

TIDAL POWER IN THE KLABAT BAY, INDONESIA

N.C. de Groot

*An application of
the SEPAM Design
Methodology*

Tidal power in the Klabat bay, Indonesia

An application of SEPAM design methodology

A master thesis commissioned by: CICAT -TU-Delft, in cooperation with Royal Haskoning, PT. Timah and Bangka regency

By: Niek de Groot
Student number: 1175947
Date: 10-8-2012
Graduation date: 24-8-2012

Graduation Committee		
Supervisors	Organization	Function
Dr.ir.P.M. Herder	Section E&I – Delft University of Technology	Committee Chair
Dr.ir. L.J. de Vries	Section E&I – Delft University of Technology	1st Supervisor
Dr. M.L.C.de Bruijne	Section POLG – Delft University of Technology	2nd Supervisor
Ir. R. Tamboer	CICAT	External Supervisor

Delft University of Technology, faculty of Technology Policy & Management
Systems Engineering, Policy Analysis and Management (SEPAM)
Section Energy & Industry

Summary

This report explores the feasibility of extracting energy from the tidal movement in the Klabat bay in Bangka, Indonesia. This is an estuary to the north of Bangka island, the larger island of the Bangka-Belitung province. The island of Bangka needs investment in electricity production capacity as the demand for electricity far exceeds the supply, and the current cost of electricity production, mostly with diesel-fired power plants, are exceptionally high. The tidal movement in the Klabat bay was identified as an option for renewable power development on the island.

The design of complex technological systems require more than a solely technological approach. One example of a complex technological system is the development of tidal power in the Klabat bay. This report attempts to study the feasibility of tidal power development in the Klabat bay, applying a specific design approach that incorporates institutional design into the design methodology. This design approach originates from the faculty of Technology, Policy and Management at the Delft University of Technology. It makes use of a generic meta-model for design, a combined technological and institutional perspective, stakeholder analysis and a model for institutional analysis. Combined, these techniques are referred to in this paper as the SEPAM design methodology.

The research objective is therefore twofold:

- A pre-feasibility assessment for tidal power development in the Klabat bay
- Study the applicability of SEPAM design models in Indonesia

In order to combine the dual research objective. A research framework was devised to structure the research. The research framework is a translation of the generic metamodel for design. The 'Diagnosis' phase is meant to explore the solution design space. This is done in chapter 1 to 5 and is an exploration of all the design objectives, design constraints and design variables. These are summarized as a 'Basis of Design' in chapter 6. Using the outcomes of the diagnosis phase two conceptual designs are made ('design phase') and subsequently evaluated on the performance indicators ('evaluation phase'). The diagnosis and design phase include institutional analysis. Afterwards the entire design exercise is evaluated.

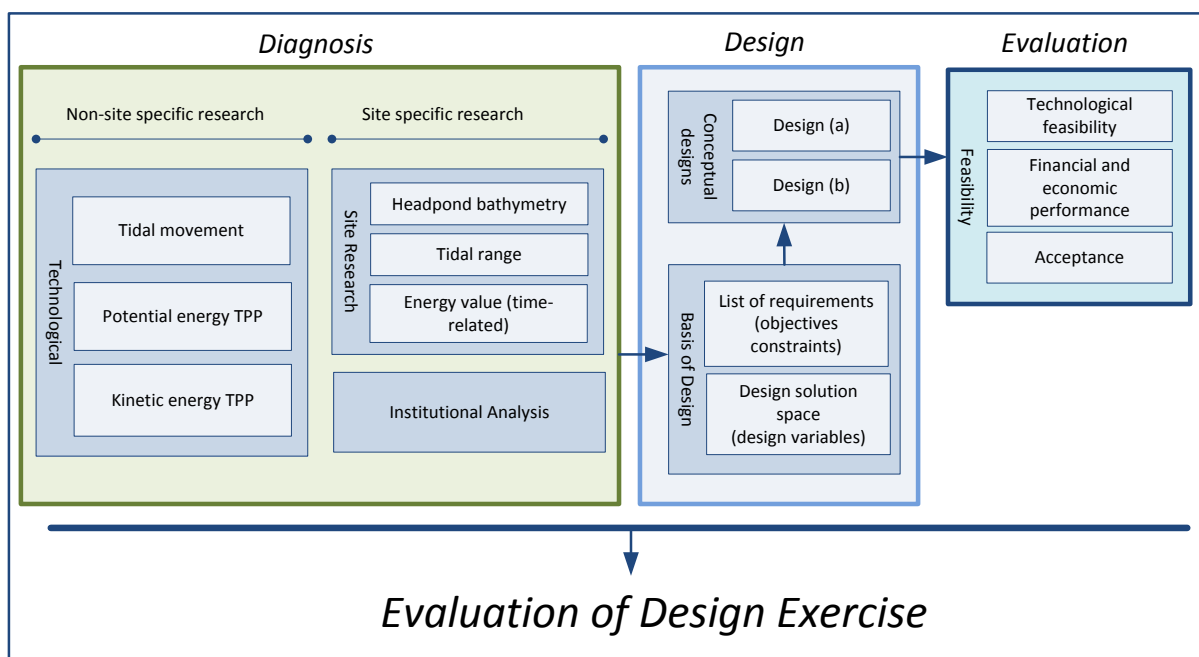

There are two distinct technologies available for tidal power development. The most important design variables and design constraints for both technologies are summarized in the table below.

	Tidal Barrage	Tidal stream
Design variables	<ul style="list-style-type: none"> • Operating schemes – Ebb generation versus Flood generation • Operating schemes – One way generation versus two way generation • Operating schemes – Single basin versus double-basin • Optimization – Number, size and type of turbines • Optimization – Necessity, number and size of sluices • Construction in the wet (caisson construction) or in the dry 	<ul style="list-style-type: none"> • Configuration – Horizontal axis, vertical axis and making use of hydrofoils. There is no option which has a clear advantage over the others. • Placement – The options range from fixed placement using a gravity structure, using a single pole like off-shore windmills to floating structures that are moored with anchors. • Developer – At this point of development the choice of the technology developer has a major impact on the technological design of the units
constraints	<ul style="list-style-type: none"> • Intermittency • Cost • Socio-economic Impacts • Environmental impacts 	<ul style="list-style-type: none"> • Immature technology • No commercial plants in operation • Energy production is very dependent on high stream speeds. The potential increases exponentially with an increase in stream speeds

The site research is summarized in the following table:

Klabat bay	Comparison with other potential sites
The average tidal range is 1.77m	Tidal ranges from 2.3m and upwards
It is a regular diurnal tide (once a day)	Always Semi-diurnal (twice a day)
Estimated stream speeds at cape Ruh 0.18m/s	1m/s and upwards
Surface area Klabat bay: 140km ²	Wide range of surface areas
Water depths at narrow entrance 20-25m	20-25m is sufficient for tidal stream development
Water depths at other places in the bay vary between 1-13m	Wide range of depths
Possible energy production with barrage 100-165GWh annually	Small compared to other projects of this size

The institutional design variables are those formal and informal instruments at the disposal of the problem owner to guide and coordinate the behavior of stakeholders. These include ownership arrangements, process arrangements with the national power company (PLN), the Power Purchasing Agreement (PPA), risk management and influencing the attitudes of stakeholders. Ownership of power production in Indonesia can be fully state owned, a public private partnership or the appointment of an independent power producer. Each type of ownership has its own merits and requires a different development process. ‘Normal’ power developments need to follow an elaborate

open tender procedure. As this is a renewable power development, it is legally possible for PLN to choose for the direct appointment of a developer. The intermittency, the expected long life time of a tidal barrage and the novelty of tidal stream technology need to be incorporated in a PPA.

Conclusions regarding the conceptual design of a tidal barrage power plant:

- A tidal barrage design would most likely be a one-way ebb generating plant with around 79 turbines with a diameter of 3 around meter. It would have a capacity of approximately 34MW and an annual production of around 99GWh.
- The most suitable ownership arrangement would be a Public Private Partnership as it would be most appropriate to manage risks. The Power Purchase Agreement (PPA) between PT. PLN and the Investment Vehicle (SPV) would have to include arrangements concerning intermittency, off-take of power, long expected lifetime and the future development of the Bangka power grid.
- The base case construction cost are estimated to be around 600million USD, with the best case being 300million USD and the worst case being 1000million USD
- Comparing even the best case construction cost scenario (300mUSD), which is a very optimistic estimate, to the cost of conventional power development, does not compare favorably for tidal barrage development.
- Comparing the best case and base case construction cost (300 and 600mUSD) to the current cost of power production on Bangka there could be a reason to continue the investigation of the feasibility

Conclusions regarding the conceptual design of tidal stream power development:

- The maximum revenue stream available for small scale renewable development, 0.11USD/kWh, is insufficient to cover the cost of tidal stream generation, even for the most positive estimate of 0.14 USD/kWh. On the basis of these numbers it is certain that there is no viable business case for tidal stream development as long as these constraints do not change
- Development of tidal stream generation would require an orchestrated process design on a national level bringing together knowledge, financing, policy, regulation and industry, which is outside the scope of the problem owner.

Recommendations for future steps tidal development in the Klabat bay:

- Tidal stream technology is not a commercially viable option. The development of tidal stream technology should be managed at the national level
- The conditions in the Klabat bay do not make it a likely location for tidal stream development. Three dimensional modeling could be used to improve the tidal stream potential assessment.
- Based on the cost estimations, tidal barrage development is unlikely to be commercially attractive, if research is continued the efforts should be aimed at (in order of importance):
 - More detailed design of a tidal barrage plant in order to better estimate the construction cost
 - Incorporate the cost of back-up power into the cost-analysis
 - Environmental impact assessment
 - Socio-economic impact assessment (fishermen, mining operations)

- Influence of sediments from the rivers on the inner Klabat bay

Conclusions regarding the design methodology:

The metamodel for design enables the designer to think in a creative, divergent manner about complex problems while offering a structured approach to do so. As it is a generic model it is applicable to almost every design problem. In relation to this case study there is definite value in the identification of design variables and design requirements and thinking about conceptual designs and their evaluation. A downside of the divergent thinking is that it invites the designer to analyze options that might not be as relevant in hindsight. Furthermore, the design approach is not similar to the industry standard which means that the designer needs to redesign the design framework instead of copying the experience of previous projects. The actual design process, making the conceptual designs, is a part of the design cycle that is not explicit in the design model. The arrows in the design framework suggest sequential steps, while in reality the establishment of objectives, constraints, a solution space and combining these three 'blocks' is an iterative process.

Conclusions regarding the combination of technological and Institutional design:

- The applicability of the TIP thinking was limited in the case study as the problem owner has limited influence on the institutional environment other than issues in layer 3 of the 4-layer model. It is therefore recommended to add the power of the designer as an extra requirement for the application of institutional design
- The value of merging technological, institutional and process design was shown in the fact that institutional issues had an important impact on the feasibility of technological design options. The institutional analysis and designs also showed the process options available for the development of power in Indonesia, these can be considered design options with different impacts on the feasibility.
- Unfamiliarity with the institutional context complicates institutional design for the designer. Difference in language and culture could result in missing important issues in institutional analysis and design.

Acknowledgements

This report is the result of my master thesis work for the master System Engineering, Policy Analysis and Management at the faculty of Technology, Policy and Management of the TU-Delft. Writing this thesis allowed me to put the knowledge the Delft University of Technology has taught me into practice. The work allowed me to use theoretical models in a real life business case. Additionally the experience of working and living in Indonesia for 5 months has taught me about cultural differences, living abroad, communicating and being flexible.

This report is commissioned by CICAT Delft. It could not have been accomplished without the (financial) support of PT. Timah, the Bangka Regency, Royal Haskoning and the TU-Delft. PT. Timah provided not only funding for this research project but also supported the field research with manpower and equipment. I wish the Bangka Regency, and especially the regent, is content with the final version of this report. Royal Haskoning provided the necessary support with the calculations and the conceptual design of a tidal barrage power plant, their support gives this report extra gravitas. CICAT played an important role in the management of interests into the report and providing me with the necessary funding for this research. Special thanks go to Andrea Peresthu who played an incredible role in the initiation of this project and provided me with an office space in Jakarta and a lot of contact persons. Thank you so much.

Additionally, I would like to thank my graduation committee for their supervision, advice and continued support during the lengthy writing process. Laurens, thank you so much for always being available and being such a kind and understanding supervisor. Our weekly meetings have been vital to the finalization of this project. Thank you Mark de Bruijne, Paulien Herder and René Tamboer for your interest in this project and your necessary advice. It has helped me to raise the quality of this research. My gratitude also goes to Zofia Lukszo who was important to me when it most mattered.

When I arrived in Jakarta I didn't know a single person. I would like to thank Windrio Sastrosatomo for giving me such a smooth landing in Jakarta and helping me with the research. Other people who have shown me the incredible hospitality of the Indonesian people include Edi Furma, David Novriandi, Indah Ibrahim and many more.

This master thesis report is the result of a long process during which I was tested in ways I had never imagined. I could not have accomplished it without the continued support of friends, family and supervisors. Papa, Mama, Rianne, René, Wim, Annelies en Ferdinand; heel erg bedankt voor jullie aanhoudende steun gedurende het schrijven van mijn afstudeerscriptie.

Niek de Groot

Augustus 2012

Content Table

1.	Introduction.....	1
1.1	Bangka-Belitung and the local electricity network	1
1.2	Tidal power development	2
1.3	Analysis and design of complex technological systems	5
1.4	Research objective	6
1.5	Research questions.....	7
1.6	Research methodology.....	8
1.6.1	Metamodel for the design process	9
1.6.2	Technological, Institutional and Process design.....	11
1.6.3	Application of the design models to the case study	12
1.6.4	Evaluation of the design methodology.....	14
2.	Tidal Energy	15
2.1	Tides	15
2.2	Tidal Barrage Technology	18
2.3	Current status of tidal barrages	20
2.4	Tidal Stream Technology	23
2.5	Conclusions about tidal energy technology	27
3.	Bathymetry.....	30
3.1	Topography and Geometry	30
3.2	Bathymetry of the Klabat bay.....	33
3.3	Conclusions about the bathymetry	35
4.	Energy Potential	36
4.1	Tidal range	36
4.2	Natural energy.....	38
4.3	Energy potential: Barrage.....	39
4.4	Stream speeds	40
4.5	Energy potential: Stream.....	42
4.6	Conclusions Energy potential	43
5.	Institutional Environment	45
5.1	Layer 3: Constraints imposed by the legal framework.....	48
5.2	Layer 2: Alignment of interests	53
5.3	Layer 2: Institutional Arrangements.....	59
5.4	Conclusions about the institutional environment.....	66

5.4.1	Design variables enabled by the institutional environment	66
5.4.2	Constraints imposed by the institutional environment	66
6.	Basis of Design.....	68
6.1	list of requirements	68
6.1.1	Design objectives.....	68
6.1.2	Performance indicators	69
6.1.3	Design constraints	70
6.2	Design solution space.....	73
6.2.1	Design alternative #1: Tidal barrage technology.....	73
6.2.2	Design alternative #2: Tidal stream technology.....	74
6.3	From a Basis of Design to Conceptual designs	75
7.	Conceptual Designs of Tidal Power Plants	76
7.1	Conceptual design tidal barrage power plant	76
7.2	Conceptual Design Tidal Stream.....	83
8.	Feasibility assessment of tidal power development in the Klabat bay	87
8.1	Feasibility assessment tidal barrage.....	88
8.2	Feasibility assessment tidal stream.....	94
9.	Conclusions and Recommendations regarding the feasibility of tidal power development in the Klabat bay.....	96
10.	Evaluation of the Design Exercise	99
10.1	Metamodel for the design process	100
10.2	Merging Technological, Institutional and Process design (TIP-model)	102
10.3	Four layer model for institutional analysis.....	103
10.4	Stakeholder analysis for institutional analysis	104
10.5	Personal reflection on execution of the project	105
11.	References.....	107
Attachment A	: Stakeholder analysis.....	110
Attachment B	: Initiating document dr. Abang Gindarsyah	123
Attachment C	: Tides.....	126
Attachment D	: Site specification.....	133
Attachment E	: Tidal Differences in the Klabat bay.....	135
Attachment G	: Interview reports.....	137
Attachment H	: Tidal stream technologies	139
Attachment I	: SCIENTIFIC PAPER.....	144

1. Introduction

This chapter introduces Bangka-Belitung, the existing conditions of the local electricity network, tidal power development and presents the research problem. Additionally the research objective and questions are formulated and the research method is introduced.

1.1 Bangka-Belitung and the local electricity network

Energy, and electricity in particular, can be harvested in many forms. This report explores the feasibility of extracting energy from the tidal movement in the Klabat bay in Bangka, Indonesia. Such a project would take place in a changing global and national environment. The ever growing global population and steady wealth creation results in an ever increasing energy demand. With the BRIC countries (Brasilia, Russia, India and China) catching up with the western world in terms of energy demand there seems to be no limit to this growth. There is a pressing need to accelerate the development of advanced energy technologies in order to address the global challenges of providing clean energy, mitigating climate change and sustainable development (International Energy Agency, 2011).

In the global turmoil of increasing energy demand, global warming, financial crises and shortage of fossil fuel supplies the Republic of Indonesia is managing its national energy policy. With a commitment to the Kyoto protocol the Indonesian government has made clear that it is serious about fighting global warming. The country signed the Kyoto protocol in 1997 and ratified it in 2004 through law No. 17/2004 (Clean Technology Fund, 2010). Indonesia has 240 million inhabitants with the population highly concentrated on Java-Madura-Bali. Indonesia's institutions are rapidly changing because of the transition from an autocratic, centrally planned economy to a democratic community with a much greater reliance on liberalized market principles. This has helped the economy to return to a stable economic growth of 5-6% annually (International Energy Agency, 2008a). However, the challenges for the Indonesian energy sector are enormous. There are the legacy fuel subsidies that put a strain on government budgets and make the country vulnerable for increasing oil prices. The Indonesian oil production and refinement capacity is in decline, partly because of the disturbing effects of the subsidies. Furthermore large parts of the population still have very limited access to basic services such as electricity, clean water, sewage, transport, trade, education and health services. The government acknowledges the need for investment in infrastructure. As part of the effort to increase access to infrastructure the national electricity company PLN is heavily investing in production capacity as well as transmission and distribution lines. Based on a presidential decree the government mandates PLN to build 10000 MW of coal fired capacity between 2010 and 2012 (Republic of Indonesia, 2009). To illustrate the scope of this challenge, an industrialized country (with a similarly sized economy) like the Netherlands has a total installed capacity of 13000MW.



Figure 1 Map of Indonesia (adapted from maps.google.com), Bangka-Belitung is marked red

Located to the east of Sumatra, Bangka-Belitung became an independent province in 2001. It is an island group of which Bangka and Belitung are the main islands. The islands are well known for its tin production and for its beautiful beaches. Access to electricity on the island is limited and black-outs are frequent. As part of the infrastructure investments PLN is currently building two 30MW coal fired power plants on Bangka and two 15MW coal fired power plants on Belitung. Even taking this investment into account Bangka faces an energy crisis. These investments are insufficient to provide all the electricity that is needed.

In 2008 a delegation from the Netherlands and local policy makers visited Bangka and the Klabat bay. The purpose of the visit was to review local policy. One of the opportunities that was identified was the tidal movement in the Klabat bay. Originally, the idea came from Dr. Abang Gindarsyah, an electrical engineer working for the local Tin giant PT Timah, when he was dragging a power line through the bay. After the visit of the Dutch delegation he wrote a document to summarize the energy situation on the island and estimate the potential of constructing a tidal power plant in the bay. This document formed the start of this research project and is included as Attachment B.

1.2 Tidal power development

When spending a day at the beach one can see the water approach and retreat over time. This is called tidal movement and is primarily caused by the gravitational pull between the earth, moon and sun and the rotation of the earth. This paragraph offers a limited explanation of the working of tides and introduces tidal power. Knowledge of the physiological properties of tides will allow for a better analysis of the methods available to extract energy in the Klabat bay. However, it should be possible to read this document without expert knowledge about tides. An explanation of how tides work is added as Attachment C

1.2.1 Ocean energy conversion

The international Energy Agency categorizes five types of ocean energy conversion schemes. Salinity Gradient makes use of the electric potential difference between salt and non-salt water. Thermal gradient exploits the temperature difference between streams. Ocean wave energy uses the movement of the waves or wave streams to extract energy. A tidal barrage creates a height potential with a dam and tidal stream uses the speed of water streams caused by tides (Powertech labs Inc, 2009). Salinity gradient and thermal gradient technologies are not applicable in the Klabat bay and

excluded from the analysis. Ocean wave would be applicable in theory but lies outside the scope of this research as its technology needs to mature and is non-specific for the Klabat bay.

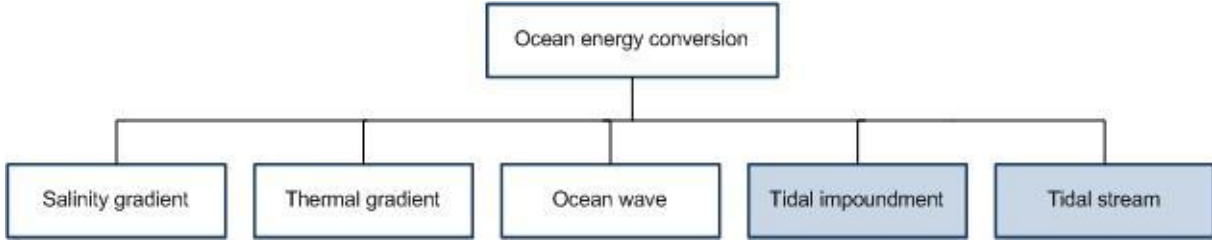

Figure 2 Ocean energy conversion

When a dam is constructed with sluices and turbines it becomes possible to create an energy potential because of the difference in height of the water level at either side of the dam. This is called tidal impoundment. If the stream of the water is fast enough it is also possible to install turbines without constructing a dam, this is called tidal stream and is conceptually similar to wind power. These two technologies differ vastly in terms of size, economics and social and environmental impacts. For both technologies there is a wide range of concepts that can be utilized to match the given site parameters as good as possible.

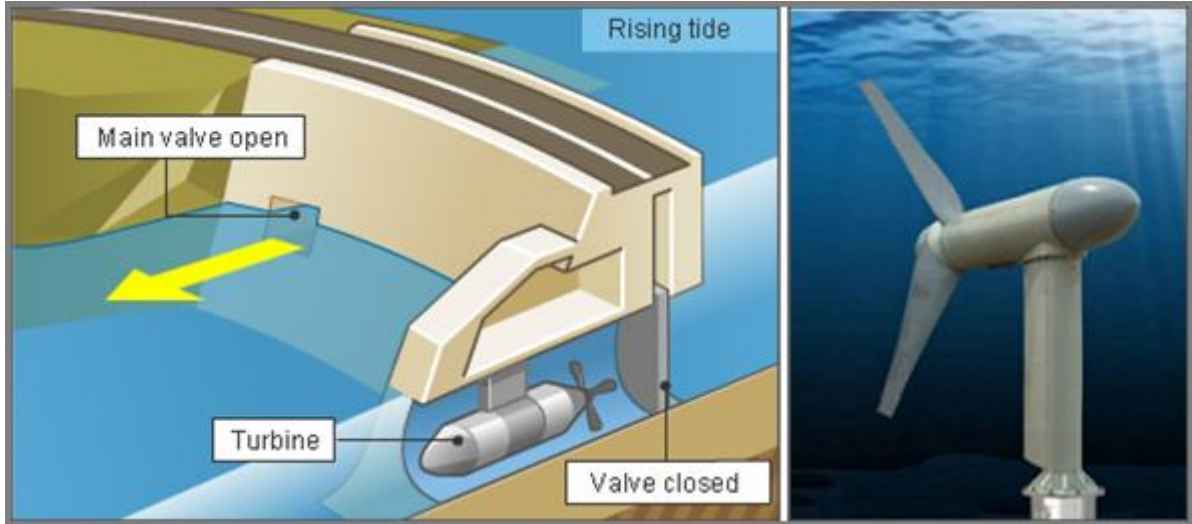

Figure 3 Tidal impoundment and tidal stream examples

1.2.2 Tidal impoundment

Using tides to produce mechanical energy has been around for many centuries. Early ‘tide mills’ were used for grinding grains. They used a basin that would be filled during rising water, the water was released during ebb and used to turn a water wheel. The concept hasn’t changed much over time, though the wheels have been traded for highly efficient hydroelectric turbines. The first large scale tidal power plant was constructed in 1964 in La Rance (France) and is still in operation today. It has a maximum capacity of 240MW. The only other operating plants are the Annapolis Tidal Generation facility in Canada (20MW), the Kislava Guba Power Facility in Russia (400KW), the Jangxia Creek in the East China Sea (500kW)(O’Rourke, Boyle, & Reynolds, 2009).

A great number of sites are considered a potential for tidal barrages. Some of the larger sites undergoing feasibility studies include the Severn Estuary in the UK, Bay of Fyndy in Canada, Mezeh Bay and Tugar Bay in Russia. Small scale sites of interest from feasibility studies include Garolim Bay

in Korea, the Gulf of Kachchh in India, Secure Bay in Australia and Sao Luis in Brazil (O'Rourke et al., 2009). And this long list of potential sites now also includes the Klabat bay in Bangka-Belitung, Indonesia.



Figure 4 Left: impression of 2 km concept of the Garolim bay in South Korea. Right: The north of Bangka, the Klabat bay

The Klabat bay consists of an inner and an outer bay. The separation between the two parts is called cape Ruh and seems an ideal location to construct a dam. The dam would be almost 2 kilometers long and impede access from the inner bay to the sea.

1.2.3 Tidal stream

Powertech prepared a report for the International Energy Agency that adequately describes the concept of tidal stream technology:

'Tidal stream technology does not require a dam to be constructed. Devices are placed directly 'in-stream' and generate energy from the flow of water. There are a number of different technologies for extracting energy from currents, including horizontal- and vertical-axis turbines, as well as others such as venturis and oscillating foils. There is also a number of methods for fixing the devices in place, such as seabed anchoring via a gravity base or driven piles, as well as floating or semi-floating platforms fixed in place via mooring lines.' (Powertech labs Inc, 2009)

The energy available at a site is proportional to the cube of the current velocity at the site and to the cross sectional area. This means that, in general, the power that can be generated by a turbine is roughly proportional to its area, and that achieving high power outputs is dependent on having high flow velocities. For this reason, tidal current systems are best suited to areas where narrow channels or other features generate high velocity (2 to 3 m/s) flows. The velocity of a tidal current, and thus its power, varies throughout the day in a pattern similar to the height of the tide (Powertech labs Inc, 2009).

The status of tidal stream technology is comparable to the status of wind power 20 years ago. The technology attracts a lot of attention from developers as well as governments that want to develop the supporting industry. There are a great many concepts developed of which a number are past the pilot stage and getting close to commercial production. The different technologies, their maturity and their developers are investigated in detail in chapter 2. Considering the narrowness of cape Ruh it can be expected that the speed of flow is accelerated in this area of the bay.

1.2.4 Tidal power development

Tides are fully predictable and therefore offer a stable, predictable potential for energy production. This differentiates tidal power from other renewable energy sources such as wind and solar. However, as most energy sources, tidal power comes with its own set of challenges.

Tidal impoundment requires large infrastructural artifacts to be constructed. This represents a high, up-front investment that needs to be off-set with future revenues. Though predictable, tidal power remains intermittent. There are designs that can mitigate the intermittency but these require the construction of more dams which usually cause prohibitively high investment cost. The local electricity network needs to be able to cover for the intermittency, this becomes an issue if the plant is large compared to the entire electricity network. Furthermore the closure of a bay usually causes significant economic, environmental and social issues. Because of the dam it becomes impossible to reach the inside of the bay over water. The tides inside the bay change because of the dam, therefore wildlife is affected, such as crabs, mussels and birds. Even with state-of-the-art turbines that are designed to have a minimum impact on fish, there will be fish that get caught by the turbines and die.

Tidal stream does not have the same environmental, social and economic impacts as tidal impoundment as the installations are smaller and don't require the closure of a bay. The global theoretical potential is enormous which explains the interest of investors and developers. Globally, tidal dissipation of energy on continental shelves has been estimated at 2.5TW. If only 10% of the potential available to the UK would be utilized it could provide roughly half of that nation's energy consumption (Bahaj, 2011). However, the hostile marine environment, high investment cost, intermittency and often distant locations of the sites pose considerable challenges.

1.3 Analysis and design of complex technological systems

The design of any system involves a number of phases; Firstly there is the interpretation of a need, followed by the development of design parameters. a divergent search transformation of concepts and finally the convergence towards a proposal (Macmillan, 2001). In engineering design the approach towards solving problems is often straightforward. A problem is identified, technological solutions are identified, assessed for their merits, and a solution is chosen (French, 1971). However, the more complex a problem becomes, and especially when human interactions are involved, the harder it becomes to maintain a strictly technological approach towards design (Koppenjan & Groenewegen, 2005). That is why methods have been developed to incorporate non-technological design issues into the design process of complex technological systems. Examples are stakeholder analysis, multi-criteria decision modeling and institutional design. This research will use a design methodology that is specifically developed to analyze such complex technological systems.

In the master curriculum of Systems Engineering, Policy Analysis and Management (SEPAM) a wide range of tools is taught that assist with the analysis of large scale technological projects. The central thesis of the program is that for the design of large technological systems it is a necessity to consider the institutional context in which the system is designed. The institutional and technological design of the system are considered interdependent. Furthermore the process in which a project develops influences the manner in which issues emerge and interact. An example is the Severn estuary in Britain, numerous feasibility studies have been performed in this region to explore tidal power production possibilities. The order, timing and contents of these studies have greatly influenced the decision making process. After forty years of research the national government decided for a

transparent national inquiry to compare and analyze all proposed concepts. To date a decision has not been made. An earlier outlook for the institutional component of designing a Tidal Power Plant (TPP) in the Severn estuary would have resulted in a very different outcome. The Severn example shows the value of an early outlook for non-technological issues such as the process and the way feasibility studies are awarded and designed.

Before making the decision to apply some form of institutional design to this system, it is necessary to establish that the system meets the characteristics of a system that needs institutional design (Koppenjan & Groenewegen, 2005):

- These systems have a technological component that can be characterized as 'unruly', which means that technology is important but does not determine the functioning of the system
- There are multiple parties involved: complex technological systems are multiactor systems. Often, these systems transcend the boundaries of one organization
- There are often both public and private parties involved, and the functioning of these systems has an impact on both private and public interests
- In their functioning, complex technological systems can be influenced by both market forces and government regulation.

For all characteristics examples can be thought of in the case of tidal power development in the Klabat bay. E.g. There are different technology options that are preferred partly based on institutional impacts, the project would involve a complex network of actors to cooperate, public and private parties are likely to be involved and the functioning of the system is heavily influenced by government regulation but also by market forces. It is therefore established that this system can be described as a complex technological system that would benefit from institutional design; the coordination of the behavior of parties necessary to make the system function.

The challenge is to apply SEPAM design models in an environment that is vastly different from western society and where people have no experience with such an approach. Application and review of the models should aid the further development of the techniques.

1.4 Research objective

In 2008 Gindarsyah made an assessment of the power production at Bangka. One of his findings was that there could be an opportunity for the development of tidal energy. This report explores the feasibility of tidal power generation at Bangka making use of design and evaluation techniques as taught at the faculty of Technology, Policy and Management at the TU-Delft. The research aim is twofold: Firstly the aim is to explore the feasibility of tidal power generation at Bangka. Secondly the aim is to assess the usability and applicability of these design techniques in an environment that is different from the one in which it was developed.

In 2009 the installed power capacity in Bangka-Belitung was 89MW. This is not enough to meet the local energy demand and many small villages are not connected to the grid. The main source for power production is diesel which is expensive and polluting. Table 1 presents an impression of the current key numbers of electricity production and consumption in Bangka compared to the Netherlands and USA. The national power company PLN is constructing the significant amount of 90MW on the islands in 2011. This means two small plants of 16.5MW at Belitung and two coal fired power plants with a capacity of 30MW at Bangka (Banka Pos, 2009; Pt. PLN, 2010). The installment of these power plants should increase the availability of power and decrease the cost of production.

The power plant project coordinator Rizal Hikmahtiar claims in the Bangka Pos (2009) that the plants will be the main backers of power production in Bangka-Belitung. Though 60MW might be sufficient to avoid an imminent energy crisis, the installed power capacity would still be very small compared to western standards.

	Bangka Island	The Netherlands	USA
Installed capacity	89 MW ^a	15325 MW ^b	1.025.400 MW ^g
Installed capacity per capita	0.089 kW ^a	0.93 kW ^b	2,9 kW
Production cost of electricity	0.33USD (2010) ^{a,d} kWh	0.05-0.07USD (2010) ^e	-
Consumer electricity cost	0.08 USD (2010) ^{a,d} kWh	0.24 USD (2010) ^c kWh	0.11USD (2009) ^c kWh
Industry electricity cost	-	0.1410	0.07USD (2009) ^{c,f} kWh

Table 1 Capacity and cost of Electricity at Bangka island compared to the Netherlands and USA. a) (Gindarsyah 2008) b) (TenneT 2011) c) (International Energy Agency 2009) d) Using XE currency converter in August 2010 e) excluding taxes. f) APX Power NI Day-ahead market results 2010 g)(U.S. Energy Information Administration 2009)

Tidal power possibly presents a reliable and sustainable way to meet the growing energy demand. This pre-feasibility study should give an indication of the technological, economical and institutional feasibility. Furthermore it should explain what information is necessary for decision making and what further analysis and decision making should look like.

As was established in paragraph 1.3 the development of tidal power in the Klabat bay can be considered a complex technological system that would benefit from institutional design. Application of the design models from the SEPAM design master is a novelty in this environment and on this subject. Previous research studies from the TU-Delft that had the objective to study the feasibility of tidal power development solely focused on technological and cost issues (Mooyaart, 2009; Swane & Stive, 2007). Therefore it will be a valuable exercise to analyze the used design methodology for its merits afterwards.

Following from this, the research objective is twofold:

- A pre-feasibility assessment for tidal power development in the Klabat bay
- Study the applicability of SEPAM design models in Indonesia

1.5 Research questions

The previous paragraphs introduced the problem setting. This section discusses the research question and sub questions. When the research question is answered the research objectives should be achieved. Every sub question should help answering the main question.

In order to fulfill the objectives the following research questions need to be answered:

Central question:

What can be learned about SEPAM design methodologies from their application to a pre-feasibility study for tidal power development in Indonesia?

To be able to answer the central question, it is necessary to articulate sub questions. The use of the SEPAM design methodologies is inherent in the way the first four sub questions are formulated.

Subquestions:

-
1. What are the goals, objectives and constraints of constructing a tidal power plant in the Klabat bay?
 2. What are the physical (technological) and institutional design variables available to create conceptual designs of a tidal power plant at Bangka?
 3. Using the identified design variables, what would the most promising designs look like?
 4. What is the feasibility of tidal power development in the Klabat bay (or; Do these designs meet the design objectives and fall within the constraints)?
 5. What are the conclusions regarding the applicability and value of the design methodology in the Indonesian context?
-

Answering these questions will ensure satisfying the dual research objective. The first sub question focuses on setting up the goals of tidal power development. It helps with answering 'why' to develop tidal power in the Klabat bay. Answering the second question helps to span up the solution space, i.e. explore the possibilities. The third question identifies the most promising designs from the solution space. The fourth question is the evaluation of the feasibility and the fifth and final question reflects on the applicability and usability of the used SEPAM design models. It is important to note that this is a pre-feasibility study, therefore the designs will offer limited detail.

1.6 Research methodology

The dual research objective and subsequent research questions lead to a specific research methodology. The SEPAM design methodologies serve as tools in the process of analyzing the feasibility of tidal power development in the Klabat bay. The feasibility study can be seen as a case study on which the SEPAM design methodology is tested. The research framework in Figure 5 is an application of the Metamodel for the design process by Herder and Stikkelman (2004) to the case of researching the feasibility of tidal power development in the Klabat bay. As can be seen, the design process is concluded with the evaluation of the design exercise, which should answer sub question 5.

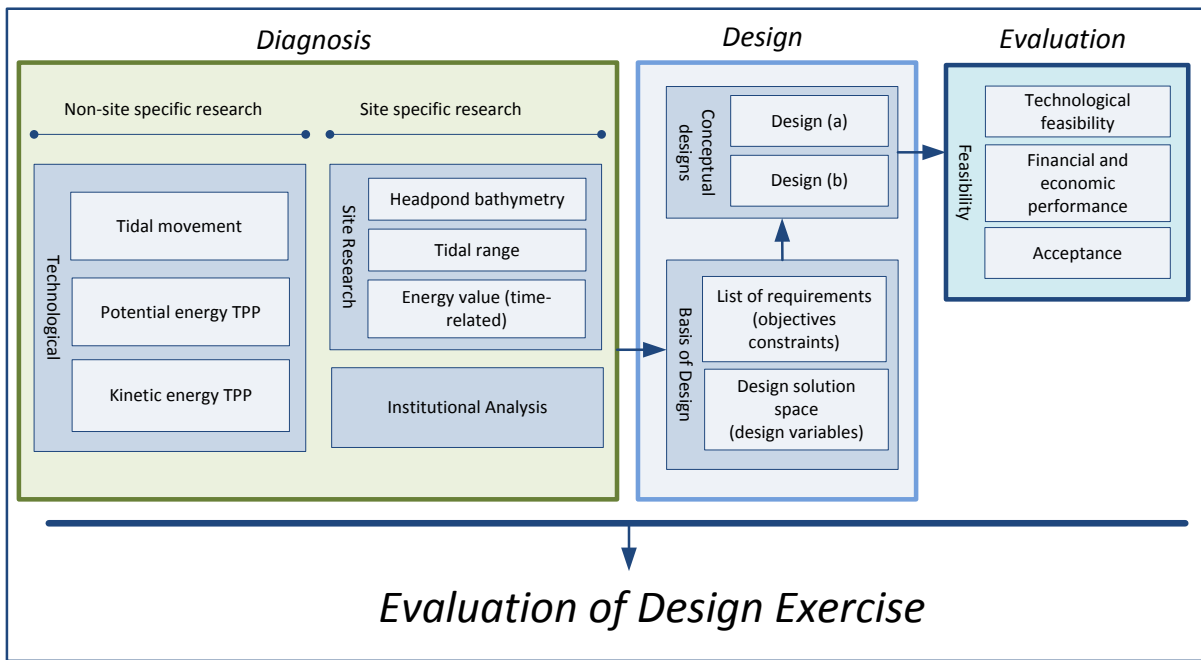

Figure 5 Research framework

As this is a pre-feasibility study, limited time, information and resources are available for this research, therefore choices have to be made about the focus of the research. Expectations about a complete detailed design of a tidal barrage power plant are unrealistic. Choices will have to be made to research the most important parameters that decide the feasibility of the development.

1.6.1 Metamodel for the design process

The research framework is an adaptation of the metamodel for the design process by Herder and Stikkelman (2004). Figure 6 shows the metamodel for design with in the background colored blocks that correspond with the blocks of the research framework.

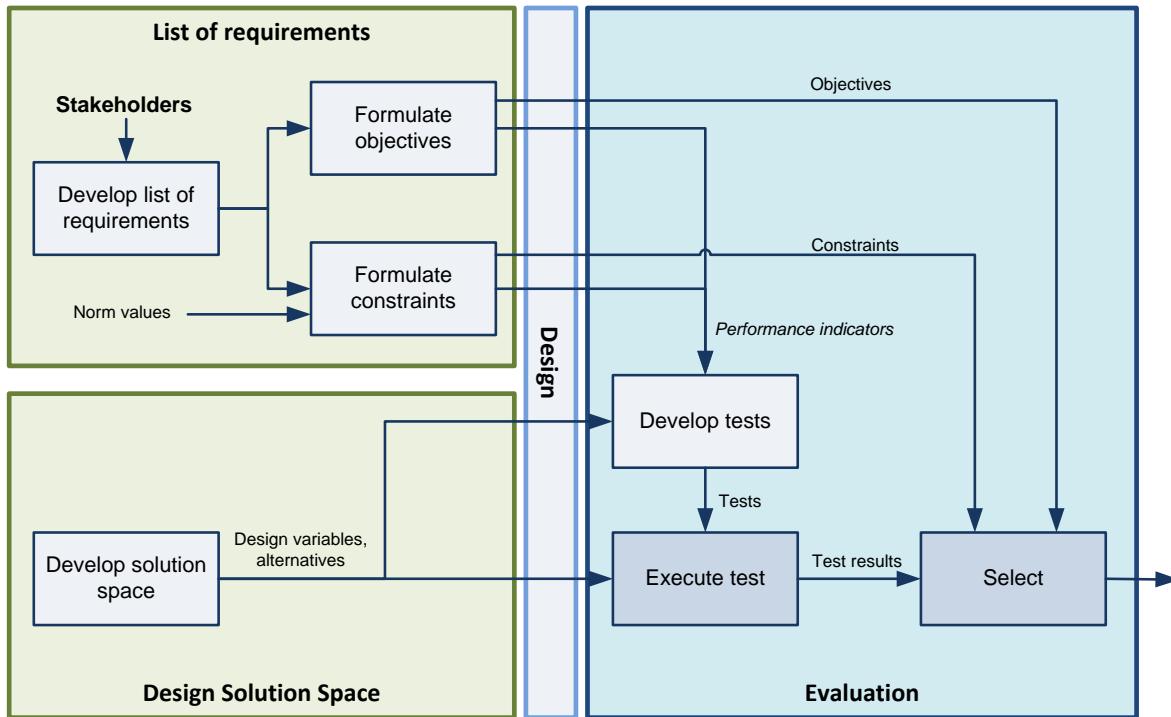

Figure 6 Metamodel for the design process (Herder & Stikkelman, 2004)

It is a generic conceptual design framework based on the work of Westerberg et al. selected on the basis of broad applicability and relative simplicity (Westerberg, Subrahmainan, Reich, & Konda, 1997). The broad applicability is useful in particular for multidisciplinary projects that require institutional design. The framework consists of five main concepts that roughly outline the contents of any stage in a design process (Herder & Stikkelman, 2004):

-
- | | |
|-------------------------------|---|
| 1. Design Goals | What the designer wishes to achieve |
| 2. Design Objectives | Selection of goals to be optimized, i.e. minimized or maximized |
| 3. Design Constraints | Selection of goals to be met but not to be optimized; constraints can also be imposed by the environment (in the broadest sense of the word), demarcating the design from its surroundings |
| 4. Tests for the goals | Tests for the goals, describing in detail how proposed designs are going to be assessed for their ability to meet each design goal, based upon a behavioral model of the design and its environment, and <i>before</i> the design has been actually built |
| 5. Design Space | Superset of design components and design variables |
-

This design methodology could be summarized as ‘selecting an instance in the design space that meets the objectives and constraints’. Structuring the design exercise like this makes design options and choices explicit. This will provide decision makers and interest groups with a resource to

objectively judge how choices were made during the design process. Even without the completion of a design there will be value in the listing of available design variables and design constraints. In order to safeguard readability for readers that are only interested in the feasibility study the report follows the structure of the research framework.

1.6.2 Technological, Institutional and Process design

An important premise of the SEPAM design methodology is the interdependency between technological design and institutional design. This interdependency is captured in the technological, institutional and process design model (TIP-model) by Koppenjan and Groenewegen (2005), depicted in Figure 7.

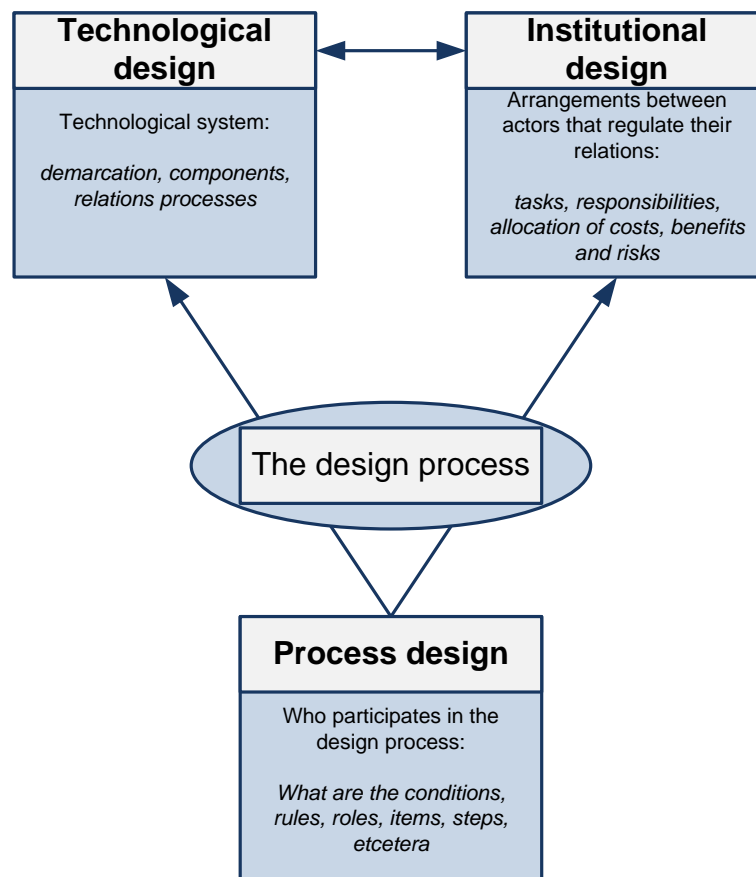

Figure 7: The relation between technological, institutional and process design (TIP-model) (Koppenjan & Groenewegen, 2005)

In their article about institutional design for complex technological systems Koppenjan and Groenewegen bring together a number of important design models, among which the TIP-model and the metamodel for design. From the abstract:

'Complex technological systems like telecom, energy and transport infrastructures are subject to institutional (re)design. Institutions concern different levels of analysis like laws and regulations as well as contracts and organizations which regulate and coordinate the behavior of actors in complex networks. In relation to technological and process design, we discuss how efficient and effective institutions can be designed according to structure behavior in such a way that socially desired objectives are realized. After analyzing the stabilizing and instrumental role of institutions, we introduce a four-layer model, which offers the building blocks for identifying the steps to be considered in processes of institutional design. After having discussed the constraints

in designing institutions, we present a generic model meant to be helpful in structuring the process of designing institutions in complex technological systems. (Koppenjan & Groenewegen, 2005)'

The four layer model is used as a framework for the institutional analysis but is not explained in this methodology description. The application of this model to this case study is limited to only one of the four layers, therefore the model is treated as an application of a model to a particular part of the analysis. In a similar way a stakeholder analysis is performed in the institutional analysis to research the goals and objectives of the involved actors. Both models are explained and applied in chapter 5.

The process design is the beginning of the design process whereas the technological and the institutional designs are its outcomes. For this pre-feasibility study choices were made about the design of the project, made explicit in a Memorandum of Understanding. The initiator, Andrea Peresthu, had a clear idea about how the project should be shaped. His relationships with the TU-Delft and governance in Bangka-Belitung shaped the initiation of this project. Experts from the TU-Delft and Royal Haskoning should be involved to safeguard the quality of the research itself. Clearly this process has already had an effect on the quality, timeline, complexity and outcomes of the pre-feasibility research. The process design itself, for the decision making about a tidal power plant, is limited to an inventory of the possible processes that can be followed within the existing legal framework.

The SEPAM master assumes an interdependency between the technological design and the institutional design. In this research the interdependencies will be made explicit and the value of stating this relationship will be evaluated. For example; Building a dam has a large influence on the life of people around the bay. It could double as a bridge, it closes off the bay for ships and it could have an impact on fish populations. The institutional impacts influence the desirability, and the technological design, of this project. The value of identifying these relationships can be sought in avoiding future social unrest, making people feel involved, i.e. mitigate risks. On the other hand introducing these issues in an early stage can make feasibility assessments needlessly complex and expensive.

1.6.3 Application of the design models to the case study

In order to satisfy the first part of the research objective, assess the feasibility of tidal power development in the Klabat bay, some adaptations have been made to the application of these design models. The application is summarized in the research framework.

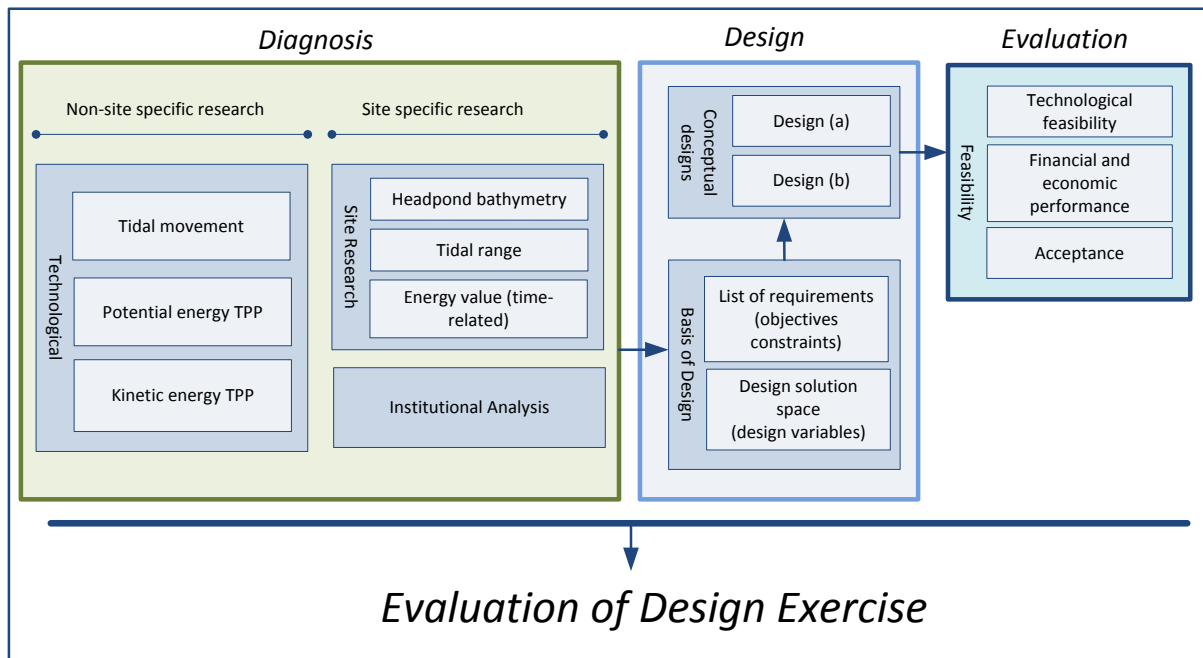

The first part of the research is called 'diagnosis' and focuses on the identification of requirements and the definition of the design solution space. This is done by first researching the technological design options of tidal power development, this is non-site-specific research and is generic for all tidal power development. Then the most important site parameters are assessed for the design of a tidal power plant; the bathymetry, the tidal range and the resulting energetic potential. Subsequently the institutional environment is assessed for the identification of the design goals, requirements and the institutional solution space. Every important aspect of tidal power plant design is treated, while being keen on the identification of the components from the metamodel for design. Every chapter ends with a summary of the identified requirements and design variables.

The summary of the 'Diagnosis' stage results in a Basis of Design (BoD) which is a list of all the requirements and a description of the solution space. This forms the basis of the conceptual designs. These designs are rudimentary designs for tidal power plant development in the Klabat bay. As will follow from this analysis the feasibility of the tidal barrage option is very dependent on the technological design and accompanying cost. Therefore the design of this system has a stronger focus on the technological and cost component of the design. Tidal stream options are less influenced by the cost, as they are always high. The analysis will conclude that there are currently no commercially attractive options for tidal stream technology and it will take time before these options exist. Therefore the design of this system will focus on the process design of such a tidal stream technology. Even if certain parameters are unknown or insufficient for the development of tidal stream, the design exercise will provide insight in how such a system could be created, in the Klabat bay, or in other places in Indonesia

The evaluation of the designs is based on the previously identified performance indicators and design criteria which are the technological feasibility, financial and economic performance and acceptance. As this is a pre-feasibility study, the analysis of the financial and economic performance lack detail.

1.6.4 Evaluation of the design methodology

In order to evaluate the application of the design philosophy, firstly the benefits of a design methodology are discussed here. Designs benefits from a design methodology for the following reasons (French, 1971):

1. Increasing insight into the problems, and the speed of acquiring insight,
2. By diversifying the approach to problems,
3. By reducing the size of mental steps required in the design process,
4. By prompting inventive steps, and reducing the changes of overlooking them
5. By generating design philosophies

After the design exercise is finished, it will be possible to evaluate the value of the design methodology based on these benefits. It is inherent in the design of the research framework that both technological and institutional components are not separate and together determine the outcome of the design process. This will allow for an evaluation of this interdependence during the evaluation of the design exercise. The final chapter will review the use of the SEPAM models for the case study. Their applicability, usefulness and effectiveness are investigated based on the experiences of this project.

2. Tidal Energy

The tides in the Klabat bay may offer an opportunity to produce electricity for the people of Bangka-Belitung. In order to assess the feasibility of tidal power development in the Klabat bay it is first necessary to learn about the technologies that exist for tidal power production. This chapter will start with an explanation of how tides work, as a basic understanding of the physiological properties and nomenclature of tides is necessary to discuss tidal power. Then the technological design options are explored. As mentioned in the introduction there are two distinctive approaches towards harvesting energy from the tides;

- Tidal Barrage
- Tidal Stream

Each has its own unique set of possible configurations and a unique set of challenges. This chapter aims to describe technological design options and investigate the development of both technologies.

2.1 Tides

This paragraph explains the basic physics of tides and introduces the nomenclature that is used when discussing tides and tidal power. Most places on earth experience two tidal cycles a day. If the earth is viewed as a simple sphere with water on the surface the two most important forces that cause tides are the gravitational force of the moon and the centrifugal force caused by the rotation of the earth. Both forces result in a 'bulge of water' on each side of the globe. Since the earth revolves around its axis in 24 hours, two 'bulges of water' pass by every day.

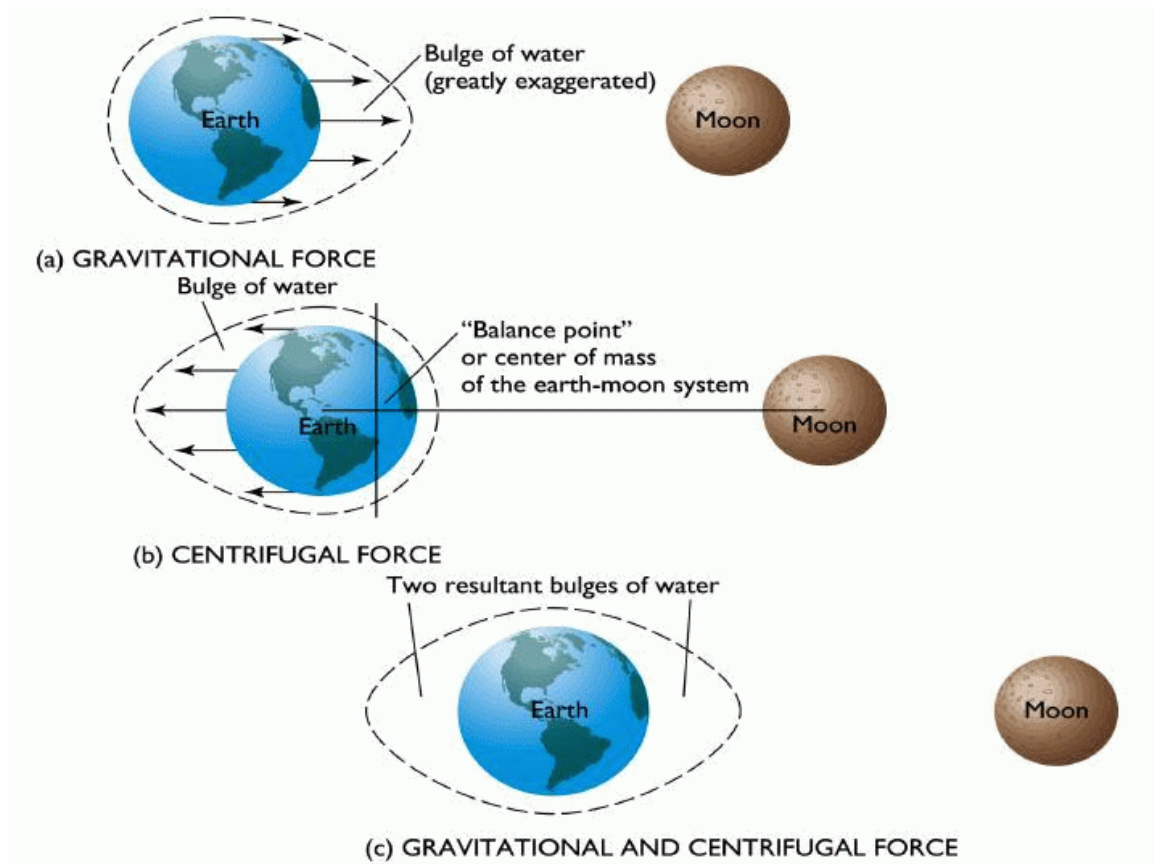

Figure 8 The influence of the moon on the tides. <http://www.lhup.edu/~dsimanek/scenario/img008.gif>

Besides the gravitational power of the moon and the centrifugal power of the earth, another important component is the gravitational pull of the sun. Because the moon is much closer to the earth the gravitational pull of the moon is about 2.2 times larger than the gravitational pull of the sun. When the earth, sun and moon align, the gravitational forces act complementary. This causes exceptionally high tides which are called *spring tides*. When the moon is at a 90 degrees angle with the earth-sun system this causes exceptionally low tides which are called *neap tides*. The tidal phenomena occur twice every 24 hours, 50 minutes and 28 seconds. In total there are 10 components that exert influence on the tides. To have a complete understanding of tides in an area one even needs to consider the angle of the moon orbit which takes 18.61 years to complete. A further explanation of the periods of tides is given in attachment C.

The following paragraph and Figure 9 introduce some crucial definitions of tides and tidal power. During one tidal cycle the water level will gradually rise until it reaches its highest point, *high water*, and then fall again until it reaches its lowest point, *low water*. Following this, the water level will rise again. The difference between these two points is called the *range* of the tide. In a bay, water will flow in (*flood*) and out (*ebb*) of the bay and cause a stream. Thus there are two distinct movements that are included in the word tide. A vertical rise and fall in the level of the water, *the tide*, and a horizontal flow in two directions, *the tidal stream* (adapted from Clark, 2007). Figure 9 shows a typical graph of a tidal cycle with definitions.

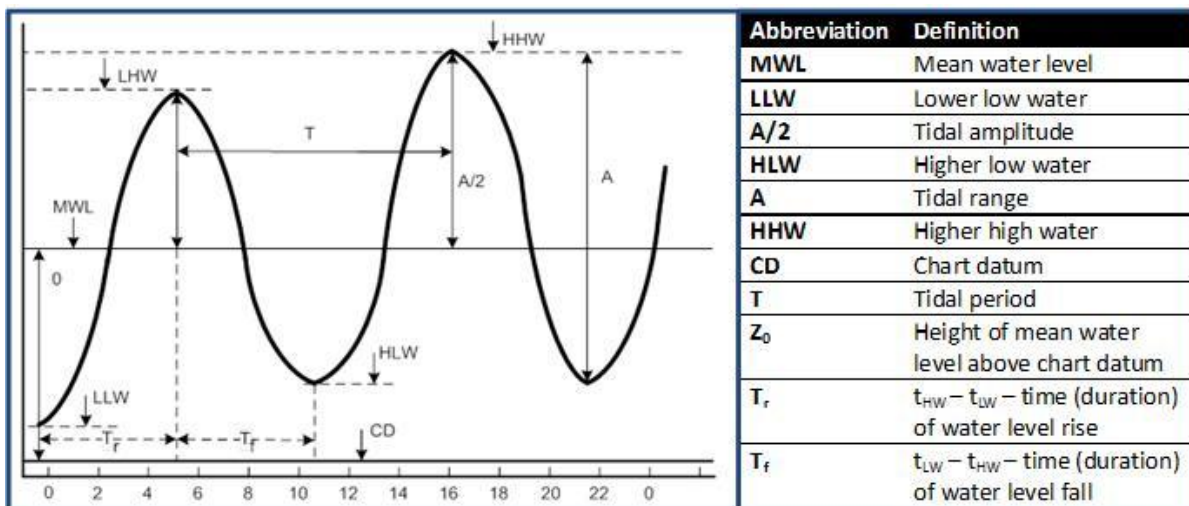

Figure 9 Definitions of a tidal cycle. The curve is a graphic representation of the water level during a day.

To explain the basic physics, simplifying the situation is useful, as it is done above. In reality the oceans of the earth form a complex system of tides that are not always easy to predict. In addition to that there are circumstances that can cause a tidal cycle to occur only once a day. The axis around which the earth revolves is not perpendicular to the orbit of the moon around the earth. This causes a daily, or *diurnal*, and a twice-a-day, *semi-diurnal*, component. Figure 10 shows how the semi-diurnal component becomes very small in those places that are furthest away from the plane that is in line with the moon (line EF in (a)). In these places it is possible that the semi-diurnal component is completely cancelled out which results in a tidal cycle of only one flood and one ebb each day (line EF in (b)).

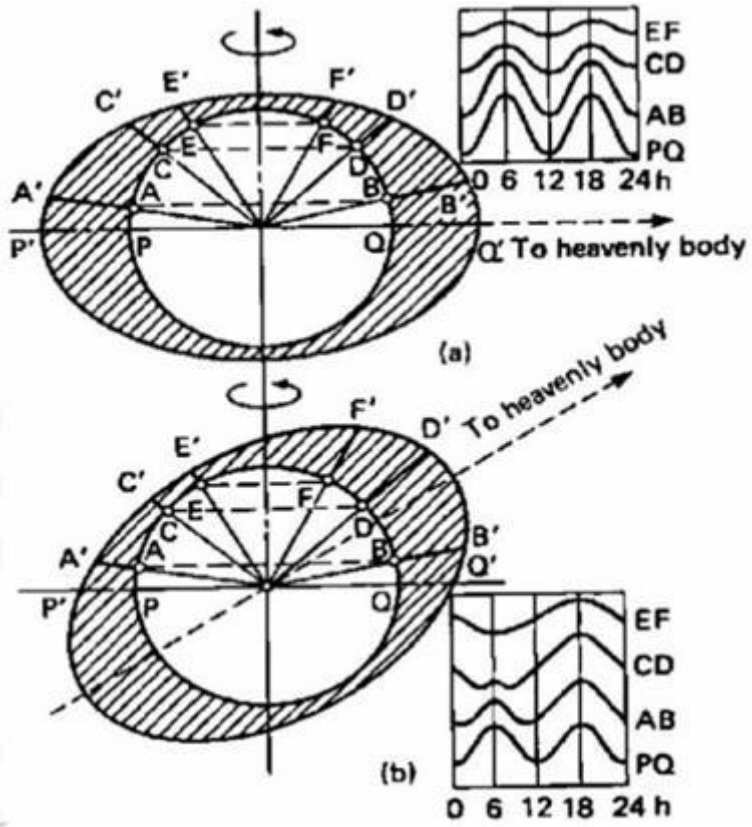

Figure 10 Tidal ellipsoid and diagram of diurnal inequality (Bernshtein, 1996)

2.2 Tidal Barrage Technology

Using tides to produce mechanical energy has been a proven technology for many centuries. Early 'tide mills' were used for grinding grains. They used a basin that would be filled during rising water, the water was released during ebb and used to turn a water wheel. The concept hasn't changed much over time, though the wheels have been traded for highly efficient hydroelectric turbines. Figure 11 shows pictures of the La Rance tidal power station in France and the Annapolis Tidal Power Facility in Canada.



Figure 11 Photographs of the La Rance Tidal Power Station in France (left) and the Annapolis Tidal Power Facility in Canada (right). Both pictures from (O'Rourke et al., 2009)

2.2.1 Single-Basin tidal barrages

There are three methods of operation with which electricity can be generated with a single basin; Ebb generation, flood generation and two-way generation (O'Rourke et al., 2009). The main differentiators are the energy-in-time output, useful head, efficiency and requirements for turbines.

2.2.1.1 *Ebb generation and flood generation*

In the case of ebb generation, the sluices are opened during flood to fill the basin. At high tide the sluices are closed. During periods of low energy demand it is possible to pump extra water into the basin. The turbine gates will open when the ebb has caused a sufficient head for the turbines to operate. The turbines will generate electricity for a number of hours. The gates will close again after the head has become so small the turbines cannot operate efficiently anymore. After which the flood sets in and the process repeats itself. This is the methodology used for the Mersey Barrage in Great Britain. The useful head is 66% of the tidal range. In the case of a semi-diurnal tide this system produces about 5 hours of power followed by 6-7 hours of filling and standstill. In the case of Klabat where there is only one tide per day, power production would be about 11 hours followed by 13 hours filling and stand still. This intermittency can be a serious issue if the power production is large. Instead of ebb generation it is also possible to generate power during flood. In this case the sluices are closed during flood so the water level outside the barrier is higher. Usually the water surface decreases during ebb, which decreases the volume of water and thus energy production. Therefore generation during ebb usually has a higher yield.

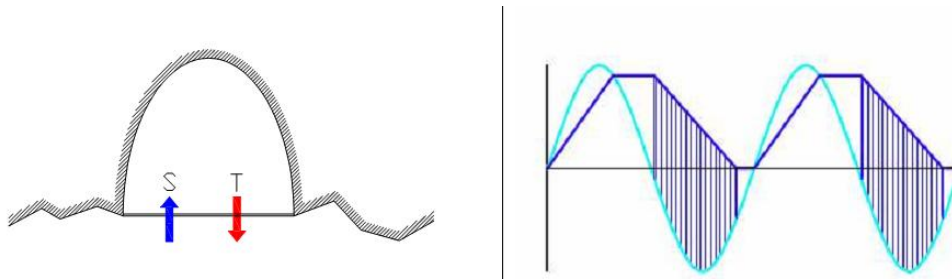

Figure 12 Single-basin system for ebb generation and flood generation (Mooyaart, 2009). The picture on the left shows the bay with the barrage, the S represents the flow through the sluices, the T represents the flow through the turbines. In this example the turbines operate when the water level decreases, so it is an ebb operating plant. In the picture on the right the water levels on each side of the barrage are shown. The difference between both lines equals the head. The blue surface represents the period during which power is generated.

2.2.1.2 Two-way generation

To battle the short operation period of the one directional power plant a two-way system was developed. With this method energy is produced both during the flood and the ebb phases of the tide. During flood the water level outside the barrier is higher. Until the minimum hydrostatic head for electricity generation is reached, the turbine gates are kept open. Then the sluices and turbine gates are closed until the upcoming ebb phase causes sufficient head to operate in the opposite direction. The energy production of a two-way operated plant is greater than for a one directional plant, but the average head over the turbines is smaller and therefore the turbines become larger and more expensive. Two-way generation has the advantage of reduced period of non-generation and a reduction in the cost of generators due to lower peak power (O'Rourke et al., 2009). When the objective is to generate an equal amount of power in both directions the water level within the basin has to be kept at the average level. If so, there is no need for sluices which reduces construction cost (Mooyaart, 2009). A version of this type of operation scheme is used in La Rance, France, where the largest operating power plant in the world is located. In La Rance more power is produced during ebb generation, it also includes a possibility for pumping water into the basin to increase the yield during peak demand.

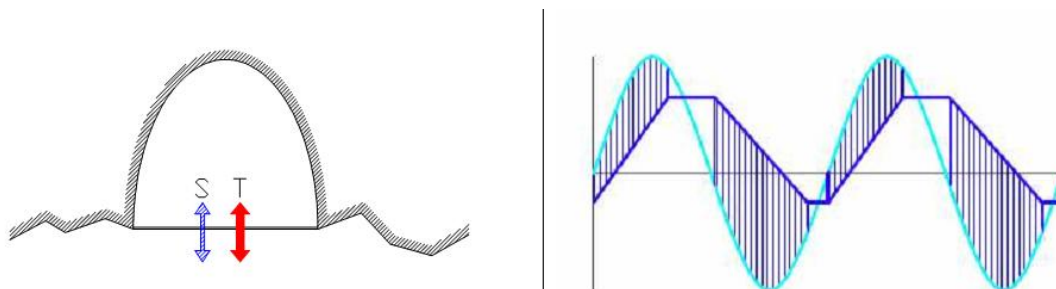

Figure 13 Single-basin system for two-way generation (Mooyaart, 2009). In the picture on the right the water levels on each side of the barrage. The difference between both lines equals the head. The blue surface represents the period during which power is generated.

2.2.2 Double-Basin tidal barrages

Another way to reduce the problem of intermittency is to create a double basin barrage. With two basins the operational scheme can be tweaked in such a way that the intermittency is minimized. There are two possible schemes, one in which both basins are connected and one in which they are not. In case there are two natural bays close to each other they could also work as a double basin barrage system. Despite the ability to deliver electricity at periods of high demand, double-basin

systems are unlikely to be feasible due to higher construction costs and the inefficiency of low-head turbines (O'Rourke et al., 2009).

2.2.2.1 Non-communicating basins

By constructing two basins it becomes possible for one basin to operate during ebb and the other during flood. Each basin works exactly like a single basin single-flow tidal barrage plant would. Of course one basin needs to operate during flood while the other operates during ebb. The electricity production becomes almost fully continuous over time.

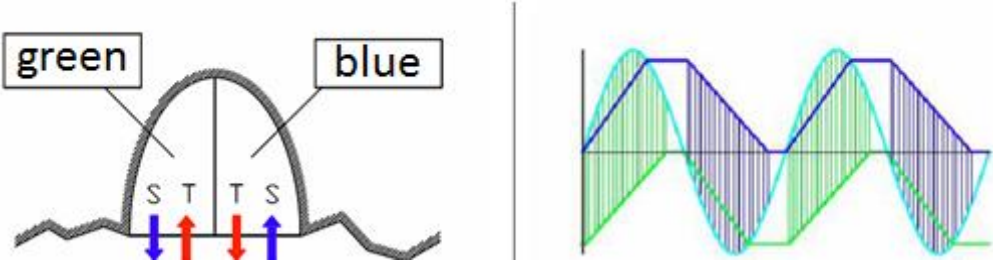

Figure 14 Double-basin system, non-communicating basins (Mooyaart, 2009). The dark blue line represents the ebb-generating basin (left compartment) and the green line represents the flood generating basing (right compartment)

2.2.2.2 Communicating basins

Having two non-communicating basins gives you the advantage of a more continuous electricity production. With the addition of turbines to the separating barrage it becomes possible to have even more control on the water levels. In the example below the level in one basin is kept continuously on a high level in one basin and on a low level in the other basin. The advantage of this configuration is the high head and continuous production of energy. However the usable volume of water during operation is smaller which decreases the yield. It is also possible to imagine a configuration that is similar to a double basin non-communicating basins but with the addition of pumps and/or sluices to the separating dyke. This would also allow for more control over production. Every addition to a tidal barrage power plant increases the already high construction cost. Therefore every addition that decreases the overall power output is unlikely to increase the feasibility.

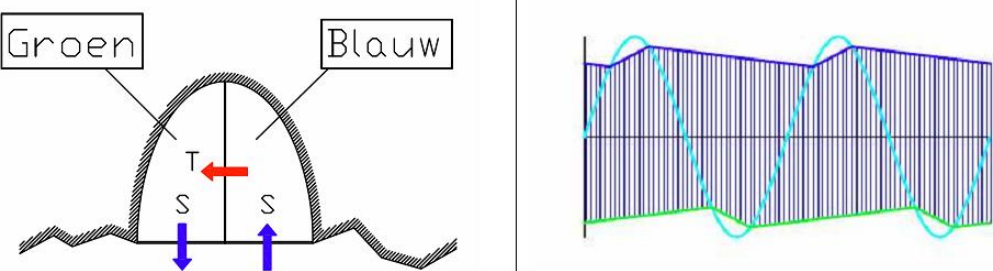

Figure 15 Double-basin system, communicating basins (Mooyaart, 2009). The water level is kept continuously high in the right compartment (dark blue line) and continuously low in the left compartment (green line).

2.3 Current status of tidal barrages

Generating power from the tides with a barrage is a mature and reliable technology. This paragraph describes existing tidal power plant projects. Despite the maturity and reliability of the technology there are only 4 existing tidal barrage power plants.

	year	capacity
La Rance (France)	1964	240MW

Annapolis (Canada)	1984	20MW
Kislaya Guba (Russia)	19	400kW
Jangxia (China)	19	500kW

Table 2 Existing tidal barrages (O'Rourke et al., 2009)

A great number of sites are considered a potential for tidal barrages. Some of the larger sites undergoing feasibility studies include the Severn Estuary in the UK, Bay of Fundy in Canada, Mezeh Bay and Tugar Bay in Russia. Small scale sites of interest from feasibility studies include Garolim Bay in Korea, the Gulf of Kachchh in India, Secure Bay in Australia and Sao Luis in Brazil (O'Rourke et al., 2009). Table 3 shows a list of identified tidal barrage sites in the world and their characteristics.

Location	Mean Range (m)	Basin Area (km ²)	Potential Power (MW)	Mean Potential Production (GWh/year)
North America				
Passamaquoddy	5.5	262	1800	15800
Cobscook	5.5	106	722	6330
Bay of Fundy	6.4	83	765	6710
Minas-Cobequid	10.7	777	19900	175000
Amherst Point	10.7	10	256	2250
Shepody	9.8	117	520	22100
Cumberland	10.1	73	1680	14700
Petitcodiac	10.7	31	794	6960
Memramcook	10.7	23	590	5170
South America				
San Jose, Argentina	5.9	750	5870	51500
United Kingdom				
Severn	9.8	70	1680	15000
Mersey	6.5	7	130	1300
Solway Firth	5.5	60	1200	10000
Thames	4.2	40	230	1400
France				
Aber-Benoit	5.2	2.9	18	158
Aber-Wrac'h	5	1.1	6	53
Arguenon	8.4	28	446	3910
Frenaye	7.4	12	148	1300
La Rance	8.4	22	349	3060
Rotheneuf	8	1.1	16	140
Mont St Michel	8.4	610	9700	85100
Somme	6.5	49	466	4090
Ireland				
Strangford Lough	3.6	125	350	3070
Russia				
Kislaya	2.4	2	2	22
Lumbouskii Bay	4.2	70	277	2430
White Sea	5.65	2000	14400	126000
Mezen Estuary	6.6	140	370	12000

Australia				
Kimberley	6.4	600	630	5600
China				
Baishakou	2.4	No Data	No Data	No Data
Jiangxia	7.1	2	No Data	No Data
Xinfuyang	4.5	No Data	No Data	No Data

Table 3 Major world barrage sites (Twidell & Weir, 2006)

2.4 Tidal Stream Technology

As explained in the introduction there are two distinct ways to harvest energy from tidal movement. The previous paragraph explained tidal barrage technologies, this paragraph will describe tidal stream technologies. Firstly the fundamental principles of operation are discussed, then the current status of the technology, followed by current issues the industry is struggling with. Finally the expected future developments of tidal stream technology are discussed.

Tidal movement consists of a vertical movement, the water moving up and down, and a horizontal movement, the acceleration of water caused by the shallow coastlines and narrow straits. Tidal stream technologies use the horizontal movement. Most promising sites are found in places with a considerable tide that is absorbed by a narrow strait, island group or a bay. Tidal stream generators do not capture all the energy that is available, therefore only a fraction of the natural energy can be captured. The devices can be installed individually or in large numbers.

2.4.1 Principles of operation

A number of technological concepts exist to convert the kinetic energy of the streams into mechanical and subsequently electric energy. The main differentiators for the different technologies are summarized in Figure 16. Each design has advantages over others. The configuration represents the type of mechanical machinery which is used to capture the movement of the water. In principal the following steps are followed in the generation of electricity from tidal streams; A turbine consists of a number of blades mounted on a hub (together known as the rotor), a gearbox and a generator. The water flowing past the blades causes the rotor to rotate, thus turning the generator to which the rotor is connected via a gearbox (O'Rourke et al., 2009).

The three main configurations are axial-flow, cross-flow and reciprocating hydrofoils. They will be explained in the next paragraph. Other important differentiators are the placement and whether ducting is present. In terms of placement one can choose to attach the installation to the bedding of the ocean or to design a floating structure. Ducting is a cylindrical shaped object in which a turbine is placed. The cylinder accelerates the stream and offers protection for the turbine.

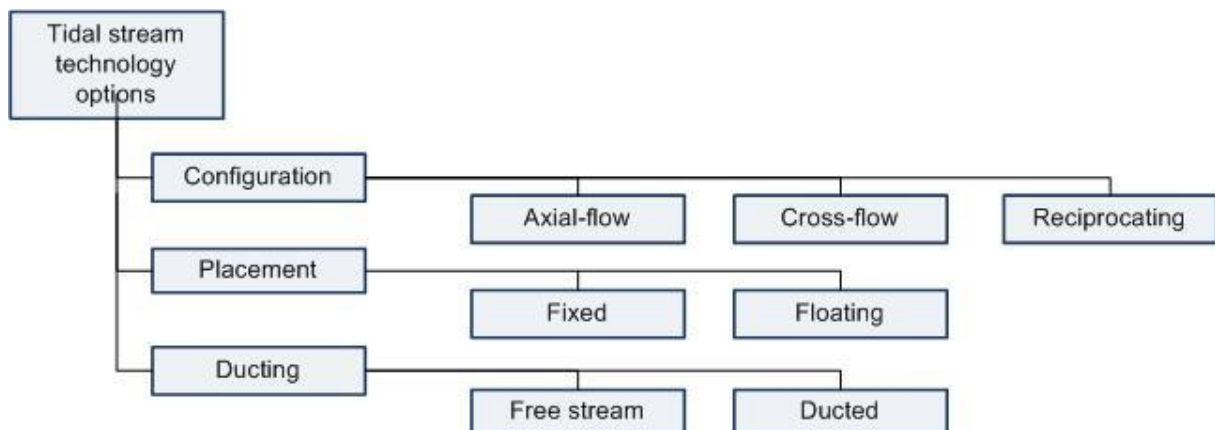

Figure 16 Tidal stream technology options. Based on (Entec, 2007), page 4

2.4.1.1 Configuration

Tidal stream technology is conceptually similar to wind energy. The objective is to convert a horizontally streaming mass into mechanical energy. However, the density of water is 832 times greater than air and the stream speeds are slower than wind speeds. This means greater forces and greater moments are acting upon the installation. A tidal stream technology needs to operate both

with ebb and flood. It needs to be capable of withstanding the forces of the marine environment, also when it is not operating. In order to achieve this three categories of configurations are used; Vertical axis flow, horizontal axis flow and reciprocating hydrofoils. The categories are depicted in Figure 17. The energy harvested is proportional to the cross-sectional area of a device. The larger the area, the greater the energy captured (Entec, 2007).

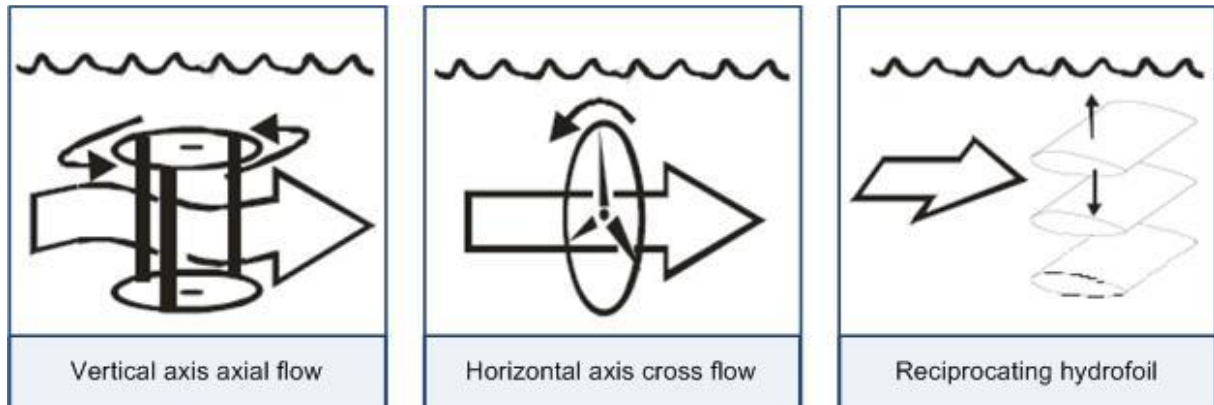

Figure 17 Schematic of different rotor types (based on (Entec, 2007))

The turbines of the vertical axis flow installation rotate around a vertical axis which is perpendicular to the direction of the flow of the water. The advantage of this technology is that it works, independently of the direction of the stream. An example is the Gorlov Helical turbine as developed by GCK Technology Inc. based in the USA (O'Rourke et al., 2009). This kind of configuration was popular in the early development of wind energy as well. In the case of wind the horizontal axis cross flow configuration turned out to be more effective.

The horizontal axis cross flow configuration is very similar to the wind turbines that are now common. The turbines rotate around a horizontal axis which is parallel to the direction of the flow of water. Because of the different energy densities of water and air the proportions are a bit different. Mostly, the materials need to be stronger to withstand the greater forces and the rotation of the turbines is slower. There are two ways to enable reversible operation, the turbines can be designed to work in both directions (accepting a loss in efficiency) or the turbines are placed on a structure that makes it movable into the direction of the stream. Examples of axial-flow turbines include those being developed by MCT, SMD Hydrovision Ltd, Luner energy Ltd. And OpenHydro Group Ltd (Entec, 2007)(O'Rourke et al., 2009).

Reciprocating hydrofoils are set in motion in a similar way to how wings of an airplane operate. So reciprocating hydrofoils do not rotate but move up and down repeatedly. The vertical movement of the hydrofoils is then converted into electrical energy. One of the advantages of hydrofoils is that they are able to 'sweep' a larger area in more shallow waters. The swept area is a square and enables several installations to be placed next to each other, which covers a greater area than circular turbines placed next to each other (Pulse Tidal, 2012). Although less common as a configuration, a number of developers try to use this technology. Pulse Generation Ltd is developing a device that uses reciprocating hydrofoils and Engineering Business Ltd has investigated this type of system in the past (Entec, 2007).

2.4.1.2 Placement

The placement involves fixing the tidal stream installation into its place. Important considerations for the type of placement are cost-effectiveness, local water depth, accessibility, safety and simplicity. Placement of an installation is challenging in a marine environment with strong currents. Therefore the possibility of a quick installation is an advantage. Many strong currents exist in deeper waters, which makes harvesting the tidal stream more challenging. For this purpose floating structures are being developed.

Fixed placement is done with either a monopile or with a gravity based installation. A monopile is a single pole to which the installation is attached. The installation of a monopile involves drilling a hole into the soil. Depending on the type of soil this is easier or harder to achieve. The practice of drilling holes is well-known as the off-shore wind industry also uses monopile constructions. A gravity based installation does not require drilling. It does require the ocean floor to be flattened and prepared with gravel. The construction of gravity based foundations take considerable time in these harsh environments. Experimental designs use gravity based structures that can directly be put in place. An example is the concept by Tidalenergy Ltd. which places three turbines on a triangular structure that is sunk to the bottom of the ocean in one piece (Tidalenergy Ltd, 2012). It is useful to prepare the placement system in such a way that it is possible to replace the turbines, both for maintenance or the installation of improved models. Fixed placement becomes harder to achieve in deeper waters.

Floating structures use mooring and anchors to keep an installation in its place. The tidal stream installation can either have its own mooring, or be attached to a structure with a mooring. Floating structures are more difficult to engineer as it is hard to keep the structure in place considering the extreme environment. Nevertheless the development of floating structures will help to open up sites for tidal development that were previously unattractive.

2.4.1.3 Ducting

Ducting forms a cylindrical installation around the turbine to enhance flow through the rotor. This may increase the flow speeds which could work in sites with lower stream speeds. The enhanced speed also means smaller turbines are required for the same power output, which should reduce costs. The Lunar RTT shown in Figure 18 is an example of a tidal stream turbine with ducting. Experience in wind energy suggests that the performance improvement from ducting alone does not justify its cost. Whether this is the same for tidal stream is unclear at the moment. The Lunar RTT is one of the more promising designs, there is a working prototype and the developers have won a contract



Figure 18 Ducted concept by Lunar energy Ltd.

to install 300 tidal current turbines of the cost of Korea in a deal worth 800 million dollar (500GBP) (Lunar Energy Ltd, 2008)

2.4.2 Current status

The previous paragraph introduced several technological concepts and distinctions. The European Marine Energy Centre Ltd (EMEC) is a centre that provides testing facilities for tidal stream and wave energy technologies. Their website refers to no less than 87 companies with different concepts for tidal stream (EMEC, 2012). An adapted version of this list with the addition of some graphs is added as attachment H. There is a clear reason for the existence of all these technologies; the industry is new and immature and in rapid development. It is inherent in today's market that there will be few winners and many losers, that is simply necessary to reach a mature market (The Crown Estate, 2011). Eventually the market will have to settle on a certain design or set of designs that have proven to be reliable enough and cost-effective enough. Other factors such as the existence of a local market, intellectual property or first mover advantage could also be important. At the moment there is a plethora of developers that all try to become the first and best company to bring a technology to market. Companies such as Siemens and Hyundai have already invested in some concepts. Because of their size and the expertise that they can bring, these companies are likely to develop their own winner or acquire the company that develops the most promising concept.

Besides the developers there are also a number of countries and energy companies that are trying to get a foothold in the rapidly developing industry. Countries such as the UK are hoping to create favorable conditions for the industry to develop in their country so that the suppliers, knowledge centers and manufacturers are most likely to settle in that country. With the existence of strong tides in many regions in the UK and planned budgets of up to 9 billion pounds in the Corkney area, the UK is by far the most serious about investing in tidal and wave stream technologies. Other countries that are investing in a more moderate fashion are South Korea, Canada and France. More stand-alone pilot projects are initiated in countries as the USA, India, Netherlands and Norway. China is not developing any projects yet but monitors developments worldwide and opportunities locally, they have proven in other renewable industries that they can rapidly develop an industry if they wish to do so. European energy giants Eon and Vattenfall are also invested as a developer together with smaller more specialized entities such as Pelamis Wave Power, Scottish renewables and Acquamarine power (Bahaj, 2011). Gaining experience with the processes, permitting and procedures that are involved in the development of sites may prove advantageous in the future.

As mentioned earlier there is a very large number of concepts that are currently being developed. Any selection of 'promising' designs that could be presented here would prove obsolete in the near future. Aquaret and O'Rourke did attempt to provide an overview of technologies (Aquaret, 2008; O'Rourke et al., 2009). These lists will not be repeated here, a summary can be found in attachment H. Three examples of front runners taken from Bahaj (2011) will give an indication of where the industry stands:

1. Project SeaGen from the company Marine Current Turbines Ltd at Strangford Lough, Northern Ireland, UK, was successfully deployed in 2008. This is a second generation device consisting of a piled twin rotor two-bladed horizontal axis turbine converter of an installed capacity 1.2MW. SeaGen reports that the systems are now working well, in spite of initial delays, re-design of the piling process and a blade failure encountered in the early stages of the deployment. This is the world's first commercial scale tidal turbine prototype to generate electricity onto the grid independent from a test centre (Bahaj, 2011). Marine Current Turbine plans to install 11 units in 2013/14 in 'The Skerries (UK)' and Kyle Rhea (UK) in cooperation with npower. Furthermore they have won a lease in the Crown Estate to install 66 units in Brough Ness (UK) in 2017/2020.

2. Atlantis Resources Corp, in August 2010 deployed a 1 MW device at EMEC, see also Figure 19. But the device was subsequently removed due to blade failure. This is clearly a setback for the company and its plans for the future. However, the company indicated that the limited exercise provided ample experience in deployment of their device (Bahaj, 2011). Under the name 'Project Blue', Atlantis resources is planning to install 30 units with the Crown Estate in the Pentland Firth, as of yet there is no planning.

3. The Irish company OpenHydro has been testing their open centered, rim generator device, capacity 250kW, at the EMEC in the Orkneys for around three years. No news has been forthcoming on performance. The company seemed to be negotiating a project in France with EDF, but this has not been formally announced (Bahaj, 2011). OpenHydro is also involved in a plan to install 100MW in Scotland (UK) with Airtricity.

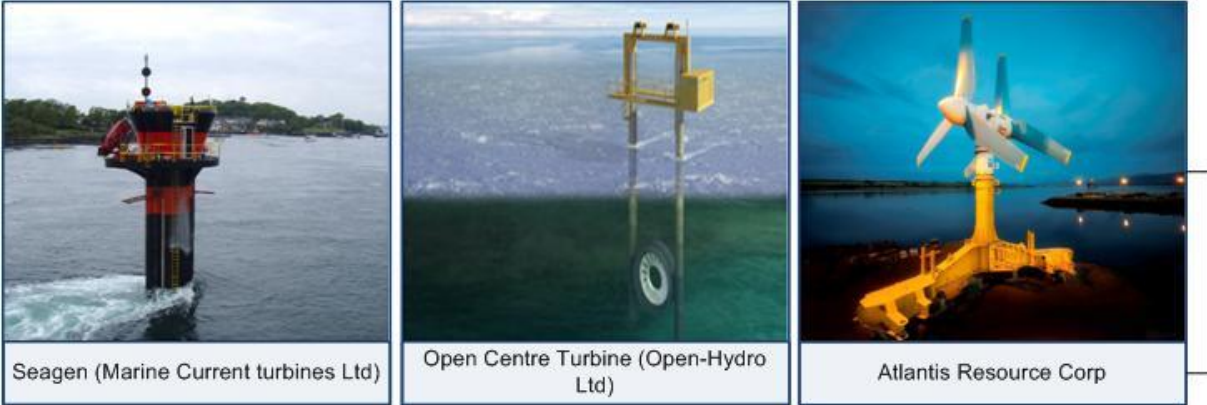

Figure 19 Examples of frontrunner concepts that have been tested on full scale. From left to right; SeaGen 1.2MW, twin rotor, 2 bladed turbine installed in Strangford Lough in April 2008. OpenHydro 250 kW open centred, rim generator device. Atlantis resources Corp 1MW, back-to-back twin rotor device prior to installation at the European Marine Energy centre. Picture 1 and 2 from (O'Rourke et al., 2009) and picture 3 from (Bahaj, 2011)

These examples show that the frontrunners in the industry have been able to install scale models and prototypes of their concepts. Some of these projects have been more successful than others but in all cases the objective was to learn from the experience. Some of the frontrunners have won leases to develop a large numbers of units in the next decade. Most of these leases were negotiated by the Crown Estate who governs the natural marine resources of the UK. Lunar Energy agreed a 700 million USD deal to develop 300 units in Korea (Luner Energy Ltd, 2008). Clearly all of the large development plans are scheduled for the medium to long term and thus subject to great uncertainties. The engineering designs are available, there is sufficient government support and funding available, the large corporations are involved, these requirements for rapid development of the market have all been met. The major challenges are to bring the manufacturing and installation cost down to an acceptable level and ensure that the (government) funds that are budgeted to go to tidal developments in the medium term will materialize.

2.5 Conclusions about tidal energy technology

This chapter set out to describe the technological options and issues concerning the development of tidal power. The technology options are design variables available for the conceptual design of a tidal power plant. The issues put constraints on the development of tidal power. As tidal barrage and tidal stream technology are so different from each other, they are treated separately

2.5.1 Conclusions tidal barrage technology

Tidal barrage technology is a proven technology that has successful precedents. It is a popular topic for feasibility studies in many places in the world, but only a handful of sites have been developed. There are multiple designs and operating schemes imaginable. The design is mainly decided on by the physical environment, the existing tides and the demands the (institutional) environment puts on the system.

2.5.1.1 *Main design variables*

- Operating schemes – Ebb generation versus Flood generation
- Operating schemes – One way generation versus two way generation
- Operating schemes – Single basin versus double-basin
- Optimization – Number, size and type of turbines
- Optimization – Necessity, number and size of sluices
- Construction in the wet or in the dry

2.5.1.2 *Constraints*

Every design comes with its own set of constraints. Technologically every design option is possible, but the resulting construction cost are often prohibitive. Cost is technically not a technological design constraint but it is heavily influenced by the technological design. Therefore the influence of the most important design options on the cost have been included here. A similar argument can be made for expected revenues, different designs have different pay-offs which could justify increased investment cost.

- Intermittency – Depending on the operating scheme there will be more or less of an issue with the intermittency of the production of electricity from the tides. The tides themselves are periodic and intermittent, a clear constraint of the system.
- Cost – The choice for an operating scheme has a large influence on the size of the initial investment cost. One way generation versus two way generation influences how many turbines are needed and how many sluices are needed.
- Cost – The choice for a single basin or a double basin design has a large influence on the initial investment cost. A double basin implies the need for an extra barrage, only in rare natural circumstances this would not be necessary.
- Cost – The number, size and type of turbines have a large influence on the cost of tidal barrage power plant design. The design of the turbines is dependent on the tidal range and the type of operating scheme. The larger the tidal range, the larger the turbines can be. One way operating schemes create a larger head than two way operating schemes and thus would allow for larger turbines.
- Revenues – The value of electricity production capacity is time dependent. Investments that add to the initial investment costs but increase production flexibility could have a positive cost benefit ratio.
- Impacts – Building a barrage has an impact on the environment in which it is placed. These are not to be underestimated. The impacts are environmental (fish population, dilution of the water, tidal marine environment), social (sailing, fishing, employment) and economic

2.5.2 Conclusions about tidal stream technology

Tidal stream technology is an immature industry that is developing fast. There are no existing plants that have been commissioned based on a positive cost-benefit analysis. This is not to say there is no future for tidal stream technology as some concepts have now been proven to work and costs will decrease quickly when the industry grows. If the objective is to develop one or more tidal stream generators in the Klabat bay in the short term it should be accepted that there is no commercial business case. The objective should be justified by the fact that the country and region is gaining experience with the technology and a remote area of Bangka is being serviced with power.

2.5.2.1 *Main design variables*

The focus of this chapter is on the technology behind tidal stream technologies. There is a plethora of design options and every design has its own advantages and disadvantages. In practice the choice for a technology is also influenced by non-technical variables such as; the experience of the supplier, national policies, existence of production lines and availability of materials.

- Configuration – There are three main concepts to turn kinetic energy from the streams into mechanical energy. Horizontal axis, vertical axis and making use of hydrofoils. There is no option which has a clear advantage over the others.
- Placement – The manner in which the unit(s) are fixed in place has a large influence on the cost, access for maintenance and options for redesign. Placement is partly decided upon by the physical environment. In deep waters it is difficult to engineer fixed placement. The options range from fixed placement using a gravity structure, using a single pole like off shore windmills to floating structures that are moored to with anchors.
- Ducting – Ducting may improve the efficiency of the turbine, but at this moment it is unclear if the increased efficiency is offset by the increase in investment cost.
- Developer – At this point of development the choice of the technology developer has a major impact on the technological design of the units
- Contracting – In the UK a tender for concessions decided on who will develop what and where. The tendering process design will have a large influence on the technological design.

2.5.2.2 *Constraints*

The most important constraint is that the market is very immature, there are no commercial plants in operation.

- Immature technology, no commercial plants in operation
- Energy production is very dependent on high stream speeds. The potential increases exponentially with an increase in stream speeds
- Operation in a (salt-water) marine environment causes engineering and maintenance challenges that have a negative impact on the cost of construction and operation
- Electricity transmission and distribution lines need to be included in the plan which slows down the development process and adds to the cost of development in often remote locations

3. Bathymetry

The tidal technologies explained in chapter 2 exist regardless of a location or environment. The feasibility of using a certain technology is very dependent on the physical environment in which it is designed to operate. This chapter is used to describe geometric facts about the location and to describe the bathymetry. Bathymetry is the study of under water depth of lake or ocean floors. It is the underwater equivalent of topography.

3.1 Topography and Geometry

Indonesia is located above the grinding and mashing of several tectonic plates, and ringed by a chain of volcanoes. This is one of the most volatile regions in the world with frequent volcano eruptions, earthquakes and tsunamis (Israel, 2010). Luckily, Bangka-Belitung is located much more safely. The epicenters of earthquakes mostly occur south-west of Sumatra and Bangka. Figure 20 roughly shows the depths of the seas in Indonesia. The ocean bedding in the Indian ocean, south-west of Sumatra and Java is very steep. The water depth just outside the coast is 300m and the dark blue areas get as deep as 6000 meter. Bangka-Belitung is located on a relatively shallow plane between the islands of Sumatra, Borneo and Java. The sea depths between these islands do not exceed 40m. There is even evidence that suggests the existence of a land bridge between Bangka-Belitung and the Malacca strait during the last glacial maximum, about 20,000 years ago (Bird, Taylor, & Hunt, 2005). Therefore the environment in Bangka-Belitung offers a much safer environment for a long term, large scale infrastructure investment. It is for this reason that the Indonesian government has even been eyeing on Bangka as the location for 2 nuclear power plants (Kusuma, 2010). Research on the stability and geometry was done by the International Atomic Energy Agency (IAEA, 2011). The information enclosed in these and future studies are also useful for establishing the feasibility of a tidal power development.



Figure 20 Indonesia, Bangka-Belitung in red (adapted from (Maps.google.com, 2012))

Figure 21 shows the administrative areas of Bangka-Belitung and the Klabat bay. The Bangka-Belitung province is divided into 7 administrative areas. The population density is highest in Pankal Pinang, the capital. For the rest the population is quite dispersed over the island. Every region has at least 100,000 inhabitants and totaled 1.1 million in 2008 (IAEA, 2011). The Klabat bay is located to the north of the island Bangka. The nearest city is Belinyu, to the east of the bay. Another nearby city of significant size is Sungai Liat, just north of Pankal Pinang. The Klabat bay can be divided into two

parts, the inner and the outer bay. The outer bay is mainly influenced by the Chinese sea while the inner bay is calmer and more heavily influenced by the rivers that end up in the bay.

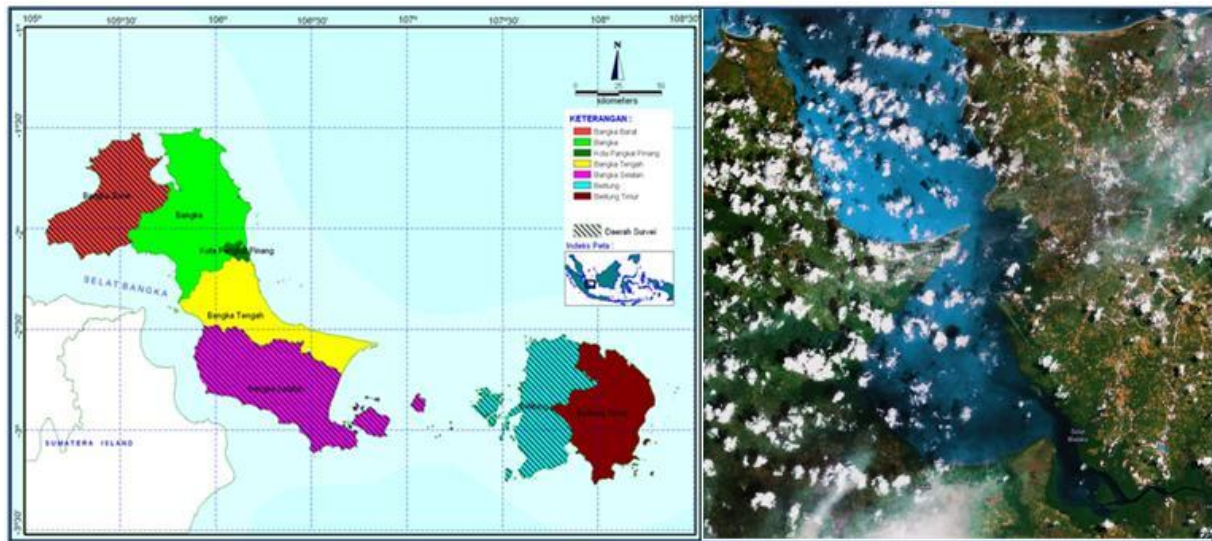

Figure 21 Left: Governance regions Bangka-Belitung (IAEA, 2011). Right; The Klabat bay (Maps.google.com, 2012)

It was suggested to investigate the feasibility of harvesting energy from the tides in the Klabat bay. A natural location for a barrage, or for tidal stream devices, would be at the narrow entrance to the inner Klabat bay. An important parameter for the calculation of the energetic tidal potential is therefore the surface of the inner Klabat bay, and the length of the entrance to the inner Klabat bay. As these are such important parameters it is shown on in Figure 22 and Figure 23 how these numbers were established. The surface area of the inner Klabat bay is estimated as 140km². The area to the south-east of the lake was not included as it is a shallow and partly dry area. Also, it is a choice to be on the safe side with the estimations. In further studies more advanced calculations can be made to establish the surface area, at this point of the study this estimation should suffice. The length of the narrow entrance is 1500m.

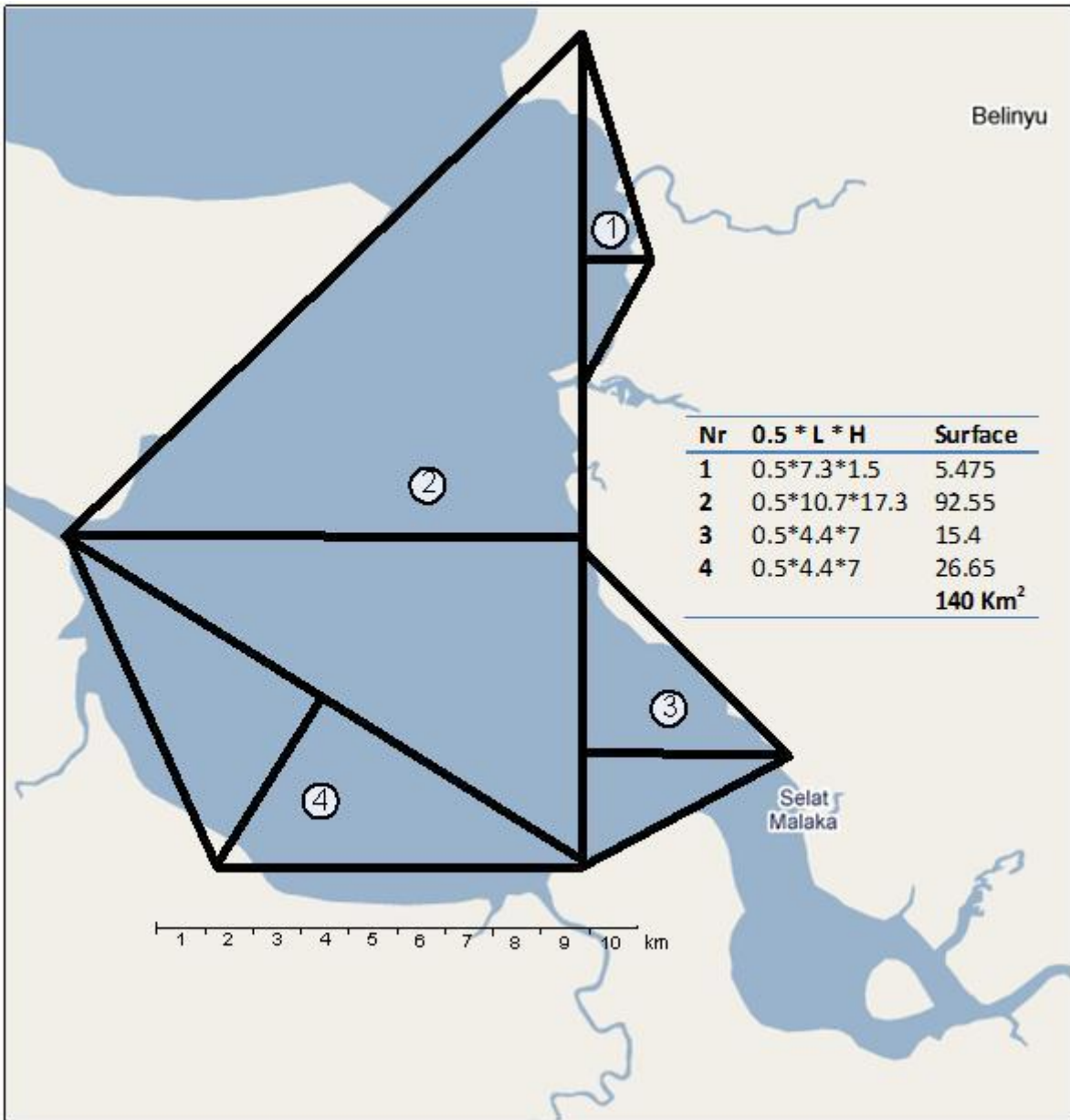

Figure 22 Calculation of the surface area of the Klabat bay



Figure 23 The length of the narrow entrance based on (maps.google.com)

3.2 Bathymetry of the Klabat bay

Bathymetry is the measurement of depths of water bodies, particularly oceans and seas. In this paragraph the available data on the size and depth of the klabat bay will be summarized. This data is essential for the analysis of different technologies that could be used for tidal power production.

Currently there are three different sources of information available about the bathymetry of the Klabat bay. Firstly there is a document in the journal for marine research Indonesia about sediments in the Klabat bay (I Sachoemar, Kristijono, & Yanagi, 2007). This research studies the oceanographic characteristics by using a series of measurements of temperature, salinity, turbidity, transparency and some other water constituents in the wet season (Northwest Monsoon) and the dry season (Southeast Monsoon). The research shows that the hydro-oceanographic characteristics of the inner part and the outer part of the bay were dominantly influenced by the terrestrial and oceanic environment, respectively. The depth of the water in the inner part is relatively shallow compared to the outer part due to high amount of sediments supplied by seven rivers. Depths in the inner part range from 1 to 13 meters, Figure 24 shows a map from the paper. The outer part of the bay is dominantly influenced by the neritic environment of the Natuna Sea. The narrow entrance, in this paper referred to as Cape Ruh, prevents good water circulation between the inner and outer area. Therefore the water constituents differ significantly between both parts of the bay during both seasons. The paper also states that the presence of the floating tin mining activity in the outer part of Klabat Bay, has caused the water quality within this area to be degraded and turbid. During the field research of this report however, the floating tin mining activity happened at the inner part of the Klabat Bay.

A second source of information is the sailor mapping system called TheMap. This digital system is designed to provide sailors with live information about water depths for navigation purposes. The TU-Delft has a limited version of the program installed in the map center for educational purposes. It is possible to get water depths of the Klabat bay but the picture is not very detailed. Figure 24 shows the kind of information that can be made available with TheMap. The outer part of the bay records depths of 1-16 meters. The inside of the bay records depths up to 9 meters.

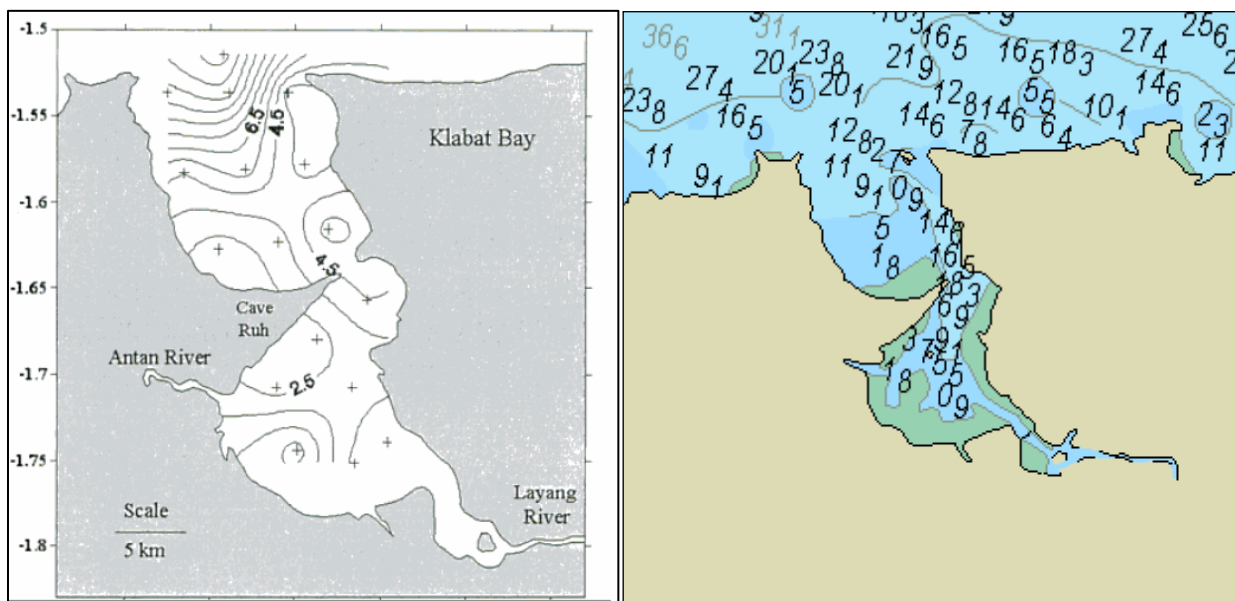

Figure 24 Left: Marine Research Indonesia (I Sachoemar et al., 2007), Right: TheMap - Klabat bay

The third source of information consists of on-site measurements. 16th of December 2010 a number of measurements were made with a rope and a weight. The methodology used was to throw a rope into the water against the current and dropping it to the bottom and measure the length of the rope. The rope had knots placed at every meter, and a colored knot at every 5 meter. Because for the weight it is not possible to recognize sludge, it does not measure the thickness of the sludge. Furthermore during the measurements around noon at the 16th of December the tide approximately added 2 meters to the measurements. These measurements showed however that the depth in Cape Ruh amounts to at least 20 meters. According to the sailors the weather and sea conditions during wet seasons can get very rough with waves of a couple of meters. During dry season the conditions are much more calm.

While performing these measurements it was visible that PT Timah, the tin mining company, had operations running in the inner Klabat bay. A large ship was collecting and processing soil from the inner Klabat bay. This suggests that PT Timah may have more detailed information on the bathymetry of the Klabat bay.

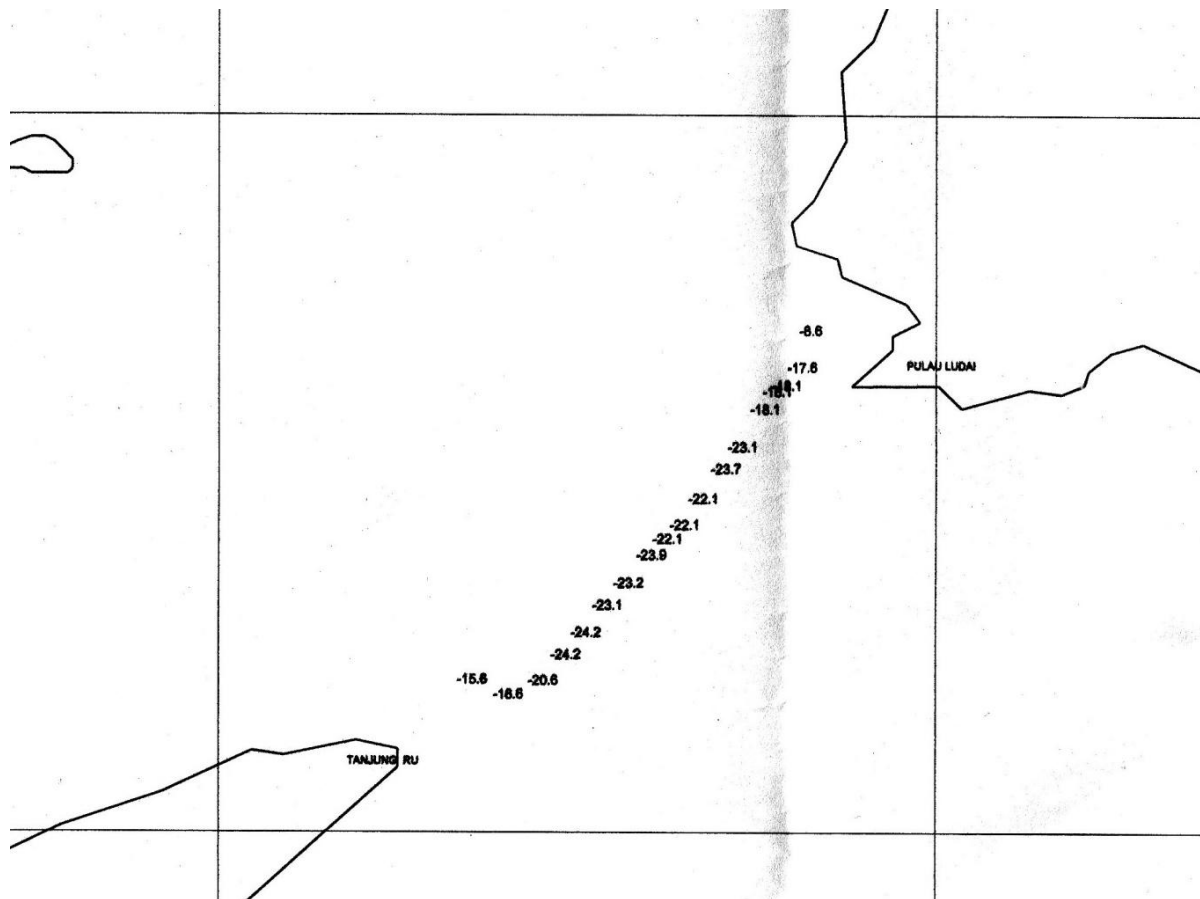

Figure 25 Results on-site depth measurements, December 2010, in meters

A number of conclusions can be drawn when combining the three sources of information. Firstly the inner part of Klabat bay is more shallow than the outer part. Depths in the inner part vary between 1-13 meters, although most prevalent are depths below 10 meters. The outer side of the bay is naturally more influenced by the south Chinese sea. The average depth in the outer part seems deeper. The narrow entrance of the bay called Cape Ruh is a lot deeper. The manually recorded depths range between 20-24 meters.

3.3 Conclusions about the bathymetry

A number of conclusions can be drawn from the assessment of the geometry and the bathymetry. The bathymetry doesn't offer any design variables but instead defines the environment and thus the constraints in which a system is designed.

3.3.1 Bathymetry constraints

- The surface area of the inner Klabat bay is 140km², or 140.000.000m²
- The length of the narrow entrance at Cape Ruh is 1500m
- The water depths in the inner Klabat bay vary between 1-13 meters, although most prevalent are depths below 10 meters.

3.3.2 Unknowns

The bathymetry offers constraints for the development of tidal power in the Klabat bay. This pre-feasibility study has limited resources to investigate the bathymetry. This is a list of the known unknowns and suggestions for further research:

- The impacts of sediments in the inner bay on the depth of the lake are largely unknown. A better understanding about the settling of sediments is necessary before a decision can be made about tidal power development
- The depths found in the analysis are estimations and lack detail. A better understanding of the lakes bathymetry is necessary for a better assessment of the feasibility The operations by PT Timah in the Klabat bay suggest that they might have more detailed data about the depths of the Klabat bay and its intricacies.
- The research which is being performed for the feasibility assessment of nuclear power development on Bangka could be just as useful for the feasibility assessment of tidal power development on Bangka.

4. Energy Potential

An estimation of the energy potential that is inherent in the tidal streams in the Klabat bay.

4.1 Tidal range

The Klabat Bay and its narrow entrance at Cape Ruh appear to have geographic characteristics that could support the development of tidal power. Because of the narrow entrance the construction work of a dam would be limited and the narrow entrance speeds up the water flow which is good for tidal stream development. However, the potential is very dependent on the size of the tides. This chapter assesses the tidal characteristics of the Klabat Bay. Information about the tides was available in the form of monthly tidal tables for the year 2010. An example of these tables is provided in Appendix E. The only information available about the location of the measurements is $01^{\circ} 42' S - 105^{\circ} 42'$ Teluk Klabat.

4.1.1 A regular diurnal tide in the Klabat bay

The case of the Klabat bay is somewhat exceptional. High water and low water occur only once a day. This means the diurnal constituents of the tides are predominant. These are the constituents that cause tidal variations with a duration of about 24 hours such as the larger lunar, the larger solar and the larger lunar elliptic constituents (Bernshtein, 1996). This makes the tide in the Klabat bay a regular diurnal tide. As a consequence the period of a tidal range becomes a little longer than one day, and power can only be generated once per day. This is a serious pitfall as most of the existing tidal power plants and feasibility studies focus on places where the tide occurs twice a day, and thus the potential to extract energy occurs twice a day.

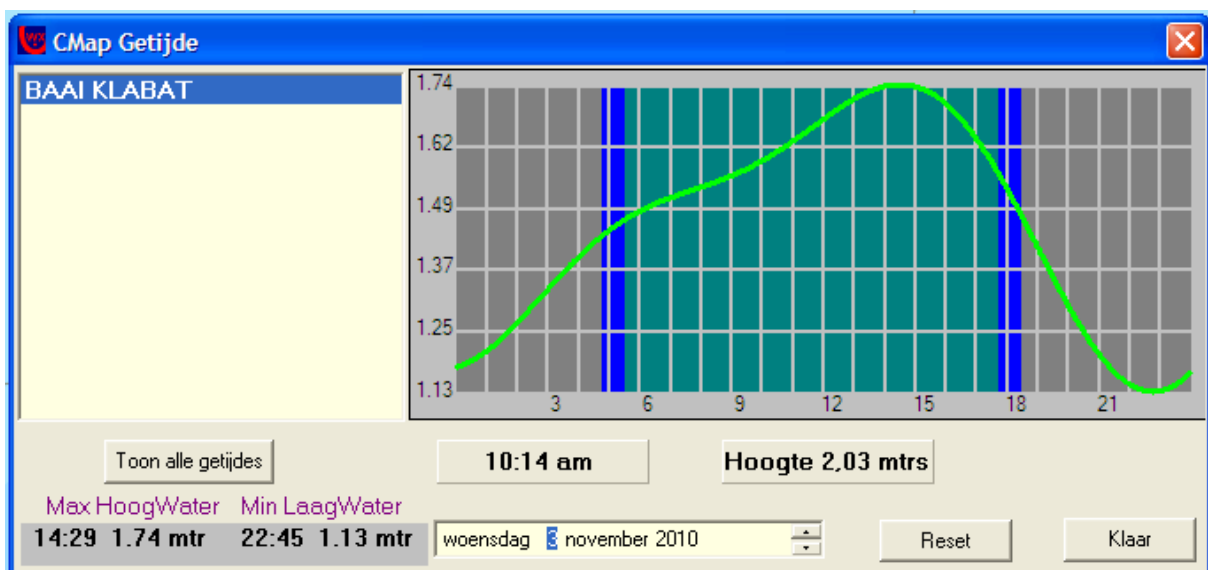

Figure 26 Regular diurnal tide in the Klabat bay - Tidal period 3-11-2010 from TheMap

4.1.2 Water levels in the Klabat bay

The employees of Pt. Timah were able to provide monthly tidal tables for the whole year of 2010. Examples of these tables and explanations about the conversion can be found in attachment F. These tables were converted in Microsoft Excel into graphs that show the changing water levels. Figure 28 shows the water levels for the month of January 2010. The tidal range is the difference between water level during high water and low water in one day. The graph shows tidal ranges from

as little as 0.6m to as much as 3m in the month of January 2010. The variations in water level amplitudes follow 14 day cycles.

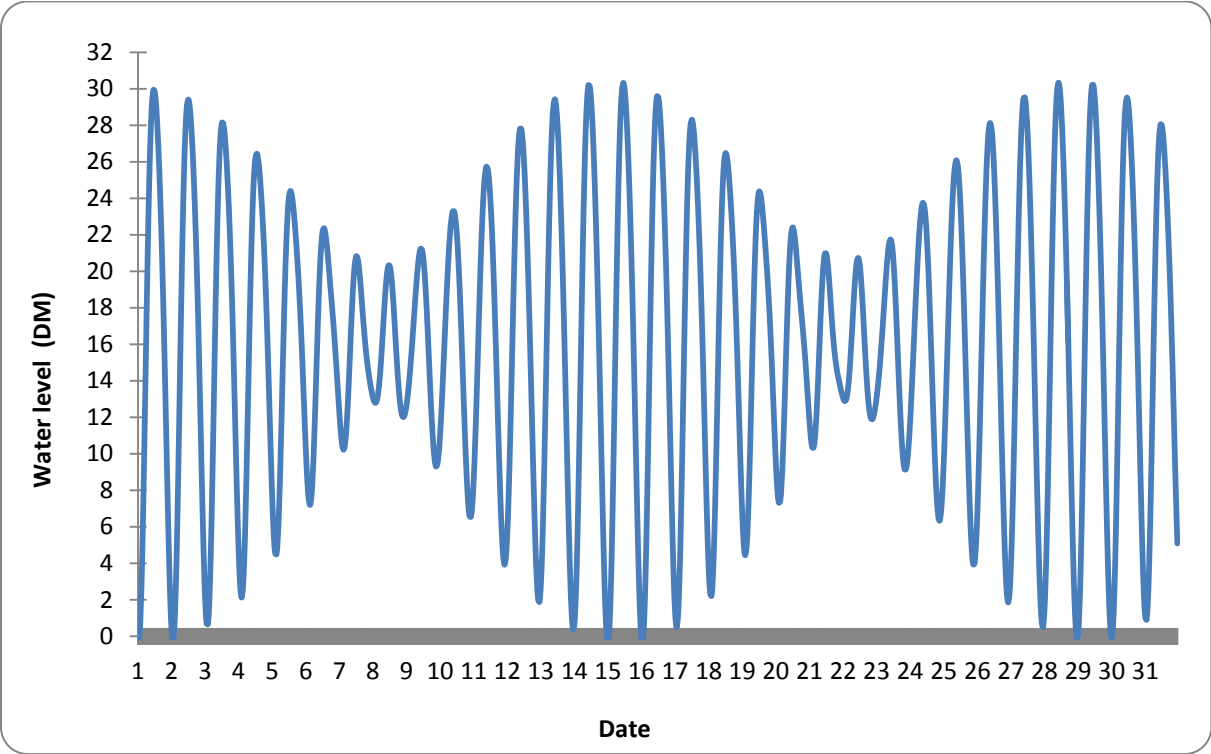

Figure 27 Water levels Klabat Bay Januari 2010

4.1.3 Tidal ranges in the Klabat Bay

By calculating the tidal ranges for every day of 2010 it is possible to get a good impression of the ranges during the whole year. It also becomes possible to calculate the mean tidal range. The graph in figure 29 shows the tidal ranges plotted for 2010. During the year ranges are observed of 0.2m up to 3m. The upper ranges during a 14 day cycle range from 2.2m to 3m. The lower ranges during a 14 day cycle range from 0.2m to 0.8m. With the available daily tidal ranges for 2010 it is also possible to calculate the average tidal range. The average tidal range is 1.77m. This an important parameter to establish the energy potential of a given site. Figure 28 shows the tidal ranges in the Klabat bay plotted for 2010. It shows clearly the 14 day cycles. There is also a variation in amplitudes with a period of half a year. For the pre-feasibility assessment the information of a full year provides sufficient detail. More detail could be necessary in future feasibility studies to incorporate the tidal variations with periods of more than one year.

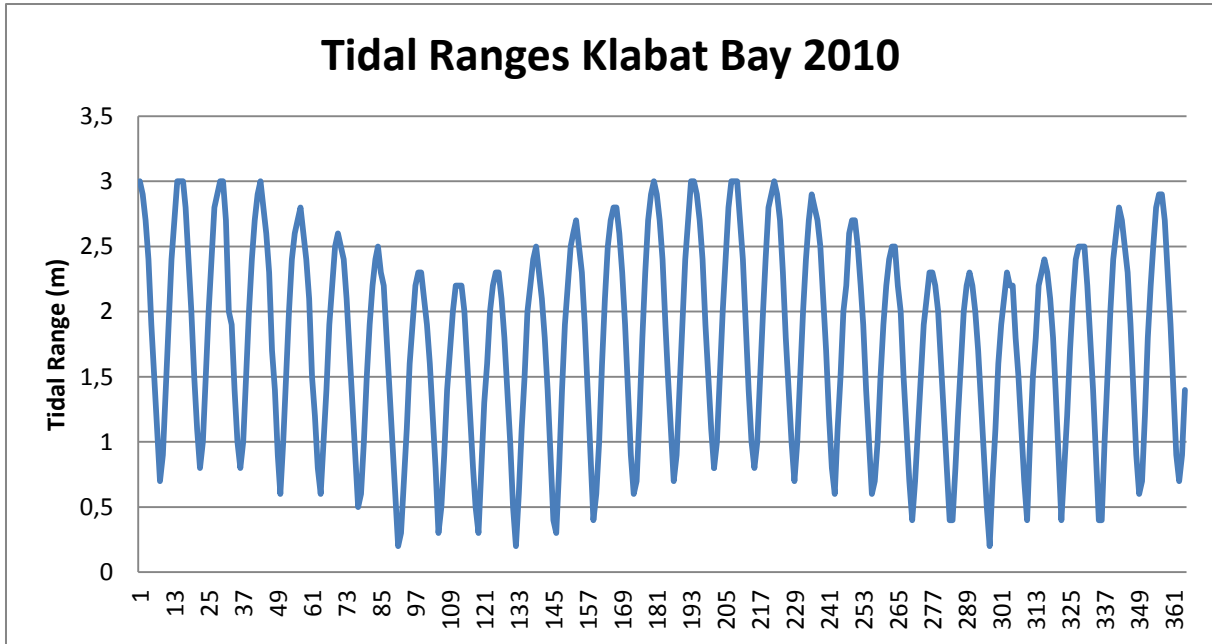

Figure 28 Tidal Ranges Klabat bay 2010, 26 cycles with 14 day periods. The horizontal axis shows the days of the year 2010

4.2 Natural energy

This paragraph will investigate the amount of energy that can possibly be extracted from the tides in the Klabat bay. The concept of natural energy potential of a site was introduced by Robert Gibrat in 1966. In this paragraph a similar approach is used as Swane used in his master thesis for civil engineering (Swane & Stive, 2007)

4.2.1.1 Natural energy potential of a site

The term 'Natural energy' signifies the maximum amount of energy that can possibly be extracted from a site. The outcome is a theoretical number because in practice it is impossible to have perfect generation schemes or 100% efficient generators. The number shows the theoretical potential of a site. For a tidal power plant this means the assumption of 100% efficient, double effect turbine-generators. Meaning that energy can be generated with incoming as well as outgoing tides. Also it is assumed that the maximum water levels can be used perfectly in both directions.

For a 100% efficient hydro plant, the energy E in [J] supplied by a water volume V (tidal prism) falling over a height of h meters is

$$E = \rho g V h$$

The power output P in [W] of such a plant is then

$$P = \rho g Q h$$

The energy $E_{nat,cycle}$ in [Wh] generated by filling and emptying a tidal basin during one tidal cycle becomes

$$E_{nat,cycle} = \rho g V R / 3600$$

The energy potential of a basin is proportional to the square of its tidal range, the root-mean-square value of the tidal ranges over a year's duration, R_{rms} , can be used to calculate $E_{nat,year}$ in [Wh]. The

total number of cycles per year is 365. The amount of natural energy, dissipated per year in one tidal basin equals

$$E_{nat,year} = 365 \cdot \rho g V_{rms} R_{rms} / 3600$$

In which V_{rms} refers to the tidal prism volume that corresponds to the tidal range of the R_{rms} ($R_{rms} \cdot A$). Attention has to be paid not to confuse V_{rms} with the root-mean-square of the volume of the tidal prism. Substituting the known values for ρ (1035 kg/m³) and g (9.81) simplifies the formula:

$$E_{nat,year} \approx 1030 \cdot V_{rms} R_{rms}$$

Using the values for the tidal ranges in 2010:

$$R_{rms} = \sqrt{\frac{R_1^2 + R_2^2 + \dots + R_{365}^2}{365}} = 1.926$$

$$V_{rms} = R_{rms} \cdot A_{bay} = 1.926 \cdot 140.000.000$$

$$E_{nat,year} \approx 1030 \cdot 1.926 \cdot 140.000.000 \approx 280 \text{ GWh}$$

To put this number into perspective, that is enough to provide about 80.000 Dutch households with electricity.

4.3 Energy potential: Barrage

The calculation in the previous paragraph shows the natural potential. Using data from previous experience it is possible to make an estimation of the actual power production. For this it is necessary to make assumptions regarding the efficiency of the plant and the usable head. These are partly dependent on the plant design configuration. The formula's used and the estimations for the values were largely taken from Mooyaart (2009).

The energy that can be produced during every tidal cycle can be described with the following formula:

$$P_{tidal\ cycle} = \eta \cdot \rho \cdot g \cdot H \cdot Q$$

For which

P = Power [W]

η = efficiency of tidal plant [-]

ρ = density [kg/m³]

H = Usable tidal range [m]

Q = flow [m³/s]

The values for H and Q are dependent on the plant design and do not directly correspond to the H and Q that were used in the potential calculation. Because turbines need a certain minimum head to operate and operating schedules also put limitations on the use per cycle. In addition to that the plant will not be operational 100% of the time because of maintenance and possible heavy storms. Adding all these factors to the formula, multiplying with the amount of annual cycles and dividing by $3.6 \cdot 10^{12}$ gives the formula for annual energy production.

$$E_{annual} = \frac{a \cdot \eta \cdot \rho \cdot g \cdot H_{avg} \cdot V_{avg}}{3.6 \cdot 10^{12}}$$

	Value [unit]	represents	calculation
a	$0.96 * 365 [-]^{-1}$	The amount of usable tides annually	Not all tides can be used for energy generation as there will be periods of maintenance or storms. The plant in La Rance was able to produce power 96% of the time (Mooyaart, 2009).
η	0.9 [-]	Efficiency of TPP	The efficiency of the TPP is dependent on the design of the plant. Major factors contributing to the efficiency are the type of turbines, plant layout and dimensions of the sluices. According to Mooyaart (Mooyaart 2009) the efficiency can reach 90%.
ρ	1035 [kg/m ³]	Density seawater	Different measures can be found for the density of seawater. Measurements range from 1025 to 1035 kg/m ³ . For this estimation is chosen to use 1035 kg/m ³ .
g	9.81 [m ² /s]	Gravity	Gravitation
H_{avg}	0.89 or 1.15[m]	Average head	Not all the head can be used for generation purposes. With a single basin one directional design about 66% percent of the tidal range can be used. With a single basing two directional plant about 50% of the head can be used (Mooyaart, 2009). For this estimation is chosen to take only these two configurations into account.
V_{avg}	$1.25 * 10^8$ or $1.61 * 10^8$	Average prism volume	The average volume of the water per cycle. This can be calculated by multiplying the H_{avg} with the surface (A [m ²]) of the lake. This number depends largely on the type of generation program that is used. It is a trade-off between generating for more time per cycle or using more head. This is why for a single directional plant the H_{avg} is 66% and for a two directional plant this is 50%. Being able to generate for a longer period can be a big advantage because it reduces the problem of intermittency. The surface is 140km ²
E_j	99 or 165 [GWh/annual]	Annual extractable energy	Annual extractable energy

Filling in the formula with the given assumptions results in a possible power production of about 100-165 GWh annually with the use of tidal impoundment.

Caveat:

- The usable head is relatively small. Turbines need a minimum head to start working. To minimize this effect there will be a need for relatively small turbines in relatively large numbers.

4.4 Stream speeds

Tidal stream technologies are very much a developing industry. For an initiative to develop tidal stream in the Klabat bay it is necessary to have some knowledge about national tidal stream opportunities as well as local stream speeds. Developing tidal stream technology in the Klabat bay will require support from national funding and knowledge centres. Therefore it is important to know how the potential in the Klabat bay relates to potentials in the rest of Indonesia.

4.4.1 Tidal streams in Indonesia

Ray and Egbert (2005) offer an overview of the tides in the Indonesian seas. Tidal phenomena in the Indonesian seas are among the most complex in the world. The many small islands, narrow straits, rugged bottom topography and large quantities of tidal input from the Indian and Pacific ocean make for a complex system of waves (Ray & Egbert, 2005). Two important contributing factors to the Indonesian tides are tides coming in from the Indian ocean and from the Pacific ocean. Where the tide from the Indian ocean has a strong semi-diurnal (twice a day) component, and the tide from the Pacific ocean an exceptionally strong diurnal (once a day) component. Places exist in Indonesia where all factors cancel each other out and the tide is virtually zero. The stronger component by far in the Bangka area is the 'pacific tide' component, which explains the diurnal characteristic of the tide in the Klabat bay.

In general stream speed velocities reflect bathymetry, with shallow waters giving rise to rapid currents. Especially the tide coming in from the Indian ocean, where the waters are deep, meeting with the islands of Bali, Lombok, Flores and Timor causes fast tidal streams. Figure 29 depicts the maximum current velocities caused by the tide from the Indian ocean. The color bar is non linear, the red colored parts represent speeds of more than 1m/s. These sites are most interesting in Indonesia to investigate for tidal stream opportunities. Unfortunately the contribution of these tides to the streams in the Klabat bay is minimal, the islands of Sumatera and Java impedes the influence of the Indian ocean tides.

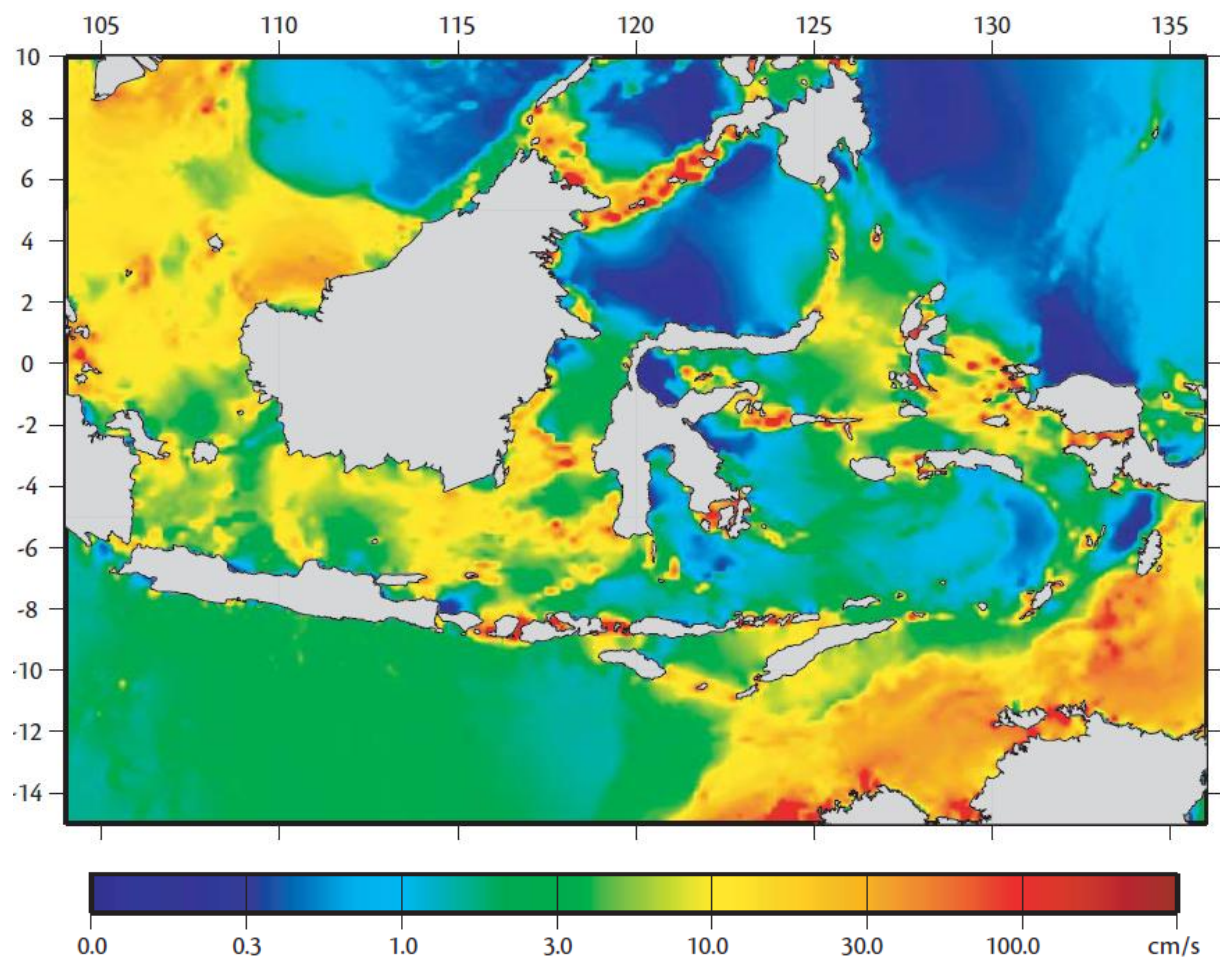

Figure 29 Maximum barotropic current velocity of the tide from the Indian ocean (Ray & Egbert, 2005)

4.4.2 Estimation of the stream speeds in the Klabat bay

The stream speeds are an important parameter for tidal stream technologies. Stream speeds occur locally and need to be researched in detail and on site. For now, an estimation of the average stream speed will give an indication of the potential.

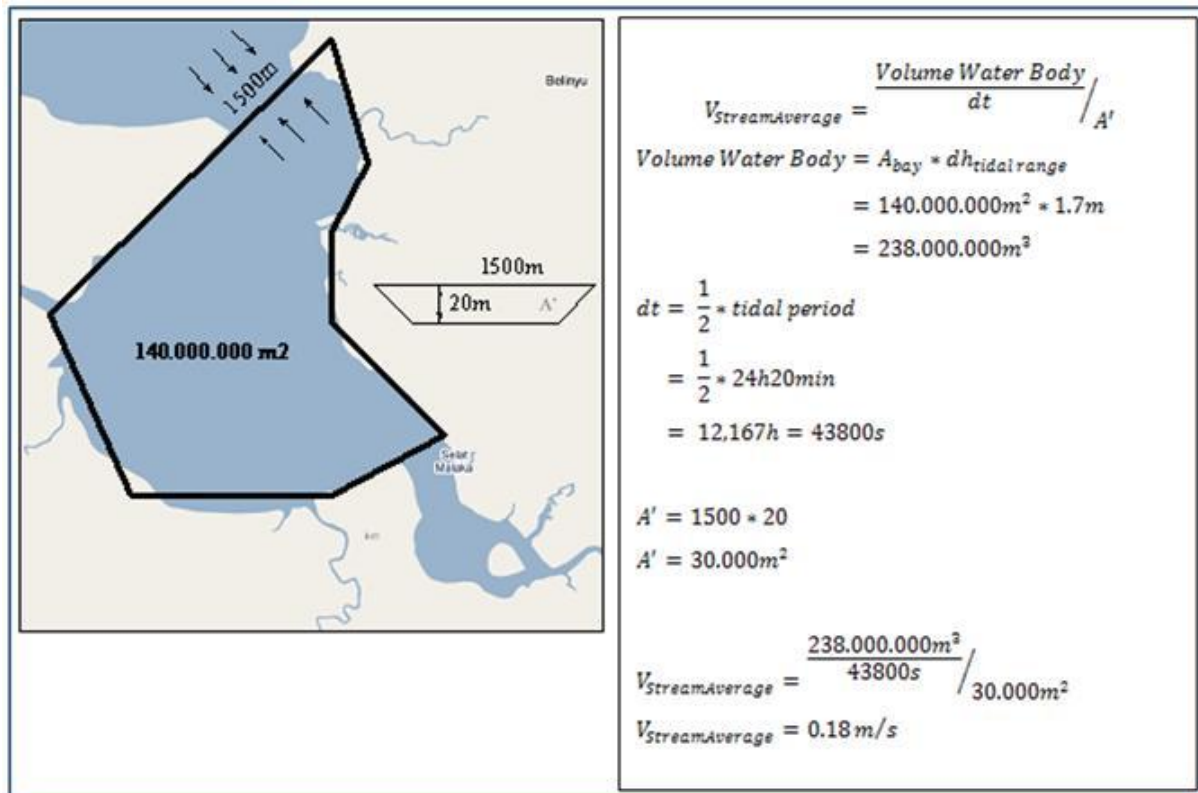

Figure 30 Left: Klabat bay surface and water flow at Cape Ruh. Right: Calculation of the average stream speed

By calculating the volume of water that has to move through the bay every tidal period and dividing it by the surface of the plane it needs to move through it is possible to calculate the average speed of flow. For the purpose of this estimation it suffices to use estimations of the surface of the lake (140km²) and the plane of cape Ruh (30.000m²). The calculations in Figure 30 result in an average stream speed of 0.18m/s.

4.5 Energy potential: Stream

Tidal stream generators draw energy from currents in a similar way as wind turbines. The higher density of water, 832 times the density of air, means that a single generator can provide significant power at lower tidal flow velocities as compared with wind speed. In other words, water speeds of nearly one-tenth of the speed of wind provide the same power for the same size of turbine system. The total kinetic power in marine current can be expressed by the following equation:

$$P = \frac{1}{2} \rho A v^3$$

Where ρ is the seawater density (kgm^{-3}), A is the swept area of turbine blades (m^2) and v is the velocity of the seawater (m/s).

However, a marine energy converter or turbine can only harness a fraction of this power due to losses and the equation becomes:

$$P = \frac{1}{2} \rho C_p A v^3$$

Where C_p is the power coefficient and the percentage of power that can be extracted from the fluid stream taking into account losses due to Betz's law and the internal mechanisms within the converter or turbine. For wind generators, C_p has typical values in the range 0.25-0.3. The upper limit is for highly efficient machines with low mechanical losses. For marine turbines, C_p is in the range of 0.35 – 0.5. With an increase in stream speeds the possible harvested power increases exponentially. As a result the effectiveness greatly increases with faster speeds. It also makes it attractive for developers to overestimate stream speeds in development areas as it has a large impact on the yields. The proportionality with the surface means that there is an incentive to increase the size of turbines. The possible size of turbines is often limited by the local bathymetry.

The economics of existing tidal stream technologies become interesting with stream speeds of 1.5m/s and upwards. As calculated in the previous paragraph the estimated average stream speed is calculated as 0.18m/s. Of course this outcome is an average speed during an average tidal range. During spring tides, with ranges of 3m, the streams will be faster. The speed flows are not the same during one tidal cycle, it will slow down between ebb and flood.

Stream speeds are a local occurrence and it is very well possible that there are places in the bay where stream speeds are acceptable for small scale tidal stream developments. Fishermen have reported on dangerous places for sailing because of treacherous flows.

- Stream speeds can be high locally, a further investigation is necessary to investigate local stream potential
- The average stream speed is estimated to be 0.18m/s
- Sites that are deemed interesting for development of tidal stream projects generally have stream speeds of 1m/s and more

4.6 Conclusions Energy potential

The bathymetry and the size of the tides put environmental constraints on the design of a system. The calculations of the energy potential quantifies these constraints in a manner that is useful for the feasibility analysis.

4.6.1 Energetic constraints

- There is a regular Diurnal tide in the Klabat bay. As a result there is only one high and one low water every day.
- The average tidal range during a year is 1.77m
- tidal ranges from as little as 0.6m to as much as 3m in the month of January 2010. The variations in water level amplitudes follow 14 day cycles
- The natural energy, or theoretical potential, of the inner Klabat bay is 280GWh annually
- Using formula's derived from previous experience the practical energy potential of the inner Klabat bay with tidal barrage technology ranges between 100-165 GWh, depending on the design
- The usable head is relatively small. Turbines need a minimum head to start working. To minimize this effect there will be a need for relatively small turbines in relatively large numbers

- Stream speeds can be high locally, a further investigation is necessary to investigate local stream potential
- The average stream speed is estimated to be 0.18m/s
- Sites that are deemed interesting for development of tidal stream projects generally have stream speeds of 1m/s and more

5. Institutional Environment

The institutional environment is the collection of public, private, formal and informal arrangements that are of importance to the development of a tidal power plant in the Klabat bay. The faculty of Technology, Policy and Management of the TU-Delft is at the forefront of academic development of institutional analysis and institutional design. Koppenjan and Groenewegen from the TU-Delft offer the following definitions of institutions and institutional design:

Institutions:

'Technological systems are in need of 'rules of the game' that guide and coordinate the behaviour of actors. These arrangements can be formulated in formal laws, but can also be of an informal nature. The rules that coordinate behavior can be of a public or private character. The public, private, formal and informal arrangements can be regarded as institutions necessary for the system to function. Institutions or institutional arrangements are thus a set of rules that regulate the interaction between parties involved in the functioning of a (technological) system.' (Koppenjan & Groenewegen, 2005)

Institutional design:

'Besides the design of the technological component, complex technological systems require an institutional structure that coordinates the positions, relations and behavior of the parties that own and operate the system. Aside from a technological design, an institutional design is also needed.'

'Institutional design is not separate from technological design, nor is it determined by it. True, the issues that have to be settled by institutional design follow, to a large extent, from the specific technological characteristics of a system, but the institutional solutions that are chosen may vary.' (Koppenjan & Groenewegen, 2005)

To make a design for the public, private, formal and informal arrangements it is first necessary to investigate the existing institutional environment. Koppenjan and Groenewegen specify institutional analysis further by distinguishing four levels of analysis, inspired by the four layer model of Williamson. The four levels signify the need for a different perspective for social analysis on the different levels (Williamson, 2000). Each level has its own kind of institutions and helps define the relations between the various levels and institutions.

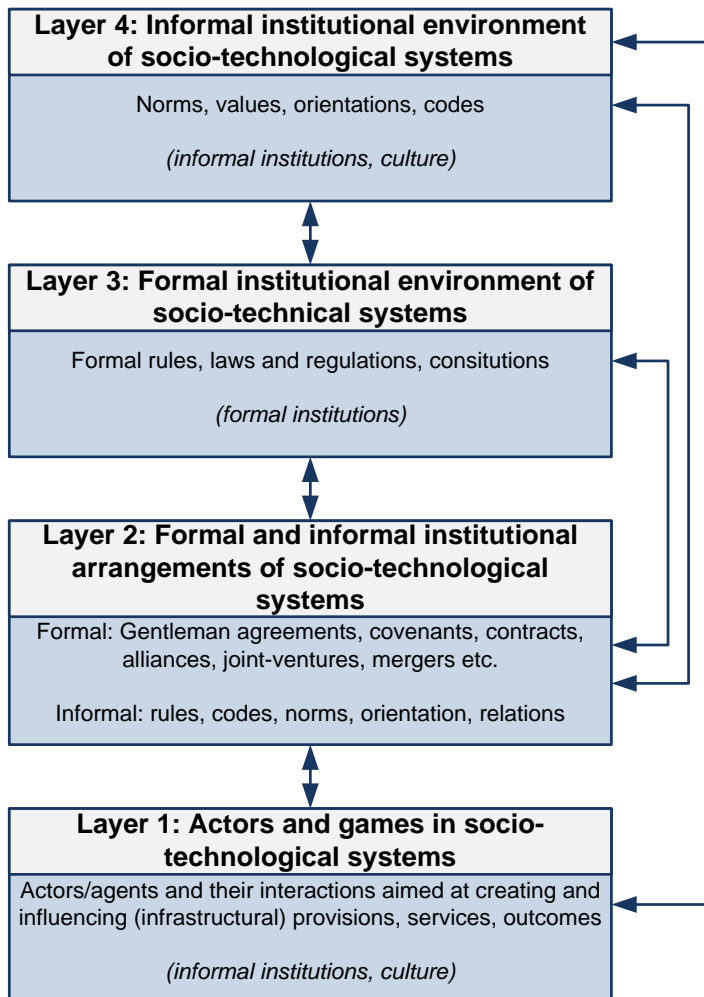

Figure 31 Four layer model Koppenjan and Groenewegen (2005) (adapted from Williamson, 2000)

The model introduced by Koppenjan and Groenewegen differs fundamentally from the original in two aspects:

1. *The layer of actors and their strategies is added to the transaction cost approach*
2. *This four layer model explicitly allows for the interaction between the layers (Koppenjan & Groenewegen, 2005)*

Transaction Cost Economics are fundamental to New Institutional Economics. The cost of transactions is considered an important factor to how institutions are shaped. Koppenjan and Groenewegen add actors and their corresponding strategies to the model. In doing so, the model allows for the inclusion of theories from stakeholder management and process management. They also explicitly allow for the interaction between layers where Williamson envisions a generally top-down relation with only minor influence upwards.

Layer 1 is at the level of individual actors and their interactions in the context of a complex technological system or setting. This is at the level where a local regent tries to get the attention of the prime minister for a local energy project. Layer 2 is about the mechanisms available to coordinate transactions between actors, and most interesting for this project. It holds for example the mechanisms available for PLN to purchase power from independent producers. Layer 3 specifies the legal rules of the game, an example relevant for this project is the 2009 electricity law. Layer 4 defines the culture, values, norms and attitudes. This level influences the perceptions of agents with

respect to problems they identify and solutions they consider feasible. For example the perception of a local fisherman towards decision making in Jakarta.

The influence of the designer should not be overestimated. For a project such as tidal power development in the Klabat bay the designer does not have the ability, nor should have the desire, to change layers 3 and 4. Therefore these are considered outside the scope of design for this project. They do help define constraints for the system. Layer 1 deals with the individual actor and his actions within a system. As this is a pre-feasibility study these kind of interactions are at this moment not the most interesting. For the identification of design goals and design variables for this project the arrangements available in layer 2 are the most relevant.

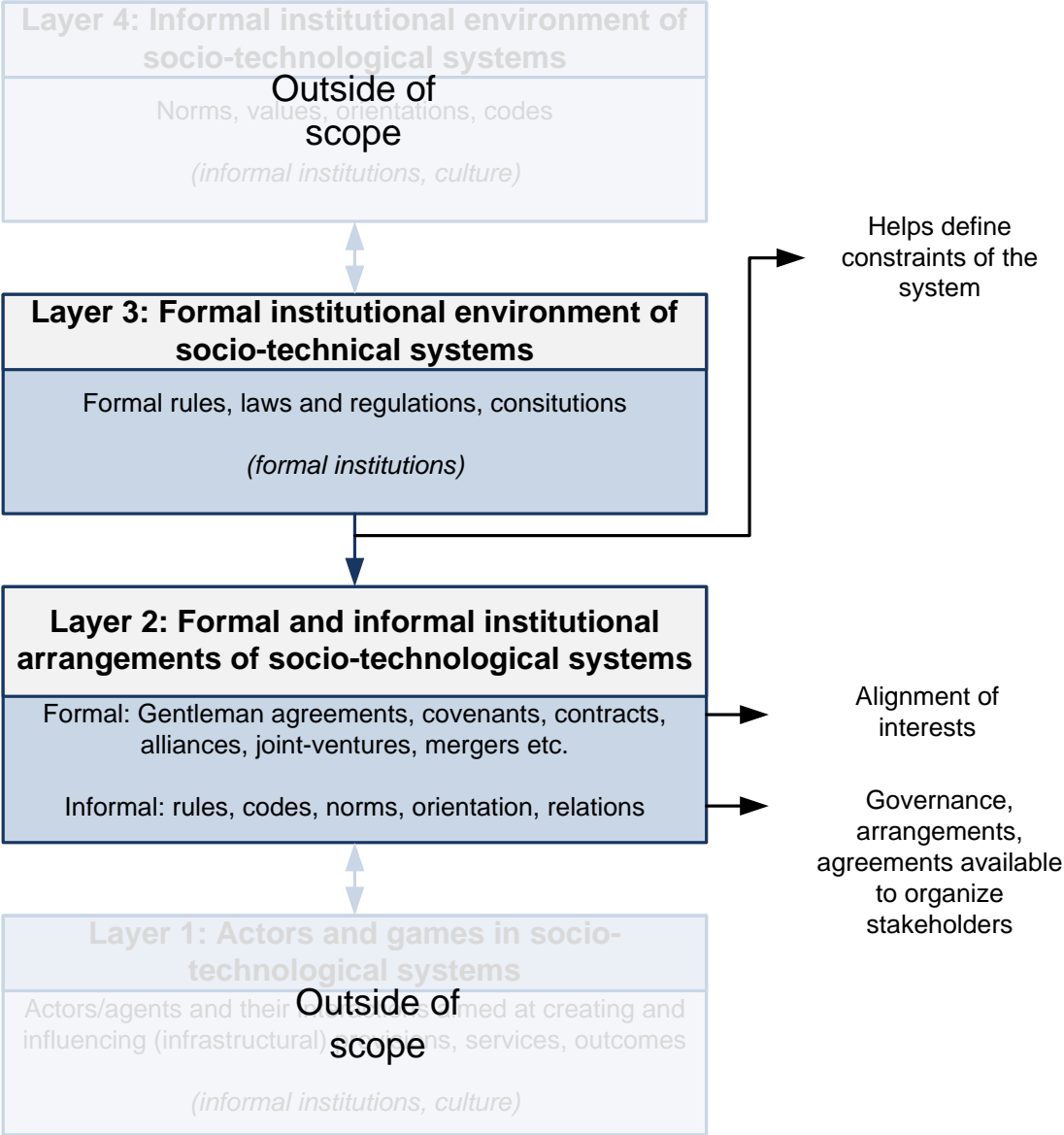

Figure 32 Scope of the institutional analysis

For this analysis layers 1 and 4 are considered to be outside of the scope. Layer 3 helps define the legal environment of the system and thus the legal constraints on the system. Most relevant for the design of a tidal power plant are the alignment of actors and the mechanisms available to organize stakeholders. In this regard the factor ‘time’ is also relevant. The alignment of interests of actors is especially relevant during the initiation and development of a project. The manner of organization of

contracts, how to organize risk management and how to organize delivery of electricity is especially relevant after a decision has been taken to build a tidal power plant.

Firstly the legal framework which offers constraints is discussed. The alignment of interests is analyzed with the help of a stakeholder analysis. Then the governance, arrangements and agreements available to organize stakeholders are discussed.

5.1 Layer 3: Constraints imposed by the legal framework

The government in Indonesia and its provinces have undergone major changes since the end of the Suharto era. The process towards a more democratic and decentralized governed Indonesia is still an ongoing process (The World Bank, 2009). Large infrastructural developments need a strong governmental, financial and local support to succeed. Governance has a large influence on the investment climate, it has the ability to offer stability (or not) and introduce (financial) incentives. Relevant for this study are the constraints and opportunities caused by the transformations in Indonesian governance, Indonesian energy policy, existing laws and regulations.

5.1.1 Constraints and opportunities caused by the transformations in governance

After Indonesia gained independence, first Sukarno and later Suharto enacted a very centralized form of government. Virtually all decisions were taken in Jakarta. Even today it is clear that Jakarta is very much at the centre of everything that happens in Indonesia. Since the end of the Suharto era, Indonesia has undergone remarkable reforms of democratization and decentralization. More and more policy development and enforcement is left to the provincial levels and subsequently the regional levels. Bangka-Belitung is a good example of this development. It became an independent province in 2001, since then investments in the island have increased. Examples are the investment in local roads, the promotion of the island as a popular holiday destination, investment in coal fired power plants and the possible development of a local harbor which could compete or cooperate with Jakarta and Singapore.

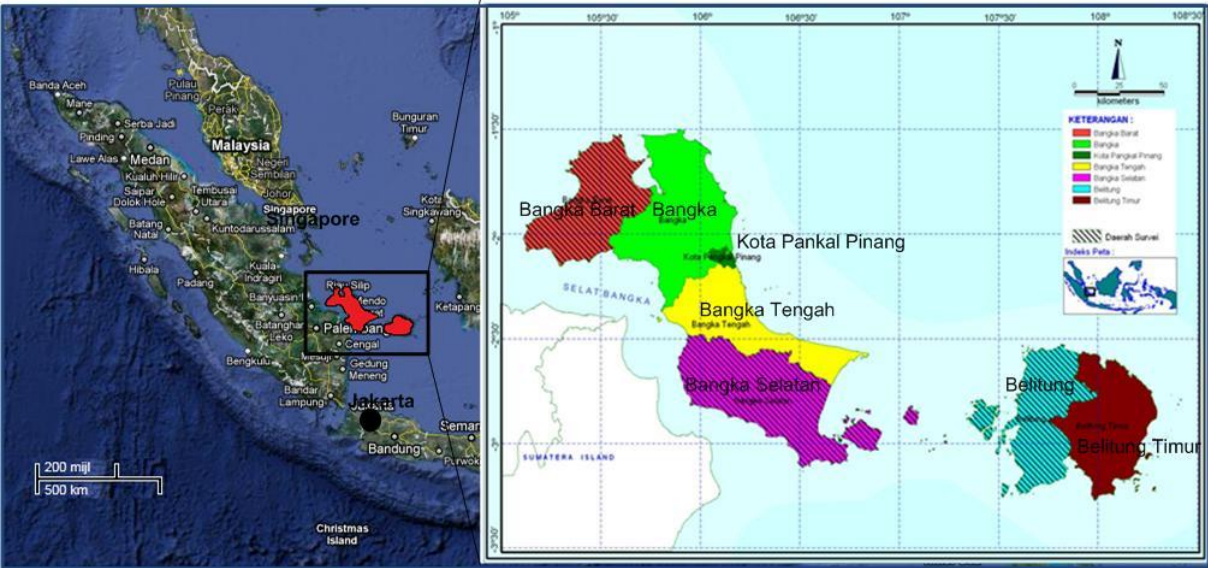

Figure 33 Regions Banga-Belitung adapted from (IAEA, 2011) and maps.google.com

The national government has its seat in Jakarta. This is the place where all the national policies, laws and regulations are formulated. The capital of Bangka-Belitung is the city Pankal Pinang, this is where

the provincial government and the governor (gubernur) is seated. The province itself is divided into 7 regions, each with a local government office which is headed by a regent. The provincial government has the responsibility to look after regional interests in the national political landscape. The governor for example has been active in the investigation into nuclear power development on Bangka. The regions are active with the development of the region in terms of economics, mining, road development etc. These responsibilities have been handed down only recently, there is a clear need to improve communication between the regions and to improve local capabilities.

The world bank wrote a review about development policy in Indonesia. According to this report enhancing government effectiveness by adapting and strengthening institutions is the central challenge towards more progress (The World Bank, 2009). From this review it was possible to identify a number of constraints and opportunities that are relevant for the development of a tidal power plant.

Constraints imposed by the institutional environment (based on; (The World Bank, 2009)):

- Incomplete government transition from a centralized authoritarian regime to a decentralized democratic state
- Democratization and decentralization has fundamentally changed accountability structures and decision-making processes within government, and this is an ongoing process
- Government effectiveness has been limited by insufficient capacity and accountability of civil servants
- Difficulties in land acquisition because of weak legal framework and weak dispute resolution mechanisms, corruption and weaknesses in public procurement.
- Local governments do not have significant tax power, borrowing for infrastructure and other projects is underutilized
- Indonesia's investment climate still ranks poorly in international comparisons
- Judged from the volume of reform legislation, the accomplishments have been significant, however there is a widespread view that implementation has been less successful. This partly reflects the inherent inertia and resistance to change that is common in any bureaucracy but is also compounded by a lack of coordination within the government as well as uncertainty about legal and judicial intervention
- Uncertainty about government policy, unclear and poorly enforced regulations and excessively complex approval and licensing requirements will continue to be major obstacles to investment in coming years.
- The retail tariff levels remain (far) below costs for electricity, reform is proposed but changes are made slowly

Opportunities because of the institutional environment (based on; (The World Bank, 2009)):

- Since access to infrastructure is very limited compared to neighboring countries, the government has made infrastructure a major economic priority and has taken steps to introduce reforms
- Infrastructure Policy Package of 2006 aims to encourage competition, to eliminate discriminatory practices that obstruct the private sectors' participation in infrastructure provision and to redefine the governments' role, including separating policy-making, regulatory and operational responsibilities

- Central among the effort of infrastructure investment is to foster Public Private Participations (PPP) in infrastructure. A National Committee on Policy for Accelerating Infrastructure Provision (KKPPI) was established in 2005, which includes a PPP Unit as a center of technical expertise in project preparation (little progress has been made so far, there still has not been one successful tender for a project). But PPPs are still seen as key component of the solution to pressing infrastructure needs.

Clearly the institutions are undergoing major reforms that impact the decision making for large infrastructural projects. These institutional changes should improve the investment climate and transparency of the decision making process. This should increase confidence in the state and law and therefore make it easier to attract capital. The fact that these changes have to be made and uncertainties about the implementation creates a barrier for decision making and investment. Long term stability of government policies are important for making long term investments.

The rapid change in responsibilities for institutions means that many regional bodies are still catching up in terms of capacity, competencies and expertise. At the moment energy policy is considered part of the industrial development policy of Bangka-Belitung. Expertise within local government is limited. The districts have little experience in dealing with projects of such size and complexity as tidal power development. As a result energy policy and power development on Bangka-Belitung seems to be almost fully the work of PLN, the national power company.

5.1.2 Indonesian energy policy

The formation of Indonesian energy policy has also undergone changes in recent years. In the past, energy policy was the responsibility of the National Energy Co-ordination Board (BAKOREN) chaired by the Ministry of Energy and Mineral resources, participating member were a subset of 15 economic ministries with special relevance to the energy sector. This arrangement was largely seen as ineffective and was replaced by the National Energy Council in 2009, chaired by the president and the vice-president (International Energy Agency, 2008b; PriceWaterhouseCoopers, 2011). The policy review from the International Energy Agency lists the objectives of energy policy by 2025 (International Energy Agency, 2008b) (percentages in relation to national energy use):

- To reduce significantly the use of oil to below 20%;
- To increase the use of :
 - coal from 15.7% to more than 33%
 - liquefied coal to more than 2%
 - natural gas from 23% to more than 30%
 - geothermal from 1.9% to more than 5%
 - biofuel to more than 5%
 - other renewable energy from 0.5% to more than 5%;
- To reduce energy elasticity to below 1
- To improve energy infrastructure.

In order to attract foreign investors for electricity the government of Indonesia attempted to liberalize the electricity market. However the Electricity Law 20/2002 which aimed to introduce competition, vertical unbundling and private participation in the electricity sector was annulled by the Constitutional Court. On the basis that electricity pricing is considered of national importance and should be controlled by the government of Indonesia. The substitute 2009 Electricity Law maintains the dominant rule of PLN. A further explanation of the legal framework and the

significance of this law is provided in the next paragraph. After the Electricity Law 20/2002 was annulled, the national government introduced a number of separate measures to attract foreign capital.

- Creation of a Guarantee Fund (PT Penjaminan Infrastruktur Indonesia (PT PII)) which is able to provide financial guarantees for infrastructure projects and is well funded
- Creation of an Infrastructure Fund (PT Sarana Multi Infrastruktur (PT SMI)), a special fund set up to support infrastructure financing in Indonesia
- A greater role for the regional governments and other entities to participate in this business
- Simplification and clarification of the legislative framework and legislative procedures

The electricity sector is regulated by the Ministry of Energy and Mineral resources (MoEMR) and its sub-agencies. The ministry is responsible for the electricity master plan which sets out a 10 year estimate of power demand and supply, the investment and funding policy and the approach to the utilization of new and renewable energy resources. This plan is reviewed annually. PLN yearly develops the Electrification Development Program with a scope of 10 years. This development programme is prepared by PLN, approved by the Ministry of Energy and Mineral Resources, and mandated by the current law and regulations. The development plan indicates, among other things, which projects will be developed by PLN and IPP investors (PriceWaterhouseCoopers, 2011).

The Indonesian government invests heavily in infrastructure, among which electricity with a focus on fast, low cost development. These are major investments that PLN and national government have to process. Therefore the focus is on coal fired power plants for large scale development, geothermal power plants for large scale renewable development (Indonesia has excellent characteristics for geothermal power development) and hydro (run of river plants) for small scale remote sites. A large scale project for tidal power development will require engineers and regulatory oversight which have to be recruited from other projects, thus competing for already scarce resources.

PLN is dependent on subsidies as the regulated consumer price is not sufficient to cover the cost of production and distribution. The Indonesian government subsidizes many forms of energy use. Initially introduced to aid the poor and support the national oil industry, this is legacy legislation from the pre-democracy era. Especially the subsidies on transport fuels are heavily debated. Any changes are hard to accomplish as lowering subsidies is likely to cause social upheaval. However, these subsidies are unsustainable as they lean heavy on the government budget. The government of Indonesia continues to attempt to reform the subsidy scheme but this has been proven very difficult.

5.1.3 Laws and Regulations

This paragraph lists the most important laws and how they relate to this project. The laws and regulations offer constraints for the development of a power plant. PricewaterhouseCoopers published an Indonesian electricity investment and taxation guide in 2011. This report also presents a recent account of the legal and regulatory framework for the electricity market. The contents of that report are used as a source basis for this paragraph (PriceWaterhouseCoopers, 2011).

The electricity sector is regulated by the Ministry of Energy and Mineral Resources. The current regulatory framework is provided by Electricity Law No.20/2009. The 2009 law is a much needed replacement to the 1985 Electricity Law that provided for a centralized system with a state-owned electricity company, being PLN, holding exclusive powers over the transmission, distribution and sale of electricity. Private companies were however allowed to generate electricity. The government

attempted to liberalize the market by allowing private investors to produce and sell power directly to customers but the law that was supposed to enact these changes was annulled by the Constitutional Court in 2004. The court ruled that electricity is a strategic commodity and its generation and distribution should remain under the exclusive control of the government.

After the attempt to liberalize the electricity market failed, the need for reforms remained. The 2009 Electricity Law does not eliminate the main role of PLN in the electricity supply business. PLN is given priority rights to conduct this business throughout Indonesia. Without changing this principle the 2009 law tries to accommodate the development of (privately owned) small scale renewable energy, involvement of the regional governments and an increase in foreign investment. Foreign investment is needed to finance the projected fast growth of electricity production. However, under the old regulations it was very hard to attract foreign investment.

Key provisions of the 2009 Electricity Law:

Key provisions (based on (PriceWaterhouseCoopers, 2011))	
Electricity supply licensing	<ul style="list-style-type: none"> • PLN is merely the holder of an Electricity Generation License for Public Use (called IUPTL in government documents) • PLN has first right of refusal for unserved areas which if not accepted can be assumed by the private sector • If the private sector does not take up a business opportunity, the Central Government must instruct PLN to supply the area
Role of regional autonomy	<ul style="list-style-type: none"> • The regional authorities are to prepare a Regional Electricity Plan or RUKD, based on the National Electricity Plan or RUKN • The Regional Electricity Development Plan must comply with the Regional Electricity Plan • The regional authorities can provide licenses for power projects which are intra-regency and do not involve the sale of electricity to holders of a Central Government issues license • The Central Government provides licenses to PLN and to IPPs selling to PLN
Tariff	<ul style="list-style-type: none"> • The Central Government approves tariffs for Central Government issued license holders (e.g. PLN and IPP’s selling to PLN) • The regional authorities approve tariffs for IPP’s selling to non-PLN utilities • Tariff variations, according to different business areas, are permitted • The authorities must consider the interests of the relevant business as well as the public • Tariffs must be approved by the Indonesian/Regional House of Representatives
Cross-border sale and purchase	A new provision in Indonesian Law. Possible by the holder of an IUPTL from the Central Government. Purchase conditions include that there be a shortage of electricity supply. Sale conditions include that domestic electricity needs have been fulfilled
Direct sale of electricity to public	No link between electricity licensing and if the electricity facilities are connected to the National Transmission Network. The 2009 Law suggests that the holders of an IUPTL (which hold sale/integrated licences) can sell directly to the public, when the projects are not connected to the National Transmission Network or are not inter province projects.

5.2 Layer 2: Alignment of interests

Goals, objectives and constraints are not universal values. Depending on who is being asked, the goal could be to increase electricity supply, increase profits, minimize environmental impacts or protect local fishing industries. These are conflicting goals. A party that represents an interest into the project is called a stakeholder and has its own set of goals. Part of the challenge is to identify the most important goals of the most important actors and create a solution that is beneficial to the problem owner, in this case the local regency. To this end a stakeholder analysis was performed and presented in Attachment 2

The scope of the stakeholder analysis is limited to tidal power development in the Klabat bay, it does not include the analysis of other options of power production. Where possible the perceptions of the stakeholders are based on written statements such as year reports and websites. If this information was unavailable assumptions were made.

5.2.1 Objective of performing a stakeholder analysis

The term stakeholders was derived from 'stockholder' and is meant to represent groups that have an interest in decision making in an organization or for a project. Stakeholder theory was first developed to help organizations deal with the organization of activists, increased governmental influences, globalization, aggressive media and a loss in trust of the business world in general (R.E. Freeman 2001). A stakeholder analysis can be performed to define stakeholders, to classify stakeholders or a combination of the two. In this case the aim is to identify stakeholders that have an interest in tidal power development in the Klabat bay in order to classify their involvement. A good approach for such a project is described by Enserink et al. (2003). The approach names 6 steps for the identification and classification of stakeholders.

- Formulation of a problem
- Inventory of involved stakeholders
- Representation of formal tasks, competences and relations of stakeholders and laws and regulations
- Assessment of the interests, goals and problem perceptions of stakeholders
- Mapping dependencies between stakeholders by making an inventory of resources and subjective involvement of actors with the problem
- Assessment of the consequences of these findings for the formulation of the problem

The aim of the stakeholder analysis is threefold:

1. Establish whether the problem formulation of the problem owner is sustainable considering the perceptions of other stakeholders
2. To help design a strategy for the problem owner to deal with dependencies on other stakeholders in the political arena
3. Identification of relevant open questions about governance

5.2.2 Problem formulation of the local regency

The stakeholder analysis assumes the local regency as the problem owner, the entity who wishes to achieve something. The local Bangka regency, with the capital in Sungailiat (not to be confused with the island of Bangka), experiences electricity shortages as well as with high costs of power production.

Infrastructure investment and power development is of major importance to regional governance. Many inhabitants of the island have no access to electricity at all. Their lives would greatly improve with access to affordable electricity. In Indonesia electricity is subsidized by the government as it is considered a basic need. The regent of Sungailiat claims that a large share of his budget is going to the appropriation of these subsidies (Andrea Peresthu, 2011). Access to affordable electricity is thus important for improving the quality of life on Bangka. The regency identified the Klabat bay as a possible source of renewable energy development. The resources of the local regency are limited so other stakeholders' involvement is necessary to develop tidal power in the Klabat bay.

The regency has very limited taxing power and no experience in the development of power production units. In order to initiate a project it will need funding, expertise input and political support among other things. The next paragraph elaborates on the critical stakeholders and their perception towards this project. The stakeholder analysis attempts to answer the following question:

Who are, from the perspective of the Bangka regency, the relevant actors to involve in the development of a tidal power plant in the Klabat bay?

5.2.3 Conclusions from the stakeholder analysis

The stakeholder analysis consists of an inventory of the involved stakeholders, formal tasks of stakeholders, interests goals and problem perceptions of stakeholders and a mapping of the dependency on certain stakeholders. The extensive stakeholder analysis can be found in attachment 2. The outcome of the analysis can be summarized by grouping the involved stakeholders based on two categories;

- 1. Dedicated or non-dedicated stakeholders.
- 2. Opposite or aligned perceptions to the problem owner.

The outcome of the analysis is presented in Table 4.

	Dedicated stakeholders		Non-dedicated stakeholders	
	Critical	Non-critical	Critical	Non-critical
Aligned perceptions, interests and objectives	<ul style="list-style-type: none"> - MoEMR (Uncertain!) - Bangka-Belitung provincial governance - Bangka regency - PT Timah (Uncertain!) - PT PLN 	<ul style="list-style-type: none"> - Engineering firms - Science/Universities - Other inhabitants 	<ul style="list-style-type: none"> - PT. SMI - PT. PII 	<ul style="list-style-type: none"> - National energy council - President of Indonesia
Opposite perceptions, interests and objectives	<ul style="list-style-type: none"> - MoEMR (Uncertain!) - PT Timah (Uncertain!) 	<ul style="list-style-type: none"> - Bangka Klabat bay fishermen 	<ul style="list-style-type: none"> NGO's 	

Table 4 Conclusions of the stakeholder analysis

The local fishermen and inhabitants of the region have little resources except their representation in local government and access to local media. Therefore their position is currently judged as non-critical for decision making. This does not mean that they are irrelevant, it just means that they have little power to influence the decision making. In fact these stakeholders are directly affected by the impacts of a development, positive and negative. A position within this diagram is not fixed, during the decision making process, the local fishermen will have little resources. During construction phase they will have considerable blocking power. If not treated accordingly, the local fishermen have the power to sabotage construction and call for the help of Non Governmental Organizations (NGO's)

The positions of two critical actors, The Ministry of Energy, Minerals and Resources (MoEMR) and PT Timah, are unclear from the present analysis. Their positions are explained in the next paragraph.

The investment funds PT SMI and PT PII that have a strong financial and organizational backing from national government and institutional investors such as the IMF and World Bank are currently unaware of the project. These funds are identified here as 'almost' critical. They are not irreplaceable, there are other sources of funding, however their access to capital and manner of organization would make them a very strong asset towards construction of a tidal power plant.

5.2.4 Interests of critical stakeholder further explained

5.2.4.1 *The Ministry of Energy, Minerals and Resources (MoEMR)*

The Ministry of Energy, Minerals and Resources (MoEMR) is the ministry that regulates PT PLN, the national electricity company. In order for PLN to develop any production unit it needs the approval of the MoEMR at several stages of the permitting process. Furthermore the civil servants of the MoEMR have a large influence on the National Energy Council and thus the development of national energy policy. It's goal is to develop and implement sound energy policy. The MoEMR is the stakeholder that will have to judge the economic conditions acceptable before providing a license.

- As the feasibility study is currently insufficiently detailed the MoEMR is unable to form an opinion on the subject. Convincing the MoEMR of the necessity and feasibility of the project is vital as the MoEMR controls the permitting process

5.2.4.2 *Bangka-Belitung provincial governance*

A large scale tidal power development would require cooperation between regions both for coordination and financing. Developing a renewable form of energy will improve the image of the island group if correctly managed and promoted. Tourism is of growing importance to Bangka-Belitung's economy. This would have to be framed with other initiatives on waste management and depleted mining sites recovery. In the case of tidal impoundment this would be a prestigious project and attract large amounts of attention. It could be a poster project for renewable energy development in Indonesia. With the caveat that the possible negative impacts of closing the Klabat bay need to be managed properly. For local government this presents an opportunity to present its capabilities and ambition to the rest of Indonesia and the world.

The provincial government has access to the national political arena, especially in the form of the governor. It has a good understanding of the local environment and good connections to the major local industries, among which PT Timah. Judging from these resources and the irreplaceable nature of the stakeholder it is critical to bring the provincial government on board.

5.2.4.3 *PT. Timah*

Pt. Timah is a state owned enterprise and one of the largest tin miners in the world. About 35% of the company is now publicly owned which has made the company more independent and transparent in performance (Pt. Timah, 2010). Their mining and processing operations make the company the largest employer of the Bangka-Belitung province (Provinsi Kepulauan Bangka Belitung, 2011). They have an interest in a reliable and abundant power supply, both for its operations and for the wellbeing of the islands. Currently Pt. Timah produces most of its own power for their operations and their employees. To that end they have about 10MW diesel generated capacity. The electric power necessary for mining operations is relatively small. Investment in abundant, stable and clean power supply on Bangka would benefit Pt. Timah for four reasons. Firstly it would reduce the cost of operations and decrease the downtime of operations. Secondly the quality of life on Bangka would improve and so improve the legitimacy of Pt. Timahs operations. Thirdly it would improve the environmental impacts of its operations which is in line with its mission statement (Timah, 2012). Fourthly it would open up the possibility to grow its processing operations on the island. Currently much of the raw ore is sold without much processing, which would add to the value of the product significantly. However, producing electricity and/or developing power plants does not belong to its core operations and is of minor importance to its business operations on Bangka.

PT Timah has conflicting interests. PT Timah is one of the co-sponsors of this feasibility study which suggests an alignment with its objectives. However, during field research it was established that PT Timah has significant mining operations on the inner Klabat bay. The size, importance and depletion of this site will decide the position of PT Timah. They are currently using a large vessel that dates back to the colonial era, this vessel will not be able to enter or exit the inner Klabat bay in case a dam was constructed. There was another vessel stationed in the lake which was not in use anymore, this would also have to move, otherwise it would have to be disassembled in this location. In case of a tidal stream development the issue would be minor.



Left: Picture of a tin mining vessel in the inner Klabat bay, this one is out of operation; Right: Picture of the other tin mining vessel still in operation on the inner Klabat bay. Both vessels date back to the colonial era

5.2.4.4 *PT. PLN*

Pt. PLN is the national electricity company. They own and operate 90% of the national production capacity and all of the transmission and distribution networks. PLN has experience with small scale hydro power in the form of run of river plants. Though not the same they have some similarities in terms of maintenance and installation. The major difference between run of river plants and tidal power is in the intermittency and reversing flows of the water.

PLN is regulated by the national government. The tariffs paid for renewable power below a capacity of 10MW are decided by the government. Above 10MW there is an elaborate process drawn up that a developer has to comply with. PLN is allowed to make a predefined return on investments in renewable developments.

As Bangka-Belitung used to be a part of the province of Sumatra, the grid is administratively part of the Sumatra grid. PLN is tightly regulated. For any project above 10MW it needs to follow a set of procedures that involves evaluating the risks and necessity of a development and getting government approval. PLN is obligated to organize online public tenders.

PLN has the 'first right of refusal' for the development of any site. This means that once an opportunity for power production is identified, PLN can claim its development. Only when PLN refuses, are private investors allowed to develop a site. As PLN is responsible for the development of sufficient generation capacity on Bangka, any addition to the current capacity is good. PLN also builds other generation units; the development of large scale tidal power would have a big impact on these plans.

5.2.4.5 PT. SMI and PT. PII

PT Sarana Multi Infrastruktur (PT SMI) and PT Penjaminan Infrastruktur Indonesia (PT PII) are two investment funds with the primary objective to invest in Indonesian infrastructure. PT SMI is fully funded by the government of Indonesia, its objective is to be a catalyst in the acceleration of infrastructure development in Indonesia. A partial aim is to promote Public Private Partnerships.

PT PII is a well funded guarantee fund started in 2010 which is able to provide financial guarantees for infrastructure projects. The SMI fund participates in this fund as well. It is privately owned with the initial shareholders being established institutional investors such as the Asian Development Bank (ADB), International Finance Corporation (IFC), Deutsche Investitions und Entwicklungsgesellschaft mbH (DEG) and open to investments from other private investors. The objective of the PII is to increase the availability of funding for infrastructure projects with long term use. PT IIF will provide funding towards commercially feasible infrastructure projects through debt instruments, equity participation or infrastructure financing guarantee for credit enhancement.

Both funds require commercial feasibility for investment. They are judged to be non-dedicated, critical actors. At this moment they are unaware of the opportunity. In order to involve them in the project they need to be convinced of the commercial feasibility. They are judged critical as it would be very difficult to find funding without these funds.

5.2.4.6 Non-Governmental Organizations (NGO's)

The impact of Non-Governmental Organizations (NGO's) on the development process is unclear at the moment. NGO's could halt/slow down the development using their access to the media and starting legal procedures. Whether large influential NGO's are interested in this project depends on the development over time. An early outlook for their interests could dampen their willingness to block the development. For an environmental NGO the position is ambivalent, the construction of a dam could have considerable negative environmental impacts, but blocking the development of a large amount of renewable energy would also have a negative environmental impact.



Pictures of the fishermen boats at the inner Klabat bay

5.3 Layer 2: Institutional Arrangements

Agents in networks use mechanisms to coordinate transactions between them. These institutional arrangements, or 'governance structures', are designed to coordinate specific transactions among multiple actors concerning labor, capital, intermediate goods, information and the like (Koppenjan & Groenewegen, 2005). PLN has a number of mechanisms available for buying electricity from producers or to invest in its own production facilities. The government of Indonesia uses incentive mechanisms to regulate PLN. This paragraph explains the procedures involved for power investment in Indonesia, the available contracting options between PLN and producers and risk management of power production investments. In other words, if a tidal power plant in the Klabat bay is built, who could own and operate the system, how could the returns be arranged and who would be carrying what risks? There are three important sources for this paragraph 1. Discussion with Dr. Abang Gindarsyah about the development procedure, 2. Tables provided by PLN during a meeting 3. The Indonesian electricity guide as prepared by PriceWaterhouseCoopers (2011) (with chapter 3 being particularly useful). The documents provided by PLN and mr Gindarsyah are not available in English.

5.3.1 Ownership of power generation capacity in Indonesia

The Indonesian power system originated as a centrally planned system. The power system and all its components were government owned and operated. This is the origin of former state company PT. PLN who is handed the responsibility to manage the electricity networks. PLN still owns the majority (90%) of production capacity. When a potential project is identified PLN has the first right to decide whether they want to develop the project. PLN has a number of options for contracting and financing. In case PLN chooses not to develop an identified potential it is allowed for private investors to develop a project.

5.3.1.1 *History of private investment in power production*

Electricity investment has generally not been done on a stand-alone basis. Instead Independent Power Producer (IPP) investment has involved offtake arrangements in the form of Power Purchase Agreements (PPAs). Most IPPs, particularly in recent times, have also operated to a more general set of Public Private Partnership (PPP) arrangements. A PPP scheme is a collaboration between the private and public sectors which utilizes the efficiencies from the private sector to reap better value for the public. The primary tool do to this is by allocating 'risk to the party with the best risk controlling capacity' (PriceWaterhouseCoopers, 2011)

The key regulation governing Indonesian PPPs is Perpres No.67/2005 as amended by Perpres No.13/2010. Most IPPs have also involved a Build-Own-Operate (BOO) or Build-Operate-Transfer (BOT) arrangement.

Private participation in Indonesia's electricity sector probably started in 1992 (PriceWaterhouseCoopers, 2011). High forecast returns in combination with government guarantees meant a high investor uptake initially. However when the Asian financial crisis struck in 1997, PLN became financially troubled as a result of the fall in the value of the rupiah. Six projects were terminated, six were acquired by the government, one project ended up in a protected legal dispute, and 14 projects continued under renegotiated terms. Most IPP investors were forced to agree on lower tariffs than initially anticipated. These experiences have made investors hesitant to invest in new power capacity to this day.

Up to 2008 IPP arrangements were not viewed as attractive as there were no government guarantees provided, forecast returns were lower compared to the previous decade (between 12 and 14%) and risk allocation was not seen as favorable. Since 2010 Perpres No.13/2010 introduced the following:

- a) Revised bidding arrangements including extensive bidder/tender consultations
- b) Better-defined risk allocations to help with the bankability of projects
- c) Government support and guarantees (such as in relation to land acquisition)
- d) Financial facilities (PT SMI and PT PII)

These measures have greatly improved investment conditions for independent power producers.

5.3.1.1 Power development by PLN

PLN can follow two distinct paths in the appointment of an independent power producer. The normal process is governed by a bidding process. Only in exceptional cases PLN is able to divert from this path and appoint an independent power producer directly. Renewable energy projects fulfill the requirements for the possibility of direct appointment.

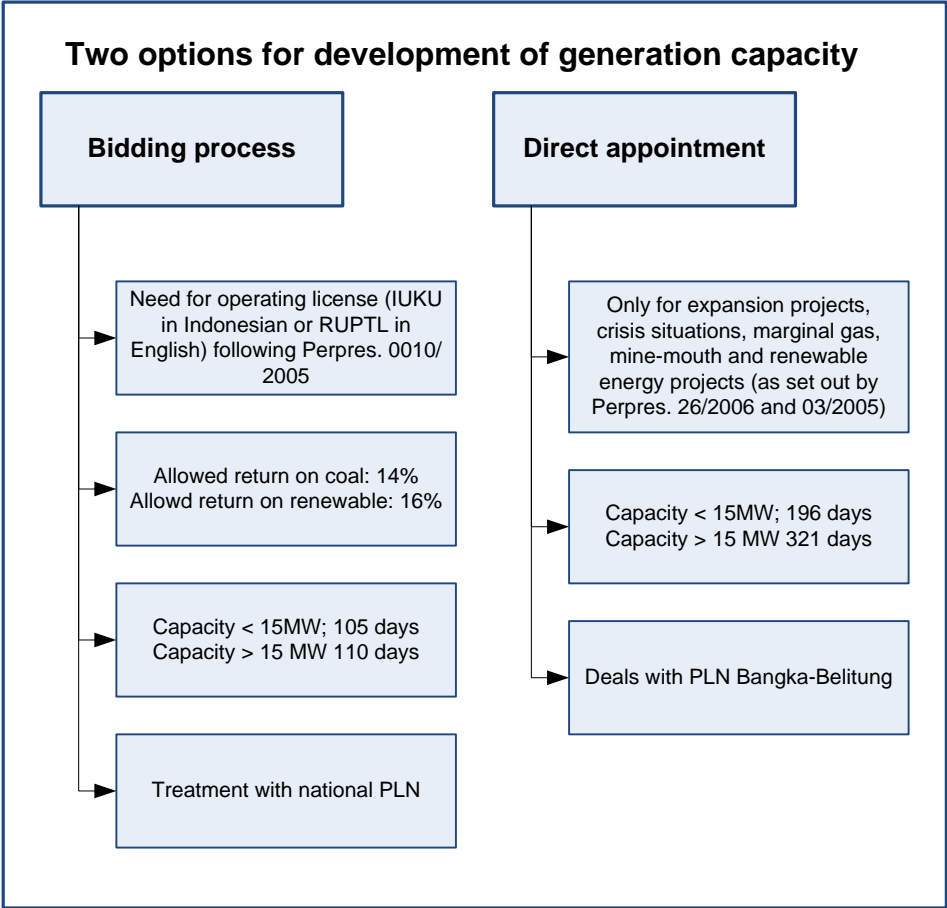

The bidding process can be summarized by the following steps:

1. Tenders be offered based on operating license (RUPTL)
2. The evaluation and pre-qualification phase be based on financial and technical capabilities
3. Requests for proposals include a power purchase agreement and include performance bond callable on failure to close financing

4. The selection process identify the 3 best bids based upon technical parameters, electricity price proposal, development/construction module
5. The preferred bidder be selected based on electricity price

After the preferred bidder is selected the process from award of tender to operation will involve:

1. The issue of a letter of intent
2. The negotiation of an electricity tariff and other terms
3. The establishment of a special purpose company with a temporary business licence applied for from the DJLPE (general director)
4. The MoEMR approval of the tariff
5. The negotiation and signing of a PPA
6. The application for the business licence from DJLPE submitted with a feasibility study, AMDAL and PPA contract
7. The issue of a licence for conducting electricity business for public use (IUPTL)
8. Completion of financing
9. Awarding of EPC contracts
10. Commencement of commercial operations

In case of direct appointment the following steps are followed:

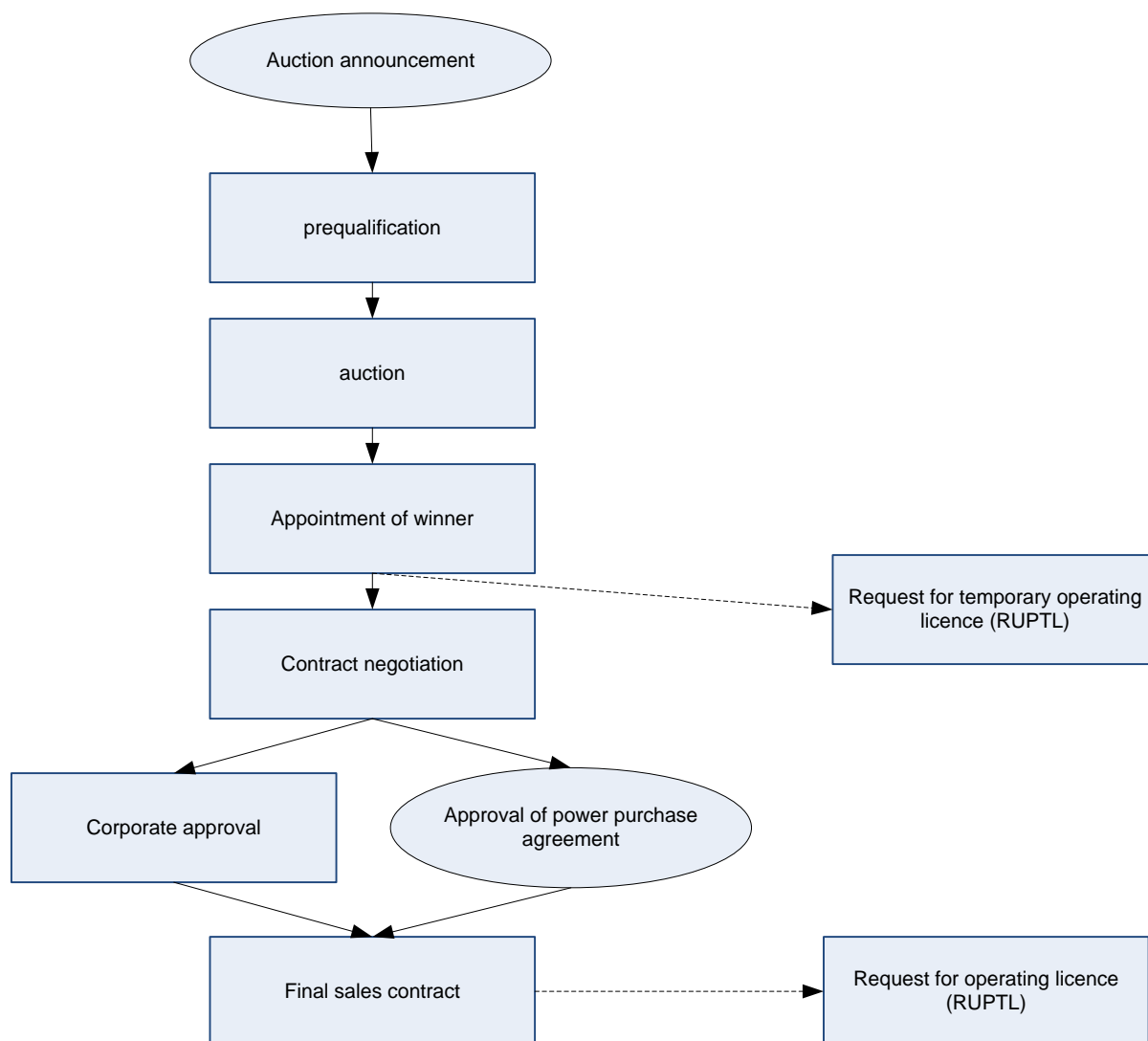

Figure 34 Direct appointment procedure as translated from: (Mekanisme Pelelangan Listrik Swasta)

5.3.2 Arrangements

Key arrangements can be summarized into the key contracts necessary for project development and the details of power purchase agreements. The Indonesian government fixed the tariff arrangements for small scale renewable developments.

5.3.2.1 Key project contracts

The key project contracts are listed in Table 5:

Key Project Contracts	Contracting Parties	Purpose of Contract
Shareholder ("SH") Agreement	Shareholders in the project's special purpose vehicle ("SPV")	Provides for the rights and obligations of shareholders
SH Loan	Shareholders in the project SPV	Allows for terms & conditions for SH loans

Power Purchase Agreement (“PPA”)	SPV and PLN	Key project document setting terms and conditions of power generation activity
Engineering Procurement & Construction (“EPC”) Agreement – Offshore	SPV and third party contractor and/or affiliates	Offshore EPC arrangements typically involve entirely offshore design and construction work
EPC Agreement – Onshore	SPV and third party contractor and/or affiliates	Onshore EPC construction, typically involving local construction firm
EPC Wrap Agreement (may also be referred to as Umbrella or Guarantee & Coordination Agreement)	SPV and contractors	Provides for the guaranteed performance of offshore and onshore contractor jointly
Long Term Fuel Supply Agreement	SPV and third party (generally)	Governs the underlying availability of long term fuel supply
Operations & Maintenance (“O&M”) Agreement	SPV & O&M contractor	Governs O&M fees & overheads charged to the project company
Technical Services Agreement	SPV & Affiliates/third parties	Provides the basis on which an affiliate or third party provides technical services to SPV
Project Finance Documents	Financiers & SPV	The PF documents may include contracts pertaining to: <ul style="list-style-type: none"> - Corporate Lending - Export Credit Agencies - Cash Waterfall Arrangements - Hedging Agreements - Political Risk Guarantees Intercreditor Agreements - Security Documents - Sponsor Agreements
Developers/Sponsors Agreement	Sponsor & SPV	Provides for a developers fee to be paid by SPV to the original sponsors

Table 5 Key project contracts (PriceWaterhouseCoopers, 2011)

5.3.2.2 *Power purchasing agreements*

PLN has a number of options to buy electricity, depending on the type and location of the production capacity. Small scale renewable developments are now regulated and benefit from a feed-in tariff. Large scale renewable developments and conventional power developments have to follow set of procedures.

The terms of the PPA should at least include the following terms and conditions according to Perpres No.13/2012 (PriceWaterhouseCoopers, 2011) :

- a) the scope of the contractual work or service;
- b) the period of operation (e.g. most PPAs are for 15 – 30 years);
- c) the implementation guarantees (i.e. essentially the relevant IPP and PLN responsibilities);
- d) start up and commissioning issues;
- e) operations and maintenance arrangements;
- f) sales and purchasing arrangements (with regulated price “ceilings” according to different types of fuel);
- g) billing and payment arrangements;
- h) rights and obligations on risk allocation;
- i) service performance standards;
- j) insurance arrangements;
- k) force majeure scenarios;
- l) dispute resolution arrangements; m) sanctions; and n) any purchase options (i.e. for PLN).
- m) sanctions
- n) any purchase options (i.e. for PLN).

5.3.2.3 *Small scale renewable development*

Indonesia has set a feed-in tariff for small scale renewable (up to 10MW) and excess power production from state facilities. This is written in perpres 31/2009.

These are two important provisions:

1. A separation between connection to medium voltage or low voltage grid
 - a. RP 656/kWh x F, for connections to the medium voltage grid
 - b. Rp 1004/kWh x F, for connections to the low voltage grid
2. Then there is a multiplication factor for the different regions in Indonesia (F)
 - a. Java and Bali, F=1
 - b. Sumatra and Sulawesi F=1.2
 - c. Kalimantan, Nusa Tenggara Barat and Nusa Tenggara Timur, F=1.3
 - d. Maluku and Papua, F=1.5

As Bangka is part of the Sumatra grid, the feed-in tariff for small scale renewable energy would be 787 IDR (0.0835 USD) for medium voltage grid connection or 1204 IDR (0.1065 USD) for a low voltage grid connection

5.3.3 Risk management

When a company makes a contract to deliver a certain service, it assumes that it is able to deliver said service for less than the negotiated price. A contract is a written declaration in which risks and benefits are divided between agents. One of the problems with large infrastructural projects are the inherent project risks. Delays, cost overruns, currency risks, and/or project failure make investors weary for such a large up-front investment. The investments funds PT SMI and PT PII are the key government tools to manage these risks.

5.3.3.1 *Role of investment funds*

PT PII essentially functions as an insurer of any risk exposed to the private sector for premium, but at a lower rate than those charged by traditional insurance firms. The mechanism works as shown in

Figure 35. The IIGF is the investment fund. The investor is the private investor investing in the generation capacity and in normal cases the contracting agency is PLN. So the investor makes a PPA agreement with PLN in which it settles on a price for the electricity produced, and the investor makes a guarantee agreement with the investment fund.

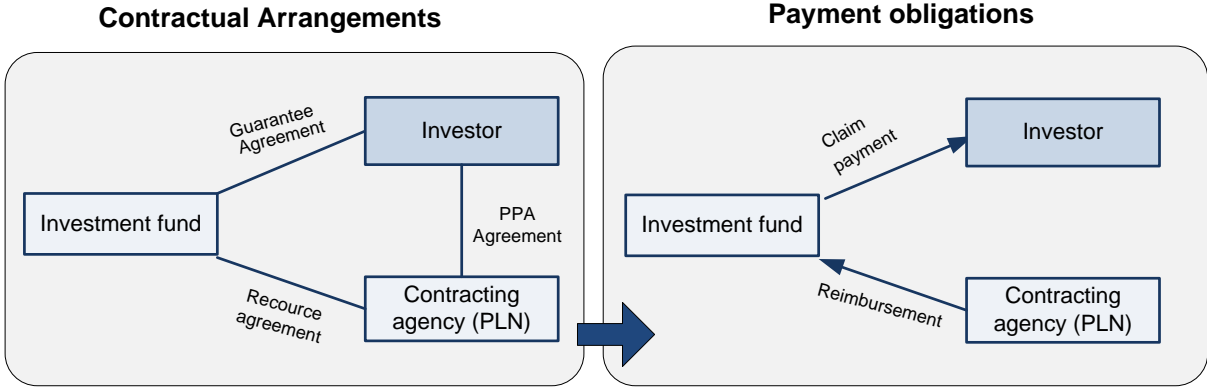

Figure 35 Investment fund arrangements (PriceWaterhouseCoopers, 2011) (as presented at the Infrastructure Asia Conference, 15 April 2010)

Before any government guarantee can be given a risk assessment unit will perform a risk management assessment based on:

1. Political risk
2. Project performance risk
3. Demand risk

The risk allocation arrangements now and in the past can be summarized in de following table:

Risk	Risk sharing mechanism	
	Before 2008	2009 onwards
Fuel supply	IPP bears the risk of availability of fuel	
Fuel cost	PLN Bears risk on the fuel cost	PLN shares the risk with the government
Site selection	IPP and PLN share the risk	
Capacity and energy price risk	PLN bears the capacity and energy risk	PLN shares this risk with the government
Construction risk	IPP bears the construction risk	
Operational risk	IPP bears the operational risk	
Foreign exchange risk	PLN bears the foreign exchange risk	PLN shares this risk with the government
Country/ regulatory risk	IPP bears the country/regulatory risk	PLN shares this risk with the government

Table 6 Risk allocation arrangements before and after 2009, based on; (PriceWaterhouseCoopers, 2011)

5.4 Conclusions about the institutional environment

The analysis of the institutional environment results in institutional design variables and institutional constraints. These are summarized in the following two paragraphs.

5.4.1 Design variables enabled by the institutional environment

- Ownership arrangements
- Process arrangements with PLN
- Power Purchase Agreement design
- Risk management
- Aligning the interests of critical stakeholders
- Other contractual arrangements
- Influence the development process/ licensing process
- Mitigate negative social impacts

5.4.2 Constraints imposed by the institutional environment

- The laws and regulations as presented in paragraph 5.1 constrain the decision making of the problem owner
- PT PLN has a set of procedures available for processing IPPs, depending on the criteria of the project, a certain procedure will have to be followed
- The problem owner, Bangka regency, will have to involve and convince a large number of stakeholders. Critical stakeholders who's problem definitions are aligned: Bangka-Belitung province and the institutional investment funds SMI and PII. Stakeholders which are critical but who's positions are ambivalent include PT Timah and the MoEMR (with the constraint of a positive cost-benefit analysis). The plans will have to include some mechanism to offset the negative consequences for the Klabat bay fishermen, and plans to mitigate negative

environmental impacts which could create non-aligned dedicated stakeholders in the form of NGO's

- In the case of small scale tidal stream development the Power Purchase Agreement is regulated. The feed-in tariff for small scale renewable energy would be 787 IDR (0.0835 USD) for medium voltage grid connection or 1204 IDR (0.1065 USD) for a low voltage grid connection at Bangka.
- Incomplete government transition from a centralized authoritarian regime to a decentralized democratic state. Democratization and decentralization has fundamentally changed accountability structures and decision-making processes within government, and this is an ongoing process
- Government effectiveness has been limited by insufficient capacity and accountability of civil servants
- Difficulties in land acquisition because of a weak legal framework and weak dispute resolution mechanisms, corruption and weaknesses in public procurement.
- Local governments do not have significant tax power, borrowing for infrastructure and other projects is underutilized
- Indonesia's investment climate still ranks poorly in international comparisons
- Uncertainty about government policy, unclear and poorly enforced regulations and excessively complex approval and licensing requirements will continue to be major obstacles to investment in coming years.

6. Basis of Design

This chapter serves to bring synthesis to all the previous chapters. It offers a structured summary of the design variables, goals and performance indicators. The introduction presented the case at hand, chapters 2 and 3 presented the technological design options in tidal energy engineering, chapter 4 offered an analysis of the site and its energetic potential and chapter 5 offered an analysis of the institutional environment. Each of these chapters contribute to the establishment of design objectives, constraints and performance indicators which are the building blocks for the conceptual design of a tidal power plant. With reference to the design model from the methodology description, we are now able to make a list of requirements and define the solution space. These consist of performance indicators, objectives, constraints and design variables.

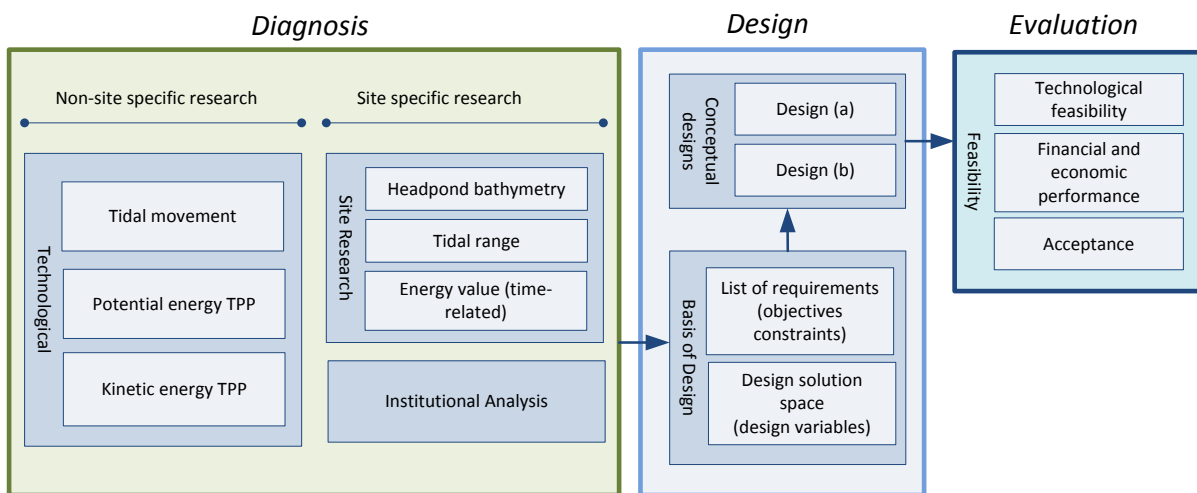

Figure 36 Research framework. This chapter serves to conclude the Diagnosis phase and construct the Basis of Design

6.1 list of requirements

This paragraph aims to define the design objective; What are we trying to achieve? This paragraph lists the goals as they follow from the analyses of previous chapters.

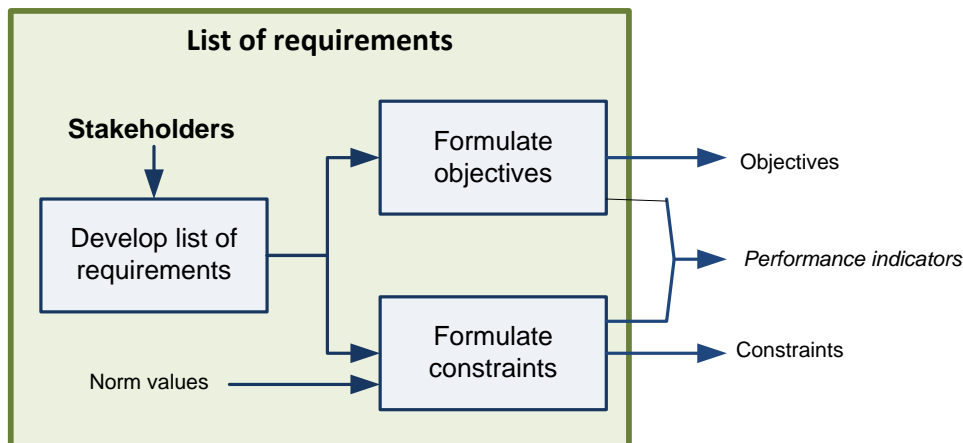

Figure 37 Partial frame of the Herder and Stikkelman model for design. The output of the list of requirements.

6.1.1 Design objectives

The introduction explains the existence of an energy crisis on Bangka. Many residences are not even connected to the grid and those who are, have to deal with frequent black-outs. Furthermore the basis for electricity production is diesel based which is very expensive and very polluting. Most of the

cost are for the government as the tariff is regulated and insufficient to meet the cost of production, let alone transmission and distribution. There are coal fired power plants being developed to alleviate the worst problems of energy production but these are unable to meet the ever growing demand. The design objectives are therefore:

1. Maximize energy output
2. Minimize cost of energy production (IDR/kWh)
3. Minimize negative environmental impacts
4. Minimize negative social impacts
5. Maximize positive social impacts

6.1.2 Performance indicators

Already in 1981 the Severn Barrage committee investigated the major factors influencing the tidal barrage project in the Severn estuary (UK). The outcomes of this analysis prove useful for the Klabat bay.

External Factors	Internal Factors	Results affected	Conclusions regarding
Future prices of fuel	Turbines: type, size, number, and cost		
Development of electrical utility systems	Sluices: type, size, number, and cost		
Tidal range	Generator capacity and cost		
Wave climate	Turbine submergence and cavitation criteria	Energy output	Technical feasibility
Bathymetry	Method of operating turbines		
Availability of suitable dredging plant	Turbine caisson foundation elevations		
Distribution of existing erodible sediments	Turbine draft tube geometry		
Supply of fresh sediments from outside of estuary	Barrage length and alignment		
Availability and costs of construction materials	Effect of barrage on tidal range	Construction costs	Economic and financial performance
Availability and cost of capital	Design criteria for structures, including risks		
Availability, productivity, and cost of labour	Rate of turbine production		
Present and future water commerce	Construction sequence and closure velocities		
	Direction and strength of current velocities from turbines and sluices	Environmental and social aspects	Acceptability
Differential inflation (e.g. between energy prices and construction costs)	Caisson construction yards- location and cost		
	Design of embankments		
	Design of transmission		

links
Navigation locks – location, size and cost
Effects of barrage on ship movements

Table 7 Major factors influencing project economics. As adapted from Severn Barrage committee 1981 by (Langston, Jonas, & Millward, 2010). These are the outcomes of the feasibility study about tidal development in the Severn estuary by the Severn Barrage committee in 1981. External factors are the factors the developer is unable to influence, Internal factors are the design parameters that the developer is able to control. The combination of internal factors (design variables), given the external factors (constraints) define the results affected and thus conclusions regarding the feasibility (performance indicators)

The table illustrates clearly the theory of the conceptual design model. There are a number of *external factors* that form *constraints* for the designer. Then there are a number of *internal factors* that can be designed, the so called *design variables*. Together the design variables and constraints span up the *solution space* in which the final solution has to be found. Furthermore each design should be accompanied by a number of *performance indicators* in order to draw conclusions regarding the *design*.

The conclusions from the Severn Barrage committee do not directly translate to the Klabat bay. In the Severn barrage only tidal impoundment was considered and the project is of a much larger scale. However, performance indicators are similar. The technical feasibility, economic and financial performance and acceptability will decide the feasibility of a tidal development project in the Klabat bay. All three performance indicators need to score sufficiently in order to assess the project as feasible.

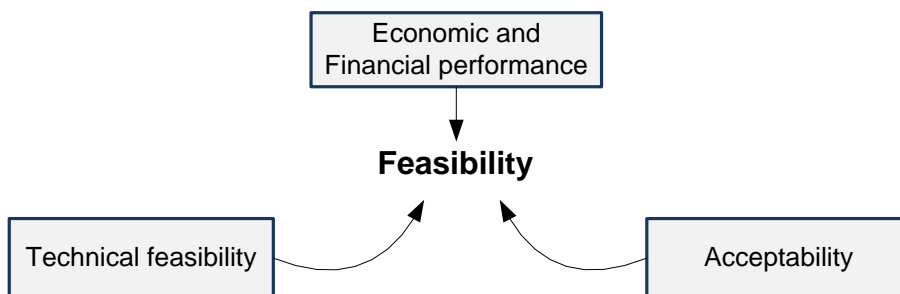

Figure 38 Performance indicators based on the tidal barrage feasibility studies of the Severn Estuary in the UK

6.1.3 Design constraints

The constraints that follow from the investigation of the barrage technology, stream technology, bathymetry, energetic potential and institutional environment are summarized here.

6.1.3.1 Constraints tidal barrage technology

Every design comes with its own set of constraints. Technologically every design option is possible, but the resulting construction cost are often prohibitive. Cost is not a technological design constraint but it is heavily influenced by the technological design. Therefore the influence of the most important design options on the cost have been included here. A similar argument can be made for expected revenues, different designs have different pay-offs which could justify increased investment cost.

- Intermittency – Depending on the operating scheme there will be more or less of an issue with the intermittency of the production of electricity from the tides. The tides themselves are periodic and intermittent, a clear constraint of the system.
- Cost – The choice for an operating scheme has a large influence on the size of the initial investment cost. One way generation vs two way generation influences how many turbines and sluices are needed.
- Cost – The choice for a single basin or a double basin design has a large influence on the initial investment cost. A double basin implies the need for an extra barrage, only in rare natural circumstances this would not be necessary.
- Cost – The number, size and type of turbines have a large influence on the cost of tidal barrage power plant design
- Revenues – The value of electricity production capacity is time dependent. Investments that add to the initial investment costs but increase production flexibility could have a positive cost benefit ratio.
- Impacts – Building a barrage has an impact on the environment in which it is placed. These are not to be underestimated. The impacts are environmental (fish population, dilution of the water, tidal marine environment), social (sailing, fishing, employment) and economic

6.1.3.2 Constraints tidal stream technology

The most important constraint is that the market is very immature, there are no commercial plants in operation.

- Immature technology
- No commercial plants in operation
- Energy production is very dependent on high stream speeds. The potential increases exponentially with an increase in stream speeds
- Operation in a (salt-water) marine environment causes engineering and maintenance challenges that have a negative impact on the cost of construction and operation
- Electricity transmission and distribution lines need to be included in the plan which slows down the development process and adds to the cost

6.1.3.3 Bathymetry constraints

- The surface area of the inner Klabat bay is 140km², or 140.000.000m²
- The length of the narrow entrance at Cape Ruh is 1500m
- The water depths in the inner Klabat bay vary between 1-13 meters, although most prevalent are depths below 10 meters
- The water depths at the narrow entrance vary between 20-25 meters

6.1.3.4 Energetic constraints

- There is a regular Diurnal tide in the Klabat bay. As a result there is only one high and one low water every day.
- The average tidal range during a year is 1.77m
- tidal ranges from as little as 0.6m to as much as 3m in the month of January 2010. The variations in water level amplitudes follow 14 day cycles
- The natural energy, or theoretical potential, of the inner Klabat bay is 280GWh annually

- Using formula's derived from previous experience the practical energy potential of the inner Klabat bay with tidal barrage technology ranges between 100-165 GWh yearly, depending on the design
- The usable head is relatively small. Turbines need a minimum head to start working. To minimize this effect there will be a need for relatively small turbines in relatively large numbers
- Stream speeds can be locally high, a further investigation is necessary to investigate local stream potential
- The average stream speed is estimated to be 0.18m/s
- Sites that are deemed interesting for development of tidal stream projects generally have stream speeds of 1m/s and more

6.1.3.5 Constraints imposed by the institutional environment

- Incomplete government transition from a centralized authoritarian regime to a decentralized democratic state
- Democratization and decentralization has fundamentally changed accountability structures and decision-making processes within government, and this is an ongoing process
- Government effectiveness has been limited by insufficient capacity and accountability of civil servants
- Difficulties in land acquisition because of weak legal framework and weak dispute resolution mechanisms, corruption and weaknesses in public procurement.
- Local governments do not have significant tax power, borrowing for infrastructure and other projects is underutilized
- Indonesia's investment climate still ranks poorly in international comparisons
- Judged from the volume of reform legislation, the accomplishments have been significant, however there is a widespread view that implementation has been less successful. This partly reflects the inherent inertia and resistance to change that is common in any bureaucracy but is also compounded by a lack of coordination within the government as well as uncertainty about legal and judicial intervention
- Uncertainty about government policy, unclear and poorly enforced regulations and excessively complex approval and licensing requirements will continue to be major obstacles to investment in coming years.
- The laws and regulations as presented in paragraph 5.1 constrain the decision making of the problem owner
- PT PLN has a set of procedures available for processing IPPs, depending on the criteria of the project, a certain procedure will have to be followed
- The problem owner, Bangka regency, will have to involve and convince a large number of stakeholders. Critical stakeholders whose problem definitions are aligned: Bangka-Belitung province and the institutional investment funds SMI and PII. Stakeholders which are critical but whose positions are ambivalent include PT Timah and the MoEMR (with the constraint of a positive cost-benefit analysis). The plans will have to include some mechanism to offset the negative consequences for the Klabat bay fishermen, and plans to mitigate negative environmental impacts which could create non-aligned dedicated stakeholders in the form of NGO's

- In the case of small scale tidal stream development the Power Purchase Agreement is regulated. The feed-in tariff for small scale renewable energy would be 787 IDR (0.0835 USD)/kWh for medium voltage grid connection or 1204 IDR (0.1065 USD)/kWh for a low voltage grid connection at Bangka.

6.2 Design solution space

Following the technological analysis there are two very distinctive technologies available for harvesting tidal streams. As these are so different, the ‘solution space’ exists around these two options. The possible solutions are limited by the constraints as presented in the previous paragraph. The design objectives help define ‘the instance within the solution space which best meets the objectives’.

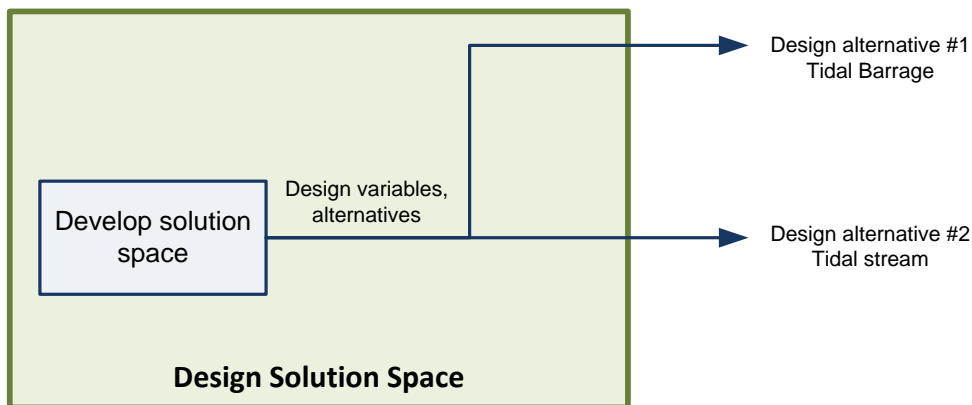

Figure 39 Partial frame of the Herder and Stikkelman model for design. The output of the solution space

6.2.1 Design alternative #1: Tidal barrage technology

The design variables available for tidal barrage technology were investigated in the previous chapters. The conclusions from these chapter are once more repeated here.

6.2.1.1 Technological design variables

The technological design variables that have the largest influence on the performance indicators (economics, technical feasibility, acceptability) were presented previously in paragraph 2.6.1.1

- Operating schemes – Ebb generation versus Flood generation
- Operating schemes – One way generation versus two way generation
- Operating schemes – Single basin versus double-basin
- Optimization – Number, size and type of turbines
- Optimization – Necessity, number and size of sluices
- Construction in the wet (caisson construction) or in the dry

Other technological design parameters that will have to be decided upon in a more detailed design:

- Turbine submergence and cavitation criteria
- Turbine caisson foundation elevations
- Effect of barrage on tidal range
- Design criteria for structures, including risks (e.g. chance of flooding 1 in 10.000 years, chance of earthquake damaging the structure below 1 in 10.000 years)

- Construction sequence and closure velocities
- Direction and strength of current velocities from turbines and sluices

6.2.1.2 *Institutional design variables*

The construction of a tidal barrage power plant means the construction of a power plant with a minimum of 30MW capacity. Other characteristics include large investment costs, closure of the inner Klabat bay and changing the tides of the inner Klabat bay. These characteristics mean that the following design variables are within the solution space:

- Ownership arrangements - (100% PLN, Public Private Partnership, Independent Power Producer)
- Process arrangement with PLN - As tidal barrage technology is classified as a renewable energy the project would be viable for the direct appointment procedure (paragraph 5.3.1.1)
- Power Purchase Agreement (PPA) – The design of PPAs is normally based on a price/kWh basis in combination with a period of time. As tidal power is an intermittent source and thus requires a back-up, a deviating PPA arrangement is required
- Risk management – The ownership construction can be considered part of the risk management strategy. Furthermore the political, project performance and demand risks need to be dealt with
- Lobbying – Align the interests of the critical stakeholders with the design objective

6.2.2 Design alternative #2: Tidal stream technology

The design variables available for tidal stream technology were investigated in the previous chapters. The conclusions from these chapter are once more repeated here.

6.2.2.1 *Technological design variables*

- Configuration – There are three main concepts to turn kinetic energy from the streams into mechanical energy. Horizontal axis, vertical axis and making use of hydrofoils. There is no option which has a clear advantage to the others.
- Placement – The manner in which the unit(s) are fixed in place has a large influence on the cost, access for maintenance and options for redesign. Placement is partly decided upon by the physical environment. In deep waters it is difficult to engineer fixed placement. The options range from fixed placement using a gravity structure, using a single pole like off shore windmills to floating structures that are moored to with anchors.
- Ducting – Ducting may improve the efficiency of the turbine, but at this moment it is unclear if the increased efficiency is offset by the increase in investment cost.
- Developer – At this point of development the choice of the technology developer has a major impact on the technological design of the units

6.2.2.2 *Institutional design variables*

- Contracting – In the UK a tender for concessions decided on who will develop what and where. The tendering process design will have a large influence on the technological design.

- Ownership arrangements – (100% PLN, Public Private Partnership, Independent Power Producer)
- Process arrangements with PLN – As tidal stream technology is classified as a renewable energy the project would be viable for the direct appointment procedure (paragraph 5.3.1.1)
- Power Purchase Agreement (PPA) – Depending on the size of the installation the PPA might be regulated. Below 10MW capacity the feed-in tariff is fixed
- Risk management – As tidal stream technology is small scale and has little impact on the environment the associated risks are more concerned about project failure, cost overruns, political risk etc.
- Lobbying – An important factor for the development of tidal stream is to bring the actors together that can provide the technology, funding and licensing

6.3 From a Basis of Design to Conceptual designs

The conclusions about the basis of design are used as an input for the conceptual designs in the next chapters.

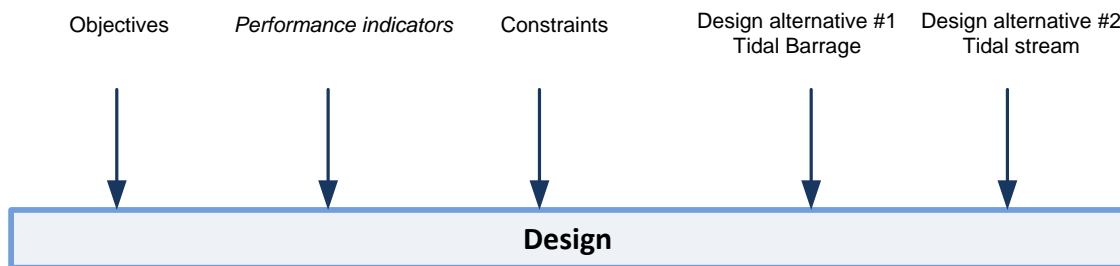

7. Conceptual Designs of Tidal Power Plants

The basis of design is the input for the conceptual designs. The objective of making this design is to assess the feasibility of tidal barrage development in the Klabat bay. As this is a pre-feasibility study, it is not about the detail of the design. After this design exercise it will be possible to identify showstoppers, have an indication about costs and benefits, have a general understanding of the impacts on the landscape and identify the knowledge gaps that are important for decision making. Design is an iterative process, in this conceptual design there is only room for one iteration. With the assistance of the expertise of Royal Haskoning it is possible to make some assumptions based on experience. The in-house expertise of Royal Haskoning concerning tidal barrages has helped to bring this report, from an engineering perspective, to a higher level. As the available information at this point is limited some of the choices had to be made based on rough assumptions and experience.

7.1 Conceptual design tidal barrage power plant

Using the outcomes of the previous analyses of the constraints and design variables, a conceptual tidal barrage design is proposed. Many design decisions were made based on expert advice from Royal Haskoning.

7.1.1 Barrage configuration

Paragraph 2.2 introduces the possible configurations of tidal barrage power plants. In consultation with Royal Haskoning the following conclusions are drawn regarding the configuration of a tidal barrage in the Klabat bay. The Klabat bay does not offer obvious geometric characteristics that would allow a design with more than one basin. That would require the construction of an extra dam, a major increase in the investment cost. That leaves the single barrage as the only option. According to the experts at Royal Haskoning it would not be a good idea to apply two-way generation. The average head in the Klabat bay is relatively small, and turbines need a minimum head to operate. Two-way generation schemes lower the available head. Under these circumstances, the construction of a two-way generating tidal barrage power plant would not be feasible. This leaves the option of a single-basin, one-directional tidal barrage. As there are no obvious reasons to install a flood generating power plant, and the output of an ebb generating plant is slightly higher, the conclusion about the configuration is that the conceptual design of the tidal barrage power plant should be one-directional, single-basin and ebb-generating.

Other concepts for tidal barrages have been developed, for example for the Severn Barrage in the UK. A concept such as the one for Severn would be a good solution if shipping entry is a major issue and low investments are needed. If you close a bay with a dam you can harvest most of the total available potential energy. The Severn concept only utilizes a smaller part of the available potential energy because water flows also pass by the turbines. It requires a complete feasibility study to analyze the feasibility of such concepts for the Klabat bay. However, based on experience, it could be claimed that the cost-benefit of such a concept will be lower compared to a dam that completely closes the lake.

7.1.1.1 Assumptions

To make a basic conceptual design for the tidal barrage power plant in the Klabat bay it is necessary to work with the outcomes of the bathymetry analysis, the tidal charts and some assumptions.

The following assumptions were used to make the basic conceptual design.

- Average tidal range: 1.77m
- Flood period: 12 hours
- Ebb period: 12 hours, 30 minutes
- Minimum operating head turbines: 0.5m
- The flux through the turbines remains the same during operation (in reality the debit fluctuate)
- The maximum water level in the basin equals the maximum water level outside the basin (in practice this depends on the through-flow area of the sluices)
- The minimum water level in the basin equals the average water level of the sea

7.1.1.2 Operating scheme

Using the assumptions from the previous paragraph the following operating scheme was devised:

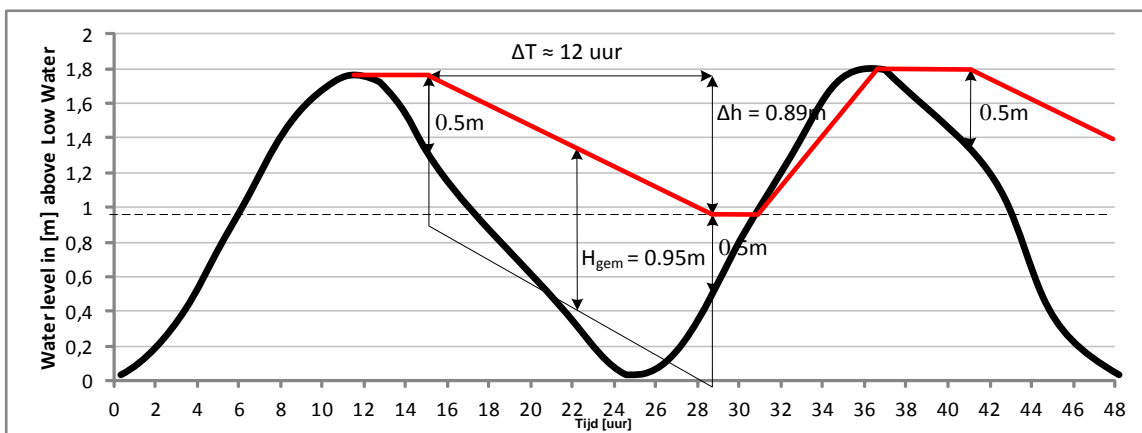

The black line represents the tide, and thus the water level, at the seaside of the dam. The red line represents the water level inside the basin. The difference in height between the red line and the black line represents the head between the inside of the dam and the outside of the dam. As can be seen on the graph the minimum head for the turbines to operate is 0.5m. Note that the tides are not a perfect sinus, in general the ebb period takes a little longer.

Based on this graph it can be derived that it takes about 12 hours to lower the water level inside the basin with 0.89m. The average productive head is 0.95m

7.1.1.3 Energy production with this operating scheme

Based on this operating scheme it is possible to calculate how much energy this power plant would produce.

P		Power [W]	$P_{tidal\ cycle} = \eta \cdot \rho \cdot g \cdot H \cdot Q$ $= \eta \cdot \rho \cdot g \cdot A \cdot dh \cdot Q$ $= 0.8 \cdot 1035 \cdot 9.81 \cdot 140,000,000 \cdot 0.89 \cdot 0.95$ $= 0.27\ GWh$ $= 0.27 \cdot 365 = 99\ GWh\ annually$
η	0.8	efficiency of tidal plant [-]	
ρ	1035	density [kg/m ³]	
H	0.95m	Usable tidal range [m]	
A	1.4 * 10 ⁸	surface area basin	
dh	0.89	Used head [m]	

7.1.1.4 Turbines

Compared to other places where tidal barrages have been developed the average tidal range is relatively small with 1.77m. There is a limit to the operating range of turbines. Every turbine needs a certain minimum head in order to start up. However, the diameter of the turbine is an important parameter. In a laboratory a scale model with a diameter of a couple of centimeters would work fine with a head of a couple of centimeters.

To establish the applicability of turbines it is good to use reference projects. In the Netherlands run of river plants in the river Maas use turbines with a 4m diameter with a head of 1m. These turbines however only need maintenance and inspection after a new start-up, while a tidal power plant in the Klabat bay would have to start up every day. The Kislaya Guba pilot plant in Russia operates with an average head of 2.3m and a turbine of 3.5m. Based on these numbers from reference projects it seems an acceptable assumption to work with turbines of 3m in diameter.

The needed average flow through all the turbines in [m³/s] can be deduced by dividing the plane of the replaced water by time [s]. As it is also possible to calculate the through-flow of a turbine with a 3m diameter it becomes possible to estimate how many turbines will be necessary:

P		Power [W]	$Q_{avg,total} = \frac{dh \cdot A}{dT}$ $= 0.89 \cdot 140 \cdot \frac{10^6}{12 \cdot 3600}$ $= 2884 \left[\frac{m^3}{s} \right]$ $Q_{turbine} = m \cdot A \cdot \sqrt{2 \cdot g \cdot H_{gem}}$ $= 1.2 \cdot \pi \cdot 1.5^2 \cdot \sqrt{2 \cdot 9.81 \cdot 0.95}$ $= 36.6 \left[\frac{m^3}{s} \right]$ $\frac{Q_{avg,total}}{Q_{turbine}} = \frac{2884}{36.6} = 79 \text{ turbines}$
H_{rated head}	0.66*1.77	Rated head	
ρ	1035	density [kg/m ³]	
H_{gem}	0.95m	Average usable tidal range [m]	
A	1.4 *10 ⁸	surface area basin	
dh	0.89	Used head [m]	
Q		flow [m ³ /s]	
dT	12*3600	Time [s]	
g	9.81	Gravity constant [m/s ²]	
m	≈1.2	Flow coefficient	

Naturally a lot of optimization is still possible. For now it is a good assumption to work with 79 turbines with a 3m turbine for the conceptual design. The installed power can now be calculated as well:

$$P = \rho \cdot g \cdot Q_{avg,total} \cdot H_{rated\ head} = 1035 \cdot 9.81 \cdot 2884 \cdot 1.17 = \mathbf{34MW}$$

The size of the sluices need to be large enough to let the water level rise with the sea level when the turbines are not operating.

7.1.2 Bathymetry issues

7.1.2.1 Shallowness of the Klabat bay

The water depths in the Klabat bay, and especially the inner klabat bay, are relatively shallow. This issue was introduced in Chapter 3 in the description of the bathymetry. One of the issues pointed out was the accumulation of sediments in the inner bay from the rivers and possible clogging of the lake. The experts at Royal Haskoning agree that there will be an influx of sediments at the side of the dam.

This is assuming that the dam is placed at the narrow entrance to the inner Klabat bay and the inner lake will function as the basin of the dam. A sediment balance would offer more detail than necessary at this stage of the research. For such a research firstly the sediment transport of the rivers has to be measured and subsequently it has to be calculated how much of the sediments will be suspended through the turbines and sluices based on the design. The current assumption is that some sediments will accumulate in front of the dam, but in this phase of the research this not a priority issue.

7.1.2.2 Changing the tides of the inner klabat bay

The red line in the operating scheme represents the water levels of the inner Klabat bay after construction of a tidal barrage which is producing during ebb. The water level will become consistently higher compared to the current situation. When the sluices are open the water level will rise up to the maximum sea water level. After the ebb sets in the sluices are closed and the water level is lowered in a controlled manner until the range between inside and outside of the dam (so called head) is so small the turbines can no longer operate. In practice this means that the water level of the inner Klabat bay will never go below a certain threshold and the average tides have become significantly smaller, almost halved. The impact this change in tides has on the maritime environment, and on populations of crabs, birds etcetera is a topic of further research. This should be part of the environmental impact assessment.

7.1.3 Arrangements

Following from the basis of design the following institutional design variables need to be addressed.

7.1.3.1 Ownership arrangements

Ownership can be fully state-owned, so owned and operated by PLN, privately owned or a combination of the two. Ownership is a form of risk management. From an economic perspective the one who is best able to carry risks will get the best economic performance out of a project.

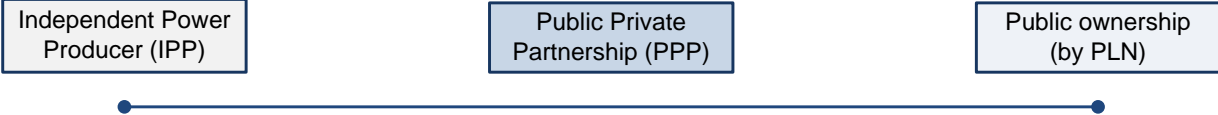

Constructing a tidal barrage in the Klabat bay involves large financial risks that are difficult for private investors to cover. Non-participation of the public sector in this project would increase the risks for the private investors to an unacceptable level. It would allow for all kinds of strategic behavior from the public sector. The licensing process could be hijacked, and PLN could act strategically during the negotiations for a power purchasing agreement. Also after construction of the power plant the investors would be very vulnerable to strategic behavior from PLN who could favor its own production units. In order to alleviate some of the risks of this unique project proposal and alleviate the risk of strategic behavior of public participants, it is critical for the public sector to be involved in the project development.

At the other end of the scale is full public ownership. This would mean PLN takes the initiative to develop a tidal power plant in the Klabat bay and finds the contractors to do so. PLN has no experience with the development of tidal barrage technology. Its organization is geared towards quick and low cost development of power capacity. Therefore it is unlikely for PLN to be willing to develop the tidal barrage plant. The tidal barrage potential in the rest of Indonesia is limited so it

requires a lot of resources for a one-time 34MW development. This means that all the knowledge, expertise and equipment will have to be hired from abroad, a risk for cost overruns.

So, an IPP would be too risky for private investors, public ownership would be too much of a stress on the organization of PLN and bring additional risks of cost overruns. Therefore a combination of the two in the form of a Public Private Partnership is more appropriate.

As explained in the institutional analysis (paragraph 5.3.1) the processes available for Public Private Partnership are guided by regulations. Key regulations governing public private partnerships for infrastructural projects are Perpres No. 67/2005 as amended by Perpres No.13/2010. These presidential decrees establish the creation of investment vehicles PPI and SMI that encourage Public Private Partnerships.

In the PPP the public parties have 2 main responsibilities

- Minimize political risk (particularly the licensing process and land-use agreements)
- Insure risk that the private sector is exposed to, at an acceptable premium

A possible hazard is that the private investors will attempt to transfer as much risk to the public sector as possible. Therefore it is crucial that the risk assessment that the government is obligated to perform is executed in a professional manner. The risk management assessment has to include at least an analysis of the political risk, project performance risk and demand risk.

7.1.3.2 Process arrangements with PLN

PLN has two process schemes at its disposal for a power plant of this capacity, the standard bidding process or direct appointment. The standard bidding process is performed on a regular basis from the main office of PLN in Jakarta. This has advantages as the available expertise and experience is already in place. Also the relations with the national government agencies for licensing follow a more structured approach. However, the process is rigid, lengthy and requires the participation to the bidding of at least three investor groups (Special Purpose Vehicle or SPV). As this is such a unique project the development process is not standard and would benefit from greater flexibility. Furthermore the number of companies with the technological knowledge and equipment for tidal barrage construction is limited.

As this is a renewable energy project the process followed could be the direct appointment procedure. This procedure is less rigid, and performed by the local Bangka PLN department. This has the advantage that they are better able to integrate the tidal barrage plant into the local power grid, which is also relevant for the Power Purchase Agreement. The disadvantage is that the local PLN office has fewer resources readily available to deal with this project application.

The process involves the appointment of a winning SPV after which the SPV can apply for a temporary operating license. The contract negotiations between the SPV and PLN have to result in a contract for which PLN will receive corporate approval (by PLN) and approval of the PPA (by Ministry of Energy, Minerals and Resources). With these approvals the contracts can be finalized after which the SPV can request a permanent operating license (RUPTL)

7.1.3.3 Power Purchase Agreement (PPA)

Standard PPA agreements in Indonesia consist of a price/kWh agreement in combination with a period for which the agreement is fixed, usually 15 to 20 years. It often includes a fuel multiplication factor to take account of changes in the price of raw material.

A tidal barrage project in the Klabat bay is exceptional for four reasons:

1. Intermittency of power production, which requires back-up capacity
2. Very low variable cost (no fuel input, low maintenance and operation cost)
3. An exceptionally long expected lifetime
4. Power demand at Bangka far exceeds supply, back-up power might not be idle when the tidal plant is in operation

These issues need to be incorporated in the PPA. One way of dealing with the exceptionally long lifetime is to devise a PPA that would transfer the ownership to a public entity after expiration of the PPA. In this case the price would have to be high enough for the investor to earn back the investment cost plus a premium within the lifetime of the PPA. This would raise the price in the PPA but transfer the benefit of a much extended lifetime to the public sector, while at the same time giving the SPV the certainty of an acceptable return on investment. According to Clark (2007) the exceptionally long lifetime of tidal barrage power plants is unaccounted in feasibility studies, with a negative impact on the feasibility as a result.

As the tidal power plant has no fuel cost the marginal cost of electricity production approach zero. Therefore the power production from the tidal power plant should have preference over other production capacity in day-to-day operations. With diesel fired power plants this variation in production is relatively easy to achieve, coal fired power plants are much less flexible. Currently a large portion of power production on Bangka is diesel, while coal fired power plants are under construction and more coal capacity is planned. This will change the conditions for the off-take of power from a tidal power plant. The Bangka-Belitung power network needs a minimum of flexible power production equal to the capacity of the tidal power plant. According to Bernshtein (1996) the power grid in which a tidal power plant is incorporated should have enough capacity to deal with the intermittency. Bernshtein even states it as a requirement for feasibility. The PPA needs to include the cost of back-up power and include scenarios of power development into the agreement. If the tidal power plant is built, and simultaneously PLN increases its non-flexible capacity, then PLN is likely to favor its own plants. This situation has to be avoided. It is one of the arguments for a public private partnership.

Some of the issues are interdependent. The long life time means that the environment in which it is constructed could radically change. At this moment the demand far exceeds power supply, but this should change in the future, especially if plans for a nuclear power plant materialize.

The exact content of the PPA will be negotiated by the SPV and PLN and checked by the MoEMR.

7.1.3.4 Risk management

The risk allocation arrangements from Table 6 in Paragraph 5.3.3 are not all relevant for tidal barrage plants. The fuel supply and fuel cost are irrelevant .

The following risks are shared by PLN and the government:

- Capacity and energy price risk
- Foreign exchange risk
- Country/ regulatory risk

The SPV bears the following risks

- Construction risk

- Operational risk

Site selection could be an issue for construction facilities and power transformation units. These risks are shared by the IPP and PLN

7.1.3.5 Alignment of interests

The feasibility is dependent on the participation of the critical stakeholders, as defined by the stakeholder analysis from paragraph 5.2

Some stakeholders have requirements for participation in electricity development projects.

PT. SMI – Commercial business case

PT. PII – Commercial business case

PT. PLN – Funding for transmission and distribution

MoEMR – commercial business case

If these requirements are not met it will be difficult to involve these stakeholders in the development process. As these stakeholders were identified as critical for the development of a tidal barrage plant in the Klabat bay, it will be very difficult to progress without their assistance.

7.2 Conceptual Design Tidal Stream

The basis of design lists the physical design parameters for tidal stream units; configuration, placement, ducting and choice of developer. With these design variables many tidal stream plant designs are possible, and many different concepts are being developed.

The design approach of this research is to 'select an instance within the solution space which best meets the objective'. There is a problem in case of tidal stream technology, the combination of some constraints are conflicting, which means that there appears to be no instance within the solution space that meets all the constraints.

- The cost of energy from the first tidal stream farms has been predicted to be between 0.14 USD/kWh and 0.28 USD/kWh, with central estimates in the range 0.19 USD/kWh to 0.23 USD/kWh (Entec, 2007). With the costs of existing units far exceeding these estimates.
- As Bangka is part of the Sumatra grid, the feed-in tariff for small scale renewable energy would be 787 IDR/kWh (0.0835 USD) for medium voltage grid connection or 1204 IDR/kWh (0.1065 USD) for a low voltage grid connection
- The average stream speeds in the Klabat bay are estimated to be about 0.18m/s while known attractive tidal stream sites measure speeds of 1m/s and more
- Tidal stream technology is immature and currently there are no plants in operation

The revenue available from the feed-in tariff for small scale renewable development, 0.11USD/kWh, is insufficient to cover the cost of tidal stream generation, even for the most positive estimate of 0.14 USD/kWh. On the basis of these numbers it is certain that there is no viable business case for tidal stream development as long as these constraints do not change. It is impossible for the problem owner, Bangka regency, to change these constraints. Given the objective of affordable electricity development that makes a real contribution to the availability of production capacity on the Bangka grid, this objectives cannot be met with tidal stream technology.

Given the fact that large scale tidal stream development is planned in the UK, and Indonesia is identified as a country with considerable tidal stream potential, then the question becomes why a similar development is not happening in Indonesia. For the rest of this paragraph suggestions are offered how to create an environment in Indonesia that would allow for the development of tidal stream farms in the short to medium term. The Klabat bay is taken as an example case that shows how a different institutional environment could change the previous calculations and thus feasibility.

In order to do so, it is necessary to assume that the physical circumstances in the Klabat bay are favorable enough for tidal stream development. Or, the stream speeds are assumed sufficiently fast for tidal stream development for the rest of this paragraph.

Changing the institutional environment is strictly speaking outside the scope of the research, the problem owner is not able to accomplish these changes. The reason it is being done here is to show an application of the SEPAM analytical models.

7.2.1 Creating the institutional environment in which tidal stream power development in the Klabat bay would be possible

Two assumptions precede this paragraph:

1. The physical parameters of the Klabat bay suit the deployment of a tidal stream unit or farm
2. The designer is able to influence the institutional environment.

These are important assumptions that need to be made for the application of this academic exercise.

7.2.1.1 *Conceptual framework*

Figure 40 is a visual representation of a cube in the ocean. The point of the figure is to show that this cube could be anywhere in the world, for example the UK or in Indonesia. The physical parameters, stream speeds, soil type, water depths and location of this cube are important for the feasibility of tidal stream development. However, research points out that both in the UK and in Indonesia there is considerable tidal stream potential, while the previous paragraph proves that tidal stream development in Indonesia is currently not possible, while it is in fact possible in the UK. So, while the physical parameters are similar, the institutional parameters impede tidal development in Indonesia. This paragraph aims to compare this conceptual cube in the Klabat bay to the conceptual cube in the UK, and suggest what changes in the institutional environment are necessary to develop tidal stream in the Klabat bay.

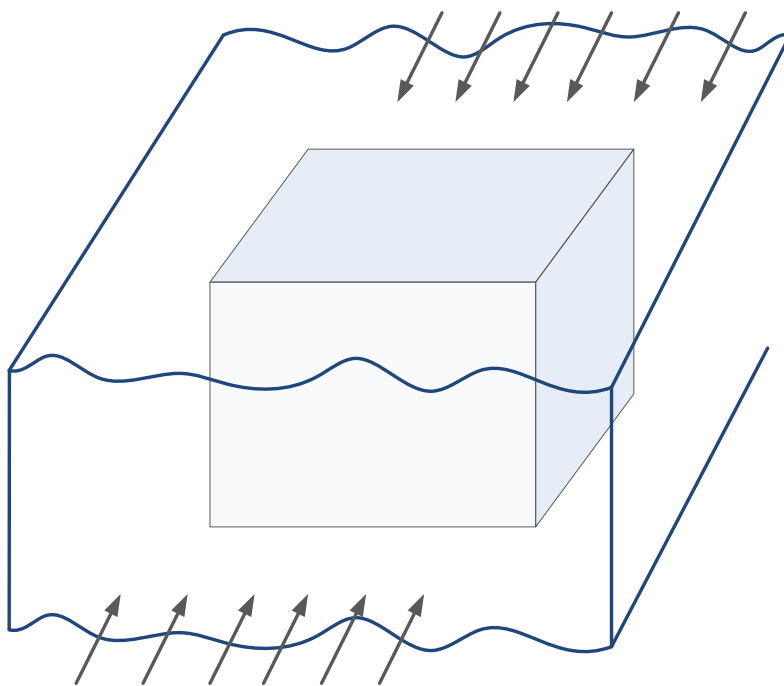

Figure 40 Visualisation of the design concept

‘Assuming the stream potential in the Klabat bay is sufficient for tidal stream development, what are the system requirements for deployment of tidal stream units in the Klabat bay?’

7.2.1.2 *Required actions from Indonesian stakeholders*

There are a number of important reasons why the United Kingdom is trying to develop tidal stream farms, and it could be argued that the same reasons apply for Indonesia.

The UK is trying to develop tidal stream farms because:

- It has a large domestic potential for tidal stream
- It aims to develop the upcoming tidal stream industry
- It hopes that the domestic industry will later serve as a global player for tidal stream development and benefit from its front runner position

- Tidal stream development is in line with its objective of increasing the percentage of renewable energy production

Such an objective requires an orchestrated initiative of many very different stakeholders. It means bringing together knowledge, financing, policy, regulation and industry. When comparing the institutional environment in the UK as sketched in the report by The Crown Estate (2011) the following suggestions can be made. The figure below shows the required actions from key stakeholders in Indonesia.

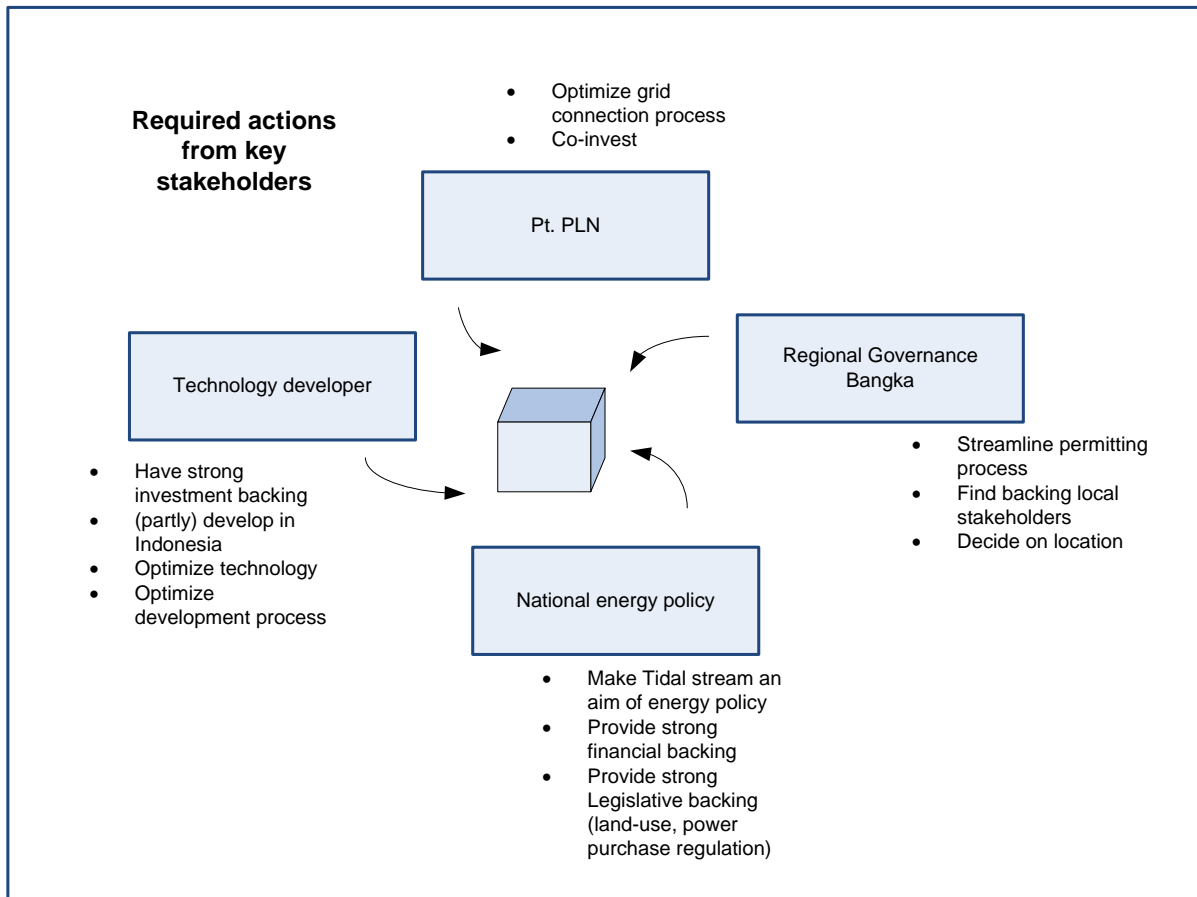

Figure 41 Required actions from key stakeholders

7.2.1.3 Site selection

The development of a tidal stream industry assumes a top down, national, initiative. In this respect site selection is important. Some research about tidal stream potential in Indonesia has been performed by Blunden et al (2012). The selection criteria for their research show the relevant factors:

Table 1
Potential sites for tidal current power schemes in Indonesia. Brackets indicate for 'second-generation' (floating or gravity-based devices). E = elevation, V = velocity.

Sea area	Criteria					Data available?
	Mean spring peak tidal current flow speed greater than 1 m/s	Adequate water depth for tidal current turbine installation	Not a major shipping lane	Near to the existing electricity grid		
Malacca Strait	+	+	-	+		E, V
Lombok Strait	+	- (+)	+	+		E, V
Alas Strait	+	+	+	+		E, V
Sunda Strait	-	-	+	+		E
Makassar Strait	-	- (+)	+	+		E
Capalulu Strait	+	-	+	-		-
Berau Bay	+	+	+	-		E

Figure 42 Site selection parameters; potential sites for tidal current power schemes in Indonesia (Blunden, Bahaj, & Aziz, 2012)

The criteria used are:

1. *Mean spring tidal current flow speed greater than 1m/s.* For this design exercise it is assumed to be upwards of 1m/s in the Klabat bay. Research has been performed on the marine current potential in Bali, Lombok and Makassar straits using three-dimensional hydrodynamic models developed at Princeton University. With the use of this model it is possible to simulate current speeds based on bathymetry conditions and know tidal differences (Rachmayani, Atma, Suprijo, & Sari, 2006). Applying the same technology to the Klabat bay could provide more detailed information about the tidal stream potential.
2. *Adequate water depths.* The water depth requirement Blunden is referring to is to do with the maximum depth. When the water is very deep it becomes a requirement to use novel technologies such as floating devices which are in a an even more modest development stage. In case of the Klabat bay the water depths are sufficient around the narrow entrance whereas in the bay the water depth is limited.
3. *Not a major shipping lane.* A requirement the Klabat bay meets
4. *Near to the existing electricity grid.* There is a former diesel fired power plant at the site, so the power infrastructure is already in place, though it might require refurbishing.
5. *Data available.* Blunden selects the site based on the availability of data. He distinguishes between water depths and stream speeds.

If the data of the stream speeds in the Klabat bay could be made available, it would allow for the site to be a subject of academic case studies. It seems to meet all the other requirements (assuming +1m/s speeds) of potential sites and there is a demand from local authorities to look into the possibility.

8. Feasibility assessment of tidal power development in the Klabat bay

This is the final stage of the study in the research framework. In the design methodology of Herder and Stikkelman the designs now need to be tested based on the performance indicators. In the research framework this is translated to the box on the left in figure 43; testing the technological, financial and economic performance and acceptance. If a design is judged feasible it is possible to select the best option.

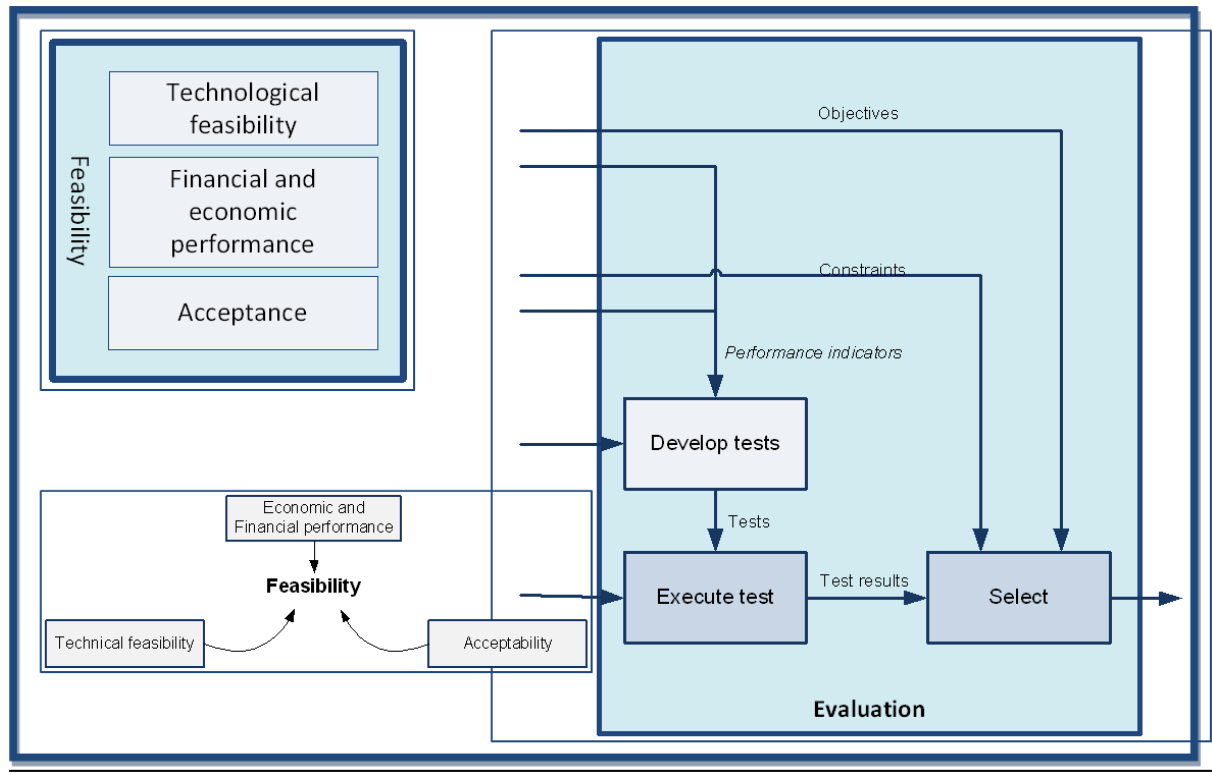

Figure 43 Evaluation methodology

The design model was originally developed for technological systems. In technological design the testing and execution of testing is supposed to have a quantitative basis, to allow for transparent comparison.

In this case the designs are evaluated on technical feasibility, economic and financial performance and acceptability. If the design fails to meet the minimum requirements of one of the performance indicators the design is considered 'unfeasible'.

Minimum requirements for the performance indicators:

- Technical feasibility – The possibility to apply engineering solutions to fulfill the objective
- Economic and financial performance – Commercial viability
- Acceptability – The design is acceptable for all the critical stakeholders

8.1 Feasibility assessment tidal barrage

8.1.1 Technical feasibility

The technology used for tidal barrage power plants is mature and has proven commercial viability in a number of cases. The bathymetry conditions of the Klabat bay are such that the construction of a barrage, with the inclusion of 79 turbines and a number of sluices, should be possible.

Another important technical factor is the energetic potential. Compared to the other feasibility studies as described in paragraph 2.3 the potential of the Klabat bay is limited. The minimum mean tidal range of those investigated sites is 2.4m, while most of the researched sites have mean tidal ranges of 5m and more. This compares unfavorably to the 1.7m mean tidal range of the Klabat bay. Not only is the mean tidal range low compared to other potential sites in the world, it is also a diurnal tide. The tidal period is 24h compared to the usual 12h, this halves the energetic potential.

The energetic potential of the Klabat bay is small compared to other sites in the world that are considered as potential tidal barrage sites.

This does not mean that it would not be technically feasible, with an unlimited budget it would be possible to construct a tidal barrage site. The next paragraph assesses the financial and economic performance.

8.1.2 Financial and economic performance

As the design is so rudimentary, the financial analysis is not less rudimentary. Estimating the cost and revenues with a best case, base case and worst case scenario it will be possible to assess the financial and economic performance.

8.1.2.1 Cost comparison scenarios

The eventual revenue for the owner of the tidal power plant depends on many factors, not least the negotiation process with PLN. For this estimation we compare the cost of the tidal barrage design with the cost of other electricity production. These are comparisons with the cost of current power production and competing technological solutions such as gas and coal. The cost estimations for gas and coal fired power production in Indonesia is based on Thammasat (2011)

Cost comparison scenarios	Cost per kWh
1. Reported basic cost of rural power supply on Bangka (as reported by PLN (Purwono, 2008))	0.31 Dollar/kWh
2. Reported basic cost of city power supply on Bangka (as reported by PLN (Purwono, 2008))	0.26 Dollar/kWh
3. Consumer revenue	0.08 Dollar/kWh
4. Estimated cost of coal fired generation capacity	0.06 Dollar/kWh
5. Estimated cost of natural gas fired generation capacity	0.098 Dollar/kWh

As the amount of energy that the tidal barrage will be able to produce in a year is known, 99GWh, it is possible to estimate the comparable yearly cost of other production options. These estimates will later be used to compare the total investment cost of a tidal barrage plant to the yearly cost of the other options for electricity production.

8.1.2.2 Cost

The construction cost are an important factor for the feasibility of tidal barrage power production. The construction costs of unique, large, infrastructural projects are notoriously hard to predict. There are a number of methods to make an estimation such as literary review, using reference projects or estimating and adding up all the component costs.

At this point of the analysis it suffices to come up with a number that gives an indication of the cost, to judge whether the cost are close to projected revenues. The cost will be a rough estimate, and therefore the economic feasibility will be reviewed based on a best case (50% of estimated cost), base case (100% of estimated cost) and worst case (200% of estimated cost) scenario.

The word 'Cost' can mean many things. Expenses and revenues are time-dependent, and so is the value of money. Therefore in order to assess the economic feasibility of any investment one needs to convert all costs and revenue streams to a Net Present Value (NPV). For now, as the great majority of the cost is up-front, the focus is on the construction cost. Another method to assess the feasibility of tidal impoundment is used by Clarke and involves comparing an energy system without tidal energy to an energy system with tidal energy to account for intermittency and adapting the system to this.

As the design of the tidal barrage is so rudimentary, it is not possible to devise a bottom up detailed cost analysis. The aim of this paragraph is to estimate the cost using data from other projects. The outcome will not be a single number, but an indication. The following steps were followed:

- Literature review
- Identification of major cost components
- Estimation of the cost of the turbines and generators
- Estimation of the total cost
- Comparison with reference project

1. Literature review

Previous cost research

Fay and Smachlo (1982) In the late seventies there was a lot of attention for renewable energy development. Most tidal projects focused on large scale projects such as La Rance. Fay and Smachlo at the Massachusetts Institute of Technology attempted to find an easy way to assess the cost of small scale tidal power plants. They did so by analyzing existing systems and performed feasibility studies and made empirical formulas that are dependent on the major design parameters; Rated tidal range, Turbine diameter and number of turbines.

One of the problems using these formulas is with the standardization. Fay and Smachlo assume mean tidal ranges between 3-5m, the use of caisson construction and the use of straight flow turbines. In Klabat the mean tidal range is 1.77m which means there is a need for many more turbines for the same rated power. The size of these turbines is much smaller. And nowadays construction companies have more experience with construction on land, which would eliminate the need for caisson construction. In the case of La Rance it was said that construction on the land could have accounted for a cost saving of up to 50%.

- Outdated (Fay & Smachlo, 1982)

	<ul style="list-style-type: none"> • Formula's officially not applicable • Formula's hard to understand • Detailed bottoms up approach
Swane (2007)	<p>In his thesis research for the TU-Delft Swane performed a feasibility study for the Seamangum straight in Korea. The situation there was slightly different as the dam was already in place as a prevention against flooding. Swane used Fay and Smachlo as a basis for his cost calculations. However he realized that the estimations for turbine cost would be inaccurate and devised his own formula based on (sparse) data that was provided by Alstom. His formula proved surprisingly accurate to predict Korean case studies.</p> <p>I was unable to track back the formulas that he used from Fay and Smachlo to their exact origin and the meaning of a number of variables.</p> <ul style="list-style-type: none"> • Uses Fay and Smachlo as a basis, except for turbines and generators • Not all formulas are well explained (missing indexes) • Easy to use • Simple but inaccurate assumptions • No barrage construction in Saemengum necessary (makes use of an existing dam)
Mooyaart (2009)	<p>Mooyaart investigated the feasibility of tidal power developments in the Westerschelde in the Netherlands. He also used Fay and Smachlo as a basis for most of his cost calculations. However for the turbines he analyzed the methods used by Swane and Gilles and compared his findings with Dutch case studies. Both predictors seemed inaccurate. According to Mooyaart the difference was likely to be in the cost of labour. He decided to correct these formulas with a multiplier.</p> <ul style="list-style-type: none"> • In terms of power output it is cheaper to build a few large turbines compared to a lot of small turbines with savings up to 30%. • Uses Fay and Smachlo as a basis and checks with Dutch projects to validate. Fay and Smachlo prove inaccurate for turbines and generators in the Dutch case in 2009 • Makes use of more detailed design parameters which are unavailable for the Klabat bay
Clark (2007)	<p>Clark presents a methodology for the economic assessment of tidal power projects. He compares complete energy systems with and without tidal power. This has the advantage of incorporating the 'systems' view into the economic analysis. Because of intermittency the entire energy system needs to deal with fluctuation in production. Therefore in order to assess the benefit of tidal power one needs to incorporate these costs (Clark, 2007).</p> <ul style="list-style-type: none"> • Thorough methodology • Takes into account alternative options • Labour intensive • Need for a lot of data

2. Identification of major cost components

Fay and Smachlo present the major cost components of tidal barrage construction. The total cost of tidal impoundment consists of the following components:

$$C_{tot} = C_{t+g} + C_b + C_p + C_{sl} + C_{bed} + C_c$$

In which:

C_{t+g}	Cost of turbines and generators
C_b	Cost of barrage
C_p	Cost of powerhouse
C_{sl}	Cost of sluices
C_{bed}	Cost of bed protection
C_c	Cost of cofferdam

In case of 'construction on the dry' there is no need for a cofferdam, so the last component would be replaced with a smaller component for some increased infrastructure spending.

3. Cost of turbines and generators (C_{t+g}) and powerhouse (C_p)

Swane (2007) and Mooyaart (2009) used formula's to project the cost for turbines and generators. The formula Swane uses is based on information made available by Alstom and a linear regression from that data. Mooyaart uses an empirical formula from Gilles (199X). Both calculations were originally made in Euros (€)

Firstly the formula made by Swane will be used:

Symbol	value	Explanation
H_r	1.17	Rated Head (0.66*average head)
N_t	79	Number of turbines
D_t	3m	Turbine diameter
P_t	658kW	Power turbine

There are a couple of factors influencing the cost of turbines and generators:

- Fixed starting costs, independent of number of turbines (= US\$ 5.5 Million)
- A linear relationship with the number of turbines (proportional to N_t)
- An exponential relationship with the turbine diameter (proportional to D_t)
- An exponential relationship with the rated head (proportional to $H_r^{0.18}$)

The proportionality factors are deduced from the total selling price of the lake Sihwa turbines. Conversion to US\$ and a correction for inflation then leads to the following formula:

$$C_{t+g} = 5.500.000 + 118.500 * H_r^{0.18} N_t D_t^2$$

Filling it in for the Klabat case:

$$5.500.000 + (118.500 * 1.0286637961895878 * 79 * 9) = \mathbf{92.168.525}$$

Using the formula in similar fashion to Mooyaart:

$$C_{t+g} = 10646 * N_t P_t^{0.70} H_r^{-0.26} =$$

$$10646 * 79 * (658^{0.7}) * (1.17^{-0.26}) = \mathbf{75.848.703}$$

Both formulas result in a figure which is in the same order size. As both numbers are rough estimations we will assume the more detailed calculated and conservative number. The estimated cost for the turbines are thus 92 million euro's.

4. Estimation of total cost

As it is difficult to make an estimation of the cost of a tidal barrage when a detailed design doesn't exist, the estimation is based on rough assumptions. This will be accounted for in the final assessment when a best case, base case and worst case scenario alleviate the problem of inaccurate prediction. Deltares and Royal Haskoning prepared a report about tidal energy that contains a selection of UK case studies and cost estimates (Deltares, 2009). The table below shows how the cost of turbines and generators relate to the total cost of the project. Percentages range from 11% to 32% and on average 19%. For this calculation we will assume the average 19%

	Mersey	Swansea	Russell	Liverpool	Loughor	Duddon	Wyre
C_{t+g}	360.4	33	362	86.7	2.6	134.4	34.5
Studies, consenting, design and management	173	10	476	43.4	4.1		16.8
total	1511.6	255.1	2348	663.6	23.4	413.5	138
% of turbines and generators cost	24%	13%	15%	13%	11%	32%	25%

Table 8 Cost details selected UK case studies in millions British pounds ((Deltares, 2009)

If the turbines and generators cost 92 million euros and account for 19% of the total cost of the project it follows that the total cost of the project can be estimated to be in the area of 484€, which at today's currency rate (1EUR=1.26USD) is 609 million USD, or 5697 billion IDR

Using the most advantageous numbers from these calculations, the estimated cost would be 295 million USD (turbine cost 75mEUR being 32% of total, multiplied by 1.26USD)

5. Comparison with reference project (Garolim, South Korea)

The Garolim bay in South Korea is remarkably similar to the Klabat bay, with the difference that the mean tidal range is much more attractive with 4.7m. But physically the parameters are very similar (Lee, 2006a):

	Garolim	Klabat
Mean tidal range	4.7	1.7
Barrage length	2km	1.5km
Basin area	45.5km^2	40km^2
Production scheme	One-way during ebb	One-way during ebb
Intalled capacity	480MW	34MW

Table 9 Comparison Garolim bay and Klabat bay

The predicted cost for the Garolim project are 1000 million USD (Lee, 2006b). The cost for the construction of the Garolim project will be higher than the Klabat bay as the power equipment will be much larger. However, the barrage construction cost will be quite similar. Therefore the comparison of 609 million USD for the Klabat bay and 1000 million USD for the Garolim bay does not sound strange. It can safely be assumed that the cost in the Klabat bay would not exceed the cost in the Garolim bay.

6. Cost scenario

Best case	Base case	Worst case
294	609	1000

Table 10 Cost scenario's in million USD

8.1.2.3 Revenues and Investment cost comparison

A simple way to calculate the cost effectiveness of a project is to calculate the time necessary for a project to achieve break-even. In a more detailed analysis it would be necessary to calculate the Net Present Value, this allows for a correction of time in the valuation of capital flows. The estimates made before are not as accurate, so running a detailed Net Present Value analysis based on that data would not significantly improve the analysis.

Instead it was chosen here to compare the estimated project cost with the identified revenue scenario's. This allows for an estimation of the time it would take for a tidal barrage to reach break even.

			Best case		Base case		Worst case	
	Dollar /kWh	Million Dollar/year with 99GWh		Cost/annual revenue= break-even		Cost/annual revenue= break-even		Cost/annual revenue= break-even
Basic cost 2008 rural (2919rupiah/kwh)	0.31	30.1	300	10	609	20	1000	33
Basic cost 2008 city (2476rupiah/kwh)	0.26	25.7	300	12	609	24	1000	39
Consumer revenue	0.08	7.9	300	37	609	77	1000	127
Coal	0.06	5.9	300	52	609	104	1000	154
Gas turbine	0.098	9.7	300	31	609	62	1000	103

Table 11 Rough estimations of revenues and investment cost

From table 11: The number 10 in the best case scenario compared to basic cost rural should be interpreted as:

If the most advantageous estimation of the construction cost of a tidal barrage power plant is compared to the current cost of rural electricity production, the time to break-even would be 10 years.

The colored blocks present the amount of years necessary for this tidal barrage project to break even, compared to the comparison cost scenario's.

There are two scenario's imaginable that have a very acceptable break-even point. If the construction cost turn out to be in the area of 300million dollar, and the investment is evaluated based on the current cost of power production on Bangka, there appears to be a business case.

Two scenario's are coloured orange, these times-to-break-even that could be acceptable for projects with a lifetime as long as a tidal power plant. These are the scenario's for the base case cost estimations compared to the current cost of power production on the island.

When comparing a tidal barrage project proposal to other production technologies such as coal or gas, then even in the best case scenario there is no business case.

In conclusion, the current cost of power production on Bangka-Belitung are extremely high, one of the reasons this project was initiated. If a tidal power project was initiated based on the current cost of electricity production on the island, there is no reason to dismiss the feasibility based on financial and economic performance. However, the local regency and PLN would like to bring down the cost of electricity production, as the cost are exceptionally high compared to other places in Indonesia. Therefore the project should also be compared to other means of power production. If compared to the cost of coal and gas, there appears to be no business case for a tidal power plant. This ignores other considerations such as CO₂ production and renewable characteristics.

Its important to note that these conclusions are based on rough estimations. Also the need for back-up power are not included in the cost analysis. As the produced tidal power is intermittent, is a requirement that that is sufficient back-up capacity, which is idle for 40% of the time. This will add to the cost significantly.

8.1.3 Acceptability

There are three issues important for the acceptability of a tidal barrage

- Environmental impacts (change in tides, marine environment, fish population)
- Economic impacts (loss of income fishermen, mining operations)
- Cost (choice for renewable or low cost)

The environmental impacts at first sight seem to be limited to a relatively small percentage of the fish being killed and a minor change in the tidal movement of the inner Klabat bay. Both impacts however should not be underestimated, if it is chosen to continue to study the feasibility of tidal barrage development, these issues need to be researched in more detail. The institutional investment funds PT SMI and PT PII will require a detailed environmental assessment report before they can participate in any development.

The negative economic impacts because of a loss of fish and a loss of mobility from the inner Klabat bay will have to be offset by the benefits of the electricity production. Offsetting these negative impacts will add to the cost of a tidal barrage development. A more precise estimation of these cost will therefore have to be part of future more detailed feasibility studies.

A large part of the acceptability with depend on the cost. A tidal barrage development would be a renewable source of electricity production which is good for the acceptability. However, if the cost of electricity production compare unfavorably to other options (as is estimated in the previous paragraph) it is difficult to see how the government and PLN will approve of such a project.

8.2 Feasibility assessment tidal stream

The feasibility of tidal stream development was already shortly assessed in chapter 7.2. Those conclusions are repeated here:

The design approach of this research is to 'select an instance within the solution space which best meets the objective'. There is a problem in the case of tidal stream technology, the combination of some constraints are conflicting, which means that there is no instance within the solution space that meets all the constraints.

- The cost of energy from the first tidal stream farms has been predicted to be between 0.14 USD/kWh and 0.28 USD/kWh, with central estimates in the range 0.19 USD/kWh to 0.23 USD/kWh (Entec, 2007). With the costs of existing units far exceeding these estimates.
- As Bangka is part of the Sumatra grid, the feed-in tariff for small scale renewable energy would be 787 IDR/kWh (0.0835 USD) for medium voltage grid connection or 1204 IDR/kWh (0.1065 USD) for a low voltage grid connection
- The average stream speeds in the Klabat bay are estimated to be about 0.18m/s while known attractive tidal stream sites measure speeds of 1m/s and more
- Tidal stream technology is immature and currently there are no plants in operation

The maximum revenue stream available for small scale renewable development, 0.11USD/kWh, is insufficient to cover the cost of tidal stream generation, even for the most positive estimate of 0.14 USD/kWh. On the basis of these numbers it is certain that there is no viable business case for tidal stream development as long as these constraints do not change. It is impossible for the problem owner, Bangka regency, to change these constraints. Given the objective of affordable electricity development that makes a real contribution to the availability of production capacity on the Bangka grid, the objectives cannot be met with tidal stream technology.

The only way in which tidal stream development is possible in the Klabat bay is if it will be considered a 'technology development'. PT. PLN could for example find the resources outside the existing framework of feed-in tariffs. This would require the national government and PLN to devise an energy policy for Indonesia that includes the development of tidal stream technology. And when such a policy is in place, it would require PT. PLN to judge the Klabat bay as an area with a good potential for tidal stream development. The advantage that the Klabat bay has over other sites is that the demand is there and in the vicinity of the tidal potential. However, the estimations of the stream speeds appear to compare unfavorably to other potential sites in Indonesia.

9. Conclusions and Recommendations regarding the feasibility of tidal power development in the Klabat bay

There are two distinct technologies available for tidal power development. The most important design variables and design constraints for both technologies are summarized in the table below.

	Tidal Barrage	Tidal stream
Design variables	<ul style="list-style-type: none"> • Operating schemes – Ebb generation versus Flood generation • Operating schemes – One way generation versus two way generation • Operating schemes – Single basin versus double-basin • Optimization – Number, size and type of turbines • Optimization – Necessity, number and size of sluices • Construction in the wet (caisson construction) or in the dry 	<ul style="list-style-type: none"> • Configuration – Horizontal axis, vertical axis and making use of hydrofoils. There is no option which has a clear advantage to the others. • Placement – The options range from fixed placement using a gravity structure, using a single pole like off shore windmills to floating structures that are moored with anchors. • Developer – At this point of development the choice of the technology developer has a major impact on the technological design of the units
constraints	<ul style="list-style-type: none"> • Intermittency • Cost • Socio-economic Impacts • Environmental impacts 	<ul style="list-style-type: none"> • Immature technology • No commercial plants in operation • Energy production is very dependent on high stream speeds. The potential increases exponentially with an increase in stream speeds

The site research is summarized in the following table:

Klabat bay	Comparison with other potential sites
The average tidal range is 1.77m	Ranges from 2.3m and upwards
It is a regular diurnal tide (once a day)	Semi-diurnal (twice a day)
Estimated stream speeds at cape Ruh 0.18m/s	1m/s and upwards
Surface area Klabat bay 140km ²	Wide range of surfaces
Water depths at narrow entrance 20-25m	20-25m is sufficient for tidal stream development, adds to cost for tidal barrage
Water depths at other places in the bay vary between 1-13m	Wide range of depths
Possible energy production with barrage 100-165GWh annually	Small compared to other projects of this size

The institutional design variables are those formal and informal instruments at the disposal of the problem owner to guide and coordinate the behavior of stakeholders. These include ownership arrangements, process arrangements with the national power company (PLN), the Power Purchasing Agreement (PPA), risk management and influencing the attitudes of stakeholders. Ownership of

power production in Indonesia can be fully state owned, a public private partnership or the appointment of an independent power producer. Each type of ownership has its own merits and requires a different development process. 'Normal' power developments need to follow an elaborate open tender procedure. As this is a renewable power development, it is legally possible for PLN to choose for the direct appointment of a developer. The intermittency, the expected long life time of a tidal barrage and the novelty of tidal stream technology need to be incorporated in a PPA.

Conclusions regarding the conceptual design of a tidal barrage power plant:

- A tidal barrage design would most likely look like a one-way ebb generating plant with around 79 turbines with a 3m diameter. It would have a capacity of approximately 34MW and an annual production of around 99GWh.
- The most suitable ownership arrangement would be a Public Private Partnership as it would be most appropriate to manage risks. The Power Purchase Agreement (PPA) between PT. PLN and the Investment Vehicle (SPV) would have to include arrangements concerning intermittency, off-take of power, long expected lifetime and the future development of the Bangka power grid.
- The base case construction cost are estimated to be around 600million USD, with the best case being 300million USD and the worst case being 1000million USD
- Comparing the best case construction cost (300mUSD), a very optimistic estimate, to the cost of conventional power development, tidal barrage power development in the Klabat bay does not compare favorably.
- Comparing the best case and base case construction cost (300 and 600mUSD) to the current cost of power production on Bangka, there could be a reason to continue the investigation of the feasibility

Conclusions regarding the conceptual design of tidal stream power:

- The maximum revenue stream available for small scale renewable development, 0.11USD/kWh, is insufficient to cover the cost of tidal stream generation, even for the most positive estimate of 0.14 USD/kWh. On the basis of these numbers it is certain that there is no viable business case for tidal stream development as long as these constraints do not change
- Development of a tidal stream plant would require an orchestrated process design on a national level, bringing together knowledge, financing, policy, regulation and industry, which is outside the scope of the problem owner.

Recommendations for future steps tidal development in the Klabat bay:

- Tidal stream technology is not a commercially viable option. The development of tidal stream technology should be managed at the national level
- The conditions in the Klabat bay do not make it a likely location for tidal stream development. Three dimensional modeling could be used to improve the tidal stream potential assessment.
- Based on the cost estimations tidal barrage development is unlikely to be commercially attractive, if research is continued the efforts should be aimed at (in order of importance):
 - More detailed design of a tidal barrage plant in order to better estimate the construction cost

- Incorporate the cost of back-up power into the cost-analysis
- Environmental impact assessment
- Socio-economic impact assessment (fishermen, mining operations)
- Influence of sediments from the rivers on the inner Klabat bay

When compared to the current cost of electricity production on Bangka there could be a case for further feasibility studies. The focus should then be on a more detailed design of the barrage in order to be able to give a better estimation of the cost. Furthermore the cost of back-up power, loss in tin mining operations and loss in income for the fishermen need to be incorporated in these calculations.

10. Evaluation of Design Exercise

Now that all the research steps from the research framework are finished, it is time for the final evaluation of the design exercise. One of the two research objectives is to establish the applicability and value of the design models in the Indonesian context. The sub-question in the methodology description that was designed to help answer this question:

- What are the conclusions regarding the applicability and value of the design methodology in the Indonesian context?

This question contains some implicit assumptions that need further explanation before we can evaluate the design methodology.

The design exercise makes use of a number of models;

1. Metamodel for the design process
2. Merging Technological, Institutional and Process design (TIP-model)
3. Four layer model for institutional analysis
4. Stakeholder analysis for institutional analysis

Each of these models has its own use, applicability and value. The evaluation of the value of the design exercise therefore needs to include the use of all these models.

Furthermore the way that these models are used in the feasibility assessment deserves attention. The research framework is modelled after the Metamodel for design. The TIP-model is apparent in the way that the diagnosis and design phase include technological as well as institutional design. And the design of the systems also elaborates shortly the process that should guide the development. Important for the evaluation is the assessment of the actual use of the models in the feasibility study was correct, and if there could have been improvements in the practical application of these models. Figure 44 shows once more the research framework to exemplify these issues.

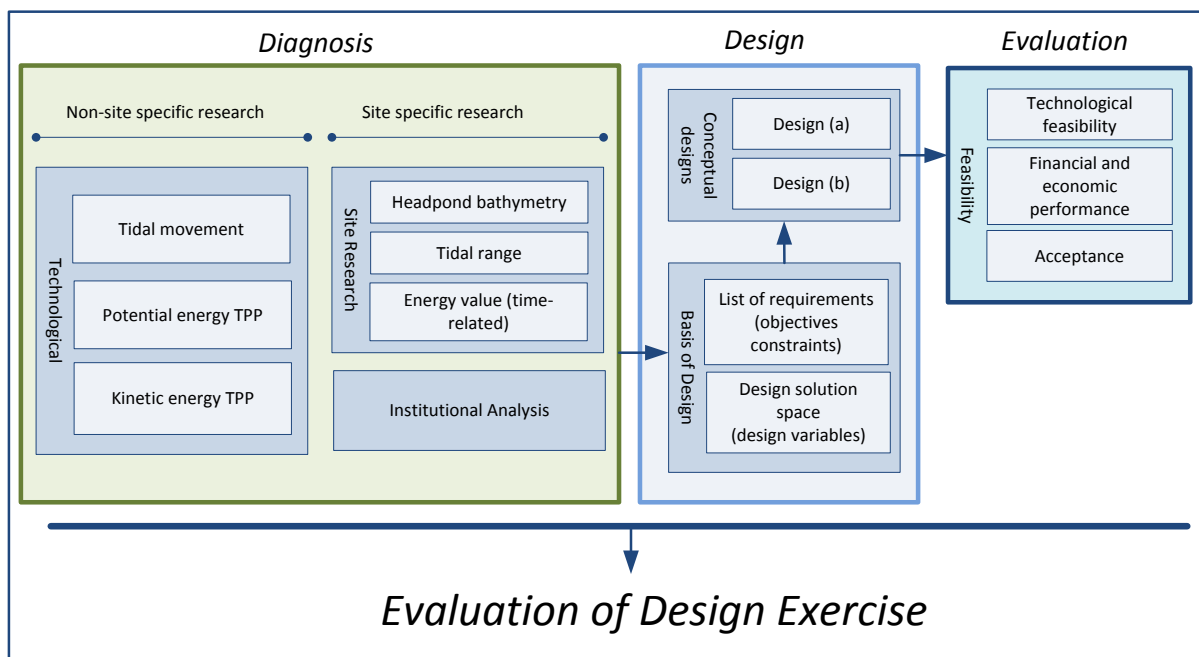
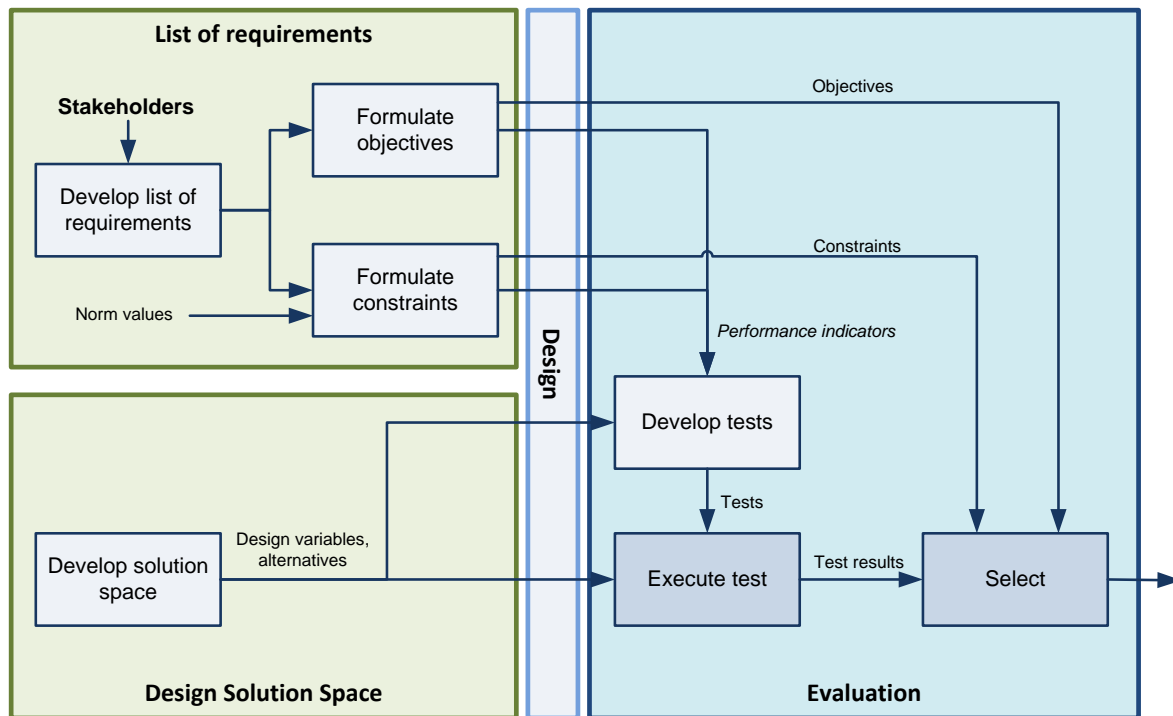

Figure 44 Research framework

The evaluation of the design exercise will be performed by analyzing the use of all the four models with regard to the incorporation into the feasibility study, Indonesian context, applicability and value.

10.1 Metamodel for the design process



The generic design model was first introduced by Herder and Stikkelman as the 'Generic conceptual design model' and used in the design and evaluation of a methanol-based industry. The theoretical background is based on the formalized heuristic approaches as described by French (French, 1971) and Hubka (1985). Hubka developed methodologies for thinking about design requirements (e.g. house of quality) and about the procedural steps of the design strategy. French focused on the fundamentals of design and analyzed the use of design methods and developed methods for optimization and functional analysis. Ideas from French can seem a bit outdated as much of the optimization methods are now so much easier to do with computers. Interesting with regard to this research is his assessment of the scope and nature of design methods. According to French, design methods may help by (French, 1971):

1. Increase insight into problems
2. Diversifying the approach to problems
3. Reducing the size of mental steps required in the design process
4. Prompting inventive steps, and reducing chances of overlooking them
5. Generating design philosophies for the particular problem in question

As was mentioned in the research methodology, the use of the design models will now be evaluated for these merits.

With regard to the feasibility study these are exactly the things that have followed from the design methodology. Especially the diagnosis phase helped with the insight into the design problem by identifying the design variables, design constraints and design objectives. The metamodel helps to think in a structured way about the problem. A non-structured approach to the design problem, as was performed by dr. Gindarsyah (See attachment B) results in an incomplete problem identification,

the outcome focuses solely on the issues that the designer thinks as important. The lack of a structured approach could mean missing out on important issues. For example, the initial problem identification assumes that the consumer price is similar to the possible cost of power production, while in fact the average cost of power production on Bangka is much higher. Furthermore the initial problem identification ignores the existence of tidal stream generation.

Diversifying the approach to problems is inherent to the identification of design variables. The approach used here was to see what could be done with the tidal stream potential in the Klabat bay. The experience from this project learns that a civil engineer would approach the issue as: Is it economically feasible to construct a tidal barrage power plant in the Klabat bay. While an offshore mechanical engineering student approaches the problem as: What kind of tidal stream unit could be designed in this location. The value of the metamodel is that it forces the designer to think about different options (design variables) with the aim to be exhaustive, after which a selection process decides what option appears to be the best. This process of divergent and convergent thinking is inherent in the metamodel for design and helps to diversify the approach to one particular problem. In a similar way this approach helps to prompt inventive steps, and reduces the chance of overlooking them (point 4).

When charged with the task to perform a feasibility study for tidal power generation in the Klabat bay the designer is overwhelmed with a large number of issues; e.g. What are the cost? What are the environmental impacts? What should the design look like? Many of these issues are interdependent, it is easy for the designer to lose track of the important issues. A structured approach helps to structure thinking. One problem that the author had with the generic design model is that its use is uncommon in infrastructural design. The approaches used by other tidal power feasibility studies were so different that it was hard to redesign the research framework in a way that was still suitable for tidal power engineering. When reading other feasibility studies it was hard to keep track of where a certain issue would fit into the generic design model. While the design approach helps to structure thinking and reduce the amount of mental steps, application to a field of study that is not used to such an approach requires the designer to be flexible in the use of previous studies.

These are the negative consequences of a divergent design approach as experienced during the case study:

- Adding very different alternatives to the design options makes the work more complex, and therefore less detailed. It invites the designer to analyze parts of the system which are not necessarily vital for the establishment of the feasibility. In the case of this project the feasibility was almost entirely depending on the potential of the tides.
- The author needs to get acquainted with a large range of specialist knowledge from different fields of research; Bathymetry analysis, tidal barrage design, tidal stream design, systems design.

The metamodel was important for the development of a design philosophy as it is the basis for the research framework and is useful for the application of both technological and institutional design. So the fact that it is a generic model allows for the application of the model to a large range of design problems.

In conclusion, the metamodel for design enables the designer to think in a creative, divergent manner about complex problems while offering a structured approach to do so. As it is a generic model it is applicable to almost every design problem. In relation to this case study there is definite

value in the identification of design variables and design requirements and thinking about conceptual designs and their evaluation. A downside of the divergent thinking is that it invites the designer to analyze options that might not be as relevant in hindsight. Also the design approach is not similar to the industry standard which means that the designer needs to redesign the design framework instead of copying the experience of previous projects. The actual design process, making the conceptual designs, is a part of the design cycle that is not explicit in the design model. The arrows in the design framework suggest sequential steps, while in reality the establishment of objectives, constraints, a solution space and combining these three 'blocks' is an iterative process.

10.2 Merging Technological, Institutional and Process design (TIP-model)

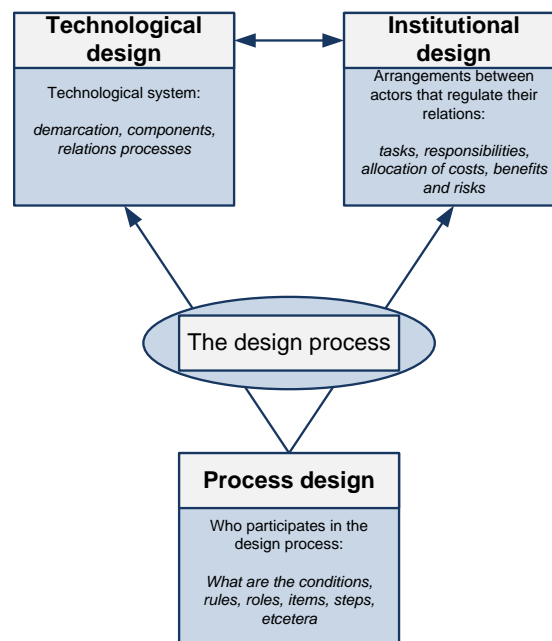

Koppenjan and Groenewegen describe the characteristics of complex technological systems that need institutional design. Before the design exercise the case study was classified as a complex technological system, during the design it was established that the problem owner had limited influence on relevant parts of the institutional environment. Koppenjan and Groenewegen do not define the power of the problem owner as important to the applicability of institutional design. The analysis of the institutional environment shows that the power of the problem owner is limited to the second layer of the four layer model. As a consequence important institutional characteristics cannot be changed by the problem owner, these are considered constraints in this report.

For example, the prices that PLN is able to pay for small scale renewable energy are regulated in the national political arena. Changing this constraint is outside the scope of this project because the stakeholders involved in the development of tidal stream in the Klabat are unable to change or influence these factors. Before a designer starts to do institutional design, the designer should ask himself the kind of influence that he can have on the institutional design.

The design however, is not completely determined by technology. The power of the designer is limited and as a consequence the applicability of the design model. A system of which the designer is able to design more than one layer is better suited for institutional design. This could be an extra characteristic requirement for systems that need institutional design.

The value of the institutional analysis was shown in the case study. The institutional environment has an important impact on the feasibility of both technological design options. In case of small scale tidal stream, the revenue is completely regulated by national policy. The tidal barrage option is much more dependent on how the tidal barrage plant is implemented into the local power grid. Ignoring these issues would result in an incomplete feasibility study.

A remark has to be made about the Indonesian context. As the author was unfamiliar with the institutional environment and unable to read and write documents in the Indonesian language, it is difficult to perform a good institutional analysis. For much of the information the author was dependent on sources such as the World Bank and the International Energy Agency. It is difficult to say how far the information available on paper coincides with reality.

In conclusion;

- The applicability of the TIP thinking was limited in the case study as the problem owner has limited influence on the institutional environment other than issues in layer 3 of the 4-layer model. It is therefore recommended to add the power of the designer as an extra requirement for the application of institutional design
- The value of merging technological, institutional and process design was shown in the fact that institutional issues had an important impact on the feasibility of technological design options. The institutional analysis and designs also showed the process options available for the development of power in Indonesia, these can be considered design options with different impacts on the feasibility.
- Unfamiliarity with the institutional context complicates institutional design for the designer. Difference in language and culture could result in missing important issues in institutional analysis and design.

10.3 Four layer model for institutional analysis

The model by Williamson is based on economic theory, transaction cost economics, and focuses on the transactions that people and organizations make. By adding the layer of the actors, and allowing for interactions between all layers, the model seems to lose some of the theoretical foundation. Now the model is primarily useful for the categorization of an institutional analysis, but as it is only a categorization, the designer is free to reshape the categories. As a result the model is applicable to virtually all forms of institutional analysis. The value has to be derived from the categorization of institutional issues.

As shown before, the stakeholders involved in the development of a tidal power plant have little influence on issues regarding the 1st, 2nd and 4th layer of the model. Therefore the applicability of the four layer model in the case study is limited to a demarcation of issues that are relevant for this particular case study. The formal and informal arrangements showed most relevant to the development of tidal power in the Klabat bay. Issues such as national policy objectives and incentive schemes are interesting from an academic perspective but not from the perspective of a tidal power development. Except from an investigative perspective as they offer system constraints for the world in which they operate.

As mentioned in the previous paragraph the Indonesian context and the origin of the designer is relevant for institutional design. This is also true for the application of the four layer model. Though

the four layer model does help to structure thinking about institutional design, regardless of the origin of the designer.

In conclusion;

- The four layer model as adapted by Koppenjan and Groenewegen departed from theoretical basis of the original model by Williamson. This has enhanced the applicability of the model and allows the application of stakeholder analysis into the model. However, in this way the model is useful for the categorization of institutional issues (which helps to structure thinking about institutional design and analysis) but has a fragile theoretical basis.
- The value of the model is in the categorization of issues. Institutional issues in different layers have generally different characteristics
- In the application to the case study the four layer model helped define the scope of the analysis

10.4 Stakeholder analysis for institutional analysis

An important part of the investigation of the institutional environment is the stakeholder analysis. Stakeholder analysis is a methodology typical to the SEPAM master. It is a form of analysis which has proven its value. With the help of a stakeholder analysis the problem owner is able to identify how he relates to other stakeholders and design a strategy (process) to accomplish his design objectives.

The value of performing a stakeholder analysis is obvious in the identification of how the problem owner relates to other stakeholders. It was shown in the case study that the stakeholder analysis allowed for the design of a strategy to deal with these dependencies. However, the validity of the stakeholder analysis is limited because of the background of the author. Assumptions made in the analysis are influenced by the cultural background of the author and available information is scarce because of the language barrier.

10.5 Personal reflection on execution of the project

During the kick-off of the project some project risks were already identified, these are now reflected upon:

- *'Things are different in Indonesia'* – Before the start of the project the author of this report had no experience with the culture and climate in Indonesia. From guidebooks and interactions with other people it was clear from the start that a graduation project in Indonesia would bring a particular set of challenges. Beforehand the specifics of the project set-up were also unclear (especially from the Indonesian side). Nevertheless the author chose to accept the challenge and accompanying risks.
 - Location – Jakarta is a vibrant metropolis (25 million people) that is developing at a very fast pace, driving around you can always see at least three skyscrapers under construction. Settling in an apartment and establishing contacts with the local people went relatively easy. I was aided by Rio Sastrosatomo, the employee of Andrea Peresthu, and he proved very valuable for this project.
 - Culture – Surely, during the project, many issues have escaped the authors attention because of a lack of understanding of the language, but also of the culture. Especially during the early stages of the project the finalization of the Memorandum of Understanding between PT Timah, Bangka regency, TU-Delft and Royal Haskoning involved meetings of which the purpose was not always clear. An important factor for the finalization of the MoU was the involvement of Andrea Peresthu, the involved people seemed willing to do him or the person he was representing a favor.
 - Culture (2) – Most Indonesian people were incredibly helpful, humble and polite. The author had so many positive experiences with people who were not only willing to help out, but really tried to go the extra mile. One example springs to mind; Late November 2011 I first visited the island of Bangka, the first two nights I was helped and shown around by the people from PT Timah. Anggi Siahaan, who worked as a public relations person for PT Timah was my guide. After we visited the Klabat bay and did some site measurements he even let me stay with his family for one night. A heartwarming experience. After that I was shown around the island by Edi Furma who volunteered, we got in contact through a website called couchsurfing.org. As I was really sick at that time (probably because of the malaria pills) his caring and enthusiasm for his island was truly great. We keep in touch occasionally and I let him stay in my apartment in Jakarta when he visited me in return. This all showed a kindness to strangers that I was previously unfamiliar with. An experience I will take with me for the rest of my life.
 - Chaos – Expect the unexpected when in Jakarta. The first experience of chaos that any visitor to Jakarta will have is with the traffic. This shows the chaotic nature of the city. Other examples include; 1. An office which was closed from one day to the next 2. Monthly visa extensions in a sweaty and overcrowded immigration office 3. Haggling for prices with the motor-cycle taxis, the fastest mode of transport around the city 4. Heavy rains, which turn the already chaotic traffic into an absolute mess. 5. Non-functioning air-conditioning in your non-ventilated room.
- *Language barrier* – The language barrier was an obvious risk at the beginning of the project. The author mostly had to rely on documents prepared by organizations such as the World

Bank, the International Energy Agency and USAID. Long and frequent conversations with Windrio Sastrosatomo helped to make some sense of the Indonesian documents and their translations. Interviews with people from PT PLN and interviews with dr. Abang Gindarsyah proved challenging because of the language barrier. With the help of these interviews (and google translate) the author was able to reconstruct the institutional processes involved in developing power in Indonesia.

- *Work load* – Already before the start of the project the author was aware that he would have to get acquainted with the specifics of tidal power engineering as well as the specifics of power development in Indonesia. This proved a hard task. Especially because the expected engineering back-up from another student disappeared early in the project. This meant an unfamiliarity with the subject matter and subsequent uncertainty.
- *Managing expectations* – Soon after I arrived in Indonesia it became clear to me that I would be presented in Indonesia as ‘a tidal power expert from the TU-Delft’ as opposed to a student writing his master thesis. This brought extra pressures to produce useful, reliable and professional results. This caused extra stress in combination with the fact that the author had to use specific kinds of models and approaches to the issue.
- *Complexity of the project set-up* – This project was set up with the help of PT Timah, Bangka Regency, Andrea Peresthu, CICAT Delft, DRI Delft, Kenneth Heijns, Royal Haskoning and initially two students and their supervising boards. The author advises students who start with a graduation project to keep the project set-up as simple as possible.

11. References

- Aquaret. (2008). Aquatic Renewable Energy Technologies. *Technology*, (December).
- Bahaj, A. S. (2011). Generating electricity from the oceans. *Renewable and Sustainable Energy Reviews*, 15(7), 3399-3416. Elsevier Ltd. doi:10.1016/j.rser.2011.04.032
- Banka Pos. (2009). Serumpun Sebalai. *Bangka Pos*. Pankalpinang.
- Bernshtein, L. B. (1996). *Tidal power plants* (2nd ed.). John Wiley and Sons Ltd.
- Bird, M. I., Taylor, D., & Hunt, C. (2005). Palaeoenvironments of insular Southeast Asia during the Last Glacial Period: a savanna corridor in Sundaland? *Quaternary Science Reviews*, 24(20-21), 2228-2242. doi:10.1016/j.quascirev.2005.04.004
- Blunden, L. S., Bahaj, a. S., & Aziz, N. S. (2012). Tidal current power for Indonesia? An initial resource estimation for the Alas Strait. *Renewable Energy*, 1-6. Elsevier Ltd. doi:10.1016/j.renene.2012.01.046
- Clark, R. H. (2007). *Elements of tidal-electric engineering. Library*. United States of America: John Wiley & Sons, Inc.
- Clean Technology Fund. (2010). *Clean Technology Fund Investment Plan for Indonesia. Renewable Energy*.
- Deltares. (2009). *Annex report: Tidal energy. Rivers*. Arnhem.
- EMEC. (2012). Tidal Developers. *The European Marine Energy Centre Ltd. - Tidal developers*. Retrieved from http://www.emec.org.uk/tidal_developers.asp
- Entec. (2007). *Tidal power in the UK: Research Report 2 - Tidal technologies overview. Contract*.
- Fay, J. A., & Smachlo, M. A. (1982). The performance of small scale tidal power plants (2). Cambridge: Massachusetts Institute of Technology.
- French, M. J. (1971). *Conceptual Design for Engineers* (3rd ed.). London: Springer.
- Herder, P., & Stikkelman, R. (2004). Methanol-Based Industrial Cluster Design: A Study of Design Options and the Design Process. *Industrial Engineering Chemical*, (43), 3879-3885.
- I Sachoemar, S., Kristijono, A., & Yanagi, T. (2007). Oceanographic characteristics of Klabat bay, Bangka island, Indonesia. *Marine Research Indonesia*, 32(2), 49-54.
- IAEA. (2011). *Country profiles: Indonesia*. Retrieved from http://www-pub.iaea.org/MTCD/Publications/PDF/CNPP2011_CD/countryprofiles/Indonesia/Indonesia2011.htm
- International Energy Agency. (2008a). *Energy policy review of Indonesia*. Paris.

- International Energy Agency. (2008b). Energy policy review of Indonesia. Paris.
- International Energy Agency. (2011). *Technology roadmap - Geothermal heat and power. Energy Policy*. Paris: International Energy Agency.
- Israel, B. (2010). No Title. *Our amazing planet - Indonesia's explosive geology explained*. Retrieved from <http://www.ouramazingplanet.com/484-indonesia-geology-explained-earthquake-volcano-101026.html>
- Koppenjan, J., & Groenewegen, J. (2005). Institutional design for complex technological systems. *International journal Technology, Policy and Management*, 5(3), 240-257.
- Kusuma, R. R. (2010). Indonesian Government Eyeing Bangka Island for 2 Nuclear Power Plants. *Jakarta Globe*. Retrieved from <http://www.thejakartaglobe.com/bisindonesia/indonesian-government-eyeing-bangka-island-for-2-nuclear-power-plants/403789>
- Langston, W. J., Jonas, P. J. C., & Millward, G. E. (2010). The Severn Estuary and Bristol Channel: a 25 year critical review. *Marine pollution bulletin*, 61(1-3), 1-4. Elsevier Ltd. doi:10.1016/j.marpolbul.2009.12.009
- Lee, K. S. (2006a). Ocean Energy Development in Korea. *Energy*, (November). Korea ocean research& development institute.
- Lee, K. S. (2006b). Tidal and Tidal Current Power Study in Korea. *Energy*. Korea ocean research& development institute.
- Luner Energy Ltd. (2008). Renewables boost as Lunar Energy seals £500m deal. *Renewables boost as Lunar Energy seals £500m deal*. Retrieved from <http://www.lunarenergy.co.uk/News.php>
- Macmillan, S. (2001). Development and verification of a generic framework for conceptual design. *Design Studies*, 22(2), 169-191. doi:10.1016/S0142-694X(00)00025-9
- Maps.google.com. (2012). Indonesia, Bangka - scale undetermined, accessed by Niek de Groot. Retrieved August 5, 2012, from <https://maps.google.com/maps?q=indonesia+bangka&hl=en&ll=-1.649781,105.805893&spn=0.603309,1.056747&sll=1.453473,125.031281&sspn=0.603364,1.056747&hnear=Bangka+Island&t=m&z=11>
- Mooyaart, L. (2009). Haalbaarheidsstudie naar een getijcentrale langs de Westerschelde. *CITG, Hydraulic*. Delft: TU-Delft.
- O'Rourke, F., Boyle, F., & Reynolds, A. (2009). Tidal energy update 2009. Dublin: Dublin Institute of Technology.
- Powertech labs Inc. (2009). Ocean energy: Global technology development status - Implementing agreement on ocean energy systems . Surrey: International Energy Agency.
- PriceWaterhouseCoopers. (2011). *Electricity in Indonesia - Investment and Taxation Guide*.
- Provinsi Kepulauan Bangka Belitung. (2011). Produk Domestik Regional Bruto. *webpage*. Retrieved from <http://www.babelprov.go.id/>

- Pt. PLN. (2010). Rencana Usaha Penyediaan Tenaga Listrik PT PLN (Persero) 2010-2019. (P. P. L. N. (Persero), Ed.) ISBN: 978-979-1203-14-2. Jakarta.
- Pt. Timah. (2010). ANNUAL REPORT 2010- Enhancing quality, achieving glory.
- Pulse Tidal. (2012). No Title. <http://pulsetidal.com/our-technology.html>. Retrieved May 2, 2012, from <http://pulsetidal.com/our-technology.html>
- Purwono, J. (2008). Perkembangan Penyediaan Tenaga Listrik Nasional.
- Rachmayani, R., Atma, G., Suprijo, T., & Sari, N. (2006). Marine Current Potential Energy for Environmental Friendly Electricity Generation in Bali , Lombok and Makassar Straits, 1-10.
- Ray, R., & Egbert, G. (2005). Tides in the Indonesian Seas. *Oceanography*, 18(4), 74-79. Retrieved from <http://scholar.google.com/scholar?hl=en&btnG=Search&q=intitle:Tides+in+the+Indonesian+Seas#6>
- Republic of Indonesia. (2009). Presidential Decree No. 59 of the Republic of Indonesia, amendment of presidential decree No. 71 . Jakarta.
- Swane, H., & Stive, P. dr. ir. M. J. F. (2007). Tidal power plant in Saemangeum. *Hydraulic Engineering, Hydraulic*, 136. Delft: Technische Universiteit Delft.
- The Crown Estate. (2011). *Wave and dal energy in the Pentland Firth and Orkney waters : How the projects could be built*.
- The World Bank. (2009). *Indonesia development policy review - enhancing government effectiveness in a democratic and decentralized indonesia*. (B. D. The world Bank, Ed.) *Investing in Indonesia Institutions for inclusive and sustainable development*. The World Bank.
- Tidalenergy Ltd. (2012). No Title. http://www.tidalenergyltd.com/?page_id=640. Retrieved from
- Timah. (2012). Vision, Mission, Value. Retrieved from www.timah.com
- Twidell, J., & Weir, T. (2006). *Renewable Energy Resources*. Taylor & Francis.
- Westerberg, A. W., Subrahmainan, E., Reich, Y., & Konda, S. (1997). Designing the process design process. *Computers & chemical engineering*, 21, S1-S9. Elsevier. Retrieved from <http://www.sciencedirect.com/science/article/pii/S0098135497874704>
- Williamson, O. E. (2000). The new institutional economics: taking stock, looking ahead. *Journal of economic literature*, 38(3), 595-613. JSTOR. Retrieved from <http://www.jstor.org/stable/2565421>

Attachment A: Stakeholder analysis

The term stakeholders was derived from 'stockholder' and is meant to represent groups that have an interest in decision making in an organization or for a project. Stakeholder theory was first developed to help organizations deal with the organization of activists, increased governmental influences, globalization, aggressive media and a loss in trust of the business world in general (R.E. Freeman 2001). A stakeholder analysis can be performed to define stakeholders, to classify stakeholders or a combination of the two. In this case the aim is to identify stakeholders that have an interest in tidal power development in the Klabat bay en to classify their involvement. A good approach for such a project is described by Enserink et al. (2003). The approach names 6 steps for the identification and classification of stakeholders.

- Formulation of a problem
- Inventory of involved stakeholders
- Representation of formal tasks, competences and relations of stakeholders and laws and regulations
- Assessment of the interests, goals and problem perceptions of stakeholders
- Mapping dependencies between stakeholders by making an inventory of resources and subjective involvement of actors with the problem
- Assessment of the consequences of these findings for the formulation of the problem

The aim of the actor analysis is threefold:

4. Establish whether the problem formulation of the problem owner is sustainable considering the perceptions of other stakeholders
5. To help design a strategy for the problem owner to deal with dependencies on other stakeholders in the political arena
6. Identification of relevant open questions about governance

Formulation of a problem

A problem description assumes a problem owner. In this case we assume the local regency as the problem owner. The local regent was the person interested in this report. The Bangka regency (capital Sungailiat) experiences electricity shortages and the cost of electricity production are high, the source is mainly diesel. The Klabat bay, central to the region, was identified as a possible source of renewable energy development. The problem the regent is faced with is how to make such a project come about. The technical and economic feasibility are only part of the question, whether one is able to conjure up the right infrastructure to work out the economics is just as important.

The problem formulation focuses solely on the issue of tidal power development in the Klabat bay. The problem owner would like to know if the prospect of tidal power development in the Klabat bay is feasible. Engineers have discovered that there is a heavy draft from the tides in the Klabat bay and would like to utilize this energy. The local regent has taken up this proposition in cooperation with Andrea Peresthu. Together they set out to find the knowledge and information necessary to investigate the feasibility.

This actor analysis will help redefine the formulation of the problem and help answer the question:

Who are, from the perspective of the Sungailiat regency, the relevant actors to involve in the development of a tidal power plant in the Klabat bay?

In order to do so we will establish the main actors resources, their substitutability, the importance of their resources and whether they have aligned or opposite objectives.

Inventory of involved stakeholders

An inventory of the involved stakeholder lists all the stakeholders who are actively involved, have the power to influence the development process, control important resources, have a desire to be involved in the process or are influenced by the outcome of the process. The list of stakeholders and their perceptions is not a fixed list. Over time, the involved stakeholders and perceptions may change.

Stakeholder	
Government of Indonesia (GOI)	Cabinet headed by the president
President of Indonesia	Both head of state and head of government. Much of the legislation coming from parliament give directions and norms, but often lack detail. The detail is later provided by the implementation of presidential decrees. Currently Susilo Bambang Yudhoyono (SBY) is serving his second five year term 2009-2014. http://www.indonesia.go.id/en/united-indonesia-cabinet/ministers.html
People's Consultative Assembly (MPR)	The highest state institution. Consists of the 550 members of the People's Representative Council (DPR) plus 130 'regional representatives' elected by the twenty-six provincial parliaments and sixty-five appointed member from societal groups. Functions include electing the president and vice-president, establishing broad guidelines of state policy and amending the constitution.
People's Representative Council (DPR)	The premier legislative institution consisting of 550 representatives. Having served as a rubberstamp body in the past, the DPR has gained considerable power and are increasingly assertive in oversight of the executive branch. http://en.wikipedia.org/wiki/Politics_of_Indonesia#cite_note-Denny361362-2
National Energy Council	A national, independent, and permanent body whose main responsibilities relate to the formulation of a national energy policy. Chaired by the President and Vice President. Day to day chair is the Minister of MoEMR. The council consists of 7 government officials and 8 stakeholders. http://carpedieminonesia.blogspot.nl/2008/08/national-energy-council.html
Ministry of Energy and Mineral Resources (MoEMR)	The ministry which regulates the energy sector. The ministry sets out a 10 year estimate of power demand and supply, the investment and funding policy and the approach to the utilization of new and renewable energy resources. The MoEMR regulates the activities of Pt PLN and has to approve PLNs yearly development program. (PriceWaterhouseCoopers, 2011). The abbreviation in bahasa Indonesia is ESDM. http://www.esdm.go.id/
Other relevant ministries	Before the appointment of the National Energy Council energy policy was the responsibility of a board called National Energy Co-ordination Board (BAKOREN) which was seen as ineffective. This council was chaired by MoEMR and participating members were a subset of the government's fifteen economic ministries that have a special relevance to the energy sector. Among which the Ministry of Industry, Ministry of Communications and informatics, Ministry of Finance, Ministry of Environment, Ministry of

	<p>Research and Technology, Chairperson of the National Development Planning Agency (head of BAPPENAS). These ministries represent their interests in the development of national energy policy.</p> <p>http://den.go.id/index.php/page/readPage/2</p>
Constitutional Court	<p>Tests new laws on coherence with the constitution. Annulled the proposed 2002 liberalization and unbundling laws on the basis of electricity production being of national importance.</p>
Institutional investment funds	
PT Sarana Multi Infrastruktur (PT SMI)	<p>PT SMI is a 100% government (GOI) funded vehicle for financing infrastructure projects. Its objective is to be a catalyst in the acceleration of infrastructure development in Indonesia. It is able to provide an alternative source of funding to finance projects and aims to promote Public Private Partnerships.</p> <p>http://www.ptsmi.co.id/establishmentpurpose.php</p>
PT Penjaminan Infrastruktur Indonesia (PT PII)	<p>A well funded guarantee fund started in 2010 which is able to provide financial guarantees for infrastructure projects. The SMI fund participates in this fund as well. It is majority privately owned with the initial shareholders being established institutional investors as the Asian Development Bank (ADB), International Finance Corporation (IFC), Deutsche Investitions und Entwicklungsgesellschaft mbH (DEG) and open to investments from other private investors. The objective of the PII is to increase the availability of infrastructure financing sources with long tenor characteristics. PT IIF will provide funding towards commercially feasible infrastructure projects through debt instruments, equity participation or infrastructure financing guarantee for credit enhancement.</p> <p>http://www.ptsmi.co.id/pressrelease.php?bid=16&action=view</p>
Bangka-Belitung provincial governance	<p>The government of Bangka-Belitung (often referred to as BaBel). The province is headed by the governor. The province has its own legislative body (Dewan Perwakilan Rakyat Daerah). The governor and representative members are elected by popular vote for a 5-year term.</p>
Bangka Regency representatives	<p>The Bangka-Belitung islands are administratively divided into 6 districts and one city. The island of Bangka is divided into four regions and a city. This report was initiated with the help of the Bangka regency of which Sungailiat is the capital. The regency is headed by the regent (Bupati). The regent and representatives are elected for a 5-year term. The local regencies enjoy more responsibilities than the province, such as providing public schools and public health facilities.</p>
Bangka inhabitants	
Bangka Klabat bay fishermen	<p>Around the Klabat bay there are small congregations of fishermen. The construction of a dam or barrage could negatively affect the fish population and impede access to sea from the Klabat bay. Their business and livelihoods could be negatively affected. At this point the size of these settlements and their importance to the Bangka regency is unclear.</p>
Other inhabitants	<p>The inhabitants of Bangka-Belitung are formally represented by their local,</p>

	regional and provincial representatives. The inhabitants of Bangka-Belitung are a culturally diverse group of people with the majority being Malay, and significant portion of people with Chinese heritage and Javanese and Sumatra heritage. There are still many people without a connection to the power grid, and if they do have a connection there are frequent black-outs or scheduled down times. Availability of a constant, affordable and reliable electricity supply would greatly improve living standards on the island.
PT Timah	Former national tin mining company. Tin mining is of major importance to the economy of Bangka-Belitung. Pt. Timah is co-sponsor of this research. Pt Timah owns and operates a number of diesel power plants. For their operations they are dependent on a reliable and affordable electricity supply.
PT PLN	National electricity company. Holds 90% of all power production facilities and all infrastructure. The government provides the organization with goals and means. The paragraphs about institutional arrangements and legal framework already provide a detailed description of PLN's responsibilities and objectives.
Engineering firms	Engineering firms have an interest in providing feasibility studies and/or the development of artifacts. In the case of tidal stream the engineering firms have a strong desire to develop a proof of concept.
Non-Governmental Organizations (NGO's)	Could provide funding, help organize local stakeholders, can attract media attention
Science/Universities	National and international knowledge institutions can learn, participate and provide knowledge
Tourism industry	The installation could attract 'green' tourism or provide surfing and diving opportunities

Some of the identified stakeholders may hold different views within their categorization. For example there are different NGO's with different objectives, for example NGO's that focus on the environment and NGO's that focus on the representation of people with little education. A similar argument could be made for 'other inhabitants'. For this analysis it was chosen to group these stakeholders together for simplicity.

Representation of formal tasks, competences and relations of stakeholders and laws and regulations

The identified stakeholders have formal and informal relationships. The representation of formal tasks, competences and relations of stakeholders and laws and regulations are identified in the figure below:

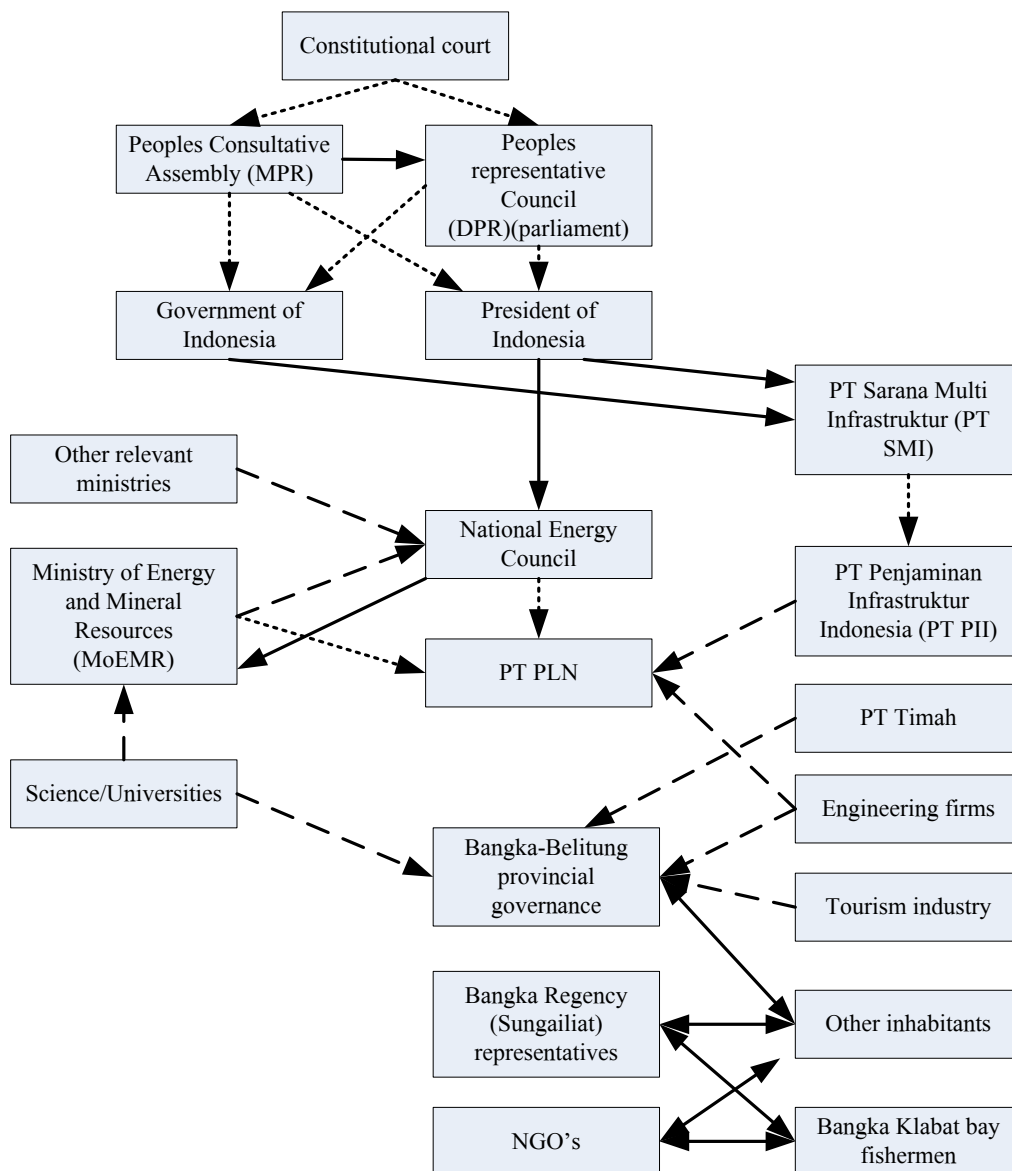

Map of the formal relations (double arrow: representation, single arrow: hierarchical relationship, dotted line: controlling relationship, Striped line: Influencing relationship)

The Bangka regency (capital Sungailiat) is the lowest governmental office. However it has more formal tasks and competences than the provincial Government of Bangka-Belitung. The national government governs all of Indonesia and sets out the energy policy objectives.

PT. PLN executes the plans of the Ministry of Energy and Mineral Resources (MoEMR). The legal framework and arrangements are the topic of paragraph 5.2 and 5.3

Assessment of the interests, goals and problem perceptions of stakeholders

The table on the next page presents the interests, goals and problem perceptions of stakeholders. These were established using the information available on websites and year reports if possible. If this information was not available an estimation of the positions was made. After a more broad analysis some of the stakeholders are excluded from further analysis. Their level of involvement is judged as minor or they are already represented by other stakeholders in the analysis. The MPR, DPR,

other relevant ministries, the constitutional court and the tourism industry are excluded from further analysis.

Stakeholder	Interest	Desired objective	current or expected situation	Causes	solutions
Government of Indonesia	Support investment in infrastructure, support national industries, provide for the people	Sound implementation of energy policies	PLN has been granted a mandate to invest heavily in as much power development as possible	Limited resources for complex projects, PLN will have to develop fast, cheap and clean if possible	Not aware of the opportunity, a need for lobbying and information provision
President of Indonesia	Support of national industries, protect image of Indonesia	Sound implementation of energy policies, progress for Kyoto objectives	Right appropriation of infrastructure investment funds by PLN, development of renewable	Infrastructure investment important part of policy, renewable investment in international political arena	Not aware of the opportunity, a need for lobbying and information provision
National Council	Develop and implement sound energy policies	Sound implementation of energy policies	It will be difficult to meet objectives concerning renewable energy, though tidal power is not key policy	Focus for renewable is on biomass (palmoil), geothermal and small scale hydro. The rest of policy is aimed at fast and cheap development of conventional power	Researching the national potential of tidal power in Indonesia, making the Klabat bay an example
Ministry of Energy and Mineral Resources (MoEMR)	Develop and implement sound energy policies, regulate the power market	Sound implementation of energy policies, development of as much power capacity as possible	MoEMR will only give approval for construction if criteria about costs and benefits are met	Responsible body for controlling PLN operations	Researching the national potential of tidal power in Indonesia, establishing possible feasibility
PT Sarana Infrastruktur Multi (PT SMI)	Provide funding and support for infrastructure development of national importance	Development of tidal power plant in the Klabat bay with Public Private Partnership	Constructing a TPP is an opportunity for a poster project participation	SMI is a new fund with a lot of resources looking for application. Not many projects meet its criteria	Align project with participation criteria
PT Penjaminan Infrastruktur Indonesia (PT PII)	Provide funding and support for infrastructure development	Development of tidal power plant in the Klabat bay with Public Private	Constructing a TPP is an opportunity for a poster project	PII is a new fund looking for investment opportunities in	Align project with participation criteria

		Partnership	participation	infrastructure		
Bangka-Belitung provincial governance	Increase investment in the island, improve infrastructures, improve profile of the island	Affordable and reliable electricity generation for as many people as possible	Interesting project if interests of pt Timah, fishermen and inhabitants are well looked after	Little funding available (limited taxing power), Pt Timah important party on the island. Interesting for promotion	Find support from Pt Timah, take care of interests fishermen and inhabitants in process design	
Bangka Regency representatives	Provide people with affordable and reliable electricity	Affordable and reliable electricity generation for as many people as possible	Good investment in the region, affordable electricity	Wishes to lower energy production cost, striving for investment from Jakarta	Lobby with Jakarta	
Bangka Klabat bay fishermen	Protect livelihoods	No change in situation	Less fish in the pond, loss of access and exit possibility through the bay	Fishing yields threatened	Difficult. Negatives will have to be off-set in a different manner	
Other inhabitants	Improvement in electricity infrastructure, low taxes	Access to affordable and reliable electricity	Investment in the island, jobs, improved electricity supply	Currently limited electricity supply, would like to use washing machines	Objectives already aligned	
PT Timah	Ensure business continuity, improve production conditions, improve standards of living on Bangka	Access to affordable and reliable electricity, improve corporate social responsibility profile	Investment in the island, stable power supply, loss of access to the bay	Investment in Bangka is good, so is a stable energy supply. Mining operations could be threatened	Negotiate planning for mining operations, make supply contracts, pay for diesel back-up	
PT PLN	Develop production capacity and improve infrastructure	Build as much capacity as possible	Interesting development. Demand for already scarce resources, complex project for the amount of power, adding investment is always positive	Large organization, even larger objectives, stress on the organization, added investment is always a bonus. Allowed to make a return	Private participation, find added budget for this specific project, coupling with other investments on the island	
Engineering firms	Execute projects	Construction of a tidal power plant	Interesting project for development of technology, profit and	Immature technology in case of stream, so an opportunity to	Early involvement, improve infrastructure on the island	

			participation	develop	(hotels, roads, harbours)
Non-Governmental Organizations (NGO's)	Represent under-represented voices, prevent misconduct, prevent environmental damage	The interests of all inhabitants of Bangka Belitung well represented, minimal environmental damage	The young decentral democracy unable to look after the interests of the less well off. Environmental damage	Construction of a dam is such a large project that smaller economic interests are not represented	Early outlook for other interests
Science/Universities	Increase research budgets, provide knowledge	Construction of a tidal power plant	Participation for technology development, creating a knowledge centre.	Less focus on cost, more on opportunity, Indonesia could become an Asian front runner	International cooperation, external funding
People's Consultative Assembly (MPR)	marginal				
People's Representative Council (DPR)	marginal				
Other relevant ministries	Marginal				
Constitutional Court	Marginal				
Tourism industry	marginal				

Mapping dependencies between stakeholders by making an inventory of resources and subjective involvement of actors with the problem

The interests, perceptions and involvement of the stakeholders are listed in the previous paragraph. Now for every stakeholder their resources, substitutability and importance of their resources for the stakeholder are assessed. If an actor is judged to have access to important resources and is irreplaceable it is judged to be 'a critical actor'. Without the involvement of such an actor and the commitment of its resources it will not be possible to solve the problem situation. Therefore it is vital to align perceptions and convince critical actors of the importance and solutions of the problem situation.

Stakeholder	Resources	Substitutability	Importance of resources	Critical actor
President of Indonesia	<ul style="list-style-type: none"> - Formal powers - Head of the Energy Council - Central position in cabinet - Access to media - Personal qualities and informal contacts 	Not in short term, but has an ending political mandate	Great	His public support would make a big difference but is non-vital
National Energy Council	<ul style="list-style-type: none"> - Formal powers - Could add tidal power to the national energy policy agenda 	Irreplaceable	Limited	Limited
Ministry of Energy and Mineral Resources (MoEMR)	<ul style="list-style-type: none"> - Regulating PLN - Co-designs energy policy - Reviews power plant proposals - Formal powers 	Irreplaceable, has to sign off on the project as the regulator	Great	Yes
PT Sarana Multi Infrastruktur (PT SMI)	<ul style="list-style-type: none"> - Organization of investors - Access to government - Access to capital 	Difficult to replace as it would be hard to find capital and such access to politics and organization	Great	Somewhat
PT Penjaminan Infrastruktur Indonesia (PT PII)	<ul style="list-style-type: none"> - Access to large (private) institutional investors - Access to project planning resources - Access to capital 	Difficult to replace as it would be hard to find capital and such access to politics and organization	Great	Somewhat
Bangka-Belitung provincial governance	<ul style="list-style-type: none"> - Formal powers - Access to (national) agenda - Knowledge and expertise about local environment - Relations with local industry 	irreplaceable	great	yes

	<ul style="list-style-type: none"> - Permitting powers - Participation in decision making 				
Bangka Regency	<ul style="list-style-type: none"> - Knowledge and expertise about Klabat bay environment - Permitting (?), facilitating role in construction - Participation in decision making - initiative 	Irreplaceable, but politically vulnerable	Necessary	Yes	
Bangka Klabat bay fishermen	<ul style="list-style-type: none"> - Lobbying - Provides employment (economic argument) 	Irreplaceable	Limited	no	
Other inhabitants	<ul style="list-style-type: none"> - Lobbying - Access to (local) media 	Irreplaceable	Limited	no	
PT Timah	<ul style="list-style-type: none"> - Lobbying - Could have purchasing power - Access to local and national political arena - Possibly capital - Blocking power 	Irreplaceable	Considerable	yes	
PT PLN	<ul style="list-style-type: none"> - Formal power - Knowledge and expertise - Designs Bangka energy planning - Ability to develop coal/nuclear on Bangka - Execution power - Blocking power 	Irreplaceable	Great	yes	
Engineering firms	<ul style="list-style-type: none"> - Knowledge and expertise - Lobbying 	Replaceable	Great	no	
Non-Governmental Organizations (NGO's)	<ul style="list-style-type: none"> - Lobbying - Access to media (independent) research - Start indictments 	Irreplaceable	Depends on level of involvement	Depends on level of involvement	
Science/Universities	<ul style="list-style-type: none"> - Knowledge and expertise 		Limited	no	

Consequences of these findings

The findings of the stakeholder analysis are summarized in the table below. There is a long list of critical stakeholders that are vital to the success of the project. Some of these are non-dedicated to the problem issue, some have are not familiar enough with the problem issue to take a position.

	Dedicated stakeholders		Non-dedicated stakeholders	
	Critical	Non-critical	Critical	Non-critical
Aligned perceptions, interests and objectives	<ul style="list-style-type: none"> - MoEMR (Uncertain!) - Bangka-Belitung provincial governance - Bangka regency - PT Timah (Uncertain!) - PT PLN 	<ul style="list-style-type: none"> - Engineering firms - Science/Universities - Other inhabitants 	<ul style="list-style-type: none"> - PT. SMI - PT. PII - 	<ul style="list-style-type: none"> - National energy council - President of Indonesia
Opposite perceptions, interests and objectives	<ul style="list-style-type: none"> - MoEMR (Uncertain!) - PT Timah (Uncertain!) 	<ul style="list-style-type: none"> - Bangka Klabat bay fishermen 	<ul style="list-style-type: none"> NGO's 	

The investment funds PT SMI and PT PII that have a strong financial and organizational backing from national government and institutional investors such as the IMF and World Bank are currently unaware of the project. These funds are identified here as ‘almost’ critical. They are not irreplaceable, there are other sources of funding, however their access to capital and manner of organization would make them a very strong asset towards constructing a tidal power plant.

The positions of two critical actors are unclear from the present analysis. The Ministry of Energy, Minerals and Resources has to judge the project on the criteria that it has for power developments. As the feasibility study is currently insufficiently detailed the MoEMR is unable to form an opinion on the subject. Convincing the MoEMR of the necessity and feasibility of the project is vital as the MoEMR controls the permitting process. The position of PT Timah is also unclear. PT Timah is one of the co-sponsors of this feasibility study which suggests an alignment with its objectives. However, during field research it was established that PT Timah has significant mining operations on the inner Klabat bay. The size, importance and depletion of this site will decide the position of PT Timah. They are currently using a large vessel that dates back to the colonial era, this vessel will not be able to enter or exit the inner Klabat bay in case a dam was constructed. There was another vessel stationed in the lake which was not in use anymore, this would also have to move, otherwise it would have to be disassembled in this location. In case of a tidal stream development the issue would be minor. The impact of NGO's on the development process is unclear at the moment. NGO's could have blocking power using their access to the media and starting legal procedures. Whether large influential NGO's are interested in this project depends on the development over time. An early outlook for their interests could dampen their enthusiasm to block the development.

The local fishermen and inhabitants of the region have little resources except their representation in local government and access to local media. Therefore their position is currently judged as non-critical. This does not mean that they are irrelevant, it just means that they have little power to change the development. In fact these stakeholders are directly affected by the impacts of a development, positive and negative.

Attachment B: Initiating document dr. Abang Gindarsyah

IDENTIFYING THE POTENTIAL OF RENEWABLE ENERGY IN THE ISLAND OF BANGKA

1. **Energy Source:** Tidal (wave) Energy
2. **Location :** Bay of KLABAT – BLINYU Region, Northern part Bangka

3. **Brief description:**

The bay of Klabat is a lagoon-like bay with a narrow "entrance" and a large, wide bay behind it.

When the tide moves in through the narrow gorge it results in a strong current inwards, and likewise during ebb, a similar strong current pushes the water out to sea. This huge amount of water moving in and out through a narrow gorge is a source of kinetic energy which could be applied to generate Electric energy through the installation of the proper turbines and generators.

Building a barrier across the gorge could create a required head and concentrate the water in and out flow but will also restrict the entrance of the Bay of Klabat.

Application of this renewable energy has been known for some time already and has been / is being utilized abroad like the USA, France, England and Australia.

4. **Estimate of potential Electric power generation**

Data assumption:

- Tidal height difference (h) : 2 m
- Water surface of the bay area behind the gorge (A) : 150 km²
- Sea water density (r) : 1025 kG/m³
- Gravity : 9,8

Potential Energy : $E = \frac{1}{2} Argh^2$

$$= \frac{1}{2} (150.000.000)(1025)(9.8)(2.2)$$

$$= 3.013.500.000.000 \text{ Joule}$$

Duration of tide/ebb: 8 hours = $8 \times 60 \times 60 = 28.800$ seconds

Electric Energy potential: $3.013.500.000.000 \text{ Joule} / 28.800 \text{ seconds}$

$$= 104.635.416 \text{ Watt} = 105 \text{ MW}$$

Considering a conversion efficiency of 30% will give us a potential of

$$\begin{aligned} P &= 105 \text{ MW} \times 30 \% \\ &= 31.4 \text{ MW} \end{aligned}$$

5. Economical considerations

Potential of Electricity to be generated:

-Tidal period is 8 hrs per day

-Electricity generated $31.400 \times 8 = 251.200$ kWh per day

-Assuming 365 operational days per year, production could be 91.688.000 kWh per annum.

Potential of sales at Rp 700,- / kWh (PLN tariff) = $91.688.000 \times \text{Rp } 700,- =$

Rp. 64.000.000.000,- per annum

This potential needs to be further investigated in order to obtain reliable data to determine the actual potential:

- a. Actual water volume moving in and out during the tide (Q)
- b. Tidal Water level difference (h)
- c. Water surface behind the gorge barrier (A)
- d. Determine the appropriate Turbine type

6. Pro and Contra

1. Construction of a costly barrier the width of the gorge (between the old MANTUNG Steam power plant and the TANJUNG RU – Bakit), approximately 2 km.
2. This barrier / dam could also double as a bridge connecting Mantung and Tanjung Ru (an additional advantage)
3. This barrier could disturb the daily activities of fishermen around the bay area. A survey should be made to investigate the socio-economic impact on the local population.
4. Possibly alternative technical solutions, e.g. offshore turbines, Vertical axis turbines, Gorlov Turbines, etc., could make it unnecessary to construct the barrier. It is understood that these technologies are still in a development stage and limited seize.

7. Bangka-Belitung(BaBel) province's strategy in energy development

Presently PLN supplies the total power requirement of the BaBel province, in particular Bangka island, approx. 77 mW, completely generated by Diesel Generator sets. Peak load in Bangka is around 67 mW, so that PLN's reserve is only 10 mW or approx. 15%.

Especially for Diesel Power Plants this is too small a reserve, thus we should expect frequent outages due to maintenance or breakdowns. The list of new applicants / customers exceeds 20 mW, or in other words Bangka is facing an energy crisis. It is observed that this crisis will continue for a couple more years. PLN's efforts to build new Power Plants in Bangka have failed, so far, so that it will have to do with what is available now. This power shortage is not only felt by the local population, but also reduces investor's interest in BaBel further reducing economic growth.

The existing Power Plants are not expected to last much longer as almost all are Diesel engine driven consuming expensive HSD/MFO, resulting in costs of Rp. 3.000,-/kWh. The average age of Diesel engines at PLN and the Tin mines is more than 15 years, thus unreliable and frequent breakdowns. Finding alternative sources is a must.

PT Timah's plan to construct gas-burning power plants, so far has not been realized as LNG or CNG are not readily available for local consumption and/or expensive (Rp. 2.500,-/kWh) as well. Gas is considered economical if "piped in" not transported as "compressed".

Steam power plants(coal fired) seem to be more attractive because of the lower (operational) cost, however the current "green" trend seem to make it more difficult to obtain cheap(er) financing (soft loans), in particular from European banks. Seeking loans from non European banks is even more difficult and more costly (higher interest rates), making steam power plants more expensive.

Another alternative could be the construction of power plants burning trash/refuse, especially in the city areas, this would at the same time solve the proper handling of city trash. In the remote areas refuse from the palm-oil plantations could be the solution, but then again it is already a well accepted source of "fuel" in the palm-oil industry.

Nuclear plants could be an even cheaper solution, however is still considered "dangerous", and therefore to be considered as a last source. Additionally the tourist industry could also suffer.

Facing this Energy crisis, the BaBel province's local government should involve experts e.g. BPPT and others who can assist in developing the renewable energy resources. One of the first could well be the Klabat bay – Belinyu tidal wave project, which could become a long term solution in providing Electricity to the BaBel province.

Jakarta, November 26, 2008

Abang Gindarsyah.

Attachment C: Tides

When spending a day at the beach one can see the water level rise and retreat. This is called tidal movement and is mainly caused by the gravitational pull between the earth, moon and sun. Knowledge of the physiological properties of tides will allow for a better exploration of possible methods to extract energy in the Klabat bay. Therefore this attachment aims to explain tides in further detail. The existence of tides is a physical phenomena which has been described in detail by many sources. For this summary the book of Bernshtein about tidal power plants and the thesis papers of Mooyaart and Swane have been used as input.

The powers that move the earth (and it's oceans)

Before Newton came up with the law of gravitation, people were unable to explain tides. The law of gravitation states that every massive particle in the universe attracts every other massive particle with a force that is directly proportional to the square of the distance between them. The gravitational forces keep the sun, earth and moon orbiting around each other. Since the force is proportional with distance, obviously the earth has the largest attraction to the water that covers the earth. The moon as the nearest body in the universe has the largest 'pull' on the water and is therefore the largest force causing the tides. The characteristics of the tides are caused by the following four factors:

1. Attraction of the moon
2. Rotation of the earth
3. Attraction of the sun
4. Geometrics of the earth
(Mooyaart 2009)

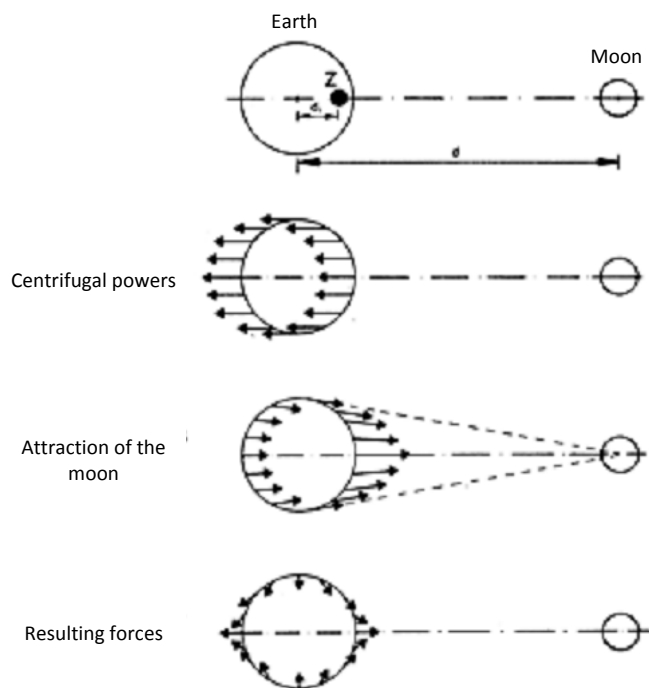

Figure 45 shows a graphic of the forces between the earth and moon. The 'bump' at the other end of the earth is

Figure 45 Forces between the earth and moon (adapted from Mooyaart, 2009)

caused because the distance from the other side of the earth is actually larger from the moon so the attraction is smaller. The earth gets pulled towards the moon more than the water on the other side of the moon. Because the resulting forces make two 'bumps' and the earth revolves around its axis once a day most places on earth experience two tides a day.

1. Periods

The periods between two high tides is not exactly 12 hours. While the earth revolves around its axis the moon revolves around the earth. For the earth and moon to be in the same position again the earth needs to 'catch up' with the moon. This is the reason the start of each new tide is 25 minutes later. The box shows the exact calculation of the rotation time.

Earthday= 23.93 hours

Moonday = 27.32 days

$$\omega_{Moon} \cdot t = \omega_{earth} \cdot (t - T_{day})$$

$$t = \frac{T_{day}}{\left(1 - \frac{\omega_{moon}}{\omega_{earth}}\right)} = \frac{23.93}{\left(1 - \frac{360/(24 \cdot 27.32)}{360/23.93}\right)} = 24.84 \text{ hours}$$

$$t = 24:50$$

In which

$$\omega_{Moon} = \text{rotation speed moon around earth} \left[\frac{\text{degrees}}{\text{hour}} \right]$$

$$\omega_{earth} = \text{rotation speed earth} \left[\frac{\text{degrees}}{\text{hour}} \right]$$

T_{day} = earthday (zenith) [hour]

t = time [hour]

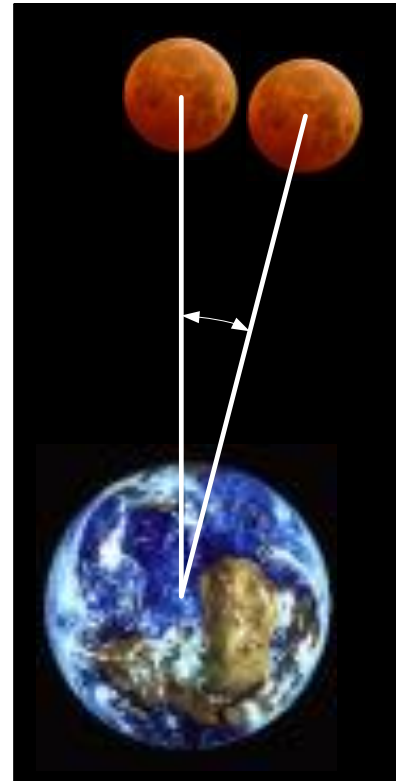

Something similar is happening with the time the moon needs to circle earth and the length of a moon month. When the earth, moon and sun align with full moon and new moon the forces reinforce each other which causes spring tides. Therefore it is important to define the period of a moonmonth. The box below explains the duration of a completed moonmonth

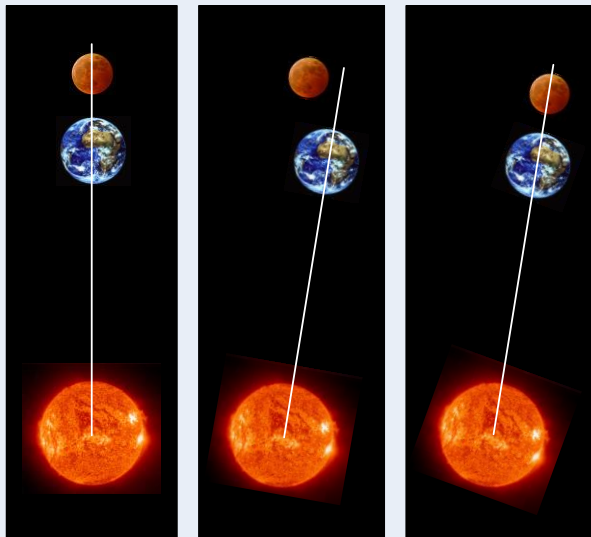

$$\omega_{es} \cdot t = \omega_{me} \cdot (t - T_{me})$$

$$t = \frac{T_{me}}{\left(1 - \frac{\omega_{es}}{\omega_{me}}\right)} = \frac{27.32}{\left(1 - \frac{360/(365.26)}{360/27.32}\right)} = 29.53 \text{ days}$$

$$t = 29.53 \text{ days}$$

In which

$$\omega_{es} = \text{rotation speed earth around sun} \left[\frac{\text{degrees}}{\text{hour}} \right]$$

$$\omega_{me} = \text{rotation speed month around earth} \left[\frac{\text{degrees}}{\text{hour}} \right]$$

T_{ma} = time for moon around earth

t = time [days]

The period of the moon revolving around the earth and the earth around the sun has the largest influence on the tide. There are however several more variations that can cause tides to become

smaller or larger. The longest cycle takes 18.6 years to complete. The table below summarizes all cycles that have an influence on the tides.

Moon	
Cycle of angle of the moon with the equator	27.21 days
Cycle around the earth	27.32 days
Variation distance earth-moon	27.55 days
Spring and low tides through alignment of moon, sun and earth	29.53 days
Catch up of the cycle of the moon-angle with equator through moon-month	376 days
Chatch up through the period of the orbit of moon around earth	440 days
Orbit ellips moonmonth	8.85 years
18.61 year cycle because of turning of moonorbit	18.61 years
Earth	
Daily inequality because of axis turning	23 hours, 56 minutes, 4 seconds
Orbit around sun	365,26 days

2. Tidal Range in the Klabat Bay

The case of the Klabat Bay is a bit different from most places, there is only one tide per day which means that the potential for energy production is smaller. The tidal difference is only achieved once a day, which means there is only one possibility each day to extract energy from this tidal difference. The application used before to investigate the depth of the Klabat Bay, TheMap, can also be used to find information about the tides. The following graphs are examples of the output this program gives.

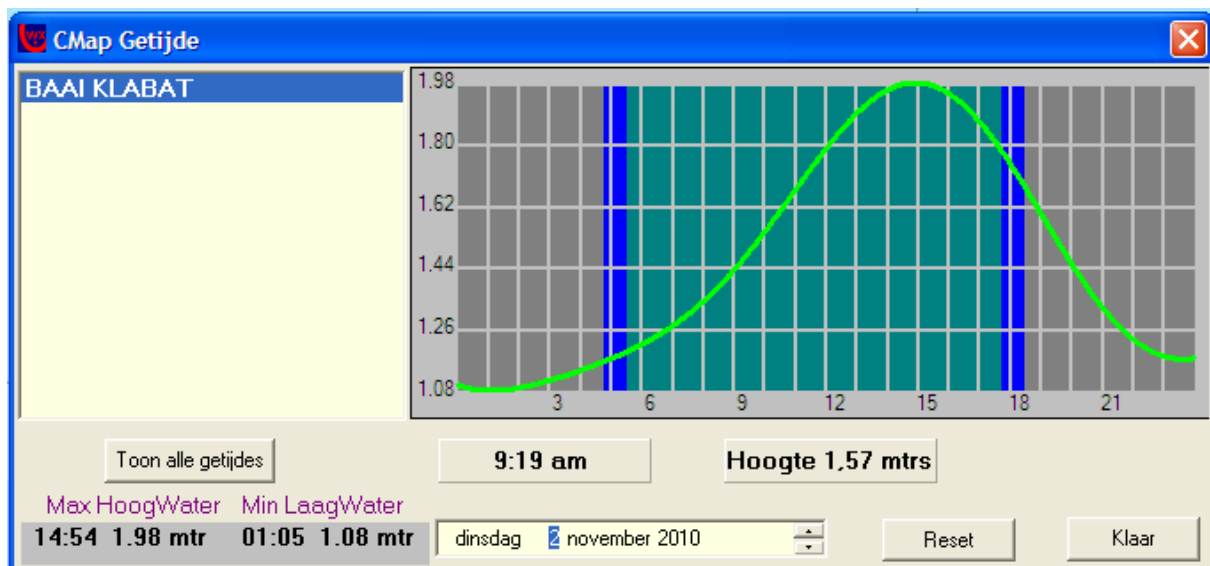

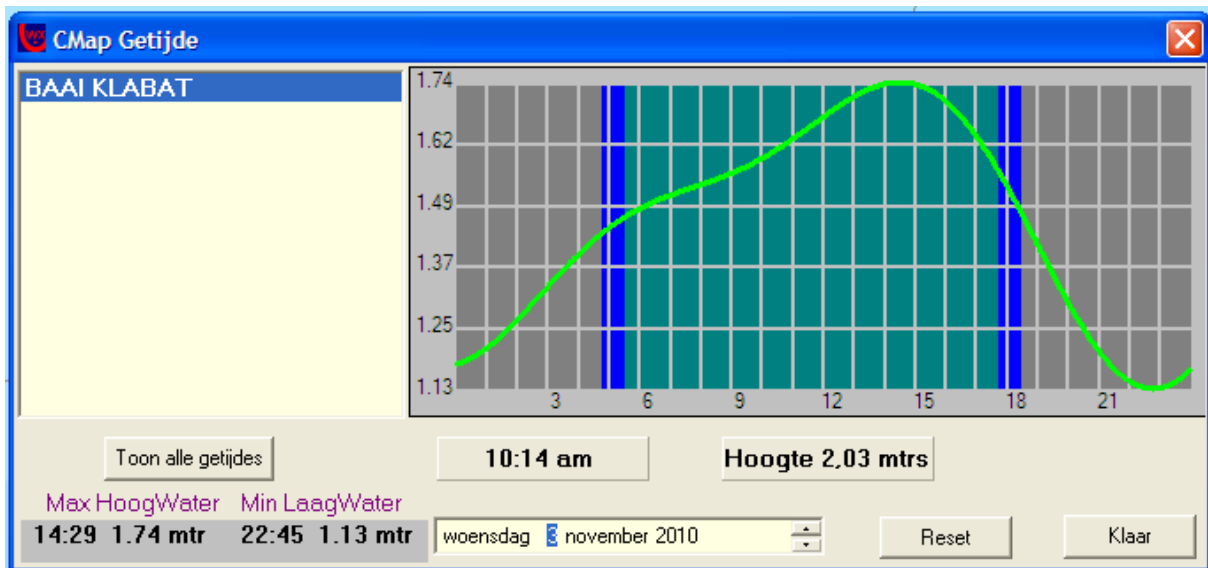

These graphs are available for 1 month only, so with this program it is not possible to gather data for longer periods. It does however give a lot of valuable information.

- Timing of high and low water
- Difference between periods of rising water level and periods of decreasing water level
- Tidal range for a day

Combining the information from these graphs for all days available presents an interesting picture of the tidal differences and especially the periods of rising water level and decreasing water level. The period it takes to get from high water level to low water level is generally a bit longer than 12 hours and 20 minutes. During periods of neap tide this period is usually a bit shorter.

Tabel 1

November	time	MaxHighWater	time	MinLowWater	Max difference	height	Hight to Low (T_f)
1	14:42	2.24	2:35	0.86	1.38	11:53	
2	14:54	1.98	2:05	1.08	0.90	11:11	
3	14:29	1.74	22:45	1.13	0.61	8:16	
4	7:33	1.81	22:16	0.98	0.83	14:43	
5	7:49	2.11	22:07	0.78	1.33	14:18	
6	8:23	2.39	22:14	0.57	1.82	13:51	
7	9:01	2.62	22:34	0.39	2.23	13:33	
8	9:41	2.81	23:02	0.26	2.55	13:21	
9	10:22	2.93	23:34	0.20	2.73	13:12	
10	11:03	2.98	0:00	0.20	2.78	12:57	
11	11:43	2.96	0:09	0.20	2.76	12:26	
12	12:21	2.86	0:43	0.27	2.59	12:22	
13	12:56	2.71	1:13	0.41	2.30	12:17	
14	13:26	2.49	1:33	0.61	1.88	12:07	
15	13:48	2.25	1:16	0.84	1.41	11:28	
16	13:51	1.99	0:00	1.04	0.95	10:09	
17	13:01	1.78	22:00	1.02	0.76	8:59	
18	7:25	1.90	21:37	0.87	1.03	14:12	

19	7:30	2.20	21:33	0.66	1.54	14:03
20	7:59	2.48	21:43	0.46	2.02	13:44
21					2.45*	
22	9:12	2.89	22:31	0.17	2.72	13:19
23	9:51	3.01	23:02	0.12	2.89	13:11
24	10:30	3.05	23:35	0.13	2.92	13:05
25	11:08	3.01	0:00	0.14	2.87	12:52
26	11:44	2.90	0:07	0.22	2.68	12:23
27	12:17	2.73	0:34	0.38	2.35	12:17
28	12:44	2.52	0:49	0.59	1.93	12:05
29	13:01	2.26	0:22	0.83	1.43	11:21
30	12:58	2.01	0:00	1.02	0.99	11:02

Apart from the data available through TheMap there is also a tidal sheet available for the whole year of 2010. These sheets show the water level in decimeters during a day and during a month. The sheets look like Figure 46. It is unclear where these measurements were made exactly as the coordinates are too broad to pinpoint a location. There is also no reference to the mean water level.

TELUK KELABAT 01° 42' S - 105° 42' T		SATUAN DALAM DESIMETER																									
		JANUARI 2010																									
		Waktu : G.M.T + 07.00																									
J T		1	2	3	4	5	6	7	8	9	10	11	12	13	14	15	16	17	18	19	20	21	22	23	24	J T	
1		0	0	2	4	8	13	17	21	25	28	29	30	30	29	28	26	24	21	18	15	12	8	5	2	1	1
2		0	0	0	3	6	10	14	19	23	26	28	29	29	28	27	25	23	20	17	14	11	7	4	2	1	2
3		2	1	1	2	4	8	12	16	20	23	26	27	28	28	27	26	25	23	21	19	16	13	10	7	3	3
4		5	3	2	3	4	7	10	14	18	21	24	25	26	26	26	25	24	23	21	20	17	15	12	10	4	4
5		7	6	5	5	5	7	10	13	16	19	22	23	24	24	24	24	23	22	21	19	18	16	14	12	5	5
6		10	9	8	7	8	9	11	13	16	18	20	21	22	22	22	21	21	20	19	18	17	16	15	13	6	6
7		12	11	10	10	11	11	13	15	16	18	19	20	21	21	20	19	18	17	16	16	15	14	14	13	7	7
8		13	13	13	13	14	14	15	17	18	19	20	20	20	20	19	18	16	15	14	13	12	12	12	12	8	8
9		13	13	14	15	16	17	18	19	20	21	21	21	21	20	18	17	15	13	12	11	10	9	9	10	9	9
10		11	13	14	16	18	19	21	22	23	23	23	23	22	21	19	17	15	13	10	9	7	7	7	7	10	10
11		9	11	13	16	18	21	23	24	25	26	26	25	24	22	20	18	15	13	10	8	6	4	4	4	11	11
12		6	8	11	14	17	21	23	26	27	28	28	27	26	24	22	20	17	14	11	8	5	3	2	2	12	12
13		3	5	8	11	15	19	23	26	28	29	29	29	28	26	24	22	19	16	12	9	6	3	1	0	13	13
14		1	2	5	9	13	17	21	25	28	29	30	30	29	28	26	24	21	18	14	11	7	4	2	0	14	14
15		0	0	3	6	10	15	19	23	26	29	30	30	30	29	27	25	23	20	17	13	10	6	3	1	15	15
16		0	0	1	4	8	12	16	21	24	27	29	30	30	29	28	26	24	22	19	16	12	9	6	3	16	16
17		1	0	1	3	6	10	14	18	22	25	27	28	28	28	27	26	24	22	20	18	15	12	9	6	17	17
18		4	2	2	3	6	9	12	16	20	23	25	26	26	26	26	25	23	22	20	18	16	14	11	9	18	18
19		7	5	4	5	6	9	12	15	18	21	23	24	24	24	24	23	22	21	20	18	17	15	13	11	19	19
20		9	8	7	7	8	10	12	15	17	19	21	22	22	22	22	21	20	19	18	17	16	15	14	13	20	20
21		12	11	10	10	11	12	14	16	18	19	20	21	21	20	20	18	17	16	16	15	14	14	14	13	21	21
22		13	13	13	13	14	15	16	18	19	20	21	21	20	19	18	17	15	14	13	12	12	12	12	13	22	22
23		13	14	15	16	17	18	19	20	21	22	22	21	21	19	18	16	14	12	11	10	9	9	10	11	23	23
24		12	13	15	17	18	20	21	23	23	24	24	23	22	20	18	16	13	11	9	8	7	6	7	8	24	24
25		10	12	14	17	19	22	23	25	26	26	26	25	23	22	19	17	14	11	8	6	5	4	4	5	25	25
26		7	9	12	16	19	22	24	26	28	28	28	27	26	24	21	18	15	12	9	6	4	2	2	2	26	26
27		4	6	10	13	17	21	24	27	29	29	30	29	27	25	23	20	17	14	10	7	4	2	1	1	27	27
28		1	4	7	11	15	19	23	26	28	30	30	30	29	27	25	22	19	16	13	9	6	3	1	0	28	28
29		0	2	4	8	12	17	21	25	27	29	30	30	29	28	26	24	21	18	15	12	8	5	2	1	29	29
30		0	1	3	6	10	14	18	22	26	28	29	30	29	28	27	25	23	20	17	14	11	8	5	2	30	30
31		1	1	2	4	8	12	16	20	23	26	27	28	28	27	26	25	23	21	19	16	13	10	8	5	31	31

Figure 46 Tidal Sheet KLabat Bay

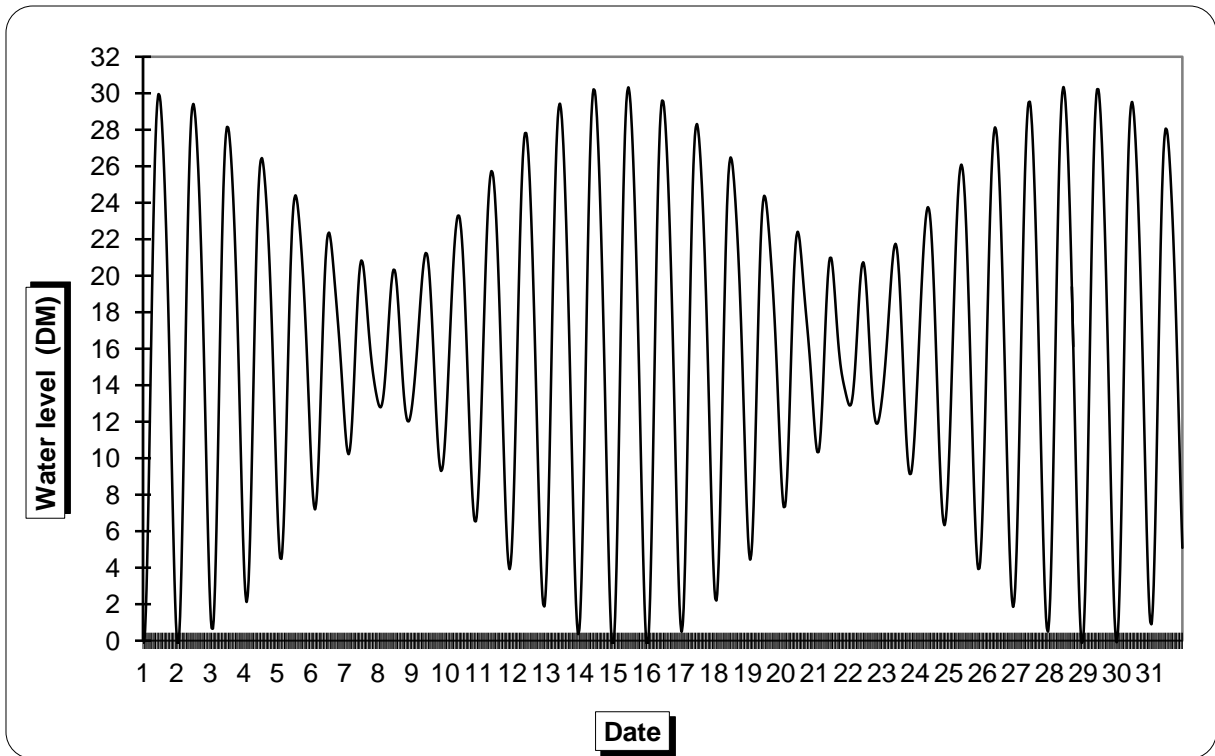
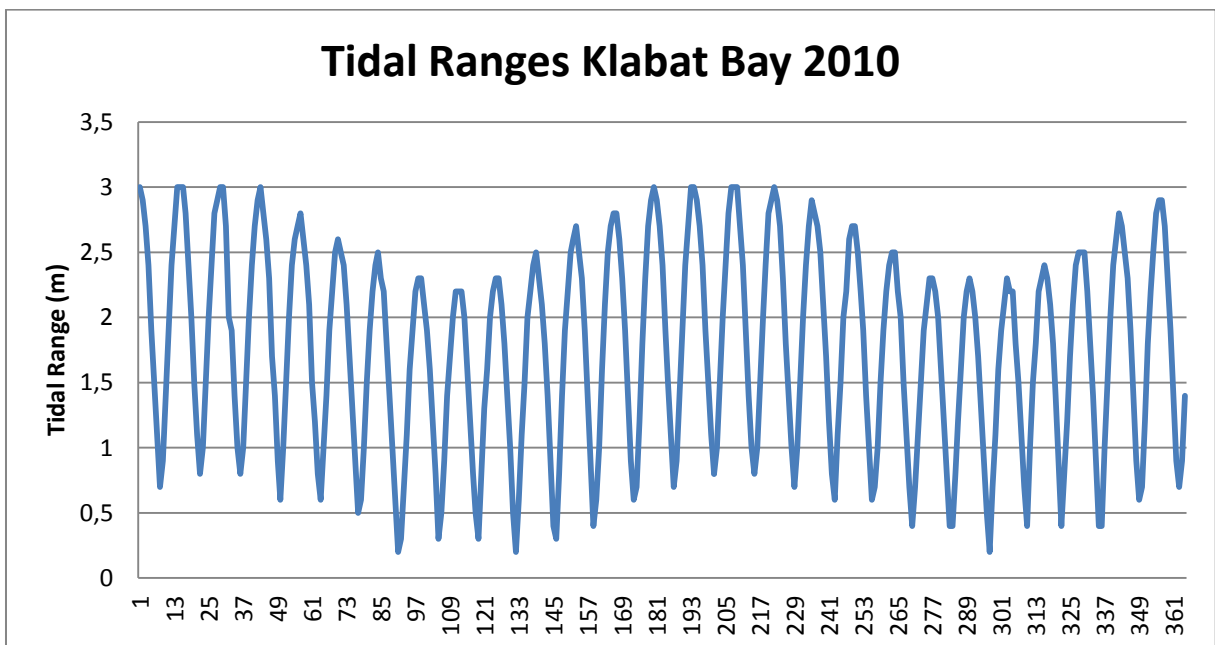

Figure 47 Tidal water level Klabat Bay Januari 2010

As this data is available for 2010 it is possible to convert the data into tables and graphs that can tell something about the tidal ranges.

The following graph shows the tidal ranges and how they change over time. Tidal ranges between 2-3 meters are very common but they are alternated by limited ranges of less than a meter. These ranges were calculated by taking the highest water level of each day and subtracting the lowest water level of that day. The list of numbers was then converted into a graph.

The average tidal range amounts to 1.77 meter



3. Definitions

The following graph contains many of the parameters that are used in the assessment of tides and design of tidal power plants. The legenda on the side explains what all the abbreviations mean.

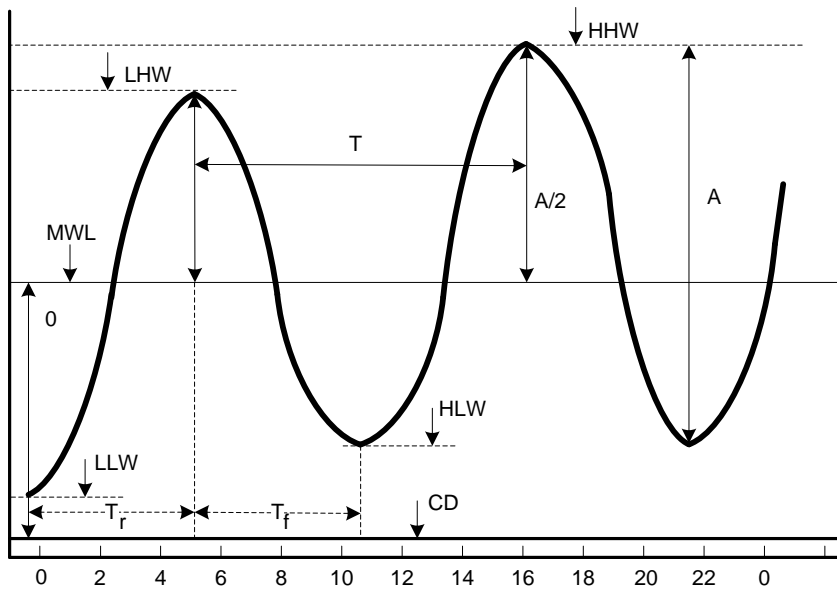

Abbreviation	Definition
MWL	Mean water level
LLW	Lower low water
A/2	Tidal amplitude
HLW	Higher low water
A	Tidal range
HHW	Higher high water
CD	Chart datum
T	Tidal period
Z_0	Height of mean water level above chart datum
T_r	$t_{HW} - t_{LW}$ - time (duration) of water level rise
T_f	$t_{LW} - t_{HW}$ - time (duration) of water level fall

Attachment D: Site specification

This appendix describes the specifications of the Klabat bay that have an influence on the energy potential and construction plans

1. Establishing the surface area of the Klabat bay

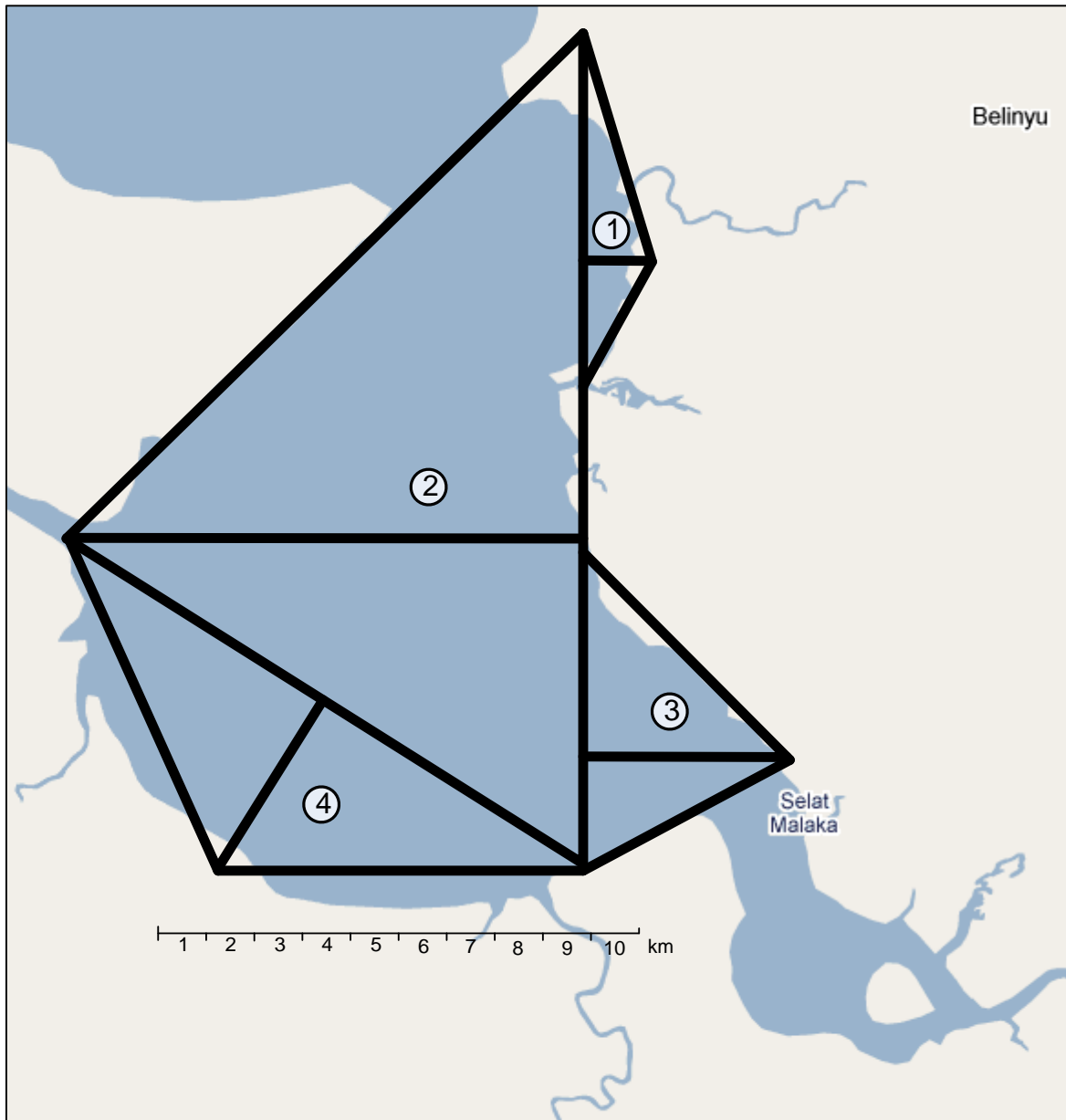

Tabel 2

Triangle	$0.5 * L * H$	Surface triangle
1	$0.5 * 7.3 * 1.5$	5.475
2	$0.5 * 10.7 * 17.3$	92.55
3	$0.5 * 4.4 * 7$	15.4
4	$0.5 * 4.4 * 7$	26.65
Surface inner Klabat bay		140 Km²

Attachment E : Tidal Differences in the Klabat bay

From the map center at the TU-Delft it was possible to access a fixed version of the TheMap application. This is software often used by sailors as an up to date map of water depths and tides. This fixed computer version, mainly used for students practice, offers insight into tidal graphs of one month in the Klabat bay. There is no extra information about where in the klabat bay this tidal difference was measured. The tidal graphs given by this software look like the picture below. Depicted are the location (Baai Klabat) maximum high water, maximum low water and the corresponding times. With the mouse it is possible to explore different points on the graph. The program does not mention to what standard height level the differences refer to. It is assumed that this it is meters above sea level, often abbreviated in Indonesia as m dpl. The mean sea level has to be defined as it differs around the globe. What mean sea level this software refers to is unclear. This batch of data only shows information for 1 month, the tidal range could differ considerably during the year. Therefore this information can only be used for estimations and rough calculations.

http://id.wikipedia.org/wiki/Meter_di_atas_permukaan_laut

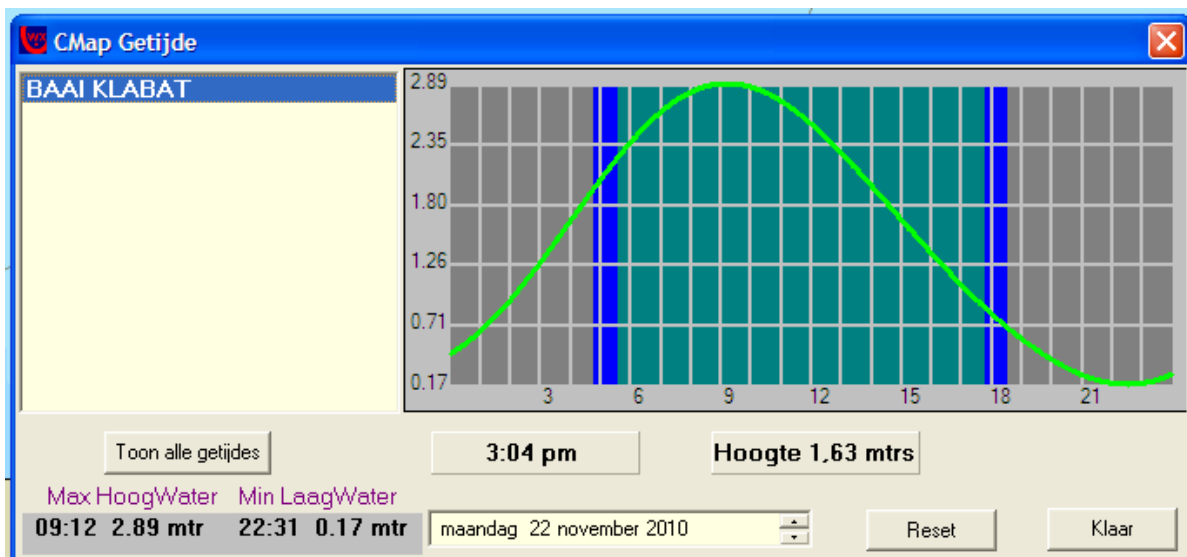

These graphs were available for one month. In order to learn more about the average tidal differences and variation the information was inserted in an Excel sheet and turn into a graph.

Tabel 3

November	time	MaxHighWater	time	MinLowWater	Max height difference	Tide Period
1	14:42	2.24	2:35	0.86	1.38	11:53
2	14:54	1.98	2:05	1.08	0.90	11:11
3	14:29	1.74	22:45	1.13	0.61	8:16
4	7:33	1.81	22:16	0.98	0.83	14:43
5	7:49	2.11	22:07	0.78	1.33	14:18
6	8:23	2.39	22:14	0.57	1.82	13:51
7	9:01	2.62	22:34	0.39	2.23	13:33
8	9:41	2.81	23:02	0.26	2.55	13:21
9	10:22	2.93	23:34	0.20	2.73	13:12
10	11:03	2.98	0:00	0.20	2.78	12:57
11	11:43	2.96	0:09	0.20	2.76	12:26

12	12:21	2.86	0:43	0.27	2.59	12:22
13	12:56	2.71	1:13	0.41	2.30	12:17
14	13:26	2.49	1:33	0.61	1.88	12:07
15	13:48	2.25	1:16	0.84	1.41	11:28
16	13:51	1.99	0:00	1.04	0.95	10:09
17	13:01	1.78	22:00	1.02	0.76	8:59
18	7:25	1.90	21:37	0.87	1.03	14:12
19	7:30	2.20	21:33	0.66	1.54	14:03
20	7:59	2.48	21:43	0.46	2.02	13:44
21					2.45*	
22	9:12	2.89	22:31	0.17	2.72	13:19
23	9:51	3.01	23:02	0.12	2.89	13:11
24	10:30	3.05	23:35	0.13	2.92	13:05
25	11:08	3.01	0:00	0.14	2.87	12:52
26	11:44	2.90	0:07	0.22	2.68	12:23
27	12:17	2.73	0:34	0.38	2.35	12:17
28	12:44	2.52	0:49	0.59	1.93	12:05
29	13:01	2.26	0:22	0.83	1.43	11:21
30	12:58	2.01	0:00	1.02	0.99	11:02

*The graph for the 21st of November was either unavailable or lost while processing the graphs. The high difference was estimated using the tidal graph.

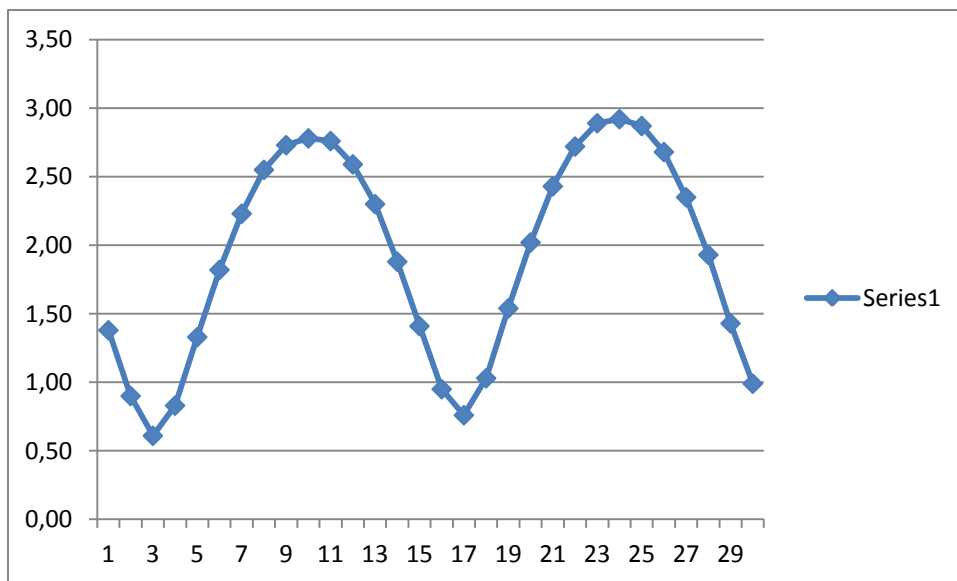

What can be learned from this data is that the average height difference in the month November 2010 was 1.92 meters. Also the variation of the tides is quite considerable during the month. Sometimes the tidal difference is smaller than 1 meter, other days the difference is more than 2.5 meters.

Attachment G: Interview reports

Interview dr. Abang Gindarsyah and Prabowo Kartoleksono, 2-5-2011

- Colleague Prabowo Kartoleksono is also interested in tidal power. He is interested in a project in south-east Sulawesi. There is a small canal, from bandah sea to java sea. Streams reach a speed of 6 (!) m/s. The name of the town is Bau-Bau
- *Introduction*; dr Abang worked for Pt Timah until 1991. As such he was in charge of electrical engineering. The technical manager and he had the supervision of the steampower plant. This was a 30MW diesel operated plant in Belinyu that is not in operation anymore. There was even a transmission line over the lake that went all the way 30 km to a different site. This power and infrastructure was developed by Pt Timah
- The power infrastructure to Sungailiat should still be there. The towers are there at 30 meters high. This is a 70kV power line. Conductors will be gone. Isolators should still be there
- Pt Timah is now running a 6 MW PLTD to supply for their own needs. For powering their housing and their operations that is already enough. Only the smelter uses some electricity, this is about 3MW. For this they use diesel capacity in Muntok
- For mining there are two options 1) Inland mining. PT Timah does not do these operations themselves anymore, instead they leave it to 3rd parties. These people use diesel power for the extraction. 2) Offshore mining. These operations use the power that is available on the boat, also diesel (This used to be dredging but now they use suction as a preferred method)

Now dr Prabowo Kartoleksono joins the interview

- PLN has an obligation to buy any renewable electricity produced at regulated prices. For Bangka these prices are at 1.2 times X. (X equals 656Rp/kWh for higher voltage and 1.004Rp/kWh for lower voltage)
- PLN runs a deficit on their operations. The regulated consumer and industry price is below the production cost. The subsidies needed to run the operations are funded by national government (with a small reasonable return for PLN included)
- Because of these subsidies PLN has little incentive to produce power at the lowest cost
- In most situations local governments do not play a big role in the development of power. They often lack the capacity to deal with these issues and leave it all to PLN. If there is a big shortage local governments will be very willing to cooperate and help invest in new generation facilities. But their funding is very limited. They can however help to provide permits and sell the needed land for a reasonable price.
- For the construction of 1 km of 70kV transmission line the rule of thumb is to budget 200.000 USD
- Currently PLN operates both production and T&D. This is disturbing the proper development of a market for private investors. In the (far) future PLN might be forced to split up its operations
- PLN is planning to connect all the major islands of Indonesia with power infrastructure. That way the access for renewable to a nearby transmission network will be greatly increased.

- Local government in Bangka probably has no extensive planning capabilities for electricity. They leave the development to PLN. Because PLN operates with such high subsidies this is usually also the more affordable than develop their own power. Dr Abang thinks that the energy responsibilities fall under the mining department in Bangka-Belitung.
- Local government there have no idea or plan or develop by their own. The only competent party to do power development is PLN. Therefore local government leaves development up to PLN. Because PLN sells for a subsidized plan so it is cheap. They have people for the mining and they put energy under this. They call this department mining division or something. He had several discussions with the major of Pankalpinang. (but this is only private interest, he has no authority as a major to make a budget or build a power plant) So they just argue and ask PLN to develop the power but have no capacity themselves. Mostly local government relies on PLN. For the electricity supply the national government doesn't authorize local government. National government still steers infrastructure developments.
- Now I think the policy is to centralize infrastructural developments. Not local
- Local government can only propose but not decide. Maybe they have the ability to reject, of course. They have the authority to give or refuse to give a permit.

Interview Hadi Susilo, General Manager Hydro PLN, 3-5-2011

Points discussed during the meeting;

- Planning of new production facilities is performed centrally at PLN head office in Jakarta
- Below 10 MW the line is paragraph 2 of the 'menteri energy dan sumber daya mineral' provides the effective guidelines.
- Above 10 MW paragraph 4 of the same document is leading, which leaves much more room for negotiation and requires unique contractual arrangements for each project
- The process followed for >10MW is described by the schemes in 'Prosedur permohonan IZIN' and will be further explained by Pak Abang on a later moment
- For normal (non-renewable) projects PLN works with an IRR of 14% and for renewable the IRR is 16%. If I understand correctly this means the all the costs (construction, operation etc.) are allowed to make a return of 16%, provided that the price (cost) per kWh is at an acceptable level
- Purchasing contracts are made for the expected life-time of the power plant
- The contractual arrangements and the necessary infrastructure investments will be performed by PLN Bangka (who are also in the main office in Jakarta)
- From the perspective of PLN the higher expense of some renewables is acceptable as the costs for production are covered by national subsidies

Attachment H: Tidal stream technologies

There are five principal ways of extracting marine energy, shown in the figure below. This report excludes wave energy, thermal gradient and salinity gradient from the analysis. The tidal range technology depends on a large barrier to be built. The tidal stream technology has a large worldwide potential and minimal impact on the environment. However compared to conventional power production it is costly. As there is such a wide range of concepts for tidal stream technology this chapter aims to summarize these concepts and their development stage.

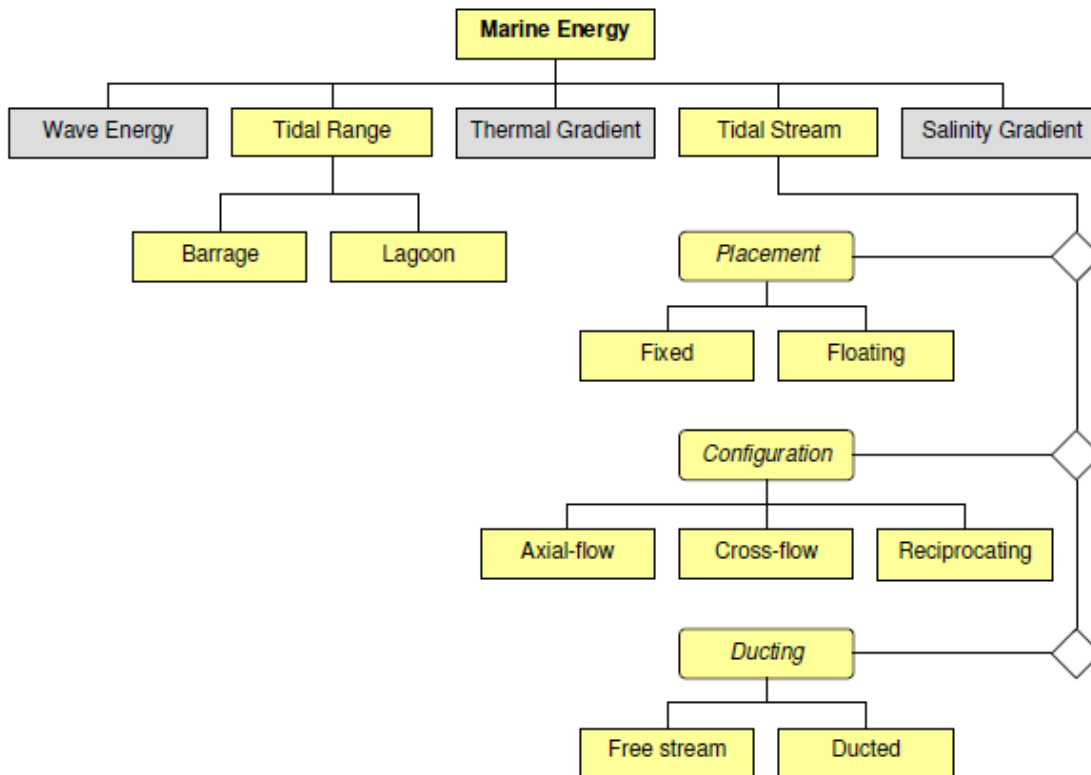

Figure 48 Categories of marine energy extraction (Entec 2007)

Tidal stream generators draw energy from currents in a similar way as wind turbines. The higher density of water, 832 times the density of air, means that a single generator can provide significant power at lower tidal flow velocities as compared with wind speed. In other words, water speeds of nearly one-tenth of the speed of wind provide the same power for the same size of turbine system. The total kinetic power in marine current can be expressed by the following equation:

$$P = \frac{1}{2} \rho A v^3$$

Where ρ is the seawater density (kgm^{-3}), A is the swept area of turbine blades (m^2) and v is the velocity of the seawater (m/s).

However, a marine energy converter or turbine can only harness a fraction of this power due to losses and the equation becomes:

$$P = \frac{1}{2} \rho C_p A v^3$$

Where C_p is the power coefficient and the percentage of power that can be extracted from the fluid stream taking into account losses due to Betz's law and the internal mechanisms within the converter or turbine. For wind generators, C_p has typical values in the range 0.25-0.3. The upper limit is for highly efficient machines with low mechanical losses. For marine turbines, C_p is in the range of 0.35 – 0.5.

Tidal stream generators are not fully mature because, at present, there is no commercial scale production of tidal generators and no standard technology being recognized as the clear winner. A variety of designs are being experimented. Several prototypes have been developed. Some are close to large scale deployment. However, their efficiencies and feasibility have yet to be independently verified.

At present, there are several prototypes, namely horizontal axis turbine, vertical axis turbine, oscillating devices and tidal turbine with venture shroud.

COMPANY	WEBSITE	TECHNOLOGY	DEVICE TYPE	COUNTRY BASE
Alstom Hydro	http://www.alstom.com/press-centre/2009/5/Alstom-enters-the-Ocean-Energy-market-reinforcing-its-renewable-energy-portfolio-20090525/	Clean Current Tidal Turbine	Ducted	France
Aquantis Inc	http://www.ecomerittech.com/aquantis.php	C-Plane	Vertical-axis turbine	USA
Atlantis Resources Corp	http://www.atlantisresourcescorporation.com/	AK-1000	Horizontal axis turbine	UK
Atlantisstrom	http://www.atlantisstrom.de/description.html	Atlantisstrom	Horizontal axis turbine	Germany
Aquascientific	http://aquascientific2.moonfruit.com/	Aquascientific Turbine	Other	UK
Balkee Tide and Wave Electricity Generator		TWPEG	Horizontal axis turbine	Mauritius
BioPower Systems Pty Ltd	http://www.biopowersystems.com/	bioStream	Oscillating Hydrofoil	Australia
Blue Energy	http://www.blueenergy.com/	Blue Energy Ocean Turbine (Davis Hydro Turbine)	Vertical-axis turbine	Canada
Bluewater	http://www.bluewater.com/bluetec	BlueTec	Horizontal axis turbine	Netherlands
BluStream		MegaWatForce		France
Bourne Energy	http://www.bourneenergy.com/	CurrentStar / TidalStar / OceanStar	Horizontal axis turbine	USA
Cetus Energy	http://www.cetusenergy.com.au/index.php	Cetus Turbine	Horizontal axis turbine	Australia
Clean Current Power Systems	http://www.cleancurrent.com/	Clean Current Tidal Turbine	Ducted	Canada
Crest Energy	http://www.crest-energy.com/			New Zealand
Current2Current	http://www.current2current.com/CURRENT2CURRENT_new_site/Our_Technology.html	Tidal Turbine	Vertical-axis turbine	UK
Current Power AB	http://www.currentpower.se/index.php?Itemid=65	Current Power	Vertical-axis turbine	Sweden
Ecofys	http://www.c-energy.nl/index.php?option=com_frontpage&Itemid=1	Wave Rotor	Horizontal axis turbine	Netherlands

Edinburgh Designs	http://www.edesign.co.uk/	Vertical-axis, variable pitch tidal turbine	Vertical-axis turbine	UK
Edinburgh University	http://www.mech.ed.ac.uk/research/	Polo	Vertical-axis turbine	UK
Fieldstone Tidal Energy	http://fieldstoneenergy.com/	Fieldstone Tidal Energy	Other	USA
Firth Tidal Energy	http://www.firthtidal.com/	Sea Caisson & Turbine System (SEACATS)	Horizontal axis turbine	UK
Flumill	http://www.flumill.co.uk/	Flumill Power Tower	Other	Norway
Free Flow 69	http://www.freeflow69.com/	Osprey	Horizontal axis turbine	USA
Free Flow Power Corporation	http://free-flow-power.com/	SmarTurbine	Horizontal axis turbine	USA
GCK Technology	http://www.gcktechnology.com/	Gorlov Turbine	Vertical-axis turbine	USA
Greener Works Limited	http://www.go-greener.com/	Relentless™ Turbine	Other	UK
Greenheat Systems Ltd	http://www.greenheating.com/	Gentec Venturi	Other	UK
Hales Energy Ltd	http://www.hales-turbine.co.uk/technology.html	Hales Tidal Turbine	Horizontal axis turbine	UK
Hammerfest Strom	http://www.hammerfeststrom.com/	Tidal Stream Turbine	Horizontal axis turbine	Norway
Hydra Tidal Energy Technology AS	http://www.hydratidal.com/	Morild ©	Horizontal axis turbine	Norway
Hydro Green Energy	http://www.hgenergy.com/	Hydrokinetic Turbine	Ducted	USA
Hydro-Gen	http://www.hydro-gen.fr/	Hydro-gen	Other	France
HydroCoil Power, Inc	http://www.hydrocoilpower.com/	HydroCoil	Other	USA
Hydrohelix Energies		Hydro-Helix		France
Hydrokinetic Laboratory	http://www.hklabllc.com/	HyPEG	Horizontal axis turbine	USA
Hydromine	http://www.hklabllc.com/	The Hydro Mine		UK

Hydroventuri	http://www.hydroventuri.com/	Rochester Venturi	Ducted	UK
Hydrovolts Inc	http://www.hydrovolts.com/	Hydrovolts	Vertical-axis turbine	USA
Ing Arvid Nesheim	http://www.anwsite.com/	Waterturbine	E	Norway
Kepler Energy	http://www.keplerenergy.co.uk/	Transverse Horizontal Axis Water Turbine (THAWT)	Vertical-axis turbine	UK
Keys Hydro Power	http://www.keyshydropower.com/		Ducted	USA
Kinetic Energy Systems	http://www.kineticenergysystems.com/	Hydrokinetic Generator, KESC Bowsprit Generator, KESC Tidal Generator	Horizontal axis turbine	USA
Lucid Energy Technologies	http://www.lucidenergy.com/	Gorlov Helical Turbine (GHT)	Vertical-axis turbine	USA
Lunar Energy	http://www.lunarenergy.co.uk/	Rotech Tidal Turbine	Horizontal axis turbine	UK
Magallanes Renovables	http://www.magallanesrenovables.com/	Magallanes Project	Horizontal axis turbine	Spain
Marine Current Turbines	http://www.marineturbines.com/	Seagen, Seaflow	Horizontal axis turbine	UK
Minesto	http://www.minesto.com/	Deep Green Technology		Sweden
Natural Currents	http://www.naturalcurrents.com/	Red Hawk		USA
Nautricity Ltd	http://www.nautricity.com/cormat/	CoRMaT	Horizontal axis turbine	UK
Neo-Aerodynamic Ltd Company	http://www.neo-aerodynamic.com/	Neo-Aerodynamic	Other	USA
Neptune Systems	http://www.neptunesystems.net/	Tide Current Converter		Netherlands
Neptune Renewable Energy Ltd	http://www.neptunerenewableenergy.com/	Proteus	Vertical-axis turbine	UK
New Energy Crop.	http://www.newenergycorp.ca/	EnCurrent Vertical Axis Hydro Turbine	Vertical-axis turbine	Canada
Norwegian Ocean	http://www.norwegianoceanpower.com/	The Pulsus Turbine		Norway

Power				
Ocean Flow Energy	http://www.oceanflowenergy.com/	Evopod	Horizontal axis turbine	UK
Ocean Renewable Power Company	http://www.oceanrenewablepower.com/	OCCGen	Other	USA
Oceana Energy Company	http://www.oceanaenergy.com/	TIDES	Horizontal axis turbine	USA
Offshore Islands Ltd	http://www.offshoreislandslimited.com/offshore%20islands%20limited_005.htm	Current Catcher	Horizontal axis turbine	USA
OpenHydro	http://www.openhydro.com/	Open Centre Turbine	Horizontal axis turbine	Ireland
Ponte di Archimede	http://www.pontediarchimede.it/	Kobold Turbine / Enermar	Vertical-axis turbine	Italy
Pulse Tidal	http://www.pulsegeneration.co.uk/	Pulse-Stream	Oscillating Hydrofoil	UK
Robert Gordon University	http://www.rgu.ac.uk/cree/general	Sea Snail	Horizontal axis turbine	UK
Rotech	http://www.rotech.co.uk/rotech_engineering_tidal_energy.html	Rotech Tidal Turbine (RTT)	Horizontal axis turbine	UK
Rugged Renewables		Savonius turbine	Other	UK
Scotrenewables	http://www.scotrenewables.com/	SR250	Horizontal axis turbine	UK
SMD Hydrovision	http://www.smdhydrovision.com/	TiDEL	Horizontal axis turbine	UK
Sustainable Marine Technologies (SMT)	http://www.susmartech.com/pages/contact.php	PLAT-O	Horizontal axis turbine	UK
Starfish Electronics Ltd	http://www.starfishelectronics.co.uk/	StarTider	Horizontal axis turbine	UK
Statkraft	http://www.statkraft.com/	Tidevanndkraft	Horizontal axis turbine	Norway
Swanturbines Ltd.	http://www.swanturbines.co.uk/	Swan Turbine	Horizontal axis turbine	UK
Teamwork Tech.	http://www.teamwork.nl/	Torcado	Horizontal axis turbine	Netherlands

The Engineering Buisness	http://www.engb.com/	Stingray	Oscillating Hydrofoil	UK
Tidal Electric	http://www.tidalelectric.com/	Tidal Lagoons	Other	UK/USA
Tidal Energy Ltd	http://www.tidalenergyltd.com/	Delta Stream	Horizontal axis turbine	UK
Tidal Energy Pty Ltd	http://tidalenergy.net.au/	DHV Turbine	Vertical-axis turbine	Australia
Tidal Generation Limited	http://www.tidalgeneration.co.uk/	Deep-gen	Horizontal axis turbine	UK
Tidal Sails	http://www.tidalsails.com/	Tidal Sails AS	Other	Norway
TidalStream	http://www.tidalstream.co.uk/	TidalStream Triton Platform	Horizontal axis turbine	UK
Tideng	http://www.tideng.com/	Tideng	Horizontal axis turbine	Denmark
Tocado BV	http://www.tocado.com/digi_cms/5/technology.html	Tocado Turbines	Horizontal axis turbine	Netherlands
UEK Corporation	http://www.uekus.com/	Underwater Electric Kite	Oscillating Hydrofoil	USA
University of Southampton		Southampton Integrated Tidal Generator	Horizontal axis turbine	UK
Verdant Power	http://www.verdantpower.com/	Various	Horizontal axis turbine	USA
Voith Hydro	http://www.voithhydro.com/media/t331_Ocean_Current_Technologies_72dpi.pdf	Hytide	Horizontal axis turbine	Germany
Vortex Hydro Energy	http://www.vortexhydroenergy.com/	VIVACE (Vortex Induced Vibrations Aquatic Clean Energy)	Other	USA
Water Wall Turbine	http://www.wwturbine.com/	WWTurbine	Other	USA
Woodshed Technologies - CleanTechCom Ltd	http://www.woodshedtechnologies.com.au/	Tidal Delay	Other	Australia / UK

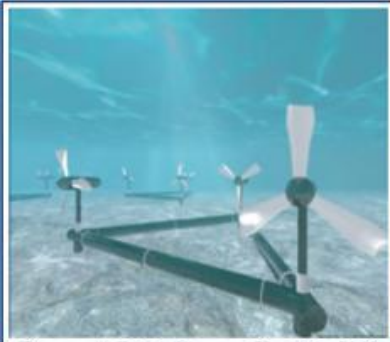

DeltaStream Turbine (Tidal Energy Ltd)

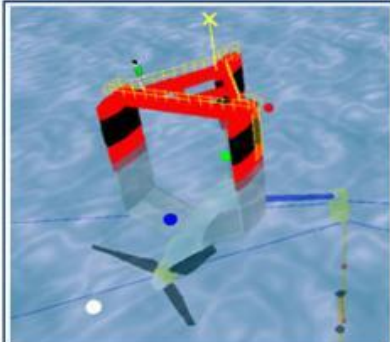

Evopod Tidal Turbine (Ocean Flow Energy Ltd)

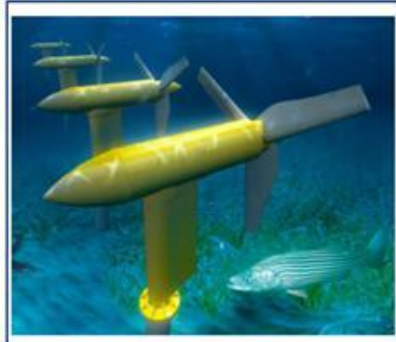

Free Flow Turbine (Verdant Power Ltd)



Gorlov Helical Turbine (GCK Technology Inc.)

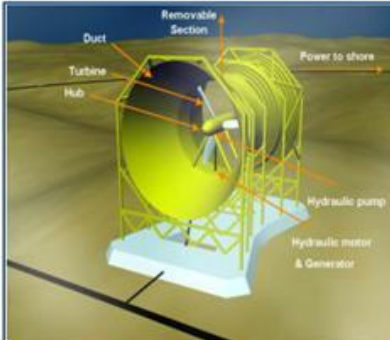

Lunal Energy Tidal Turbine (Lunar Energy Ltd)



Neptune Tidal Stream Device (Aquamarine Power Ltd)



Nereus Turbine and Solon Turbine (Atlantis Resource Corporation Ltd)

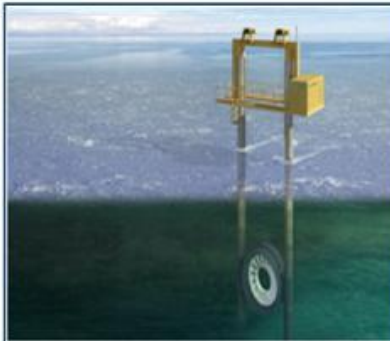

Open Centre Turbine (Open-Hydro Ltd)

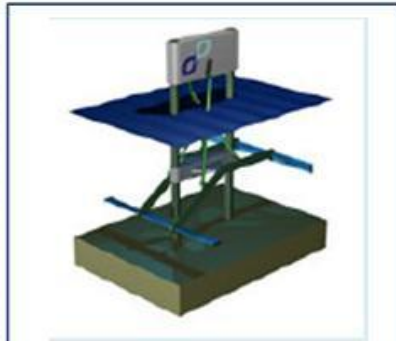

Pulse Tidal Hydrofoil (Pulse Generation Ltd)



Seagen (Marine Current turbines Ltd)

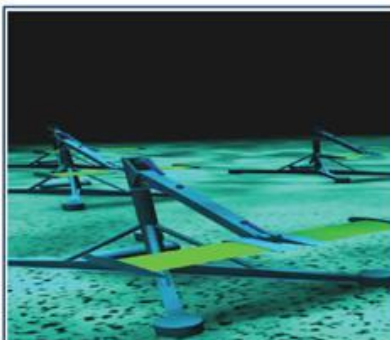

Stingray Tidal Energy Converter (Engineering Business Ltd)



Tidal Fence Davis Hydro Turbines (Blue Energy Ltd)



TidEl Stream Generator (SMD hydrovison Ltd)



Tidal Stream Turbine (Hammerfest Strom AS)

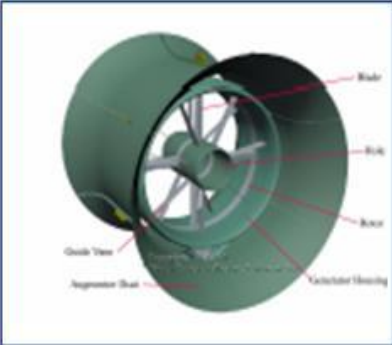

Tidal Turbine Generator (Clean Current Power Systems)



Ponte di Archimede (ENERMAR)



Underwater Electric Kite (UEK corporation)

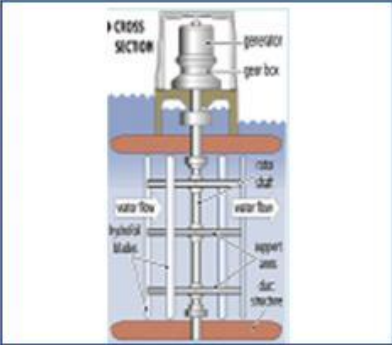

Ocean Turbine (Blue energy)



Hydra Tidal design (Statkraft)



Tidal Sails (Tidal Sails AS)



Blue Concept (Hammerfest Strom AS)

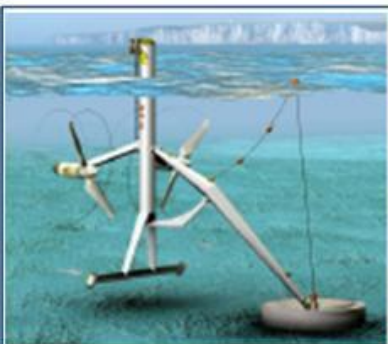

TidalStream (J.A. Consult)



EnCurrent (New Energy Corp)



OCGen (Ocean Renewable Power Company)



SRTT (Scotrenewables)



Tide Current Converter (Neptune Systems)

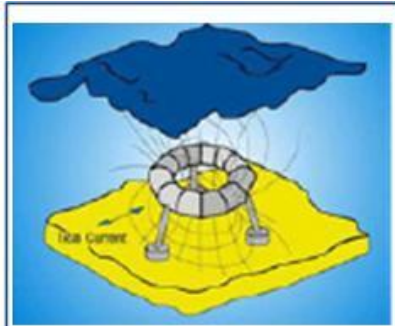

Proteus (Neptune Systems)



Deep Gen (Tidal Generation Ltd.)

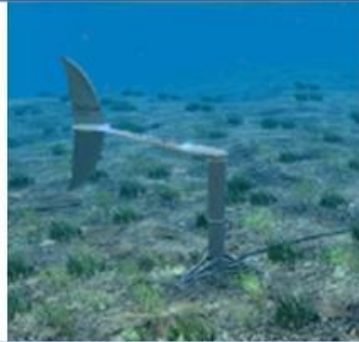

bioStream (BioPower Systems Pty Ltd)

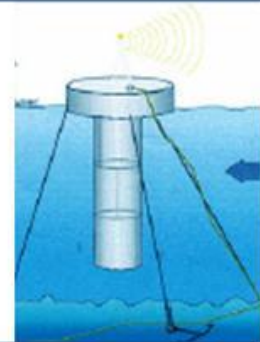

Exim (Seapower)

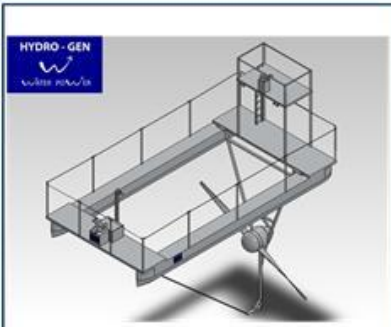

Hydro-Gen waterpower (Hydro-gen)



Sea Snail (Robert Gordon University and AREG)

Attachment I: Scientific Paper

The paper copies the layout of the journal 'Research in Engineering Design', as published by Springer. Adjustments have been made to the layout to ensure that this paper will not be confused with a published article in this journal.

Res Eng Design

DOI 10.100X/s00163-012-xxxx-z

ORIGINAL PAPER

Combined Technological and Institutional design methodology applied to a case study of tidal power development in the Klabat bay, Indonesia

N.C. de Groot

Received: 10 August 2012/ Revised: 24 August / Accepted: XXX

© The Author(s) 2012. This article is **not** published in any journal

Abstract The design of complex technological systems required an early outlook of institutional issues. The paper suggests a design methodology to combine institutional design and engineering design. The design methodology is applied to a case study of tidal power development in the Klabat bay, Indonesia. In the case study it is shown that there are interactions between institutional design and technological design. Ignoring the institutional environment the financial and economic performance of tidal power in the Klabat bay is poor for all options. Incorporation of institutional design allowed for creative thinking that could allow for the decision to continue feasibility research. The inclusion of institutional design therefore proved valuable. The design process did become more complex.

Keywords Engineering design · complex technological systems · Institutional design · Design requirements · Design variables

1 Introduction

The design of any system involves a number of phases; Firstly there is the interpretation of a need, followed by the development of design parameters,

a divergent search transformation of concepts and finally the convergence towards a proposal (Macmillan, 2001). In engineering design the approach towards solving problems is often straightforward. A problem is identified, technological solutions are identified, assessed for their merits, and a solution is chosen. However, the more complex a problem becomes, and especially when human interactions are involved, the harder it becomes to maintain a strictly technological approach towards design (Koppenjan & Groenewegen, 2005). That is why methods have been developed to incorporate non-technological design issues into the design process of complex technological systems. Examples are stakeholder analysis, multi-criteria decision modeling and institutional design. In this paper a combination of institutional design and technological design is applied to a case study, and evaluated for its merits. The question this paper attempts to answer is: 'What is the value of combining technological and institutional design to the design of complex technological systems?'. The approach towards answering this question is to apply this design philosophy to a case study of tidal power development in the Klabat bay in Indonesia.

In order to evaluate the application of the design philosophy, firstly the benefits of a design methodology are discussed here. Designs benefits from a design methodology for the following reasons (French, 1985):

1. Increasing insight into the problems, and the speed of acquiring insight,
2. By diversifying the approach to problems,

N.C. de Groot (✉)

Department of Energy and Industry

Faculty of Technology, Policy and Management, TU Delft

e-mail: ncdegroot@gmail.com

3. By reducing the size of mental steps required in the design process,
4. By prompting inventive steps, and reducing the changes of overlooking them
5. By generating design philosophies

After the design exercise is finished, it will be possible to evaluate the value of the design methodology based on these benefits. The design philosophy used in this paper is central to the master education 'Systems Engineering, Policy Analysis and Management' at the TU-Delft. A paper by Koppenjan and Groenewegen (2005) about the institutional design of complex technological systems is important in this regard. In their paper the theoretical benefits of institutional design and a design approach is proposed. The design approach is further explained in the next paragraph, here we will further define the terms 'institutions', 'institutional design' and 'complex technological systems'. Koppenjan and Groenewegen offer the following definitions of institutions and institutional design:

Institutions:

'Technological systems are in need of 'rules of the game' that guide and coordinate the behavior of actors. These arrangements can be formulated in formal laws, but can also be of an informal nature. The rules that coordinate behavior can be of a public or private character. The public, private, formal and informal arrangements can be regarded as institutions necessary for the system to function. Institutions or institutional arrangements are thus a set of rules that regulate the interaction between parties involved in the functioning of a (technological) system.' (Koppenjan & Groenewegen, 2005)

Institutional design:

'Besides the design of the technological component, complex technological systems require an institutional structure that coordinates the positions, relations and behavior of the parties that own and operate the system. Aside from a technological design, an institutional design is also needed.'

'Institutional design is not separate from technological design, nor is it determined by it. True, the issues that have to be settled by institutional design follow, to a large extent, from the specific technological characteristics of a system, but the institutional solutions that are chosen may vary.' (Koppenjan & Groenewegen, 2005)

Koppenjan and Groenewegen argue that complex technological systems require institutional design as well as technological design. Before making the decision to apply some form of institutional design to the case study, it is necessary to establish that the case study has the characteristics of a system that needs institutional design. Koppenjan and Groenewegen offer the following definition for the characteristics of complex technological systems:

- These systems have a technological component that can be characterized as 'unruly', which means that technology is important but does not determine the functioning of the system
- There are multiple parties involved: complex technological systems are multiactor systems. Often, these systems transcend the boundaries of one organization
- There are often both public and private parties involved, and the functioning of these systems has an impact on both private and public interests
- In their functioning, complex technological systems can be influenced by both market forces and government regulation.

From here on, the case study will be introduced, and argued to be a complex technological system that needs institutional design. Then the design methodology for the case study is explained in detail. The outcome of the design process is summarized subsequently. The outcomes of the design process of the case study are the basis for the evaluation of the design methodology.

2. Case study; Tidal power development in the Klabat bay, Indonesia

The Klabat bay is an estuary to the north of the island Bangka, of the Bangka-Belitung province in Indonesia. Figure 1 shows a map of the Bangka-Belitung province and a close up of the Klabat bay. The estuary consists of an 'inner Klabat bay' and an 'outer Klabat bay', this is how both parts of the estuary will be referred to in this paper. Located to the east of Sumatra, Bangka-Belitung became an independent province in 2001. It is an island group of which Bangka and Belitung are the main islands (Erman, 2007). The islands are well known for its tin production and for its beautiful beaches. Access to electricity on the island is limited and black-outs are frequent. As a large part of the electricity production uses aging diesel plants, the production costs of electricity are very high. The

production cost of electricity using diesel are about 3000 IRD, this compares unfavorably with the cost of electricity production using coal fired power plants, about 700 IRD, and the consumer price of electricity, about 700 IRD (Pt. PLN, 2010). As can be seen from these figures electricity usage in Indonesia is subsidized by the national government budget. The national electricity company PT. PLN is constructing coal fired power plants at the island which will improve the basic infrastructure conditions. However, the island group still faces an imminent energy crisis. In 2008 a delegation from the Netherlands and local policy makers visited Bangka and the Klabat bay. The purpose of the visit was to review local energy policy. One of the opportunities identified was the tidal movement in the Klabat bay. This case study will use the previously explained design philosophy to analyze the potential for tidal power development in the Klabat bay. The question the case study is trying to answer is: What is the feasibility of tidal power development in the Klabat bay.

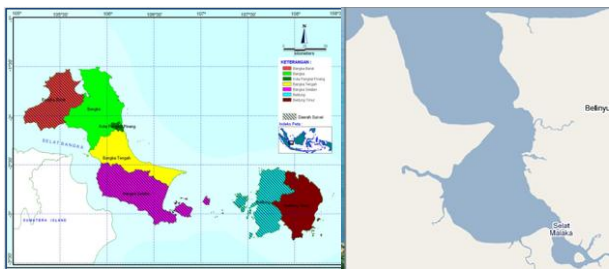

Figure 1 Map of the province of Bangka-Belitung and the Klabat bay. (picture left: (Kusuma, 2010), picture right: (Maps.google.com, 2012))

The introduction explained that complex technological systems need institutional design. The characteristics of complex technological systems were defined there. For all characteristics, examples can be thought of in the case of tidal power development in the Klabat bay. E.g. There are different technology options that are preferred partly based on institutional impacts, the project would involve a complex network of actors to cooperate, public and private parties are likely to be involved and the functioning of the system is heavily influenced by government regulation but also by market forces. It is therefore established that this system can be described as a complex technological system that would benefit from institutional design; the coordination of the behavior of parties necessary to make the system function.

3. Proposed design methodology for complex technological systems

Koppenjan and Groenewegen propose the metamodel for the design process by Herder and Stikkelman (Herder & Stikkelman, 2004) as a suitable tool for institutional design. As this metamodel is also suitable for engineering design, it is used here to combine both design disciplines into a single design methodology. Figure 2 shows an adapted version of the metamodel for the design process. The design process consists of a number of steps, which closely relate to the benefits of having a design methodology as explained in the introduction. By developing a list of requirements and defining the design space, it becomes possible to define the design solution space. The design methodology could be summarized as ‘selecting an instance in the design space that meets the objectives and constraints’ (Herder & Stikkelman, 2004)

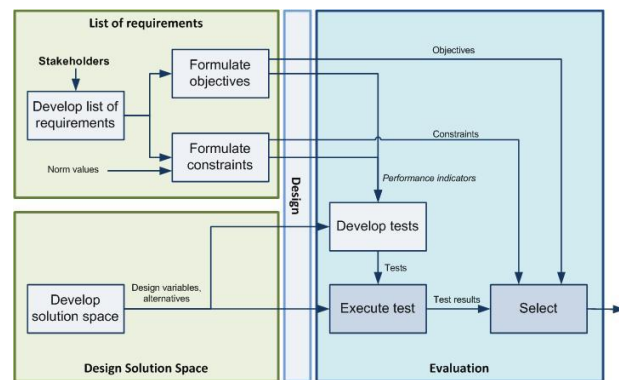

Figure 2 Metamodel for the design process (Herder & Stikkelman, 2004)

The contents of the design blocks are further defined in table 1.

Design Goals	What the designer wishes to achieve
Design Objectives	Selection of goals to be optimized, i.e. minimized or maximized
Design Constraints	Selection of goals to be met but not to be optimized; constraints can also be imposed by the environment (in the broadest sense of the word), demarcating the design from its surroundings
Tests for the goals	Tests for the goals, describing in detail how proposed designs are going to be assessed for their ability to meet each design goal, based upon a behavioral model of the design and its environment, and <i>before</i> the design has been actually built
Design Space	Superset of design components and design variables

Table 1 Definitions of the design blocks from the metamodel for the design process

Every design process follows a number of phases. The definition of a list of requirements and design solution space could be considered a 'diagnosis' phase that supports divergent thinking. The following 'design' phase is an iterative process in which the earlier defined components are combined in several ways to establish a number of conceptual designs. These designs are then evaluated, or tested, on their merits after which an option is selected. In the case study all the phases of the design process are performed. Important in this regard is that not only technological design variables and requirements are research and integral to the conceptual designs; the institutional components form an integral part of the design process.

4. Application of the design methodology to the case study

Any design process should start with a thorough problem analysis, exploring the demands and expectations of the problem owner. In this case developing tidal power in the Klabat bay is considered a solution by the problem owner. Analysis of other alternatives for electricity development are outside the scope of the research. Tidal power uses the natural flows of water in estuaries caused by the gravitational forces of the moon and sun and the rotation of the earth. The tides make two distinct movements; 1. Vertically, the water moves up and down 2. Horizontally, because of the shape of the estuary and the force of the tidal movements the water is accelerated (Aquaret, 2008; Denny, 2009; Swane & Stive, 2007). The objective of this case study is to study the feasibility of harvesting this kinetic energy and transforming it into electrical power. This is done by first analyzing the design objectives, constraints and design variables (spanning up the design solution space) and creating conceptual designs that are within the solution space. Because there is limited space in this paper only the most important parameters are discussed in this paper. Details about the case study are presented in the master thesis report by Niek de Groot (de Groot, 2012).

4.1 Design objectives are a selection of goals which are to be minimized or maximized. The introduction explains the existence of an energy crisis on Bangka. Many residences are not even connected to the grid and those who are, have to deal with frequent black-outs. Furthermore the basis for electricity production is diesel based which is expensive and polluting. Most of the cost are covered by government budgets as the

tariff is regulated and insufficient to meet the cost of production, let alone transmission and distribution. There are coal fired power plants being developed to alleviate the worst problems of energy production but these are unable to meet the ever growing demand. The design objectives are to:

1. Maximize energy output
2. Minimize cost of energy production (IDR/kWh)
3. Minimize negative environmental impacts
4. Minimize negative social impacts
5. Maximize positive social impacts

4.2 Design variables are those parameters that the designer has control over. We identify two categories of design variables; technological and institutional. Technologically there are two very distinct options, tidal barrage and tidal stream.

Tidal barrage means the construction of a barrage with sluices and turbines. There are functioning tidal barrage power plants, with the 230GW plant in La Rance (France) being the prime example (O'Rourke, Boyle, & Reynolds, 2010). With a barrage it is possible to utilize the artificially created head, this option is able to harvest almost all of the energy that is available from the tides. It would be a large scale project of about 30-50MW with high up-front investment cost and significant social and economic impacts on the environment. Technologically the most important design variables are the plant configuration, optimization and construction strategy. With the help of different configurations it becomes possible to influence the timing of the output of the power plant. Tidal energy is intermittent as the tide moves in two directions. The largest power output can be achieved with one-directional turbines that generate only during ebb. Any adjustment, such as two-way operating turbines, will decrease the total output of the plant, while increasing investment cost. These need to be offset by the gain in flexibility. The optimization involves the design of the turbines and sluices. The size of necessary sluices are a function of the configuration of the plant. The size and number of the turbines are mainly a function of the local tidal range and the plant configuration. In general, the larger the turbines, the smaller the cost per power output (Mooyaart, 2009).

Tidal stream technology is very different from tidal barrage technology. It is more similar to wind power, but then using the tidal streams instead of wind. The technology is immature with a number of proven concepts but without existing commercially operating

examples. As the technology is immature there are still many developers trying to come up with the best concept. The main technological design variables are configuration, placement and ducting. The three most important configurations are horizontal axis turbines, vertical axis turbines and making use of hydrofoils (Entec, 2007; O'Rourke, Boyle, & Reynolds, 2009; The Crown Estate, 2011). There is no option which has a clear advantage over the others. The placement could be gravity based, on a pole or using a floating structure. The placement strategy is dependent on the local environment with depth and soil type the differentiators. Ducting is the placement of a spherical construction around the turbine to increase speed flows. Ducting is generally considered to be uneconomical (Entec, 2007).

The institutional design variables are those formal and informal instruments at the disposal of the problem owner to guide and coordinate the behavior of stakeholders. These include ownership arrangements, process arrangements with the national power company (PLN), the Power Purchasing Agreement (PPA), risk management and influencing the attitudes of stakeholders. Ownership of power production in Indonesia can be fully state owned, a public private partnership or the appointment of an independent power producer. Each type of ownership has its own merits and requires a different development process. The process arrangements that can be made with PLN are guided by national legislation. 'Normal' power developments need to follow an elaborate open tender procedure. As this is a renewable power development, it is legally possible for PLN to choose for the direct appointment of a developer. The design of a Power Purchase Agreement is normally based on a price/kWh in combination with a time period, generally 15-20 years. As tidal electricity production is intermittent it requires back-up power that can only operate when the tidal power plant is offline. The intermittency, the expected long life time of a tidal barrage and the novelty of tidal stream technology need to be incorporated in the PPA. Design variables available for risk management include the type of ownership arrangement. Another option is the involvement of the institutional investment funds PT PII (PT Penjaminan Infrastruktur Indonesia) and PT SMI (PT Sarana Multi Infrastruktur) which are respectively owned by institutional investors and the government of Indonesia (PriceWaterhouseCoopers, 2011). These investment funds have the explicit objective to provide funding for infrastructural projects in Indonesia and to

insure project risks at an acceptable premium (The World Bank, 2009).

4.3 Design constraints are goals that have to be met but don't need to be optimized. In the case of tidal power development in the Klabat bay we identify three categories of constraints; 1. Physical constraints 2. Technological constraints and 3. Institutional constraints.

The physical parameters of the klabat bay and the tidal movement constrain the available energetic potential. The average tidal range in the Klabat bay is 1.77m with a regular diurnal tide. Diurnal tides occur only once a day, while most tides occur twice a day (semi-diurnal tides). Calculations show that the maximum energy that could be harvested with a barrage could be between 100-165 GWh annually. The average stream speeds in the Klabat bay are estimated to be 0.18m/s. The entrance to the inner klabat bay is more than 20m deep. In the rest of the inner and outer Klabat bay the depths range between 1-13m (de Groot, 2012).

The constraints differ for stream and barrage technology. In both cases the intermittency of the tides is a serious issue. Tidal barrage technology is a mature and proven technology. The large tidal barrage power plant will have to fit in with the local electricity network. Investment cost of a tidal barrage are high and impacts on the socio-economic environment significant. Tidal stream technology has a smaller impact on the environment, and the smaller scale allows for an easier integration into the grid. Tidal stream technology however is in a development stage and has not proven commercial viability yet.

The existing laws and regulations, institutional environment and commitment of stakeholders offer other constraints. The tariff for small scale renewable energy is regulated to be 787 IDR (0.0835 USD)/kWh for medium voltage grid connection or 1204 IDR (0.1065 USD)/kWh for a low voltage grid connection at Bangka (Pt. PLN, 2010). The national energy company PT. PLN is an important stakeholder in any electricity development in Indonesia as they own and operate the transmission and distribution networks and 90% of the national production capacity (International Resource Group, 2007). Indonesia is going through a process of democratization and decentralization. The transfer of responsibilities to lower governments offer opportunities for local developments. However the process of decentralization and democratization also brings institutional uncertainties. The Indonesian

government has tried to improve the investment climate by introducing legislation and the creation of the investment funds PT PII and PT SMI. However, the investment climate in Indonesia still ranks poorly compared to neighboring countries (The World Bank, 2009).

4.4 Conceptual designs offer an opportunity to combine the design variables within the solution space. as the identification of the design variables indicate there are two distinctive technological options with very different characteristics.

Using the design variables and constraints for the tidal barrage technology, the best option appears to be an ebb-generating plant with about 79 turbines with a 3m diameter. This design was created with the help of experts from Royal Haskoning, the conceptual design lacks detail, so changes could be made in future studies. The power plant could generate 99GWh annually with a 35MW capacity (de Groot, 2012). A Public Private Partnership would be the ownership arrangement most suitable to manage the inherent project risks. An investment vehicle could be chosen by direct appointment by PT. PLN to develop the power plant. The Power Purchasing Agreement between the investment vehicle and Pt PLN needs to include arrangements for the cost of intermittency, the very low variable cost of power production, the exceptionally long expected life time of the power plant and the electricity developments on Bangka-Belitung.

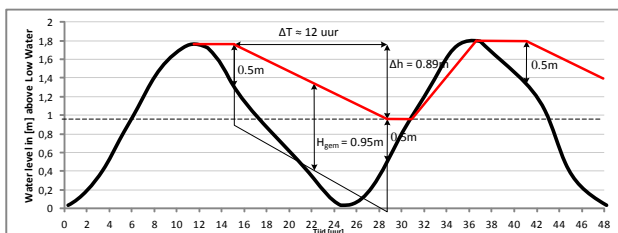

Figure 3 Generation scheme of the conceptual tidal barrage power plant design (de Groot, 2012)

A realistic tidal stream power plant design is more difficult to make. The technology is immature and there is no technological design that is a clear industry winner (O'Rourke et al., 2010). Projections for the cost of power production of tidal stream units range between 0.14 USD/kWh and 0.28 USD/kWh, with central estimates in the range 0.19 USD/kWh to 0.23 USD/kWh (Entec, 2007). With the costs of existing units far exceeding these estimates. If these figures are compared to the feed-in tariffs at Bangka (0.0835USD/kWh or 0.1065USD/kWh) then there is no

viable business case. Therefore, in order to make tidal stream energy possible in the Klabat bay, the problem owner, the Bangka regency, needs to align interests of other stakeholders in such a way that development would still be possible. PT. PLN has the ability to develop pilot projects outside the existing legal framework, this could be one option to pursue. It would require PLN to find funding for the development of the technology. There are a number of convincing arguments for the national government to invest in the development of tidal stream technology. Indonesia has a large domestic potential for tidal stream (Ray & Egbert, 2005), it could develop the manufacturing industry in Indonesia and become a supplier to the world market and tidal stream development is in line with the objective to increase renewable energy production (PriceWaterhouseCoopers, 2011). Framing the development of tidal stream technology is a choice, and the high initial cost of development would have to be accepted as a consequence of this choice.

4.5 Evaluation of the conceptual designs is based on the performance indicators, technological feasibility, financial and economic performance and acceptance.

The costs of constructing the tidal barrage power plant are estimated to be between 300 and 1000 million USD, with 610 million USD being the best estimate (de Groot, 2012). Comparing these cost to the production cost of coal and natural gas fired power plants and using these to estimate the time to break even, results in unattractive estimates. The time to break-even in the base case scenario would be 60 to 100 years. Only when comparing the construction cost to the exceptionally high production cost of electricity using diesel, there could be a viable business case (20-25 years in the base case scenario). As diesel is currently the main source of electricity on the island, this could be a legitimate choice. From a technological perspective the construction would be challenging but certainly possible. Acceptance of the plant needs to be further researched with a focus on the environmental impacts and the socio economic impacts of building a barrage in the Klabat bay.

It is easy to discard the tidal stream option as non-feasible based on the performance indicators. The option scores bad on the financial and economic performance (revenue within the existing institutional framework will not exceed cost). However, the development of a small scale pilot project could be

feasible if the economic performance is accepted to be part of the development of the technology and industry.

5. Interaction technological and institutional design

The design methodology in which institutional design and technological design are combined were applied to the case study. There are instances where the institutional components and the technological components interacted, in other words the design was not fully determined by technological issues.

- The feed-in tariffs for small scale renewable energy implies the need to involve stakeholders into the development that are able to 'work around' the institutional constraint. A simple cost-benefit analysis would have discarded the option of tidal stream development.
- Comparing the cost of tidal barrage development to the cost of conventional power production means there is no commercial business case. But the cost of power production on Bangka are extremely high at the moment. And demand far exceeds supply. So any addition to the power supply (especially if it would be funded with external funds) would be a good thing, even if it is expensive in comparison to coal, it might be affordable compared to the current cost of electricity production. Therefore, the choice to proceed with further feasibility studies could still be justified.

The benefits of the design methodology are now reflected upon. The design methodology increased insight into the problem, it allowed for a divergent thinking process followed by a convergent selection process. This ensured that the likelihood of missing viable options was small. Applying this methodology to the case study did increase the amount of mental steps required in the design process, a clear disadvantage. The industry standards for feasibility research do not include such different options into one analysis and generally exclude institutional issues from the analysis. As a consequence the research process became somewhat complex. The open-minded approach towards tidal development did allow for the inclusion of many options and 'thinking outside the box'. This allowed for reframing the tidal stream option as an

option for 'developing technology' compared to 'generating electricity'.

6. Conclusion

The design approach in which institutional and technological design were combined in a generic design model allowed for the feasibility assessment of tidal power development in the Klabat bay Indonesia. The design approach encouraged divergent thinking about the issue and a convergent selection process. The case study shows examples of institutional issues being interdependent with technological issues. By pointing out these examples it was possible to creatively think about future steps in the development of tidal power development in the Klabat bay. The inclusion of institutional design in the early stages of the design process allowed for the early assessment of institutional constraints and the development of creative solutions to these constraints. The inclusion of institutional design did make the process more complex than might have been necessary to establish the feasibility of tidal power development. The energetic and technological constraints are the most important parameters that influence the technological but also the financial and economic performance.

References

- Aquaret. (2008). Potential key interactions between tidal barrage installations and the receiving environment, (December).
- Denny, E. (2009). The economics of tidal energy. *Energy Policy*, 37(5), 1914-1924. doi:10.1016/j.enpol.2009.01.009
- Entec. (2007). *Tidal power in the UK: Research Report 2 - Tidal technologies overview. Contract.*
- Erman, E. (2007). Rethinking Legal and Illegal Economy: A Case Study of Tin Mining in Bangka Island. *East Asia*, (October), 1-34. Retrieved from <http://globetrotter.berkeley.edu/GreenGovernance/papers/Erman2007.pdf>
- French, M. J. (1985). *Conceptual Design for Engineers* (3rd ed.). London: Springer.
- Herder, P., & Stikkelman, R. (2004). Methanol-Based Industrial Cluster Design: A Study of Design Options and the Design Process. *Industrial Engineering Chemical*, (43), 3879-3885.

- International Resource Group. (2007). *USAID 2007 - ASIA Annex 3: Indonesia country report. Renewable Energy*.
- Koppenjan, J., & Groenewegen, J. (2005). Institutional design for complex technological systems. *International journal Technology, Policy and Management*, 5(3), 240-257.
- Kusuma, R. R. (2010). Indonesian Government Eyeing Bangka Island for 2 Nuclear Power Plants. *Jakarta Globe*. Retrieved from <http://www.thejakartaglobe.com/bisindonesia/indonesian-government-eyeing-bangka-island-for-2-nuclear-power-plants/403789>
- Macmillan, S. (2001). Development and verification of a generic framework for conceptual design. *Design Studies*, 22(2), 169-191. doi:10.1016/S0142-694X(00)00025-9
- Maps.google.com. (2012). Indonesia, Bangka - scale undetermined, accessed by Niek de Groot. Retrieved August 5, 2012, from <https://maps.google.com/maps?q=indonesia+bangka&hl=en&ll=1.649781,105.805893&spn=0.603309,1.056747&sll=1.453473,125.031281&ssp=0.603364,1.056747&hnear=Bangka+Island&t=m&z=11>
- Mooyart, L. (2009). Haalbaarheidsstudie naar een getijcentrale langs de Westerschelde. *CiTG, Hydraulic*. Delft: TU-Delft.
- O'Rourke, F., Boyle, F., & Reynolds, A. (2010). Tidal energy update 2009. *Applied Energy*, 87(2), 398-409. Elsevier. Retrieved from <http://www.sciencedirect.com/science/article/pii/S030626190900347X>
- O'Rourke, F., Boyle, F., & Reynolds, A. (2009). Tidal energy update 2009. Dublin: Dublin Institute of Technology.
- PriceWaterhouseCoopers. (2011). *Electricity in Indonesia - Investment and Taxation Guide*.
- Pt. PLN. (2010). Rencana Usaha Penyediaan Tenaga Listrik PT PLN (Persero) 2010-2019. (P. P. L. N. (Persero), Ed.) ISBN: 978-979-1203-14-2. Jakarta.
- Ray, R., & Egbert, G. (2005). Tides in the Indonesian Seas. *Oceanography*, 18(4), 74-79. Retrieved from <http://scholar.google.com/scholar?hl=en&btnG=Search&q=intitle:Tides+in+the+Indonesian+Seas#6>
- Swane, H., & Stive, P. dr. ir. M. J. F. (2007). Tidal power plant in Saemangeum. *Hydraulic Engineering, Hydraulic*, 136. Delft: Technische Universiteit Delft.
- The Crown Estate. (2011). *Wave and dal energy in the Pentland Firth and Orkney waters : How the projects could be built*.
- The World Bank. (2009). *Indonesia development policy review - enhancing government effectiveness in a democratic and decentralized indonesia*. (B. D. The world Bank, Ed.) *Investing in Indonesia Institutions for inclusive and sustainable development*. The World Bank.
- de Groot, N. (2012). *Tidal power in the Klabat bay, Indonesia - an application of the SEPAM Design methodology*. TU-Delft.