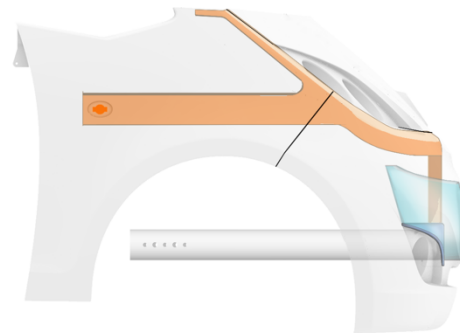
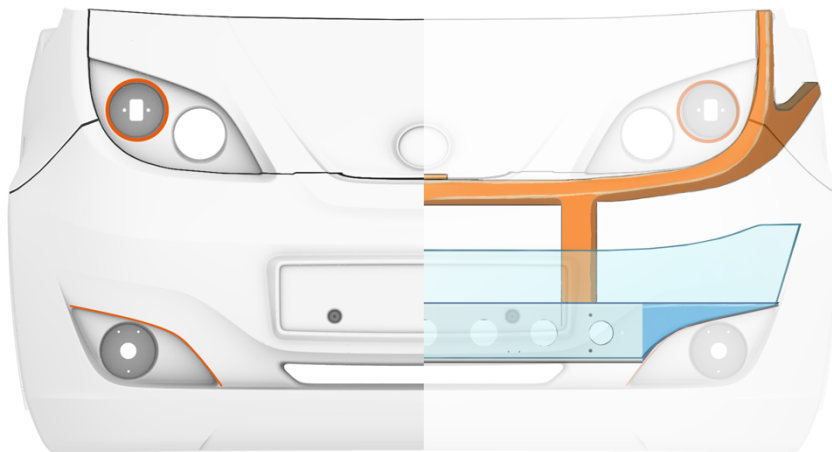
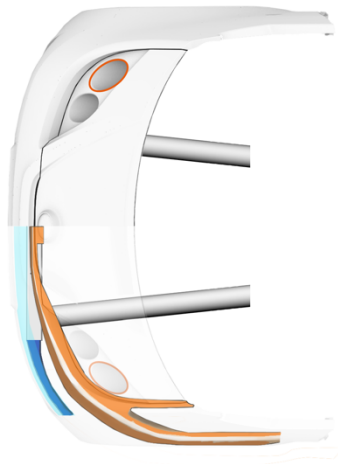


19 FEBRUARI 2021



The reparability of car body panels in a circular economy case study: Microcab Industries Ltd

Master Graduation Thesis Industrial Design Engineering

RUTGER MAK VAN WAAY | 4168098

IPD – Industrial Design Engineering – TU Delft

Mekelweg 5, Delft

The repairability of car body panels in a circular economy

case study: Microcab Industries Ltd

BY
RWJ MAK VAN WAAY

TO OBTAIN THE DEGREE OF MASTER OF SCIENCE
AT THE DELFT UNIVERSITY OF TECHNOLOGY

Student number: 4168089

Project duration: September 9, 2020 – February 19, 2021

Supervisory team:

Chair: Conny Bakker TU Delft

Mentor: Jelle Joustra TU Delft

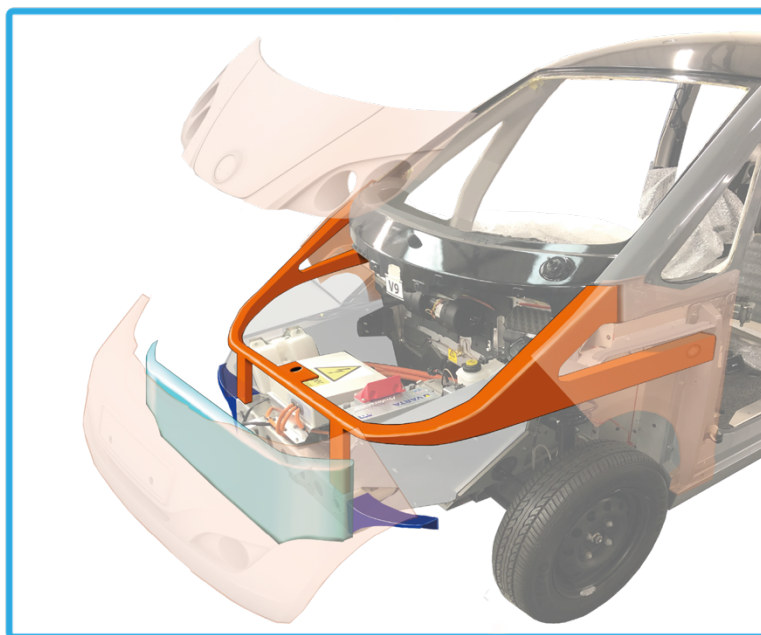
Contact Microcab: James Ayre Microcab



SUMMARY

The current vision of Microcab is to increase the repair capabilities of the VIANOVA. Part of that vision is to begin the shift towards a circular economy in which the lifecycle of the product is extended, and parts can be processed in a circular manner during the lifecycle. Considering that Microcab is a small company and the challenge is considerable, additional safety regulations mean that a vehicle should become a road-safe vehicle.

This graduation project contributes to this challenge by researching the main question that focuses on the front section of the vehicle: *'How can Microcab design the front section of the VIANOVA to increase the repairability and solve the safety issues?'*. Through several analyses and explorative design directions, the result is a concept that reconfigures the front section of the VIANOVA to allow for increased repairability and better safety requirements while maintaining the goal of becoming more circular. An important requirement is that the concept should allow for a production volume of 500 units annually. The current design of the front clip is a single large body panel hand-made from a glass fibre reinforced thermoset, which is difficult to repurpose and recycle. Based on research data, a sustainable alternative known as thermoplastic olefin (TPO) is introduced. Furthermore, the front clip has been split into four segments. These changes allow for better repair capabilities and lower the overall impact of a low-speed collision. In order to make this possible, structures were required to support the panels and increase energy absorption. The bonnet with incorporated headlights is enlarged to increase accessibility during service and fixated on the support structure, removing it from the impact zone. The support was required to improve safety for pedestrians and increase protection of internal components. This support consists of adding an energy absorber, upper load beams, cross member, and extending the width of the bumper beam. Additionally, it is recommended to use plastic fasteners to increase circular capabilities, considering that these are more likely to break, allowing for the body panels to remain intact. Lastly, it is recommended to implement a different type of surface finish. 3M provides an PVC-free wrap material, reducing the use of harmful chemicals and increasing repairability and circularity. This change also provides opportunities to illustrate internals or implement advertisement. Therefore, the project reveals that there are multiple elements that can have a positive influence on the repairability and safety issues while at the same time, shift towards a circular economy. The recommendations that emerged from the project provide a high desirability, but will require follow-up research and physical crash testing to determine optimal configuration of the front section, and create a better understanding of the elements and how they influence impact resistance and repairability.



PREFACE

This graduation thesis is the deliverable of my graduation project for the Master of Science Integrated product design at the Delft University of Technology at the Faculty of Industrial Design. Over the past 6 months, I have conducted my graduation research for Microcab. It gave me considerable insight into how a small company operates in the automotive industry and insights into the challenges and opportunities for Microcab.

I identified this project on the list of graduation project provided by the faculty. I always had an interest in the automotive industry but purely through passion. During my graduation, I had the pleasure to submerge myself in my own passion and learn more about the field.

This project provides a concept that can help Microcab shift towards a circular economy and provide relevant data to help Microcab solve their repair and safety issues. It was also interesting to learn more about hydrogen and how it will have an impact on the future.

Graduating during COVID has brought multiple challenges for me: The fact that there are existing VIANOVA's, but not accessible due to travel restrictions. This brought limitations in physically getting insight on the current configuration. Having not met my supervisory team in person during the process also was a strange experience, but I would like to express my gratitude to my Chair, Conny Bakker, and mentor, Jelle Joustra. Their encouragement, understanding, and enthusiasm helped me significantly during my research and always provided insightful feedback throughout the process. It improved my reflection and created a mindset to keep advancing.

Finally, I would like to thank James Ayre from Microcab. Even though we have never met in person, he made me feel at ease and always helped me throughout my research, raising questions that provided new insights and helped my focus on relevant fields.

This whole project has been a strange and interesting journey for me, considering I was not able to visit Microcab and work together on the VIANOVA. Nevertheless, I thank James for his support and communication these past few months.

TABLE OF CONTENTS

1	GLOSSARY	9
2	INTRODUCTION	10
2.1	Project context	10
2.1.1	The client: Microcab Industries Ltd	10
2.1.2	The goal: Increasing reparability in a circular economy.....	11
2.1.3	Problem definition	12
2.1.4	Circularity for Microcab	14
2.1.5	Stakeholders.....	15
2.2	Research questions	16
2.3	List of requirements	16
2.4	Project methodology.....	18
2.4.1	1:10:100 approach.....	18
2.4.2	Reflective practice.....	19
3	RESEARCH.....	20
3.1	Automotive Trend analysis.....	20
3.2	Frequent automotive damages.....	21
3.3	Development of the front car bumper.	21
3.4	Repair and safety.....	23
3.4.1	Safety means.....	23
3.4.2	Synthesis.....	23
3.5	Circularity.....	25
3.5.1	materials.....	25
3.5.2	Surface finish.....	26
3.6	Aesthetics	27
4	CONCEPT GENERATION	29
4.1	Design development	30
4.2	Increasing reparability and safety.....	32
4.2.1	Segmentation front clip	32
4.2.2	Support and fastening.....	34
4.2.3	Low-speed impact energy absorption.....	35
4.3	Increasing circular capabilities	36
4.3.1	Material selection	36
4.3.2	Surface finish selection	36
4.4	Embodiment	37
5	MANUFACTURING AND COSTS	39
5.1	Manufacturing.....	39
5.2	Cost estimate.....	39
6	CONCEPT EVALUATION	40
7	CONCLUSION	43
8	RECOMMENDATIONS.....	43
9	REFERENCES	45
10	APPENDICES	51

A.	Manufacturing and costs VIANOVA front clip	M.	Plastic materials in the automotive industry
B.	Photographs Dismantled VIANOVA	N.	Comparison PP VS ABS
C.	Current GRP repair process	O.	PP Welding
D.	BMW Damage expert insights	P.	Process of painting a car/body panel
E.	Cycle 1	Q.	Infographic car wrapping process
F.	Cycle 2	R.	Technical specifications 3m Envision
G.	Reflections	S.	Mood board design language
H.	Historical analysis of front car bumper	T.	Physical Prototyping
I.	Images Field research bumper panel lines	U.	Analysis Manufacturing processes
J.	Active safety systems	V.	Cost overview
K.	Fastening systems	W.	Project Brief
L.	Photographs dismantled BMW bumper		

1 GLOSSARY

- PLA	:	Polylactic acid
- EV	:	Electric vehicle
- PP	:	Thermoplastic polymer polypropylene
- JUTE	:	Fibres made from flowering plants
- front clip	:	Refers to the complete front body panel section of a the VIANOVA including headlights and other related items fixated on the body.
- front section	:	Everything from the front to the A-pillar/doors of a car
- GRP	:	Glass fibre reinforced plastics (polyester resin)
- Bumper Beam	:	Main structure for absorbing the energy of collisions.
- Frame rails	:	Structural part of chassis that acts as crumple zone to absorb energy and protect occupants
- Virgin material	:	Previously unused raw material
- LCI	:	Life cycle impulse, other definition for a facelift, usually to update a vehicle every ± 3.5 years \rightarrow aesthetics and minor technical updates
- Environmental Weathering	:	the breaking down or dissolving of the material on the surface. Water, ice, acids, salts and temperature changes are agent of weathering
- ELV	:	End of life vehicles
- PHEV	:	Plug-in hybrid vehicle
- Bumper fascia	:	The visual part of a bumper system, commonly referred to as the 'bumper'
- Energy absorber	:	The part that absorbs low-impact speed collision energy, reducing physical damage, and lowers the risk of injury regarding pedestrians
- ADAS	:	Advanced driver assistance systems
- GMT	:	Glass mat thermoplastic (typically with PP)
- SCM	:	Sheet moulding compound with a thermosetting resin
- PC/PBT 1103	:	Thermoplastic alloy of polycarbonate and polybutylene terephthalate
- TPO	:	Thermoplastic olefin: blend of PP with EPM or EPDM and a filler
- Upper load beam	:	support structure in the front section of a car that helps absorb energy from collisions
- Cross member:	:	Structural section that protects internal components of a car
- Thermoset	:	Irreversibly hardened Plastic
- Thermoplastic:	:	Plastic that becomes soft when heated and hard when cooled, can be done several times without losing its chemical or mechanical properties
- EPM	:	Ethylene propylene rubber
- EPDM	:	Ethylene propylene diene monomer rubber
- ABS	:	Thermoplastic acrylonitrile butadiene and styrene
- Acrylic (paint)	:	Water-based and thus water-soluble
- Aerosols:	:	Medium for applying paint on a surface: air-solution \rightarrow paint is mixed with air or a gas to spray it on the surface.
- VOC	:	Volatile organic compounds: chemicals that have a health and environmental impact.
- PVC	:	Polyvinyl chloride
- PE	:	Polyethylene
- Panel lines	:	Also referred to as panel gaps: lines between the different body panels.
- ARN	:	Auto Recycling Nederland

2 INTRODUCTION

This project is a master graduation project for the master's in integrated project design (IPD) at the Faculty of Industrial Design Engineering (IDE) of the Delft University of Technology (TU Delft). The project is initiated from the PhD research 'design strategies for composites in a circular economy' by Jelle Joustra, supported by EU H2020 project Ecobulk. The project client is Microcab, a company in Great Britain that designs and builds hydrogen-powered vehicles in a sharing platform. This chapter describes Microcab, the goals set by Microcab, the research question, a clear problem definition, relevant stakeholder, and the project methodology.

2.1 Project context

This paragraph describes background information about the company and their product, clearly defining the scope of the project and the problem provided by the project client.

2.1.1 The client: Microcab Industries Ltd

Microcab Industries Limited (throughout the report referred as Microcab) is a relatively small company located in Coventry that specializes in building a low carbon vehicle called the VIANOVA to provide a sustainable means of travel in the UK on a sharing platform. Their goal is to create a fully circular way of transportation. The key sustainability element of their vehicle is the drivetrain: the VIANOVA has a fuel cell system that runs on hydrogen. Currently, Microcab estimates a lifecycle of around 20 years for the VIANOVA, with refurbishment intervals of 7 years, designed with an emphasis on the circular economy.



Figure 1: Microcab VIANOVA

The company ethos of Microcab focusses on sustainability (David Hooppell, Mechanical engineer at Microcab):

- Futureproofing
 - o Circular
 - o Reliable
 - o Upgradable
 - o Efficient
 - o Retrieve from PLA waste
- Carbon capture
- Autonomous
- Intra-extra vehicle applications
- Home and grid technology integration

The VIANOVA is a small city vehicle that accommodates two people (Figure 1). The initial idea was for the car to be a taxi. This concept shifted towards the sharing principle or as a utility vehicle on a large university campus. Microcab follows the principle of the access model (C. Bakker et al. 2014); this relies on the company remaining in ownership, where it is either possible to lease or share the VIANOVA.

The research of Microcab focusses on the new mobility: thinking, feasibility and design with a hydrogen economy as an important factor. The current design of The VIANOVA is focussed on the following:

- Whole vehicle platform design (specializing in hydrogen fuel cell powertrain)
- Lean weight chassis design
- Hydrogen system design and integration
- Fuel cell system design and integration
- Motors and EV drives

The interior of the VIANOVA (Figure 2) has several materials implemented that contribute to circularity. Interior panels are made from PLA, a highly recyclable thermoplastic; PP/JUTE (Ecobulk material) is used for parts; and lastly, ABS and GRP is implemented in the interior.



Figure 2: Interior of the VIANOVA

The body consists of several body panels, as illustrated in Figure 3:

- front clip (large front segment with electronics incorporated and bonnet incorporated)
- Two door panels (doors)
- Two rear side panel (fenders/wing)
- Roof
- Rear bumper
- Rear trunk lid

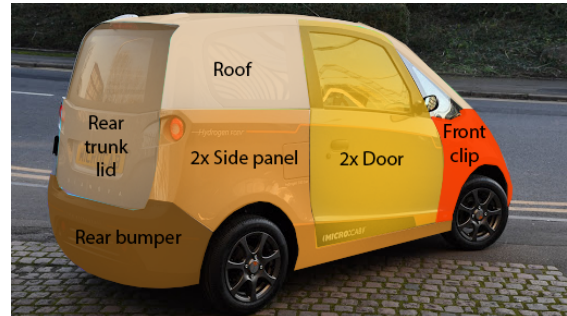


Figure 3: Body Panels.

2.1.2 The goal: Increasing repairability in a circular economy

Microcab wants the company to shift towards a circular economy. In order to do so, one strategy is to increase the repair capabilities of the VIANOVA. It was decided within Microcab to focus on the front section of the VIANOVA, specifically the front clip. considering it is such a large element. All elements of the front body section are incorporated in that panel (figure 4). This is common practice in a prototype phase and derived from motorsports vehicles. This allows for quick (dis)assembly (with quick release systems) during a pit stop.

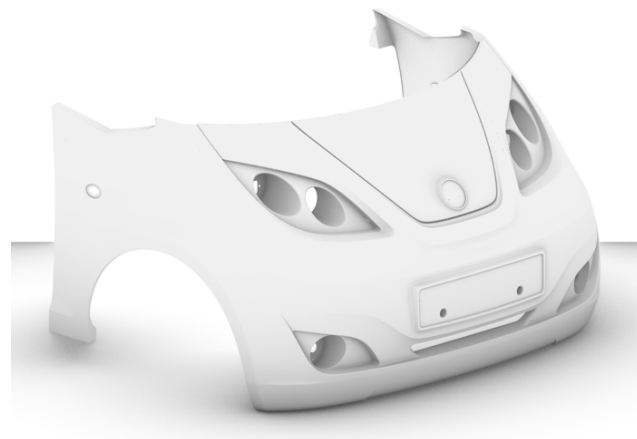


Figure 4: Front clip VIANOVA

The current VIANOVA is the result of 10 years of research and design. The front clip, however, is not suitable for road-safe vehicles, especially when damaged, increasing costs when in need of repair or replacement.

Currently, Microcab has built 10 VIANOVA's, but Microcab wants to increase the volume to 250–500 units annually with a production start volume of 100 units. The current design is not viable for such a production volume. The body panels are hand-built using GRP material, which is a difficult and time-consuming procedure: one front clip takes 16 hours to be built. Although the material is recyclable, it involves an extensive procedure (Stella Job, 2013). The final body panels are traditionally spray-painted with automotive paint. The estimated costs to produce one front clip are £630 (see Appendix A for a breakdown of the manufacturing process and costs). Microcab is aware of these issues and is investigating possibilities for improving the design; for example, splitting the front clip into several body panels. This is part of the final concept due to the overall benefits, which will be reviewed in this report. The goal is to eventually increase the repair capabilities of the front section of the VIANOVA in a circular economy.

2.1.3 Problem definition

This paragraph describes the problems relating to the front clip. Further details of the configuration are reviewed to gain an improved understanding of the problem. Photographs of the front section of the VIANOVA were provided by Microcab, Appendix B reviews a selection of these. These photographs and a CAD file were the basis of the analysis. Several aspects required improvements:

1. Assembly/disassembly
2. Materialisation
3. Pedestrian and overall safety

Assembly/Disassembly

The current VIANOVA is designed as a prototype. The material is defined in the previous paragraph. The front clip is directly mounted onto the chassis of the VIANOVA. When damaged, the process of removing the front clip is required to perform repairs. The front clip is connected to the chassis at four different areas, with a total of 12 points. Figure 5 illustrates important measurements and the fastening locations listed below:

- Two points behind the licence plate holder directly bolted to the bumper beam using a small bracket. This beam is directly bolted to the two front frame rails (the cylinder-shaped beams). These act as a crash absorber that protects the occupants.
- Four points at the top below the windscreen.
- Three points at each side in front of the doors (one at the middle and two at the bottom)
- Each point is fastened through a small hole on both parts with a standard a steel hex combination.
- Modular headlights provided by Hella.

A further problem is that impact at low speeds is likely to result in extensive damages, especially at an angle. The red arrows in Figure 5 illustrate an impact. When the VIANOVA impacts an object in a similar situation, it is possible that the front clip might deform or even crack and detach from the chassis. This is due to the lack of support under the body and the way the front clip is mounted on the chassis.

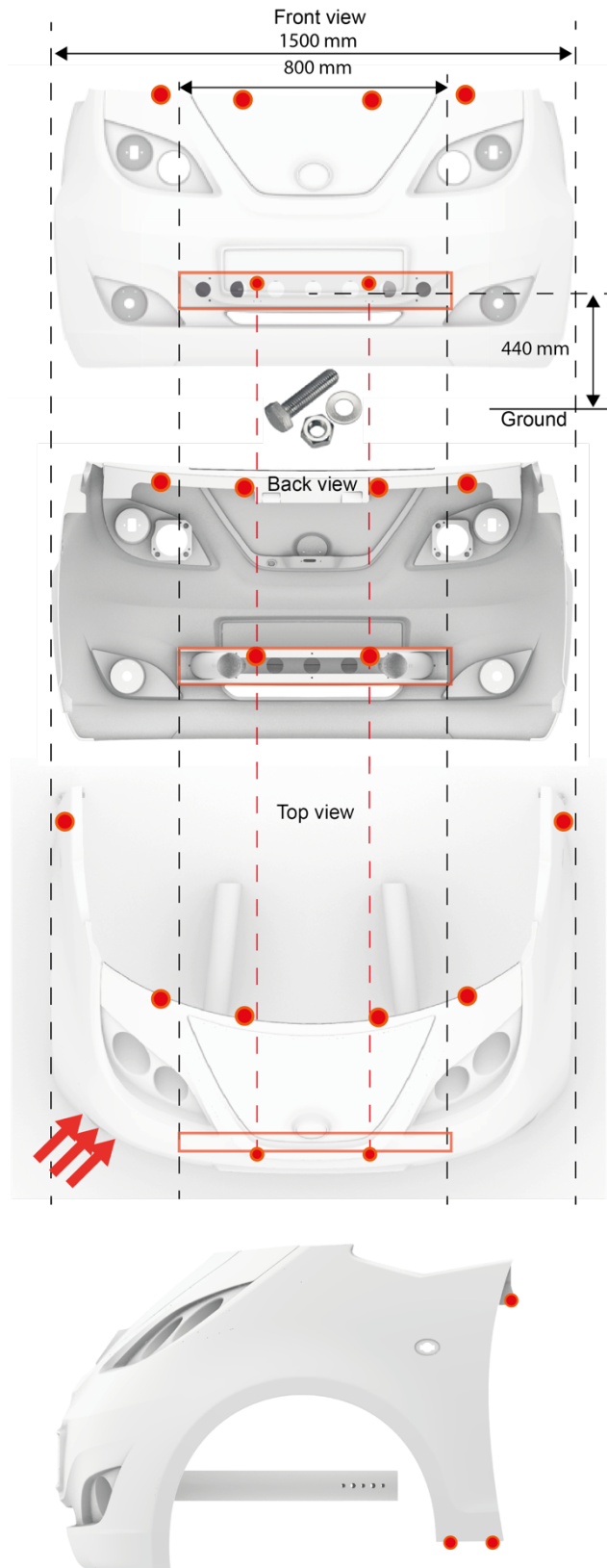


Figure 5: Fastening locations and measurements

Materialisation

The current material configuration creates several issues concerning the repairability, the front section being one part. When damage occurs, additional materials are required to repair the GRP material. The process of repairing a GRP-type material is difficult and also involves adding harmful chemicals (Appendix C). The GRP material is lightweight and has good mechanical properties; however, its application is not common in high production volumes and limits circular capabilities. It is typically used for specialist low volume vehicle production, such as race cars or customization parts (Boon, 2011).

Pedestrian and overall safety

It was later discovered that multiple safety issues are present that needed to be addressed before the VIANOVA could become a road-safe vehicle. Data provided by a BMW damage expert during a qualitative interview (Appendix D) substantiated these findings and stated these issues.

It was also realised that the current front section is likely to injure a pedestrian due to the exposure of internal components and lack of support to absorb the energy (figure 6). Note that the large panels are not supportive; they merely act as dampening for loud road noises. Considering that the front clip is likely to fracture, the number of hard and sharp objects within the front section can therefore increase the risk of injury to a pedestrian. The lack of energy absorption increases this risk. This also influences the internal components: the engine, motor management computer, and battery are all close to the impact zone, which also increases risks.

Lastly, the current front clip has a small bonnet, limiting access for maintenance, which is directly locked on the front clip itself. It was recommended to not lock the bonnet to the body since during a collision the bonnet is part of the impact zone in the current situation. This increases the risk of damage, thus potentially increasing costs. The bonnet should be locked on the chassis, which is also true for the headlight clusters. These should be located away from the impact zone.

To conclude, these problems regard the front section of the VIANOVA, especially in urban situations, where low-speed impacts are probable. The front section required several iterations in order to create a vehicle that is easy to repair without increasing costs significantly and provide an ability to increase circular capabilities of the body panels, regarding reusability and recyclability, since the current design allows for a continuous flow of virgin material throughout the lifecycle of the VIANOVA. The following sub-chapter describes this in-depth and helps create an understanding of circularity and how it can influence Microcab.

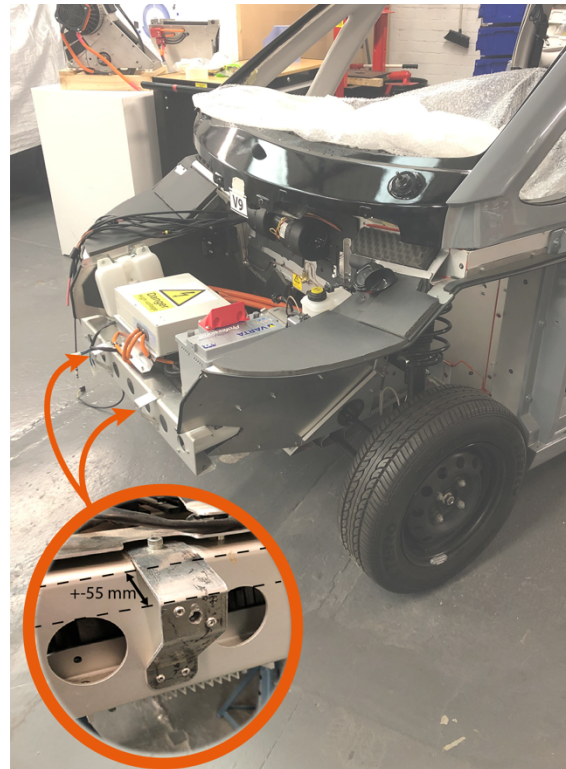


Figure 6: Exposed front section VIANOVA

2.1.4 Circularity for Microcab

This paragraph reviews the current lifecycle of a VIANOVA and how circularity can influence it. A clear definition of a circular economy is provided to understand what a circular economy is (Ellen Macarthur foundation, 2017):

'Looking beyond the current take-make-waste extractive industrial model, a circular economy aims to redefine growth, focusing on positive society-wide benefits. It entails gradually decoupling economic activity from the consumption of finite resources and designing waste out of the system. Underpinned by a transition to renewable energy sources, the circular model builds economic, natural, and social capital. It is based on three principles:

- *Design out waste and pollution*
- *Keep products and materials in use*
- *Regenerate natural systems'*

Therefore, in order to increase circularity, Microcab should evaluate possibilities for lowering the use of virgin material, allowing for more reuse and repurpose in the lifecycle. Within the current lifecycle of 20 years, the VIANOVA and its parts should be either repaired (reused), refurbished (repurposed), or recycled. The project focussed on the front clip. This part is designed to give the vehicle a certain aesthetic value, provide safety, and improve aerodynamics.

Figure 7 shows the current expected lifecycle, which consists of three stages:

- Building
- Modernisation and refurbishment
- End-of-life.

Between these stages, there are several material flows in and out of the vehicle; for example, those involving repairs and maintenance, and allowing for the opportunity to update the design. These material flows are relevant for this project in order to define where it is possible to lower the flow of virgin material. This is a key aspect of shifting towards a circular economy.

The illustrates also illustrates, that at each stage, virgin material flows into material in use. A small percentage is recycled material; for example, the interior panels and the likelihood of a general mix of recycled materials. Furthermore, the chassis is made from aluminium, providing the opportunity – when reuse is not possible – to recycle it. As stated in the problem definition, the body panels require virgin material during repair.

Current lifecycle

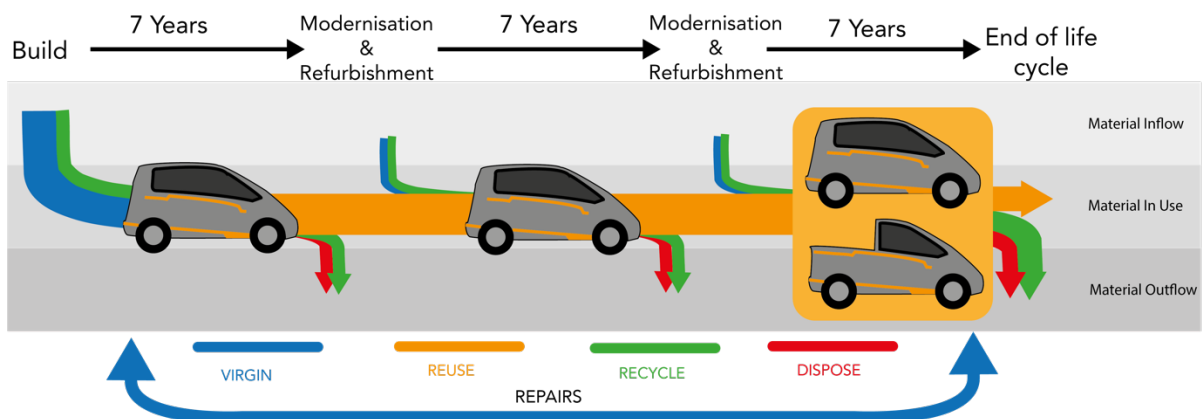


Figure 7: Visualisation of current lifecycle.

An Ideal future scenario lifecycle is illustrated in Figure 8. This lifecycle represents the goal of Microcab regarding a circular economy. It illustrates the increase in recycled and reusable materials, especially during repairs. Ultimately, the body panels are reconfigured to such an extent that they are completely circular.

Ideal future lifecycle

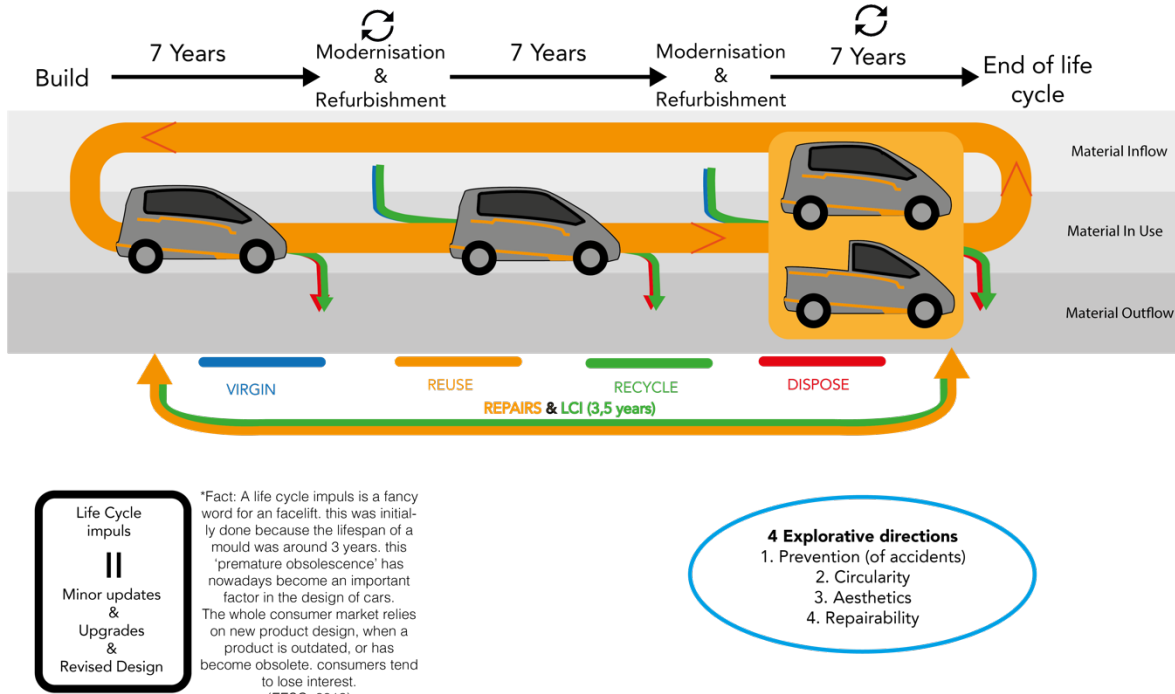


Figure 8: Visualisation of the improved lifecycle.

The future lifecycle scenario helped determine four key areas to further research and create solutions for the final concept. These areas helped create directions to explore in-depth and provide substantiating data to create a viable concept.

2.1.5 Stakeholders

Based on the fact that Microcab remains in ownership of the vehicles, a list of stakeholders was formed to set boundaries for the project. Table 1 reviews these relevant stakeholders.

Internal stakeholders	External stakeholders
Board of directors	First-hand users
Engineers and designers	Second-hand users - Pedestrians - Other drivers
Service and maintenance	Municipalities/government
Investors	Manufacturers
	Suppliers - Body panels - Headlight clusters (Hella) - Others

Table 1: Stakeholders

Parts are designed in-house. This allows the company to design their own parts and have a certain degree of freedom in decision making. The vehicles are also assembled in-house; most of the parts, however, are outsourced. For example, the body panels are built and manufactured by a generic company specialised in hand lamination. The chassis is supplied by Lotus.

Based on the project and the goal of Microcab, the majority of the stakeholders were considered. This is reflected in the list of requirements.

2.2 Research questions

Guidelines and wishes early in the process helped defined the research question ‘*how can Microcab increase the reparability of the VIANOVA in a circular economy?*’ and how this project can help contribute to answering this complex question. At the start, the focus was on the reparability of low-speed impact damages. However, halfway through the process, an issue regarding safety surfaced in which it was discovered that the front clip of the VIANOVA is not safe for pedestrians and that the internal components will also damage easily on impact.

It was decided to take all relevant safety issues into account for further analysis. This led to broadening the scope, including safety as an important factor. This led to the main research question visual in Table 2. The sub-questions helped define the direction of the project and determine the scope; the context remained a circular economy.

	Research	Design
Main Question	<i>How can Microcab design the front section of the VIANOVA to increase the reparability and solve the safety issues?</i>	
Sub questions	<ol style="list-style-type: none"> How is the automotive industry changing and what are the current trends? Which parts most likely need repair? How can pedestrian safety be improved and comply with safety regulations? How are safety and reparability linked? What is the material flow of the VIANOVA? What are the functional requirements for the body panels? What material offers the best functional properties within the context and requirements set by a circular economy? 	<ol style="list-style-type: none"> How to design body parts for repair? What are the limitations in changing the design of body panels? How can concept design help create a safe and repairable VIANOVA? How to create solutions for these limitations?
Analysis	<ul style="list-style-type: none"> * 2.1.4 (Lifecycle analysis) * 3.1 & 3.3 (Trends and bumper analysis) * 3.2 (Frequent car damages) * 3.4 (Repair and safety analysis) * 3.5 (Materials and surface finish) 	<ul style="list-style-type: none"> * 2.3 (List of requirements) * 4 (Concept generation) * 3 (Research data) * 4.4 (Embodiment)
Results	<ul style="list-style-type: none"> * 7 (Conclusion) * 8 (Recommendation) 	<ul style="list-style-type: none"> * 5 (Final concept) * 6 (Concept evaluation)

Table 2: Research questions

2.3 List of requirements

In order to facilitate a solution that is substantiated, a list of requirements and wishes was constructed based on the wishes of Microcab, stated early in the process, and information was gathered throughout the research phase of this project. The focus of the list is on the front section. This list is the foundation of the final concept and helps determine the most viable solution.

1. IMPACT PERFORMANCE	R1.1	The product should remain intact to impact speeds up to 15 km/h.
	R1.2	The product should absorb energy at the start of a crash and guide the remaining crash forces into the rest of the body structure (Macey, 2014).
	R1.3	At higher speed: to guide the crash forces into the body structure in such a way that the probability for a disintegration of the body structure is low and the survival of the occupants is ensured (Macey, 2014).

	W1.1	At low and medium speed: to minimize the damage of the vehicle in order to reduce costs (Macey, 2014)
2. ENVIRONMENT	R2.1	Automotive vehicles should use materials to make a 95% recycle rate realistic (ARN, 2019).
	R2.2	The product should achieve standards regarding environmental weathering: ASTM G154, ASTM D4329, ASTM D4587, ISO 4892, SAE J2020 (Intertek). An example is 8 hours ultraviolet exposure at 70°C, followed by 4 hours of condensation at 50°C for multiple cycles.
	R2.3	The product should lower the virgin material inflow during lifecycle.
	R2.4	Increased the ability to reuse or repurpose parts prior to recycling
3. LIFE IN SERVICE	R3.1	Has to perform for at least 20 years
	R3.2	The design should allow for ease of dis- and reassembly (Bakker, 2014).
	W3.1	The design should allow for upgradability and adaptability (Bakker, 2014).
4. MAINTENANCE	R4.1	The product should minimize impact damage to speeds up to 30 km/h.
	R4.2	The design should allow for ease of maintenance and repair (Bakker, 2014).
	R4.3	Parts must be removable by one maintenance worker.
	R4.4	Maintenance and repair should be outsourceable.
5. QUANTITY	R5.1	The solution is producible with a start volume of 100 units with an annual production of 250–500.
	W5.1	After 3.5 years, the product should allow for upgradability and/or Adaptability.
6. PRODUCTION FACILITIES	R6.1	The product must be in agreement with the Microcab guidelines of vehicle changes.
	W6.1	It should be manufacturable within the UK.
7. SIZE AND WEIGHT	R7.1	The product should not change the exterior dimensions.
	R7.2	The product should not increase the weight by more than 10%.
	W7.1	The solution should not add weight.
8. STANDARDS, RULES AND REGULATIONS	R8.1	Follow international standard for automotive quality management: IATF 16949 (British Standard Institution, 2021)
	R8.2	The product should follow standard road/travel safety regulations, starting with the UK.
	R8.3	The product should follow the Directive 2000/53/EC (ELV directive, focusing on end-of-life vehicles (ELVs) that aims at dismantling and recycling of ELVs in a more environmentally friendly manner). (European Commission, 2020)
	R8.4	The product should follow the Directive 2005/64/EC (type-approval of motor vehicles regarding their reusability, recyclability, and recoverability; (European Commission, 2020).
	W8.1	(<i>recommendation</i>) possibly achieve following ISO standards in the future: ISO 9001 (quality management), ISO 14001 (environmental management), ISO 45001 (health and safety) (global Certification Body, 2021)
9. ERGONOMICS	R9.1	Body panels should be easily removable during service and maintenance.
	R9.2	Internal components in the front section should be easily accessible.
	R9.2	Fasteners should be easily accessible.
10. RELIABILITY	R10.1	The solution should remain intact to driving speeds up to 100 km/h.
	R10.2	The product should be durable enough to allow for annual dis-/re-assembling
	W10.1	In case of product failure, the product must not create a more dangerous situation than the current one
11. SAFETY	R11.1	At speeds from 0 to 20 km/h the product should lower the risk of injury to pedestrians.
	R11.2	At speeds above 40 km/h, the product should guarantee occupant protection.

	R11.3	The product should protect important components at all speeds.
	R11.4	The product should not contain sharp corners or edges to guarantee maintenance safety.
	W11.1	The product should not interfere with existing safety measures.
12. PRODUCT POLICY	R12.1	The product must treat servicer and maintenance accordingly to company guidelines.
13. SOCIETAL AND POLITICAL IMPLICATIONS	W13.1	The product should have a positive influence on the general public.
14. INSTALLATION AND INITIATION OF USE	R14.1	The product should be applicable to all future vehicles of Microcab.
15. AESTHETIC, APPEARANCE AND FINISH	R15.1	The product should fit the brand image.
	R15.2	The product should remain appealing.
	R15.5	The finish of the product should remain in good condition for 3.5 years.
	W15.1	The product should visualise 'econess' in the design.
	W15.2	The product should fit within the future of Hydrogen mobility.

Table 3: List of requirements and wishes

2.4 Project methodology

The goal of the project was to develop a solution for a practical problem. The defined problem allowed for the scope to be clearly defined in the early stages of the project, created a clear direction for this applied research. Through prior obtained knowledge of the automotive industry, literature research, field research, and qualitative data provided by BMW, a solution has been created. In order to structure the data, prioritize relevant activities, create a focus, provide viable data for Microcab, as well as portray skills as a concept designer. Two main project methods were chosen: a 1:10:100 approach and reflective practice. This allowed for an iterative process throughout the project. The next two paragraphs briefly describe the two methods used.

2.4.1 1:10:100 approach

At the start of this project, it was important to create a structure. Together with the supervisory team, it was decided to use one main project method: 1:10:100 (Van Turnhout et al. 2013) to keep the work structured. This method is often used for open-ended design projects where there is no clear direction of the preferred solution upfront. Within the scope of this project, there was a preferred solution upfront mentioned by Microcab. However, this was intentionally excluded from decision making, making the method still applicable in this context. The 1:10:100 method relies on going through three complete design cycles lasting 1, 10, and 100 days (Dorst, 2006). After each cycle, an evaluation session was held with the supervisory team to reflect on the progress. Figure 9 illustrates the process in a pyramid. Refer to Appendices E and F for the results of cycle 1 and cycle 10, respectively.

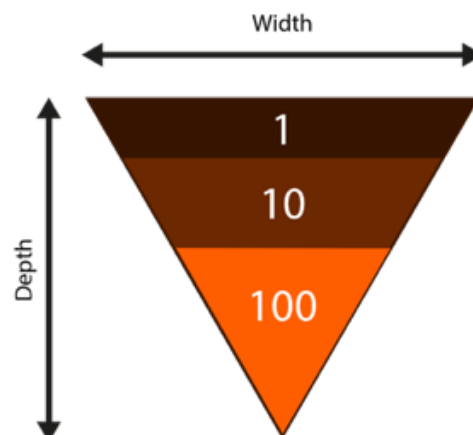


Figure 9: 1:10:100 Pyramid

2.4.2 Reflective practice

Throughout the project, reflective practice was important to ensure insights were well integrated into the project. The 1:10:100 method allowed for these reflective moments early in the process, helping to identify the scope and direction of the project. The combination of these methods led to a fully iterative process in which there already was a basis of the project/report at the start of the research but allowed for continuously iterating to come to this final report.

Every three weeks, a progress meeting with the supervisory team led to co-reflection, and personal reflections were conducted throughout the time span of the research at random. Figure 10 illustrates the process of the three cycles combined with reflection between each stage. Refer to Appendix G for all personal reflections.

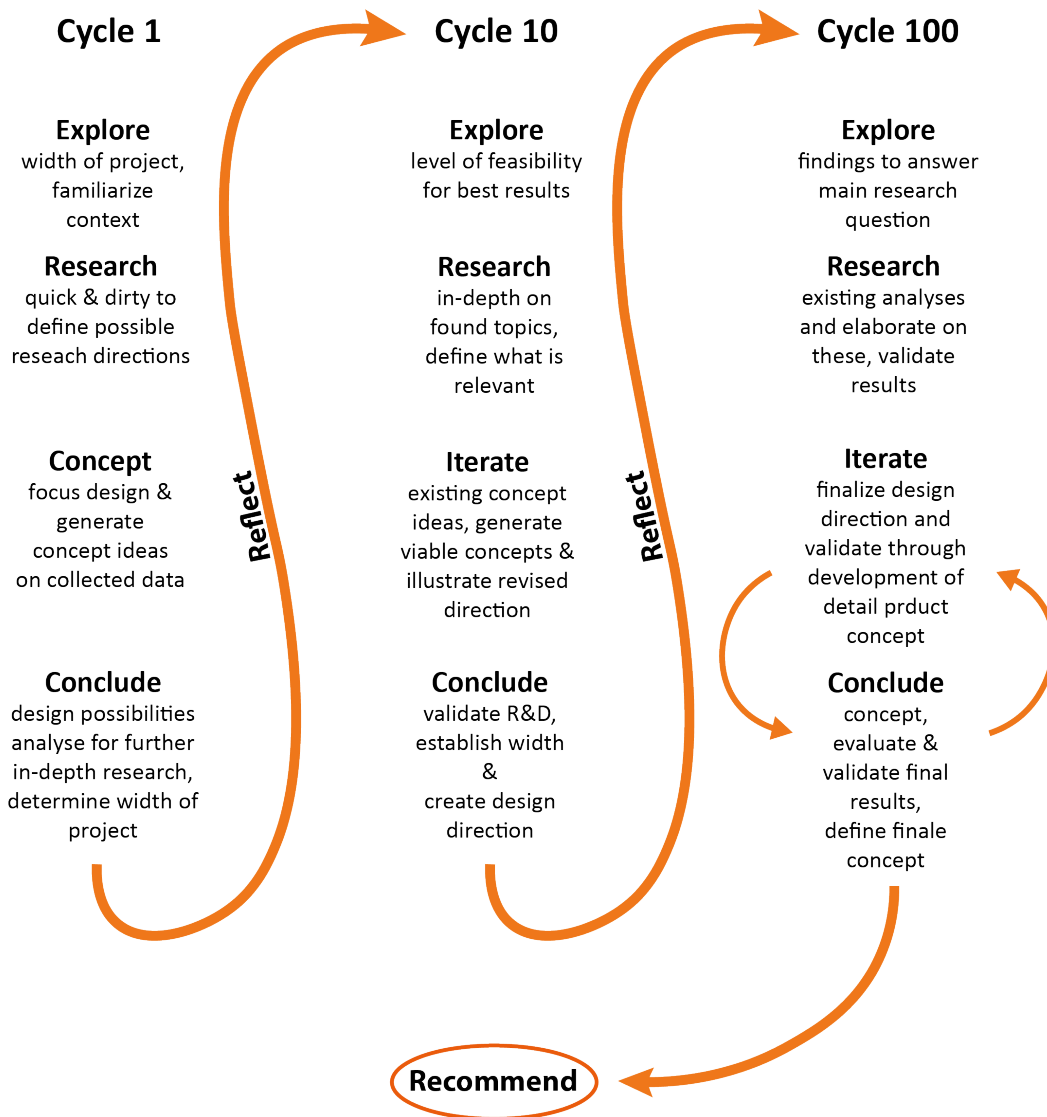


Figure 10: Schematic illustration of the process of 1:10:100 and reflective practice

3 RESEARCH

In order to determine relevant information to substantiate certain decisions and follow the list of requirements and wishes, further analysis was done within the automotive industry. Primary and secondary research data has been collected and reviewed in this chapter. Starting with an Automotive trend analysis that helped determine the direction the industry is heading. Furthermore, the automotive bumper is described and how it obtained its general shape. And lastly, in-depth research into existing repair and safety measures, as well as circular measures are analysed to provide substantiated data for the final concept.

3.1 Automotive Trend analysis

The automotive industry is changing. People are increasingly willing to use different ways of transportation, especially through a sharing platform. More than one in three kilometres will be driven on a sharing platform by the year 2030 (PWC Global, 2020). Several trends and shifts in the automotive industry helped determine the vision of Microcab and the thought behind their ethos. Table 4 reviews a selection of automotive trends that are interesting for Microcab and substantiate certain decisions they made in the past.




Automotive Trends	
1.	'Hydrogen is the future' according to Shell (2020). 
2.	All new cars sold in the Netherlands by 2030 need to be 100% electric, either using a battery, hydrogen fuel cell, or solar energy (Rijksoverheid).
3.	Starting in November 2020, consumer vehicles with diesel engines are only allowed in the centre of Amsterdam with emissions class 4 or higher. (Amsterdam.nl)
4.	The state of California in the USA plans to ban sales of new gas-powered cars in 15 years (The New York Times).
5.	Global EVs (including PHEVs) sales up 43% in 2020 (Cleantechica, 2021).
6.	BMW has committed into a limited production series of hydrogen-powered X5 (SUV) scheduled for the consumer in 2022 (BMW). 
7.	The share of autonomous driving is expected to rise with 40% in overall traffic by 2030 (PWC Global, 2020).
8.	The annual growth rate for shared-mobility solutions is expected to exceed 20% through 2030 (PWC Global, 2020).
9.	Honda will leave Formula 1 after the 2021 season. Because of their goals to become CO ₂ neutral by 2050, they are invested in new resources such as fuel-cell-powered vehicles and battery-powered vehicles (Honda).
10.	Lynk & Co sharing platform (Volvo & Geely); their catchphrase being: 'experiences over ownership'. starting at the end of 2020, this new company will provide a sharing mobility platform for electric vehicles by membership (lynkco.com). 

Table 4: Automotive trends

Based on these trends, renewable energy sources, sustainability, and circularity are key in order to survive in the automotive sector. PWC Netherlands (2019) stated that the automotive future will be electrified, autonomous, shared, connected, and updated yearly by 2030. Consumers are losing interest in 'ownership' and the market share of sharing platforms is increasing annually. This means that Microcab can have a significant influence on the market if they create a favourable market position.

3.2 Frequent automotive damages

The most frequent damages occur to the front bumper of a car. Table 5 shows the top five damages in NL, UK, and the USA (top 4), with item 1 being the most frequent damage. Sources from three parts of the world show that the front section of a car is involved in the majority of accidents, whether one- or multi-sided. Percentages were not shared (except parking 18% parking, NL), but the table clearly illustrates that over 86% (respectively 80%, 80%, and 100%) of combined damages occur at the front section of a car. This helped substantiate the decision to focus on the front section of the VIANOVA. Furthermore, it helps to determine the specific areas of the front section that are relevant, considering the VIANOVA does not have a grille.

	A. ABS Schadeherstel (NL) (2019)	B. Brighton Panel works (UK) (June 24 th , 2019)	C. Carpro (USA) (2019)
1.	Bumper	Front bumper	Front bumper
2.	Scratches and Paint	Front and rear doors	Headlights
3.	Windows	Car bonnet	Fenders
4.	Dents	Fenders/wheel frames	Grille
5.	Parking (18%)	Grille	

Table 5: Frequent damages

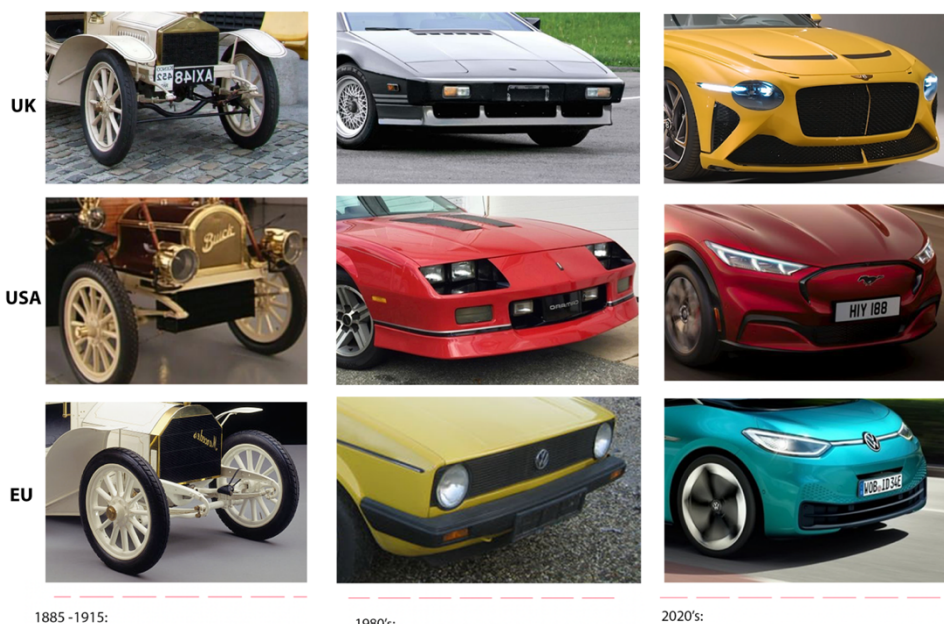
Further details in the damage patterns on passenger cars are that 26% is directly to the front (12 o'clock direction), with an overall rate of 51% on the front section of a car (Kurebwa, 2018). The most common types of damages that occur on the front bumper are the following (BPG, 2018):

1. Scrapes and scratches
2. Dents
3. Cracks
4. Bends

This quantitative data aids in determining solutions that lower the chances of these types of damages occurring and also substantiates the decision to focus on the front section of the VIANOVA.

3.3 Development of the front car bumper.

The design and configuration of the front section of the car have changed since the car became part of the infrastructure. To gain a better understanding of where the shape from a bumper comes from, a historical analysis of the development was conducted. Figure 11 illustrates a section of the timeline. For the complete timeline and additional information, refer to Appendix H.



1885-1915: 1980's: 2020's:
Figure 11: Section of historical timeline of car bumper

Since the start of the automotive industry before the 1900s, the shape of vehicles in general has changed significantly. Where a bumper used to have a merely aesthetic function, in time due to regulations, bumpers started to change shape. Especially between the 70s and 80s, bumpers started to differentiate (Knauf industries, 2020). Prior to that era, the bumper was often mounted on the body of the vehicle. During that time period, Plastics started to increase in popularity for car manufacturers due to safety regulations, especially regarding pedestrian safety (Miller, 2006).

In modern cars, the visual bumper has become part of a bumper system. The system generally consists of three parts, illustrated in Figure 12. The metal bumper beam is hidden behind the bumper fascia, generally referred to as the 'bumper'. The bumper beam functions as a safety measure to absorb the energy from a high-impact collision. It acts as a crumple zone to lower the energy before it is transferred to the passenger compartment and lowers the risk of injury for pedestrian and other road users. However, it also has sufficient strength to protect nearby internal components (Beyene, 2014). The energy absorber acts as a dampener to absorb energy from any collision and also lowers the risk of injury regarding pedestrians. The bumper fascia characterises the aesthetics of the vehicle and decreases the aerodynamic drag force. The fascia is a non-structural component and cannot handle the energy of a collision (Nasiruddin, M. Et al. 2017). Further analysis of the front bumper system resulted in the general configuration of the front section of a car. This is typically divided into the elements listed below:

- **Bumper:** A sacrificial frontal part, easily exchangeable/repairable when damaged, protecting more valuable body panels.
- **Fender/wing:** The side portion of the front of a vehicle, usually containing the majority of a wheel arch opening and side indicators.
- **Headlight cluster:** Area of the front dedicated to housing the majority of the front-facing lighting. Often easily accessible and removable for servicing/replacement.
- **Bonnet:** Hinged access point to motors and components within the interior of the front section.

Figure 13 illustrates a schematic representation of the front clip divided into the above-described segments. Further field research on existing cars was executed to determine how the split lines are part of the design (reviewed in Appendix I).

The combination of this primary and secondary data allows for a better understanding of a traditional front car section, and how segmentation of the VIANOVA front clip into multiple panels can help increase ease of maintenance and reparability. The data from the literature review reveals the current standard in modern road-safe vehicles. It lowers the material outflow after a small damage, and in result, lowers the virgin material inflow considering only a section has to be repaired/replaced.

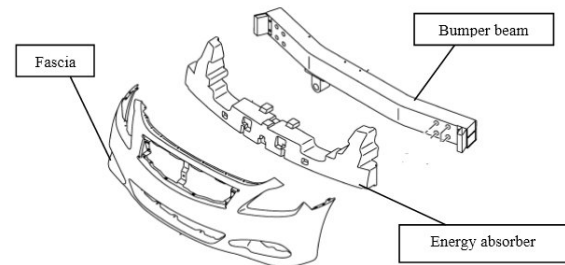


Figure 12: Schematic view generic bumper system (Nasiruddin, M. Et al. 2017)

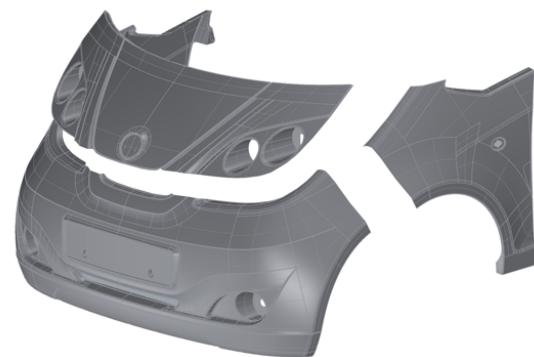


Figure 13: Sectioned front clip

3.4 Repair and safety

In order to determine further possibilities for increasing the reparability and shift towards a road-safe vehicle, research into existing repair and safety measures was executed. Through literature review and a qualitative interview at a local BMW damage department, data was acquired and describes in this paragraph. It reviews several aspects that increase the reparability and safety performance of a car.

3.4.1 Safety means

Safety in the automotive sector can be split into two different means: *active safety* and *passive safety* (European Aluminium Association, 2011):

1. **Active safety** refers to advanced driver-assistance systems in a vehicle, or ADAS for short. These systems help the driver avoid or reduce the severity of an accident (Mobility insider, 2020). Several systems were further analysed for possible incorporation (Appendix J). Due to the scope of the project, no systems were implemented in the final concept. Chapter 5.2 reviews the related reasoning.
2. **Passive safety** includes all components of the vehicle that help lower the risk of injury for the occupants and second-hand users, while also reducing the damage during an accident.

Figure 14 illustrates several examples of both means. The following paragraph reviews relevant passive safety measures that are located in the crumple zone, and have a positive influence on reparability.

3.4.2 Synthesis

Based on the problem definition, there is a clear path to follow to determine valuable data to achieve the goal. The following paragraphs describe several elements regarding passive safety measures that influence the reparability.

Bumper beam

The current bumper beam of the front section is comparable with the left illustration in Figure 15. The bumper beam is a supportive structure that reinforces the front section of a vehicle. This helps absorb energy during collisions at higher speeds. Certain guidelines govern the placement of the beam in the bumper ‘band’, measuring between 405 and 508 mm (S. Macey, 2014). These guidelines are designed to offer the most protection during high-speed accidents. The current height of the VIANOVA bumper beam meets these guidelines (Figure 16). The beam is mounted on the frame rails, these ‘tubes’ act as the crumple zone to protect occupants during a collision. Research has shown with the use of finite analysis method that the VIANOVA protects its occupant during a frontal impact with speeds of up to 40 km/h (Grimes, O. et al., 2013). The bumper offset is the space between the furthest point of the front bumper and the important components, such as the headlight cluster and bonnet. Further research in strengthening the bumper beam for normal consumer vehicles has shown that changing the geometry of the bumper (widening it) improves the energy absorbed during low-speed impacts, especially during collisions that are not perpendicular on impact. Up to 10 km/h, the absorbed energy with the standard bumper was 0.18925 Joules; with the iterated bumper, it rose to 136.29 Joules (Sonawane, 2018), making an increase in the length of the bumper an



Figure 14: Example of safety measures

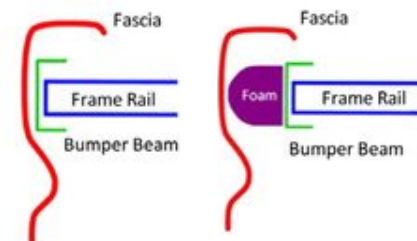


Figure 15: Generic bumper section views (Davoodi et al, 2020)

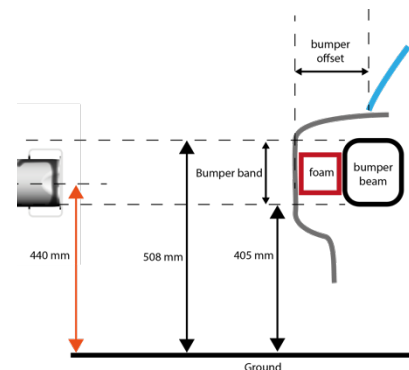


Figure 16: Microcab bumper beam vs. generic section car bumper

improvement, Increasing the support of the body panels (increasing repairability) and lowering the risk of injury of a pedestrian. Lastly, typical bumpers can vary in shapes, sizes, and materials. Microcab and most car manufactures use steel or aluminium. Research into comparing three materials (aluminium, GMT and SMC) in a bumper beam resulted in SMC having the best results from a lifecycle point of view. It is also easy to manufacture, reduces weight, and uses low-cost material (Marzbanrad, 2009). In a circular economy, aluminium is preferred due to recyclability.

Energy absorber

Figure 17 shows an example of a BMW i3 and its energy absorber. The photograph also illustrates other components that improve the overall structure of the front section (right illustration in Figure 15).

Adding an energy absorber increases the overall support of the front section of the VIANOVA, it also stabilizes the front body panel and helps keep its shape, which increases repairability (I-car, 2015). It was also found that the repair costs for collision speeds of up to 32 km/h with an energy absorber were lower than the conventional bumper with collision speeds up to 18 km/h, resulting in an overall costs advantage of 4% (Danner, 1978). Furthermore, when using a type of plastic foam, the impact force was reduced by 30–48% depending on type and dimensions (Philippic, 2020). It was also found that an X-shaped conceptual bumper energy absorber (Figure 18) can provide a good alternative, lowering the weight while maintaining safety measures (F. Mo et Al, 2018). The material is similar to ordinary foam energy absorbers and is made of Xenoy (PC/PBT 1103), a plastic blend that is recyclable (Sanches, 2007). Lastly, it was found that an energy absorber can be manufactured with optimised TPO, delivering a 40% cost saving and 10% weight reduction versus conventional PC/PBT and GMT material (Sohn, C. 2013)

Support and fastening

Generally, support increases the repairability. Increasing the number of body panels requires additional support: the panels should not only be connected to each other but fixated separately to the chassis. Figure 19 illustrates two sections of a structure that helps support body panels and creates points to fixate the panels. It also creates the possibility of locking the bonnet on the chassis using the front cross member. Furthermore, the upper load path beam creates the ability to fasten the wings to the chassis. Additionally, this structure increases the protection of the internal components.

To introduce the possibility of fastening the panels to the chassis, further research in different types of fasteners was conducted. Review Appendix K for an overview of the different types of fasteners. Generally, multiple combinations are used to fasten a body panel on the chassis. Typical fasteners are illustrated in Figure 20.



Figure 17: Photograph of BMW i3 with removed front bumper

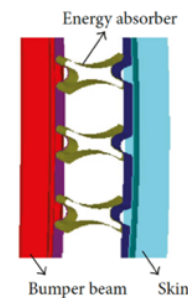


Figure 18: Conceptual energy absorber (F. Mo et al, 2018)

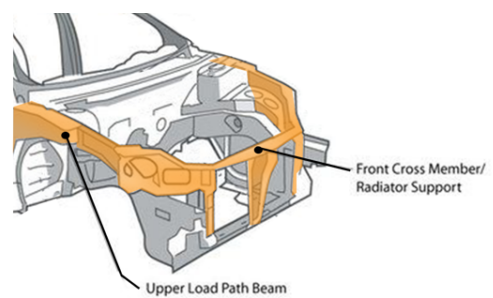


Figure 19: Schematic view Support structure Front section (edited Macey, S. 2014)

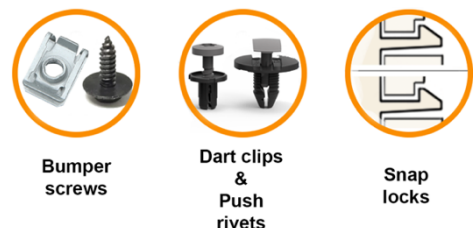


Figure 20: examples of fasteners

As described in the problem definition, the VIANOVA uses a hex bolt combination. This is not necessarily an inappropriate fastener. However, due to the way the front clip is fastened, it is likely the panels will tear. Changing to plastic fasteners helps keep the body panels intact and allows for the fasteners themselves to break, lowering the damage incurred to the panel, considering there is ample space to move. To create more support in current vehicles, an additional constructive part between the body panel and support structure is added. Figure 21 shows an example of the bumper bracket of a BMW. It includes the fasteners but also has a large area that supports the body panel, allowing for improved support and increased energy absorption during impact. Refer to Appendix L for more images of a bumper and its fasteners. These bumper brackets also absorb energy, allowing for the bumper to remain intact. Generally, filling in the negative space within the front section allows for the body panels to remain in its original shape and increases the ability to absorb energy. This was substantiated by the damage expert. The downside of a mechanism such as this one; are the additional costs: it is only manufacturable with injection moulding, which is considered a costly process in low production volumes.



Figure 21: Fastening mechanism BMW bumper

To conclude, a list of the elements that have a positive impact on the goal is summarised in Table 6.

Relevant data insights	Contributes to
Extending the length of the bumper beam	Lowers risk of injury for pedestrians
Low-speed energy absorber	Increases surface area energy absorption
Plastic fasteners	Increases repairability and impact performance
Support structure	Supports the body panels
Multiple body panels	Increases ease of (dis)assembly
	Lowers repair costs.

Table 6: Summary repair and safety insights

3.5 Circularity

In order to increase the overall circularity of the VIANOVA, literature review involving materials and surface finishes of automotive body panels was conducted. The data retrieved in the previous paragraphs help increase repairability by potentially lowering the damage during a collision, which resulted in increased circular capabilities regarding reusability and the ability to repurpose parts. Considering materials that have beneficial recycle capabilities can potentially close the loop and create a circular part by lowering the inflow of virgin material, thus increasing circular capabilities for Microcab. The data retrieved during this part of the research provide insights in materialisation and surface finish that benefits the VIANOVA regarding circular capabilities.

3.5.1 materials

As stated in the introduction, the current GRP material is accompanied by several complications. The current composition being a thermoset creates difficulties for the production volume and overall circular capabilities. Some companies work with natural fibres, providing sustainable options within motorsports body panels or car interiors (Bcomp, 2018). Considering the production volume Microcab wants to achieve, this is currently not a

viable solution, considering that it requires a similar production process as the current GRP material regarding the body panels, resulting in high costs.

The current type of material is still popular in low production volumes, and thermoset composites been popular in the transportation industries, but during the millennial change, thermoplastics started to increase in popularity. One of the reasons was that Thermosets are limited in repair after production due to the non-reversible curing process, and thermoplastic composites have the ability to be softened with heat and be remoulded without degradation. These cycles can be repeated, giving the material an almost indefinite shelf life (AZO materials, 2001). Furthermore, thermosets require high energy input in processing, giving thermoplastics improved recycling capabilities, considering that thermoplastics can be shredded and reheated to form a new product (Post, 2019). Consequently, this means that using a thermoplastic material can extend the lifecycle and lower the flow of virgin material. In modern vehicles, thermoplastics already are common.

The following plastics are most commonly used (Euric, 2020):

1. PP (32%)
2. PU (17%)
3. PVC (16%)

PP is primarily used for plastics body components. These plastic components represent around 20% of the average car weight. Appendix M reviews an overview of plastics used in the automotive industry, with its specified application. Another material used for bumpers is ABS, which has slightly different characteristics (Ashby, 2010). Appendix N reviews the different characteristics of these two materials. In the automotive industry, PP body panels generally refer to a TPO-type material (ACplasticsinc, 2020). TPOs are blends of PP with EPM or EPDM. Automotive parts typically have an EPDM blend due to the added flexibility in production it gives, and EPM is used for roofing and hose products (PARKER, n.d.)

Generally, increasing the amount of EPDM promotes a more homogeneous dispersion of external forces inside the material, decreasing the risk of fracture (Luda, M.P. et al, 2013). Adding fibres promotes a stiffer product and is therefore more frequently used for constructive parts. Figure 22 reveals the material composition of a BMW rear bumper made from TPO, illustrating that it contains PP and EPDM with 15% talc. Talc is added as a filler to lower the material costs (BMW, 2020). Front bumpers often contain a lower percentage of talc, increasing flexibility and required to better disperse energy during an impact. Concerning for small damage repairs on either thermoplastics or thermoset, typical processes do not differ. Regarding both types of materials, a liquid filler is applied and refinished to blend with the rest of the body. However, similar to metals, several plastics can be welded. Appendix O provides detailed information about plastic welding (Badell, 2017). Being able to weld the material creates an additional repair method, extending the lifecycle of a plastic bumper and the ability to reuse the part. Furthermore, TPO (PP) is one of the easiest plastics to weld (Kingplastic, 2011).

To conclude, shifting towards thermoplastic materials seems to be the most viable direction, considering the circular capabilities and self-healing properties when introducing heat (Subranmanian, 2017). Small scratches can be faded by the use of a heat gun or even reshaping it. This allows for the ability to reuse or repurpose a part before recycling it, creating a preferred scenario in a circular economy.

3.5.2 Surface finish

Two surface finishes have been analysed to determine what can further help Microcab to achieve circularity: the current method of spray painting and the method of wrapping a car (Figure 23).

Aerosols (spray paint)

The surface finish of the VIANOVA is spray-painted. Microcab uses acrylic aerosols. Acrylic paints started to make ground in the early 2000s when governments required reductions in VOCs (ERA environmental, 2020). Early automotive paints contained high

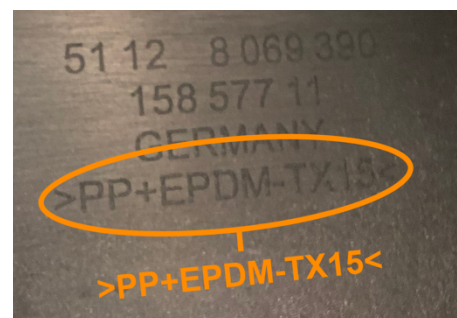


Figure 22: Material BMW bumper



Figure 23: Schematic representation of wrapping vs spray painting

concentrations of these VOCs and have a negative impact on the environment and health of the people closely working with the paints. During the shift, over 75% of car manufacturers shifted towards acrylic paints (Collisionprosinc, 2020). However, the damage expert at BMW stated that in modern surface finish treatment, the top clear coat is still often applied using some form of chemical agent. Therefore, although labelled as acrylic, it still requires special solvents; specifically, the top clear coat. Therefore, even though paints have improved, there still exists a negative impact when using automotive paints. Doing so also requires multiple steps to remove the painted surface finish before the material underneath can be either repaired or recycled. The surface needs to be sanded down to gain access to the material underneath. The sanded paint turns into dust that is not easy to collect and separate and is likely to be released into the environment. Appendix P reviews the process of painting a car.

Car wrapping

Car wrapping became popular in 2014, with an increase of interest in car wrapping of over 75% (Mediadevotion, 2018). The process is mostly used to personalize a vehicle or as advertisement, Appendix Q contains an infographic that illustrates the steps of wrapping a car (APEX customs). This principle in surface finish has several benefits and limitations. Generally, it protects the material underneath better and has the ability to self-heal small scratches. The material is softer than paint, which allows for scratches to fade in the sunlight more easily. It is nevertheless strong enough to maintain its shape and position. It also helps separate the surface finish from the body panel more easily since it can be removed without leaving any residue. This allows for improved recycling of the material underneath. A limitation of a typical (vinyl) wrap is the material used. PVC is the main component, and a variety of solvents is added to make it flexible.

Shifting from spray paint towards a wrap therefore allows for an increase in reparability and improved separation of harmful materials. Further research led to finding another alternative. 3M provides an eco-friendly variant, a PVC-free wrapping material with 58% less solvent content called 3M Envision. There are several different versions, and the durability is 11 years. Refer to Appendix R for the technical specifications (3M, 2020). This wrap is already used on refuse trucks in the UK (figure 24). Additionally, marketing at BMW Driving Experience verified that, when vehicles wrapped for promotional use, the sustainable models – such as the BMW i3 – use this specific material.



Figure 24: Briers refuse truck (recycling & waste world, 2016)

Considering the characteristics of both processes, spray paint requires steps in order to remove it and is not scratch resistant compared to a wrap, which is easy to remove and slightly softer, allowing for scratches to fade in heat. Wrapping the body panels seems a suitable solution. During concept generation, the final choice is discussed.

3.6 Aesthetics

Microcab is evaluating possibilities for improving the reparability through the aesthetics of the VIANOVA and is willing to change the overall design of the vehicle. The current design of the VIANOVA is shown in Figure 25. Although the appeal of the design is subjective and therefore difficult to compare, the car has the appearance of a traditional small vehicle with some additional design features. Redesigning the VIANOVA by creating a future-proof design that visualises that it differentiates to the traditional could potentially increase a positive perception from the public; for example, visualising it as a hydrogen-powered vehicle. Initially, there was discussion regarding redesigning the VIANOVA completely to create a



Figure 25: The Microcab VIANOVA

more outspoken design in keeping with a hydrogen future and visualising durability. A mood board was created to reflect this futuristic design (Appendix S). Another direction was to visualise 'econess' in the design; for instance, by showing the material it is made of. Further research in visualising durability and this 'econess' led to Citroën. In some models, Citroën emphasises a form of a 'pillow' design, such as the current Citroen C3 (Figure 26). These small inserts at critical areas help protect the body at low-speed collisions.



Figure 26: Side and front view of Citroën C3. See above.

These Airbumps® are made from thermoplastic TPU, filled with air, and mounted on a PC and ABS support shell. This structure is directly fixed to the metal chassis to then act as a cushion (BASF, 2014). Implementing this can create a certain design that reflects durability. However, considering the requirements of a circular economy, the goal to lower virgin material and the fact that Microcab is still a relatively small company where funding is important, this currently not perceived as a viable option, support is limited in the front section, and implementing even more parts would require more R&D to discover if it is desirable. There is no substantiation that this design lowers the overall costs during ownership and considering the added materials, R&D work and the added parts required to fixate, it was decided not to further research this. Citroën changed the Airbumps® in their newer designs, shifting towards a more traditional design (Figure 27). The reasoning behind this may be due to the additional costs that are required and that the public might not find it visually pleasing.



Figure 27: C4 Cactus 2014 vs C4 Cactus 2018

Another possibility is to implement modular bumper guards in the design, but the benefits of this method are not substantiated, and the vehicle can even be perceived as outdated, considering that bumpers in the 90s had plastic bumper trim to protect the body. Refer to Appendix H for visual representation. Based on these insights and the scope of the project, it was decided not to further pursue this area. The final concept implemented splitting the front clip into multiple segments. This influences the aesthetics since it creates panel lines. The list of requirements also states that the goal is to minimize the aesthetics. Therefore, this is not implemented in the final concept.

4 CONCEPT GENERATION

A concept has been created to solve the problem and help achieve the initial goal of Microcab. Figure 28 illustrates the decision to focus on two areas out of the four explorative areas derived from the lifecycle scenario due to the scope of the project. These two directly influenced each other and helped maintain a balance in creating the final concept.

Prevention and redesigning the aesthetics are not incorporated in the final concept. Microcab are currently working on implementing autonomous driving. Therefore, implementing preventative systems during this research would have been redundant. It also does not focus on improving repairability, but simply trying to prevent it. It also does not aid in creating a more circular vehicle.

The aesthetics focus on futureproofing the design and adding elements on the exterior to potentially improve repairability. The goal was to directly increase repairability and create a foundation to shift towards circularity. The only element of repairability that influences the aesthetics in the final concept are the panels lines that split the front clip. Lastly, the solutions that improve repairability directly improved the safety issues. The following paragraphs describe the elements of the final concept that facilitate the goal and how these were implemented.

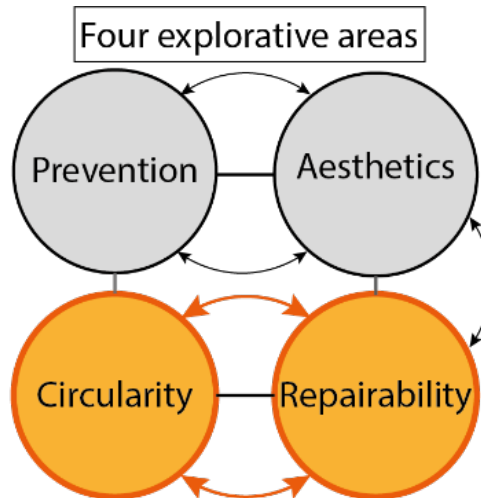


Figure 28: Explorative areas

4.1 Design development

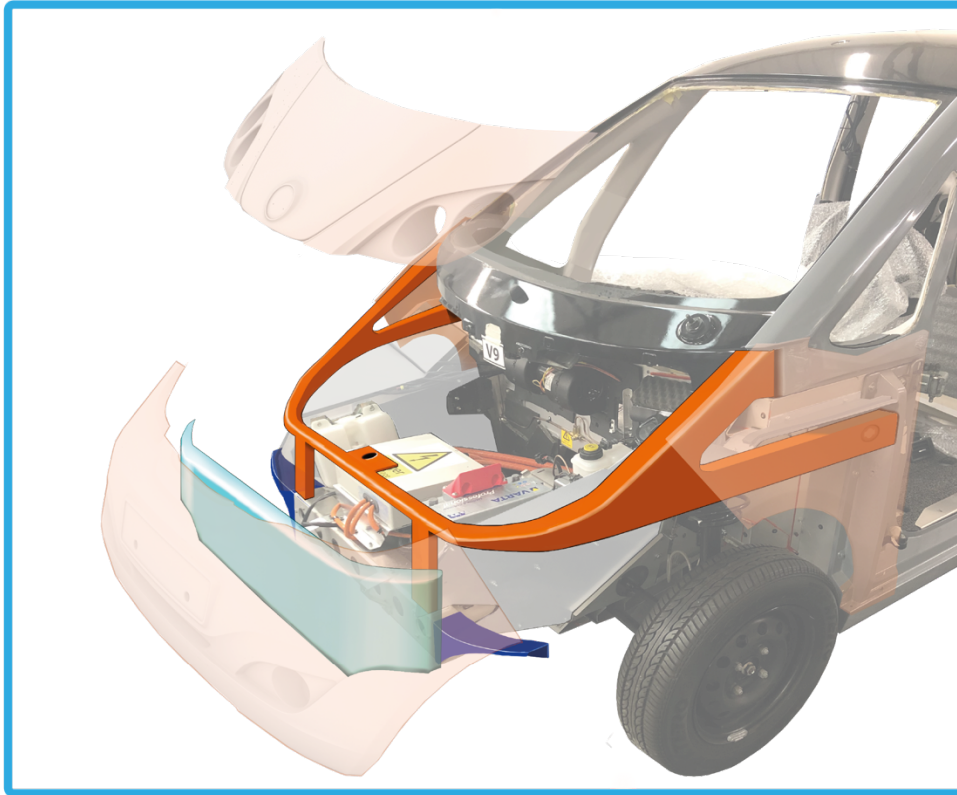
The final concept is developed by incorporated multiple elements that contribute to the goal. By combining these, problems are addressed and based on the research data required in order to significantly improve the reparability and safety and shift towards a circular economy. Table 7 illustrates the final configuration through a morphological chart.

MORPHOLOGICAL CHART

Prevention		ADAS	Other								
Aesthetics		'airbumps'	'econess'								
Repairability and safety	Segmentation Front clip	Wing / bumper									
		Bonnet / bonnet									
	Fasteners	Fasteners	screws & clips		Quickloc	Plastic Push rivets	Snap locks	Click bonds	Magnetic Fid locks	Quick release	Slide mechanism
			Support structure	NONE (current)							
			Energy absorber	NONE (current)							
			Bumper Beam	standard							
Increasing circularity	Materialisation Body panels	TPO	ABS	Other							
	Surface finish										

Table 7: Morphological chart

Implementing multiple elements was required in order to create a road-safe VIANOVA that meets the list of requirements. Figure 29 illustrates a visual presentation of the elements implementing in the front section of the VIANOVA. Provided is brief explanatory feedback on what each element contributes.



Energy absorber
Soft material component that absorbs energy during low-speed impact. lowers risk of injury of pedestrians

Support structure
- Upper load beam
- Cross member
* Locking bonnet on chassis
* support for body panels

Segmentation front clip
Large bonnet for increase acesibility during maintenance
TPO material for circular capabilities

Extended bumper beam
Increased surface offering protection againts impacts on a angle, for example during parking

Plastic fasteners
Decreases risk of tearing and breaking of body panels

Surface finish
Implementing a wrap as surface finish, PVC-free sustainable option

Figure 29: Final concept illustration

4.2 Increasing repairability and safety

This paragraph reviews the relevant additions to the VIANOVA regarding repairability and safety. Each subparagraph describes the part and why it is incorporated into the final design.

4.2.1 Segmentation front clip

Splitting the front clip was possible using multiple methods. Figure 30 and 31 illustrate these methods, respectively, the side view and front view. Starting with the side view, it was initially preferred to separate the headlight cluster into single parts and directly fixate them to the chassis based on the data provided by the BMW damage expert. Figure 29 elaborates on the advantages and disadvantages of incorporated headlights in the bonnet and separating them in individual parts.

Reviewing separation of the headlight clusters with Microcab resulted in the headlight clusters being incorporated into the bonnet. This would require fewer moulds during manufacturing and no need for additional brackets and fasteners, thus creating an easier implementation in the VIANOVA. Regarding the wings, it was decided to go with version 2, considering that it is the shortest distance from the wheel arch to the headlight cluster/bonnet, creates perpendicular corners that increase safety, and was perceived as most visually pleasing.

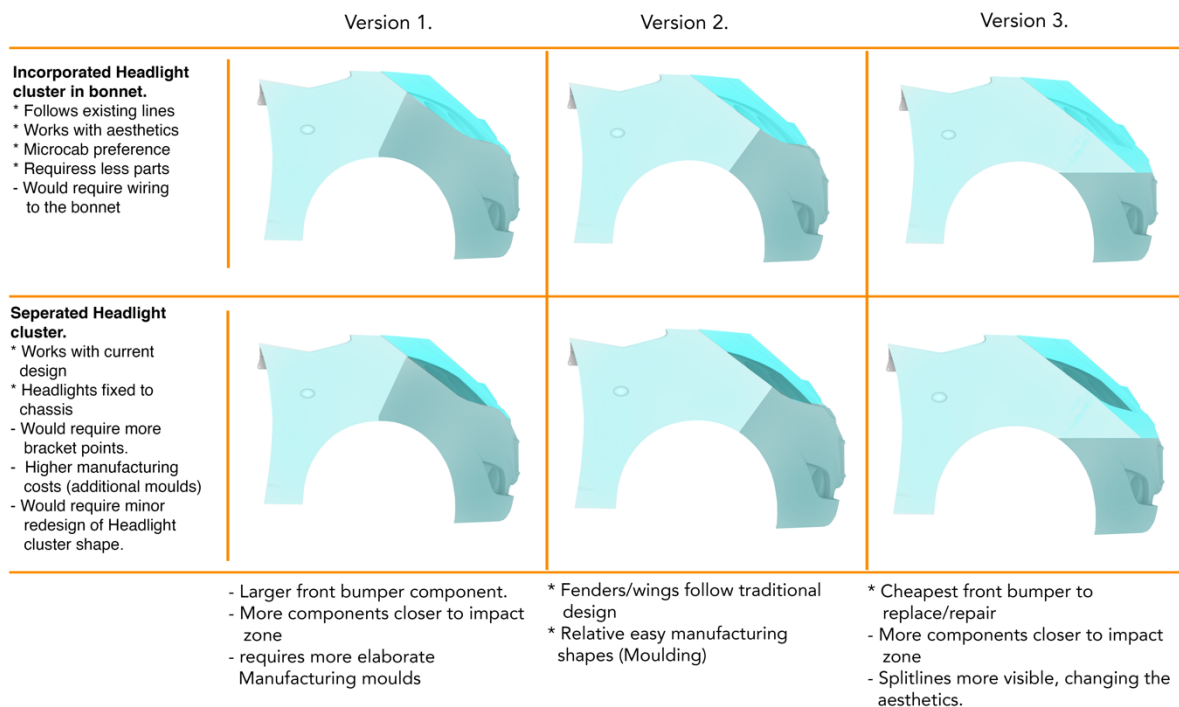


Figure 30: Sideview body panel iterations

Furthermore, incorporating the headlight clusters in the bumper was also reviewed and compared to incorporating them in the bonnet. This is visible in Figure 30. Reviewing the front view, it is visible how the split line divides the bonnet/headlight cluster and the bumper.

Considering the impact zone at the front, other parts should be kept on a distance. Version 2 allows for improved separation from the impact zone. During a low-speed impact, the headlight cluster and bonnet should remain in position, considering the bonnet is fixated to the chassis, which will be reviewed in the next chapter.


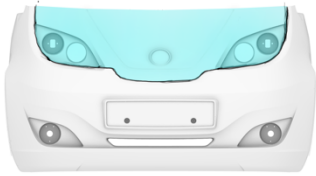
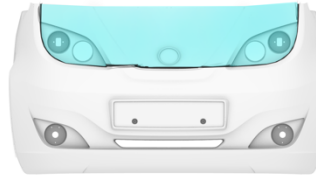

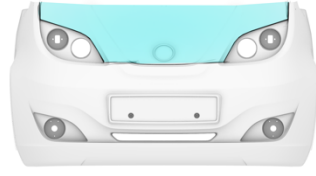
	Current design	Version 1	Version 2
		<p>Version 1</p> <p>Follows the lower horizontal Design line</p> <ul style="list-style-type: none"> * Fits well in the design * Increases accessibility of internal components - Bonnet closer to impact zone 	<p>Version 2</p> <p>Follows current horizontal split line</p> <ul style="list-style-type: none"> * Fits in the design * Increases accessibility of internal components * Away from impact zone
Headlight clusters incorporated in bonnet			
Headlight clusters incorporated in bumper			

Figure 31: Front view body panel iterations

The final design regarding the separation of the front clip into several body panels is illustrated in Figure 32. This design creates a certain mechanical distance between the bumper and the bonnet with incorporated headlight clusters. It helps keep the damage during a low-speed impact clustered at the bumper and provides an efficient compromise with the headlights being incorporated in the bonnet, which consequently increases the ease of implementation and lowers investment costs, as well as regarding the limited ability to support them individually.

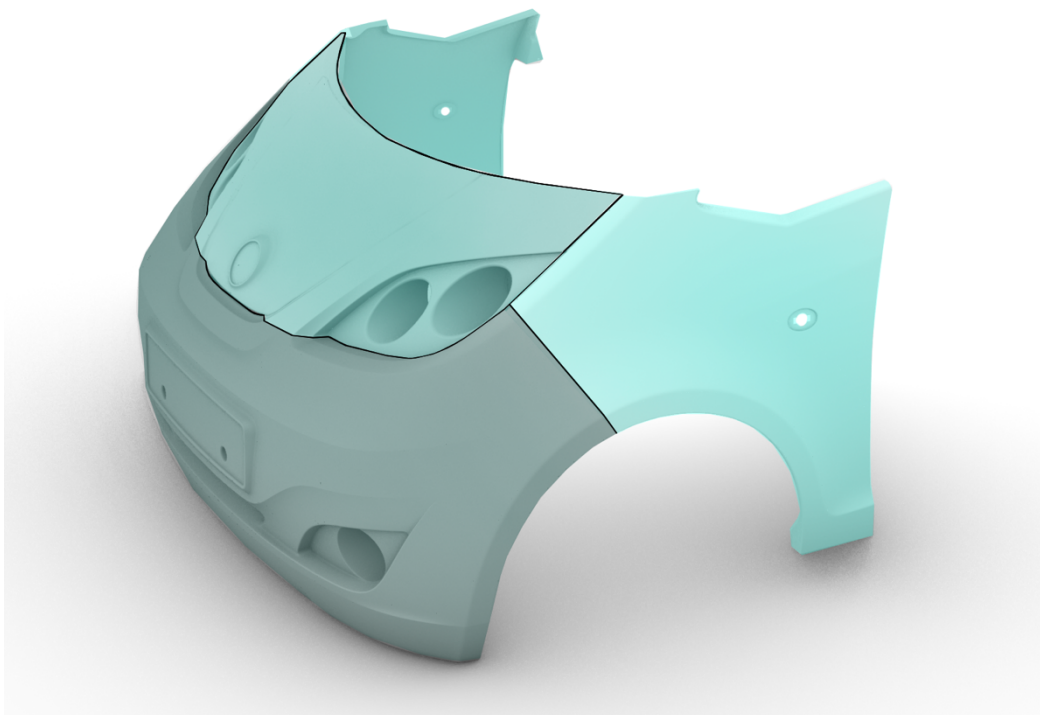


Figure 32: Final configuration segmentation

4.2.2 Support and fastening

In order to support the new body panels of the front section, support systems and fasteners are required. This in effect also increases the ability to absorb energy during an impact, increasing the reparability and offer more protection, lowering the risk of injury to a pedestrian or damage. It is important that each panel is fixated individually on the chassis and that the chassis of support. Specific fasteners help lower the change of damage to the panel. supported on the chassis. Each part has to be fixated with a specific type of fastener to lower the chance of damage to the body panel. The following elements are required to make this possible.

Constructive support

Based on the research, two specific parts are required in the front section to support the panels and allow for bracket points to fasten the panels. The main reason for these parts is the increase in overall protection and energy absorption, increasing overall repair capabilities and safety. Figure 33 illustrates a schematic representation of an upper load beam and a front cross member incorporated in the front section of the VIANOVA. Additionally, the lock mechanism is highlighted. This is an important aspect, considering the bonnet should be fixated to the chassis and not the bumper. The combination of this support system helps increase the overall stiffness of the front section, also aiding in lowering the movement of the body panels, based on the fact that there is less negative space in which the panels can move. At both sides, a bracket system will be incorporated, together with a cross member at the front that allows for the bonnet to be locked on the chassis. Both elements increase the overall stiffness of the front section, allowing for less movement of the panels. Figure 32 illustrates this in a schematic matter.

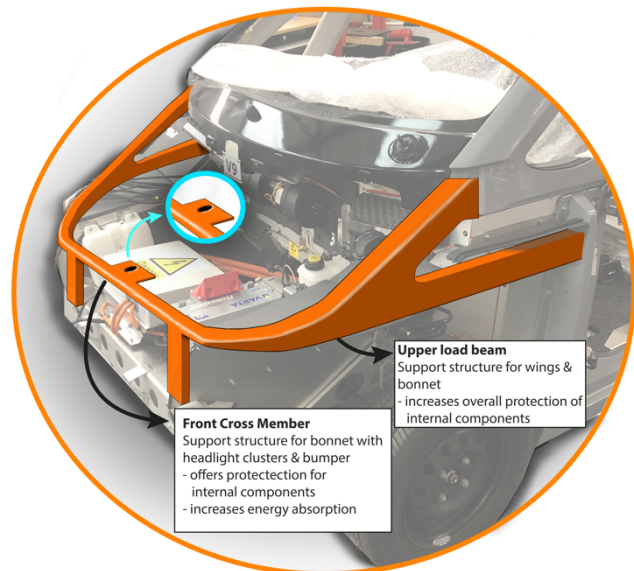


Figure 33: Illustrated support VIANOVA

Fasteners

In an ideal situation, all the body panels would be fastened with the use of plastic fasteners, specifically push-rivet-type fasteners or snap locks (Figure 34). In order to use these types of fasteners, however, it is required to use them in relatively large quantities, since they are easy to break. By increasing the number of fasteners, the force of an impact is spread evenly. Figure 21 illustrated the fastening system of a BMW bumper with snap locks. The downside of this system for Microcab is that it requires an additional part where the snap locks are moulded into. This is an injection moulded part, which will later be clarified as an unsuitable manufacturing process in this context, due to the feasibility. Therefore, the focus should be on plastic push rivets, compared to metal screws or hex bolt systems. In this scenario, the push rivet is more likely to break, instead of tearing the body panel.



Figure 34: Push rivets (top) & Snaps (bottom)

4.2.3 Low-speed impact energy absorption.

Elements that focus on improving low-speed impact energy absorption, inflicted damage, and risk of injury regarding pedestrians do so through two measures: increasing the width of the bumper beam and incorporating an energy absorber.

Bumper beam

The frontal surface area of the bumper beam is increased to protect the body structure during side impacts. This helps support the bumper during low impacts at an angle, decreasing the likelihood of damage since it keeps the damage in that area. The width of the bumper beam in the final concept is increased with 50%, but ideal measurements will require further analysis.

Energy absorber

Adding an energy absorber helps increase the resistance to an impact and lower the risk of injury of a pedestrian: it absorbs the energy, allowing for the bumper to maintain its shape, resulting in a decreased chance of damage.

Figure 35 illustrates the current configuration with a scenario regarding an impact force. This is compared to the concept scenario with the two elements. It illustrates how the added elements offer more support. During the embodiment phase, further analysis was conducted to determine the space in the front section of the VIANOVA and create a physical reference for further development.

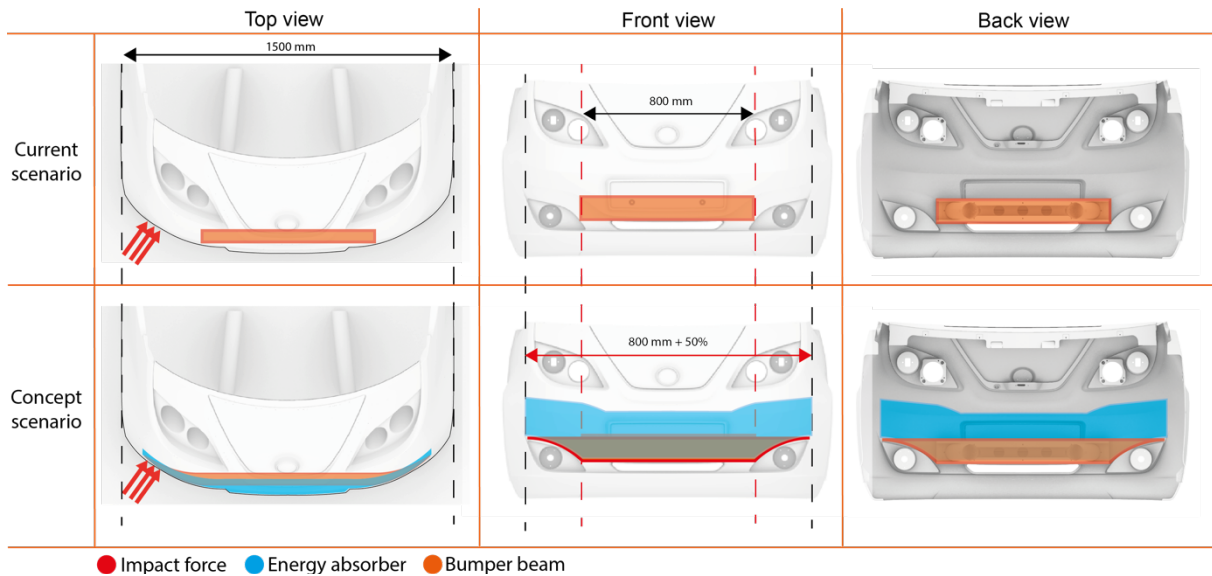


Figure 35: Schematic view of extended bumper beam and energy absorber

Both elements help increase the overall reparability. Due to the added support behind the bumper, energy is absorbed during impact protecting the body panels and lowering the magnitude of damage, thus increasing reparability. These elements are not required by law but offer a significant improvement regarding reparability and safety, making the VIANOVA a road-safe vehicle.

4.3 Increasing circular capabilities

Based on the elements mentioned before, the overall repairability should improve significantly, allowing for a longer lifecycle of the parts, due to the decrease in damage. This improves the circular capabilities. However, an ideal scenario for a circular economy is to close the loop. To further improve the reusability, repurpose ability and recyclability. It was decided to change the materials used for the panels and the surface finish. A consideration has been made regarding the support structure based on logics and current materials used in the VIANOVA. The following sub-paragraphs describe these selections.

4.3.1 Material selection

Given the context of the project to design for a circular economy, the most suitable material for the body panels is TPO. It is broadly available, relatively inexpensive, and will help Microcab to shift towards a circular economy. Due to the characteristics of TPO, it enables reusability and recyclability loops in a circular economy. The characteristics it carries that allow for easy and cost-effective repairs give Microcab the ability to reuse a bumper multiple times, extending the lifecycle. The recycle capabilities allow the material to be 100% recyclable, have a long-lifecycle, and be proven as a material preferred by large car manufacturers. TPOs offer the best characteristics for markets that require durability, it is designed to provide the optimum balance of stiffness, cold temperature impact and low thermal expansion (ImpactPlastics, 2017). To conclude, of the several TPO compositions that are possible, it is advised to use a composition with EPDM, common for car (front) bumpers, creating optimal characteristics regarding circularity and energy absorption. The other added elements of the final concept will require further analysis to determine the optimal material. Table 8 reviews some possibilities that provide a basis as a reference for further analysis.

Element of final concept	Material	Circular impact
Segmentation front clip - Bumper - Enlarged bonnet (with headlights) - Wings	TPO	This material allows for a closed loop due to the recycle characteristics and also improve reusability due to increased repair capabilities.
Fasteners	PE or PP	The fastener is more prone to break or tear, replacing the damage from the body to the fastener, lowering the input of additional material during repairs, increasing reusability.
Support structure	Aluminium	Aluminium is 100% recyclable, closing the loop of this material
Energy absorber	Start with PE → TPO or Xenoy (foam or double-walled)	Although this design adds more materials, they are 100% recyclable and improve the repair characteristics of other parts, lowering the input of additional material during repair
Extended bumper beam	Aluminium.	SMC is not recyclable but performs better from a lifecycle perspective (Witik, 2011). From a circular point of view, Aluminium is the better option because it closes the loop.

Table 8: Materials

4.3.2 Surface finish selection

Based on a circular point of view, wrapping the car is the preferred option. However, in large scale production, spray painting is typically more cost-effective. Further costs analyses will compare the pricing between the two surface finishes. Nevertheless, implementing a PVC-free wrapping material is most suited given the goal of Microcab: doing so contributes to the repairability and creates the opportunity to separate materials easily at end-of-life stage to improve recyclability.

4.4 Embodiment

In order to determine the available space in the front section of the VIANOVA, two scale models were created (16% of the initial size) with several additional parts illustrated in Figure 36. This aided in finding critical areas and help visualise the solution in a pragmatic manner. Review Appendix T for the whole process.

The first scale model (figure 37) represented the existing VIANOVA front section with the noise dampening aluminium panels and the current bumper beam. the second model (Figure 38) did not have these sheets, the motor management computer, or the battery (the two square shapes). These were removed to determine available space for the additional parts that are required and possible opportunities. The final concept allowed for a configuration in which all components fit inside the front section.



Figure 36: Scale models and parts



Figure 37: Scale model 1 based on current configuration.



Figure 38: Scale model 2

Critical areas

The limited space available in the front section is illustrated in Figure 39. The distance between the fastening location and the internal components is ± 50 mm: since the internal components are so close to coming into contact, available space is limited, and safety issues arise. Based on the pictures, it was already mentioned during the research phase that this can increase costs and the frequency of dangerous situations. Therefore, in a collision, even at low speeds, it is probable that these parts can be damaged. Another issue was the distance between the lower corner of the bumper beam and the design insert for the fog lights, illustrated in Figure 40. Even at low speeds, due to the sharp corners of the bumper beam, this might result in damages such as cracks since the body panel will directly hit this sharp corner. The inserts also limit the ability to extend the height of the bumper beam over the width of the front bumper.

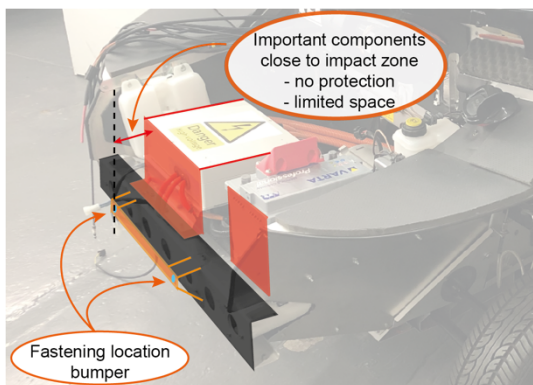


Figure 39: Schematic view of critical issue regarding internal components

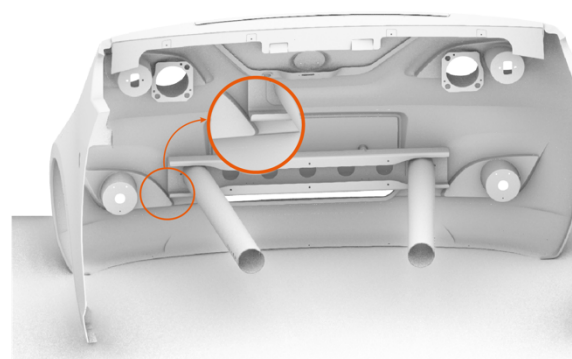


Figure 40: View of critical area between existing bumper beam and front clip

These insights helped set boundaries for the embodiment. The front clip was sectioned in the preferred configuration illustrated in Figure 41. With these panels and the scale models, iterations took place regarding support structures and the bumper beam. Furthermore, an energy absorber was added to gain a sense of how it influences the front section.



Figure 41: segmented front clip

Support structure

The body panels require the support structure in order to be fixated on the VIANOVA. Existing support is limited, and it is not common to fixate the elements on the bumper beam. Therefore, follow-up research is required to determine locations to mount the support elements. The overall dimensions are not representative for actual sizes but illustrate how the wins and bonnet are supported. This is visualised in Figures 42 and 43. The upper load beam and cross member are represented by a single element, which continues to the middle of the front section. The element creates support for the body panels, helps protect the internal components and provide constructive support for the locking mechanism of the bonnet.



Figure 42: Support structure



Figure 43: Support structure with bonnet

Bumper beam and energy absorber

Figure 44 illustrates the iterated bumper beam (also shown in Figure 43 in more detail) and how it fits the front bumper. Comparing this to the existing setup shown in Figure 39 helps create an understanding of how the bumper beam could be extended maintaining the current aesthetics. This is, however, an intricate bumper beam shape that can significantly increase the costs of the bumper beam. Considering this, it could also be possible to add a separate part at each side, maintaining the current bumper beam. This is illustrated in Figure 45.



Figure 44: Extended bumper beam iteration



Figure 45: Separate bumper beam extension parts iteration

In the recommendations, further suggestions regarding how to improve this matter and ensure that the bumper beam is supportive over the width of the VIANOVA are provided.

Figure 46 illustrates the front clip with this bumper beam and an additional energy absorber.

These elements incorporated in the front section gave a noticeable difference in overall stiffness. They aided in keeping the existing front clip in position and with the separated body panels provided support to fixate the panels in position. The increased surface area that absorbs energy is clearly visible, as well as how the increased width helps protect a larger portion of the front section.

Due to the scale of the model and a limited time frame, further research on where to fasten the body panels has not been analysed in the recommendations. However, where the critical areas are and how to fixate the added elements are discussed briefly.

To conclude, the embodiment helped determine critical areas of the VIANOVA. The models gave a clear representation of; the available space, the positive influence regarding energy absorption, and how the different elements are dependent on each other. It sets a base for follow-up research, which is required to further develop, and implement the elements of the final concept in the VIANOVA.



Figure 46: Existing front clip with extended bumper beam and energy absorber

5 MANUFACTURING AND COSTS

This chapter describes the manufacturing process of the revised body panels and also provides the most probable manufacturing process for the added elements in the front section of the vehicle. Furthermore, a cost estimation is provided for Microcab.

5.1 Manufacturing

The majority of the research is focussed on the body panels. Based on the required production volume of 500 units, a thermoplastic material such as TPO, and the investment costs, pressure forming is considered the most viable manufacturing process to produce the body panels. For further information regarding manufacturing selection, refer to Appendix U. Pressure (thermo)forming is most suitable due to the requirements regarding costs and production volume. Considering the other components of the final concept and based on common production methods used for the required parts and the expected production volume, possible manufacturing methods have been analysed and recommended based on the material and function. However, additional research is required to determine optimal manufacturing process, since this is dependent on final material selection, dimensions, and costs. Table 9 reviews each part with the selected manufacturing process to provide an overview and help determine necessary suppliers.

Element of final concept	Material	Manufacturing process
Segmented body panels	TPO	Pressure forming
Fasteners	PE or PP	N.A.
Support structure	Aluminium	Bending/piercing
Energy absorber	PE, TPO or Xenoy	Roto moulding or foam injection moulding
Extended bumper beam	Aluminium.	Extrusion/bending/cutting

Table 9: Required manufacturing processes for final concept

5.2 Cost estimate

A cost analysis was conducted to determine likely costs per VIANOVA considering the new front section. Costs were estimation based on data of existing parts, manufacturing processes and common sense.

This gave an estimated price that seems viable. Refer to Appendix V for an overview of the costs and relevant that resulted in this cost estimation. The costs are based on an annual production of 500 units over 4 years,

meaning 2000 units. With a lower production volume, prices could rise. Provided in Table 10 is an overview of the estimated costs based on the defined material and if the part will need specific parts or can be bought from a supplier.

Cost estimation per unit	Material	Type	Costs
Segmented body panels	TPO	Custom made	£225
Surface finish	3m Wrap	Stock acquisition	£170
Energy absorber	PP (TPO) or PE	Custom made	£20
Push rivets	PP or PE	Stock acquisition	£6
Support structure	Aluminium	Custom made	£256
Miscellaneous	N.A.	N.A.	10%
Total			£745

Table 10: Total cost estimation

This is a rough estimation but gives a clear representation of what it might cost. Eventually, parts such as the energy absorber and support structure can be produced in larger volumes considering it would need no updates, potentially lowering the costs. The costs are higher than the current front clip, but the desirability of the elements for Microcab justifies the higher costs.

Ideally, a rough estimation of the costs of ownership would have been provided, but in order to provide viable data, testing and additional knowledge is required regarding current estimates and new estimates. Given the timeframe, this was not possible.

6 CONCEPT EVALUATION

In order to evaluate the final concept, a simplified version of the list of requirements is illustrated in Table 11 below. The table reviews how the final concept meets the requirement and what further steps are required to achieve the goal.

Requirements and wishes	Impact final concept	Follow-up required
R1.1 The product should remain intact to impact speeds up to 15 km/h	The additional parts provide a stronger and stiffer front section, lowering the chance of severe damage	Physical testing and determining the optimal configuration
R1.2 The product should absorb energy at the start of a crash and guide the remaining crash forces into the rest of the body structure	The added support structures allow for improved distribution of the force during an impact	Physical testing and determining the optimal configuration
R1.3 At higher speed: to guide the crash forces into the body structure that the probability for disintegration of the body structure is low and the survival of the occupants is ensured	The current VIANOVA already has been tested and meets these requirements	New tests will be necessary to determine how to force is absorbed with the added elements
W1.1 At low and medium speed: to minimize the damage of the vehicle in order to reduce costs	Due to the separated body panels and added support structures, energy is absorbed, lowering damage, and inflicted damage is kept in a smaller area	Physical testing and determining the optimal configuration
R2.1 Automotive vehicles should use materials to make a 95% recycle rate realistic	The selected materials have recycling capabilities, increasing the recycling rate	Create a material index of the whole vehicle to determine the recycling rate
R2.2 The product should achieve standards regarding environmental weathering	The selected materials are proven in the context and are resistant to weathering	Determine if there are any critical areas that let weathering inside the front section
R2.3 The product should lower the virgin material inflow during the lifecycle	Four separate parts enhance reparability and lower material inflow because only the damaged element will need replacing	Execute a detailed lifecycle analysis of the VIANOVA

R2.4 Increased the ability to reuse or repurpose parts prior to recycling	the material and body panel configuration allows for improved reusability due to the increase of repairability	Determine optimal material composition
R3.1 Has to perform for at least 20 years	The selected materials are proven to have a long-lifecycle and can last a lifetime with proper care	Determine optimal material composition
R3.2 The design should allow for ease of dis- and reassembly	Due to the segmented front clip, accessibility is increased and provides better circumstances to dis- and reassembly	Determine ideal dimensions and location of fasteners
W3.1 The design should allow for Upgradability and adaptability	the body panels increase the feasibility to incorporate adaptability and upgradeability	Determine needs of general public
R4.1 The product should minimize impact damage to speeds up to 30 km/h	Based on the data provided, the added elements should significantly lower damage at low-speed impacts	Physical testing and quantify impact
R4.2 The design should allow for ease of maintenance and repair	Due to the enlarged bonnet, internal components are better accessible, and the separate body panels allow for increased ease of maintenance.	Determine ideal dimensions and location of fasteners
R4.3 Parts must be removable by one maintenance worker	Due to the significantly smaller panels, they are removable by a single person	Determine location of fasteners
R4.4 Maintenance and repair should be outsourceable	The concept shifts the VIANOVA towards a traditional car. This helps create familiarity.	Test with maintenance workers
R5.1 The solution is producible with a start volume of 100 units with an annual production of 250–500	Based on the material and manufacturing process, the final concept is producible with the given production volume	Find suitable supplier that can facilitate manufacturing
W5.1 After 3.5 years, the product should allow for upgradability and/or adaptability	The separated body panels and material allow for quick and easy adjustment throughout the lifecycle	Determine needs of general public
R6.1 The product must be in agreement with the Microcab guidelines of vehicle changes	The progress has been discussed with Microcab, and whether aspects were desirable for Microcab was considered	Discuss internally if the final concept is in agreement
W6.1 It should be manufacturable within the UK	Coventry provides a wide network that manufactures for the automotive industry,	Find suitable supplier that can facilitate manufacturing
R7.1 The product should not change the exterior dimensions	The final concept did not change exterior dimensions, maintaining the current shape and aesthetics.	To improve energy absorption, design might require iterations. Analyse the design and create space for improved implementation of the parts
R7.2 The product should not increase the weight by more than 10%	This has not been tested, but probable that it will exceed this requirement	Determine overall weight of added elements and decide what is most feasible for the VIANOVA
W7.1 The solution should not add weight	This was not possible	Determine maximum allowed weight in order to maintain functionality
R8.1 Follow international standard for automotive quality management: IATF 16949	This was taken into consideration, but not analysed and implemented in final concept	This is considered an important standard and Microcab should meet this standard
R8.2 The product should follow standard road/travel safety regulations, starting with the UK	The final concept is based on existing parts, therefore should follow standards regarding safety	Determine safety regulations, implement elements, that they follow these standards
R8.3 The product should follow the Directive 2000/53/EC	The new body panels should provide improved dismantling at end-of-life, helping to shift towards this directive	Meet standards regarding funding and perception: these can positively influence brand image
R8.4 The product should follow the Directive 2005/64/EC	Circularity has been an important factor during the project and should help shift towards this directive	Meet standards regarding funding and perception: these can positively influence brand image

W8.1 (recommendation) achieve the following: ISO 9001, ISO 14001, ISO 45001.	This had not been further incorporated in the project, but standards can typically help a company's market position	Determine if these are relevant for the market position of Microcab
R9.1 Body panels should be easily removable during service and maintenance	Creating four separate body panels instead of one front clip accessibility for ease of maintenance/service	Share insights and test with maintenance department
R9.2 Internal components in the front section should be easily accessible	The increased size of the bonnet with incorporated headlights increases the accessibility of the internal components	Determine what is most comfortable for maintenance and service
R9.3 Fasteners should be easily accessible.	Although insights have been provided on types of fasteners, no clear locations have been defined	Determine location of fasteners
R10.1 The solution should remain intact to driving speeds up to 100 km/h	This was not able to be tested considering it is still in a conceptual phase	After implementing, physically test how the structure reacts to high driving speeds
R10.2 The product should be durable enough to allow for annual dis- and reassembly	Plastic fasteners are likely to break during dis- and reassembly, the rest of the elements should however easily withstand regular dis- and reassembly	Test the strength of the fasteners and determine where they should be located
W10.1 In case of product failure, the product must not create a more dangerous situation than the current one	This could not be verified, but due to the added support and fastening, the rest of the elements should remain in position	Physical crash tests are required to determine this
R11.1 At speeds from 0 to 20 km/h the product should lower the risk of injury on pedestrians	The final concept improves energy absorption, in result lowering the risk of injury	Further details are required how an impact influences pedestrian safety
R11.2 At speeds above 40 km/h, the product should guarantee occupant protection	The current VIANOVA already has been tested and meets these requirements	New tests will be necessary to determine how to force is absorbed with the added elements
R11.3 The product should protect important components at all speeds	The added support elements and energy absorption increase protection of the internal components	Further analyse how they protect and determine ideal configuration
R11.4 The product should not contain sharp corners or edges to guarantee maintenance and pedestrian safety	The body panels have been designed that they do not have sharp corners	N.A.
W11.1 The product should not interfere with existing safety measures	N.A.	N.A.
R12.1 The product must treat servicer and maintenance accordingly to company guidelines	N.A.	N.A.
W13.1 The product should have a positive influence on the general public	N.A.	N.A.
R14.1 The product should be applicable on all future vehicles of Microcab	Considering the modular design of the VIANOVA, the final concept should be applicable to other vehicles in the future	Determine if same dimensions can be implemented in other vehicles
R15.1 The product should fit the brand image	N.A.	N.A.
R15.2 The product should remain appealing	N.A.	N.A.
R15.5 The finish of the product should remain in good condition for 3.5 years	The specifications of the wrap material state it lasts for 11 years	Field test the material and determine it fits company guidelines
W15.1 The product should visualise 'Econess' in the design	N.A.	N.A.
W15.2 The product should fit within the future of hydrogen mobility	N.A.	N.A.

Table 11: Conclusion final concept

The table illustrates a clear evaluation of the final concept based on the list of requirements. Follow-up research is required, but the concept provides a substantial positive influence on the requirements and the goal.

7 CONCLUSION

The current VIANOVA has several limitations regarding repairability, safety, and shifting towards a circular economy. The goal of this research was to improve these limitations by creating a solution that can be implemented in the VIANOVA. This was realised by answering the main research question '**How can Microcab design the front section of the VIANOVA to increase the repairability and solve the safety issues?**', and the derived sub questions listed in chapter 2.2. This report determined the elements that are required to achieve the goal and provide a concept that illustrates these elements. From the start, one of the concept ideas was to split the body panels into multiple segments. The default assumption was that this should significantly improve the repairability. Based on literature review and qualitative research, this was later substantiated. Splitting the front clip, would not have been a desirable solution as a stand-alone concept, due to the safety issues and required constructive support. Therefore, the final concept consisted of multiple elements to provide a substantial increase in repairability and safety. In order to increase the circular capabilities, it was found and proven by literature and qualitative data that the most suitable material is thermoplastic olefin (TPO), combined with a revised surface finish that does not contain volatile organic compounds (VOCs).

The combination of elements provides a contribution to make the final concept desirable and justify the increase in costs (£745 vs £630, per unit). Although still conceptual, the final concept provides a clear direction and serves as a starting point for further development and implementation.

8 RECOMMENDATIONS

In order to create a successful product, it is recommended to implement the elements in a specific order.

Through the medium of the three lenses of IDEO; desirability, feasibility, and viability (Fenn, 2017), this order of implementation is reviewed in table 12. All elements have a high desirability, by the order of implementation the feasibility and viability are increased, since the elements require further research, and the likely requirement of funding. The table provides a path that ensures this, creating a solution that assures a successful business.

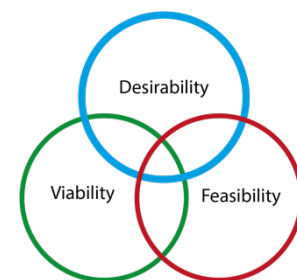


Figure 47: Three lenses of IDEO

Order of implementation	Element	How	Why
1.	Energy absorber	By implementing standard foam material (PE) sourced locally and cut into shape to create an energy absorber that fits in the available space. This helps create stability behind the bumper and absorb energy.	This is a simple way to determine how it influences the impact performance, highly desirable due to the added safety and repairability and Highly feasible due to the simplicity. Can eventually become a viable solution when is correctly implemented
2.	Support structure <ul style="list-style-type: none"> - Upper load beam - Cross-member 	Design and build the structure that supports the front clip at the areas where the body will be eventually split. Use mechanical fastening on the chassis so the VIANOVA would only need a new front section instead totalling the chassis during a high-speed impact. Start with simple structural components. Finalise design with rest of the elements.	required for separated body panels, desirable due to added & repairability, feasible due to available knowledge at Microcab.



3.	Segmentation of front clip and shift towards TPO and plastic fasteners	These elements can be incorporated at one point in time: after overall measurement are determined, it is easier to determine, for instance, where the fasteners should be located (regarding the mould). Furthermore, determine if push rivets are sufficient, or additional snap lock brackets are required.	High desirability and feasibility. will require funding to increase viability.
4.	Extend bumper beam	It is recommended to Simplify the design of the front bumper; this lowers the costs of the mould, as well as the bumper beam. The current final concept involves an intricately shaped bumper beam. Start with implementing parts that can be bolted on the bumper beam. redesign the fog light clusters, then determine available space and redesign energy absorber and bumper beam.	Highly desirable considering the added safety and repair benefits, but will require additional R&D, making it slightly less feasible and viable at the start.
5.	Wrapping surface finish	Start testing with the 3M PVC-free material, Test suitability and look at doing this process in-house.	Significantly improves circular capabilities → desirable, but will require staff training to become feasible and viable
6.	Noise dampening	The noise reductive plates limit available constructive space. re-evaluate and determine a better solution for this issue. The new front section creates opportunities, considering there is more support to create or fixate noise reduction → Traditional plastic wheel arch covers	A desirable solution improving noise dampening and potentially compensating the added weight of the final concept elements.
7.	remove mechanical hinges  (Renault)	Create a mechanism that locks the bonnet in place and is fixated to the chassis with a secured line.	Decreases weight, slightly compensating the added weight of the added elements. Internal components only require access during service and maintenance. Lowers costs. A solution that follows all three lenses of IDEO.
8.	Follow industry standards in the list of requirements	Obtain relevant certifications. Create a roadmap that can help communicate the priorities from the conclusion to relevant stakeholders.	Improves market position. Standards tests the value of long-term sustainability, generates funding, increasing viability of the company.
Additional step	Implementing mould in repair process 	Use mould as repair process. Creating a hardwood mould and a heating element in the workshop. This application is theoretical but could be a desirable solution for the service works, lowering difficulties during repair.	Adding a repair possibility, applicable during the redesign stage increasing circularity by reusing existing bumper in redesign. Futureproofing the design capabilities. Potentially facilitates all three lenses of IDEO.

Table 12: order of recommendation

The final concept provides several benefits regarding reparability and safety in a circular economy. The combinations of the elements will provide a road-safe VIANOVA in urban situations. In order to achieve this, it is recommended to follow the steps steadily. The final concept involves a significant change to the front section of the VIANOVA, making it not directly viable or feasible, but implementing the final concept over a time period could increase the feasibility and will create a viable product in the future. Therefore, it might be useful to implement the insights of this project in a road map to clarify the communication to relevant stakeholders.

9 REFERENCES

- 3M. (n.d.). *LX/SV480mC: 3M™ Envision™ Print Wrap Film LX & SV 480mC*. 3M Science.
https://www.3m.com/3m/en_us/company-us/all-3m-products/%7E/lx-sv480mc-3m-envision-print-wrap-film-lx-sv-480mc/?n=5002385+3291516961&rt=rud
- ABS schadeherstel. (2017, December 22). *Top 5 meest voorkomende autoschade | ABS De Autoherstellers*. ABS.
<https://www.deautoschadeherstellers.nl/top-5-meest-voorkomende-autoschade/>
- AC plastics Inc. (n.d.). *4 Varieties Used in The Automotive Industry*. Acplasticsinc.
<https://www.acplasticsinc.com/informationcenter/r/plastic-used-in-cars#:~:text=Polycarbonate,snow%20to%20heat%20and%20cold.>
- Advanced Plastiform. (2019, May 30). *Thermoplastic Olefin Thermoforming and Injection Molding - API*. Advanced Plastiform, Inc. <https://advancedplastiform.com/materials/tpo/>
- Advanced Plastiform. (2019b, December 12). *Polypropylene Thermoforming and Injection Molding - API*. Advanced Plastiform, Inc. <https://advancedplastiform.com/materials/polypropylene/>
- Aquin, P. (2016, June 2). *7 frequently asked questions about vehicle wraps*. 3M Science.
<https://sciencecentre.3mcanada.ca/articles/7-frequently-asked-questions-about-vehicle-wraps>
- Arkema. (n.d.). *Thermoplastic composites and advanced composites with outstanding properties – Arkema.com*. <https://www.arkema.com/global/en/arkema-group/innovation/lightweight-materials-and-design/thermoplastic-composites/>
- ARN. (2020, March 11). *Autorecyclinketen*. <https://arn.nl/autorecyclinketen/>
- Ashby, M., Shercliff, H., & Cebon, D. (2010). *Materials: Engineering, Science, Processing and Design* (2nd edition). Elsevier.
- AZoM. (2020, October 19). *Thermoplastic Composites - An Introduction*. AZoM.Com.
<https://www.azom.com/article.aspx?ArticleID=85>
- Badell. (2018, March 28). *The Evolution of Bumpers | Badell's Collision*. Badell's Collision.
<https://www.badellscollision.com/blog/evolution-of-bumpers/#:~:text=Bumpers%20in%20the%20Beginning&text=Automobiles%20emerged%20on%20the%20scene,on%20them%20until%20around%201915.&text=The%20earliest%20bumpers%20were%20extremely,but%20not%20in%20the%20back.>
- Badell. (2019, June 5). *How Badell's Collision Repairs Bumpers Quickly | Plastic Bumper Repair*. Badell's Collision. <https://www.badellscollision.com/blog/quick-repair-plastic-bumper/#:~:text=Car%20manufacturers%20use%20a%20variety,combination%20of%20these%20differen%20materials>
- Bakker, C., Den Hollander, M., van Hinte, E., & Zijlstra, Y. (2014). *Products That Last - product design for circular business models*. TU Delft Library.
- Barrett, A. (2020, July 24). *History of Bioplastics in the Automotive Industry*. Bioplastics News.
<https://bioplasticsnews.com/2019/11/26/history-bioplastics-automotive-car-industry/>
- BASF. (2014, April 19). *How Airbumps Protect the Citroen C4 Cactus*. BASF Automotive Solutions.
<https://automotive.basf.com/news/read/how-airbumps-protect-the-citroen-c4-cactus>

- Bcomp. (n.d.). *Motorsports & bodywork*. <https://www.bcomp.ch/solutions/motorsports-bodywork/>
- Berhanu-MacDonald, K. (2020). *Sustainability in The Automotive Coating Industry*. Era Environmental. <https://www.era-environmental.com/blog/sustainability-in-the-automotive-coating-industry>
- Beyene, A. T., Koricho, E. G., Belingardi, G., & Martorana, B. (2014). Design and Manufacturing Issues in the Development of Lightweight Solution for a Vehicle frontal Bumper. *Procedia Engineering*, 88, 77–84. <https://doi.org/10.1016/j.proeng.2014.11.129>
- Blueplanetrecycling. (2020, September 1). *Plastic Recycling Services: Car Bumpers Made From TPO*. <https://blueplanetrecycling.ca/materials-we-recycle/plastic-recycling/car-bumpers-made-from-tpo/>
- BMW group. (2020, March 30). *The powertrain for the BMW i Hydrogen NEXT: BMW Group reaffirms its ongoing commitment to hydrogen fuel cell technology*. [Press release]. <https://www.press.bmwgroup.com/global/article/detail/T0306930EN/the-powertrain-for-the-bmw-i-hydrogen-next:-bmw-group-reaffirms-its-ongoing-commitment-to-hydrogen-fuel-cell-technology>
- Böllhoff. (n.d.). *Quick-release fasteners QUICKLOC® | Böllhoff*. Böllhoff. <https://www.boellhoff.com/de-en/products-and-services/special-fasteners/quick-release-system-quickloc.php>
- BPG. (2018, May 8). *THE 5 MOST COMMON TYPES OF CAR BUMPER DAMAGE*. [Http://Www.Bestpricegarage.Co.Uk/Blog-Entry-the-5-Most-Common-Types-of-Car-Bumper-Damage.Html](http://www.bestpricegarage.co.uk/Blog-Entry-the-5-Most-Common-Types-of-Car-Bumper-Damage.Html). <http://www.bestpricegarage.co.uk/blog-entry-the-5-most-common-types-of-car-bumper-damage.html>
- Brentwood Industries. (2020, January 4). *Top 5 Advantages of Pressure Thermoforming | Brentwood*. <https://www.brentwoodindustries.com/resources/learning-center/transportation/6711/>
- Brighton panel works. (2019, June 24). *5 Most Common Car Parts that Damage in Accidents*. <https://brightonpanelworks.com.au/news/5-most-common-car-parts-that-damage-in-accidents/>
- BSI. (n.d.). *ISO/TS 16949 Automotive Quality Management*. <https://www.bsigroup.com/en-IL/Automotive-Quality-ISOTS-16949/>
- Carpro. (2020, March 3). *4 Most Common Car Accident Damages*. CARRO Blog. <https://carro.sg/blog/common-car-accident-damages/>
- CES EduPack software, Granta Design Limited, Cambridge, UK, 2009.
- Constant Fibreglass Ltd. (2015). *Vehicle Fibreglass Bodywork & Panels*. <http://www.constantfibreglass.co.uk/vehicle-bodywork.php>
- Creative Solutions Direct. (n.d.). *Eco Friendly Wraps | Vehicle Graphics*. <https://www.creative-solutions-direct.co.uk/eco-friendly-vehicle-graphics>
- Dorst, K. (2006). *Understanding Design*. BIS Publishers.
- Davoodi, M. M., Sapuan, S. M., Aidy, A., Abu Osman, N. A., Oshkour, A. A., & Wan Abas, W. A. B. (2012). Development process of new bumper beam for passenger car: A review. *Materials & Design*, 40, 304–313. <https://doi.org/10.1016/j.matdes.2012.03.060>
- Danner, M., & Anselm, D. (1978). Do energy absorber bumpers result in cost savings? *ATZ*, 80(3), 123–126. <https://trid.trb.org/view/145543>

- EESC (2016) *EESC study on planned obsolescence* retrieved from:
<https://www.eesc.europa.eu/resources/docs/factsheet-en.pdf>
- Ellen Macarthur foundation (N.b.) *Circular economy*. Retrieved from:
<https://www.ellenmacarthurfoundation.org/circular-economy/concept>
- EuRIC (2020) *call for recycling plastic in cars*, Retrieved from: <https://www.euric-aisbl.eu/position-papers/item/351-euric-call-for-recycled-plastic-content-in-cars>
- European Aluminium Association. (2013). *Applications – Car body – Crash Management Systems*.
https://www.european-aluminium.eu/media/1548/4_aam_crash-management-systems1.pdf
- European Commission. (2020). *End of life vehicles - Waste - Environment - European Commission*. European Commission - Environment. <https://ec.europa.eu/environment/waste/elv/>
- Fenn, T., & Hobbs, J. (2017). Conceiving and Applying Relationship Models for Design Strategy. *Research into Design for Communities, Volume 2*, 517–528. https://doi.org/10.1007/978-981-10-3521-0_45
- Fentahun, M. A., & Savas, M. A. (2018). Materials Used in Automotive Manufacture and Material Selection Using Ashby Charts. *International Journal of Materials Engineering*, 8(3), 40–54.
<https://doi.org/10.5923/j.ijme.20180803.02>
- Formlabs. (n.d.). *Guide to Manufacturing Processes for Plastics*. <https://formlabs.com/eu/blog/guide-to-manufacturing-processes-for-plastics/#Thermoplastics>
- G-force signs (2020) *3M Envision wraps are environmentally friendly!* Retrieved from:
<https://gforcesigns.com/3m-envision-wraps-are-environmentally-friendly/>
- Grauss, N. BMW Breman Schade (personal communication)
- Grimes, O., Bastien, C., Christensen, J., Rawlins, N., Hammond, W., Bell, P., Brown, B., & Beal, J. (2013). Lightweighting of a Hydrogen Fuel Cell Vehicle Whilst Meeting Urban Accident Criteria. *World Electric Vehicle Journal*, 6(2), 464–475. <https://doi.org/10.3390/wevj6020464>
- Grigore, M. ă. ă. (2017). Methods of Recycling, Properties and Applications of Recycled Thermoplastic Polymers. *Recycling*, 2(4), 24. <https://doi.org/10.3390/recycling2040024>
- Harbid, T. (2019, September 1). *Are Plastic Used Car Bumpers Recyclable?* Cash Cars Buyer.
<https://www.cashcarsbuyer.com/are-plastic-used-car-bumpers-recyclable/>
- Harbid, T. (2020, April 4). *Bumper Repair Cost Guide*. Cash Cars Buyer.
<https://www.cashcarsbuyer.com/bumper-repair-cost/>
- I-Car. (2015). *Bumper Energy Absorbers, Crush Boxes, and Bumper Reinforcements*. <https://rts.i-car.com/collision-repair-news/bumper-energy-absorbers-crush-boxes-and-bumper-reinforcements.html>
- Intertek (2021) *Automotive materials weathering testing*. Retrieved from:
<https://www.intertek.com/automotive/weathering-testing/>
- Intertek (2021) *Automotive plastics and polymers physical testing*. Retrieved from:
<https://www.intertek.com/automotive/polymers-and-plastics-testing/physical/>

- Impactplastics. (2017, June 21). *Learn More About Your Plastic Sheet: 7 Facts About TPO Plastic*. <https://blog.impactplastics.co/blog/learn-more-about-your-plastic-sheet-7-facts-about-thermoplastic-olefin-tpo>
- Jeasin. (2017, September 20). *Comparison between ABS and PP - China Top Lockers*. Toplockers. <http://www.toplockers.com/comparison-between-abs-and-pp.html>
- Job, S. (2018, August 1). *Study on Mechanical Properties of Natural - Glass Fibre Reinforced Polymer Hybrid Composites: A Review*. Materials Today. <https://www.materialstoday.com/carbon-fiber/features/recycling-glass-fibre-reinforced-composites/>
- Kingplastic. (2011, August 29). *TIPS FOR WELDING THERMOPLASTICS*. <https://www.kingplastic.com/tips-for-welding-thermoplastics/>
- Kurebwa, J., & Mushiri, T. (2019). A Study of Damage Patterns on Passenger Cars Involved in Road Traffic Accidents. *Journal of Robotics, 2019*, 1–12. <https://doi.org/10.1155/2019/3927935>
- Luda, M. P., Brunella, V., & Guaratto, D. (2013). Characterisation of Used PP-Based Car Bumpers and Their Recycling Properties. *ISRN Materials Science, 2013*, 1–12. <https://doi.org/10.1155/2013/531093>
- Macey, S., & Wardle, G. (2014). *H-Point 2nd Edition: The Fundamentals of Car Design & Packaging* (2nd ed.). Design Studio Press.
- Makuta, M., Moriguchi, Y., Yasuda, Y., & Sueno, S. (2000). Evaluation of the effect of automotive bumper recycling by life-cycle inventory analysis. *Journal of Material Cycles and Waste Management, 2*, 125–137. <https://doi.org/10.1007/s10163-000-0028-5>
- Marzbanrad, J., Alijanpour, M., & Kiasat, M. S. (2009). Design and analysis of an automotive bumper beam in low-speed frontal crashes. *Thin-Walled Structures, 47*(8–9), 902–911. <https://doi.org/10.1016/j.tws.2009.02.007>
- Mayers, H. (2018, May 23). *GRP Lamination Process - Helen Mayers*. Medium.Com. <https://medium.com/@helenmayers267/grp-lamination-process-a3958f309f34>
- Miller, R. (2006, February 27). *Pedestrian rules put more plastic in autos*. Automotive News. <https://www.autonews.com/article/20060227/SUB/60223083/pedestrian-rules-put-more-plastic-in-autos>
- Mobility Insider. (2020). *What Is Active Safety?* Aptiv. <https://www.aptiv.com/insights/article/what-is-active-safety>
- Mo, F., Zhao, S., Yu, C., Xiao, Z., & Duan, S. (2018). Design of a Conceptual Bumper Energy Absorber Coupling Pedestrian Safety and Low-Speed Impact Requirements. *Applied Bionics and Biomechanics, 2018*, 1–8. <https://doi.org/10.1155/2018/9293454>
- Moore, S. (2018, July 19). *World's first bio-based, circular car created from PLA*. Plasticstoday.Com. <https://www.plasticstoday.com/automotive-and-mobility/worlds-first-bio-based-circular-car-created-pla>
- Nasiruddin, S. M., Hambali, A., Rosidah, J., Widodo, W. S., & Ahmad, M. N. (2017). A Review of Energy Absorption of Automotive Bumper Beam. *International Journal of Applied Engineering Research, 12*(2), 238–245. https://www.researchgate.net/publication/315099439_A_Review_of_Energy_Absorption_of_Automotive_Bumper_Beam

- Nitrogen Welding Information*. (n.d.). Polyvance.Com. <https://www.polyvance.com/Nitrogen-Welding-Information/>
- NQA Global Certification Body. (n.d.). *What Standards Apply to the Automotive Industry? | NQA*. <https://www.nqa.com/en-gb/certification/sectors/automotive>
- Onyeachonam, J. (n.d.). *The evolution of car bumpers over the years*. Naijauto.Com. <https://naijauto.com/market-news/car-bumpers-4066>
- Parker. (n.d.). *What's the difference between EPR and EPDM?* Parker.Com. <https://www.parker.com/literature/O-Ring%20Division%20Literature/Static%20Files/EPRvsEPDM.pdf>
- Pilipović, A., Ilinčić, P., Petruša, J., & Domitran, Z. (2020). Influence of Polymer Composites and Memory Foam on Energy Absorption in Vehicle Application. *Polymers*, *12*(6), 1222. <https://doi.org/10.3390/polym12061222>
- Plastics used in automobiles and its advantages*. (2018, June 1). Modern Plastics Global. <https://www.modernplasticsglobal.com/2018/04/27/plastics-used-in-automobiles-and-its-advantages/>
- Post, W., Susa, A., Blaauw, R., Molenveld, K., & Knoop, R. J. I. (2019). A Review on the Potential and Limitations of Recyclable Thermosets for Structural Applications. *Polymer Reviews*, *60*(2), 359–388. <https://doi.org/10.1080/15583724.2019.1673406>
- PWC. (2019). *Five trends transforming the automotive industry*. <https://www.pwc.nl/en/publicaties/five-trends-transforming-the-automotive-industry.html>
- PWC Global. (2019). *Automotive trends 2019: The auto industry must find a way to balance accelerating innovation and financial survival*. PWC. <https://www.pwc.nl/nl/actueel-publicaties/assets/pdfs/pwc-2019-automotive-trends-report.pdf>
- De Ruiters, B. BMW product trainer, (personal communications)
- Sanchez, E. M. S. (2007). Ageing of PC/PBT blend: Mechanical properties and recycling possibility. *Polymer Testing*, *26*(3), 378–387. <https://doi.org/10.1016/j.polymertesting.2006.12.007>
- Shahan, Z. (2021, February 8). *Global Plugin Vehicle Sales Up 43% In 2020, European Sales Up 137%*. CleanTechnica. <https://cleantechnica.com/2021/02/08/global-plugin-vehicle-sales-up-43-in-2020-european-sales-up-137/>
- Sohn, C. H., Kim, O., Chun, Y., & Lee, J. W. (2013). Development of TPO Based Rear Bumper Back Beam. *SAE Technical Paper 2013-01-1396*, <https://doi.org/10.4271/2013-01-1396>
- Sonawane, C. R., & Shelar, A. L. (2017). Strength Enhancement of Car front Bumper for Slow Speed Impact by FEA Method as per IIHS Regulation. *Journal of The Institution of Engineers (India): Series C*, *99*(5), 599–606. <https://doi.org/10.1007/s40032-017-0365-y>
- Subramanian V., Varade D. (2017) *Self-healed Materials from Thermoplastic Polymer Composites*. In: Ponnammma D., Sadasivuni K., Cabibihan JJ., Al-Maadeed MA. (eds) *Smart Polymer Nanocomposites*. Springer Series on Polymer and Composite Materials. Springer, Cham. https://doi.org/10.1007/978-3-319-50424-7_6
- The Difference Between Active and Passive Safety | Uncategorized*. (2018, January 3). Breakawayhonda. <https://www.breakawayhonda.com/blogs/35/uncategorized/the-difference-between-active-and-passive-safety/>

- Van Turnhout, K., Jeurens, J., Hoppenbrouwers, S., Smeenk, W., Jacobs, P., & Bakker, R. R. (2013, April). *Requirements from the Void: Experiences with 1:10:100*. International Working Conference on Requirements Engineering, Essen. https://www.researchgate.net/publication/263807351_Requirements_from_the_Void_Experiences_with_110100
- Tress, B. (2020, August 10). *Is Water Based Paint as good as Solvent Based Paint?* Collision Pros. <https://collisionprosinc.com/is-water-based-paint-as-good-as-solvent-based-paint/>
- V.C.G. Author (2018, December 7). *Marketing Tips for Companies Becoming Environmentally friendly*. The Visual Communication Guy. <https://thevisualcommunicationguy.com/2018/12/07/marketing-tips-for-companies-becoming-environmentally-friendly/>
- Weijer, B. (2020, October 8). *De 'afvalbak', een nieuwe duurzame auto die is gemaakt van gerecyclede materialen, inclusief huisvuil*. De Volkskrant. <https://www.volkskrant.nl/nieuws-achtergrond/de-afvalbak-een-nieuwe-duurzame-auto-die-is-gemaakt-van-gerecyclede-materialen-inclusief-huisvuil~bf35aea4/?referrer=https%3A%2F%2Fwww.google.com%2F>
- recyclingwasteworld. (2016, May 27). *Refuse truck gets environmental graphics wrap*. Recyclingwasteworld.Co.Uk. <https://www.recyclingwasteworld.co.uk/products/refuse-truck-gets-environmental-graphics-wrap/141486/>
- Rezwow, K. (2020, April 5). *From metal to plastic bumpers: in search of the balance between aesthetics and safety*. Knauf Industries Automotive. <https://knaufautomotive.com/the-history-of-bumpers/#:%7E:text=The%20first%20plastic%20bumpers%20were,low%20speeds%20without%20permanent%20deformation.>
- Witik, R. A., Payet, J., Michaud, V., Ludwig, C., & Månson, J.-A. E. (2011). Assessing the lifecycle costs and environmental performance of lightweight materials in automobile applications. *Composites Part A: Applied Science and Manufacturing*, 42(11), 1694–1709. <https://doi.org/10.1016/j.compositesa.2011.07.024>
- Wood, J. (2011). *Fibreglass Car Panels | GRP Body Panels & Fibreglass Body Kit*. Grplite. <https://www.grplite.co.uk/racing.php>

10 APPENDICES

A. Manufacturing and cost VIANOVA front clip (provided by Microcab)

The vehicle uses a basic wet hand lay process for the glass reinforced plastic with 3mm of average thickness and an average weight of 450gsm.

breakdown of time & process (1 person - standard):

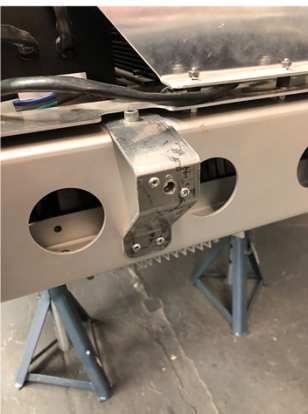
Mould Preparation	: 30mins
Gel Coating	: 30mins
Rest Period (To set Gel Coat	: 2 hours
Lay Up (Application of glass followed by resin, layered)	: 4 hours
Harden	: 8 hours / overnight
Removal from Mould	: 30 mins
Trim Edges	: 1 hour
Total	: 16.5 hours

cost breakdown:

Tooling creation / Mould making: £8500 (Tool will make 100 - 500 parts) average: 300	
Therefore, tool cost per part, estimated to be	~£30 per front clip.
Hand layered GRP to mould, costs	: £350 per part
Finalisation and painting	: £250
Total	£630

All costs are estimates.

B. Photographs dismantled VIANOVA
Provided by Microcab



C. GRP repair process (Boone, 2011)

In order to repair GRP bumpers, three critical components are needed:

1. fibreglass resin
2. fibreglass matting strips
3. liquid hardening agent.

Furthermore, a plastic or wooden stick to help mix the resin and an applicator is needed to put it on the bumper.

The process is not difficult, but the components are chemicals that require care and are not good for the environment. Furthermore, it is a tedious process that involves several hours of manual labour.

1. The body panels need to be removed in order to access both sides.
2. It needs to be sanded down to the bare material
3. New sheet needs to be cut in the correct size and placed on the damage
4. A chemical type of resin is painted over the sheets to bond it and harden it (Image right). It also requires a few hours to harden
5. Bondo is applied to fill in any imperfections
6. This need sanding to smoothen the surface before painting
7. Paint primer coat
8. Colour coat
9. Clear coat
10. It is important to fade the paint into the existing paint, so no lines are visible
11. Finally, it needs a sanding/polishing treatment to smoothen it out towards the rest of the body panel.



The front clip of the VIANOVA also has a gelcoat, this also require special steps to repair it.

Depended on the size of difficulties of the damage, prices vary, according to sources multiple sources on the internet prices of repair fibreglass and the gelcoat vary from 55 to 80 pounds per hour (constantfibreglass.co.uk). This includes the material and labour.

D. BMW Damage expert insights (provided by BMW Breeman)

Results from interview with BMW damage expert, qualitative conversation of +- 2 hours.

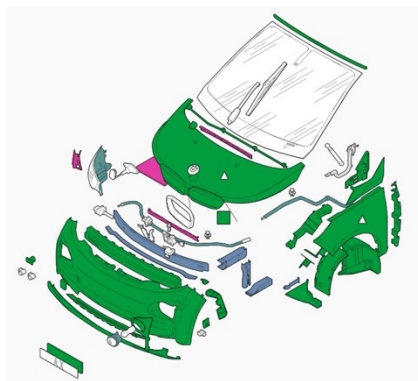
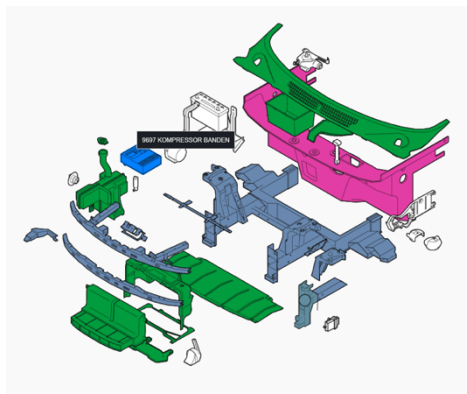
- **Important Insights:**
- **Bracket system should carry front section body panels.**
- **Energy absorber helps maintain shape of bumper and absorbs energy**
- **TPO is preferred material**

he also mentioned that French car manufacturers use a weird composition of plastics, where plastic welding is not possible, often difficult to repair, apparently, they mix a lot of different plastics.

He also filled in a questionnaire I made, review next page for questions (in Dutch)

Answers questions:

- | | |
|---|---|
| 1. Zou ik niet doen, lichtbundels zijn duur, hebben vast punt nodig, zo blijven. Bij schade blijven die buiten deze zone. | - B |
| 2. Zie mail overzicht I3 | - D |
| 3. Zie tekening/ lassen is mogelijk bij PP | - E |
| 4. C (push rivets) gaan los bij aanrijding en roesten niet, licht materiaal | - F (als iets vast moet blijven is dit prima) |
| 5. Lijst | - A |
| - C | - H |
| | - G |
| | 6. Popnagels en lijmtechniek |
| | 7. Zie foto's in de mail |



Questionnaire Repairability

Mijn naam is Rutger Mak van Waay en momenteel ben ik aan het afstuderen aan de Technische universiteit Delft.

In verband met mijn onderzoek heb ik een vragenlijst opgesteld om meer te weten te komen over de reparatiemogelijkheden van de voorbumper van een specifiek voertuig.

Het is een case study over een compacte Deelauto waarvan de huidige configuratie het repareren lastig maakt.

In de foto hiernaast kunt zien dat het vrij minimalistisch is vergeleken met een normale consumenten auto.

Momenteel is de hele voorkant 1 groot onderdeel gemaakt van glasvezel-versterkt plastic, die wordt bevestigd op 6 punten, 4 onder de ruit, 1 aan elke zijkant, (hiervoor moet de deur gedemonteerd zijn) en 2 op de voorste bumperbalk.

Om de reparatiebaarheid te verhogen, zal PP als vervangend materiaal gebruikt worden en zal het paneel opgesplitst worden in meerdere delen.

Nu moet er ook onderzoek gedaan worden naar de mogelijkheden in het bevestigen van deze panelen. Daar heb ik uw hulp voor nodig.

Dit formulier bevat een aantal vragen met betrekking tot het bevestigen van de panelen.

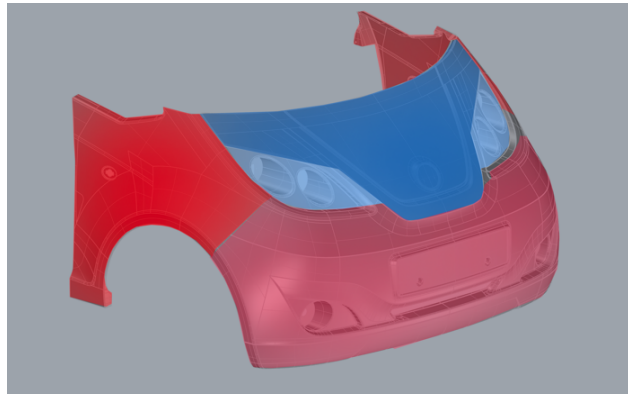
Gezien dit nog een lopend onderzoek is, vraagt de universiteit zijn studenten om de informatie die verstrekt wordt in dit onderzoek niet zomaar te delen met derde, daarom vraag ik u vriendelijk om dit ook te ondertekenen, dat u de informatie niet met anderen zult delen.



Handtekening

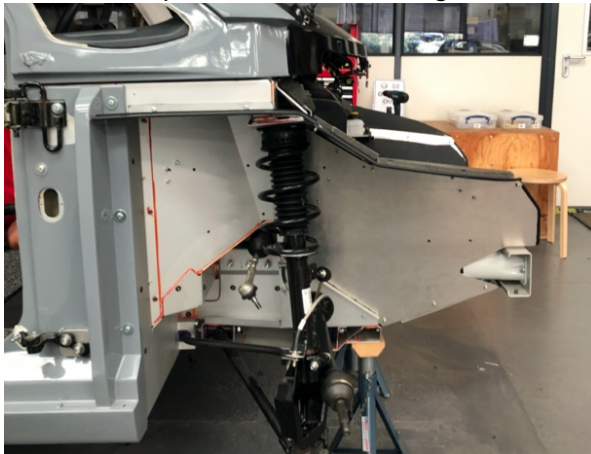
Datum

De afbeelding hiernaast is een snelle schets van hoe de nieuwe panelen eruit zouden kunnen zien op het huidige paneel. De koplampen zullen geïntegreerd worden in de motorkap omdat de panelen boven de wielen niet bedoeld zijn om iets op te bevestigen.





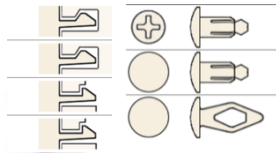





Vragenlijst.

1. Bent u het eens om de koplampen te integreren in de motorkap? Licht toe.
2. Wat zijn logische punten voor het bevestigen van de panelen in deze situatie? Licht toe met behulp van deze afbeeldingen.



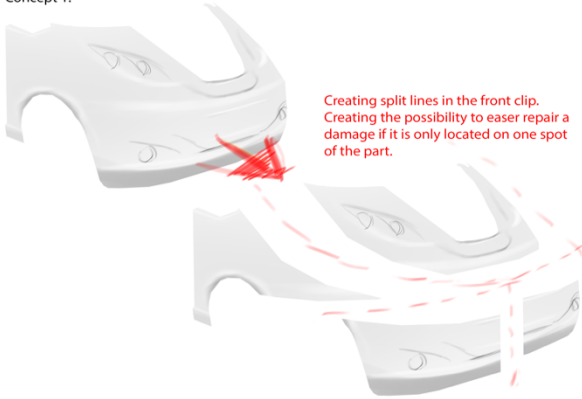
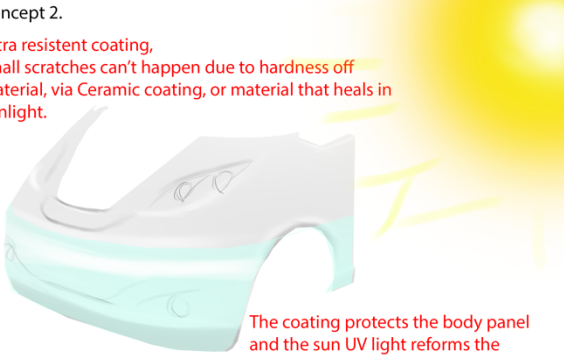
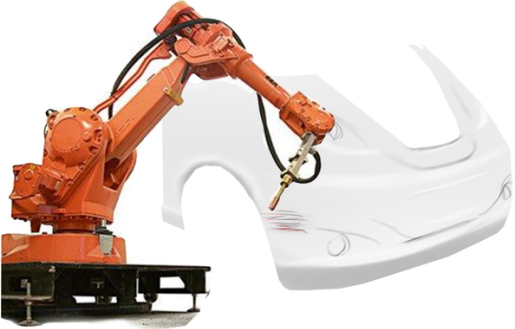

3. Zijn er voor u bekende manieren om de reparerbaarheid van bumpers te verbeteren? Licht toe.
4. Wat is Ergonomisch het meest fijne om mee te werken? (zie volgende blz)
5. Op de **volgende bladzijde** staan enkele manieren voor het bevestigen van panelen. Zou u de letter van elke methode op volgorde kunnen plaatsen met 1 de 'beste'.
6. Zijn er andere methode die hier niet tussen staan en wellicht beter zijn in deze situatie? Zo ja, Licht toe.
7. Verdere informatie of feedback wordt gewaardeerd.

Fastening System	Description	Image
<p>a. Traditional bumper screw system</p>	<p>Small metal screw and metal fastener, the fastener is often fixated on the bumper, bracket points on chassis allow for tightening with screw.</p>	
<p>b. Quickloc</p>	<p>For easy removal of panels, requires some extra space for wing handle. Does not require extra tooling.</p>	
<p>c. Dart clip & push rivets</p>	<p>Specially designed for body and trim panels of vehicles.</p>	
<p>d. Quick release</p>	<p>Used in drift scene, very easy to disassemble, very visible.</p>	
<p>e. Snaplocks & clips</p>	<p>Common fastening method for plastic panels. Some require tooling. Often used in interior trim panels.</p>	
<p>f. Clickbonds</p>	<p>Works with traditional screws, often requires an adhesive to be mounted on bumper.</p>	
<p>g. Fidlocks</p>	<p>A magnetic fidlock could help in keeping the bumper in place during assembly. Would require additional fastening.</p>	
<p>h. Slide Mechanism</p>	<p>Could improve assembly, additionally improves crash resistance with low speeds, focusing impact on front bumper</p>	

E. Cycle 1: Pressure cook analysis

The first cycle was in the span of one day. This cycle is the basis for the final report.

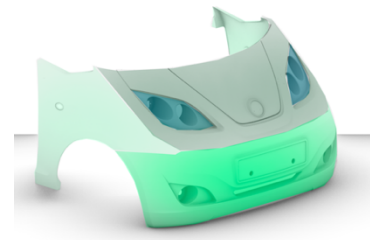
At the end of the first cycle, four concepts were generated based on the scope and research which are visible in the table. For further insights to the first cycle, refer to appendix D.

<p>Concept 1.</p>  <p>Creating split lines in the front clip. Creating the possibility to easier repair a damage if it is only located on one spot of the part.</p> <p><i>Figure 12: Concept 1: Split & divide.</i></p>	<p>Concept 2.</p> <p>Ultra resistant coating, small scratches can't happen due to hardness off material, via Ceramic coating, or material that heals in sunlight.</p>  <p>The coating protects the body panel and the sun UV light reforms the structure of the molecules, removing the scratches.</p> <p><i>Figure 13: Concept 2: Self-healing material</i></p>
<p>Concept 3.</p> <p>3D printen bumpers. Bumpers are printed with large 3D print robots, when damaged, the bumper is not in need of dismantling, the robot can add recycled plastic to the bumper, regaining its properties and easthetics. Visualising the recyclebility</p>  <p>When no extra material is needed, the robot heats the body panel, melting the material and reshape the body</p> <p><i>Figure 14: Concept 3: 3d printing repairs</i></p>	<p>Concept 4.</p> <p>Modularity and symmetry, by lowering the aesthetics and combining concept 1. generate the body panels that are symmetric on both side, meaning you would online need one panel for both sides, lowering costs and increase repairability and efficiency.</p>  <p>Still creating a modern easthetic that is pleaing to the eye, however increasing function of body panels, same can be done for rear bumper.</p> <p><i>Figure 15: Concept 4: Modular body panels.</i></p>

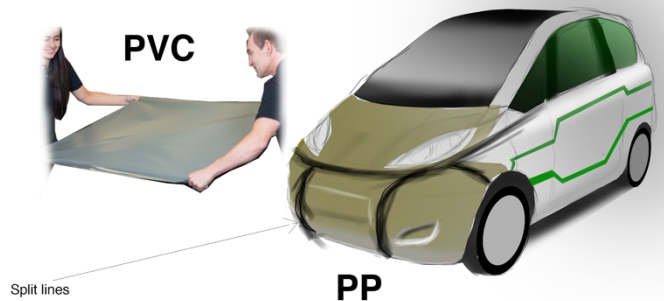
F. Cycle 2 In-depth analysis

Cycle 2 (10 days). The reparability of car body panels for Microcab in a circular economy
Start October 9th

Cycle 2 clearly reflects the difference of what 10 days can achieve compared to just one day. It resulted in finding depth in all relevant subject and allowed for questions to be answered that resulted from the insights of the first cycle. The goal of this cycle was again to complete a full design cycle from start to finish, however with the results from the first cycle as a basis. During this cycle the four concepts did not change, but through knowledge obtained during this cycle helped substitute the findings and build for stronger and more viable concepts. For instance, Concept 2 from the first cycle was merely adapted into the possibility of Wrapping the panels, created the Self-healing with a surface finish instead of the material itself, and within this stage it was decided to keep the aesthetics of the VIANOVA. Resulting in concept four not viable anymore. Concept 3 was eventually not researched any further due to viability. This stage led to the combination of several concept direction incorporated into one direction. Based on the data and knowledge obtained. For instance, the body panel should be split up, by splitting up the front clip, allows for better reparability and lower (repair) costs. Further research into material led to a clear path towards thermoplastics, that are more flexible and can be reshaped with heat. The cycle eventually led to a final concept direction visible in figure 17. At this point, it was clear to split the body panels, change the material and manufacturing process and look at a different surface finish. At this stage it was also found that a foam energy absorber could improve reparability. Solutions were found, but not substantiated. Refer to Appendix E for the whole cycle.



Using conventional car wraps to create the lacquer finish on bare plastic parts. reducing repair processes and at the same time increase recyclability



G. Reflections

Reflection 1st Cycle September 25th (after first cycle)

Although this is nothing like a 'real' report, I thought it worked surprisingly good for my mindset. I got a better picture of the whole project and what is missing for the final concept. I do realize I did not incorporate multiple aspects I found earlier during research, but I really tried to keep everything within this cycle. I also did things I did not do prior to this day but should be done extensively. For instance, the future situation roadmap was helpful, although it literally was quick & dirty. It still made me realize this is an important aspect of the project. I realize in order to come up with viable solutions, this roadmap might be very important for the outcome of the project. On another note, I do find it sometimes difficult to write down facts. As mentioned, my knowledge regarding automotive technology is pretty high, so certain things I just know. Yet according to the 'rules' of a report, facts need to be built on data, but often that data is in my head, from years ago even. Nevertheless, I am very grateful for this project. Graduation in the automotive sector is something I did not expect, but very really glad to be able to do so. And I am already looking forward to the coming weeks, even though I sometimes have a 'writers block'.

Reflection 2nd Wednesday October 14th

For the second cycle I am expanding the first cycle. I had difficulties in how to look at the second cycle, I decided to use the first cycle as a base and elaborate on each subject for the current cycle. After shortly discussing personal doubts with Jelle (my mentor), he quickly reassured me. Look at the project as it being a concept itself, continuously iterating the report. This is what I am currently trying to do. I feel this works best for me. I finally received some more materials from Microcab, and this is already useful to continue my process. From the start I was focusing on the front clip, the email of Microcab confirmed that the main issues are with the front clip. Microcab themselves also want me to focus on the front clip. To be honest I myself believe this is a very big task in itself. The direction is pretty clear now, the next important step is to substantiate my decisions for the direction. Even though they seem very logical. Important for myself is to restructure the report as is, I feel parts are still not really in the right order or information not at the correct section. Nevertheless, I still enjoy the project even though I sometimes feel I am hitting a wall. Looking forward to the development stage.

Reflection 2nd cycle October 22nd

It gives joy to see how the report is taking shape this early in the process. The cycles really helped me in already looking at the report/project as a whole. Usually, I would have all the research in different files and would have started making a report. With this second cycle I already have a good foundation for my midterm and final report. I know where I need to do more work and which the parts are taking good shape. The meetings always help me to restructure and send me off in the right direction. I notice I sometimes need a push in the back in order to ignore my insecurities about my work. Even remarks about elements I did wrong. If I do not take them personal, it helps me even more. I really want to deliver something good at the end. This project is about my biggest passion for cars, and that really helps keep everything interesting, however it sometimes gives me a strange feeling that I am not allowed to do something wrong. Nevertheless, I am surprised of how far I already am and am looking forward to the rest. This whole part is also still not yet finished, but for the second cycle I am pretty pleased.

Reflection midterm October 28th

Feedback throughout the project really helps me. The co-reflecting with each session helps me get a better overall view on where to go. This first part went well if I look back at it. I do feel I miss some 'professionalism' at some parts. At other parts it helped to me create new questions. For instance, realizing the first interview I made was not really relevant, but that I will need to make a new one for body repair shops, focusing on fastening systems and configurations. Big next step for me now is to combine everything and visualise my ideas better. The last two pages can use a significant amount of improvement. The information is there, but it is important to clearly define the concept direction and substantiate why I am going in that direction. Furthermore, even though this is a lot already, I still need to work on some stuff. Deciding what is relevant and what is not. I am looking forward to the next part, especially expanding my own knowledge with CAD design and generating something real. Experimenting and prototyping are also things I am looking forward to. It is however important I do not lose focus at this point.

Reflection November 11th

I noticed myself that the reporting I have done till this point was not really a report yet, so instead of moving forward and start working on prototyping, I did a lot of rewriting and restructuring the report. For my own peace of mind this was very helpful, I feel the report feels a lot more like a 'real' report. It still needs work, but now I can focus on the next step again. Which, I do not know why, makes me nervous. I feel I do not have the know-how to start 3D modelling a front car fascia and I notice now how important it is to have the physical vehicle, that would have been a big help in deciding where bracket points fit. It just helps my mind to look at the actual vehicle. I will have to be creative in evaluating ways to still make this work. Nevertheless, I still enjoy working on the project. The continuous iterating of previous work is probably due to my perfectionism. Nothing is ever really finished.

Reflection November 30th

Last week was difficult, although I am still making progress, I hit the point I really miss to be able to take on the existing vehicle. all my prototyping relies on scale models, with different materials and not in the way I really want it. Last week I started working at TU delft, the guys there are really helpful. But is still is difficult, the person responsible for my models got sick, and nobody else was able to finish them, resulting in waiting three more days. Since today, Don is back, and he is the only one that can further help me. I hope that at the end of today, I can continue my prototype, since I am basically waiting for that at this moment. Although it still helps, I believe my progress and results would be better if I was able to work a few days at Microcab. I also decided to start using Ritalin again, the past weeks I noticed losing focus. In the past I always used Ritalin with exams. Since I really have to push myself now. This should be able to help me, even though it makes me mentally feel a bit down. I also talked to someone at the damage department at BMW. He opened my eyes, that there is a lot more work to do, and that it is not that easy as I thought. The concept direction is now going towards introducing large bumper brackets, traditional to that of consumer cars. This should help structure the body panels, lowering damage.

Reflection December 4th

Lost my perspective a bit this past two weeks. It took a lot of time to finish all the parts, which I could not control. First Don at PMB was not available, then Willem helped me around a bit to get started, Willem later got sick and I had to wait for the parts again. The following week Don was back. Everything started to fall back in place. December second Don left, and Wiebe recommended to wait for Don the next day, Eventually Ronald was available that day. He took charge of everything. He helped me a lot for almost three hours, which resulted in a lot of progress. Continuously asking questions and getting insights also from the experts at PMB really helped me, they confirm my direction and even help in evaluating possible solutions. For next week, two mockups should be finished. Making it possible for me to visualise and test my possible solutions. This is also still a bit scary because of the insights of the interviews, it opened my eyes, that the new configuration comes with a lot more work than expected.

Reflection December 11th

Being able to work steady helps with my state of mind, I am slightly behind schedule due to the periods of waiting for certain people to be available. This led to me falling behind schedule, I think I am behind schedule, 3 to 4 days. Coming Sunday is a day I will need to work to try and get back on schedule again. As for the holidays, I will also need to work some additional days. The mockups are nearing completion. Before the holidays, it is important to have them finished and analysed for the ideal configuration. I am confident I will be able to visualise a solution with the prototypes, however my goal is still to try and find the time and patience to create a 3d CAD file for Microcab. It makes me feel insecure if I will not be able to accomplish that. I am planning to figure that out during the holiday break. Furthermore, in realizing that, often at night I spend time looking at explanatory videos on YouTube about Rhino modelling. I believe it is an important asset for my future professional life. Other than that, further in-depth knowledge gained on the subject resulted in realizing some information in the report will need alterations, since the information is not substantiated. At least I am positive that my final recommendations will be beneficial for Microcab.

Reflection December 30th

A final reflection before the new year's starts. A big issue in the report was the list of requirements. they were all over the place and made the overall report look unstructured. Spending time on this list allowed for better grip on reflecting on certain decisions. When I finished the list in a structured manner, it helped me understand the rest of the report better. With each question or doubt, I could reflect on the list and made sure the

direction was correct. Since the last meeting before the holidays, a lot has changed, also the parts already in it. I made sure information was at the right section and looked at how to create an order in presenting the Data. It is common to show the final concept at the beginning and then show how it was created. During this report that was quite difficult for me. The basis of the report was already there in early stages of the process. Changing this would be very time-consuming. I decided to stick with the structure of the report as it is and follow the steps van start to finish. The final concept therefore is at the end of the report. This is a report that follows the process of defining it. Instead of showing it and defining how I got there. There are a few more days left for the Greenlight meeting, and there a still things to do. It is especially important that I visualise the final concept. The concept is there, but it needs to be defined with help of the prototype.

Reflection January 3rd

The past three days were very effective, I got a clear vision in my head on what I want the report to look like. I feel a sense of accomplishment on how the report changed these past days. It looks and feels like a report even though it still needs some work. My stepdad and uncle helped look at mistakes I overlooked resulting in more professionalism throughout the report. The coming weeks will focus on creating a more visual report, addressing the issues I stated at several places. I have got a clear vision on the prototyping, which I will continue tomorrow, prior to the meeting. This was a moment I realize how much better I work when I am under pressure. I was very focussed and eager to create a pleasant looking report. I accessed some extra spirit to really try and make a worthy graduation thesis and I am looking forward to continuing.

Reflection January 5th

The methodology used for the project, 1;10;100 was very useful to quickly define the scope at the project and allowed for an early basis of the final report. I did miss structure in the '100' cycle. I would have wanted to start the concept design phase earlier to have a better concept vision available at the Greenlight meeting. The meetings helped restructure the '100' cycle, as they were personally interpreted as a deadline that helped me achieve certain goals at that phase. Personal reflection and co-reflection during the meetings helped inspire new directions to analyse. It also helped looking at the future instead of staying in a current phase. One personal goal to increase my digital 3D modelling skills was not achieved during this project. Due to the time constraints, it was not possible to 3D digitalize the physical prototyping. I would have wanted to give Microcab a solution that was ready to be manufactured, in this stage, further R&D and 3D modelling is required to determine the mould design of the panels and create a cost estimate. Even though the combination of elements is not necessarily innovative and futuristic, it does provide a positive solution for Microcab, that can help them get more insights in designing the VIANOVA better, safer and ready for the future.

Reflection January 5th

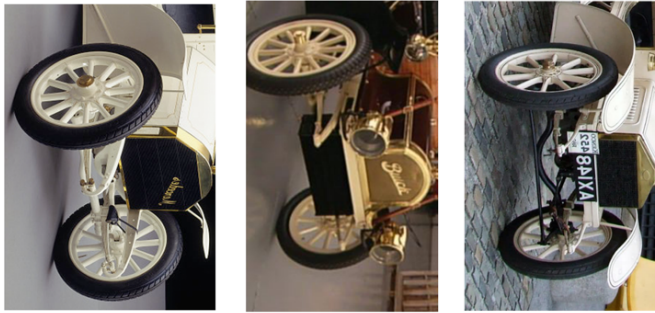
Past 1.5 weeks have been very stressful but also very fulfilling. The feedback in the last meeting was very helpful and it gave me a certain vision on how I want to communicate the information. I also notice that I am never really finished. I continuously iterate sections. Also, the ones I thought were sufficient. Looking back on how the previous version looked, I feel a lot more confident about this one. Although some elements still need additional work and maybe some restructuring, the story is a lot better to follow now. Most important thing now is to figure out how to communicate the prototyping in an efficient and clear matter. That part still needs quite some work what the focus will be the next couple of days. It might also need some iterations regarding how to use to list of requirements as feedback at the end of the report. Still struggling a little bit on that part.

Reflection February 11th

After receiving green light at the greenlight meeting January 19th, the feedback provided gave me the motivation and insight to finish the report. The last month has been a positive experience, and I have managed to incorporate the feedback plus additional elements that provide a report that is clear for an inexperienced reader as well as a clear direction for Microcab. Although i did not manage to incorporate 3D modelling for my personal learning objective, the knowledge I gained during the process is significant. I learned a significant amount of knowledge in Microsoft Word, PowerPoint and increased my digital drawing skills. the process of my graduation has been a big learning experience for me, and I know myself better because of it. I have a clear path for my future and what I find interesting. I realise that my interest lies in the conceptual phase, which is directly reflected in this report. I am looking forward to what the future holds for me outside of TU Delft.

H. Historical analysis of front car bumper.

Onyachonam, J. (2019) & others



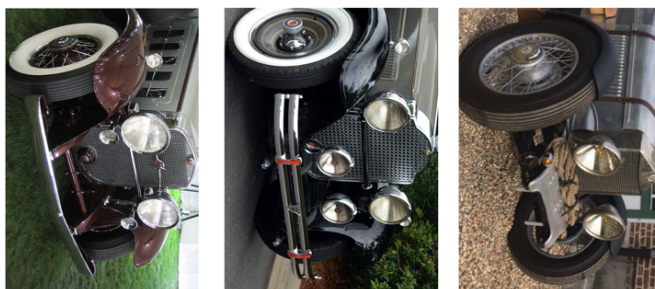
1885 - 1915:
Although invented in 1901 by Frederick Richard Simms. At the start of the automotive industry. The first three decades of the automobile, cars were basically a carriage with an engine, the wheels at the outside corners as much as possible.



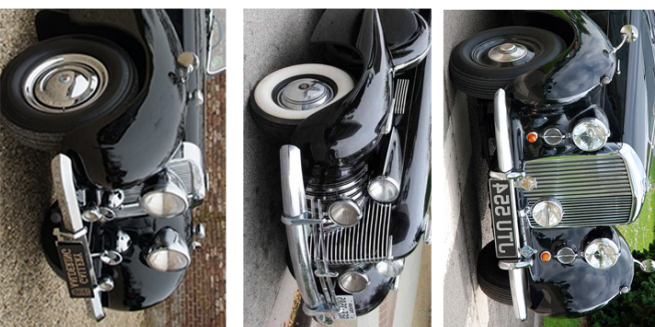
1910's:
The first bumper started life as a design feature in 1915. These were large steel beams and often only at the front of the car.



1920's:
For sportscar, bumpers were still often left out around the world, the bumper became more relevant as a desing feature. Double steel beam configuration was a common way of expressing this



1930's: Bumpers became more incorporated in the design of the whole vehicle, with also the fender flares becoming more part of the design. Except for sportscars, where weight was still an important factor.



1940's:
Fender flares were taken more to the front, getting closer to the bumper, and bumpers started to become part of the design of the front, being more part of the grill.

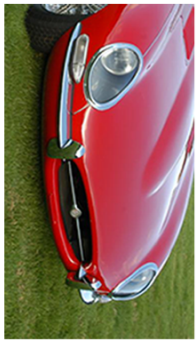


1990s:
Starts the design were bumpers are incorporated in the whole body. This is the design as we know it today.

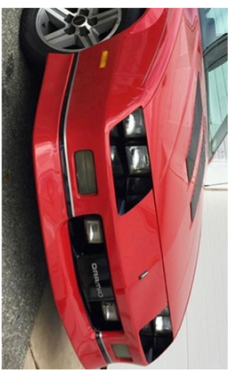
2010s:
the configuration of bumpers dit not change, there is a design element (the small horizontal beam, that resembles the bumper design.

2010s:
The front expresses the brand identity of the brand. Grills are often bigger than they need to be, pure as a design feature. The design element of the bumper is often left out.

2020s:
the front of the car is expressive in the brand identity and what type of car, a luxury sportscar often shows a very big grill purely as an aesthetic feature. Electric car design shows no grill to resemble the fact it does not need cooling.



Note design shift due to the safety regulations between '69 and '73 Jaguar E-type.



1950's:

After the second world war, Cars changed significantly, Fender flares were incorporated in the body, and bumpers became part of the front, often fully incorporated within the front grill. It became an important design feature, and often the rule was: 'bigger is better'.

1960's:

Safety measures started to take place, it became important that the bumper needed to provide protection the the headlights and engine, around 1969, bumpers were raised to a specific height to provide this protection.

Around the start of the 70's, Plastics were incorporated in bumper styles. At the start of this decade, new safety regulations for the occupants and pedestrians meant more safety equipment at the front. Bumpers were still mostly steel, with plastic incorporated.

1980's:

At the end of this decade bumpers became fully made out of plastic with the steel or aluminium safety beams hidden in the body, starting from here bumpers became designed as they still currently do.

I. Images Field research bumper panel lines



J. Active safety systems

Active safety measures that can lower the change of damage, lowering repair costs. This appendix provides insights in several ADAS systems that are relevant in urban situations.

Park Distance control

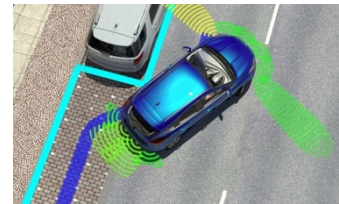
Starting in the early 2000s, the parking sensor invention started to break ground. Sensors help the driver know its surroundings, with the added function of a visual on the dashboard. Drivers are less likely to damage their car. This method can be expanded with a front and rear camera, or even 360° view camera. Allowing the driver to closely see what is happening around the car.

<http://industryarcblog.com/global-parking-sensors-market-share-size-analysis/>



Park assist

Another method is the park assist, where the car scans if the parking spot is. This system allows the car to steer the car autonomously. With high end brands, the car is even in control of the acceleration and brake. The big benefit of this system is that it can detect obstacles more accurately than a human. It is then able to stop itself when it senses a nearby obstacle. <https://www.confused.com/on-the-road/gadgets-tech/parking-technology-brief-history>



Autonomous driving

Finally, the ultimate solution/method would be autonomous driving vehicles, according to the automotive sector, this will be part of the future. With people taken out of the equation, vehicles can anticipate each other without the doubts and capabilities of the human behind it. This is however something that is not likely to happen in the near future, since the maximum speed of the VIANOVA is 80km/h. the necessity is also not there yet.



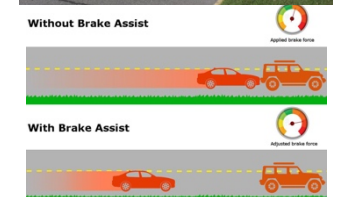
Pre-crash warning

Also referred to as CAS (collision avoidance system). This system warns the driver of a possible crash and takes actions to improve the safety when the driver is too late to react. The system relies on radar, laser and/or sensors to detect is a crash is likely to happen.



Brake Assist

This system helps the vehicle come to a stop quicker during emergency braking.



Lower side window

Another possible method based on knowledge acquired personally in the past, is using windows in the lower part of the door, McLaren has done this with a sportscar. This car, the McLaren Senna is very wide with intricate parts. The windows allow for better view on the side of the car. This was mainly a design feature for looking better at the corners when driving fast on the circuit (McLaren, 2018), however this could possibly help with parking creating a better view on the surroundings when parking. Scania has done something similar in order to create better view on the blind spot of a truck, allowing for better safety towards pedestrians and bikers.



K. Fastening systems

Traditional bumper fastening

Currently There are no specific ways in the fastening of bumper on the chassis of a car, usually brackets hold the bumper in place, but at multiple points the bumper is fixated with the use of small screws and fasteners.

Small metal screw and metal fastener, the fastener is often fixated on the bumper, bracket points on chassis allow for tightening with screw.



Quickloc

A patented design of Böllhoff, the Quickloc is often used for panels that need to be easily removed, for instance panels in the engine bay that cover parts that do not need direct access. These quick fastening systems often do not need extra tooling, making it easy to remove.



Dart clips & Push rivets

There are companies that specialize in fastening solution for automotive body panels and trim fasteners. Araymond provides ways of different technologies of fastening systems, with dart clips and push rivets specially designed for automotive body panels.



Quick release system

There are also other quick release systems often used in the Drift scene. These cars a very low and in order to transport them the bumper often needs to be removed. An easy solution is this system. These are however very visible on the aesthetics of the vehicle.

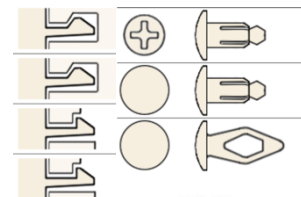


Snap locks & clips

Snap locks or 'snaps' are a common practice of fastening light panels and is often used for consumer goods. There are different types, some can be dissembled without tools, some require tools, the image shows the two top ones that do not need tooling, the bottom two need common tools.

Böllhoff also offers a specific snap lock system called Snaploc, this is another system specifically designed for the automotive sector.

Then there are clips, clips are common in the automotive industry, these are often hidden behind interior panels. This allows for easy access electronics or systems behind for instance the door panels. They require some force to be dissembled, but do not need tooling.



Click bonds

Click bonds allow for normal bolts to be with flush and shallow areas. This type of fastener often does however use an adhesive in order to fixate the bonds to the panels that need to be linked together. The mall part of a click bond can also be an ordinary screw or bolt



Fidlocks

Fidlock systems are often used for other types of fastening systems, it works with sliding two parts together that create a tight fit. The image shows an interesting possibility incorporating this with magnetic technology. The advantage of using Fidlocks, is that it is easier to hide the fastening systems.



Slide mechanism

A possible new way of fixating the front bumper, is the use of a slide mechanism. The front bumper would slide into place and the mechanism also has a purpose of moving when a frontal crash occurs with low speed. The energy absorber absorbs the energy and the bumper only move backwards, possibly lowering the chance of damaging it. Ideally it would slide under the bonnet and side wings, allowing does parts to remain undamaged.



L. Photographs dismantled BMW bumper
(Pictures taken at BMW Breeman)





M. Plastic materials used in automotive parts

Fentahun, M. A. 2018

<i>High performance plastics</i>	<i>characteristics</i>	<i>applications</i>
1. <i>Polypropylene (PP)</i>	polypropylene is a thermoplastic polymer used in a wide variety of applications. A saturated addition polymer made from the monomer propylene, it is rugged and unusually resistant to many chemical solvents, bases and acids.	automotive bumpers, chemical tanks, cable insulation, gas cans, carpet fibres.
2. <i>Polyurethane (PUR).</i>	Polyurethane (PUR). Solid Polyurethane is an elastomeric material of exceptional physical properties including toughness, flexibility, and resistance to abrasion and temperature. Polyurethane has a broad hardness range, from eraser soft to bowling ball hard. Other polyurethane characteristics include extremely high flex-life, high load-bearing capacity and outstanding resistance to weather, ozone, radiation, oil, gasoline and most solvents.	flexible foam seating, foam insulation panels, elastomeric wheels and tyres, automotive suspension bushings, cushions, electrical potting compounds, hard plastic parts.
3. <i>Poly-Vinyl-Chloride (PVC).</i>	PVC has good flexibility, is flame retardant, and has good thermal stability, a high gloss, and low (to no) lead content. Polyvinyl chloride moulding compounds can be extruded, injection moulded, compression moulded, calendared, and blow moulded to form a huge variety of products, either rigid or flexible depending on the amount and type of plasticizers used.	automobile instruments panels, sheathing of electrical cables, pipes, doors.
4. <i>Acrylonitrile Butadiene Styrene (ABS)</i>	Acrylonitrile Butadiene Styrene is a copolymer made by polymerizing styrene and acrylonitrile in the presence of polybutadiene. The styrene gives the plastic a shiny, impervious surface. The butadiene, a rubbery substance, provides resilience even at low temperatures. A variety of modifications can be made to improve impact resistance, toughness, and heat resistance.	automotive body parts, dashboards, wheel covers.
5. <i>Polyamide (PA, Nylon 6/6, Nylon 6).</i>	Nylon 6/6 is a general-purpose nylon that can be both moulded and extruded. Nylon 6/6 has good mechanical properties and wear resistance. It is frequently used when a low cost, high mechanical strength, rigid and stable material is required. Nylon is highly water absorbent and will swell in watery environments.	gears, bushes, cams, bearings, weatherproof coatings
6. <i>Polystyrene (PS).</i>	Naturally clear, polystyrene exhibits excellent chemical and electrical resistance. Special high gloss and high-impact grades are widely	equipment housings, buttons, car fittings, display bases.

	available. This easy to manufacture plastic has poor resistance to UV light.	
7. <i>Polyethylene (PE).</i>	Polyethylene has high-impact resistant, low density, and exhibits good toughness. It can be used in a wide variety of thermoplastics processing methods and is particularly useful where moisture resistance and low cost are required.	car bodies (glass reinforced), electrical insulation.
8. <i>POM (polyoxymethylene).</i>	POM has excellent stiffness, rigidity, and yield strength. These properties are stable in low temperatures. POM also is highly chemical and fuel resistant.	interior and exterior trims, fuel systems, small gears.
9. <i>Polycarbonate (PC).</i>	high performance plastics Amorphous polycarbonate polymer offers a unique combination of stiffness, hardness and toughness. It exhibits excellent weathering, creep, impact, optical, electrical and thermal properties. Because of its extraordinary impact strength, it is the material for car bumpers, helmets of all kinds and bullet-proof glass substitutes.	bumpers, headlamp lenses.
10. <i>Acrylic (PMMA).</i>	A transparent thermoplastic, PMMA is often used as a lightweight or shatter-resistant alternative to glass. It is cheaper than PC but is also more prone to scratching and shattering.	windows, displays, screens.
11. <i>PBT (polybutylene terephthalate).</i>	The thermoplastic PBT is used as an insulator in the electrical and electronics industries. It is highly chemical and heat resistant. Flame-retardant grades are available.	door handles, bumpers, carburettor components.
12. <i>Polyethylene terephthalate (PET).</i>	PET is mostly used to create synthetic fibres and plastic bottles. You may recognize it on clothing labels under the name 'polyester.'	wiper arm and gear housings, headlamp retainer, engine cover, connector housings.
13. <i>ASA (acrylonitrile styrene acrylate).</i>	Similar to ABS, ASA has great toughness and rigidity, good chemical resistance and thermal stability, outstanding resistance to weather, ageing and yellowing, and high gloss. Be careful not to burn this material. It will cause a toxic smoke.	housings, profiles, interior parts and outdoor applications.

N. Comparison PP VS ABS

	PP	ABS
Recycle number		
Embodied energy	62,800 MJ/ m ³	95,300 MJ/m ³
Average Price (CES EDUPACK 2019)	1.19 – 1.23 EUR/KG	1.23 – 1.74 EUR/KG
Density (Mg/m3)	0.89 – 0.91	1.01 – 1.21
Young's Modulus E (GPa)	0.896 – 1.55	1.1 – 2.9
Yield strength (MPa)	20.7 – 37.2	18.5 - 51
Tensile strength (MPa)	20.7 - 37.2	27.6 - 55.2
Fracture toughness (MPa*m ^{1/2})	3 – 4.5	1.19 – 4.30

Including the insights from damage experts at BMW and others, Polypropylene is currently more used, it also has a higher flexibility, making it less likely to break, Furthermore ABS tends to get brittle when it is colder, making it easier to crack.

O. PP Welding

Retrieved from Polyvance.com, specialist in plastic repairs.

Polypropylene welding works similar to that of ordinary metal welding

The focus with thermoplastic welding is on two different types of techniques,

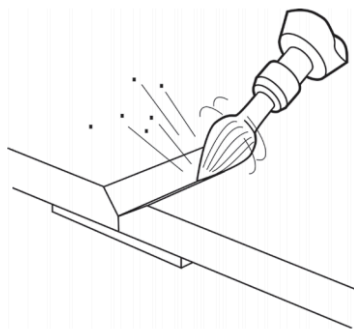
- Fusion welding
- Nitrogen welding.

Information is retrieved from Polyvance, company specializes in different types of Plastic repair techniques.

Almost all bumpers are made from thermoplastic materials, the mis they can be melted with the application of heat. Considering TPO's can be welded using Fusion welding or Nitrogen welding, Nitrogen welding offers the strongest Bond to repair thermoplastics.

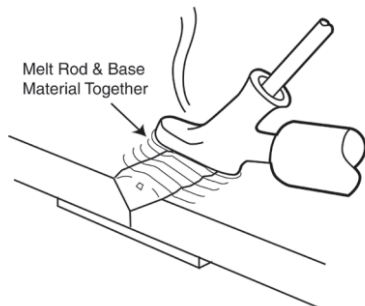
The illustrates below are descriptions retrieved from Polyvance, explaining the steps of Fusion welding and Nitrogen welding.

Fusion welding



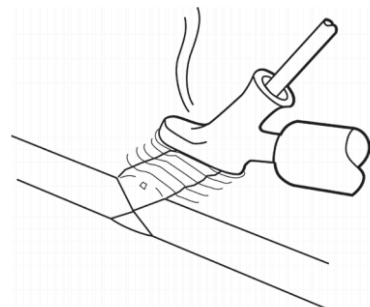
V-Groove Damaged Area

- Line up the outer surface of the tear with 6482 or 6485 Aluminum Body Tape or with clamps.
- V-groove halfway through the part with either the 6121-T Teardrop Cutter Bit and a rotary tool or the sharp edge of the plastic welding tip.
- Remove the paint in the area surrounding the v-groove and radius into the v-groove with coarse sandpaper.



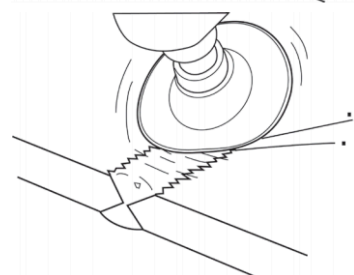
Melt the Rod Together with the Base Material

- Set the temperature setting of your airless plastic welder to the setting that's appropriate for the welding rod you selected in the identification process. In most cases, the welding rod should melt cleanly and not be discolored (the only exception would be nylon, where the rod should turn a light brown).
- Lay the welder tip on the surface of the plastic and slowly melt the rod into the v-groove. Pull the welder toward you so you can see the welding rod fill the v-groove as you make your pass.
- Lay down no more than 2 inches of welding rod into the v-groove at a time. Remove the rod from the welder tip, and before the melted rod has time to cool down, go back over it with the hot welder tip and thoroughly melt the rod together with the base material. It helps to press into the plastic with the edge of the welder tip to mix the materials, then go back and smooth it out. Keep the heat on it until you have a good mix between the rod and base.



V-Groove and Weld Opposite Side

- After the weld on the backside cools, repeat the v-grooving and welding process on the opposite side.



Grind Weld to a Smooth Contour

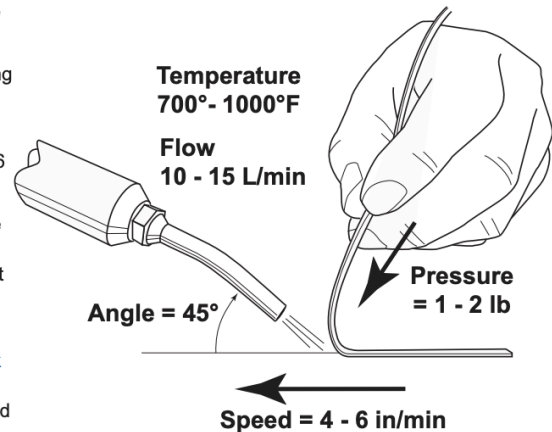
- If you need to refinish the plastic, grind weld to a smooth contour with coarse sandpaper. Grind the weld slightly flush so that filler can cover the welded area completely. Follow instructions for filler application. (Page 15)

Nitrogen welding

Basic nitrogen welding process

Welding with nitrogen involves the coordination of both hands, one controlling the torch and the other feeding the rod. When you weld, you just want to melt the bottom surface of the rod and the top of the bumper. You don't "puddle" the rod like you do in metal welding. This makes for a stronger repair because it leaves the basic structure of the rod intact. When you're making your weld, make sure you melt both the bumper and the rod at the same time and fuse them together with the downward pressure on the rod. Remember the five important factors for plastic welding: "T.F.A.P.S.", an acronym for Temperature, Flow, Angle, Pressure, and Speed.

- For **temperature**, set the temperature on the nitrogen welder's dial to the proper setting. For example, the PP/TPO setting will generate an air flow of about 700°-800°F.
- The **flow** should be set between 10 to 15 liters per minute depending on the plastic's thickness; less for thinner plastics, more for thicker.
- An **angle** of 45° between the torch and the bumper is optimum. Aim the stream of hot air a little in front of the rod; for thick rod like the O6 profile, focus a little more heat on the rod.
- Put as much downward **pressure** on the rod as possible to help the rod fuse with the bumper. Keep a steady downward pressure on the rod and keep the rod moving slowly. Don't overheat the rod and let it fold over backwards.
- The **speed** of your weld should be about 4 to 6 inches per minute. With thin rod like the O3 profile, it's difficult to go this slow. With thick rod like the O6 profile, it may go even slower. The important thing is to move steadily while keeping proper downward pressure on the rod while making sure the bumper and the bottom surface of the rod are both melted before they come together.



Considering that both methods work for Microcab, there is no preference. Research should point out what is more available in the area of Microcab or preferred to do in-house. The advantage of both methods compared to repairing GRP. Both could be easily thought in-house. Significantly lowering the costs, generally hourly rates in the automotive industry are between 50 and 80 pounds. The materials for repairing a TPO bumper are neglectable in the price. A professional air fusion welding machine can cost 700 pounds (nitrogenwelder.com), however it can be used for a long time.

A plastic welding consumable kit for PP type plastics costs 25 pounds, depending on the severity of the damage, this can be used for multiple cars. A plastic smoothing iron cost no more than 40 pounds, resulting in a combined cost of less than 800 pounds, assuming the tools last 4 years, and the sticks can do 10 damages. A large crack can take up to two hours, estimate same hourly wage as GRP, so outsourcing it would cost more than 200 pounds, keeping it in-house, the investment costs are low, and the repairs can be done by own mechanics, if proper trained, significantly lowering the costs. Better to work with compared to thermosets and does not involve toxic chemicals, which need health & safety precautions.

P. Process of Painting a car

Information retrieved from Desjardins insurance

Generally, cars can be spray-painted through two different means, large car manufacturers use robots that spray paint the cars, manufacturers with considerably low production volumes are often sprayed by hand. Considering the production volume of Microcab, manually is the only viable method. It would not be economically viable to incorporate an automated spray booth.

Manually spray painting a car requires several materials and steps in order to provide a visual pleasing and protective layer. Both are listed below.

Materials required for painting a car manually:

- A spray booth
- A power sander
- Sanding pads
- An air compressor
- A paint sprayer
- 1200- and 2000-grit sandpaper
- A cleaning solvent
- Newspaper
- Masking Tape
- Primer
- Enamel, acrylic enamel, or polyurethane paint
- Paint thinner
- face masks to protect against the VOC's
- Safety glasses
- Undercoat/primer
- clear coat lacquer
- A rag
- Denatured alcohol or mineral spirits
- Rubbing compound (optional)

Steps:

Preparation

Step 1: prepare spray booth (often the floor is watered to lower dust particles to get in the air)

Step 2: make sure all imperfections are removed from the body

Sanding

Step 3: Sand

Step 4: Clean

Step 5: Tape surfaces

Priming

Step 6: Prime

Step 7: Allow primer to cure

Step 8: Sand once more

Step 9: Wipe down

Painting

Step 10: Paint

Step 11: Sand and wipe

Step 12: Apply lacquer

Step 13: Remove masking tape

Step 14: Buff



Q. Infographic car wrapping process

HOW TO VINYL WRAP


7 STEPS USED BY PROFESSIONALS

Have you considered vinyl wrapping your car but don't know where to start? What are the pros and cons of vinyl wrapping? Does it have to be done by a professional? How much material should you buy?

The truth is that you **CAN** do it at home by following the same seven steps we do. However, if after going through the process, you decide that this project is more than you want to tackle, contact us now. We'd be happy to give you quote on your new vinyl wrap.





1 PLANNING OUT HOW TO VINYL WRAP YOUR CAR




PREPARATION

Quality install depends on good prep and solid approach.



AMOUNT OF VINYL


You must know how much vinyl is necessary to wrap the part.



REMOVING BLOCKING PARTS


You need to remove anything which could block you from wrapping the surface entirely.

2 CLEAN & PREP THE CAR BEFORE VEHICLE WRAPPING




CLEANING THE SURFACE

Clean surface/product is the most critical step. Use degreaser and 70% Isopropyl Alcohol.



SMOOTH SURFACE


Make sure that the wrapping surface is smooth to the touch.



BEWARE OF IMPERFECTIONS


Chips, scratches or dirt debris can't be covered. Any imperfection will be visible once wrapped.

3 VINYL WRAP SIZE & MEASUREMENTS




SAFE MEASURING

Once everything is clean, you'll want to measure your vinyl 4-6 inches longer than needed for the piece you're wrapping.



VINYL SIZE


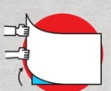

Vinyl comes in a 60 inch roll by 25 feet in length.




OVERSIZED

Most panels are smaller than 60 in, but sometimes you'll need to cut multiple pieces for an oversized hood/trunk/roof...

4 LAYING VINYL WRAP






5 CUTTING VINYL WRAP



RAZOR HANDLING

The most important thing to remember when cutting vinyl wrap is a razor blade will scratch your paint quickly. Watch your blade and put away when not in use.





CUT AND TUCK

When wrapping a body panel, use the outer edge of the body to make the cut ensuring there is 1 to 4 cm to tuck around the edge.

TIP 1. You never want to cut directly on the vehicle. Always keep your blade away from the paint surface by lifting the vinyl slightly running your blade along the edge, then press the vinyl back down.

TIP 2. Practice cutting vinyl on a raw piece of metal or non-vehicle part before you start working directly on your vehicle to ensure you don't accidentally damage your paint.

6 TUCKING VINYL EDGES



TUCK EDGES

After you make your cuts, tuck all of the edges against a clean surface to ensure your vinyl looks factory.

TIP 1. Make sure that the wrapping surface is clean and smooth to the touch.

TIP 2. If there is too much stretch or tension in the vinyl, the edges will fall.

7 POST HEAT

FINAL STEPS

Run your heat gun briefly over the surface of the wrap to eliminate wrinkles as well as ensure your edges are secure and the vinyl adhered tightly to the surface.

CLEAN

After you finish heating, clean the vinyl surface with alcohol water and inspect your panel.

TIP 1. Post heating will relieve tension in the vinyl and ensure the tucked edges don't fall.


TIP 2. On deep pockets and contoured edges, post heat will ensure your vinyl edges don't move or pop when the wrap is exposed to the sun.

FINAL WORDS OF ADVICE ON HOW TO VINYL WRAP YOUR CAR

If you choose a high quality vinyl wrap material and take your time to pay attention to the details, when it comes time to remove the wrap, your paint will look exactly the way it did the day you wrapped it. High quality vinyl and proper application techniques will not damage your car's paint. In fact, vinyl wrap offers a layer of protection against the weather and road debris that will last for years when properly maintained.

The cost of a vinyl wrap is significantly less than a quality paint job. Vinyl wraps are highly customizable and are offered in a wide variety of unique colors and patterns.

By following these 7 Steps on How to Vinyl Wrap a Car, you can have a professional looking wrap and save a bit of money. However, after spending a little time on your wrap, you might be surprised at how little it costs to have your car wrapped professionally given the amount of work required to get a professional looking finish.



1945 East Jefferson Street
Phoenix, AZ 85024
Tel: (480) 331-3924
sales@apexcustoms.com
www.apexcustoms.com

R. Technical specifications 3M Envision Wrap Film

Retrieved from 3M

Specifications	
Adhesive Colour	Gray
Adhesive	
Controltac/Comply	Controltac™ and Comply™
Adhesive Features	Air-Release, Slideability
Application	Buildings & Walls, Cars & Vans, Displays, Trucks and trailers, Vehicles & Transportation, Walls, Watercraft, Windows & Glass
Application Surface	Compound Curves, Corrugations, Deep Channels, Flat, Flat with rivets, Simple curves
Brand	Envision™
Certifications and Specifications	ASTM D-4956 07 for Type 1 Sheeting, NFPA®
Colour Effect	Metallic
Colour Name	White
Colour Palette	White
Core Size (Imperial)	3 in, 6 in
Film Type	Non-PVC
Imaging Method	Digital Print
Line	Digital Printing Films, Overlaminates and Inks
Max. Durability	11 years
Opacity	Opaque
Overall Length (Imperial)	100 yd, 200 yd, 50 yd
Overall Length (Metric)	183 m, 45.7 m, 91 m, 91.4 m
Overall Width (Imperial)	48 in, 54 in, 60 in
Overall Width (Metric)	1.37 m, 1.52 m, 1220 mm, 1371.6 mm
Performance Level	Premium
Print Compatibility	Latex, Solvent, UV
Product Color	White
Product Type	Digital Print Film
Product Usage	Exterior, Interior
Removability	Permanent, Removable with heat
Service Temperature	-60°C to +107°C
Substrate Type	ABS, Aluminium, Chrome, Fibreglass reinforced plastics, Glass, Paint, PMMA, Polycarbonate
Surface Finish	Luster
Vehicle Type	Boat, Bus, Tram & Metro, Car & Van, Emergency Vehicle, Recreational Vehicle, Truck & Trailer
Warranty	3M Basic Product Warranty, 3M Performance Guarantee, 3M™ MCS™ Warranty

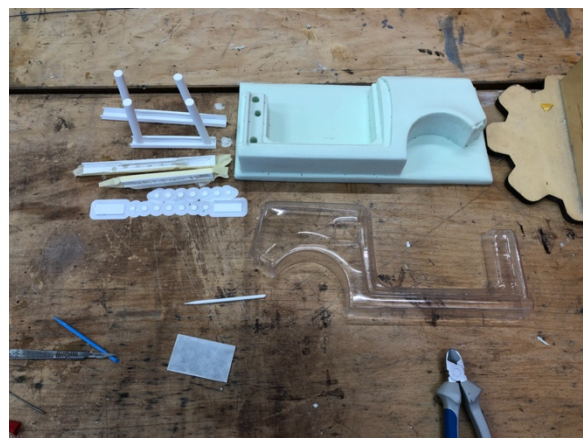
S. Mood board design language



T. Embodiment

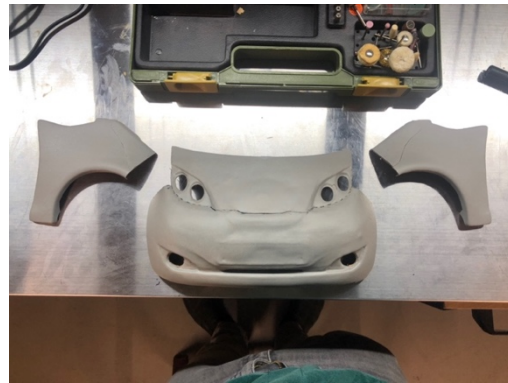
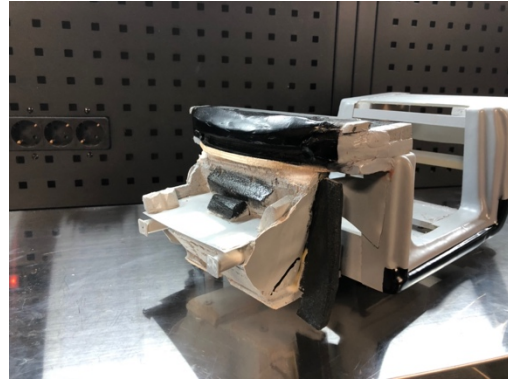
The first model includes the noise dampening plates, to get insight over the current situation. The second model did not have these plates, to better work with the available space and look for opportunities.

The body panels were produced at the faculty of IDE, where there was the ability to vacuum form them. Measurements in the models are not accurate due to the loss of details during the several stages of building. Figures in this paragraph help illustrate overall findings. Since there were not a lot of points to fixate the body panels on, the support structure was made with plasticine (clay). This allowed for easy shaping to the contours of the body. Furthermore, the bonnet should be fixated on the chassis and not on the front bumper, therefore the structure goes over the width of the vehicle, making sure all panels are supported. The bumper beam is extended, protecting against impacts with an angle. In between the support/bumper beam and bumper, an energy absorber is added. Overall, there is enough space to incorporate the elements of the concept, however further testing and measuring is required with the 1:1 scale VIANOVA.











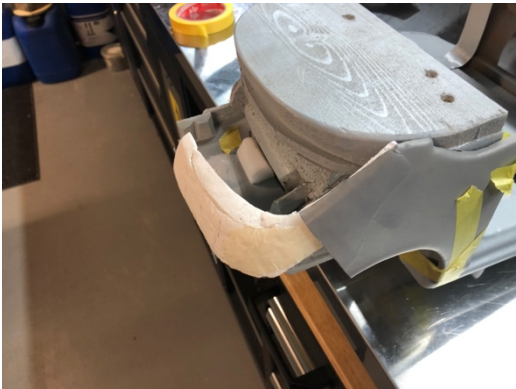
First support structure iteration

Follows lower lines of the body and connect to the end of the bumper beam.



Second iteration of the support structure

Started as a relatively big structure, with a mount in the middle of the bumper beam. Due to the available space, it was thought to place this at the sides as visualised in the report.



To conclude, a clear visualisation of the iterated bumper beam with energy absorber. Bottom beam in first images represent the existing bumper beam. It was found that in an ideal situation, the fog lights would be redesigned, creating more space for the bumper beam. Simplifying the shape.



Critical area

The critical area regarding the fog lights is illustrated in the following images.

The final two pictures review two different types of bumper beam iterations. One, new bumper beam design. And the other one that allows for an extension by bolting a part on the existing bumper beam.



Current scenario



Iterated scenario 1

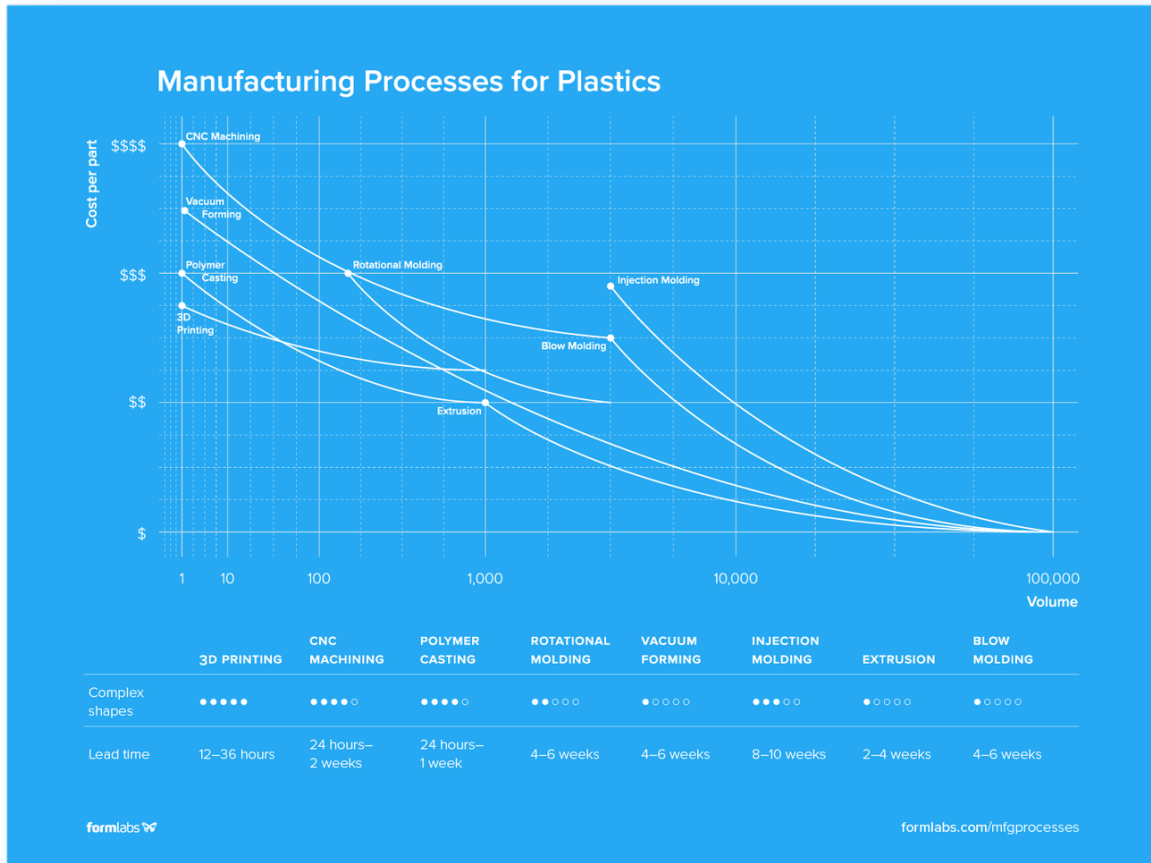


Iterated scenario 2

U. Manufacturing Processes for Plastics

Two processes were taken in consideration regarding the manufacturing of the body panels with TPO. Injection moulding and Thermoforming. Both processes are common in the automotive industry. However, injection moulding tends to be more cost effective with high production volumes.

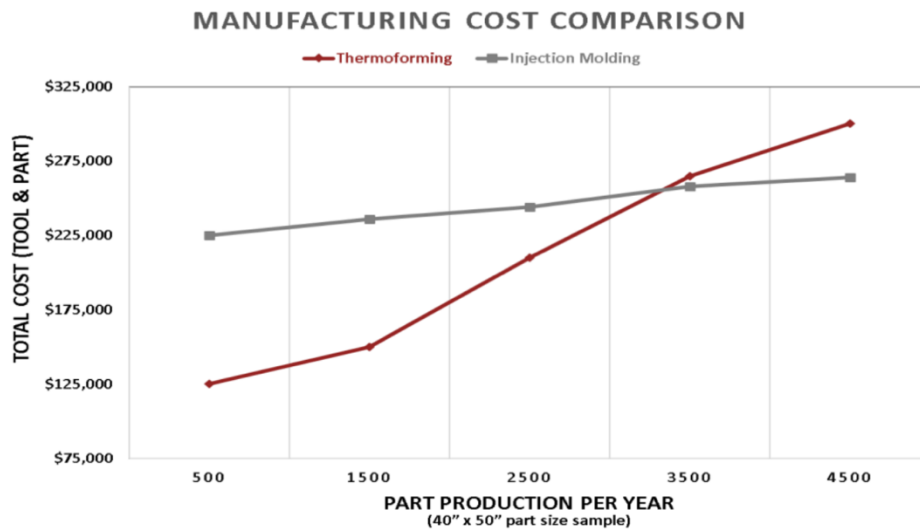
The table below (retrieved from Flowlab) illustrates the typical manufacturing processes for plastics. Based on the required production volume of Microcab, injection moulding is not even feasible due to the much higher production volume when it starts to become cost effective. Vacuum forming is a type of thermoforming.



This is further substantiated by a rule of thumb, retrieved from Productive plastics. Illustrated below.

The breakeven cost can vary GREATLY for each project, but typically
less than 3,000 - 5,000 parts = plastic thermoforming
more than 3,000-5,000 parts = injection molding

The chart below already provides a good estimation of the costs of thermoforming including the part. Generally vacuum forming is cost effective for low to moderate quantities (300 – 5000). Based on the chart, a part measuring +/- 100cm x 130cm costs around £180 pounds. Considering one mould can produce 2000 parts over the timespan of 3 to 4 years, results in an estimate of £64 pounds per part. Significantly lower.



There are however two types of two different types relevant to this case study.

- Vacuum forming (uses a 'male' tool)
- Pressure forming (uses a 'female' tool)

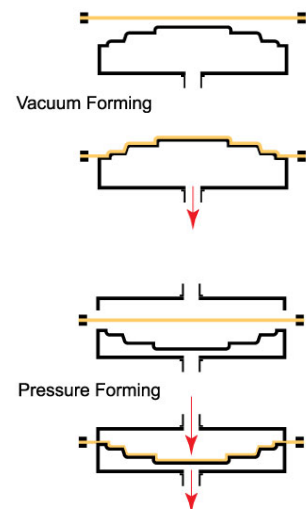
Both processes work with a sheet of plastic that is heated.

Each process has its advantages.

Vacuum forming is usually for larger parts and the costs for the moulds are usually lower.

Pressure forming allows for more detail and surface textures can be added (on one side, compared to both sides with injection moulding). Whether to choose which process suits best depends mostly on design (EngatechR7D).

It is possible to manufacture the parts in the current colour, requiring no paint. However, this is not possible in recycling. Materials are often mixed and loses its colour.



Trimming of residue materials and further operations required to finish the part are the same. Moulds are currently being made with 3D printing techniques, allowing for a lower lead time and having a mould from a digital CAD file straight to the 3D printer. This helps Microcab with the start production of 100 units. Generally during prototyping or pilot runs, hardwood is also possible, for full production, aluminium is required.

Bases on the requirement and insights retrieved from this Data.

Pressure forming is suggested, especially for the Bonnet with headlight cluster and the bumper, due to the detailing of the headlight- and fog-light cluster. For the wings, vacuum forming should be sufficient if the costs are lower.

To summarize, a list of advantages of Pressure forming (Brentwood):

- High level of detail possible
- Significantly lower tooling costs than injection moulding
- Ability to form parts with functional detail
- Cost effective
- Large parts
- Rapid prototyping, thus low lead time

V. Cost overview

The costs are based on a production volume of 2000 units divided over 4 years, allowing for the ability to adapt the mould if necessary, and introduce a LCI when the design would require an update.

Cost is based on the findings throughout the research and the manufacturing process. All costs are estimated and rounded off.

Costs front clip panels

Parts	Estimate measurements in centimetres	Estimates costs per product
2x Wings	: 88*88	: £100
1x Bonnet	: 125*62,5	: £60
1X Bumper	: 162,5*69	: £65
Total		: £225

Costs Surface finish

Prices were difficult to find for the PVC-free wrap film.

The figure to the rights belongs to a company located in the UK that supplies the material (Walsh Graphics). The bumper would require a wider roll, but this does give a good estimation. Estimating that one roll can wrap +- 15 vehicles. And setting the price for one roll at £900 (considering this one is not coloured).

The costs per front section are around £60.

This is without labour, the process of wrapping a car is quite time consuming, generally a normal vehicle costs around £2000 pounds to wrap, whereas painting a car costs between £1000 to £3000 pounds, depending on the quality. Prices are pretty comparable. However, on a production line, spray painting tends to get cheaper, because it can be done a lot faster.

Nevertheless, wrapping the car is a process that can be learned and quite possibly be done in-house. It is also possible to hire a car wrapper directly. Outsourcing it generally is more expensive, front section including materials would cost around £350 (D. van Fellegen, owner PPFLAB)

Assuming it takes around 6 hours to wrap the front section of the VIANOVA by one worker. And the average vehicle wrapper salary in the UK is £12.82 per hour (uk.talent.com). this seemed a bit low, so in precaution of missed costs, this is set at £15 per hour. Furthermore, wraps require (similar as to paint) a rest period, usually around 12 hours.

All costs are combined to give an estimate of the costs.

3m Envision wrap film £900/15 cars	: £60
Labour	: £90
Equipment (assumed)	: £20
Total	: £170

Costs Energy absorber

Energy absorber do not require a lot of detail, can be produced through multiple manufacturing methods, and the material costs are low, since the density is low.

Determining a price for the energy absorber is difficult considering it has not been elaborately reviewed.

It was found that it has a 4% advantage on repair costs, lowering the cost throughout the lifecycle of the VIANOVA in general.

An energy absorber is generally manufactured through Foam moulding, this is a type of injection moulding. Considering Injection moulding is relatively expensive. A large mould can cost as much as £100K. not viable for Microcab. A company in Coventry specializes in Foam moulding → MRA Foam Mouldings Limited. They could determine a better price. Another manufacturing process that can possibly be incorporated, is rotational moulding. This would not be creating a foam or x-shaped energy absorber. But a hollow product. This fills in the negative space between the bumper 'fascia' and bumper beam, allowing for some form of energy absorption. Tooling costs are significantly lower (15000 for a mould), creating the opportunity to implement some form of energy absorption. Provided a company in the UK → Excelsior Ltd, offering roto moulding. Based on roto moulding, the energy absorber should not cost more than **£20**.

3M Envision Print Wrap Film SV480mC

From **£380.92**

Short Description

3M Envision Print Wrap Film SV480MC is a high performance, versatile, non PVC film - suitable for vehicles, trailers, boats and textured walls.

Choose your Product

Options	Qty	Price
1370mm x 25m roll	0	£380.92
1370mm x 50m roll	0	£761.84

Costs Structural components & fasteners & extended bumper beam

A mounting kit for a front bumper costs 16,95 pounds for a consumer (winparts.nl). considering Microcab can buy in bulk, significantly lowers the price, also redacting the VAT.

The consumer price is divided by 3 to give an estimation. Resulting in 6 pounds (rounded off) for each VIANOVA.

Finally, determining the costs for the constructive parts are difficult to calculate, materials and shapes have not clearly been defined.

The internet offers a wide selection of upper load path beams for sale for consumers, with considerable prices (Ebay). Determining a price for the VIANOVA is purely based on assumptions and estimates.

Therefore, assuming a relatively high price of 140 pounds for 2 side beams considering the shape is more intricate. A crossmember, or some form of support for the bonnet should be easy designed and manufacturable in-house. Prices on the internet are significantly lower compared to a side load beam.

Assumed is a price of 30 pounds.

The price of the bumper beam is also determined using available sources on the internet, a large variety is available. Considering the shape of the bumper beam of the VIANOVA will require a redesign or additional parts mounted on it. Costs are added. A relatively high price of £80 is assumed to count for unexpected costs.

Summarizing the costs:

Structural components

Fasteners	: £6
2X Load beams	: £140
Cross member	: £30
Extended bumper beam	: £80
Total	: £256

To conclude, all costs are added together, with additionally 10% for miscellaneous costs.

Total cost estimation:

Body panels	: £225
Surface finish	: £170
Energy absorber	: £20
Fasteners	: £6
Structural components	: £256
Combined total	: £677
Miscellaneous	: 10%
Total	: £745

W. Project Brief

APPROVAL PROJECT BRIEF

To be filled in by the chair of the supervisory team.

chair _____ date ____ - ____ - ____ signature _____

Digitally signed by
Conny Bakker - IO
 Date: 2020.09.14 17:48:13 +02'00
r - IO

CHECK STUDY PROGRESS

To be filled in by the SSC E&SA (Shared Service Center, Education & Student Affairs), after approval of the project brief by the Chair. The study progress will be checked for a 2nd time just before the green light meeting.

Master electives no. of EC accumulated in total: _____ EC

YES all 1st year master courses passed

Of which, taking the conditional requirements into account, can be part of the exam programme _____ EC

NO missing 1st year master courses are:

List of electives obtained before the third semester without approval of the BoE

name _____ date ____ - ____ - ____ signature _____

FORMAL APPROVAL GRADUATION PROJECT

To be filled in by the Board of Examiners of IDE TU Delft. Please check the supervisory team and study the parts of the brief marked **. Next, please assess, (dis)approve and sign this Project Brief, by using the criteria below.

- Does the project fit within the (MSc)-programme of the student (taking into account, if described, the activities done next to the obligatory MSc specific courses)?
- Is the level of the project challenging enough for a MSc IDE graduating student?
- Is the project expected to be doable within 100 working days/20 weeks ?
- Does the composition of the supervisory team comply with the regulations and fit the assignment ?

Content: APPROVED NOT APPROVED

Procedure: APPROVED NOT APPROVED

comments

name _____ date ____ - ____ - ____ signature _____

introduction (continued): space for images

image / figure 1: _____

image / figure 2: _____

PROBLEM DEFINITION **

Limit and define the scope and solution space of your project to one that is manageable within one Master Graduation Project of 30 EC (= 20 full time weeks or 100 working days) and clearly indicate what issue(s) should be addressed in this project.

ASSIGNMENT **

State in 2 or 3 sentences what you are going to research, design, create and / or generate, that will solve (part of) the issue(s) pointed out in "problem definition". Then illustrate this assignment by indicating what kind of solution you expect and / or aim to deliver, for instance: a product, a product-service combination, a strategy illustrated through product or product-service combination ideas, In case of a Specialisation and/or Annotation, make sure the assignment reflects this/these.

PLANNING AND APPROACH **

Include a Gantt Chart (replace the example below - more examples can be found in Manual 2) that shows the different phases of your project, deliverables you have in mind, meetings, and how you plan to spend your time. Please note that all activities should fit within the given net time of 30 EC = 20 full time weeks or 100 working days, and your planning should include a kick-off meeting, mid-term meeting, green light meeting and graduation ceremony. Illustrate your Gantt Chart by, for instance, explaining your approach, and please indicate periods of part-time activities and/or periods of not spending time on your graduation project, if any, for instance because of holidays or parallel activities.

start date _____ - _____ - _____ end date

MOTIVATION AND PERSONAL AMBITIONS

Explain why you set up this project, what competences you want to prove and learn. For example: acquired competences from your MSc programme, the elective semester, extra-curricular activities (etc.) and point out the competences you have yet developed. Optionally, describe which personal learning ambitions you explicitly want to address in this project, on top of the learning objectives of the Graduation Project, such as: in depth knowledge a on specific subject, broadening your competences or experimenting with a specific tool and/or methodology, Stick to no more than five ambitions.

Vertical dashed line on the left side of the page.

FINAL COMMENTS

In case your project brief needs final comments, please add any information you think is relevant.

Vertical dashed line on the left side of the page.