

WELCOME

P5 PRESENTATION

Femke Slooff





**DESIGNING AN OLYMPIC
AQUATIC CENTER**



19/01/2023

INDEX

INTRODUCTION

DESIGN FRAMEWORK

LOCATION OF THE DESIGN

CONCEPT

CONTEXT

THE DESIGN

IMPLEMENTATION OF THE RESEARCH

REFLECTION

INTRODUCTION



BERLIN



BERLIN

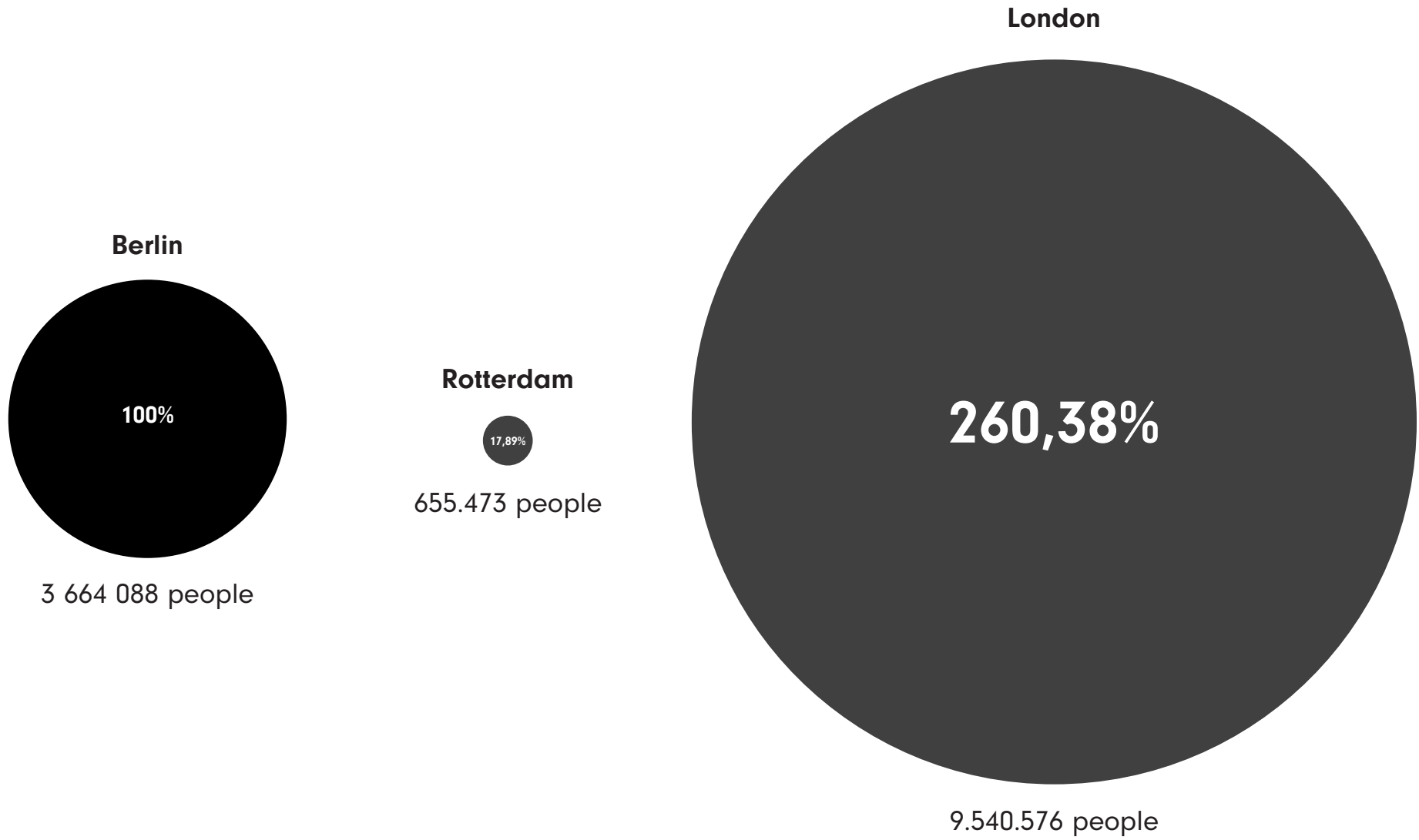

BERLIN

Almost **44%** of the city's surface area is made up of woods, farmland, water, allotment gardens, parks

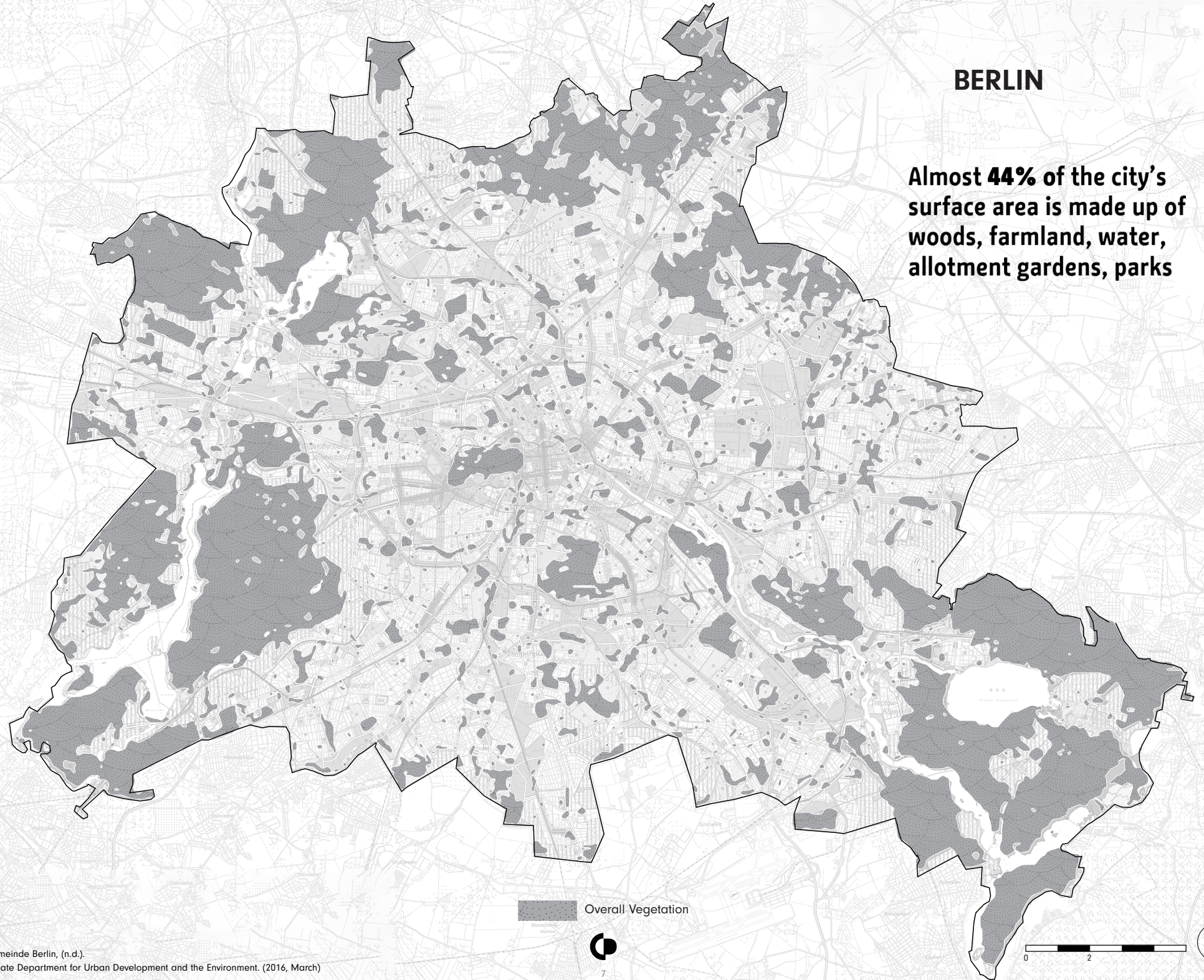

1| Gemeinde Berlin, (n.d.).

4| Senate Department for Urban Development and the Environment. (2016, March)

BERLIN

SOIL SEALING

33% of the entire city surface consists of sealed surfaces



11% is sealed surfaces of built-up areas (buildings of all types)



22% is sealed surfaces of non built-up areas (streets etc.)

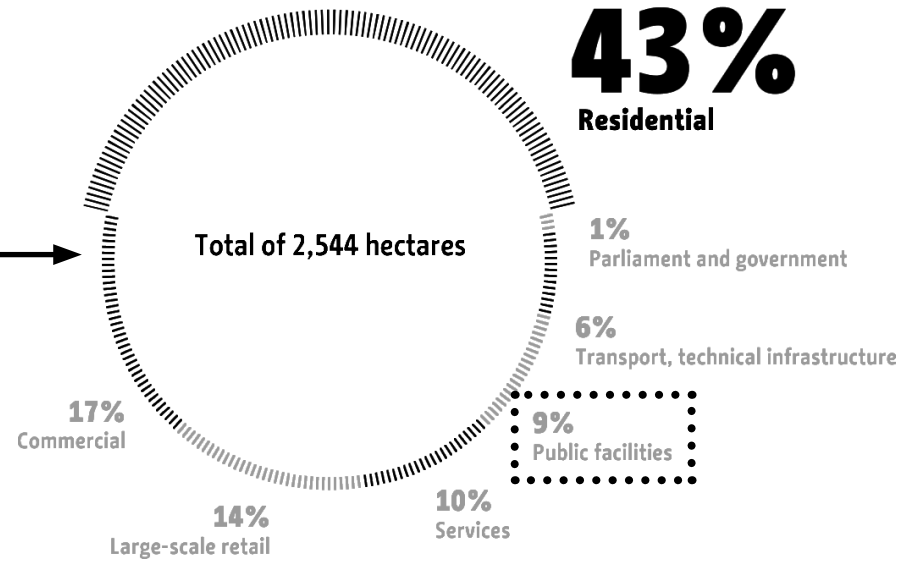
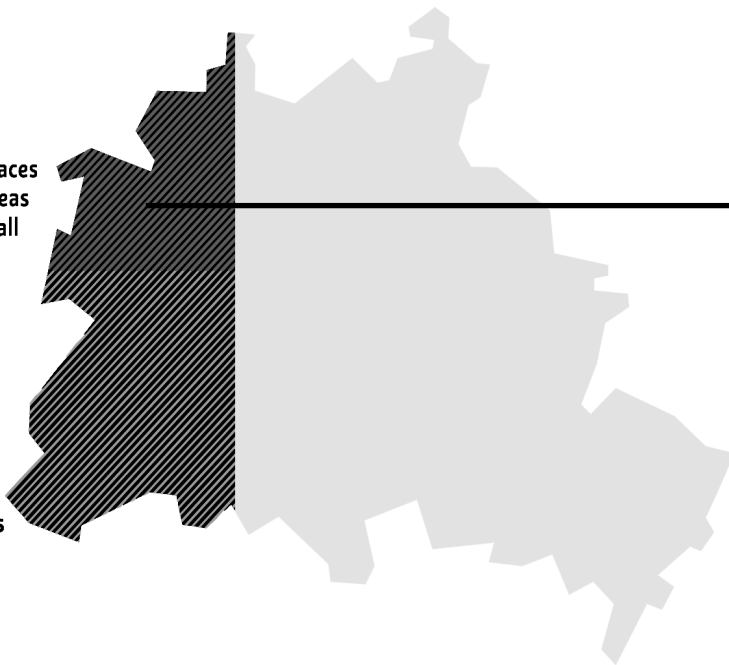

BERLIN

Berlin

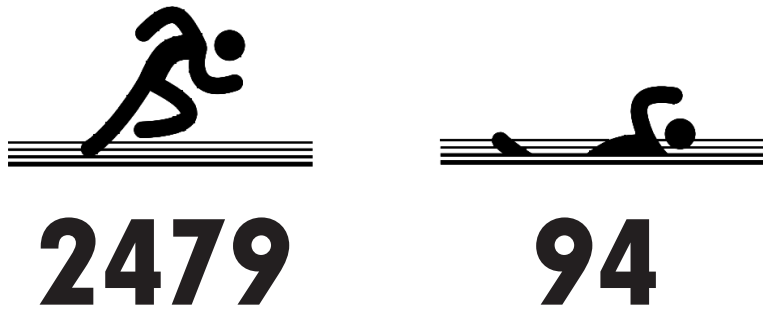

85% participate in sports

Rotterdam

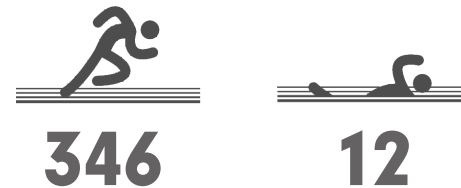

62 % participate in sports

London



61.5 % participate in sports

BERLIN

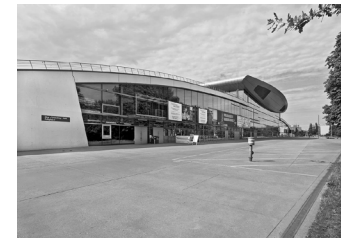
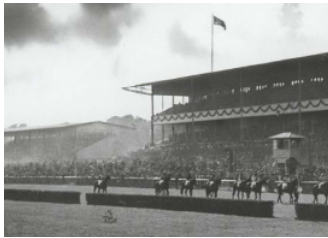
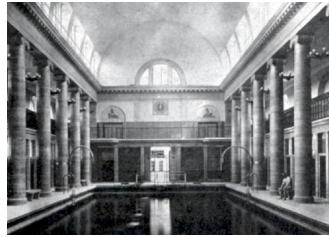

1868

1898

1936

1949

1992

1996

19th Century

Nazi Germany

Cold War

21st Century

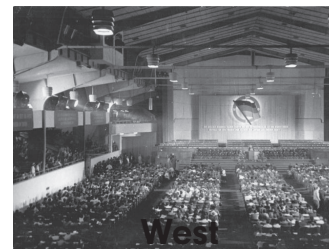



BERLIN

Population growth of 44.230 inhabitants

Municipality: There is a growing need for sport facilities.

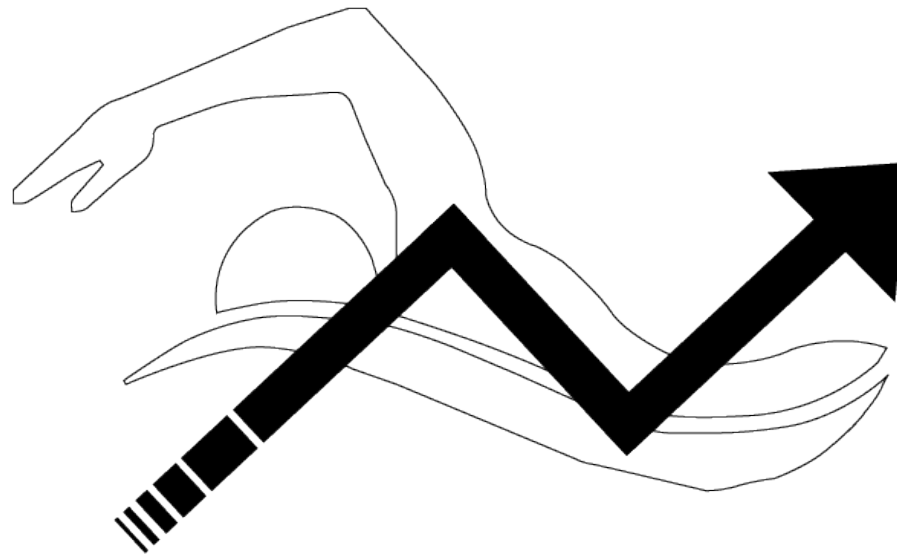

The **ambition** of the berlin Municipality is to continue to, and to **increase** the amount of future major national and international **sporting events** within the city of Berlin.

Therefore new sporting infrastructure should be developed for both **Top-Flight** and **Grass-roots use**.

BERLIN



HISTORY OLYMPICS



776 B.C.

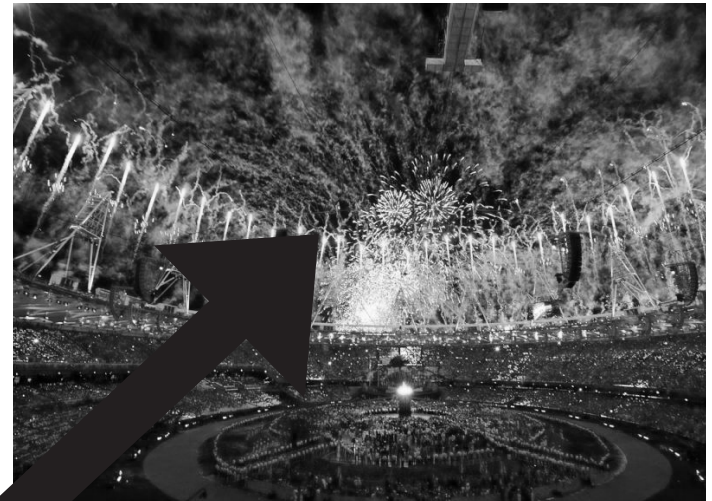

1896 A.C.



CURRENT OLYMPICS

14.6 BILLION EUROS

**OF THE 33 COMPETITION VENUES, 11 NEW VENUES WERE
CONSTRUCTED**

BIG URBAN REDEVELOPMENT PROJECTS WERE NEEDED

TOKYO 2020



CHALLENGES

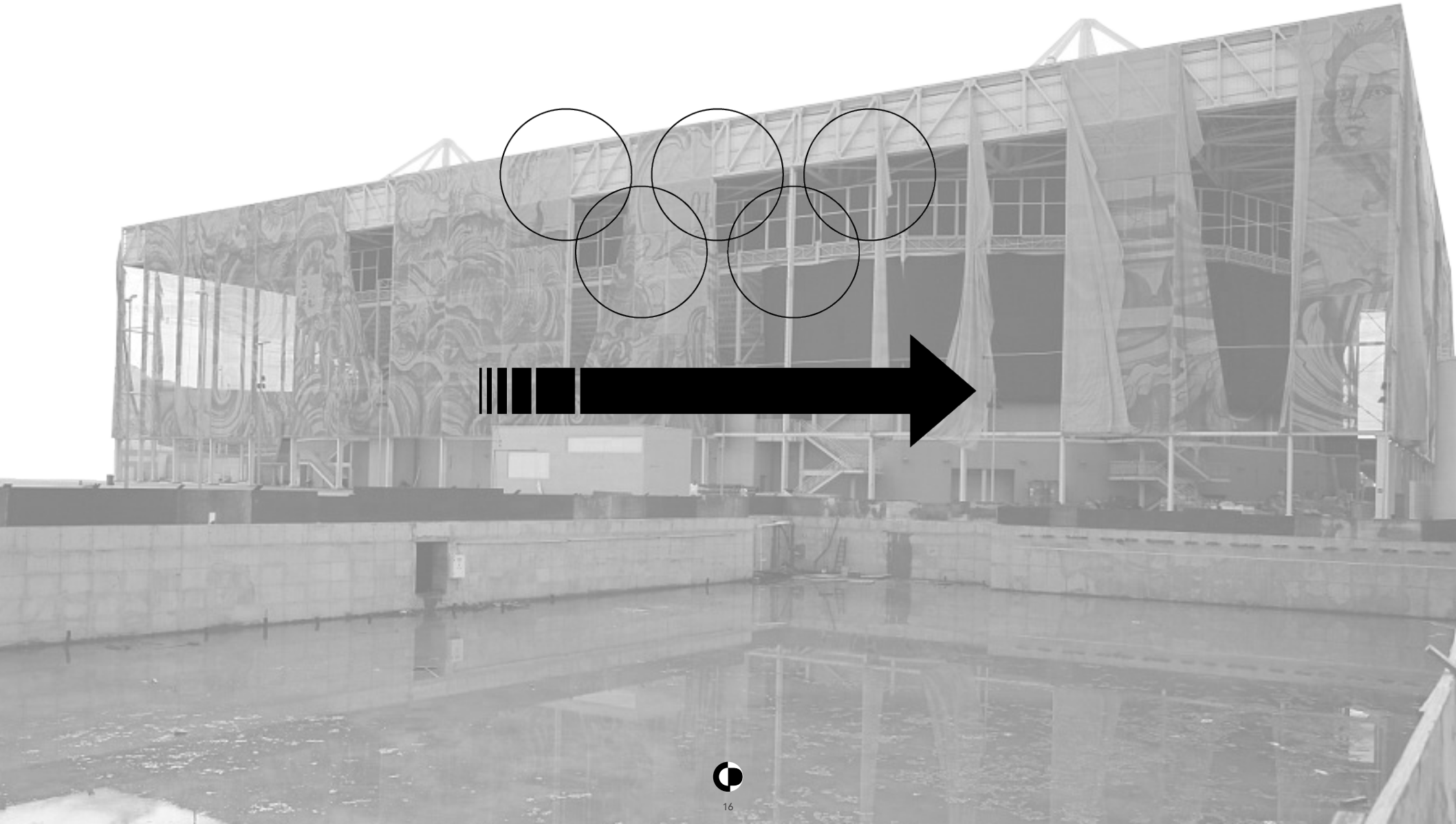

CHOSEN TYPOLOGY

OLYMPIC AQUATIC CENTER

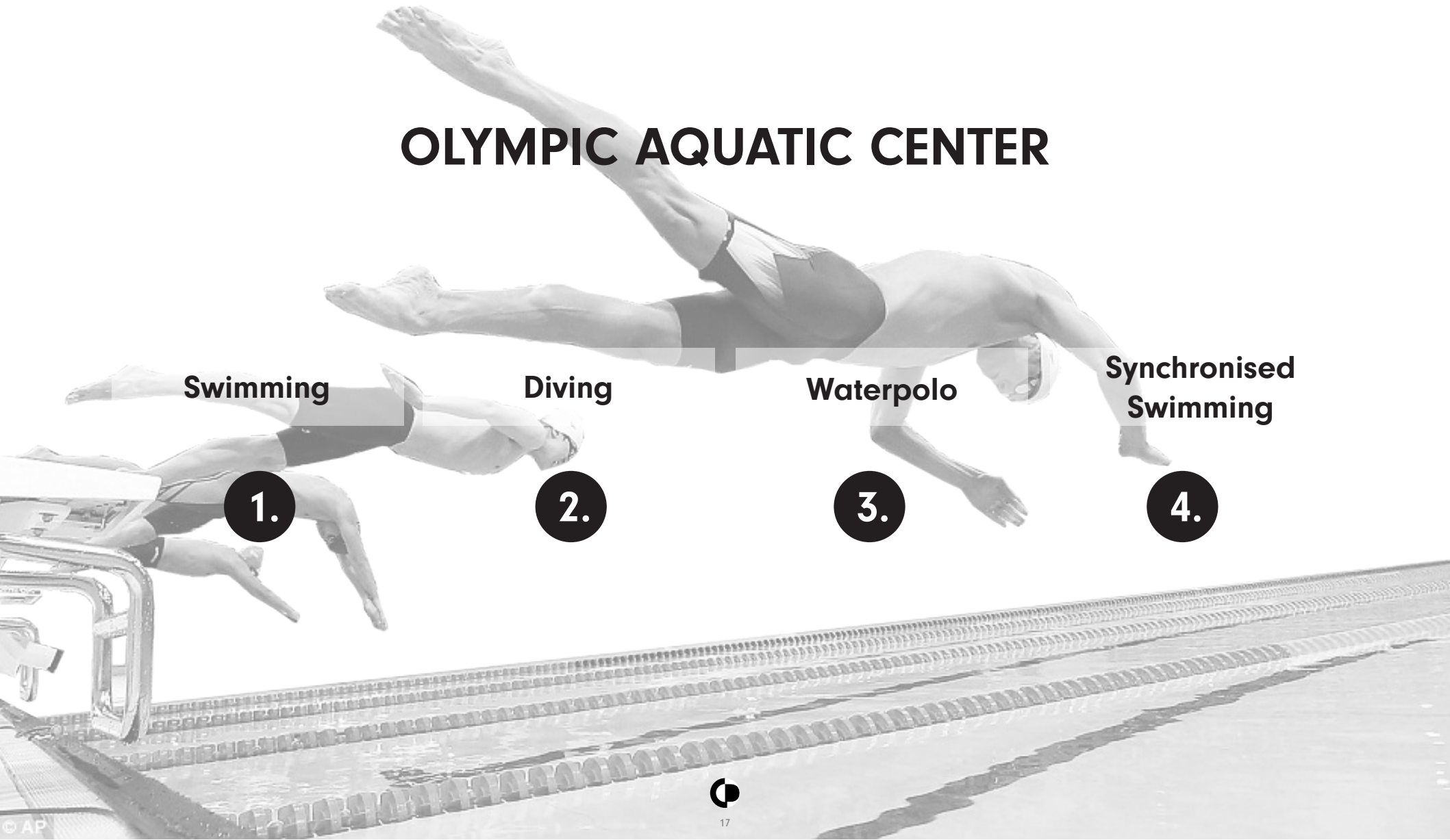

Swimming

1.

Diving

2.

Waterpolo

3.

Synchronised
Swimming

4.



SWIM CULTURE BERLIN

“It may be associated with music and fashion but Berlin is also a city that loves to swim.”

- The Guardian

“With 3,000 lakes and more than 30,000 km of rivers and other flowing streams, Berlin and the surrounding state of Brandenburg has the most inland bodies of water in Germany and, naturally, as many places to take a swim as there are grains of sand on a beach. , when the temperatures rise in the summers, what are often crystal clear waters beckon the city’s residents and visitors.

- Visit Berlin.de



SWIM CULTURE BERLIN

25 INDOOR POOLS

44 BEACHES

12710 METERS OF BEACHES



BERLIN BEACHES

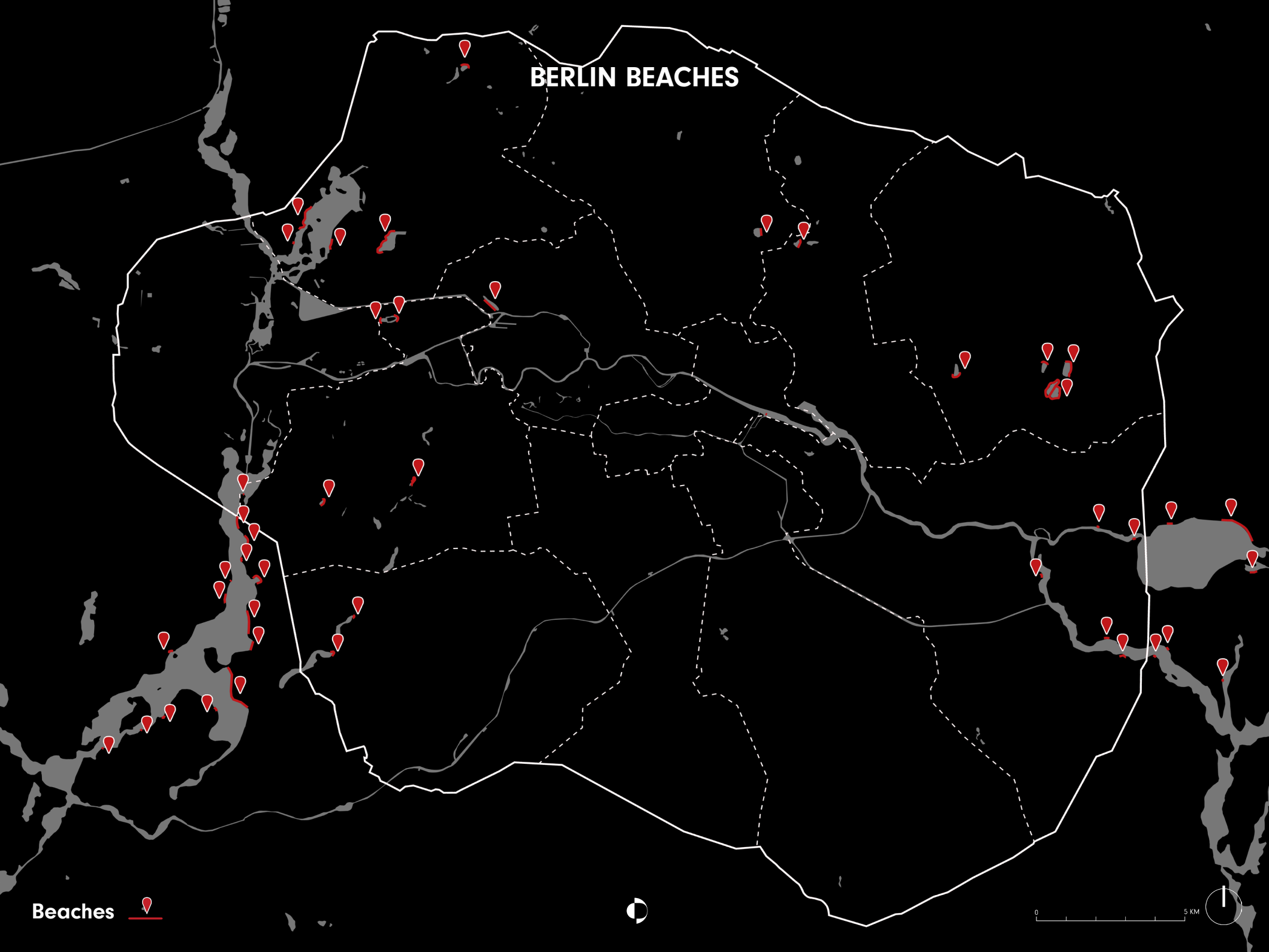

Beaches 



0 5 KM



DESIGN AMBITIONS

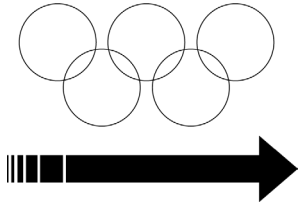

Because of the challenging nature of future proofing the legacy of Olympic facilities

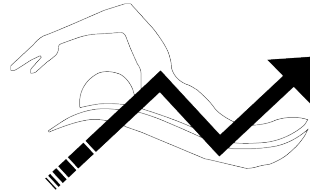

Because of the need by the municipality to develop more sports oriented urban developments



Because of Berlin's sport status both within Germany, Europe and the rest of the world.



The OAC should be a Catalyst of an **urban renewal project** of a neighbourhood

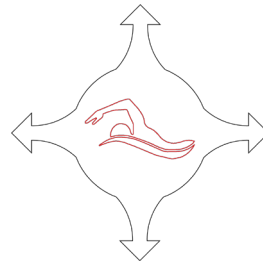

DESIGN FRAMEWORK



DESIGN OBJECTIVE

OLYMPICS





DESIGN OBJECTIVE

OLYMPICS

TOP PERFORMANCE



BERLIN



2479



94

85% participate in sports

DESIGN OBJECTIVE

OLYMPICS

TOP PERFORMANCE

DOWN PERFORMANCE



DESIGN OBJECTIVE

OLYMPICS

TOP PERFORMANCE

GRASSROOT FUNCTIONS



DESIGN OBJECTIVE

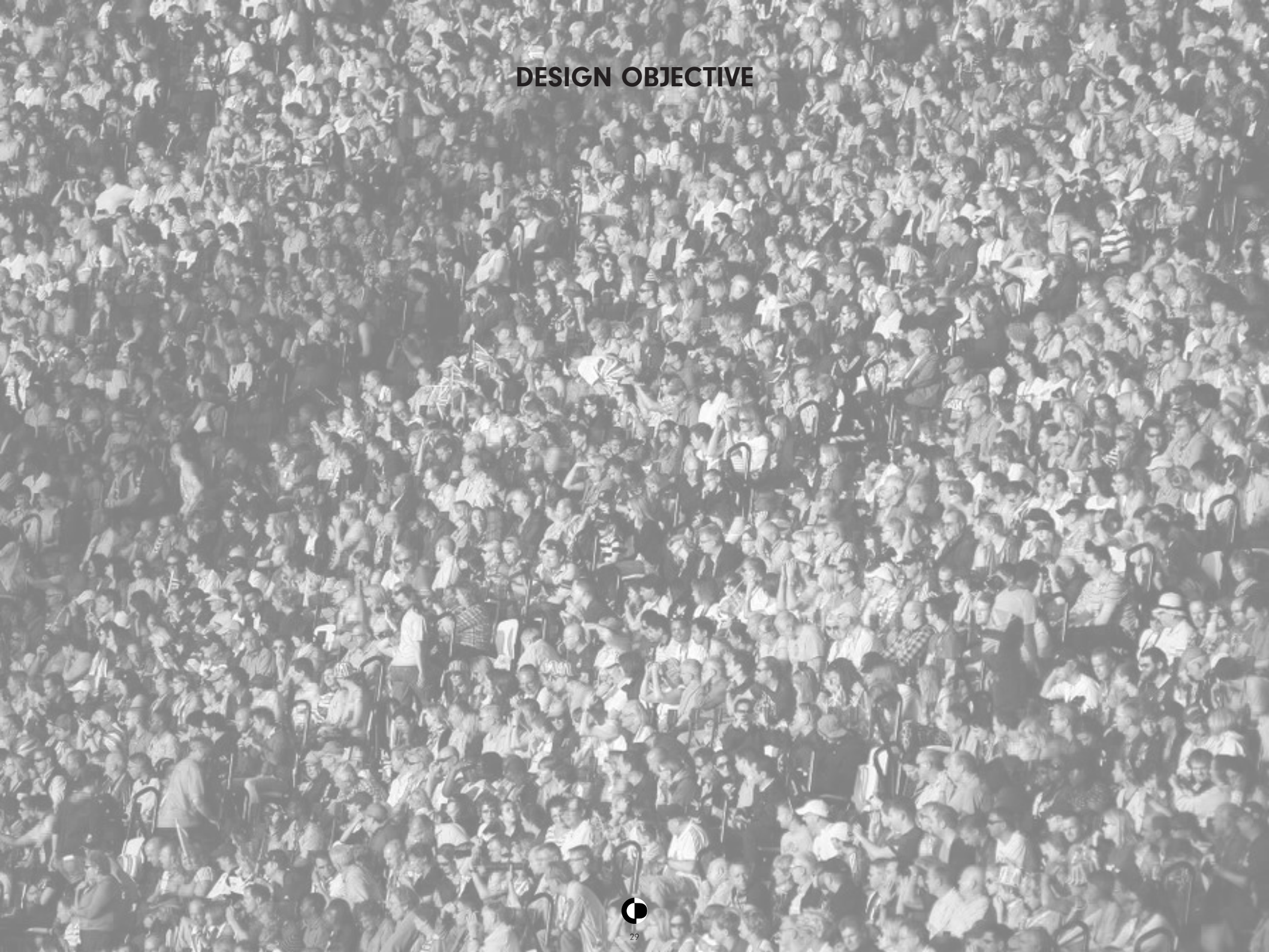

DESIGN OBJECTIVE

~~OLYMPICS~~

TOP PERFORMANCE

GRASSROOT FUNCTIONS



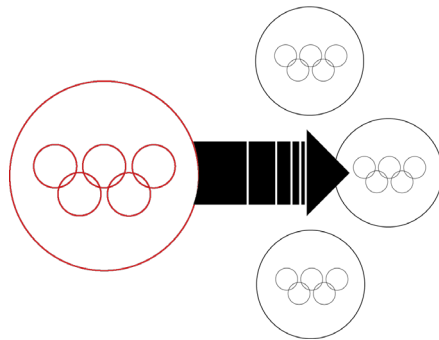

**In what way should the facility
form an example for future olympic
facilities?**

DESIGN AMBITIONS

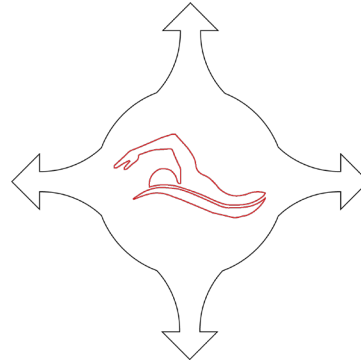

HOW COULD THE PROJECT BE A CATALYST OF URBAN RENEWAL PROJECT?

1

Solve urban complexities or challenges

2

Placed within an area of development

3

Introduce grass-root functions to support neighbourhood and city redevelopment



LOCATION OF THE DESIGN



CONTEXT

CONTEXT

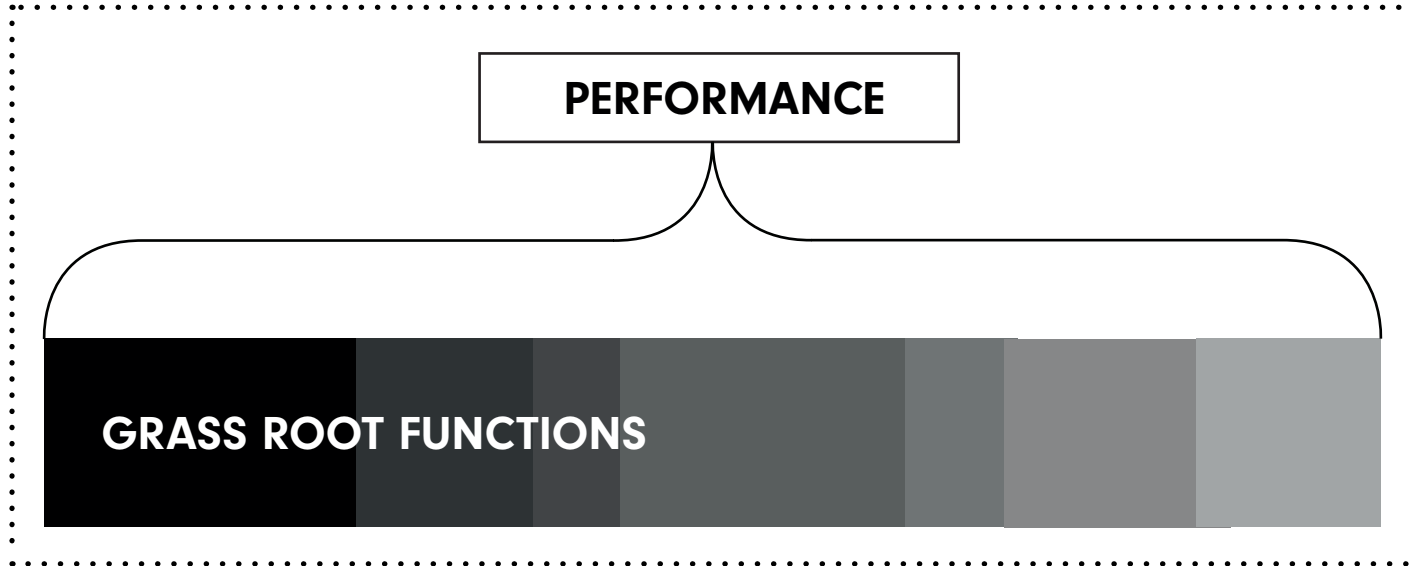

APPROACH

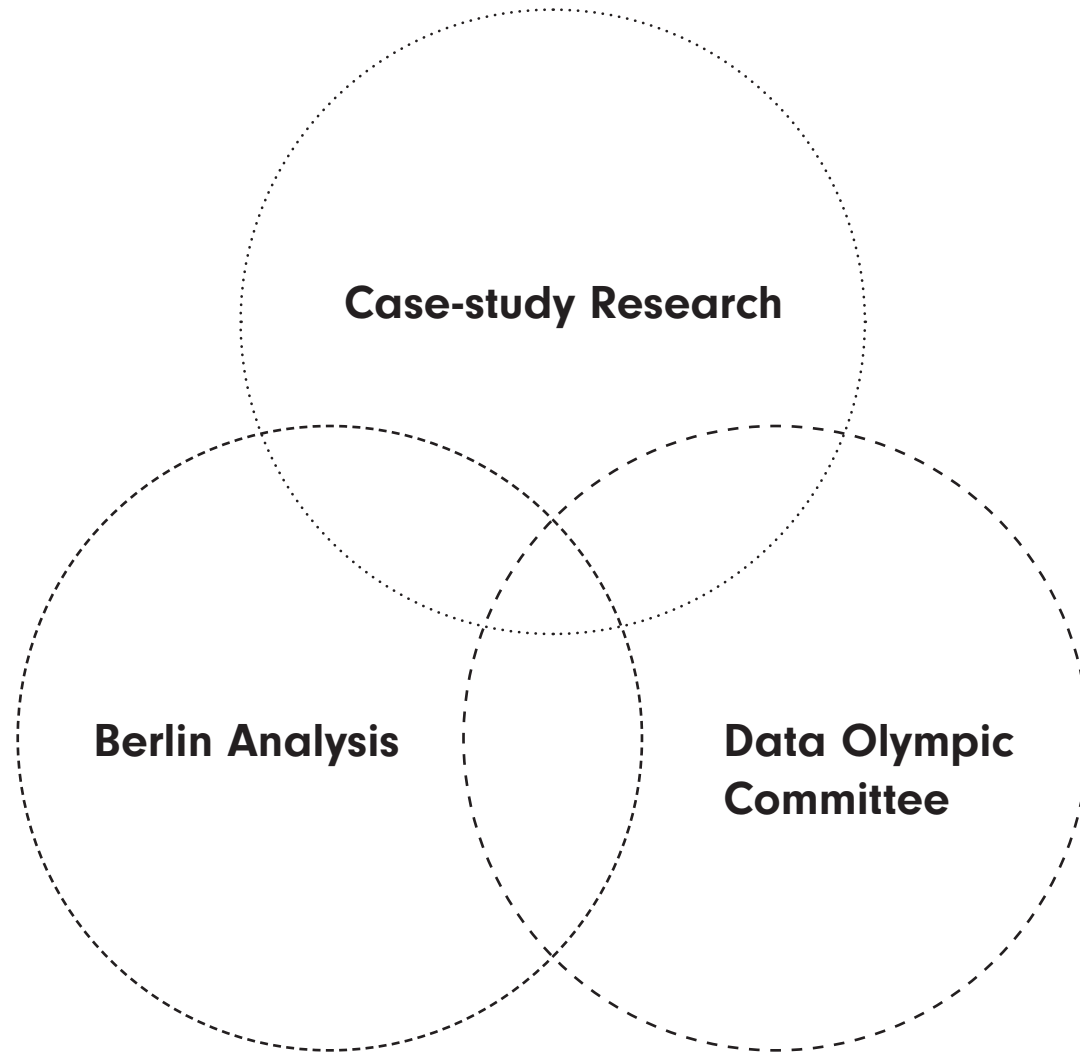

REQUIREMENTS URBAN CONTEXT

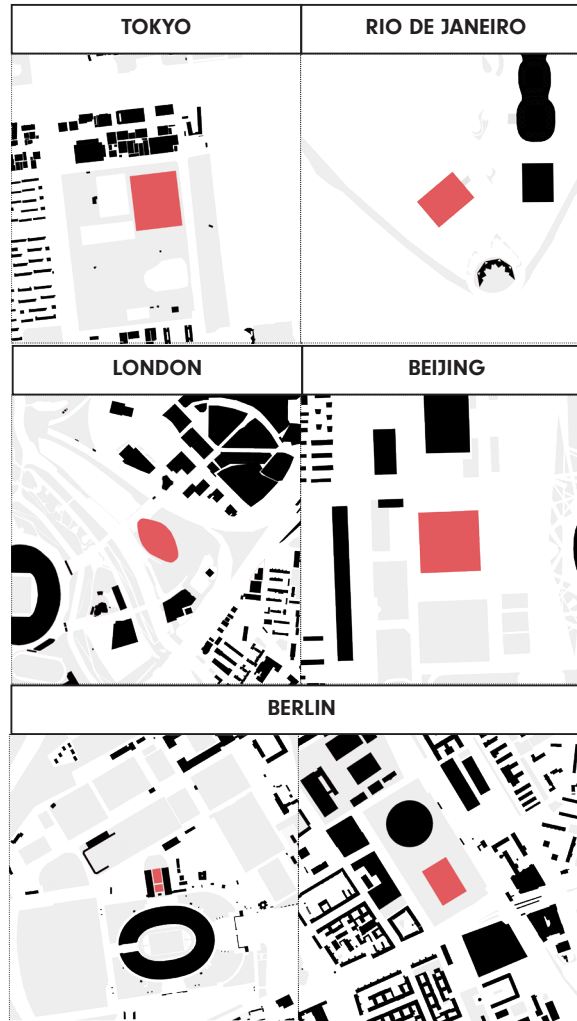

REQUIREMENTS URBAN CONTEXT



1

Placed within area which is being developed

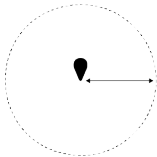

2

In the vicinity to the city centre

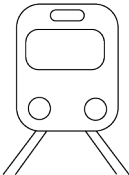

3

Close proximity to Public Transportation

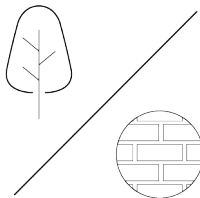

4

A combination of green and grey space

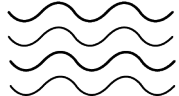

5

Near Water

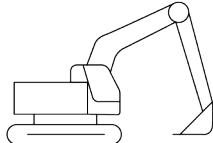

6

Low density area
Low amount of demolition needed

POTENTIAL REDEVELOPMENT AREAS



Transformation area
Stimulus
Centre-sustaining urban space
(Carried over from Urban Development
Plan for Centres 3)



POSSIBLE LOCATIONS

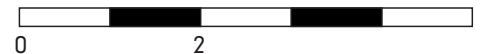
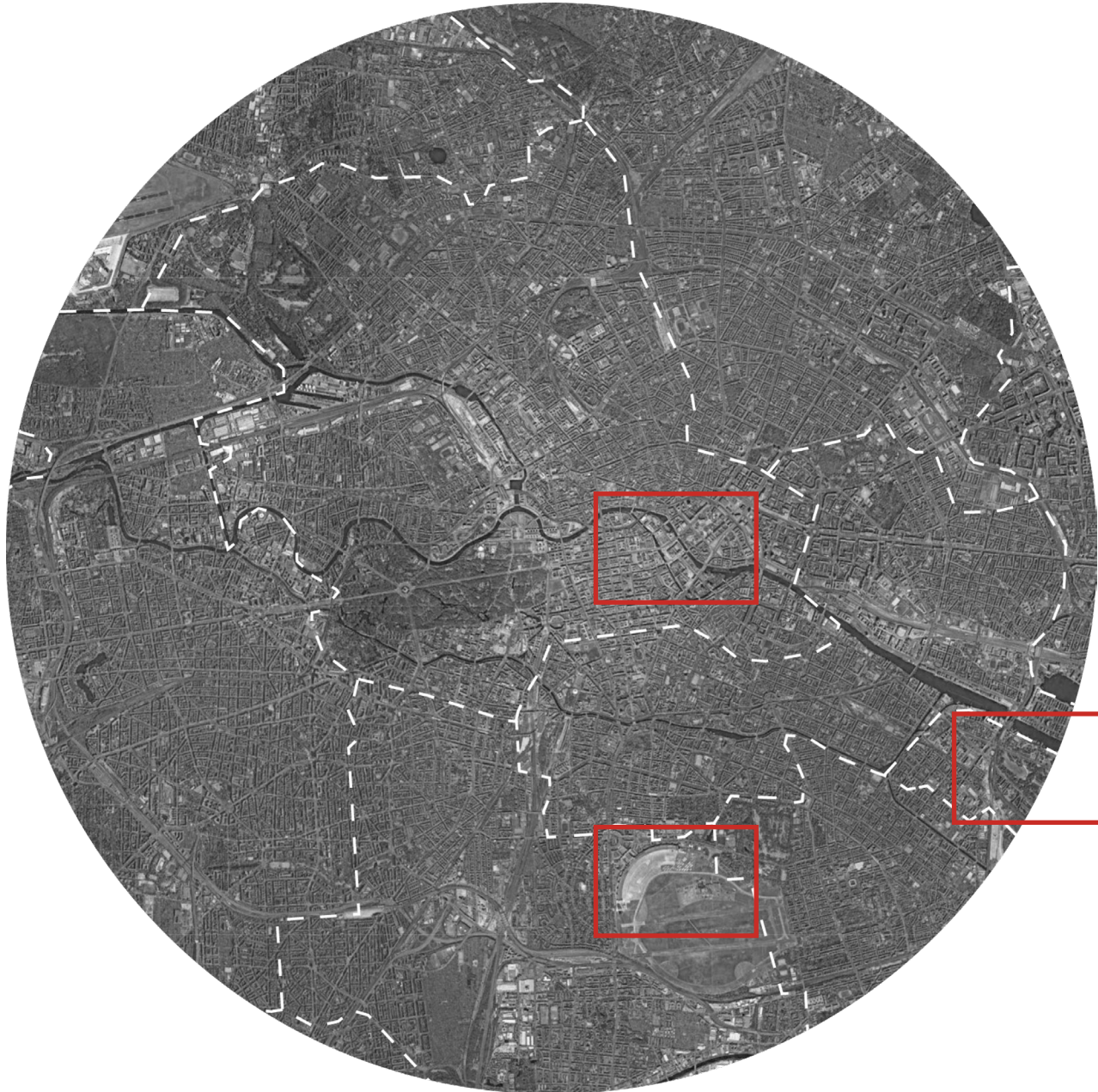

POSSIBLE LOCATIONS

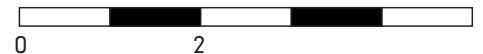
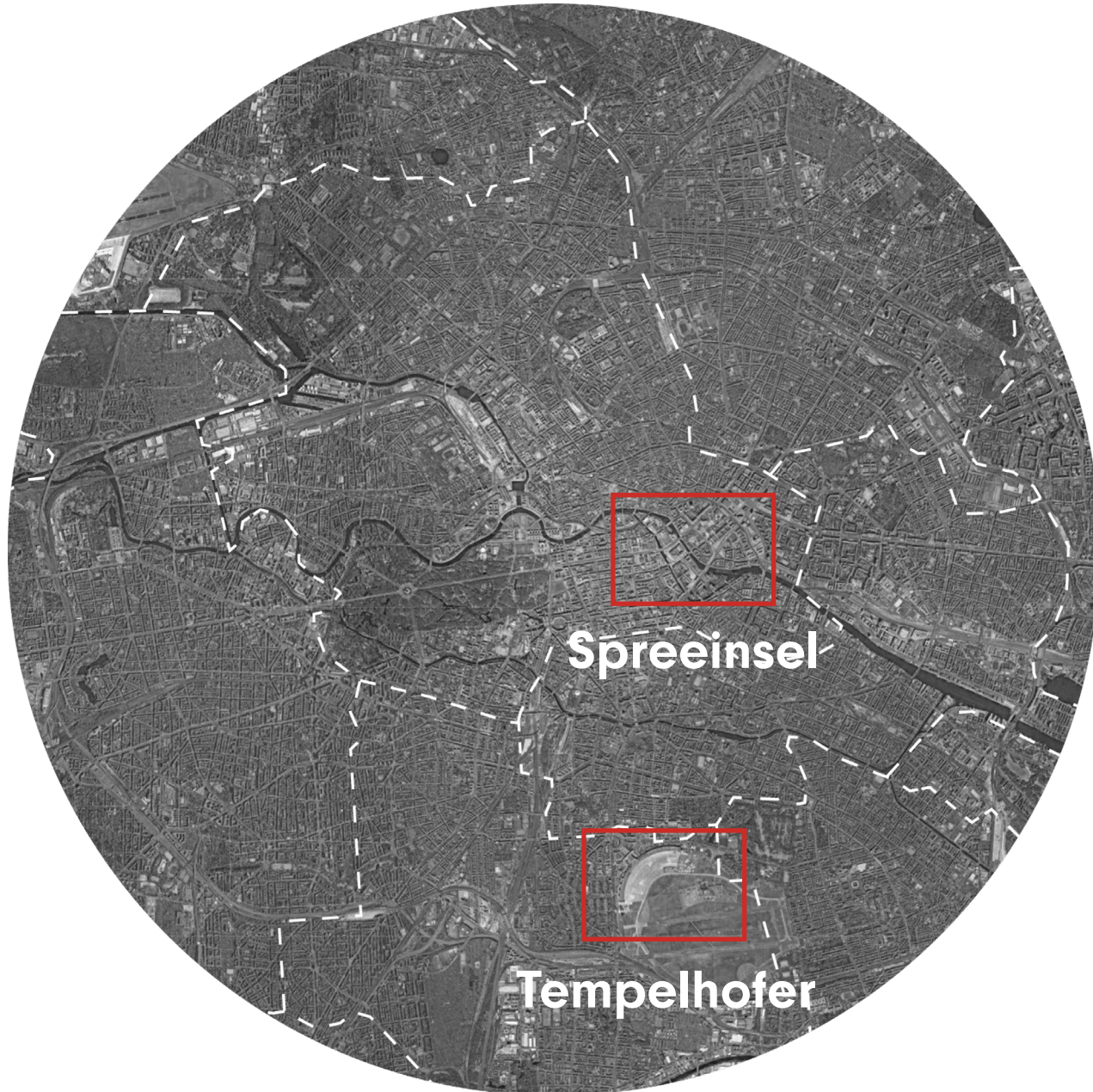

POSSIBLE LOCATIONS

Spreeinsel



Berliner Dom

Tempelhofer



Flughafen Berlin-Tempelhof



Neues Museum



Tempelhofer Feld

FINAL LOCATION

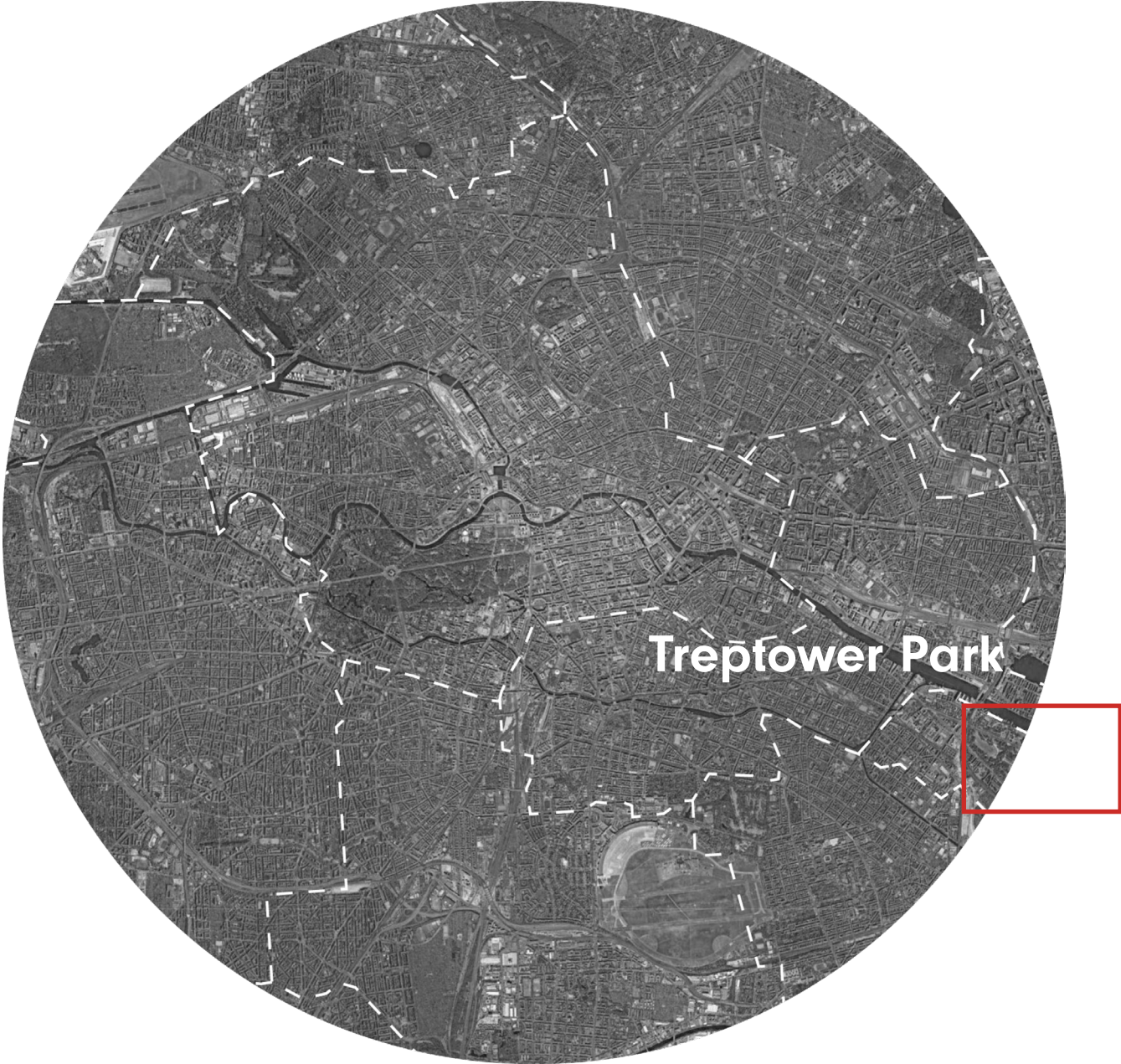

Treptower Park

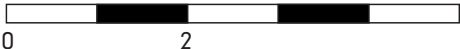

OPPORTUNITIES

Gate Towards the City

FUTURE DEVELOPMENT

B M

B

Public transportation Development Waterfront

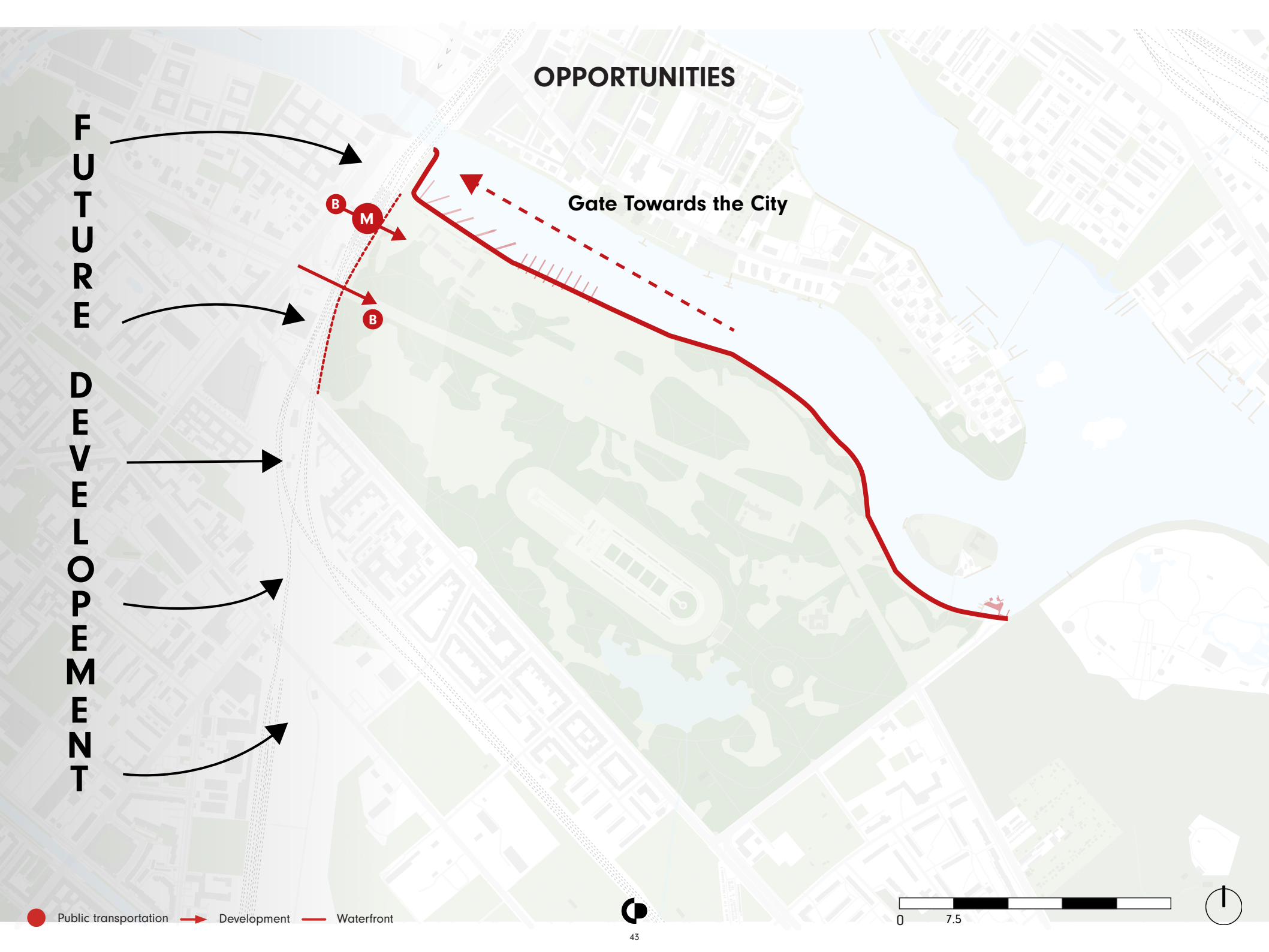

HISTORY

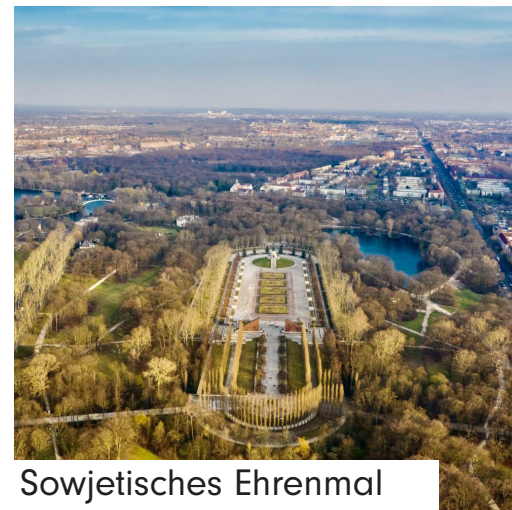
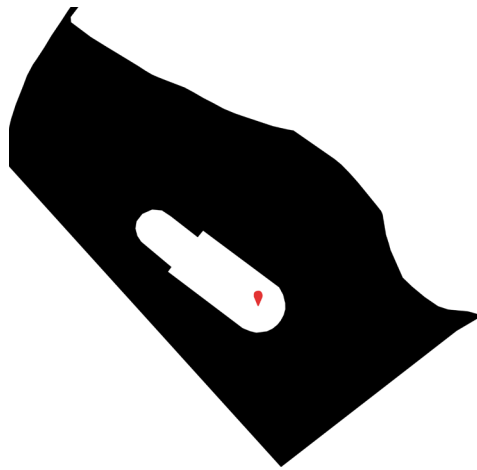

Sowjetisches Ehrenmal

4 DIFFERENT CHARACTERS

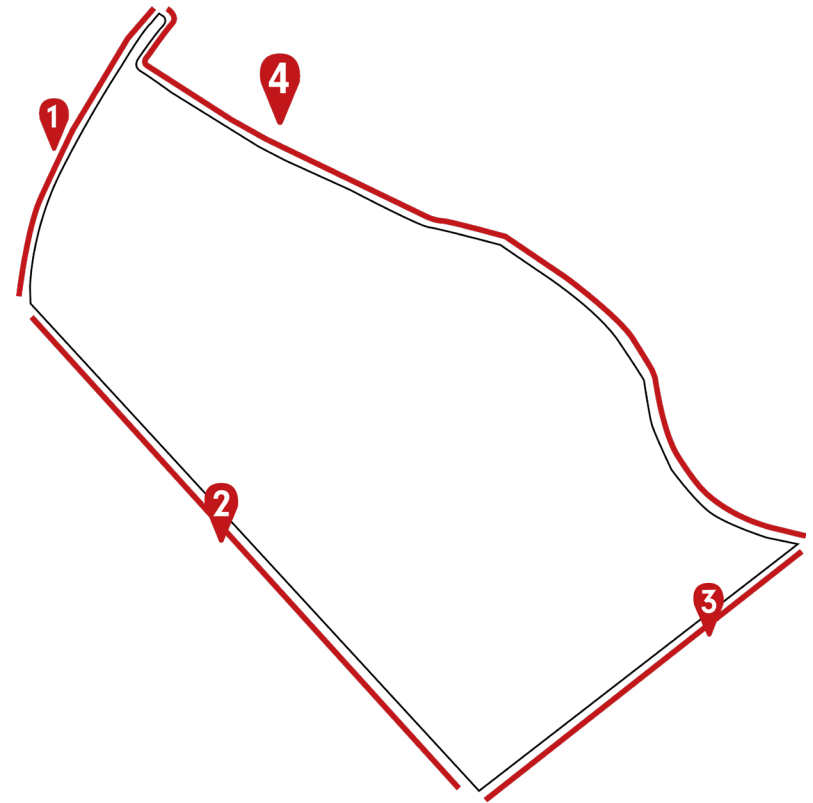

CHOSING A PLOT

Gate Towards the City

FUTURE DEVELOPEMENT

B M

B

-  High historic value
-  Public transportation
-  Development
-  Waterfront



CHOSEN PLOT

Gate Towards the City

F
U
T
U
R
E
D
E
V
E
L
O
P
M
E
N
T

B
M

B

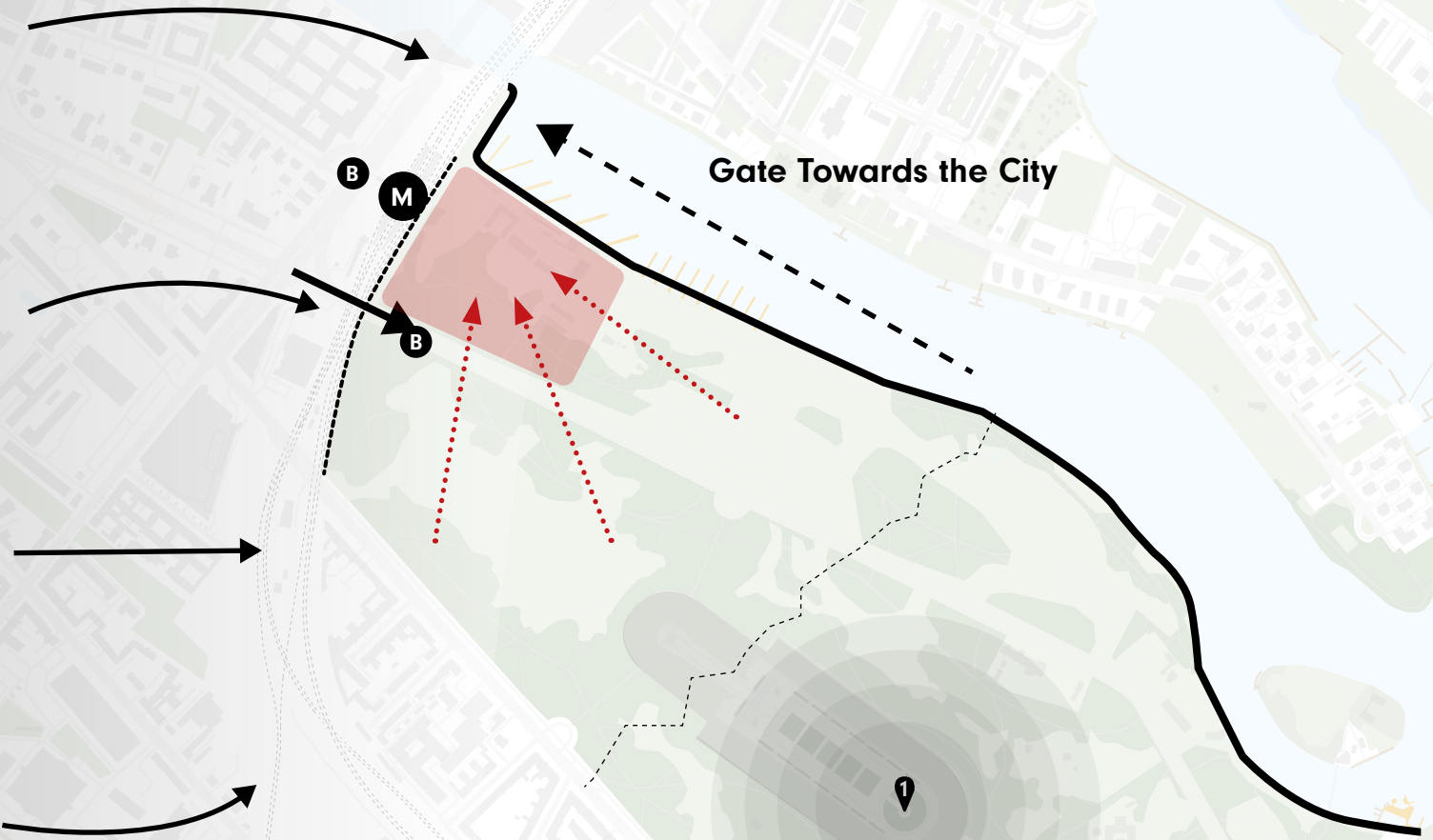

DIFFERENT CHARACTERS



CHOSEN PLOT

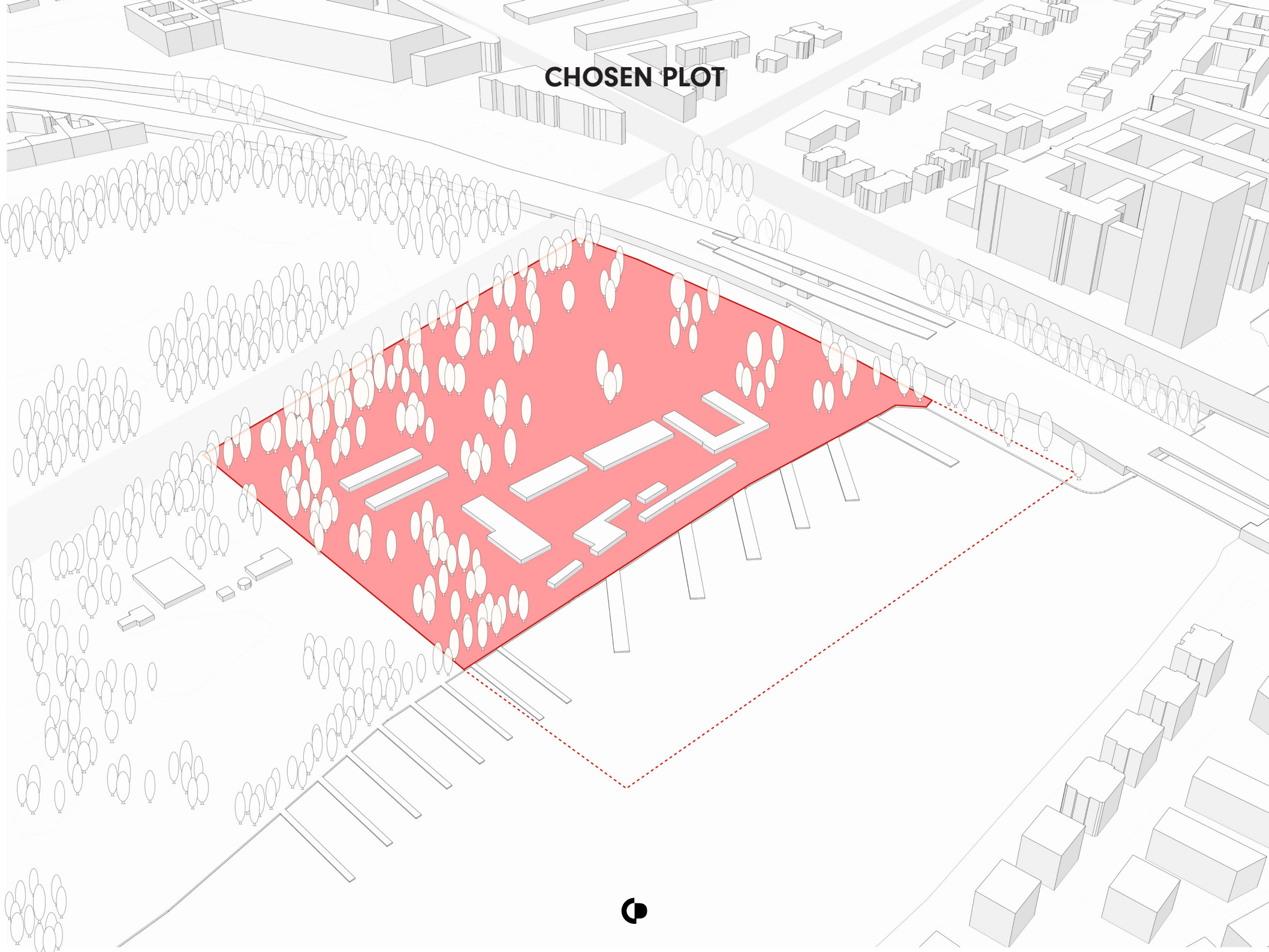

APPROACH

1

STIMULATE CONNECTION

2

**DON'T LIMIT EXISTING
QUALITIES**

3

**BUILD ON EXISTING
QUALITIES**



CONCEPT



TOP PERFORMANCE

GRASSROOT FUNCTIONS



ANALYSIS URBAN REQUIREMENTS

Tokyo



Urban Development plan:

"Create a sports centred area to support the city"

Rio de Janiero

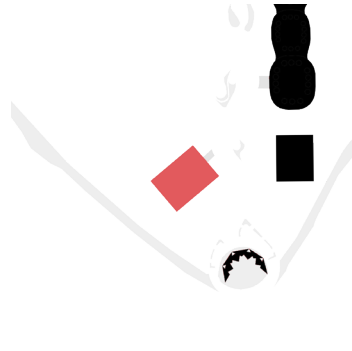

Urban Development Plan:

"New area for people. However failed because the park does not offer the requirements to attract people."

London

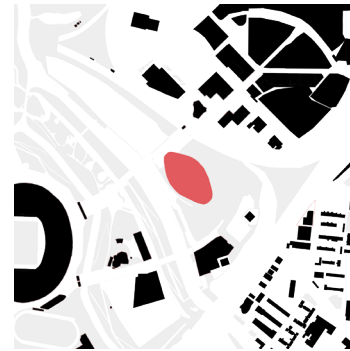

Urban Development Plan:

"Create new Urban Redevelopment, including new sports facilities as well as educational facilities"

Beijing



Urban Development Plan:

"Create New Urban redevelopment where recreation is at the centre. The recreational pool and the park attract people."

Berlin



Urban Development Plan:

"The site is designed to solve conjunction problems. The plan itself was supposed to disappear from view, and provide a landscape."

CONTEXT

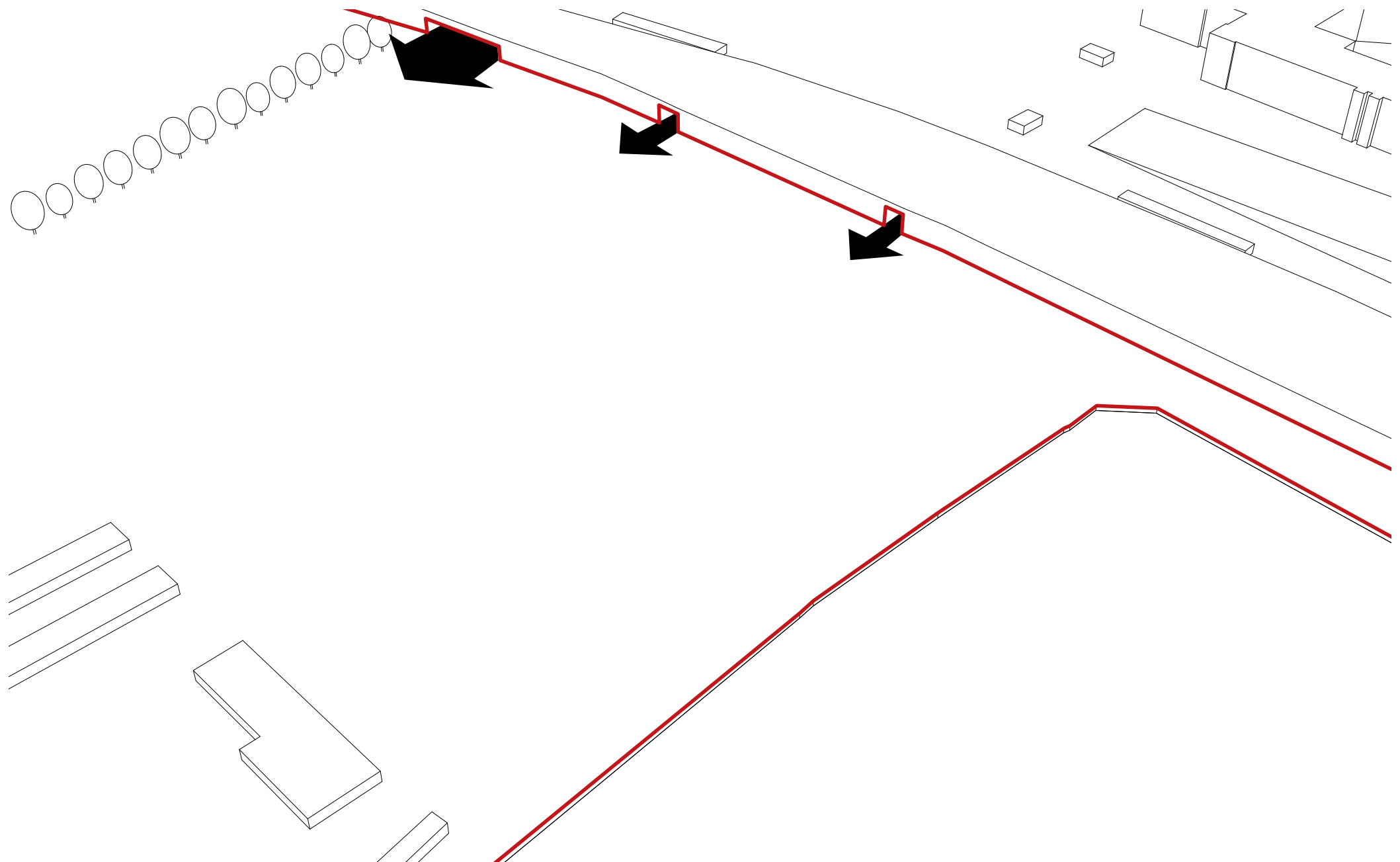

CONTEXT

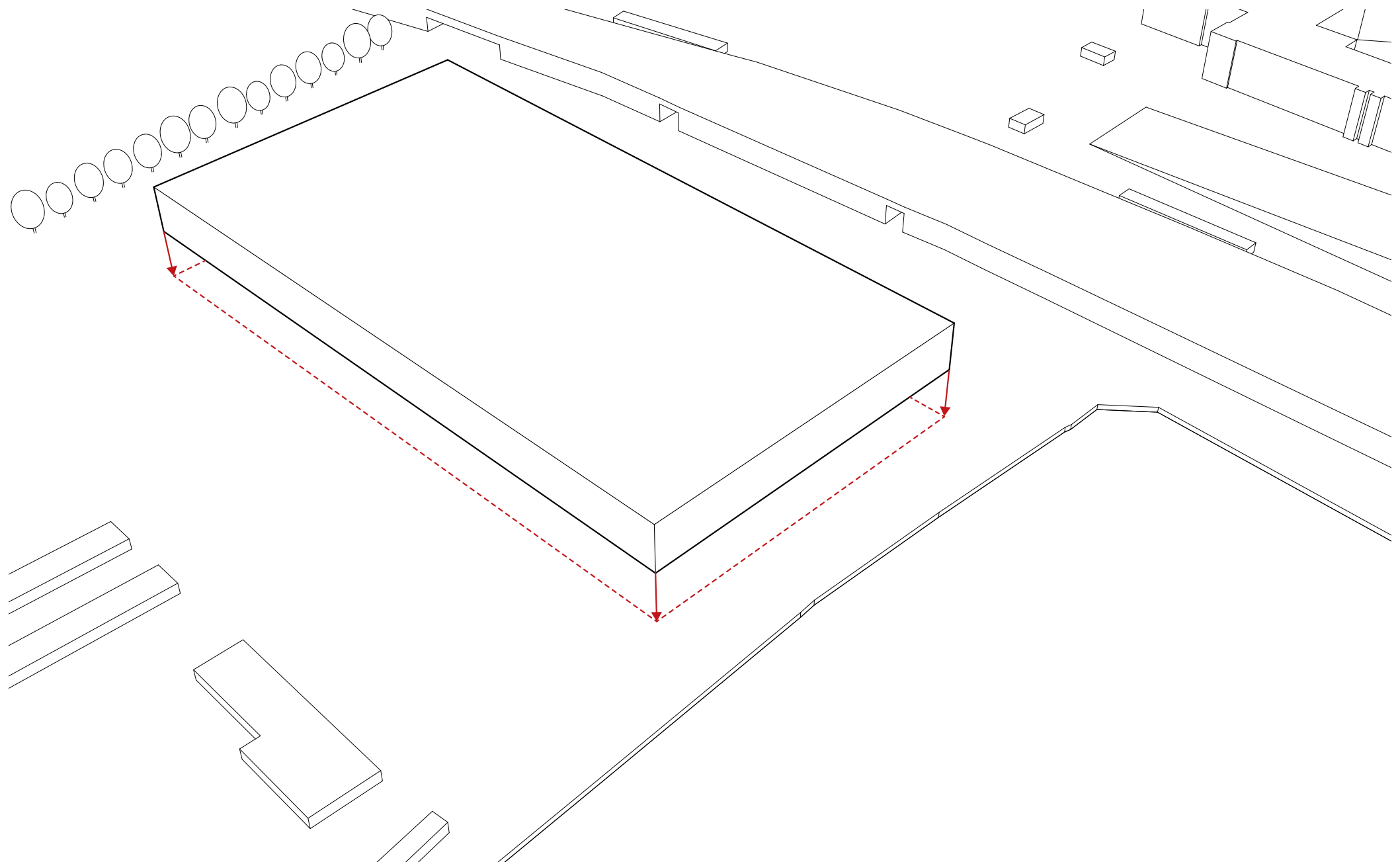

CONTEXT STUDY

CONDENSED

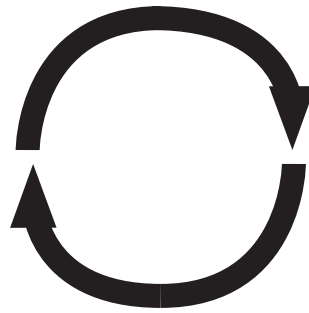

FRACTURED



VOLUMES

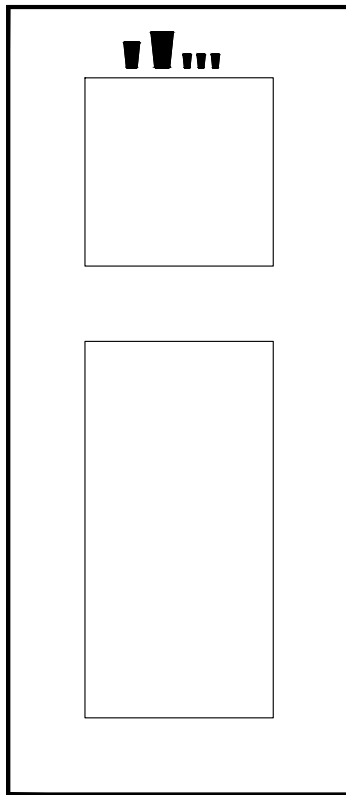

MAIN POOL

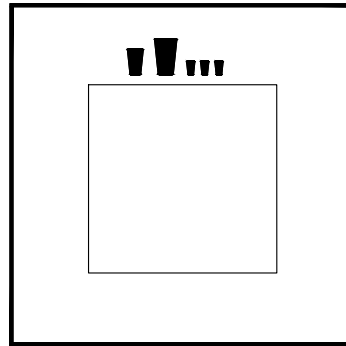

OLYMPIC DIVING POOL

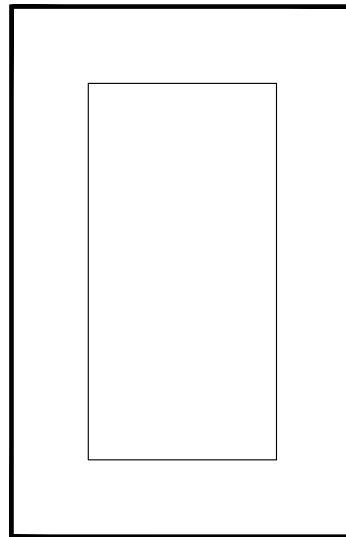

OLYMPIC SWIMMING POOL

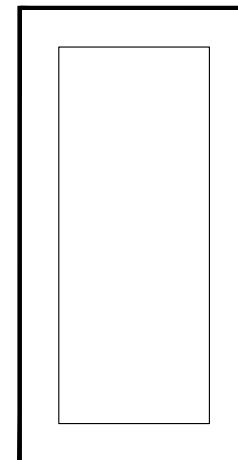

WARM UP POOL

VOLUME STUDY

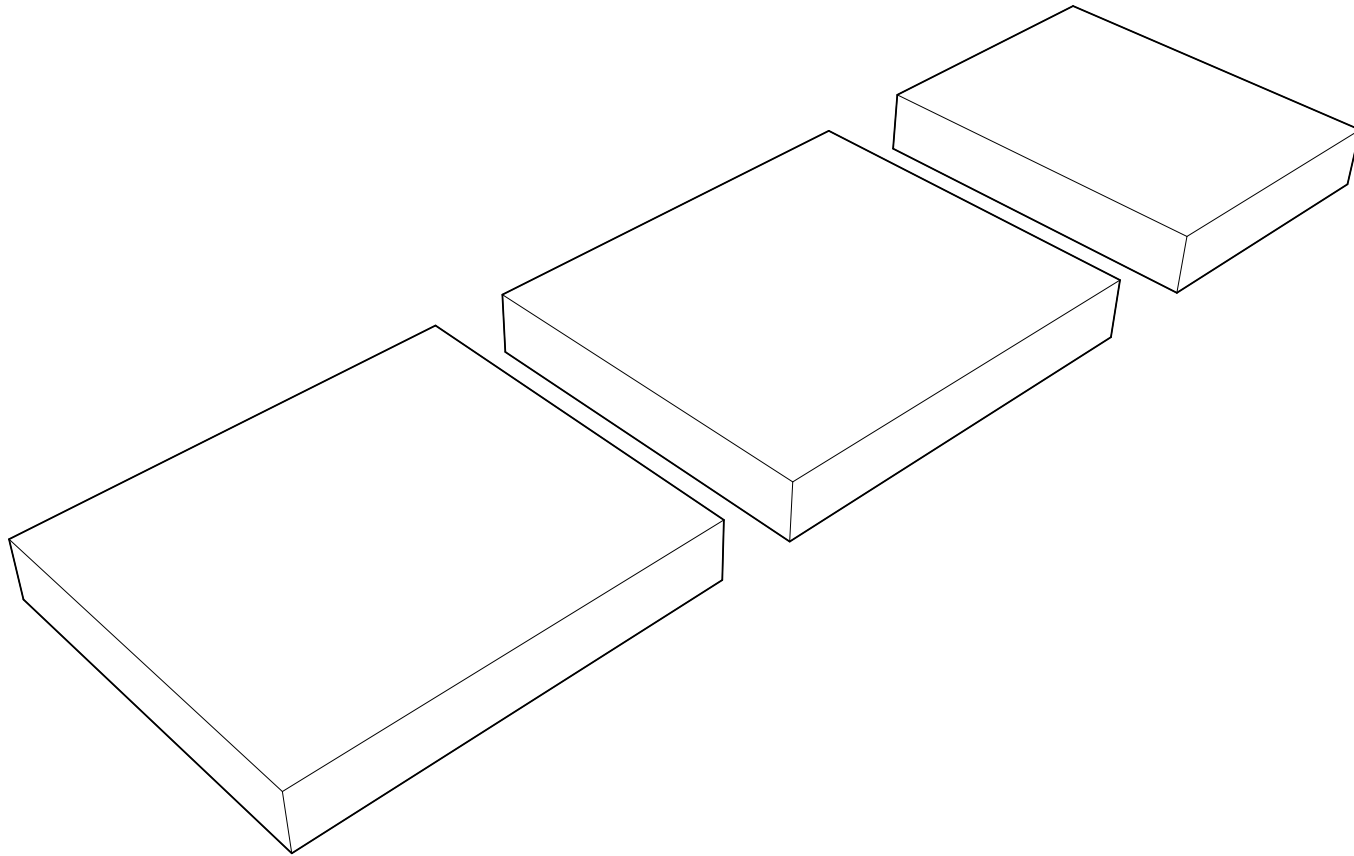

VOLUME STUDY

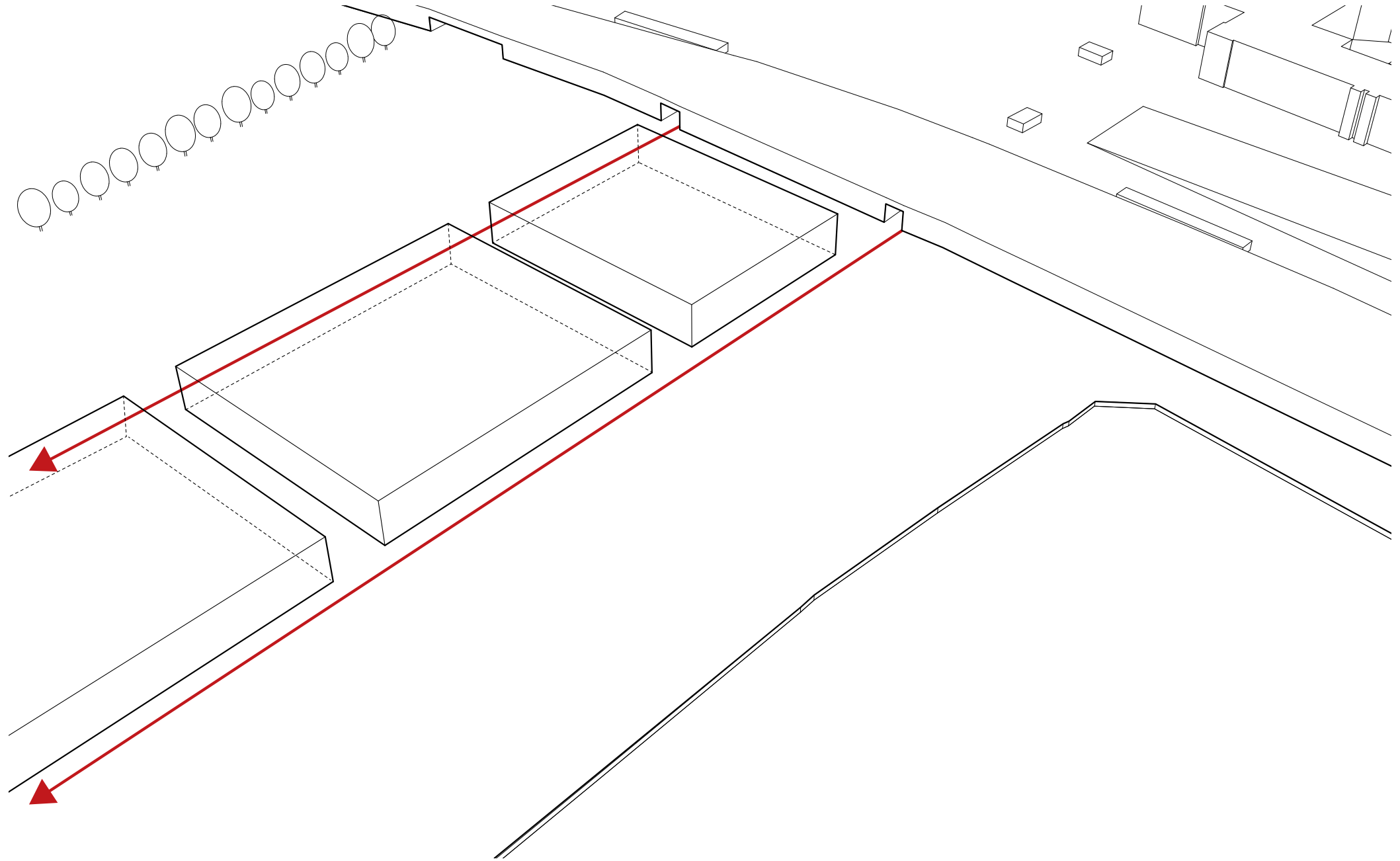

F
U
T
U
R
E
D
E
V
E
L
O
P
M
E
N
T

SITE

Gate Towards the City

B M

B

- High historic value
- Public transportation
- Chosen Location
- Development
- Waterfront



VOLUME STUDY

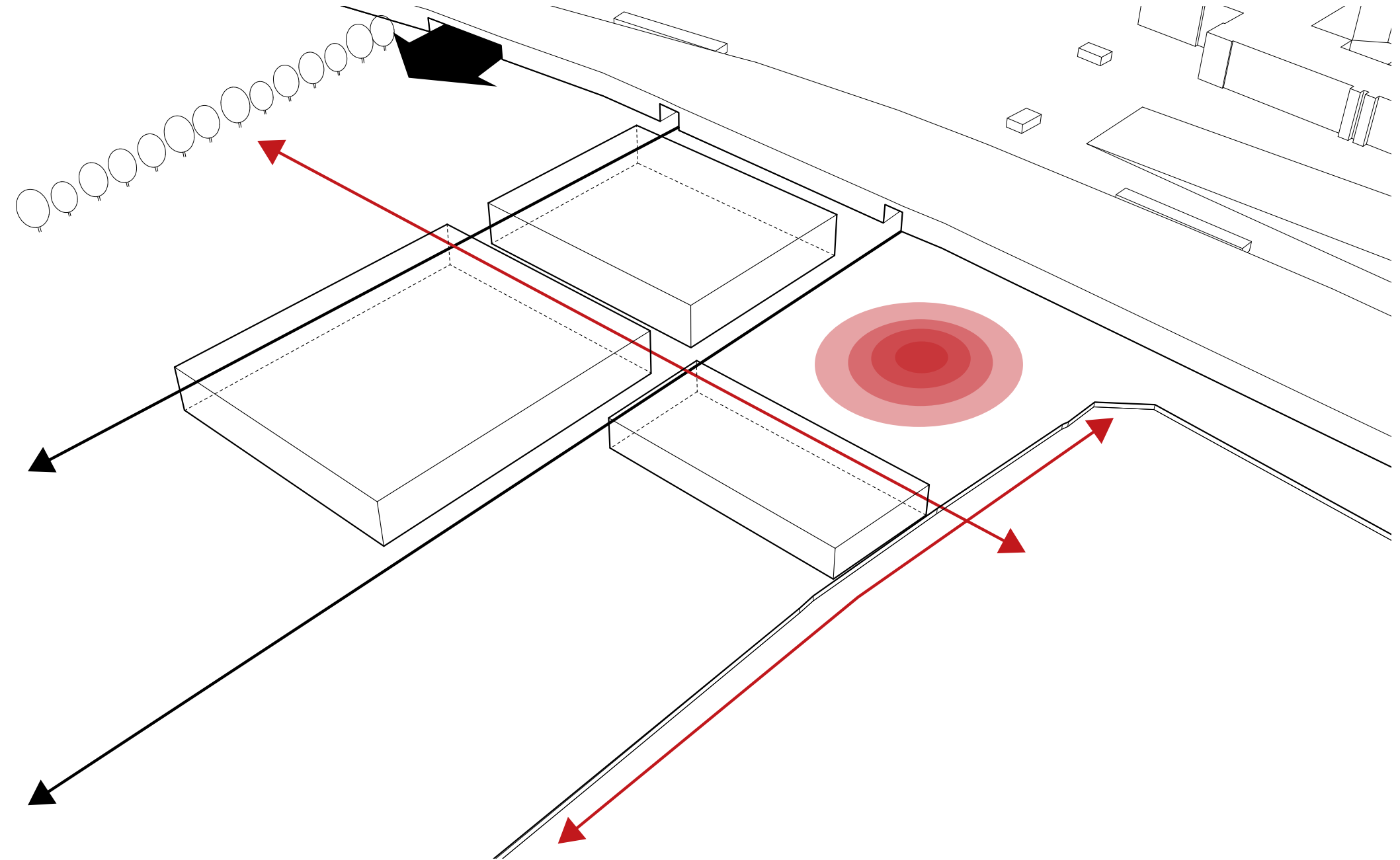

CONTEXT



GRASS-ROOT FUNCTIONS

PUBLIC SQUARE



THE PARK



TRANSPORTATION

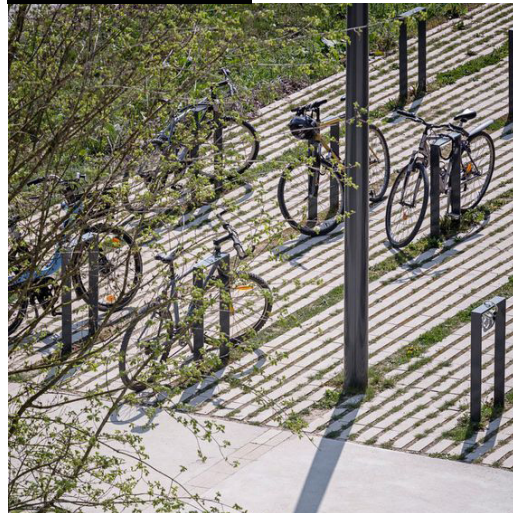

OUTDOOR SWIMMINGPOOL

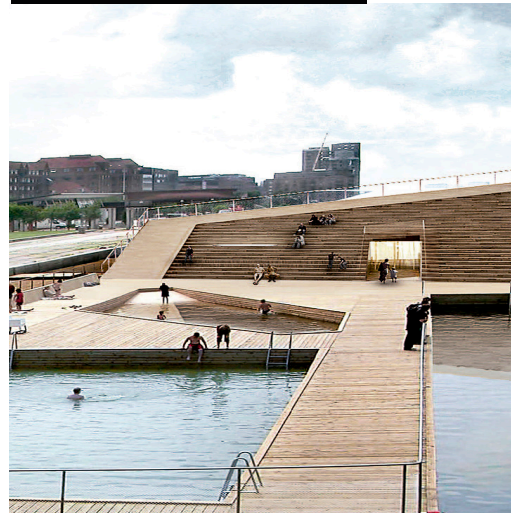

CONTEXT

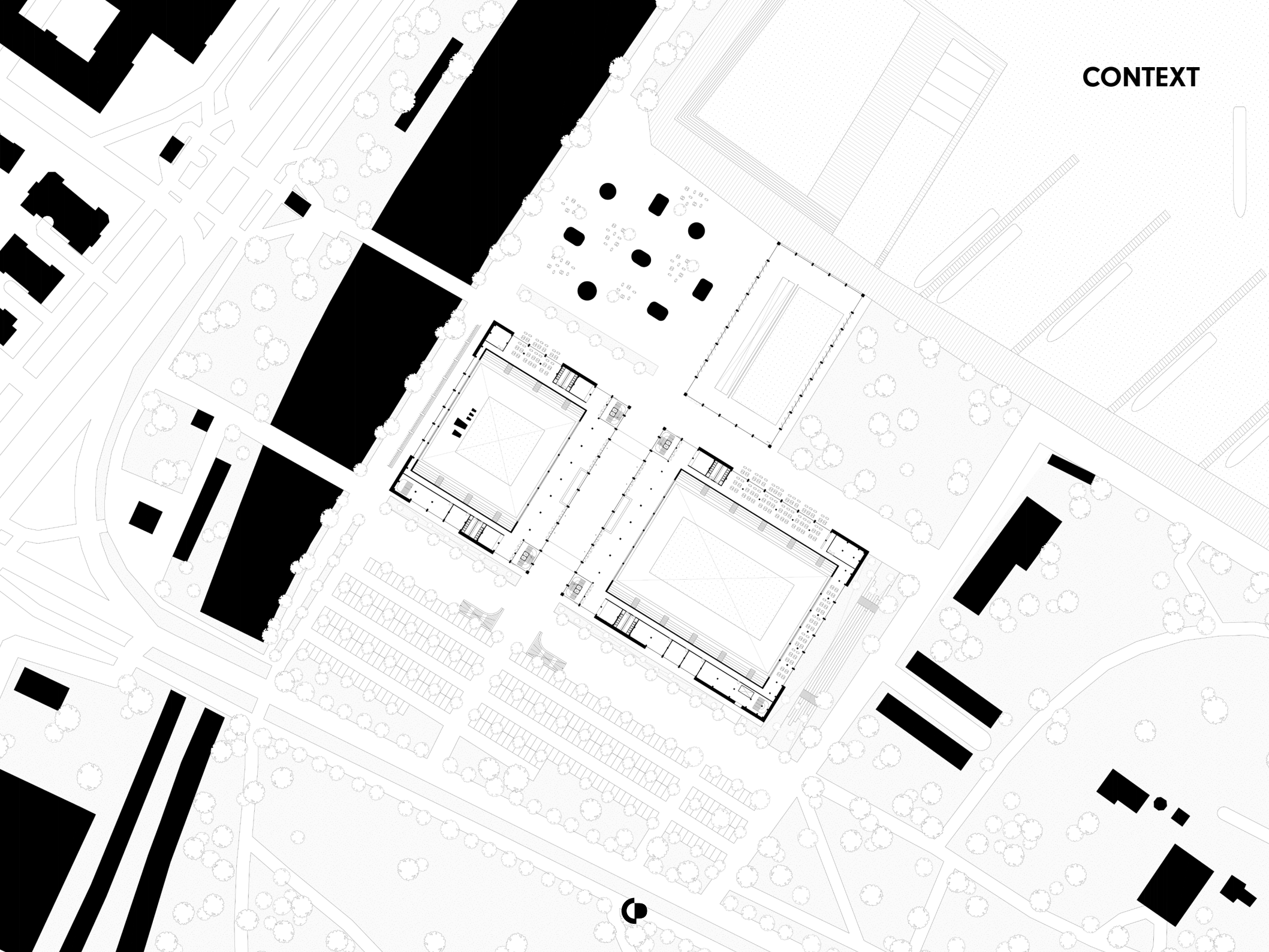

CONTEXT

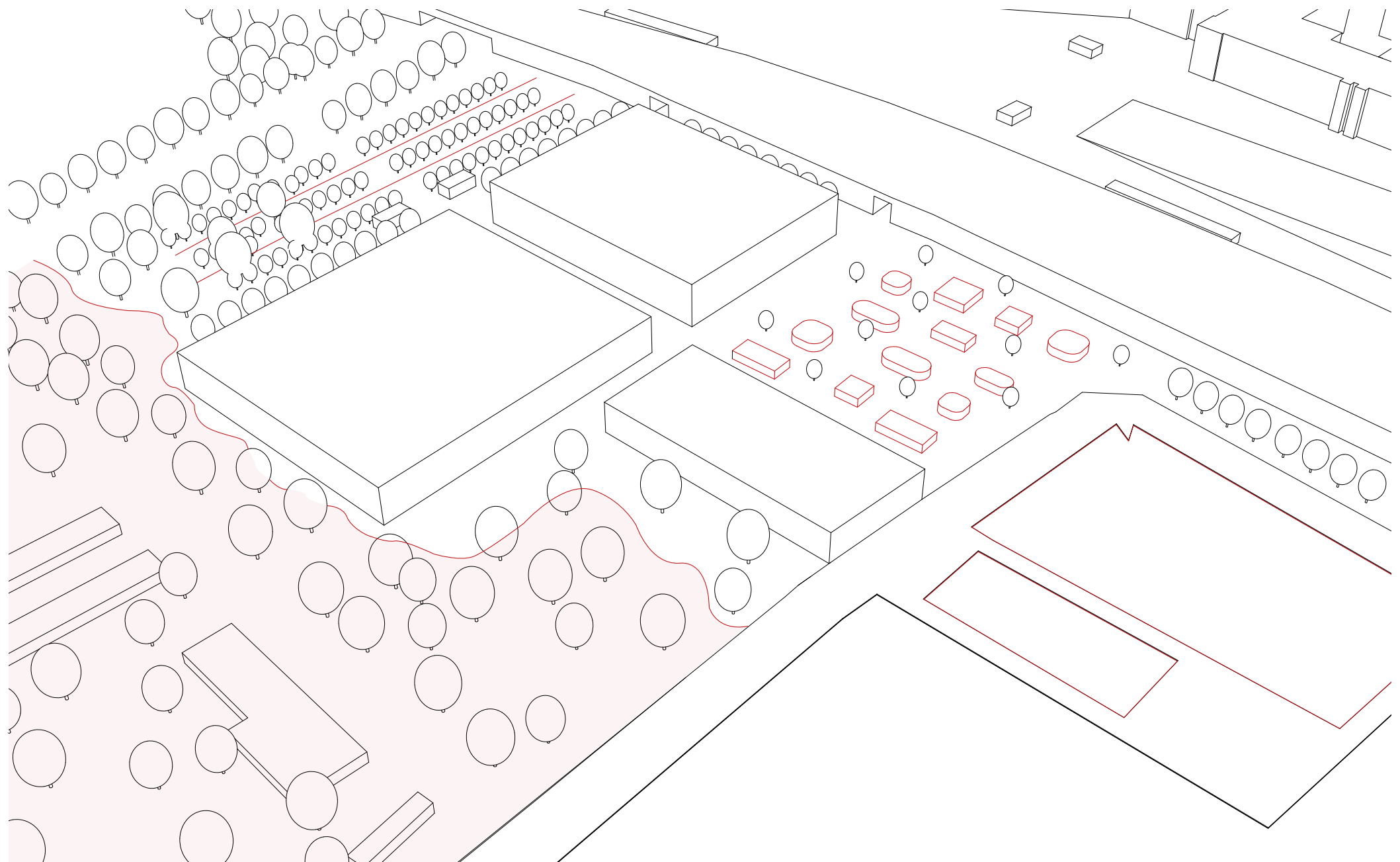

THE DESIGN



PERFORMANCE

GRASS ROOT FUNCTIONS



ATHLETES

VISITORS



ANCHORS: USERS



ATHLETES



VISITORS



LOGISTICS

ATHLETES

VISITORS



DESIGN REQUIREMENTS: ATHLETES

SPORT FACILITIES



DOPING CONTROL



PRESS OPERATIONS

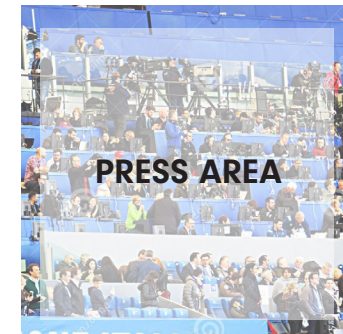
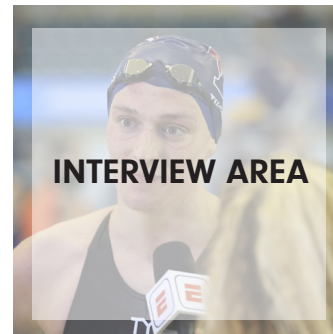

CEREMONIES

ATHLETES

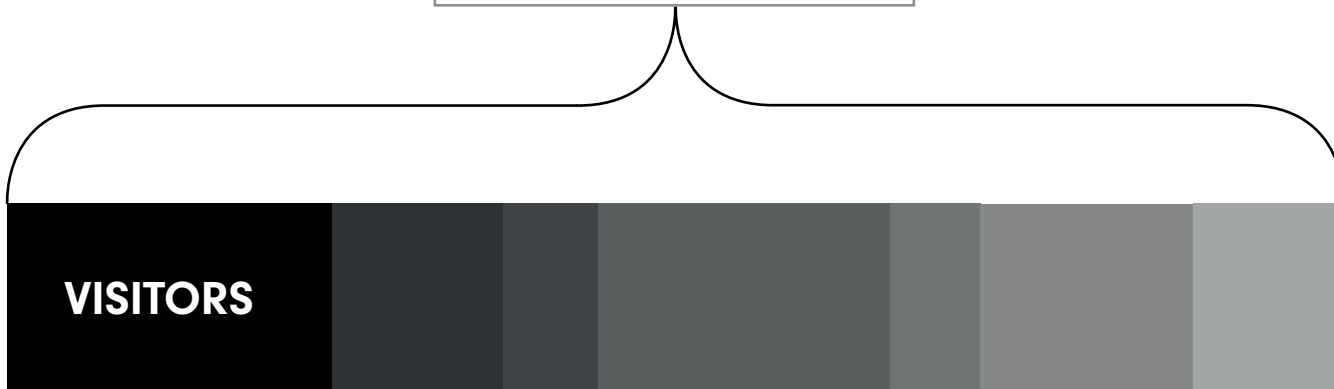

DESIGN REQUIREMENTS: ATHLETES

EVENT SERVICES



STANDS



MEDICAL

LOGISTICS

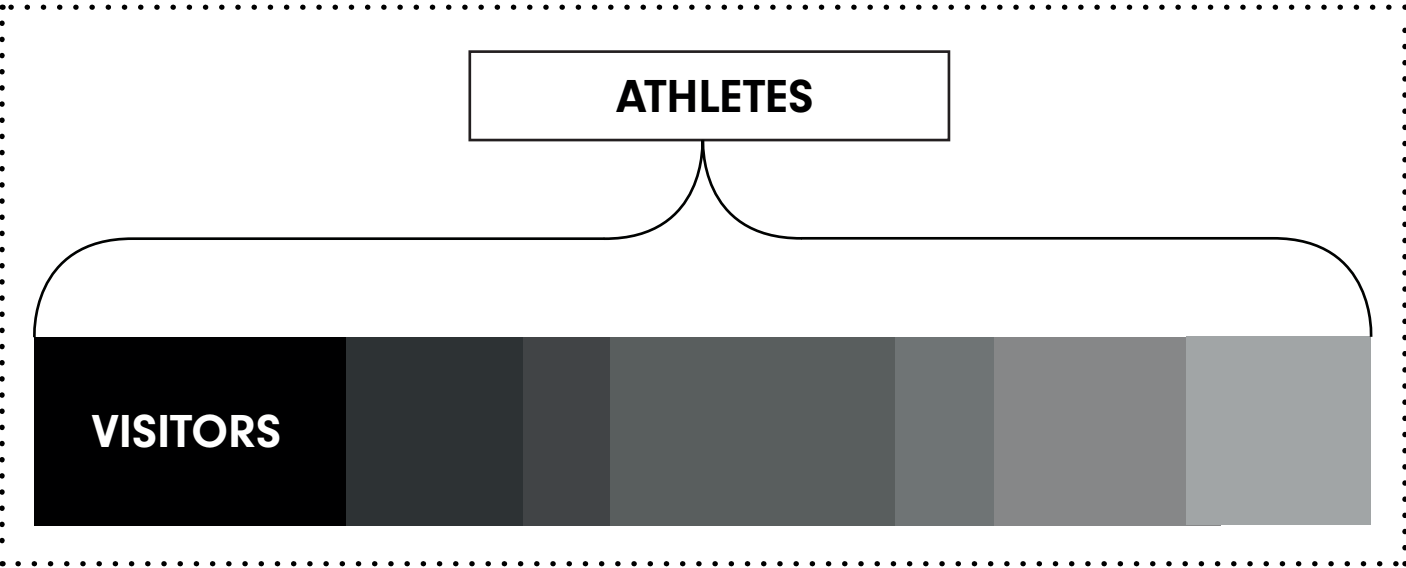

DESIGN REQUIREMENTS: LOGISTICS

SUPPORT WORKFORCE



OFFICES & DESKS

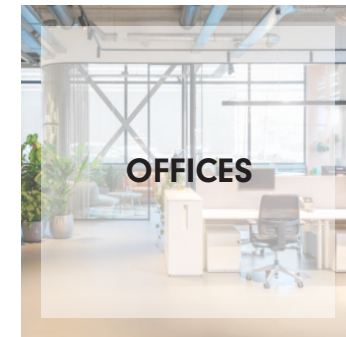
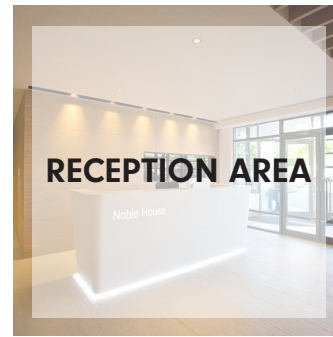

LOGISTICS



TECHNICAL SPACES



PROGRAMM REQUIREMENTS

Athletes

CEREMONIES

Staging
Presentation Area
Manager Desk
Dressing rooms
Storage (flags)

DOPING CONTROL

Office
Waiting area
Processing room
Toilet & Sink area
Athlete tagging

SPORT FACILITIES

Compound management
Sport information
Athlete Lounge
Athlete Dressing, Locker, shower, toilet
Athlete Massage area
Gym Area
Sport Meeting room
Video meeting room
Equipment Storage
Maintenance Equipment Storage

Field of Play
Sport Lighting
Warm-up area's
Athlete Call-Room
Control center
Camera positions
Athlete Seating
Toilets

PRESS OPERATIONS

Offices
Broadcast compound
Info Stations
Press Work
Photo Work
Press confrence room
Lockers
Press Tribune
Pre & Post-Competition Interview Area
Commentator Positions

Commentator-Camera
Positions.
Radio Frequency
broadcast tower

Visitors

EVENT SERVICES

Office
Ticketing
Office
Merchandise
Office
Storage
Program Sales
Merchandise Points of Sale
Catering
Catering compound
Spectator Points of sale
Manager Desk
Public information

Wheelchair Rental
Contraband Storage
Tocket Rip
Environmental Koisk
Stroller Storage
Water Station
Pay phones
Spetator rest stop
Designated Smoking area
toilets
ATM
Language services
Olympic Family Lounge

STANDS

Spectator Seating
Judges Seating
Olympic Commity Seating

MEDICAL

Office
Examination Area
Physiotherapy Area
Ambulance Parking
Finish Area
triage station
Medical Desk & Storage
Helicopter landing zone
Spectator medical

Staff

SUPPORT WORKFORCE

Workforce office area
Break and dining area

CLEANING & WASTE

Office
Containers
Storage

LOGISTICS

Logistics Compound
Office
Loading Zone

Parking Area
Transportation area

SECURITY

Office
Security Work Area
Vehicle screening Area & Office

Observation Platform
Venue Perimeter Entrance

OFFICES & DESKS

Accreditation Desk & Office
Finance Desk & Office
Olympic Family Welcome &
Transformation Desk
Protocol Manager Office

International federation
president office
International Federation
offices
Distribution desk

VENUE MANAGEMENT

Office
Storage
Desk

TECHNICAL SPACES

Telecommunication equipment room
Timing scoring and results operations
Results Printing
Audio Control

Technology Storage
General infrastructure



PROGRAMM REQUIREMENTS

Athletes	20.888 m²
CEREMONIES	290 m ²
DOPING CONTROL	416 m ²
SPORT FACILITIES	8.885 m ²
PRESS OPERATIONS	11.297 m ²

Visitors	28.813 m²
EVENT SERVICES	2.212 m ²
STANDS	26.000 m ²
MEDICAL	601 m ²

Staff	8309 m²
SUPPORT WORKFORCE	415 m ²
CLEANING & WASTE	460 m ²
LOGISTICS	2.402 m ²
SECURITY	2.237 m ²
OFFICES & DESKS	1.229 m ²
VENUE MANAGEMENT	820 m ²
TECHNICAL SPACES	746 m ²

Total	58.010 m²
--------------	-----------------------------



PROGRAMM BAR

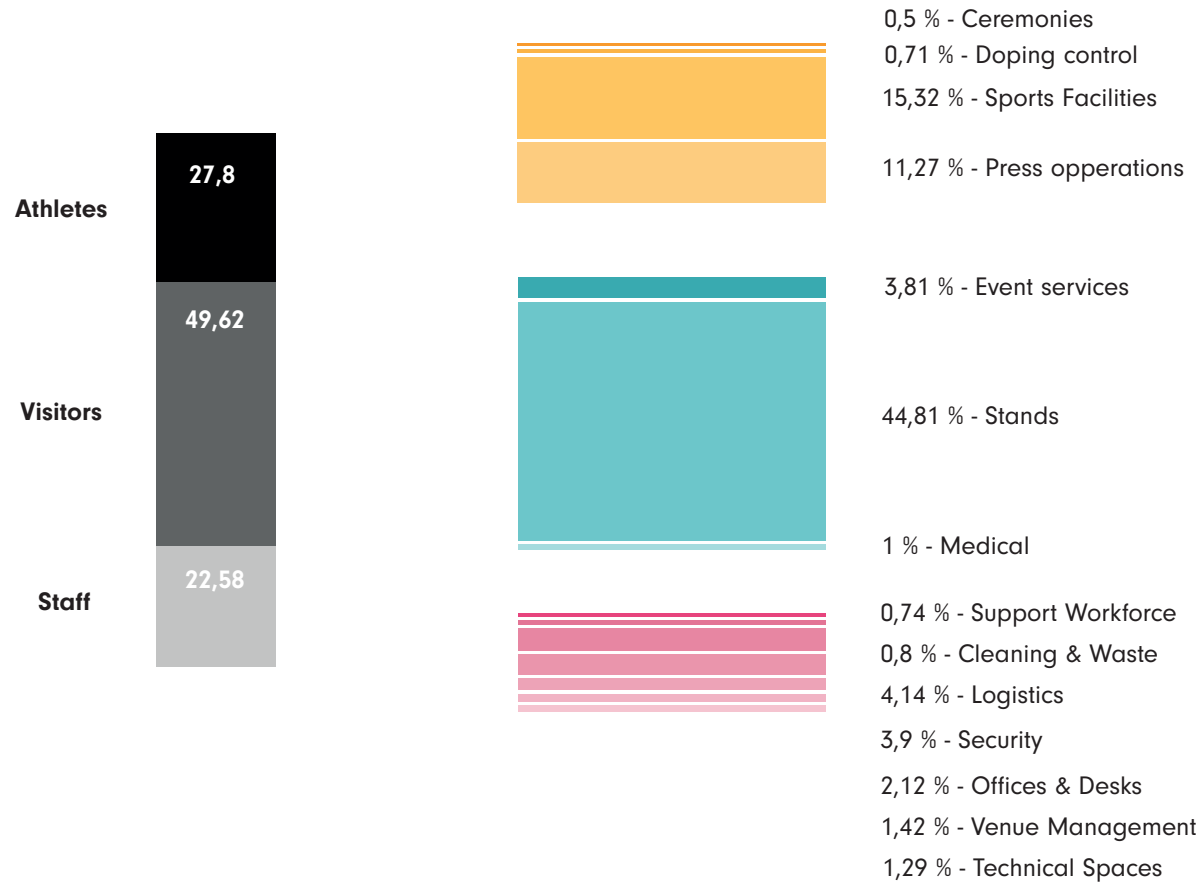

CIRCULAR

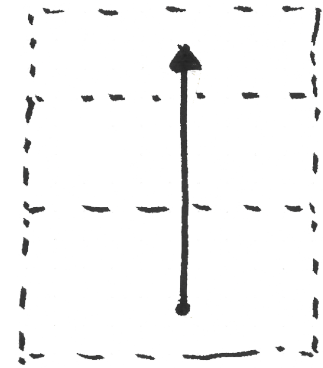
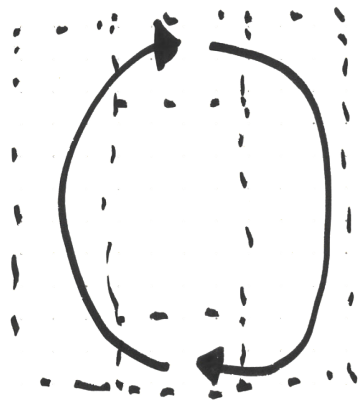

1

MINIMISE FLOORAREA

Decrease the floorarea of the final volume

2

CLEAR CIRCULATION

Create very clear circulation to increase user comfort

3

DEFINITE SEPERATION FUNCTIONS

Seperate the visitors, workers and athletes



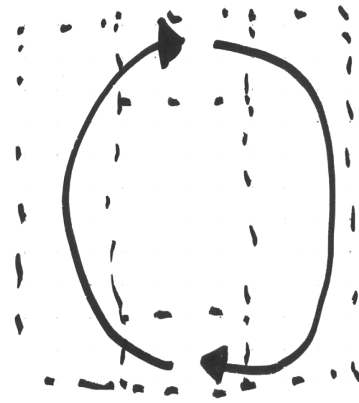

USERS



ATHLETES



VISITORS

THERE IS GOING TO BE TWO DISTINCTIVE USERS WITH DIFFERENT NEEDS

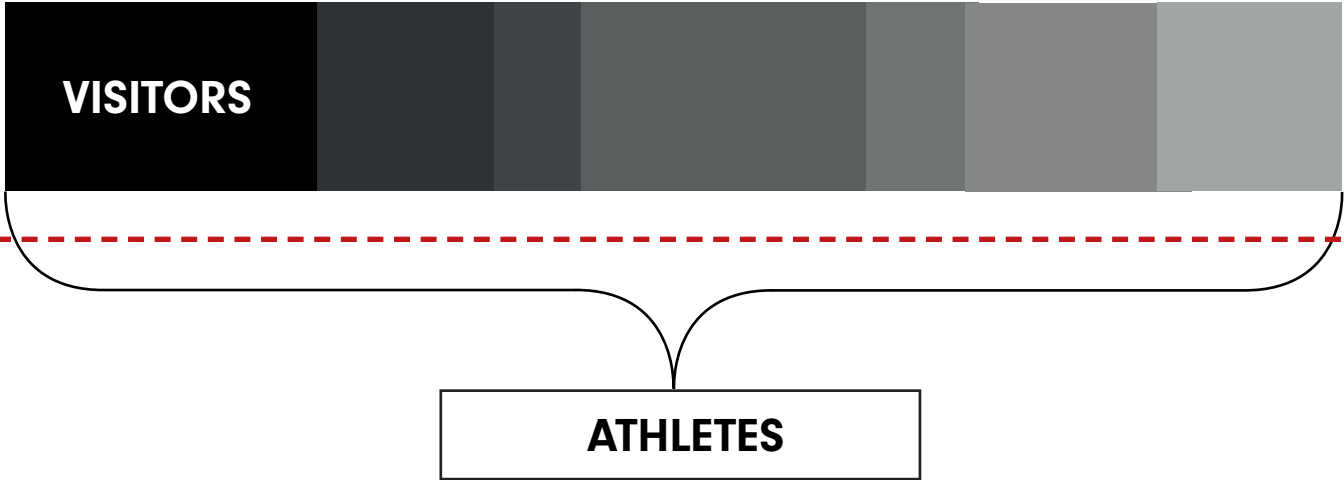

ATHLETES

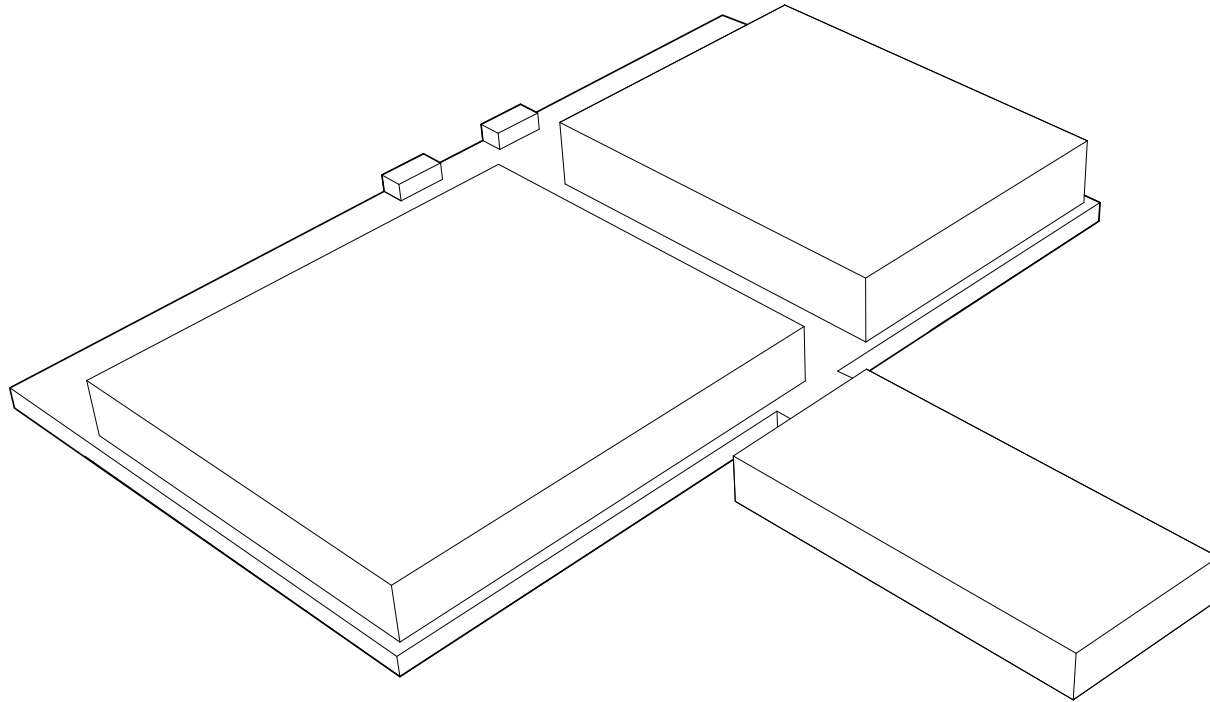

VISITORS



VISITORS

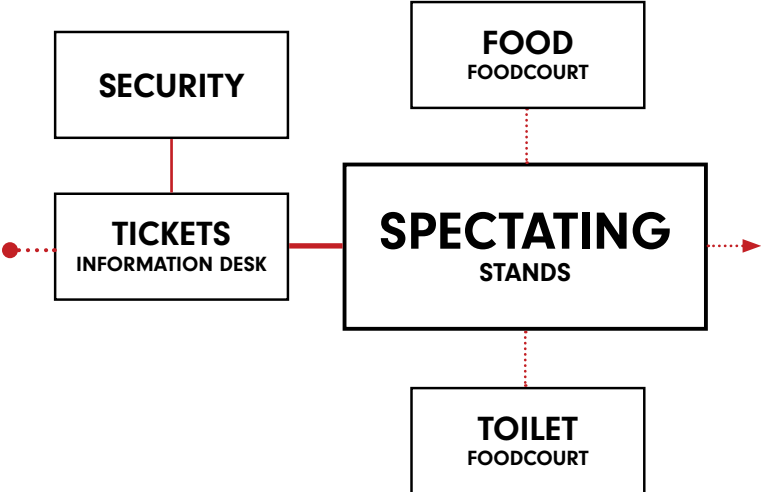

VISITORS



VISITORS

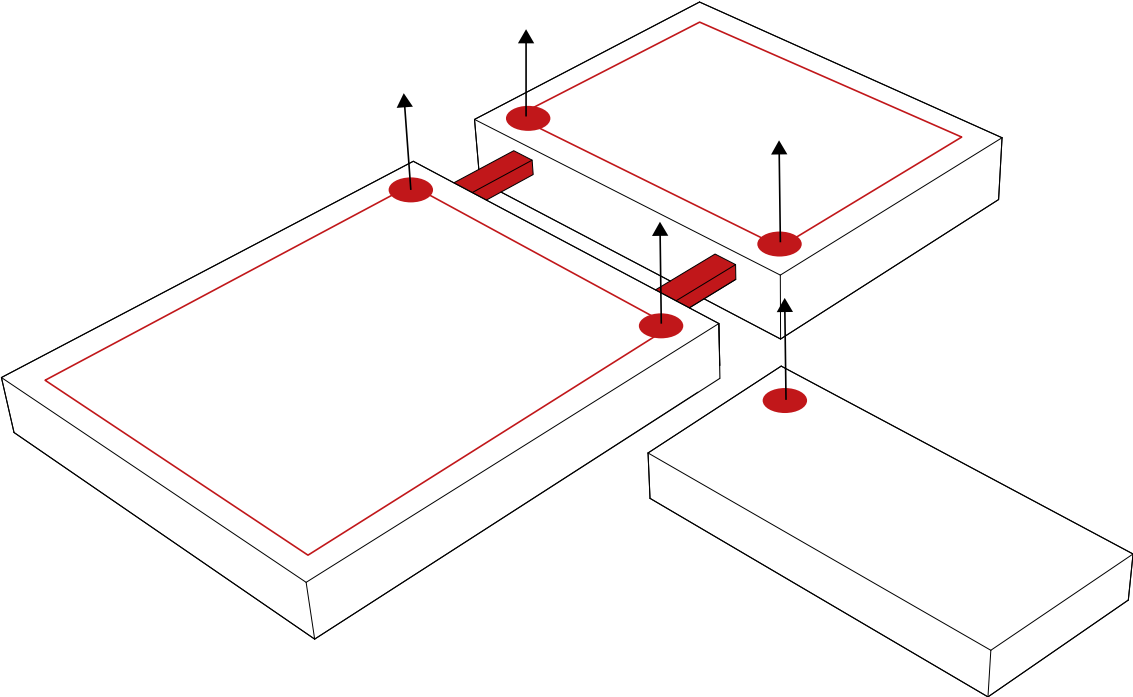

ATHLETES

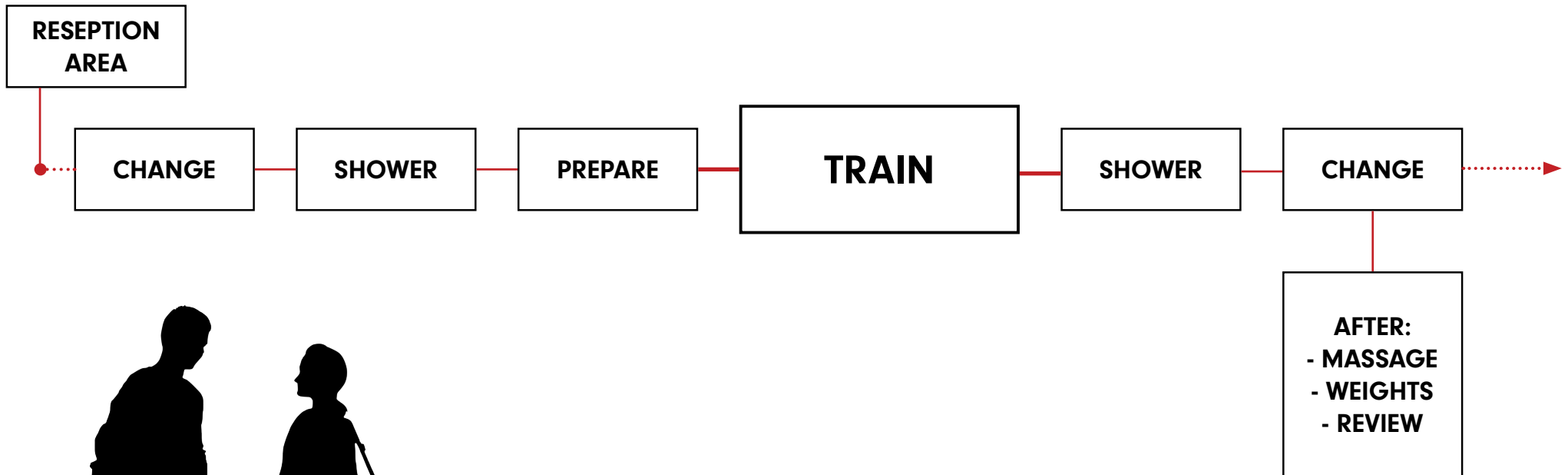

ATHLETES

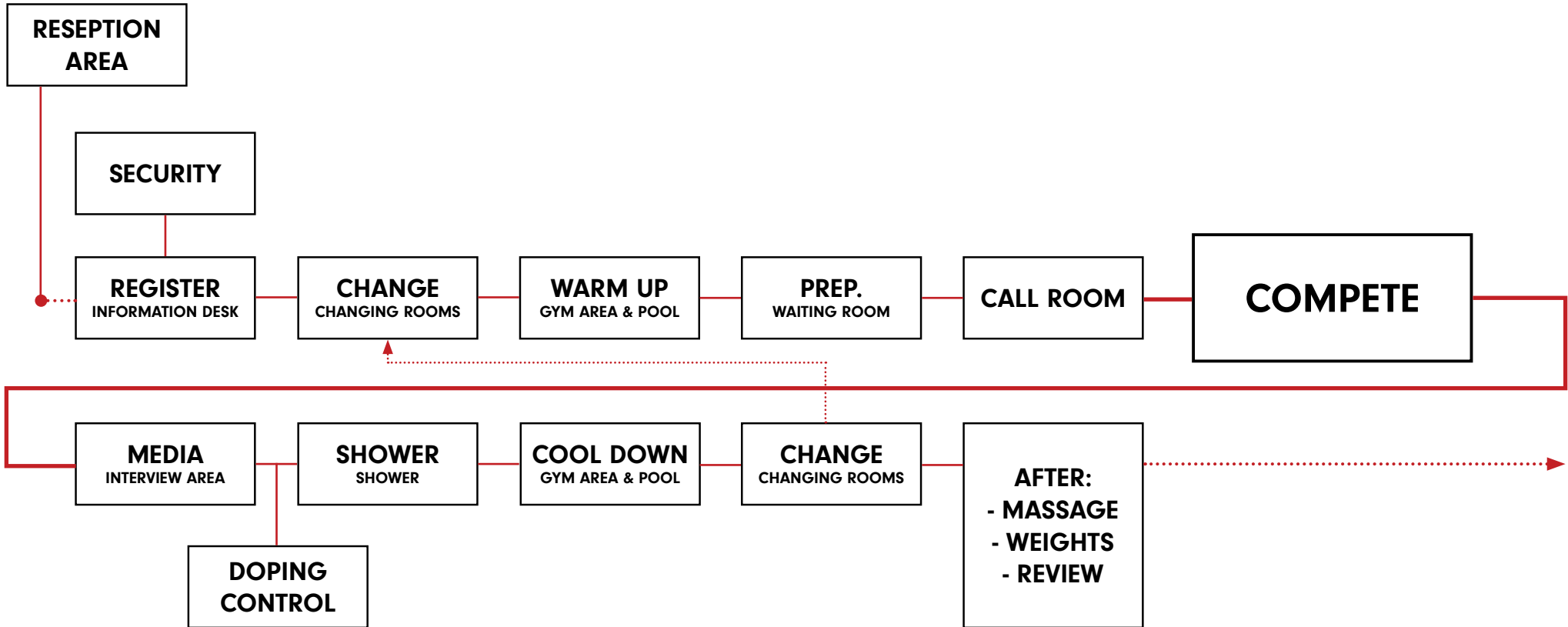

ATHLETES



ATHLETES

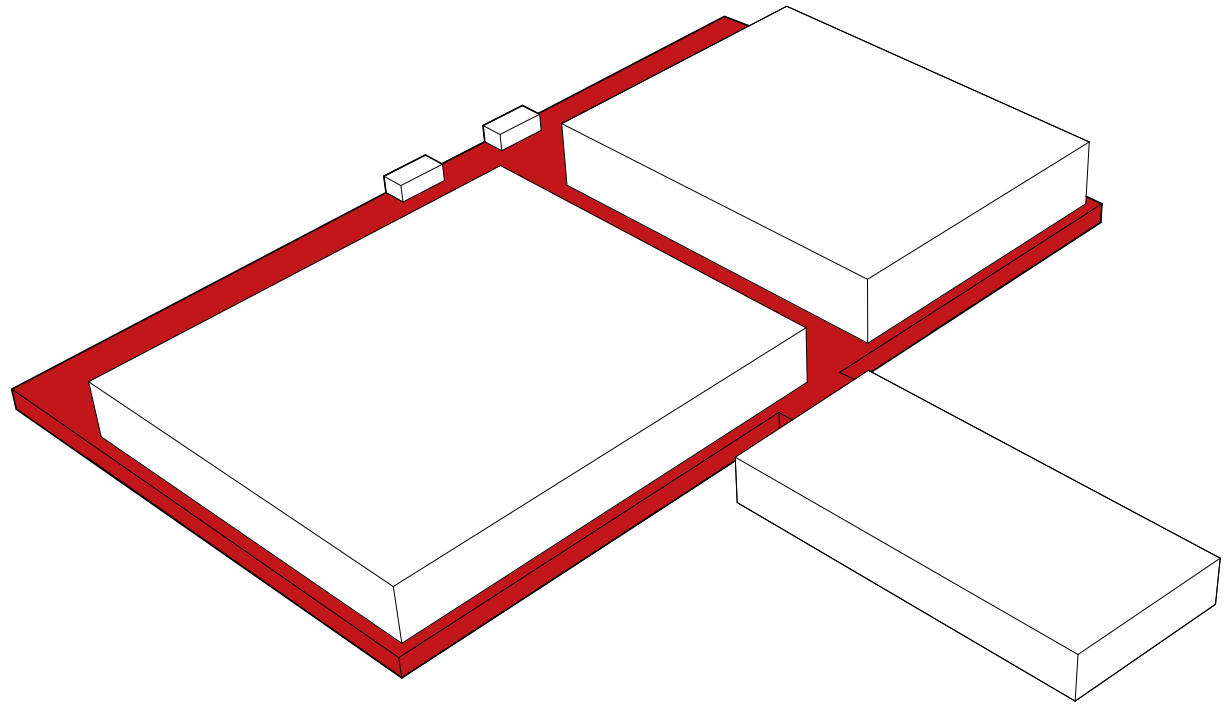

LOGISTICS

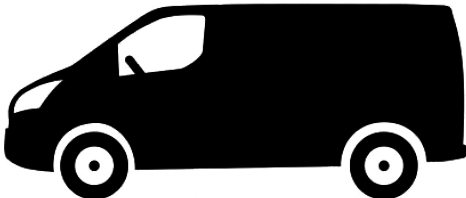

LOGISTICS

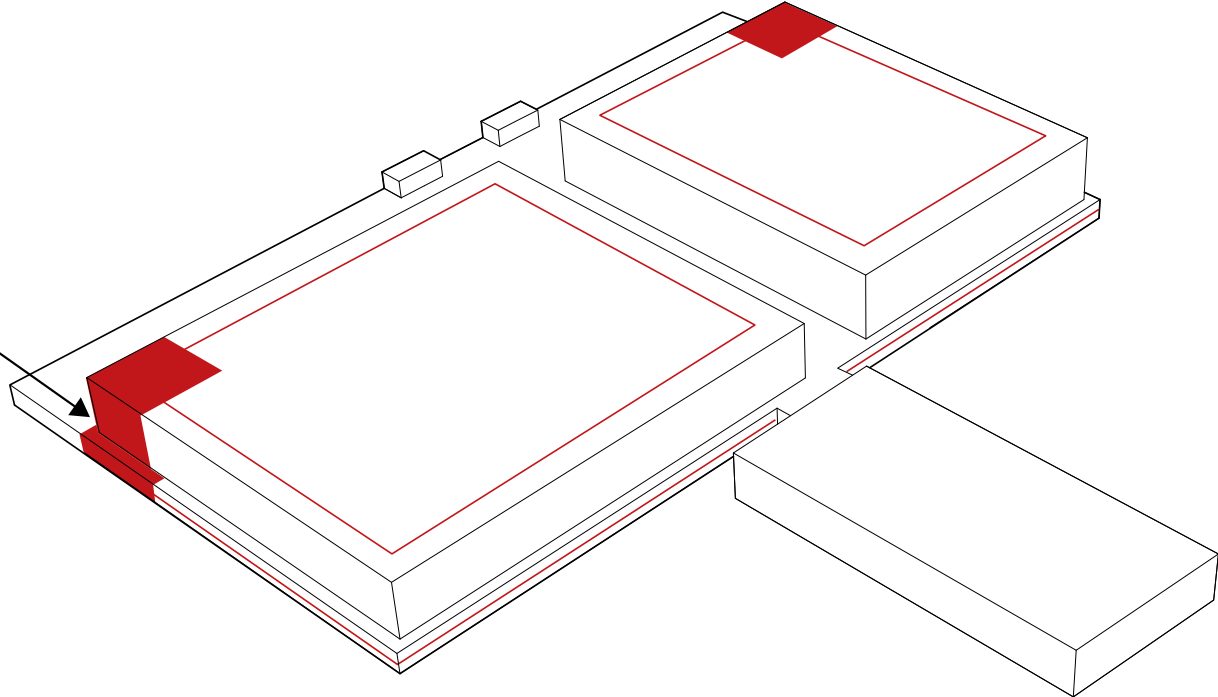

FLOWS

Visitors (Competition)

Athletes (Practice)

Athletes (Competition)

Visitors (Families)

Logistics

Total

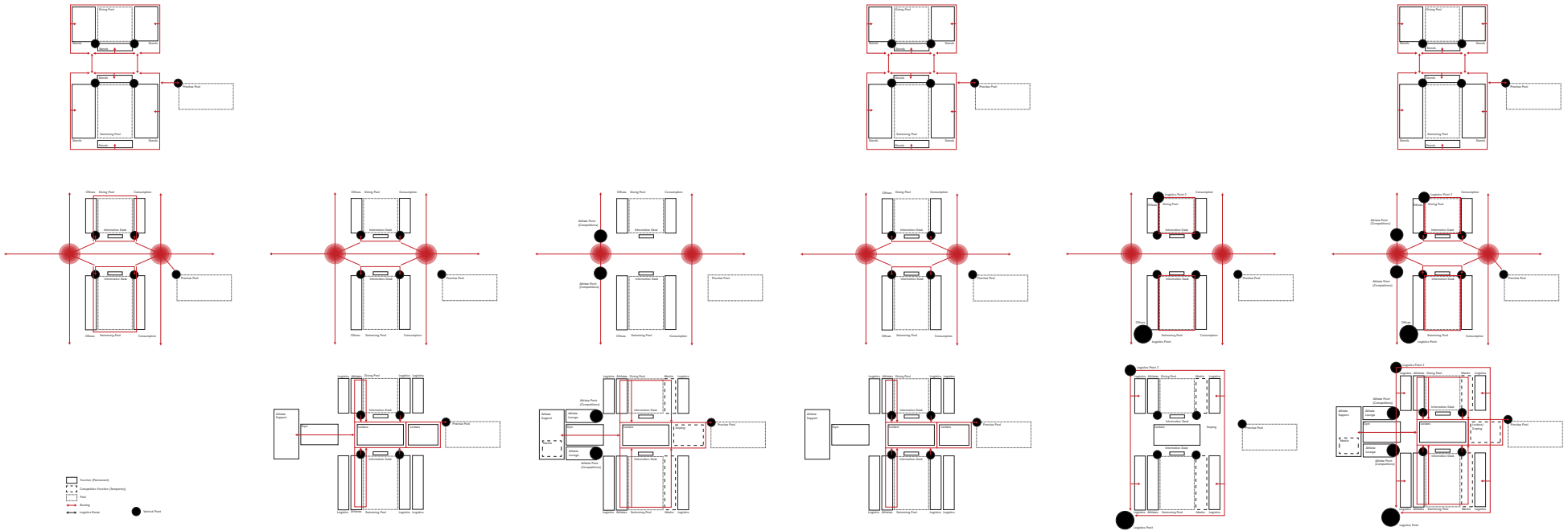



ENTRANCES

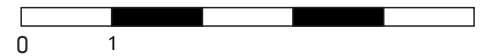
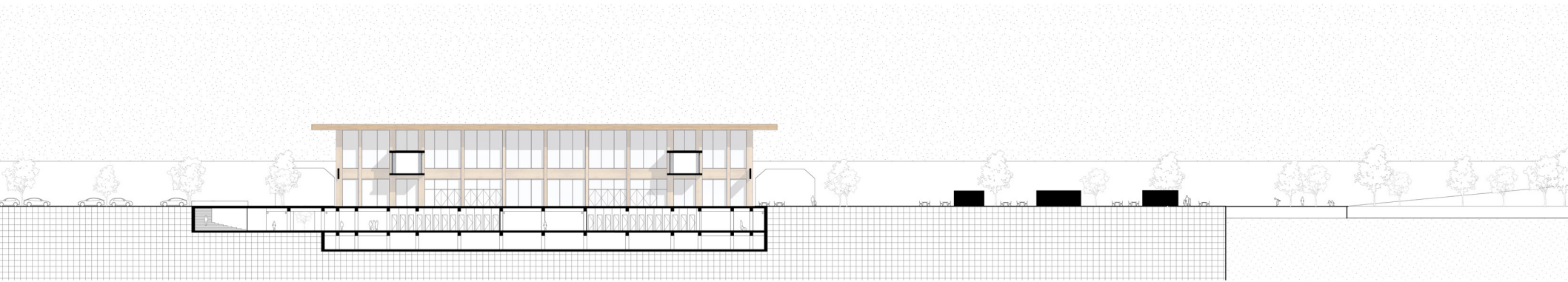

GROUND FLOOR

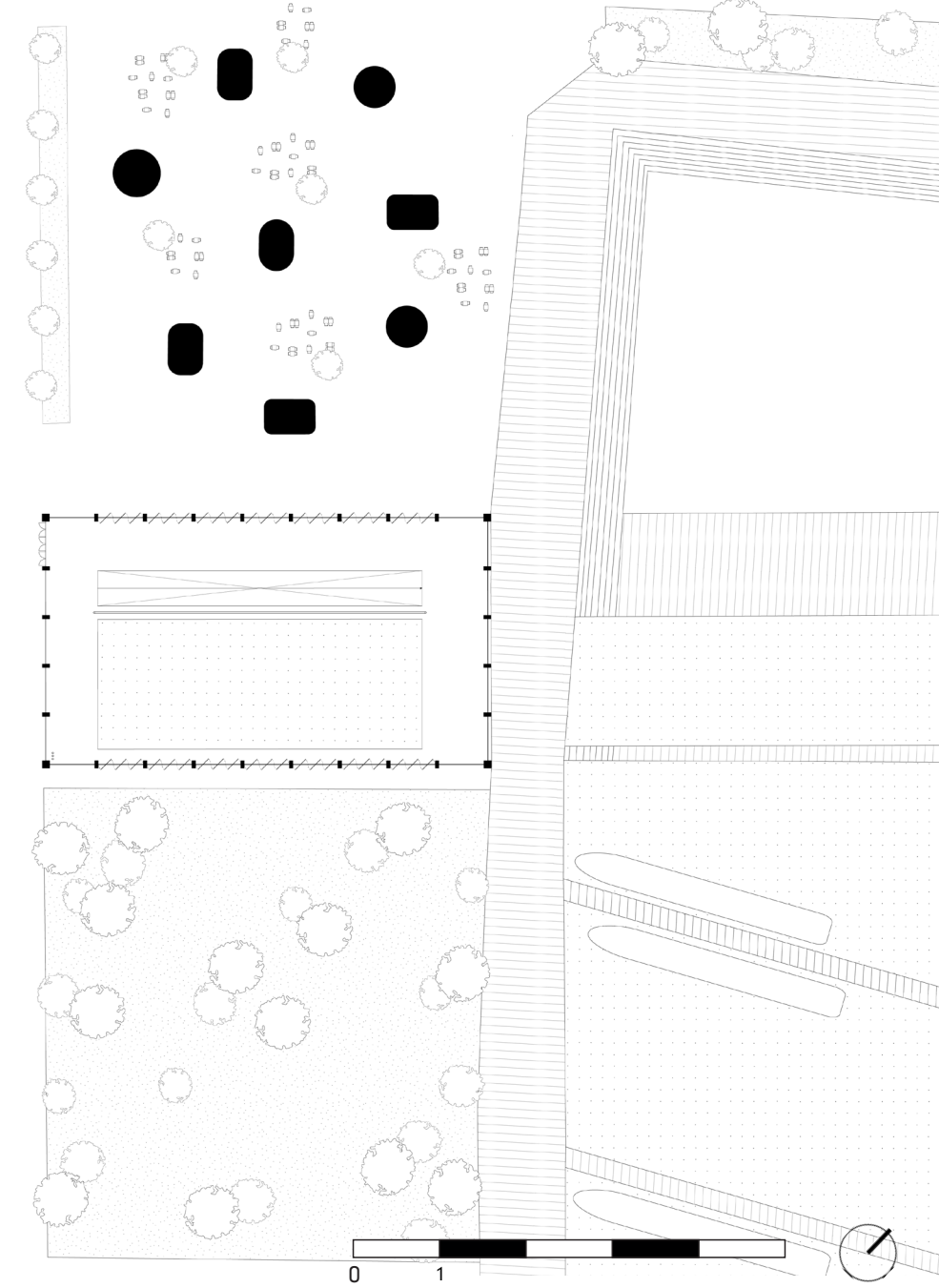
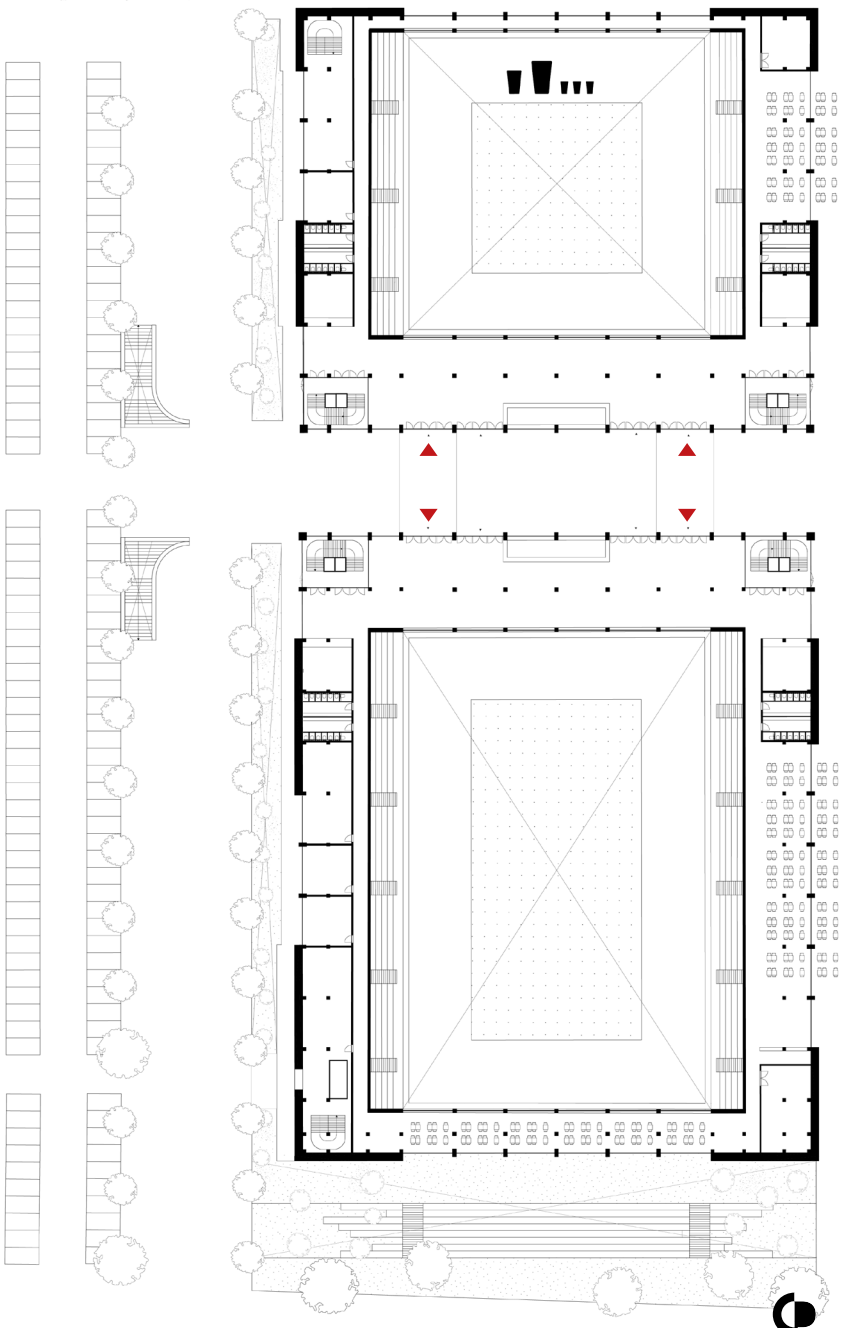

1ST FLOOR | STANDS

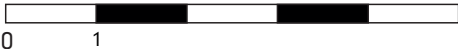
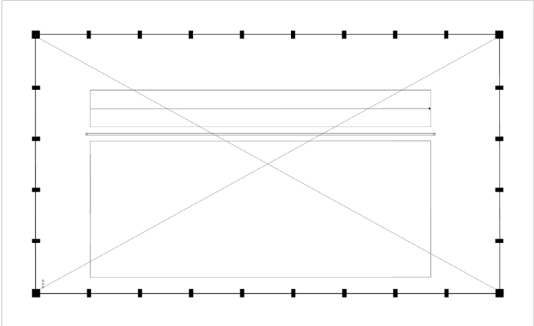
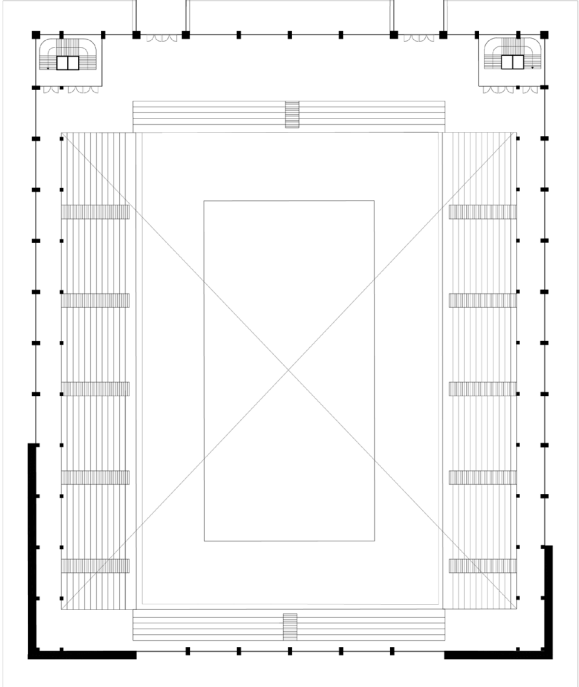
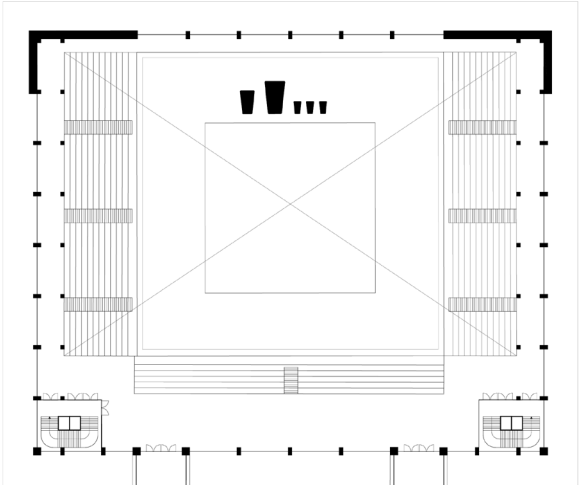

GROUND FLOOR

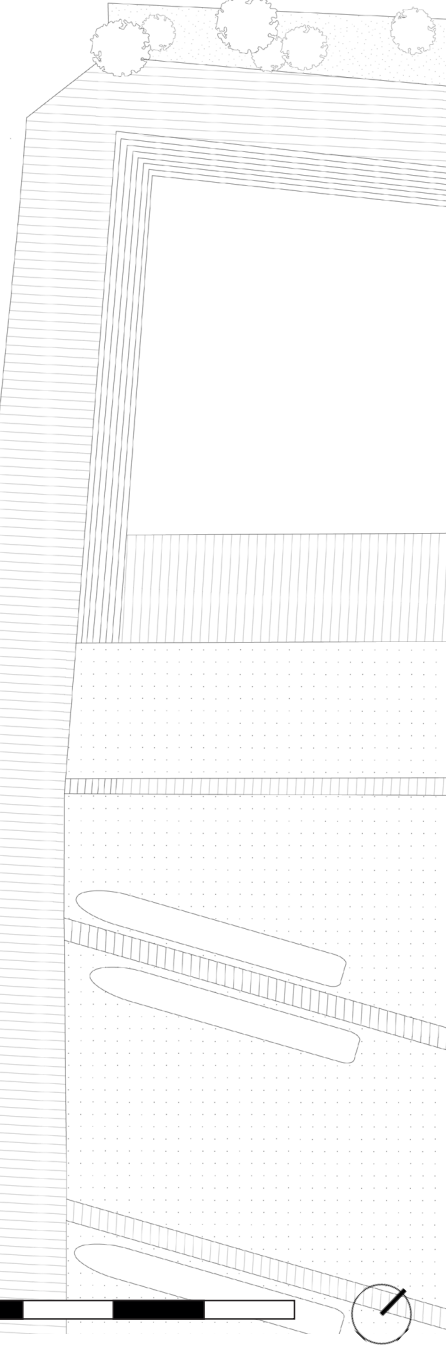
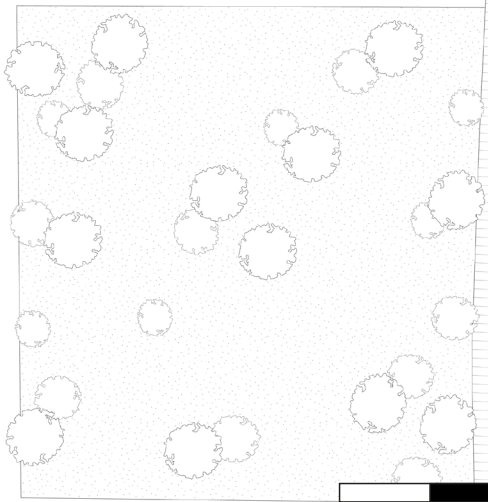
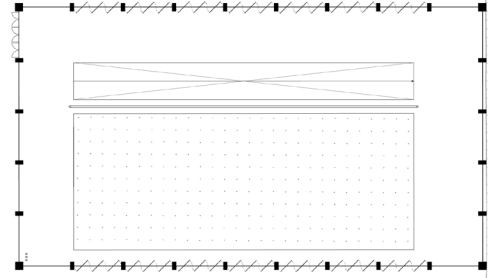
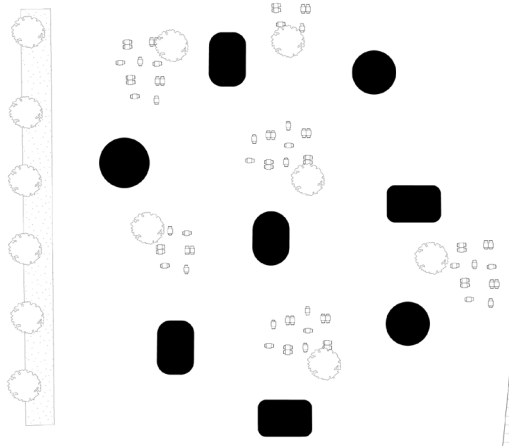
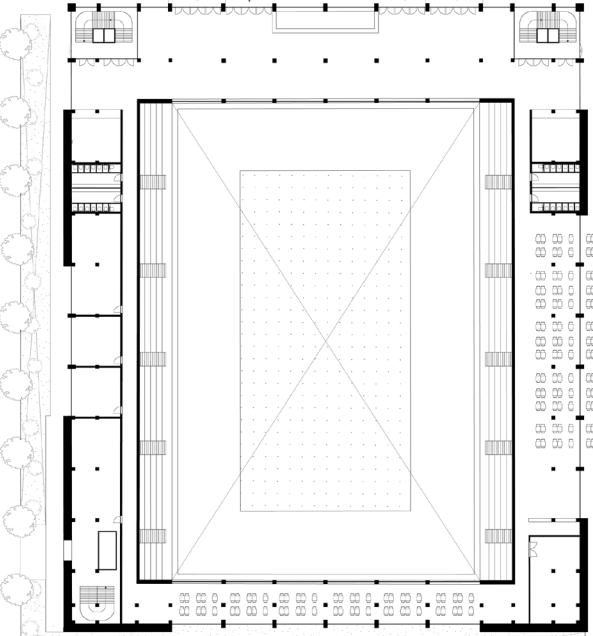
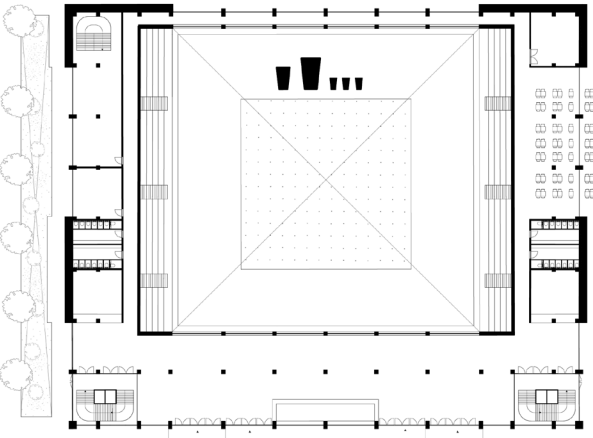
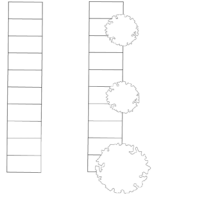
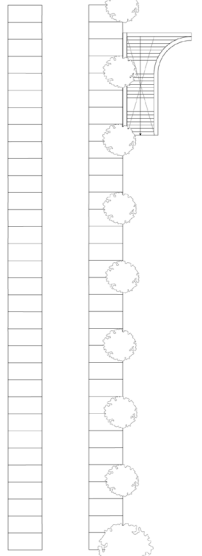
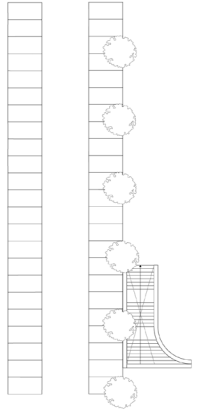
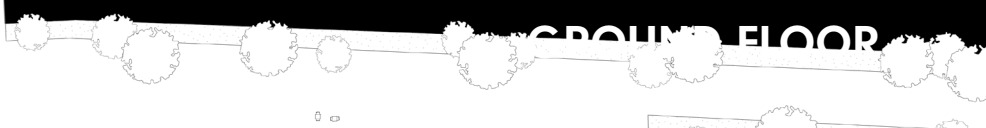
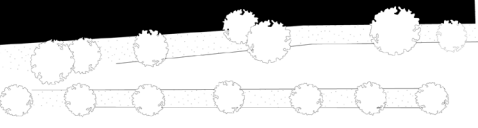



GROUND FLOOR

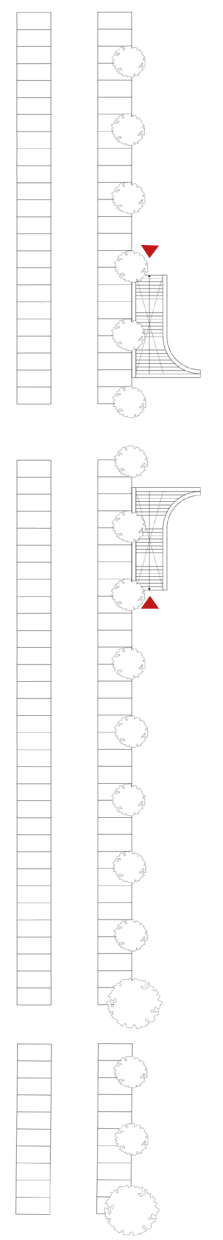
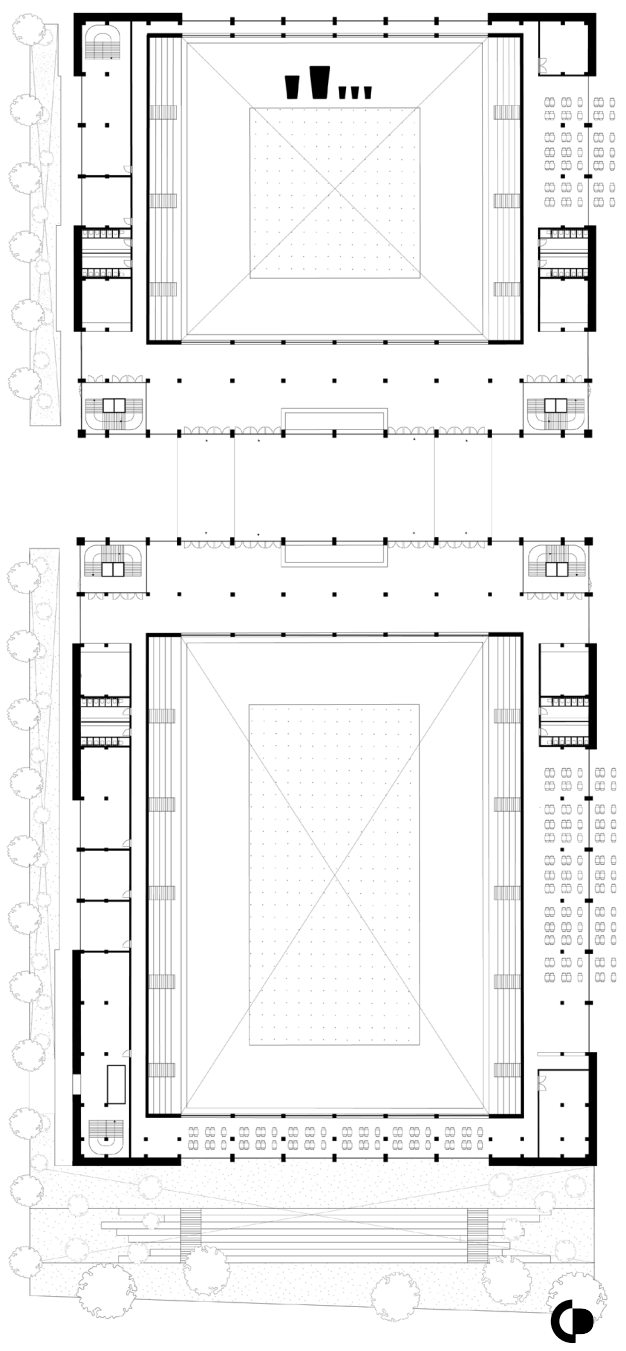
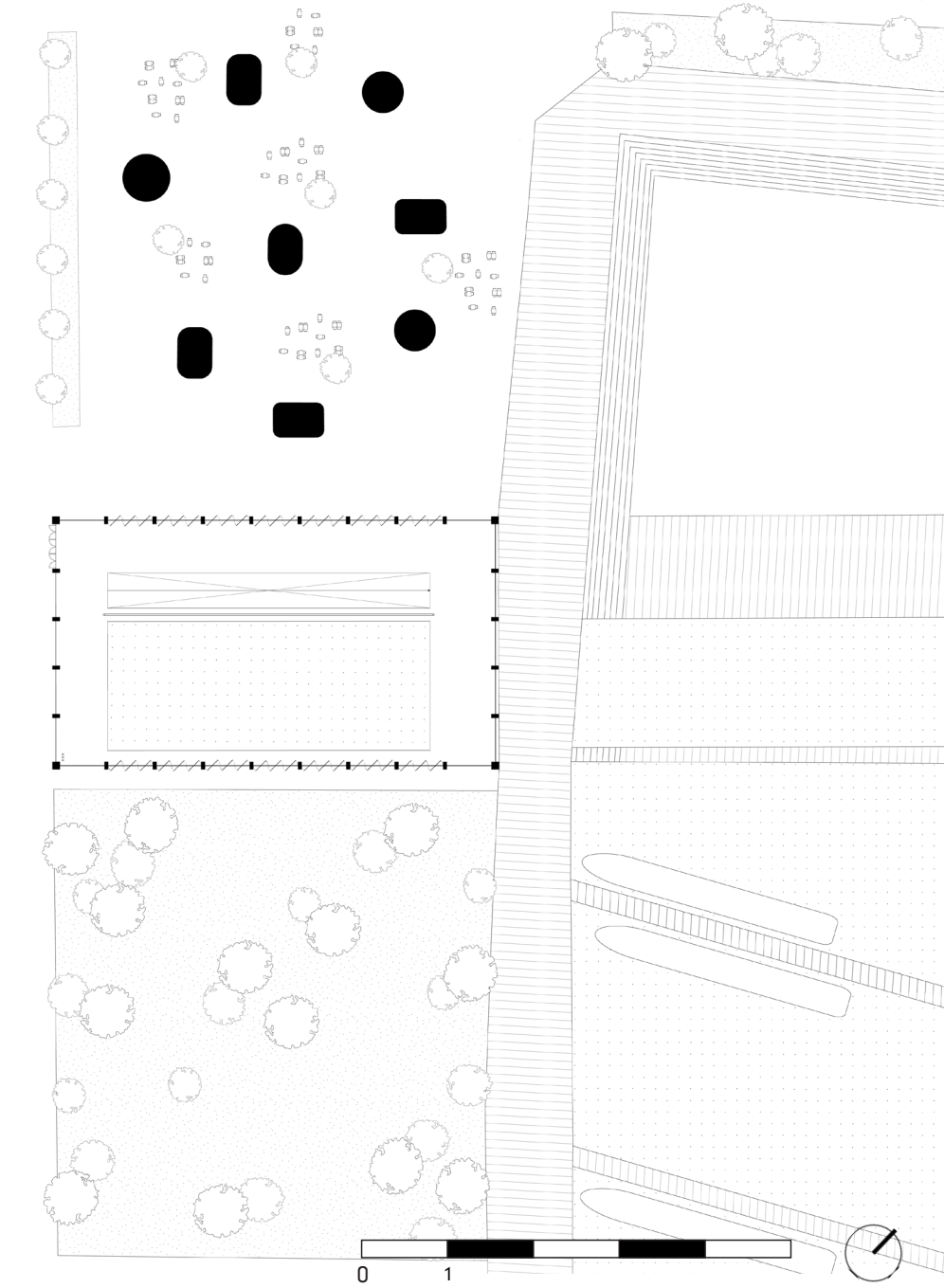

-1 | ATHLETES BASEMENT

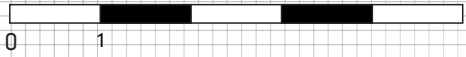
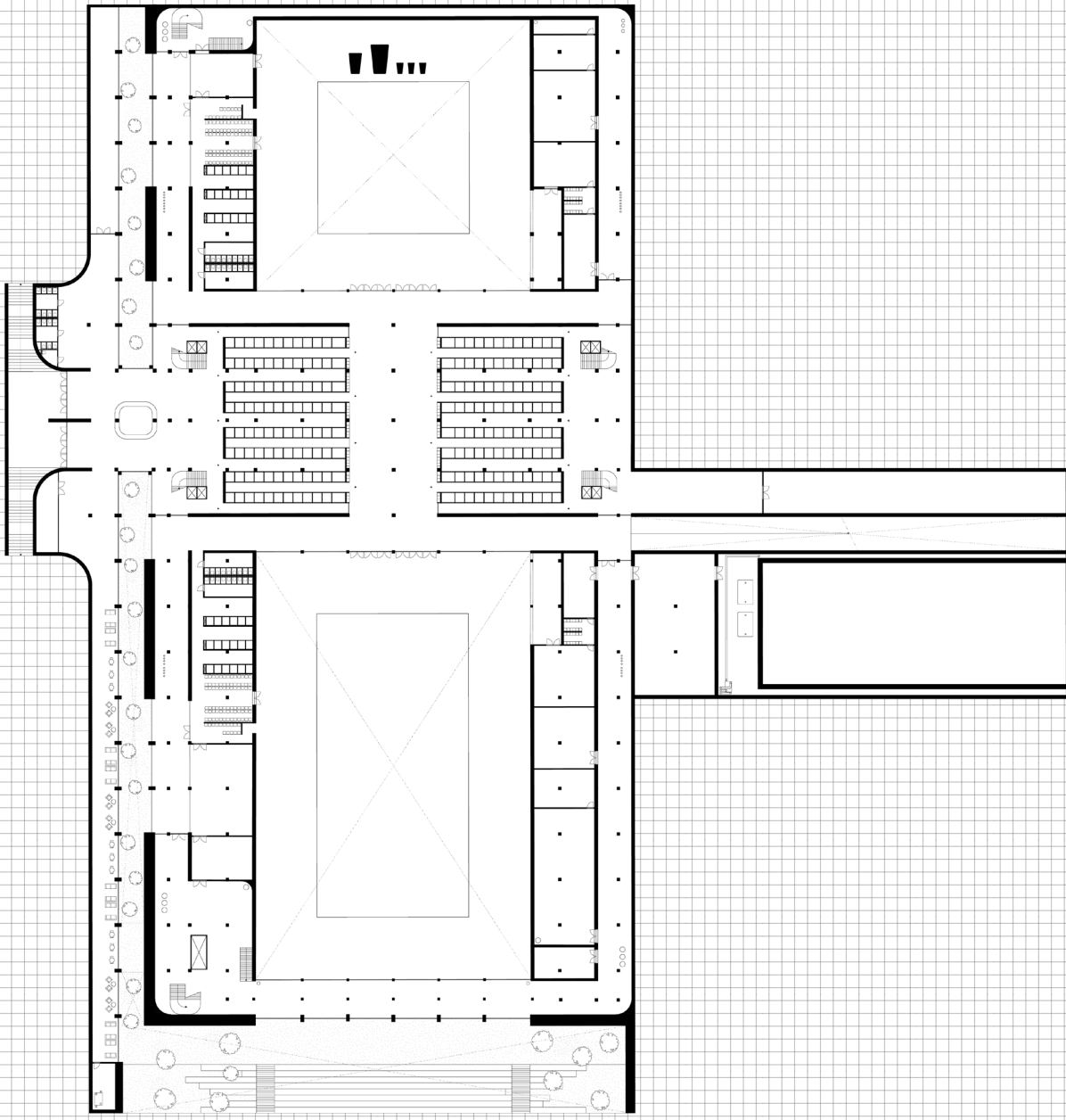

FLAWS

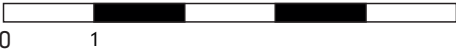
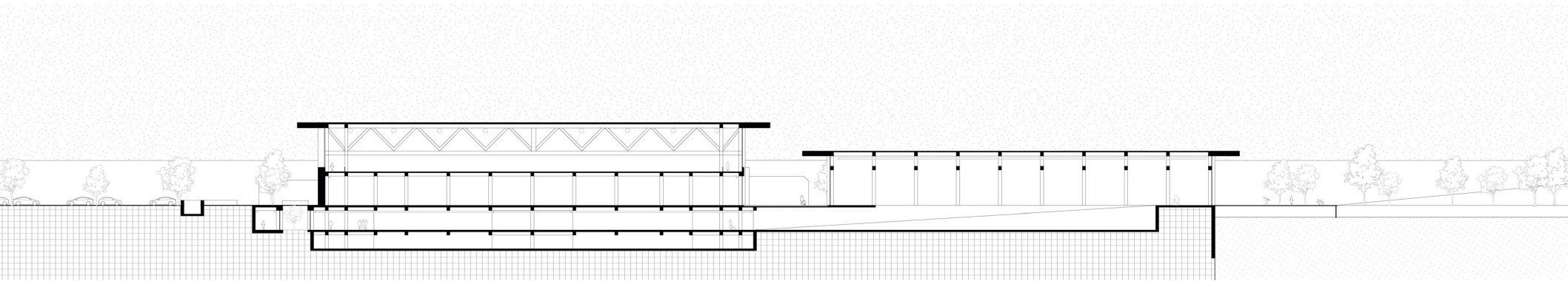

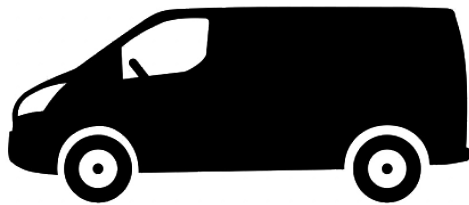

GROUND FLOOR

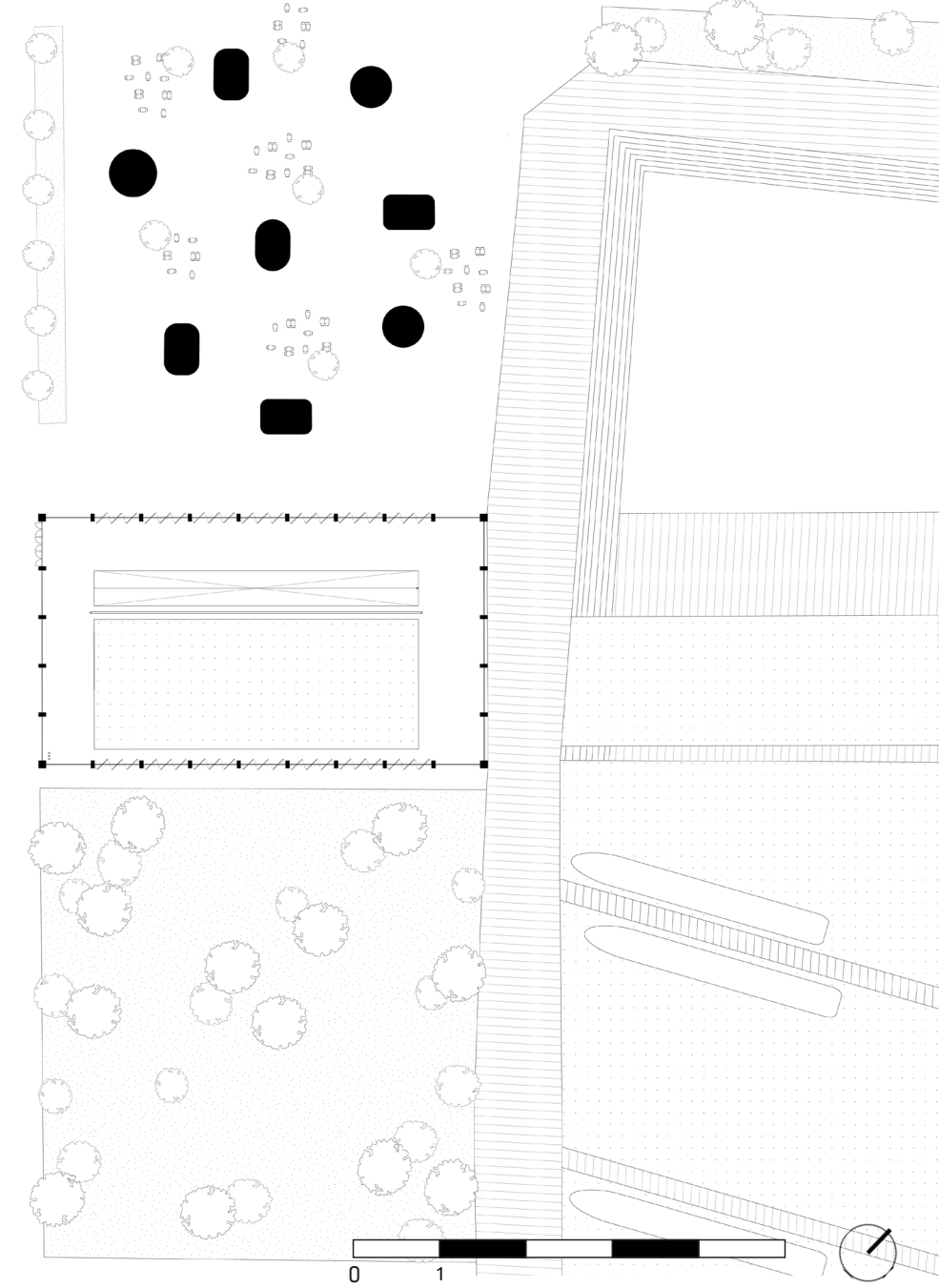
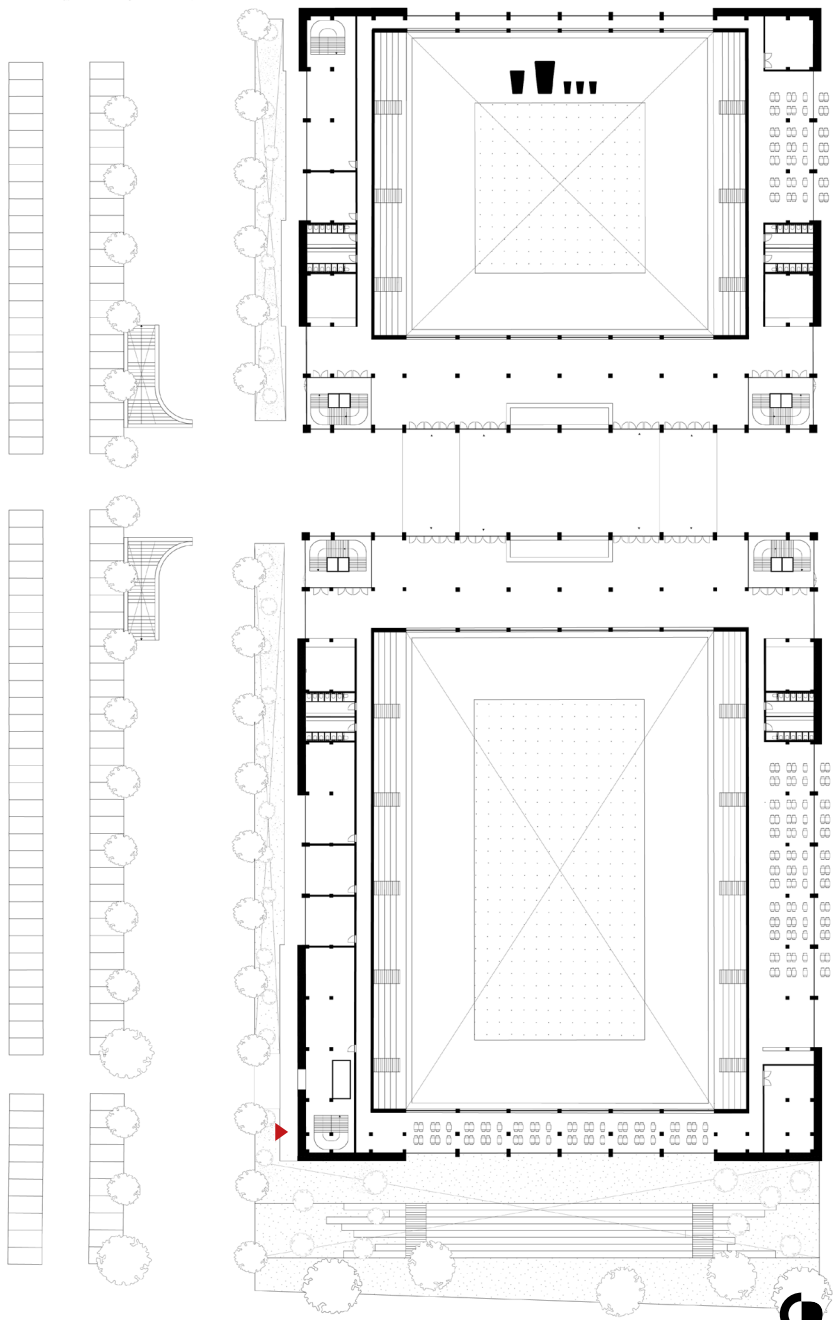

-1 | ATHLETES BASEMENT

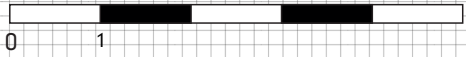
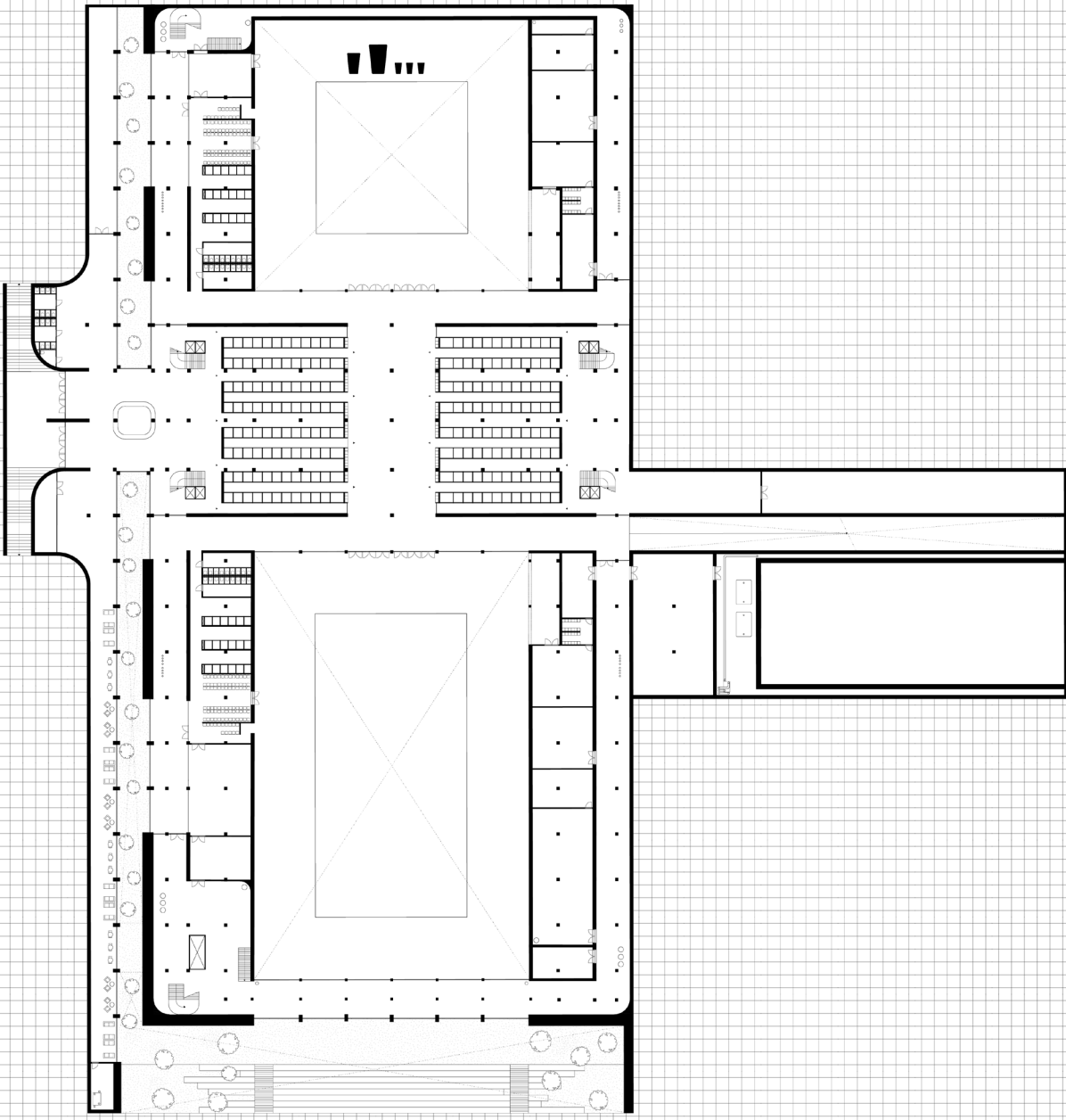

-2 | TECHNICAL BASEMENT

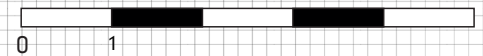
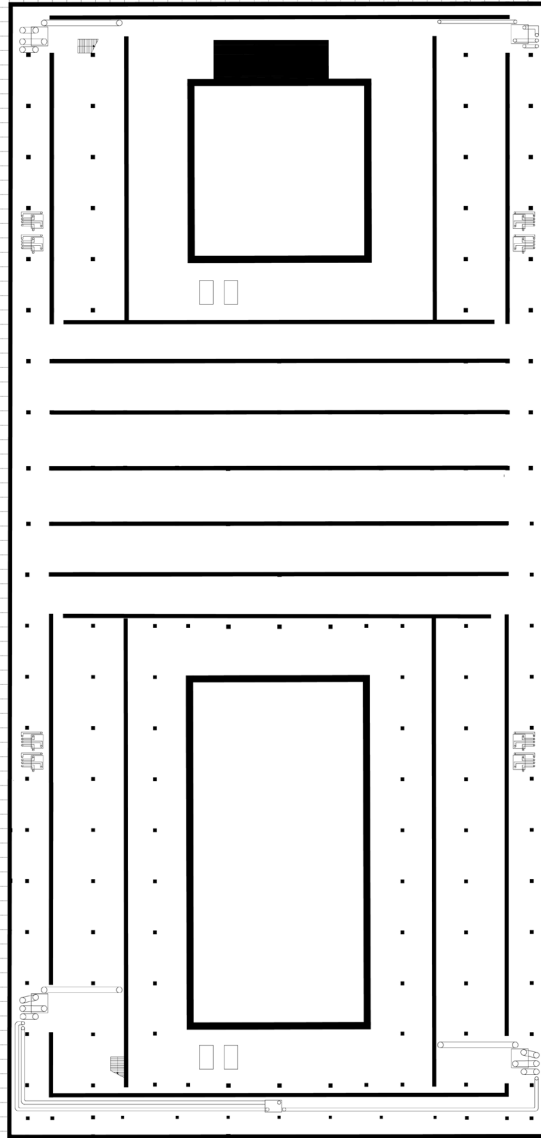

ARCHITECTURAL EXPRESSION



RESEARCH



THE SWIMMING POOL

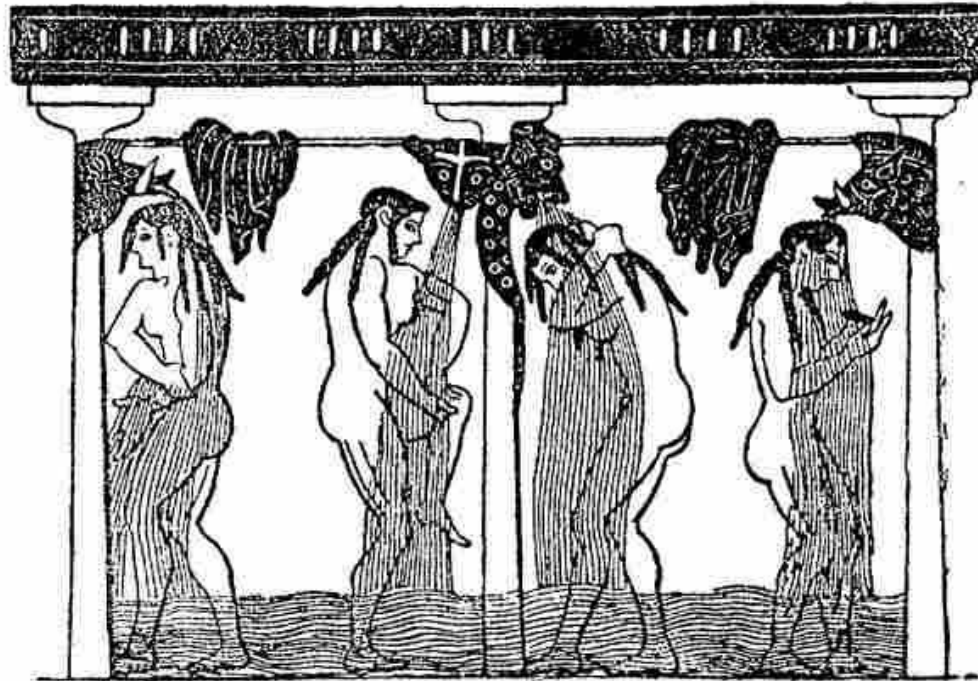

Shower Baths for Women. (From a Greek Vase.)

Greek Society

1700 - 1400 BC



THE SWIMMING POOL



Open air swimming pools



Roman Bathing Houses

Roman Times

625 BC - 476 AD

AIR QUALITY

Impact on the Body

Plato



Hippocrates

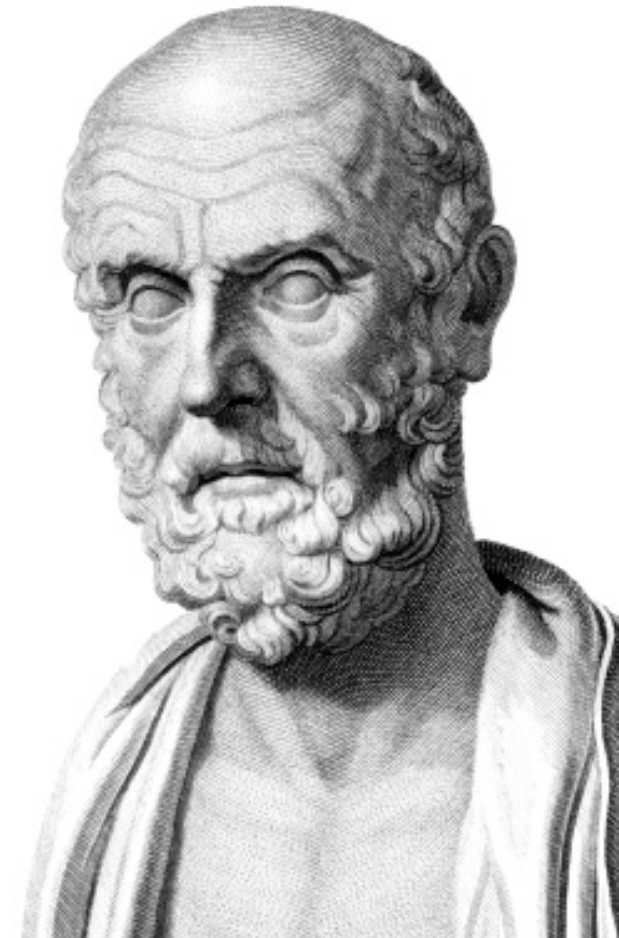

“Many famous philosophers, such as Plato and Hippocrates, talked about the experience of bathing and the advantages it has for a person’s health and wellbeing”

- Research Plan

AIR QUALITY

Bodily Experience

“When visiting a public bath, the visitor would visit different temperature baths, increasing humidity, forming a complex ritual..... These climate differences were created by specially designed natural ventilation techniques, with which they could control the air quality within different rooms.”

- Research Plan



THE SWIMMING POOL

Public Bathing

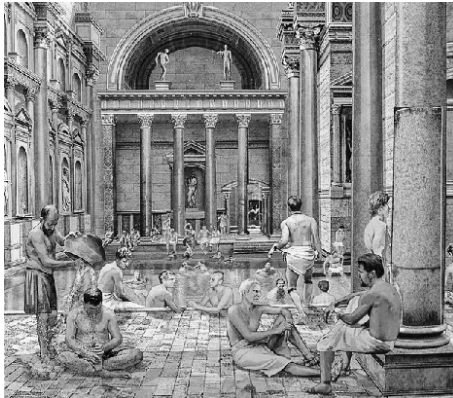

625 BC - 476 AD

Rise of Private Bathing



19th and 20th century

Technical development of swimming pools



20th and 21st Century



1896 Olympics - Athletic development swimming

THE SWIMMING POOL

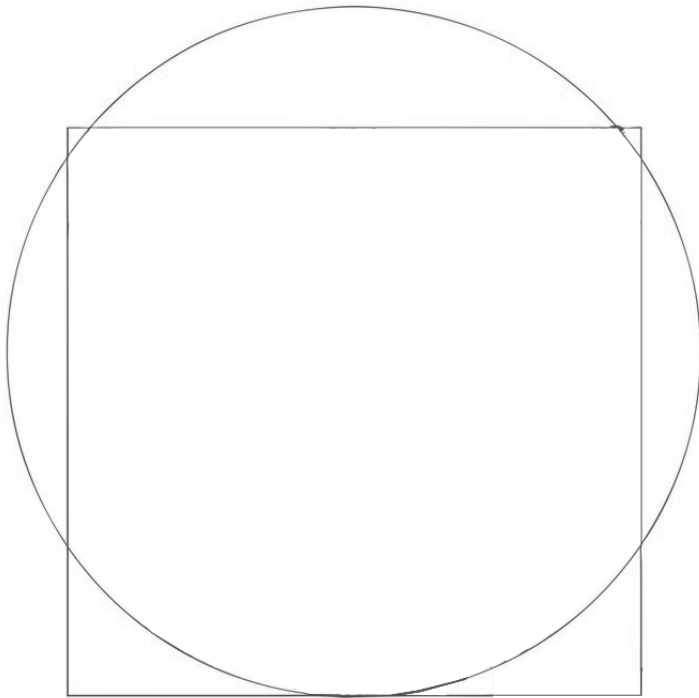

High performance environment to support the Bodily Experience

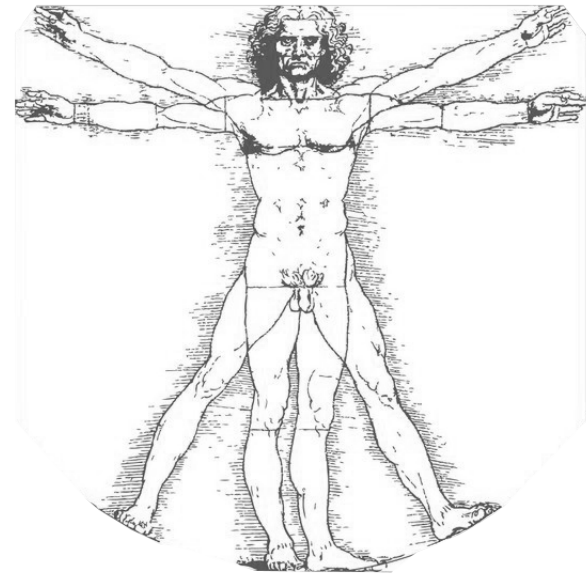

High performance environment to support the Bodily Performance

AIR QUALITY

Natural Ventilation

625 BC - 476 AD

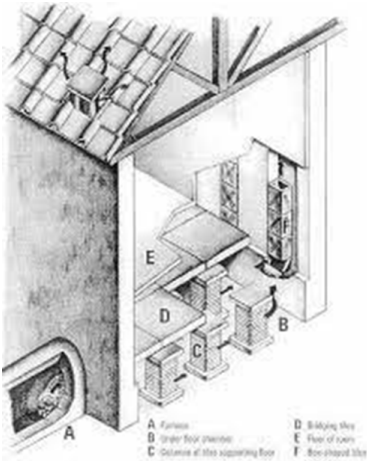

Mechanical Ventilation

19th and 20th century

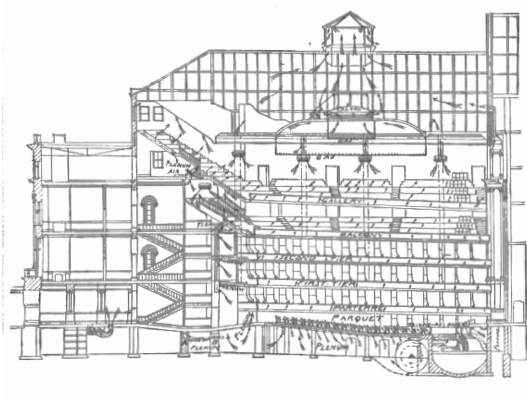

Mechanical Ventilation

20th and 21st Century

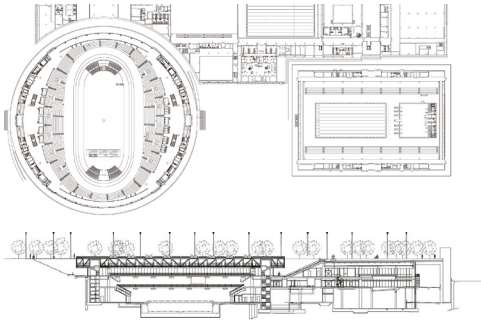

NATURAL VENTILATION

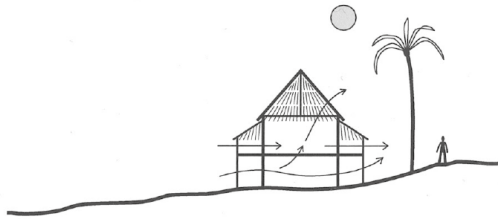

THAILAND - HOUSE ON STILTS

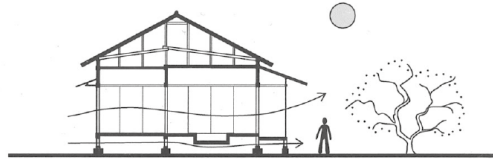

JAPAN - TRADITIONAL HOUSE

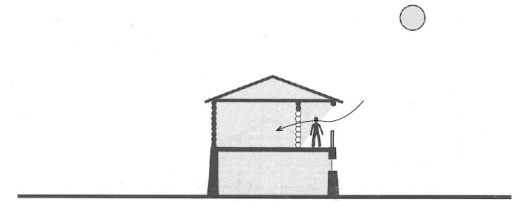

TURKEY - COUNTRY HOUSE

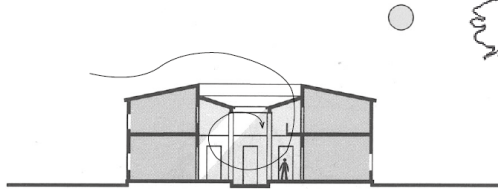

ROME - ATRIUM HOUSE

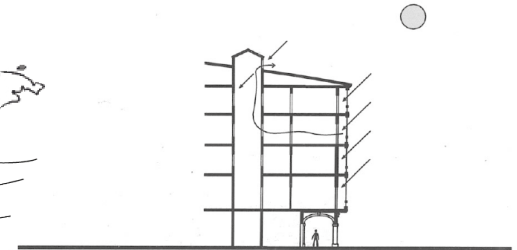

LA CORUÑA - TOWN HOUSE

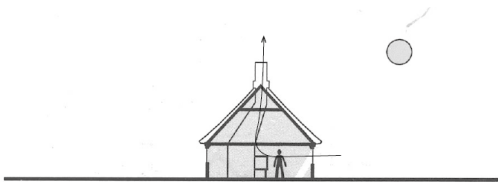

FANØ - RECTANGULAR-SHAPED HOUSE

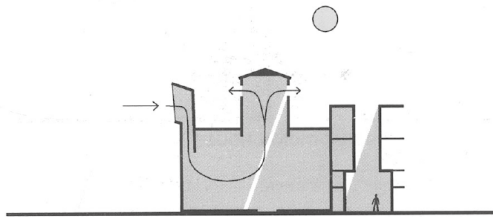

EGYPT - TOWN HOUSE

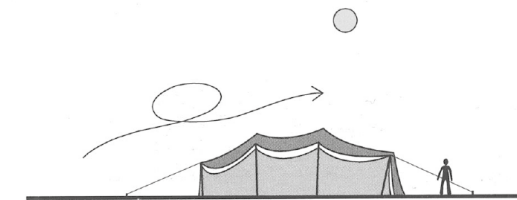

SAUDI ARABIA - BEDOUIN TENT

NATURAL VENTILATION

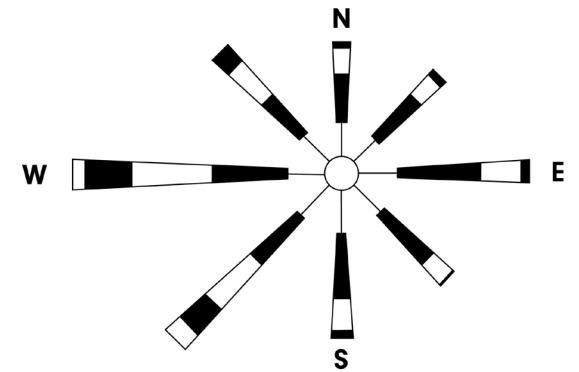
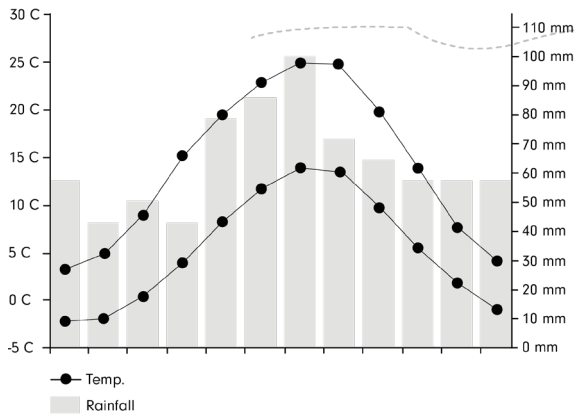

Marine West Coast climate zone.

NATURAL VENTILATION

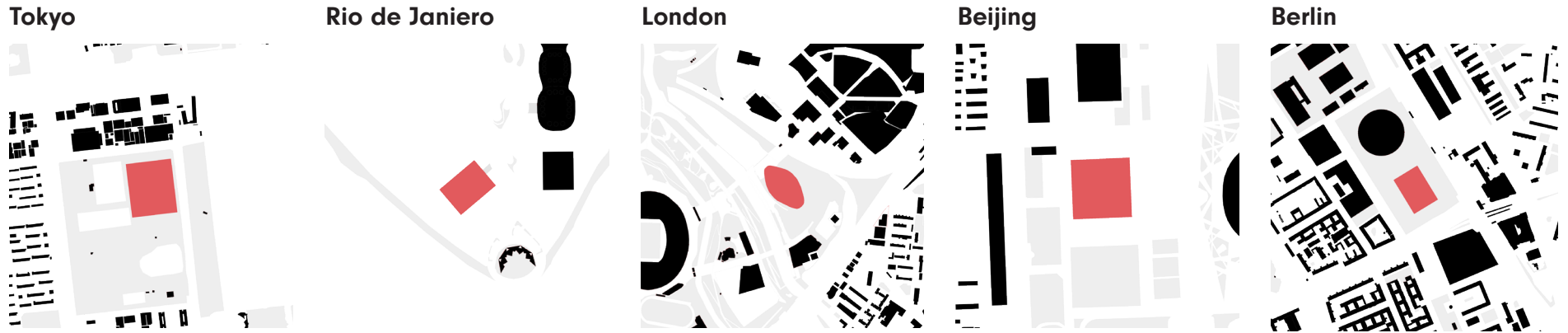

NATURAL VENTILATION IS NOT POSSIBLE TO ACHIEVE THE HIGH PERFORMANCE ENVIRONMENT NEEDED

CLIMATE ZONES

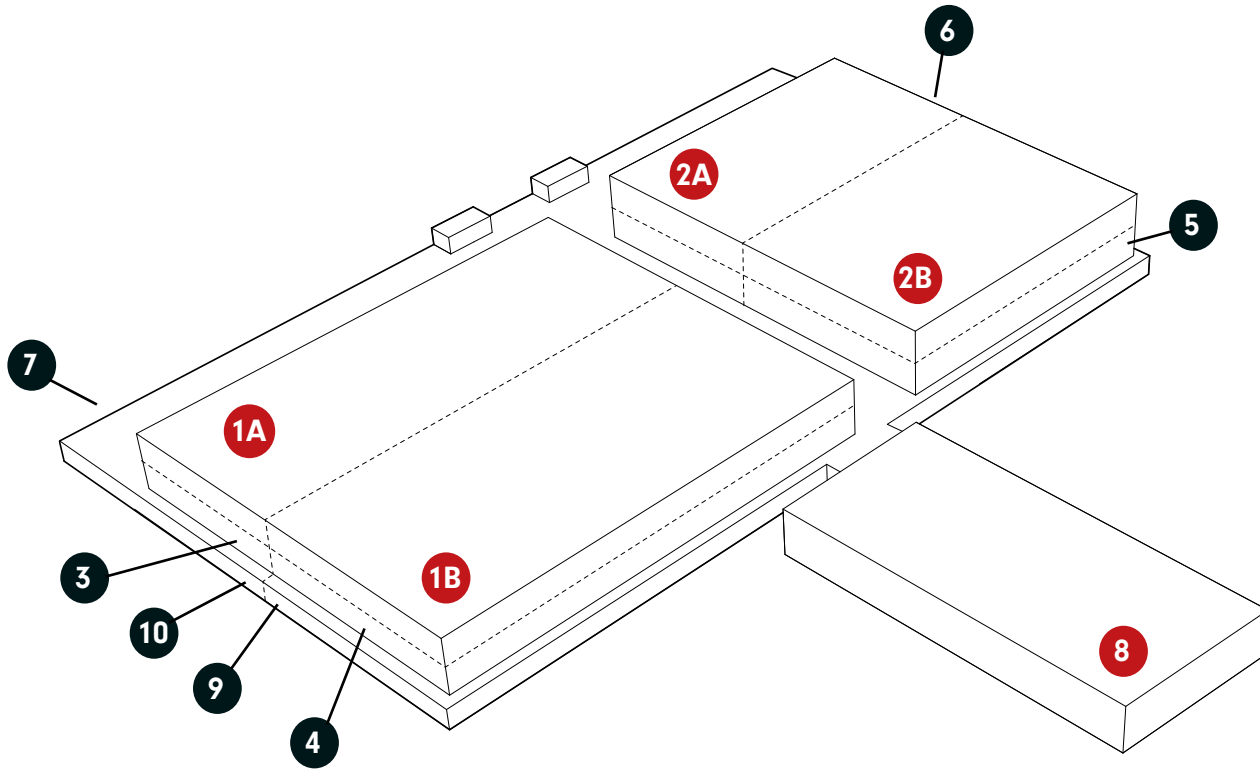

MECHANICAL VENTILATION

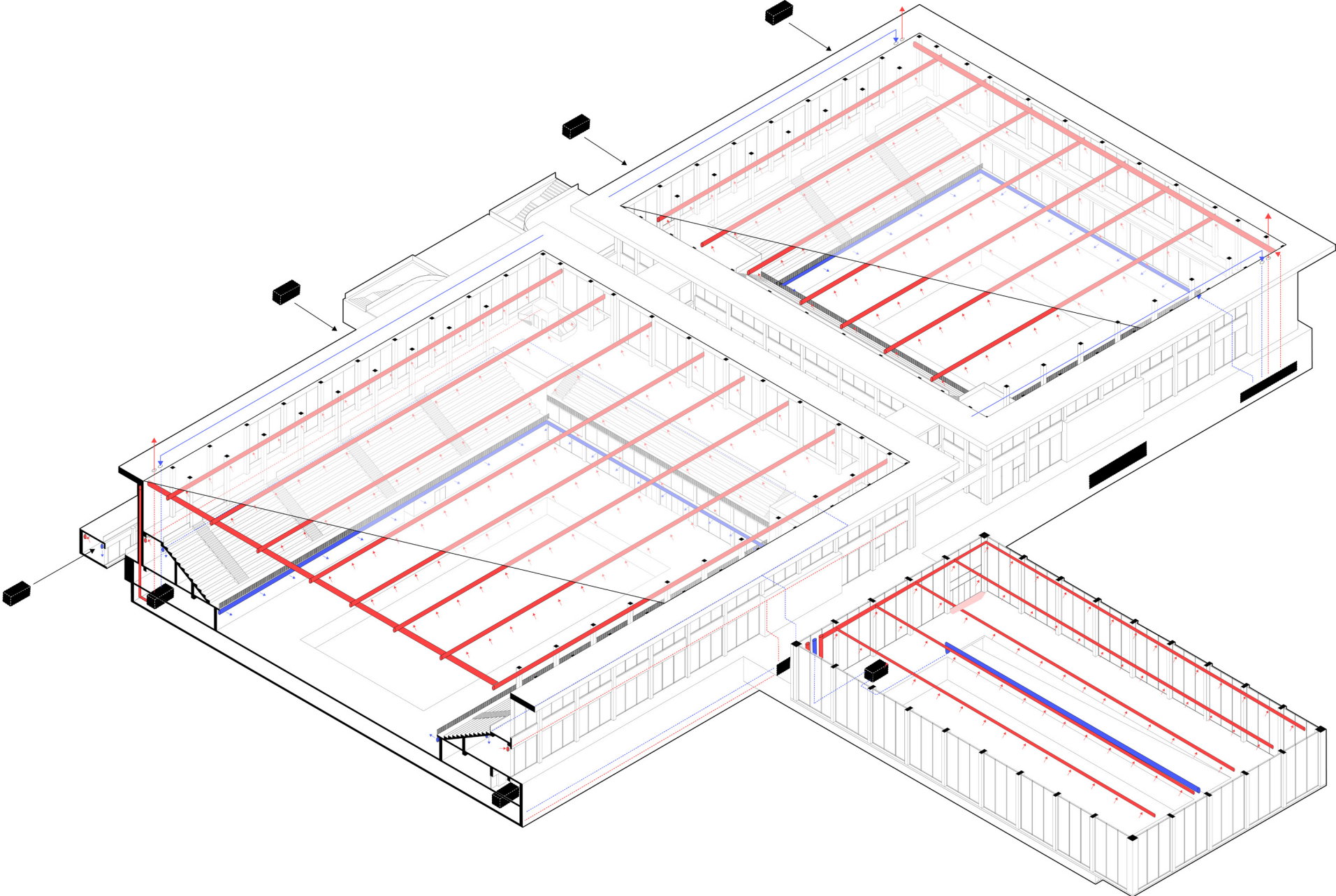

NATURAL VENTILATION

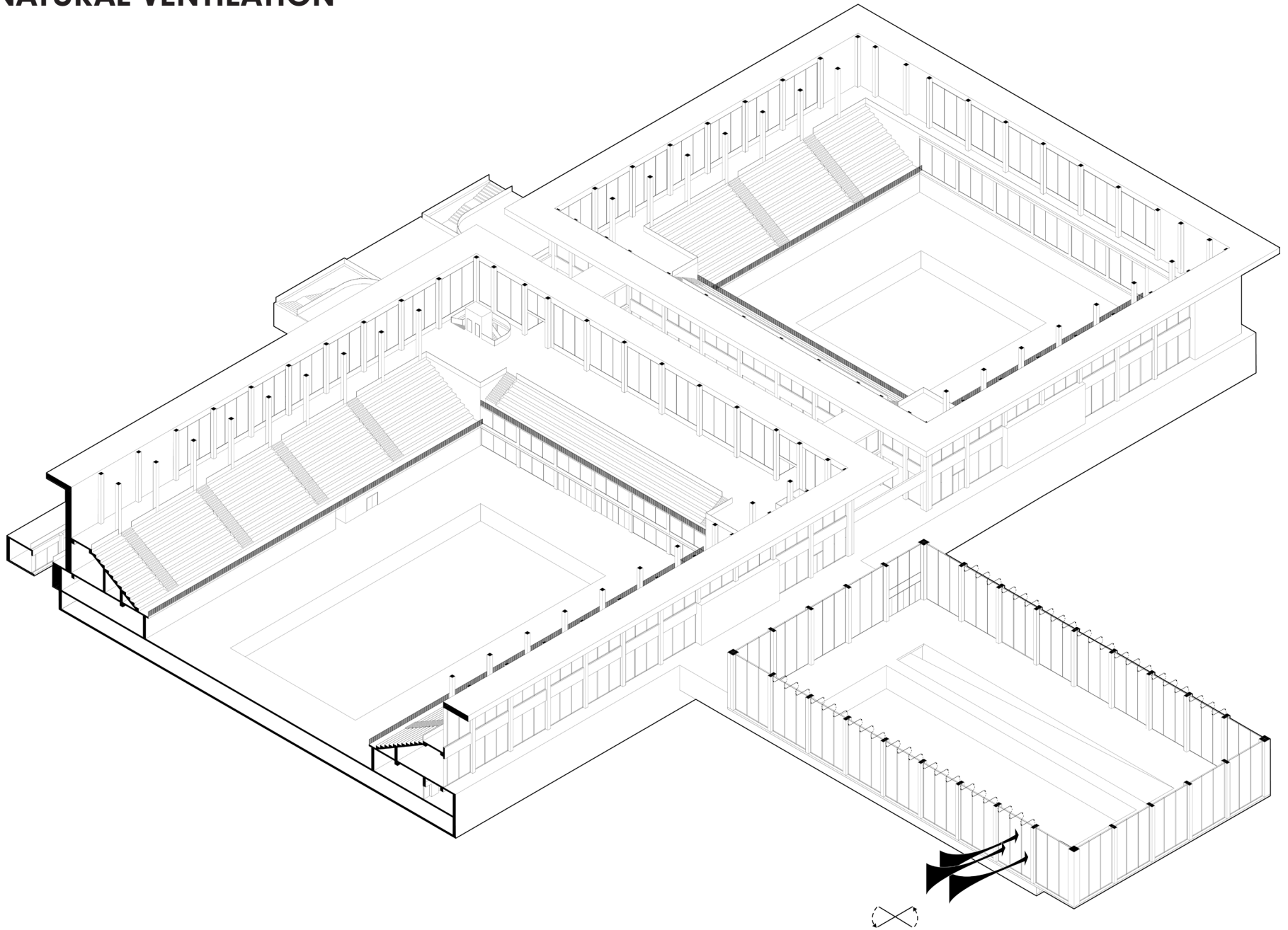

HEATING SYSTEM

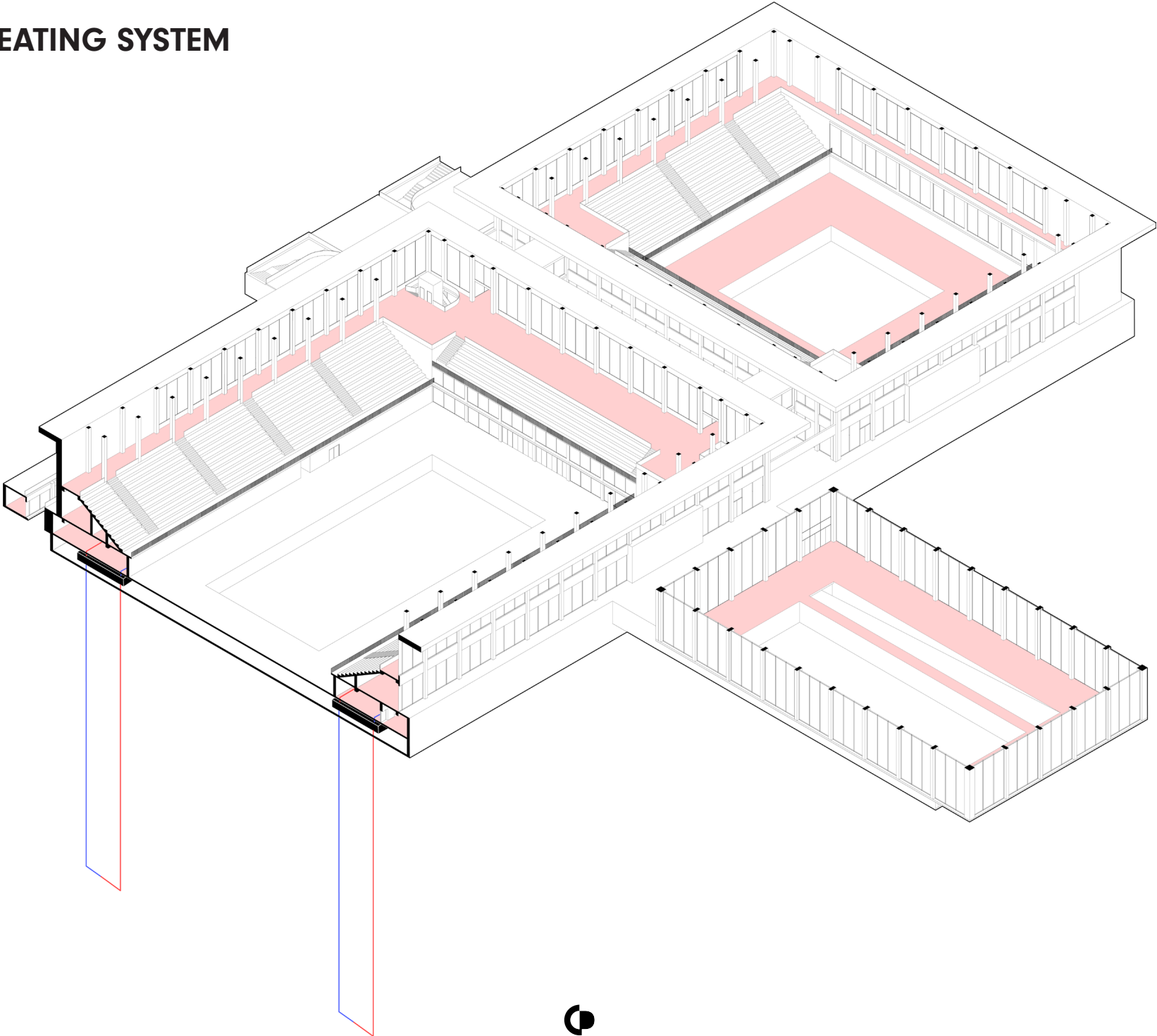

COMPLETE CLIMATE SCHEME

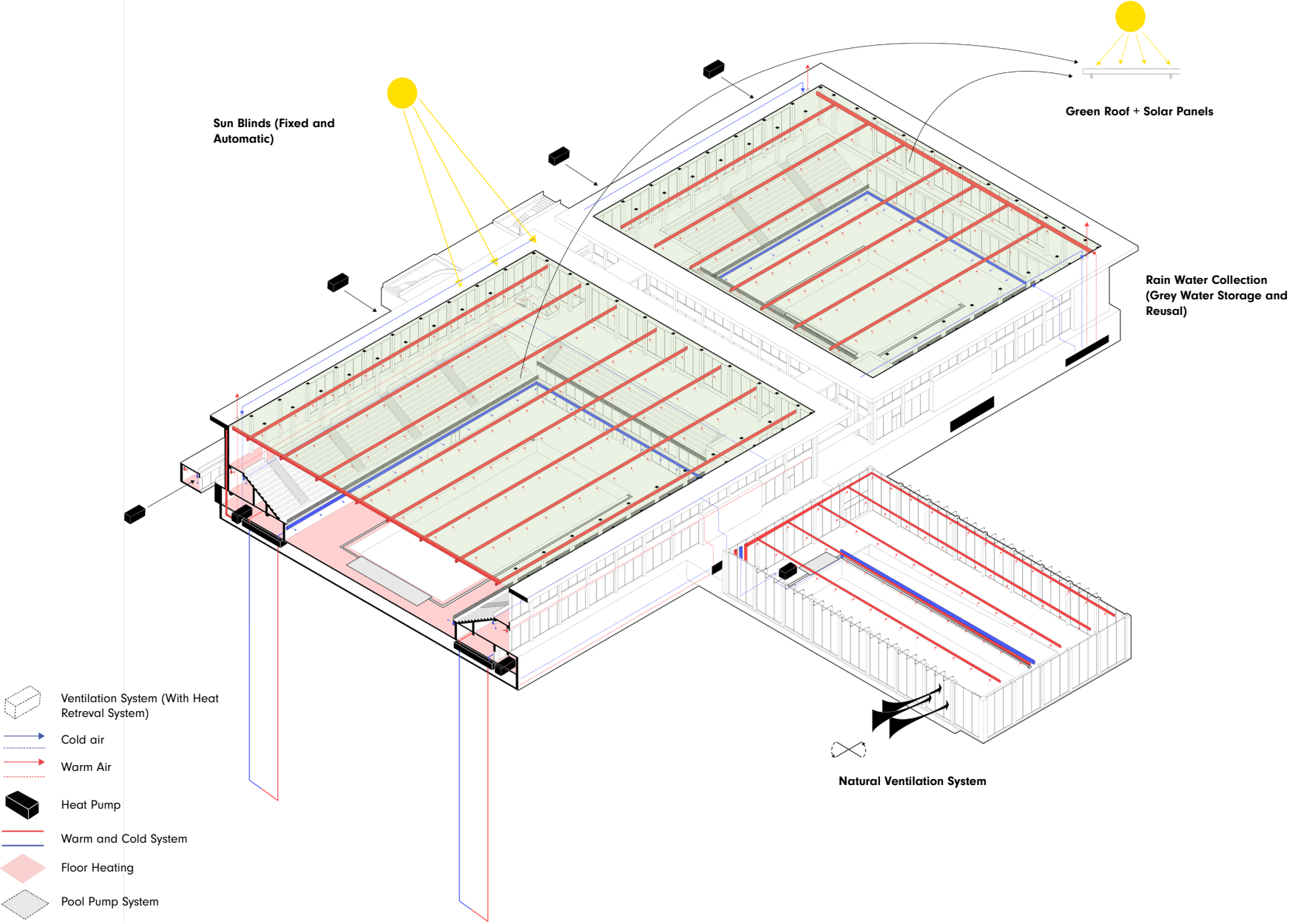

THE SWIMMING POOL

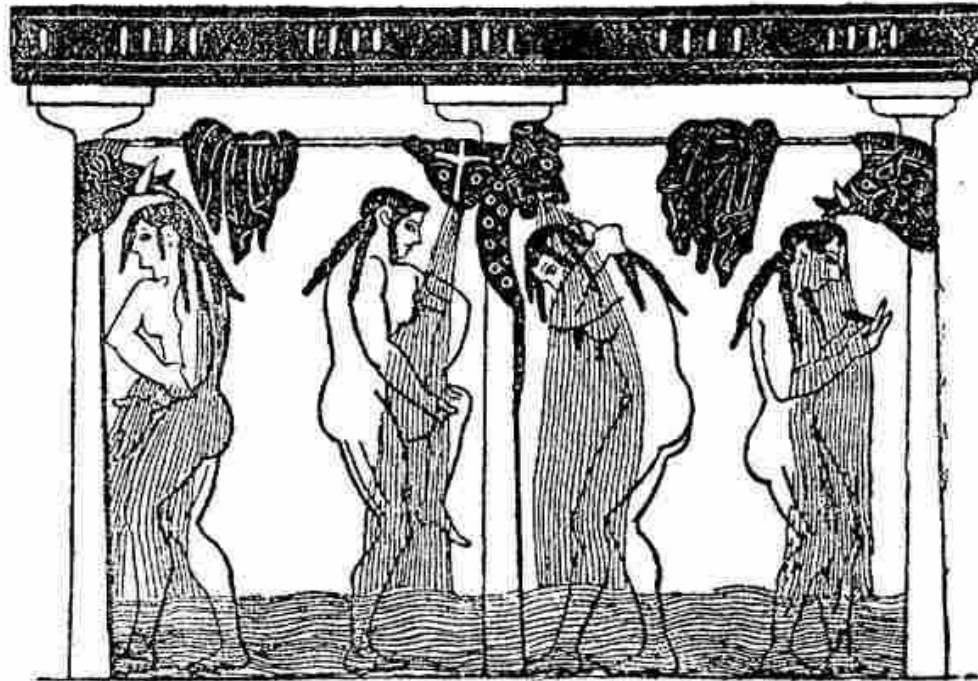

Shower Baths for Women. (From a Greek Vase.)

Greek Society

1700 - 1400 BC



ATHLETES VS. VISITORS

SENSORY EXPERIENCE

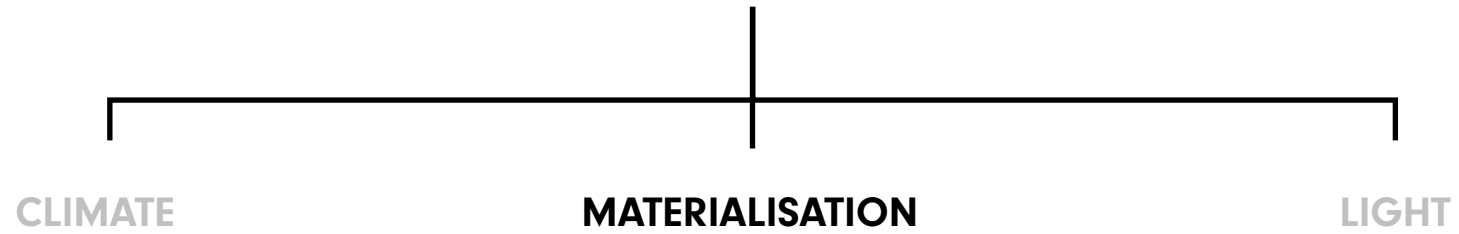

ARCHITECTURAL EXPRESSION



ARCHITECTURAL EXPRESSION

CONCRETE

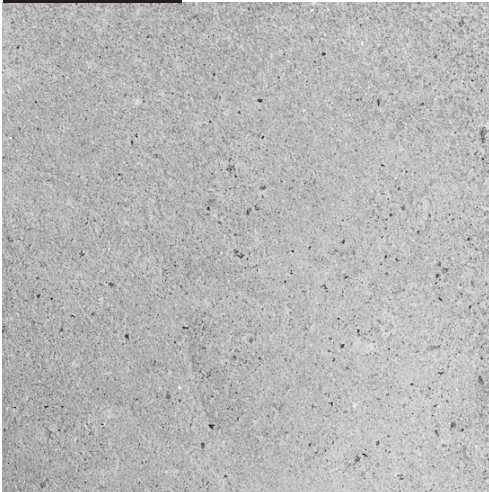

LAMINATED TIMBER



TERRAZZO

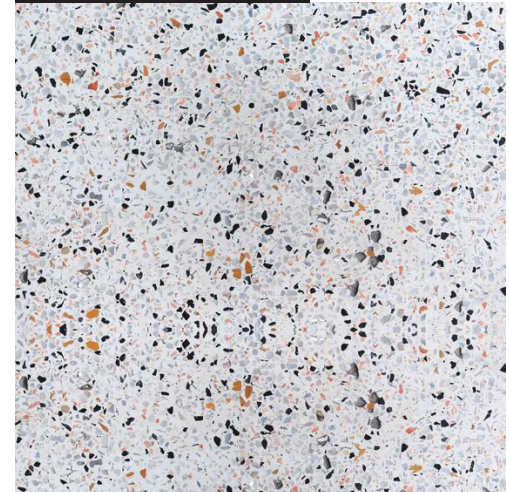

STRUCTURAL CONCEPT

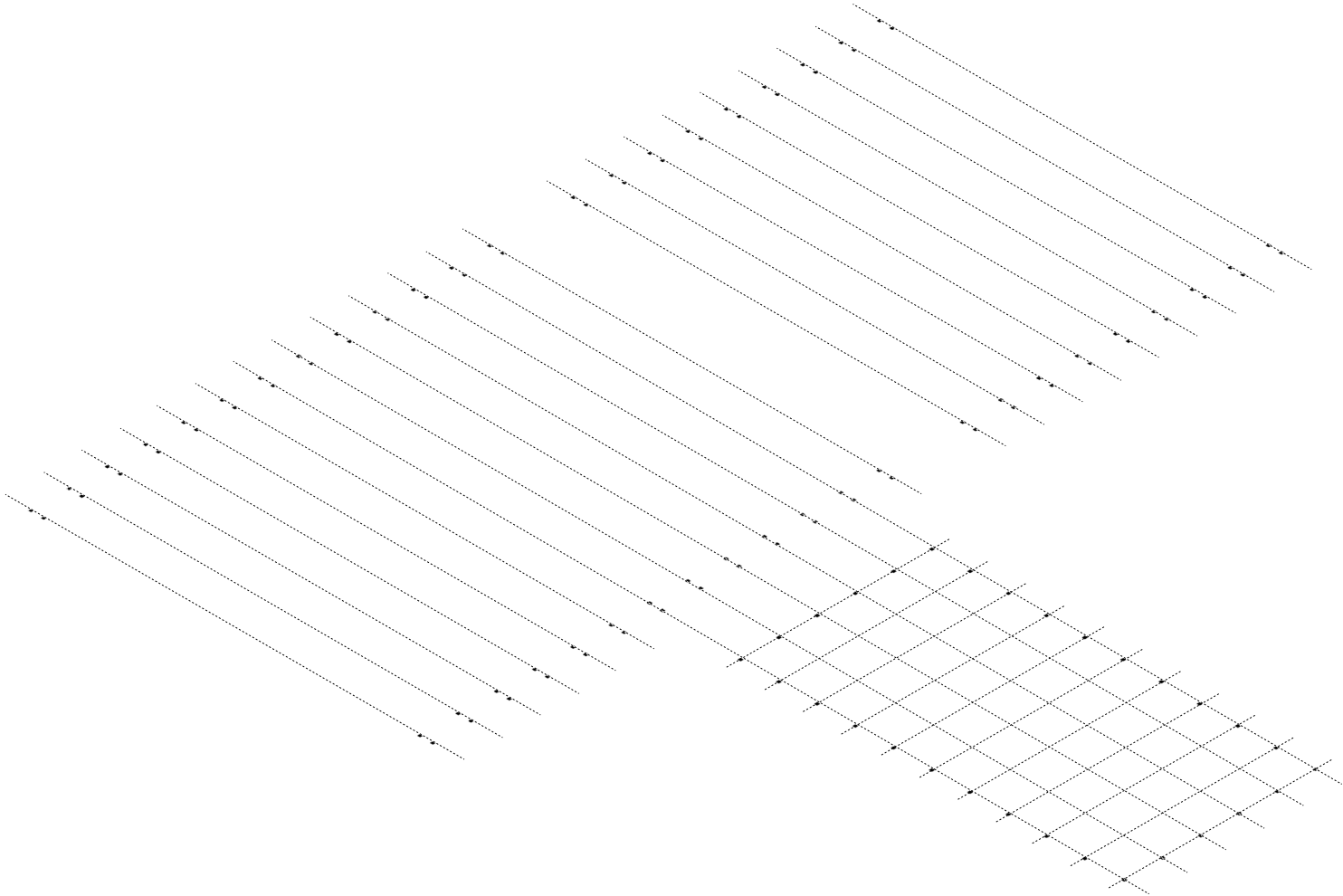

7.5 M GRID



CONSTRUCTION CONCEPT

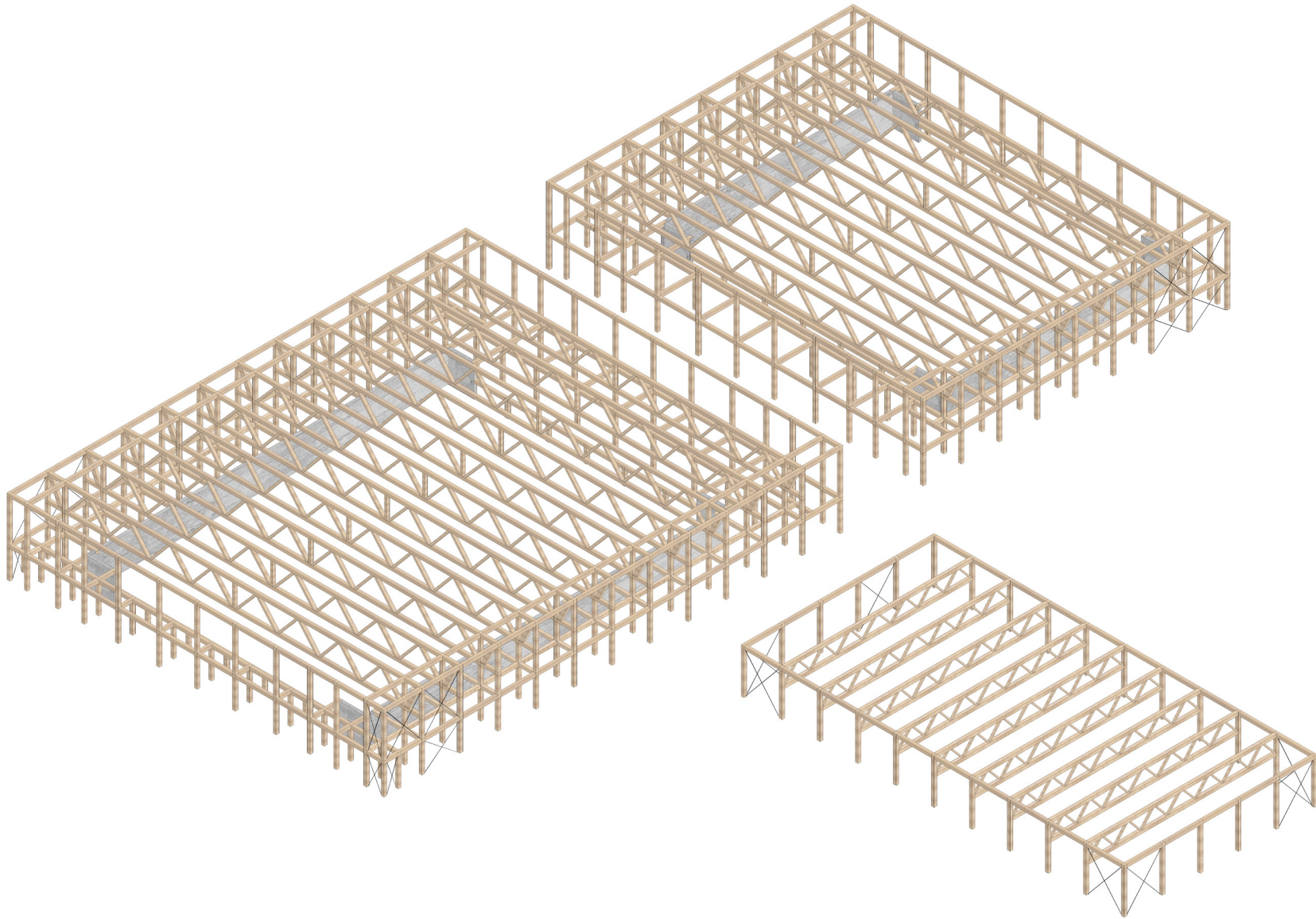

CONSTRUCTION CONCEPT

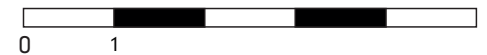
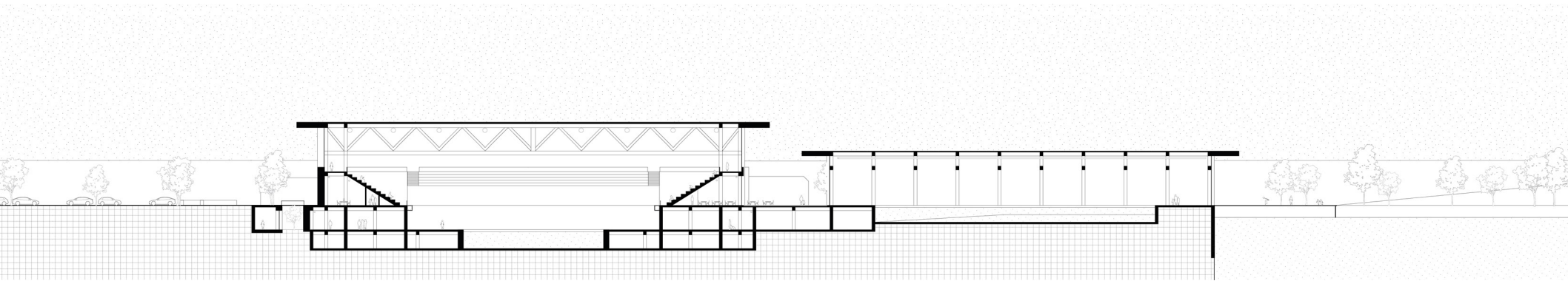

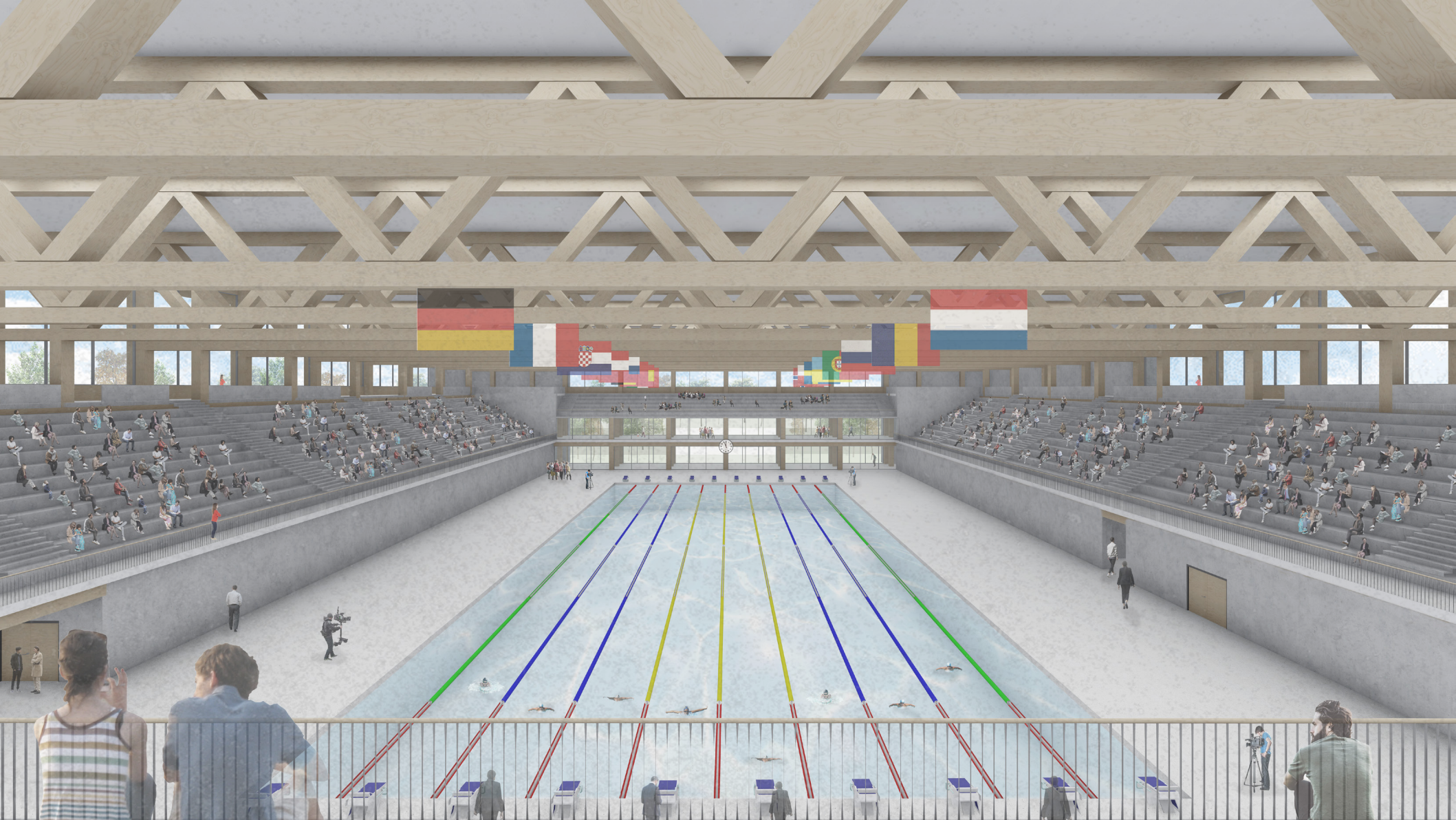

CONSTRUCTION CONCEPT

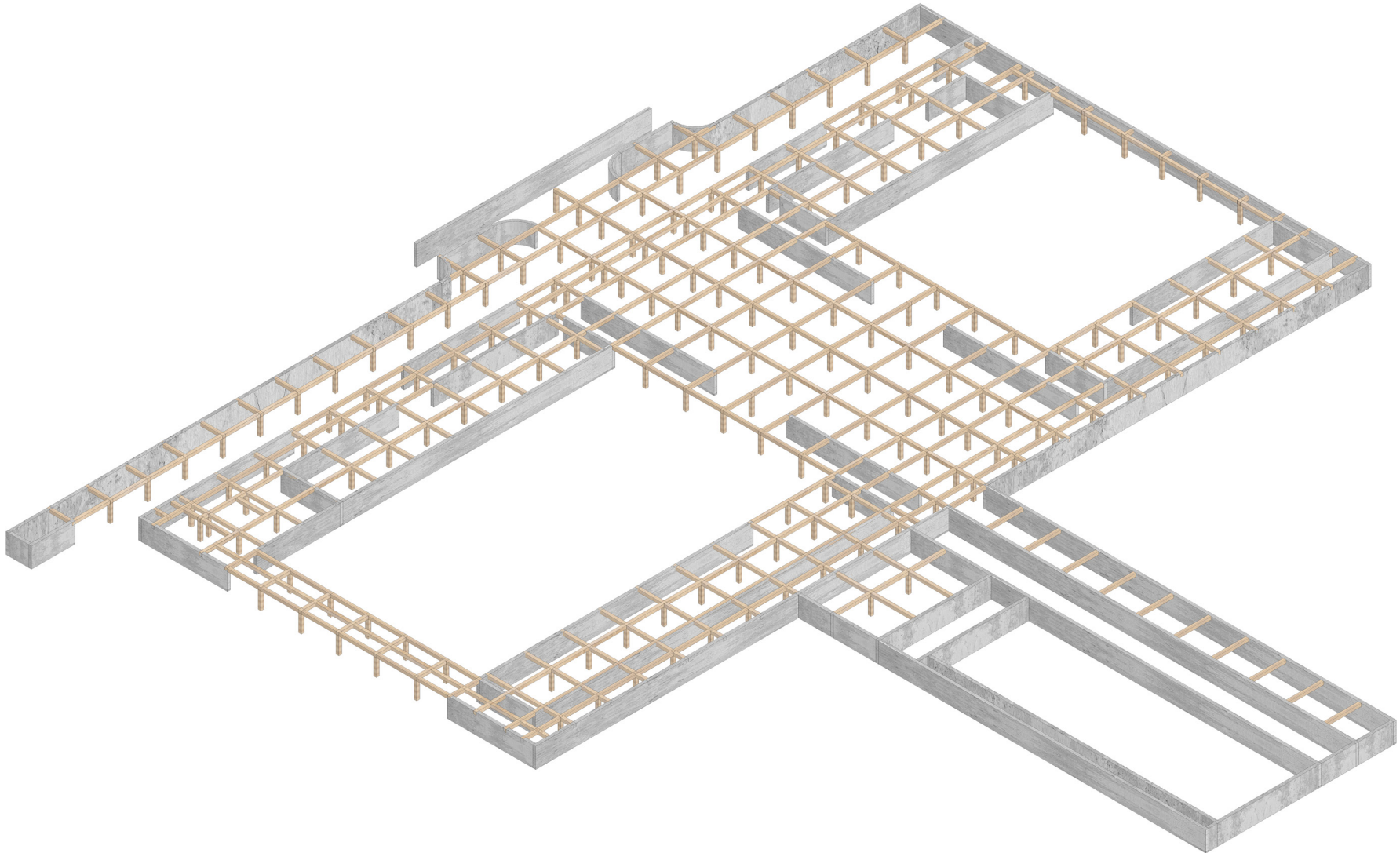

CONSTRUCTION CONCEPT

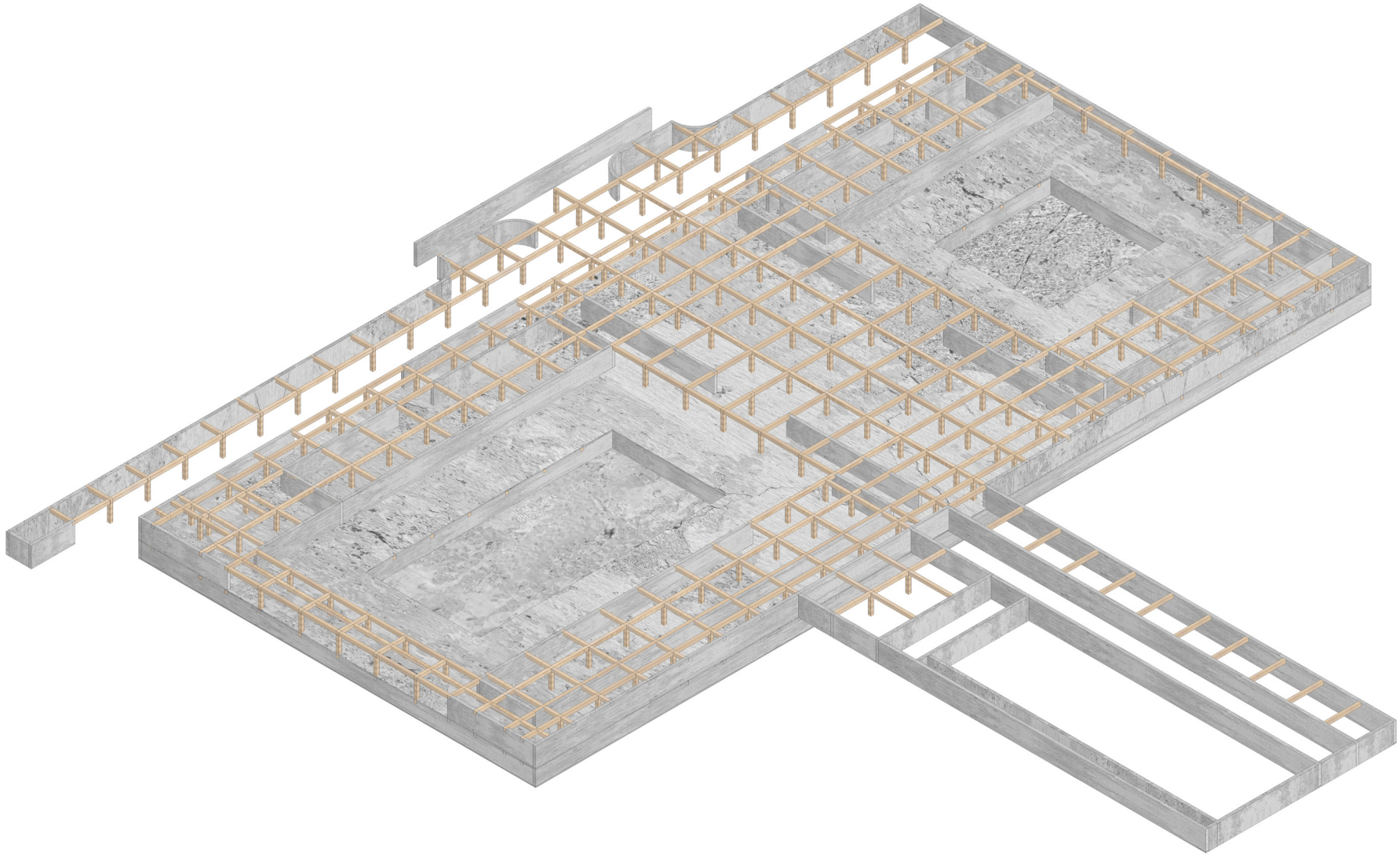

ARCHITECTURAL EXPRESSION

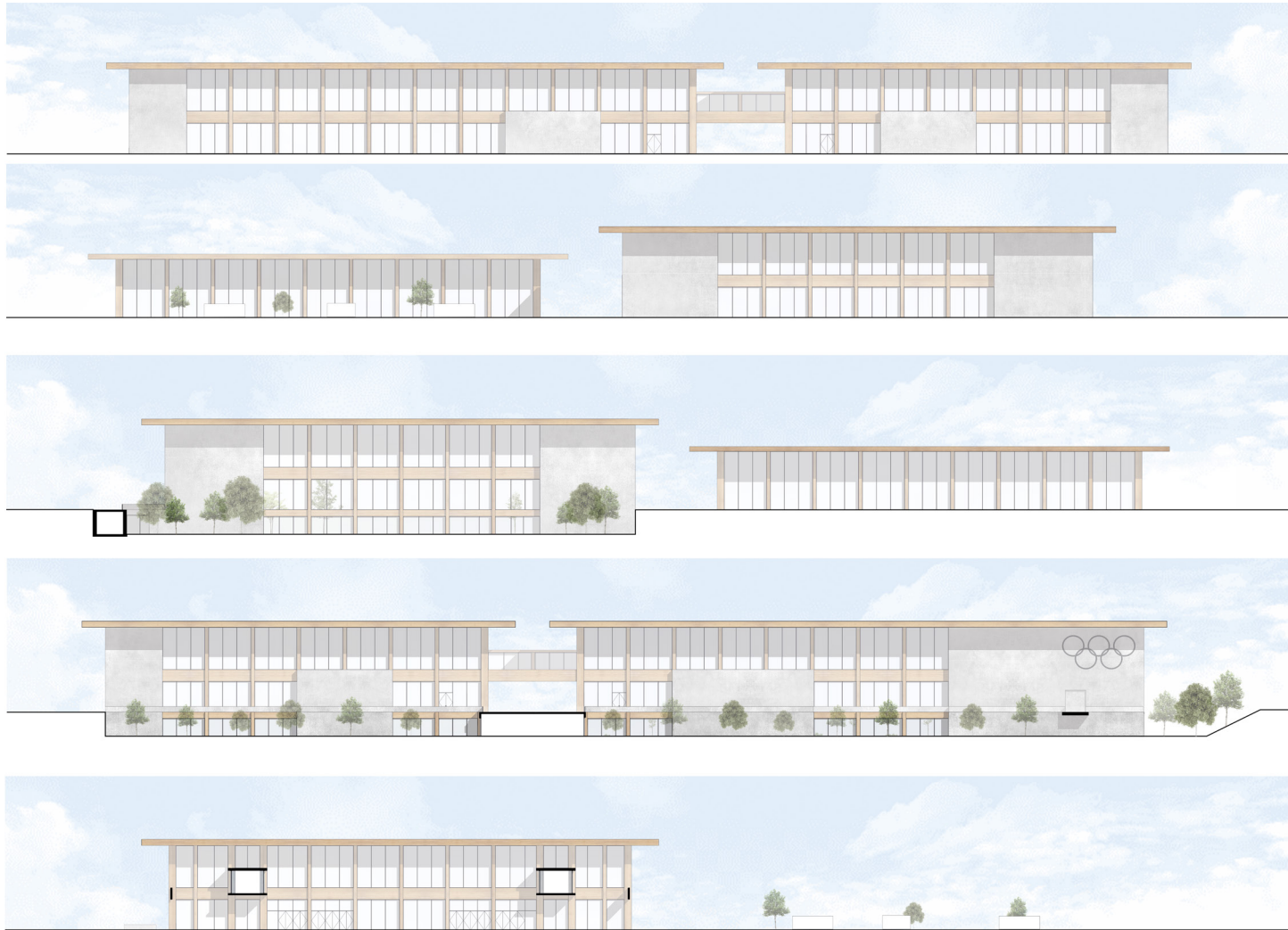

SENSORY EXPERIENCE

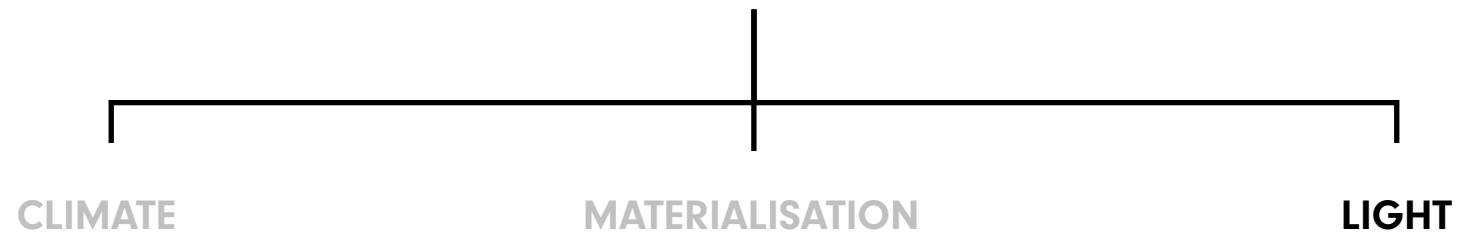





-1 | ATHLETES BASEMENT

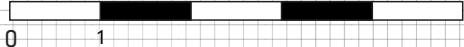
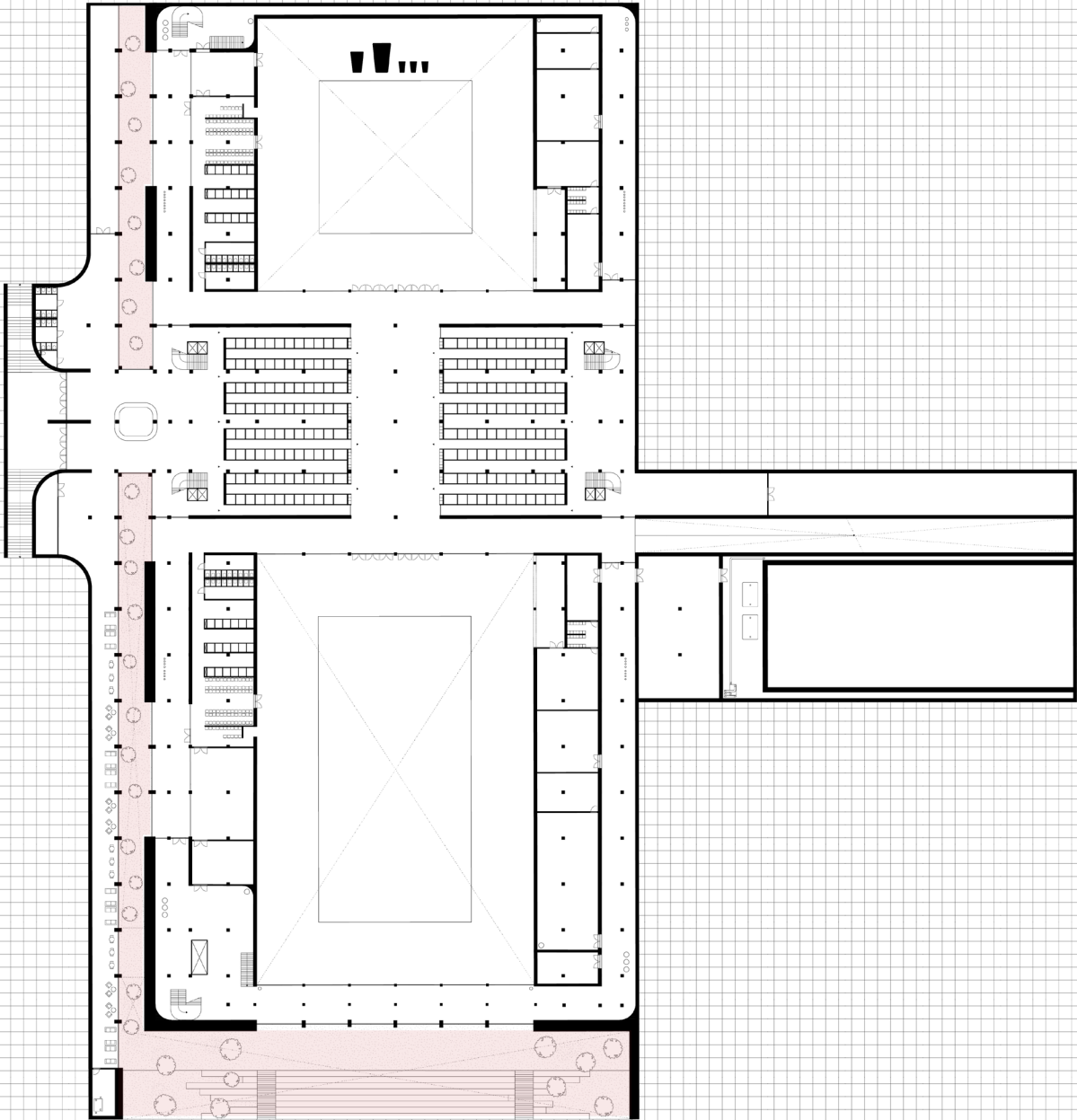

ARCHITECTURAL EXPRESSION

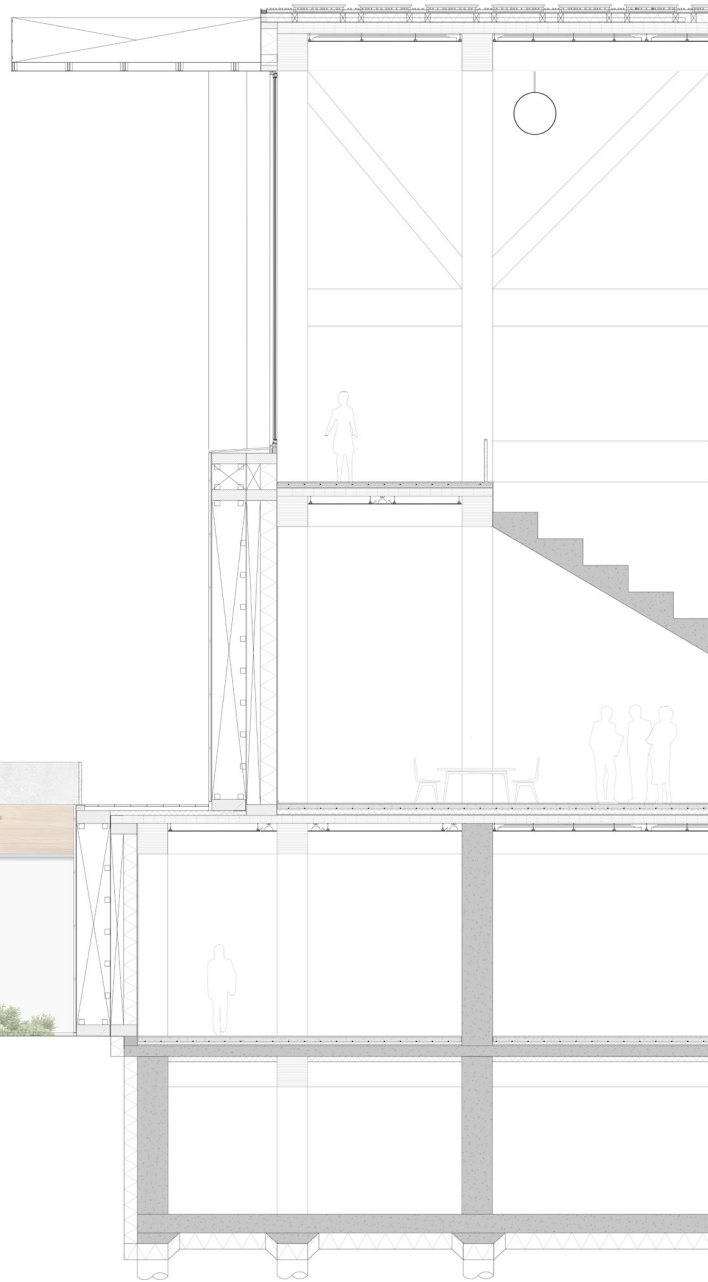





FLWS

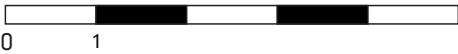
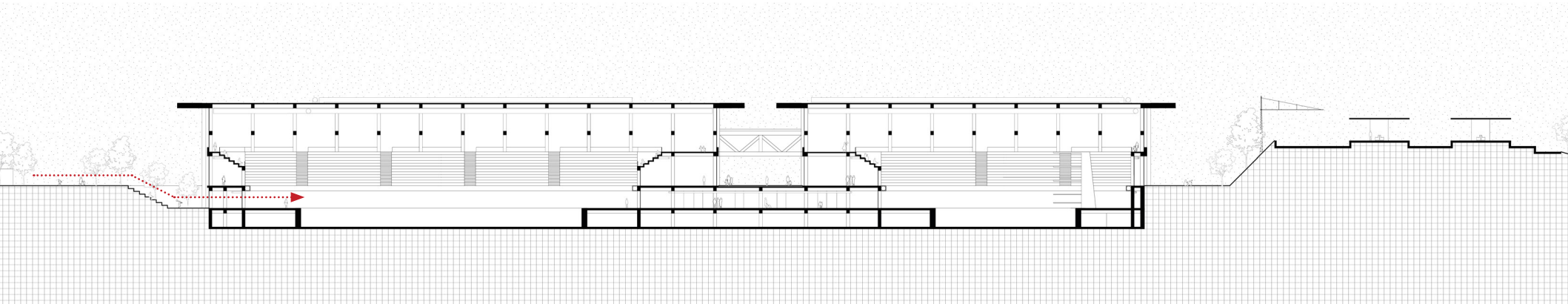



FLAWS

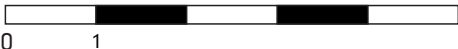
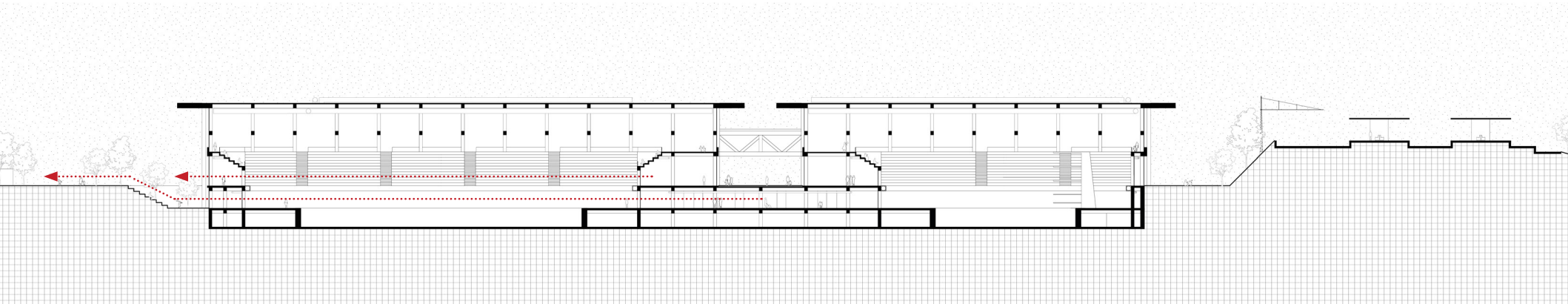



ING POOL

SWIMMING POOL

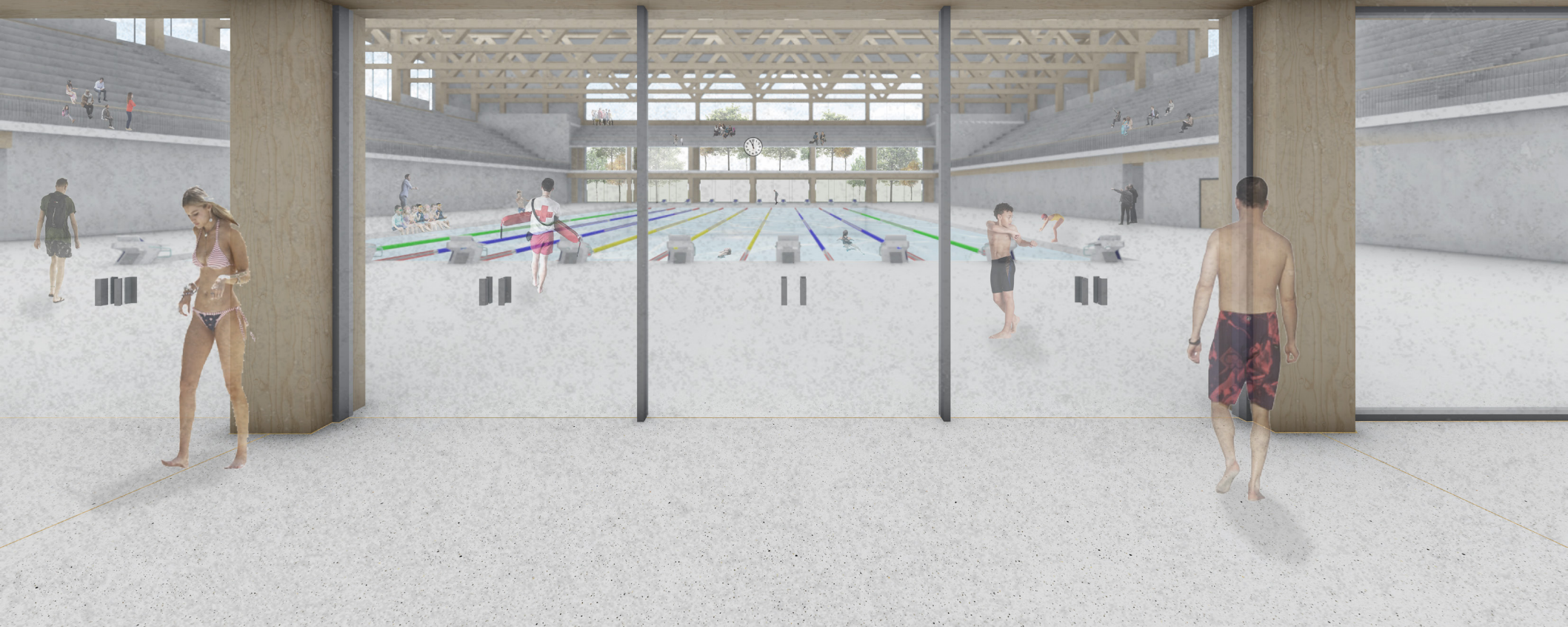



REFLECTION



DESIGN AMBITIONS

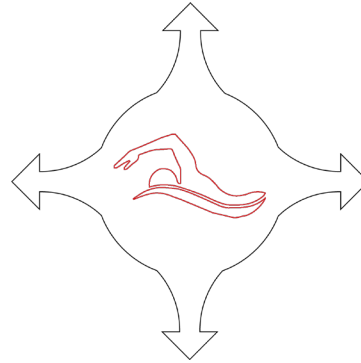

HOW COULD THE PROJECT BE A CATALYST OF URBAN RENEWAL PROJECT?

1

Solve urban complexities or challenges

2

Placed within an area of development

3

Introduce grass-root functions to support neighbourhood and city redevelopment







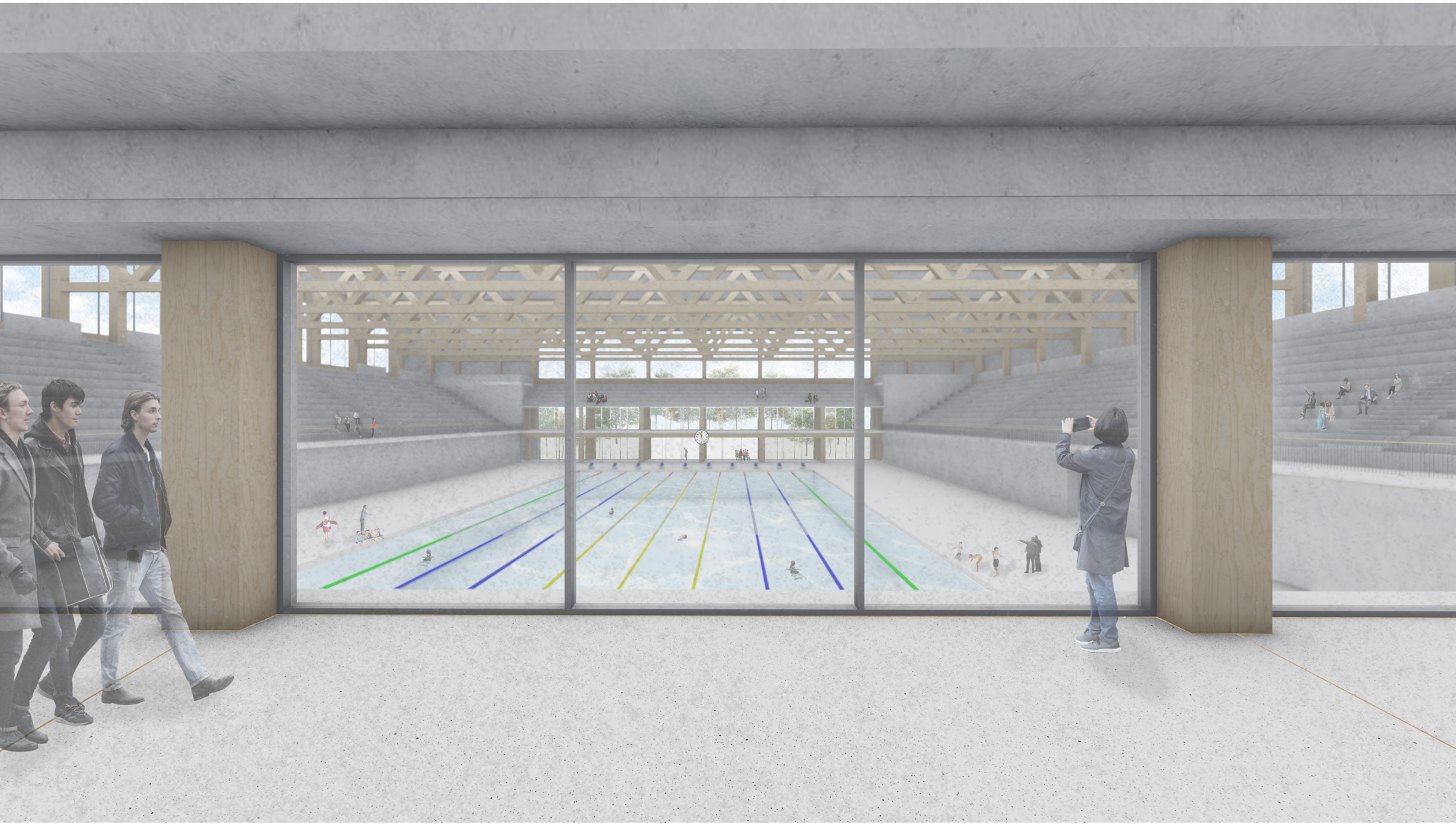

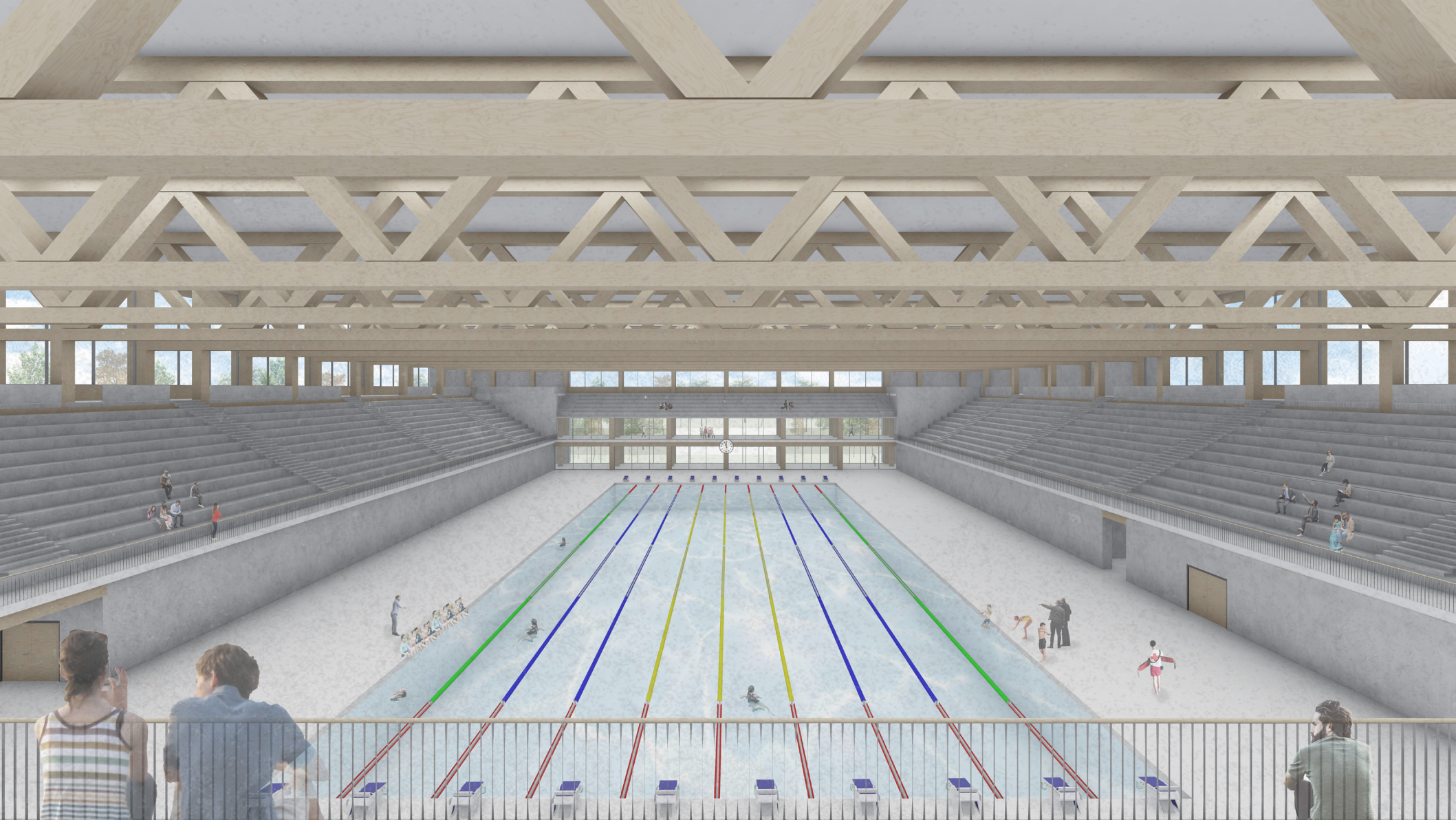

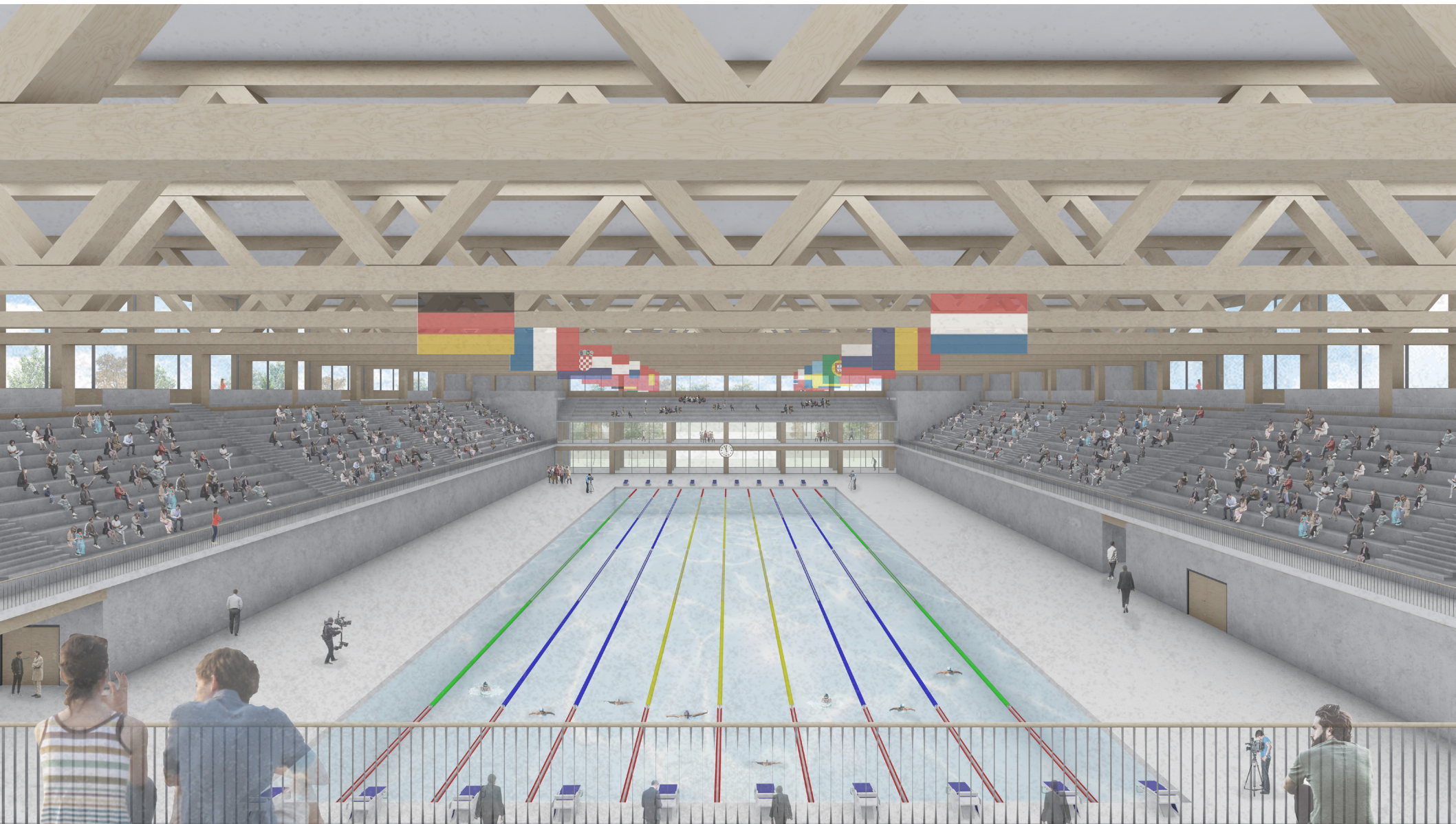







THANK YOU.



complex projects