

The Equipment Journey as a Tool to design safe surgical Equipment for low- and middle income Countries

Electrosurgery used as an example

Master thesis

Larissa Hesselink

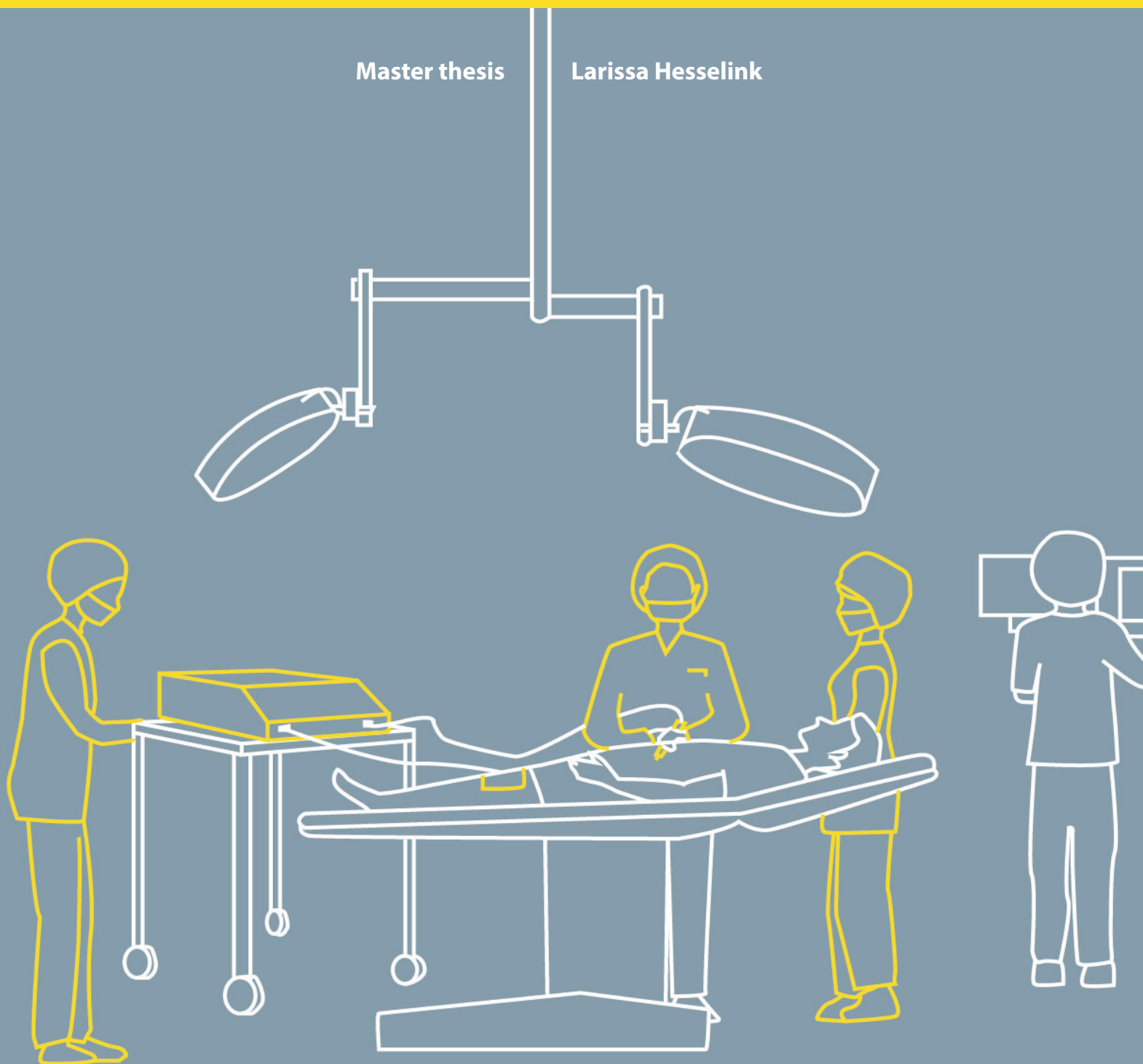

The Equipment Journey as a Tool to design safe surgical Equipment for low- and middle income Countries

Electrosurgery used as an example

Master Thesis - Larissa Hesselink

March 2019

Master Design for Interaction

Delft University of Technology
Faculty of Industrial Design Engineering

Supervisory team

Ir. Oosting, R.M. (client)
Faculty of Mechanical, Maritime and Materials Engineering
Department of Biomechanical Engineering

Dr. ir. Diehl, J.C. (chair)
Faculty of Industrial Design Engineering
Department Design Engineering, section Design for Sustainability

Dr. ir. Sonneveld, M.H. (mentor)
Faculty of Industrial Design Engineering
Department Industrial Design, section Applied Ergonomics and Design

Acknowledgement

This graduation project has been a period of intense learning for me, not only on a scientific, but also on a personal level. I would like to reflect on the people who have supported and helped me throughout this project.

I would first like to thank my supervisory team consisting of Prof. Jan-Carel Diehl, Ir. Roos Oosting and Prof. Marieke Sonneveld for the great supervision and the useful feedback during meetings. The meetings helped me to improve my work and grow as an Industrial designer and researcher.

Furthermore, I would like to thank the Delft Global Initiative for the financial support for my research in Kenya. In addition to improve my skills as a design researcher this project gave me the chance to also grow as a person. Having never visited another continent before, the field trip to Kenya was a great and exciting experience. I would also like to thank Dieuwertje Drexhage who offered me to stay at her apartment for two weeks and who showed me around in Eldoret.

I want to especially thank Prof. Jan-Carel Diehl, Ir. Roos Oosting and Ir. G-Young Van who enthusiastically supported me in preparing my field research and made sure that I felt comfortable during my stay. I value that I could always contact you in case I needed some advice.

One of my personal goals for this project was to further develop my visual design skills. I am very thankful to Joost Kuiper from the TU Delft Design Drawing staff for teaching me how to improve those skills.

And last but not least, I want to thank all the lovely people I met in Eldoret who supported me in organizing my research in the national hospital, and who made this project an unforgettable experience!



Executive Summary

In low- and middle income countries there is a need for safe and affordable high quality surgical equipment. Nowadays, electrosurgical units are part of the standard equipment in operation theatres worldwide, since electrosurgery comes with many advantages such as reduced blood loss. However, the technology of electrosurgery also carries several safety risks such as alternative electrical pathways or current leakage which often have burn wounds as a result. The problem is that electrosurgical equipment is not designed with the low-resource healthcare context in mind. And as research shows many hazardous situations are frequently caused by electrosurgical equipment use in low-resource countries (Oosting, 2018).

The aim of this study is to determine how the low-resource healthcare context triggers safety risks to occur. Therefore, the general technology related risks, the journey of the electrosurgical equipment in terms of activities, and the user characteristics are researched. In the user study special attention is paid to the users' knowledge about electrosurgery.

The research data was collected by conducting a literature study, and by using a qualitative case study approach. In a Kenyan national hospital fourteen surgeries were observed and semi-structured interviews were held with users of the electrosurgical equipment. The data was used to map out the electrosurgical equipment journey including all the phases and activities the equipment is involved in. Additionally, user profiles were created.

The results show that the electrosurgical equipment journey contains seven phases namely the procurement, pre-treatment, surgical treatment, post treatment, maintenance, repair and disposal. The main users of the electrosurgical equipment are the biomechanical engineering technician, the nurse, the surgical assistant, the surgeon and medical students. What is striking is that only the biomechanical engineering technician learned about the principles of electrosurgery during his/her education.

The study results reveal that the interplay of safety risks generally related to electrosurgery, contextual factors, and user characteristics trigger several safety

concerns during the equipment journey. The risks lead from the selection of too high power settings to incorrect placement of the return electrode plate, and not knowing how to react in case of a system error. The study reveals that many of those safety concerns are caused by the medical staff's lack of knowledge about the principles and risks of electrosurgery, and by an interface design that does not consider these user characteristics and needs.

On this basis, a new interface of the electrosurgical unit and additional information stickers for safe equipment use were developed during this project. The equipment journey was used to pinpoint the safety concerns and related root causes that were planned to resolve. Furthermore, the journey helped to determine where the design intervention should be placed.

It is recommended to further develop the design concepts in the future and test their usability with intended users.

The equipment journey for discovering safety concerns appeared not only to be valuable within this project. An evaluation of the equipment journey revealed that the tool is also valuable for other designers and researchers to empathize with the low-resource healthcare setting, and to gain insights into the journey of the equipment and the related safety concerns. Future research should explore if the equipment journey is also suitable for mapping the journey and safety concerns of other surgical equipment.

CONTENTS

CHAPTER	1	Introduction into the Graduation Project	1
		Part 1 - The Equipment Journey	
1.1		Research method	9
		1.1.1 Method part A: Mapping out the equipment journey	9
		Technology related risk study method	9
		User study method	9
		Context study method - Phases and activities	10
		Pinpointing risks within the journey	12
		1.1.2 Method part B: Evaluation of the digital equipment journey	13
1.2		Research Results Part A: The equipment journey	16
		1.2.1 The technology and its potential safety risks	16
		Takeaways technology study	22
		1.2.2 The users' knowledge & concerns about electrosurgery	23
		Takeaways user study	29
		1.2.3 Phases & activities electrosurgical equipment is involved in	30
		Takeaways context study	45
		1.2.4 Pinpointing & assessing risks within the equipment journey	46
		Takeaways risk assessment	53
1.3		Research Results Part B: Digital equipment journey	55
		1.3.1 The digital equipment journey	55
		1.3.2 Evaluation of the digital equipment journey	57
		Conclusion digital equipment journey	60
		Recommendations	60
1.4		Conclusion part 1: Equipment Journey	61

Part 2 - The Impact of the Journey on Design

2.1	Chosen safety concerns and their root causes	63
2.2	Design of the user interface	66
2.3	Information sticker for correct ESU use	73
2.4	Information sticker for correct patient plate use	78
2.5	Information poster for safe electrosurgery	79
3	Final Conclusion	81
4	Discussion	82
	References	83
0	Appendix: Project Brief	85
1	Appendix: Assumption Journey	92
2	Appendix: Interview cards	97
3	Appendix: Evaluation Test plan	99
4	Appendix: Patient Plate study	107
5	Lessons learned	112

Glossary

Active electrode is the part of the electrosurgical instrument that transmits the current during a surgical procedure to the targeted tissue of the patient

Alternating current Current that regularly changes its direction from positive to negative (AC)

Bipolar electrosurgery Electrosurgical procedure in which two active electrodes are integrated into one electrosurgical instrument

Carbonization Charring of human tissue

Coagulation mode Electrosurgical effect in which proteins start to coagulate, and the tissue shrinks

Current Electrical charge quantity that moves past a certain point in one second, Unit: Ampere (A)

Current density Amount of current flow per cross-section area. The higher the current density, the more heat is generated

Cutting mode Electrosurgical effect in which the intracellular fluid is explosively vaporized and the cell walls burst

Desiccation Drying out of biological tissue

Direct coupling Transmission of AC between two electrical conductors when being in direct contact

Electrical resistance / impedance Describes the electrical conductivity of a material. The greater the conductivity the lower the electrical resistance. The resistance of a conductor is the product of the material dependent specific resistance and the length, divided by the cross-section area, Unit: ohm (Ω)

Electrosurgery Application of high-frequency current on biological tissue with the goal of creating a surgical effect through heating

Frequency Rate of periods per second during which the direction of, for example, the current changes; Unit: Hertz (Hz)

Fulguration Non-contact coagulation with arcings above biological tissue

High-frequency generator Device that converts direct current or low-frequency AC into a high-frequency current

Likert scale Scale to measure the probability and impact of safety concerns

Monopolar electrosurgery Electrosurgical procedure in which a handheld with one active electrode is used, and in which the electrical circuit is closed by a return electrode plate

Return electrode plate/ Patient plate Conductive electrode which is attached to the patient during a monopolar surgery in order to close the electrical circuit

Root cause analysis is used for identifying the root causes of faults and problems. A factor is considered a root cause if removal thereof prevents the final undesirable outcome from recurring

Peak voltage Maximum value of a voltage varying in time, in positive or negative direction starting from zero voltage

Power Electrical power is the product of current and voltage, Unit: Watt (W)

Voltage Energy for separating charges, relative to the charge quantity. Unit: Volt (V)

1 Introduction into the Graduation Project

This graduation project is part of Prof. Jenny Dankelman's Global Health project which focuses on developing safe and high-quality instruments for accessible surgery worldwide. The project is a collaboration of researchers from the Biomechanical engineering department of the TU Delft, Kenyatta University (Nairobi, Kenya) and designers from the TU Delft faculty Industrial Design.

Within this Global Health project one of the goals is to develop new safe and high-quality electrosurgical equipment for low- and middle income countries (LMICs).

In LMICs basic healthcare such as surgery is still not available for everyone. Worldwide the shortage of access to basic surgical interventions kills more people than malaria, HIV and tuberculosis put together (Dankelman). There is a need for affordable surgical equipment, such as electrosurgical units, which are designed to fit into the low-resource healthcare context.

The electrosurgical unit is a complex device that has found its way into hospitals all over the world. But even for well trained staff in the Western world the device turns out to be challenging to use (Dankelman). The electrosurgical unit is used to make incisions and cauterize wounds. The surgeon is able to do a precise cut by burning through the tissue using a high-frequency current. After cutting, blood loss is kept to a minimum by cauterizing the wound as quick as possible. Further to reduced blood loss the incision by electrosurgery has the advantage of a reduced incision time and decreased postoperative pain when comparing it to incision by scalpel (Patil, 2018).

Despite the advantages of electrosurgery, research shows that the implementation of the electrosurgical equipment in low-resource healthcare settings is challenging and that the use of the device frequently causes hazardous situations (Oosting, 2018). PhD candidate Ir. R. Oosting from the TU Delft BioMechanical Engineering department interviewed 62 African surgeons about the use of the electrosurgical equipment. With open-ended questions she asked the

surgeons about complications during electrosurgery. These interviews revealed that about 47 percent of those surgeons at least once encountered complications with the electrosurgical equipment in their hospital, such as patient burns, electrical shocks and malfunctioning of the machine.

Thereby, Oosting's study shows that the functioning of the electrosurgical unit in low-resource countries is not optimal and that the safety of electrosurgery should be improved.

Additionally, it is possible that not all the safety concerns regarding electrosurgery in LMICs have been explored yet. Further to self-reported complications, there might be hazardous situations during their practices which could lead to severe risks, but which the medical staff is not aware of.

In order for the Global Health project team to develop not only affordable and high-quality, but also safe electrosurgical equipment for LMICs, it is crucial to get an understanding of the journey the equipment goes through during its lifespan, including all current activities and stakeholders. Further to that all the safety concerns* and root causes within that journey should be mapped out.

When looking at the field of Design and Marketing, journey mapping is a commonly used tool. Customer journeys are a great way of visualizing data and creating valuable insights, and also in the healthcare domain the so called patient journey is proven to be a valuable tool.

Customer journey maps, often also called experience maps, combine two powerful instruments: storytelling and data visualization. A customer journey is a visual representation of a customer's experience with a product or company at various touch points over time (Lemon & Verhoef, 2016). The journey helps designers and other stakeholders to empathize with the needs of their customer, discover pain points that the users



experience, and identify customers' emotions during the journey. This tool is intended to find gaps in the overall experience and accordingly improve the customer's experience (Lemon & Verhoef, 2016). Patient journey maps are very similar to customer journeys, but focus on exploring the interaction between the patient and healthcare providers in all stages of the disease. Patient journeys are intended to map out complex healthcare scenarios, discover the patient's emotions, and pinpoint opportunities for improvement (McCarthy et. al, 2016). In conclusion, these visual representations of customer's and patient's journeys are a good tool to help the designer empathize with the journey of the

user. In this study it will be evaluated if this way of visualizing data is also transferable and valuable for mapping out the journey of surgical equipment.

However, as discussed previously, further to gaining insights into the journey of the electrocautery equipment and the low-resource healthcare context in which it is used, it is important to pinpoint potential safety risks within that journey. This will enable the development team to create design interventions which prevent those risks to occur. The customer and patient journey do not focus on safety concerns related to a specific product and are

not intended to assess risks related to equipment use. Nevertheless, risk assessments are a common practice in product development, especially in the medical domain. Before being allowed to bring a new product onto the market, the Food and Drug Administration (FDA) requires medical device manufacturers to perform usability tests in order to determine use errors and their root causes (Wiklund et. al, 2015). Usually, most manufacturers only test the usability of their products at the end of their development process. At that stage the product design is usually already frozen and mitigations can only be taken with the provision of manuals. As such the mitigation is not embedded in the hardware but only in the instructions. It would be much more efficient and often also more cost-effective for the manufacturer to have insights into the context and potential safety risks right at the beginning of the project.

The root-cause analysis is usually based on participant reported root-causes, known user interface design heuristics, insights from human factors psychology and ideally other contributing contextual factors such as ambient light and sounds, or overall workload (Wiklund et. al, 2015).

Contextual factors have a great impact on product use. However, most commonly usability testing is conducted in a controlled setting, and not in the intended context.

This could lead to wrong assumptions about the context or missed insights especially for intended use settings in LMICs, which are often very different from comparable settings in the Western world.

It is important to gain insights into the context, because the context plays a big role in the occurrence of risks. There are a lot of risks generally related to the technology of electrosurgery. However, different contexts of use can trigger different risks to occur.

Combining journey mapping tools, risk assessment methods and field research

Within this study aspects of journey mapping tools, risk assessment methods and field research are combined to form an equipment journey for risk assessment (see figure 1). The phases and activities of electrosurgery are visually represented in the form of a journey in order to tell an empathetic story. Additionally, the journey includes insights about the product and technology, in this case electrosurgery, and the users. In order to get first-hand information about the context a field study in a Kenyan national hospital is conducted. The interplay of activities, technology, and user insights

reveal safety concerns within the electrosurgical journey.

This project is divided into two parts whereby part 1 is about the equipment journey. This first part again is split into the part A and B.

Part A aims at filling the current knowledge gap and mapping out the electrosurgical equipment journey and its related risks. Therefore, the context, the technology related risks, and the users' characteristics and their concerns are analyzed. The equipment journey is the main contribution to knowledge for the Global Health project.

In part B a visual representation of the data in form of an digital equipment journey is exemplified. This digital equipment journey is intended to serve other designers and researchers as a tool to gain insight into electrosurgery in LMICs without needing to go to the context themselves. In a small evaluation study it is tested if this tool works and fulfills this purpose.

The second part of this report illustrates an example of the impact of the use of the journey on design. The equipment journey is used to resolve some safety concerns by addressing the root causes and pinpointing moments within the journey where a design could intervene most effectively.

As a result a new user interface for the electrosurgical unit (ESU), and information stickers and a poster for safe equipment use were designed.

On the pages 5 and 6 an overview of the project structure is displayed.

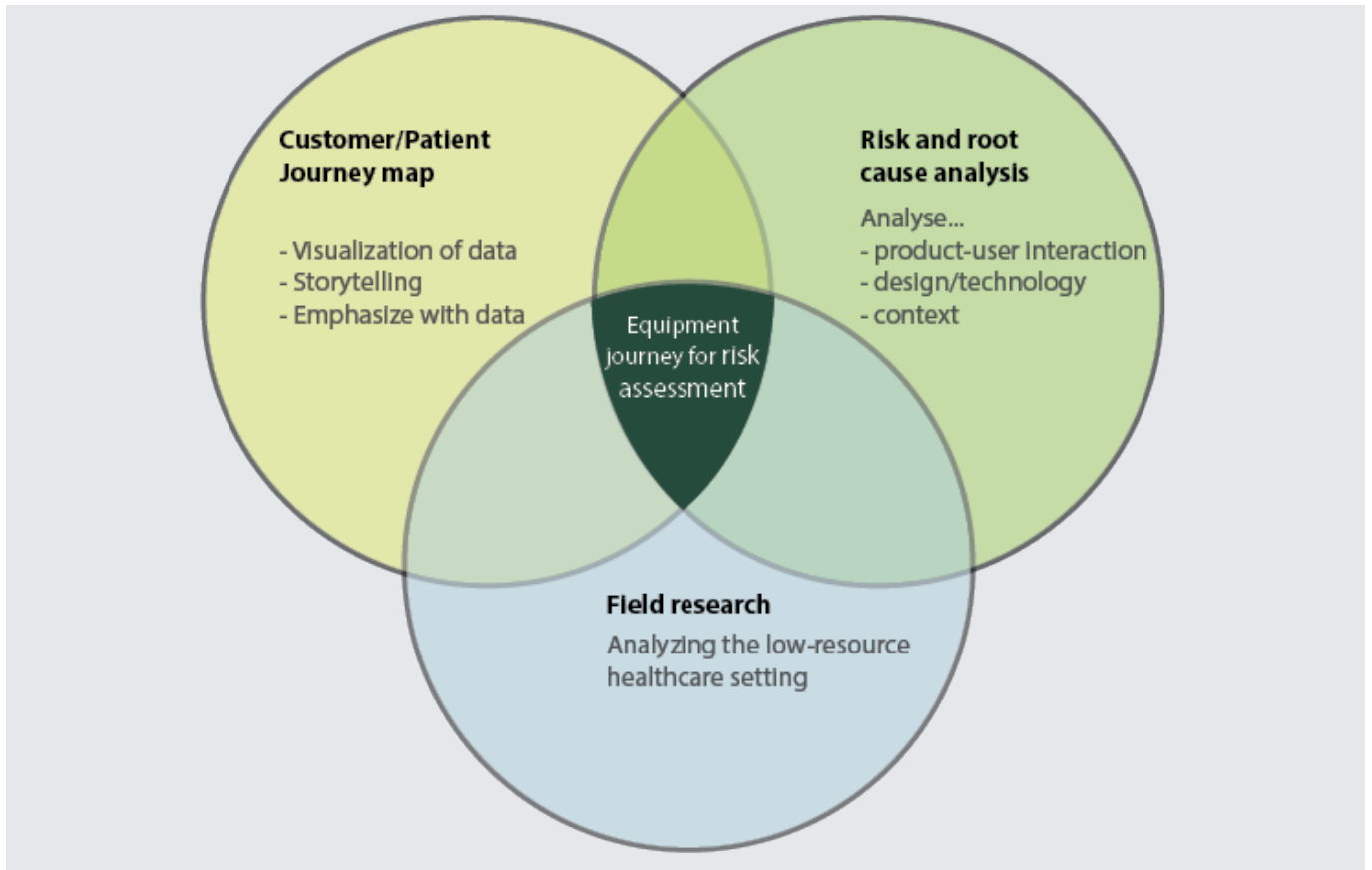

Figure 1: Interplay of journey mapping, risks and root cause analysis and field research

Part 1 - The Equipment Journey

Part A

The goal is to map out the electrosurgical equipment journey and pinpoint the safety concerns within the journey.



1.2.1 The Technology related risks



1.2.3 The context - activities the equipment is involved in



1.2.2 The users' knowledge & concerns



1.2.4 Combining insights to reveal safety concerns (p. 37)

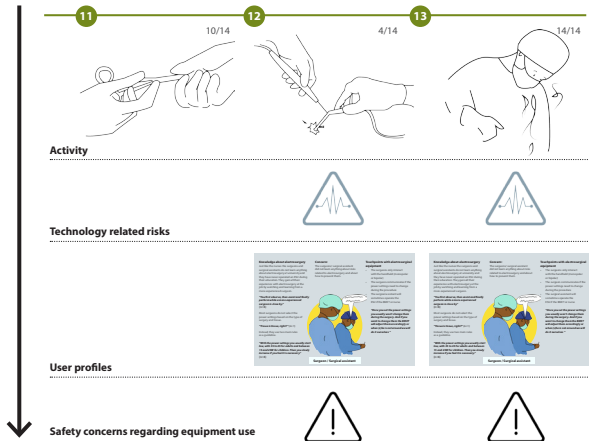

Part B

The goal is to evaluate if the equipment journey is a tool which also helps other designers and researchers to empathize with the low-resource healthcare context and to gain insights into the journey of electrosurgical equipment and its risks.

Part 2 - Example of the impact of the use of the journey on design

In part 2 the impact of the journey on design is illustrated. Therefore, several safety concerns are chosen and mitigated by design. Below an overview of the design concepts is presented.

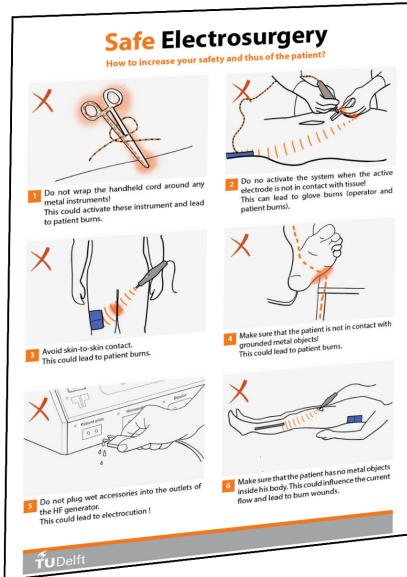

2.5 Information poster for safe electrosurgery

2.3 Information sticker for safe ESU use

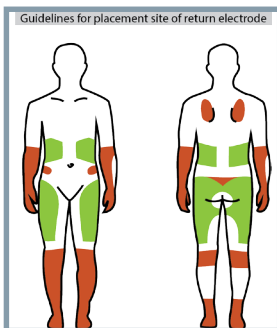
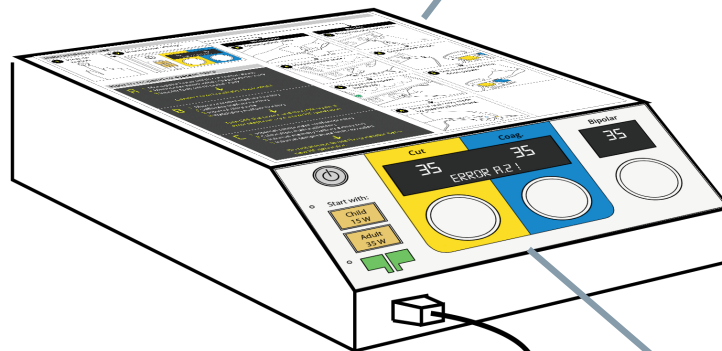
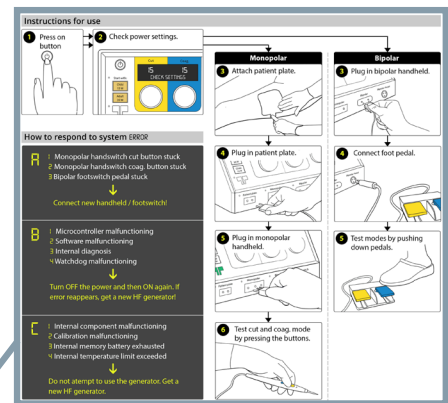

2.4 Information sticker for correct patient plate use

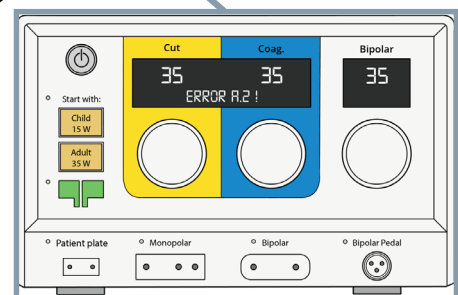

2.2 User interface design



PART

1

The Equipment
Journey

The first part of this report addresses the research concerning the journey of the electrosurgical equipment and the potential safety risks during the journey. In part A the results of the literature study concerning the technology related risks, the user study and the field study will be presented. At the end of this part those results will be combined and used to reveal safety concerns within the electrosurgical journey.

In part B it will be evaluated if the equipment journey serves as a valuable research tool to empathize with the context and to design safe surgical equipment.

1.1 Research Method

Method part A : Mapping out the equipment journey

The methodological approach taken in this study was a mixed methodology. Further to literature review, this study used a qualitative case study approach to investigate the journey of electrosurgical equipment in a low-resource healthcare setting. In this study a national Kenyan hospital was taken as a case study. In order to discover all the risks and their root-causes within this equipment journey data about the technology, the user and the context were collected and combined. In the following paragraphs the research set-ups for the technology, user, and context studies will be presented. At the end of this chapter it will be described how these studies have been combined and how risks have been pinpointed and analyzed.

Technology related risk study method

In order to get an understanding about electrosurgery and risks that come along with this technology a literature study was conducted. Scientific papers and books about electrosurgical risks have been searched on Google Scholar. Additionally, previous graduation

reports on the topic of electrosurgery have been consulted. The literature used does not explicitly focus on risks regarding electrosurgery in LMICs. Instead, the described risks are generally related to electrosurgery and therefore also applicable for Western countries.

User study method

Objective

During its use journey the ESU gets in contact with different stakeholders. The goal of this study is to map out all the users and their touch points with the electrosurgical equipment. Additionally, this study aims at exploring the users' theoretical knowledge about electrosurgery and their concerns about the technology, the use of the equipment and related factors.

Data collection

The data for this user study was collected by doing observations in a national Kenyan hospital and by interviewing the different stakeholders.

During the observations in and around the operation theatres the different users who interact with the electrosurgical equipment were identified. The touchpoints between the equipment and the user were collected by interviews and cross checked by observations.

Observations allow the researcher to see directly what happens during the journey, rather than relying on what people say they do (Cothari, 2004). Interviewees might not tell everything, because they might consider information irrelevant.

In order to find out about the users' knowledge regarding electrosurgery, the use of the ESU, and their concerns semi-structured interviews have been conducted. The interviews were semi-structured to be able to ask follow-up questions to get deeper insights. The users were approached for small interviews during the surgeries, in between surgeries and during the tea and lunch breaks. In order to be flexible the interview questions have been printed on small cards which easily fit into a pocket. Those cards helped leading the conversation and ensured that no important questions were forgotten. It was planned to talk to at least three people of each stakeholder group.

Data analysis

The observation and interview data has been gathered and clustered into related groups to reveal data patterns. Interview answers that did not match with any of the ten observed procedures, were excluded from the analysis. From the data different user profiles were created.

Context study - Phases and activities the ESU is involved in

Objective

The goal of this context study is to explore the different phases the electrosurgical equipment goes through during its lifespan in a low-resource setting. Further to that all the activities within those phases should be mapped out.

Data collection

In order to prepare the field research in Kenya I did some literature research. In 2016 Ir. R. Oosting conducted a study in which she interviewed Kenyan BMETs, local distributors, and medical staff. They were asked which phases the surgical equipment goes through within their hospital and which stakeholders are involved in each phase. Also the electrosurgical unit was considered surgical equipment. The findings revealed three phases, namely, the procurement, the use and the disposal. Within those phases she identified different activities such as maintenance and repair in the use phase.

Furthermore, I looked at the Use Journey of the ESU created by Ir. K. Ouweltjes. As the name already suggests this journey gives a detailed overview of the activities within the use phase of the ESU. He divided the journey into three sub-phases, the pre-treatment, surgical treatment and post-treatment. This journey is based on interviews with Dutch and Kenyan surgeons. I combined the insides from Oosting and Ouweltjes to create an overall overview of the equipment journey of the ESU. Since those findings have been based

purely on interviews, I treated those results with care and considered the overall journey an assumption of the situation in low-resource hospitals. People do not always mention important information, since they might consider them irrelevant. Moreover, they might not even be aware of some things that happen within the context, because they happen so regularly that they become part of a routine.

Nonetheless, this journey formed the basis for my field research in which I evaluated those assumptions. For every phase and action I predefined a set of questions which I wanted to get answered. See figure 2 for an example.

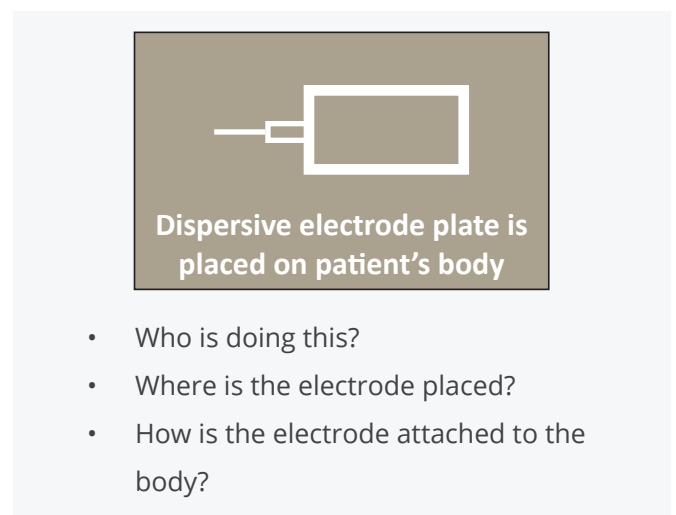

Figure 2: Assumed activity within the use phase

In order to discover all the activities within the use phase, observations of different surgeries were done. It was planned to observe at least ten surgeries. The prepared overview of the assumed activities within that phase and the related questions helped to get an understanding of what I could expect to see. This helped me not to get too overwhelmed by all the new information.

During each surgery every activity and every stakeholder that was involved was noted down. Observation was used as the main method to gather information, since they allow researchers to get a much better understanding of a complex real-world context than by doing interviews with people who have experienced the context (Wilkinson, 2003).

The activities of the other phases have mainly been

researched by conducting semi-structured interviews. It was decided to treat maintenance and repair as phases and not as activities within the use phase such as Oosting proposed. For each the procurement, the maintenance, the repair and the disposal phase a set of cards (see figure 3) was prepared. Those card sets are based on the assumption journey. For every activity within a phase I created a small card. On every card the name of the activity and the stakeholder involved is mentioned. The cards were used during interviews with different BMETs from a Kenyan national hospital. They were asked to lay the cards into the correct sequence and they had the chance to add activities by using the empty cards, or remove an activity if they would not consider it part of the journey.



Figure 3: Procurement, maintenance, repair and disposal cards

Data analysis

For every activity I had an interview card to get more detailed information about the activity with the electrosurgical equipment (see figure 4). For the whole set of interview cards see appendix 2.

The data from the observations and interviews were collected and sorted according to the activity and topic. All the activities were put into chronological order. Additionally, for each activity it was tracked how often it was observed / described.



Donated equipment 	Repair	Disposal - General 
<ul style="list-style-type: none"> • Do you directly receive the donated equipment? • Does donated equipment come with training, manuals and instructions? • How do you get spare parts? • Are there policies on donated equipment? 	<ul style="list-style-type: none"> • Do you repair ESUs when they break? • Who repairs the device? • Do you have access to training and instructions on how to repair the product? • Do you have the needed tools available? • Is it difficult to get spare parts? • What are struggles/ barriers when it comes to reparation? 	<ul style="list-style-type: none"> • When and how do you decide to dispose an ESU? • How and where do you dispose the device? • Do you need permission? • Do you recycle parts of the device? • Do you think it is important to recycle things? • What happens to the products? Is someone picking them up?

Figure 4: Examples of a procurement, repair and disposal interview card

Pinpointing risks within the journey

Layering the context, technology and user studies reveals different safety concerns along the electrosurgical journey. In the journey all the activities in which a stakeholder is involved were pinpointed. For every one of those activities the related user profile was laid next to it to determine if the user characteristics

influence the safety of that activity. Additionally, it was investigated if the technology related risks influence the safety of the the activities within the journey and therefore could form a risk for the user and/or patient. In a last step all the activities which trigger a risk were clustered into categories (see figure 5).

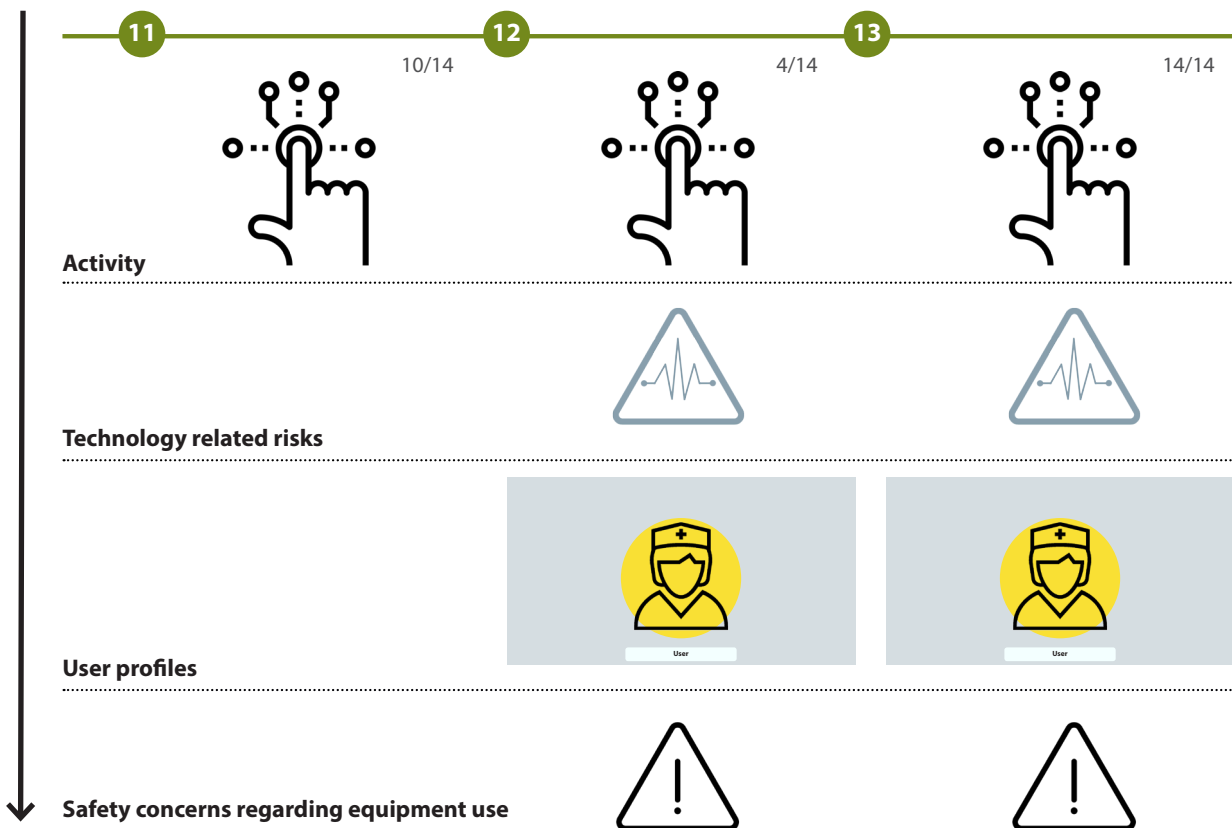

Figure 5: Method defining safety concerns

Method part B : Evaluation of the Digital Equipment Journey

The results from part 1.1 were combined into an online electrosurgical equipment journey. The journey which illustrates all the activities within the electrosurgical journey, the insights from the technology and the user study, and the safety concerns is intended to help other designers and researchers empathize with the context and to provide them with insights from this research.

Digital equipment journey evaluation

Hypotheses

Based on my own experiences with using the journey the following hypotheses have been formulated:

- H1: The equipment journey provides designers and researchers with new insights into the journey of surgical equipment in low and middle income countries
- H2: The equipment journey provides insights in the context and enables the user to empathize with the context and the involved stakeholders
- H3: The journey helps determine risky moments within the context and it reveals insights into moments where they could intervene with a new design
- H4: The journey is also valuable for designers and researchers who are not focussing on improving electrosurgery

Objective

The evaluation of the equipment journey is intended to assess the journey's usability and to test the hypotheses by interviewing potential users. It will be evaluated whether the journey serves as a tool to provide insights into the low-resource surgery setting and if it contains valuable data for other designers and researcher who are working on projects focussing on such a context. This evaluation is also intended to gather participants' feedback on the Journey's design.

Participants

Intended users

The intended users of the equipment journey are designers, design researcher and researchers who all work or plan on working on projects related to equipment in OR settings in low and middle income countries. The intended users have not visited this context yet and therefore have no first hand experience with this setting. The intended users are still in the startphase of the project in which they need to explore the context, define the problem and look for a moment to intervene with a new design.

Participants

The participants of this evaluation will be designers and researchers who have not been in a low-resource healthcare setting before. The participant group can be divided into two sub-groups:

1. Laypeople: Participants who do not have a medical background and therefore do not have much or no knowledge about the healthcare settings. They are currently not working on a project related to low and middle income countries, operation theatres or electrosurgery.
2. Biomechanical engineers: The second group of participants are biomechanical engineers who focus on developing medical instruments. These participants have some knowledge about the healthcare setting and medical equipment, but have never been to an operation theatre in a low or middle income country before.

Evaluation execution

In total 5 evaluation sessions were conducted, three with laypeople and two with biomechanical engineers.

Sessions with laypeople/ designers

At first the sessions with designers/ laypeople were conducted. After welcoming the participant, the facilitator provided a short session introduction and explained the basic principles of electrosurgery by using illustrations. Next, the participant was asked to take around five minutes to fill out an assumption form in which the participant was asked about his/her assumptions about the procurement and the pre-treatment phase. After filling out the form the participant was shortly introduced to the digital equipment journey by explaining the front page and they had the chance to go through the procurement and pre-treatment phase for about 15 minutes. It was decided to only focus on these two phases during the evaluation session, since these phases also provide a lot of insights into the context further to the use of electrosurgical equipment. For someone without any knowledge about the operation theatre context it is more easy to start at the beginning of the journey. The participants were asked to look for new insights within the journey. Furthermore, the facilitator pointed out that the participant could leave comments in the journey. After the participant explored the equipment

journey, the test facilitator conduct an exit interview which was video or audio recorded in agreement with the participant. This interview focussed on evaluating if the participants gained new insights. Next, the usability and added value of the equipment journey in design and research projects was evaluated. Additionally, the interview focussed on gathering feedback on the design of the journey. Refer to the facilitator guide in appendix 3 for a list of questions that the test facilitator asked during the exit interview. For a detailed overview of the evaluation plan see appendix 3.

Sessions with biomechanical engineers

The sessions with the biomechanical engineers had the same structure as the session with the laypeople/ designers. However, there some changes in the equipment for the evaluation were made based on some feedback gathered during the first three evaluation sessions the digital equipment journey. The new version of the journey includes a new front page which visually explains the structure of the whole document and which provides more insight into the methodology used to gather the data illustrated in the journey (see figure 6).

Additionally, it was decided to only focus on the pre-treatment phase during these evaluation sessions,

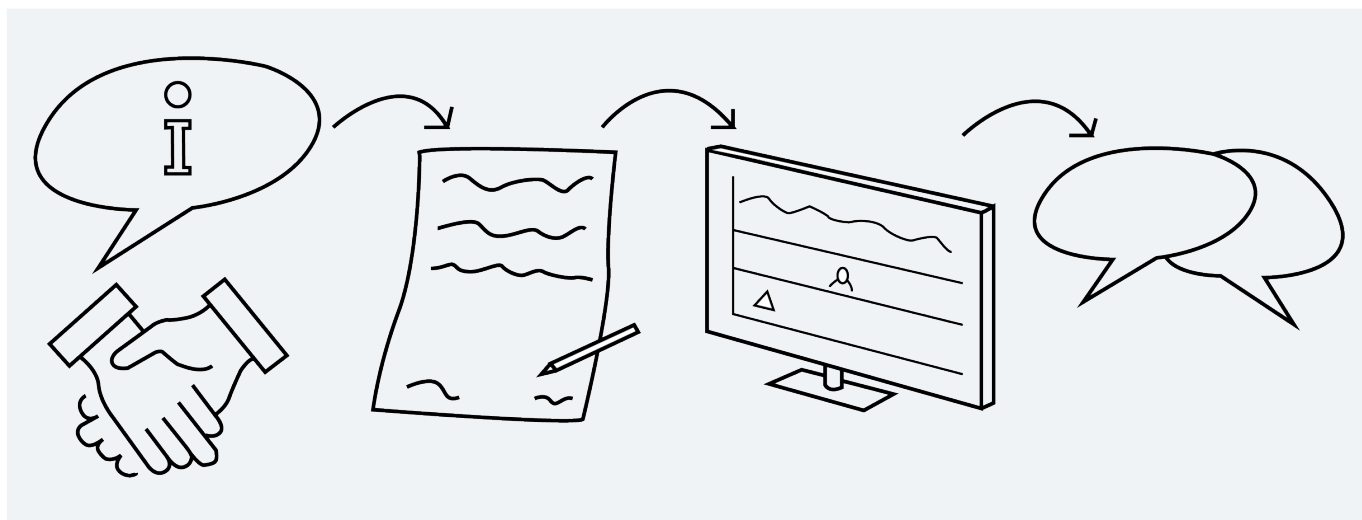

Figure 6: Method digital equipment journey evaluation

because the previous evaluation sessions showed that it took the participants much longer to read through the journey than expected. As a result the first participants did only manage to read around a third of the pre-treatment phase. Moreover, it was decided to skip the procurement phase, because also filling out the assumption form took much longer than 5 minutes.

All the questions concerning the procurement phase were taken out of the assumption form and instead a question about the assumed risks during the pre-treatment phase was added (see appendix 3).

Data analysis

By comparing the responses to the assumption and interview questions it was analyzed if the participants gained new insights.

All the responses to interview questions will be organized into related groups in order to reveal opinion patterns.

1.2 Research Results Part A: Equipment Journey

1.2.1 The Technology and its potential Safety Risks

The basic principles of electrosurgery

Electrosurgery is an effective tool to cut biological tissue and to coagulate it, which means heating up and drying out the tissue. The positive effect of this is that blood loss is kept to a minimum.

Cutting and coagulation are both achieved by heat generated due to a controlled amount of electricity flowing through the tissue (Ouweltjes, 2018).

The electrosurgical circuit

In order to understand electrosurgery one needs to have a basic understanding of electricity. The electrosurgical unit uses an electrical circuit to achieve its surgical effects. In this case the HF generator is the voltage source, the electrical switch is a foot or handswitch, and the patient's body is the main resistor (see figure 7).

The voltage source, in this case the HF generator, causes a flow of electrons called current and is expressed in

Reminder research method

Objective:

Analyzing the technology and its potential safety risks

Method:

A literature study was conducted. Scientific papers and books were searched on Google Scholar. Additionally, previous graduation reports were used.

ampere (A). The effect on the tissue being exposed to electricity is an increase in temperature depending on the amount of power, resistance of the specific tissue, and duration of exposure. The amount of power can be controlled via the HF generator. Therefore, the user can set the maximum power in Watt that may be delivered by the system. The power required for a certain effect varies between the different tissue types due to differences in thermal properties and

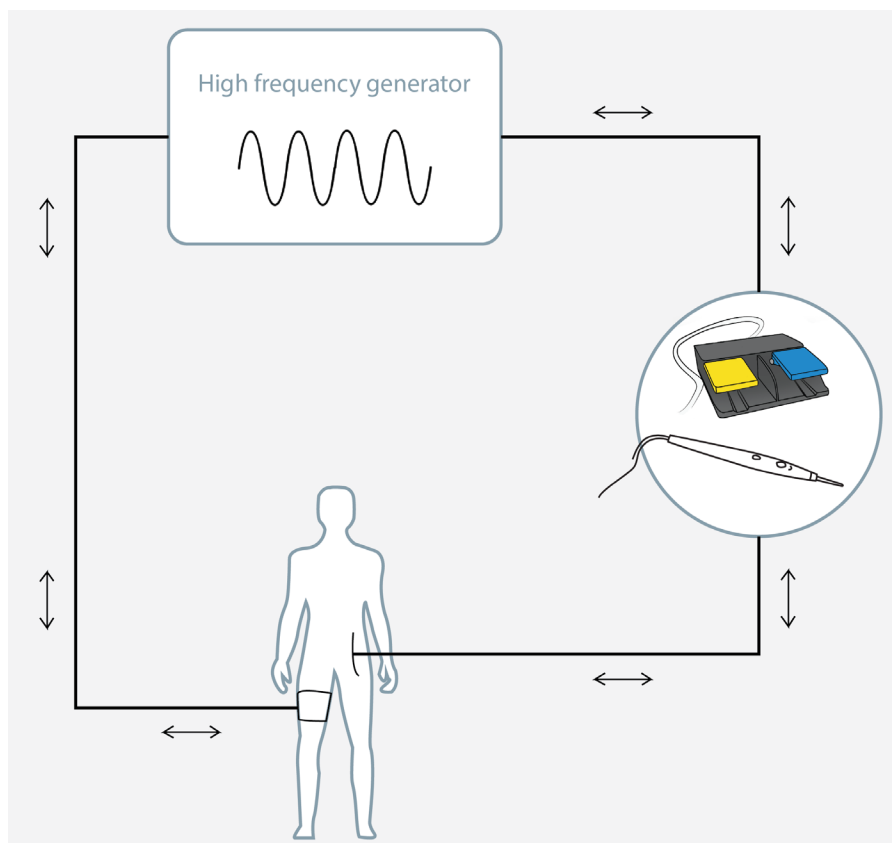

Figure 7: Electrical circuit

electrical resistance, also known as impedance (Convidien, 2008). The impedance of a certain tissue type is dependent on the fluid concentration within the tissue and on the virtue of age and lifestyle of the person. For example blood, which is considered a connective tissue, has a high concentration of fluid, which results in an increased conductivity and thus a reduction of impedance (Ouweltjes 2018). In figure 8 different tissue types and their impedances are shown.

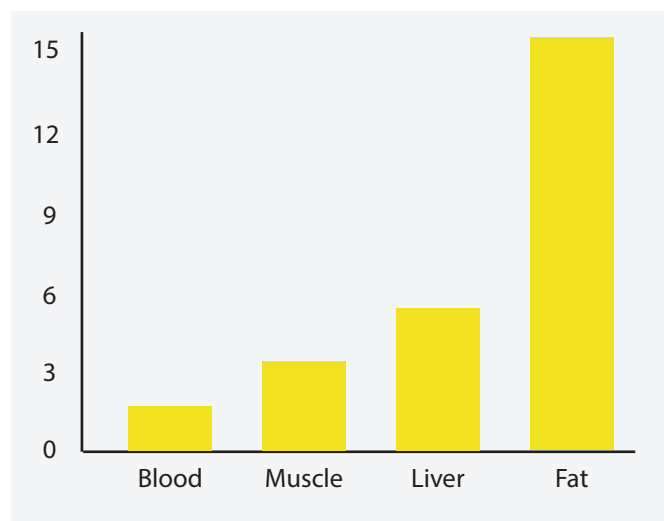

Figure 8: Tissue types

Electrosurgery makes use of alternating current (AC), which means that there is actually no flow of electrons, but rather an oscillation. So current is constantly changing its direction. The used alternating current does not shock the patient due to its frequency. Electrosurgery uses a high frequency of 200 kHz to 3.3 MHz to prevent neuromuscular stimulation or electrocution. Low frequencies would interfere with the function of the cell and would result in those hazardous effects (Massarweh et. al, 2006).

Voltage waveforms

The tissue effect is largely influenced by the voltage waveform. The two main waveform modes being used are cut and coagulation.

A cut waveform has a continuous relatively low voltage waveform (see figure 9). It rapidly warms up the tissue, using sparks, which can only form when the voltage is above 200 volt. This results in the vaporization of the intracellular fluid and rupture of the cell. This causes a clear cut.

In contrast, a coagulation waveform consists of a relatively high peak voltage waveform that is only

activated for about 6% of the time (see figure 9). This results in the surrounding tissue being heated with intermittent spikes and a cool down of the tissue in between, resulting in cell dehydration. The cell forms a coagulum via the clotting of proteins. This can be achieved with little, if any, scarring (Massarweh et. al, 2006).

The two waveform modes cut and coagulation are distinguished by color codes. On the HF generator and on the hand- and footswitch the cut mode is always highlighted in yellow and the coagulation mode in blue (Ouweltjes, 2018).

Alternative modes can usually be found within one of these two modes, depending on which mode it resembles most. Other modes are for example the blend mode, which is a combination of cutting and coagulation. In this case the activation time and voltage are adapted.

Two other tissue effects are fulguration, also known as spraying or non contact coagulation and desiccation, also known as direct contact coagulation (Ouweltjes, 2018).

Monopolar electrosurgery

There are two types of electrosurgery: Monopolar and bipolar. In this case mono and bi refer to the number of poles being part of the hand-held device.

The most commonly used type is monopolar electrosurgery. A monopolar hand-held only contains one electrode, namely the active electrode. The other electrode is a relatively large dispersive plate, also known as the patient return electrode, patient plate, or dispersive electrode. This patient plate needs to be placed on a well vascularized area of the body, like for example the upper leg. Both electrodes are directly connected to the HF generator and thereby close the electrical circuit. The patient plate ensures that the current that enters the patient's body via the active electrode also leaves the body again (Ouweltjes, 2018). The active electrode can be activated by hand- or footswitch. The reason why only the tissue near the active electrode is affected is that the contact area of the patient plate is many thousands of times larger than that of the active electrode. The amount of current between the two electrodes remains the same, but the current density is over a thousands of times smaller at the dispersive plate compared to the active electrode. As a result the heat will be highly concentrated at the active electrode and highly distributed at the patient return electrode. Therefore, it is important that the

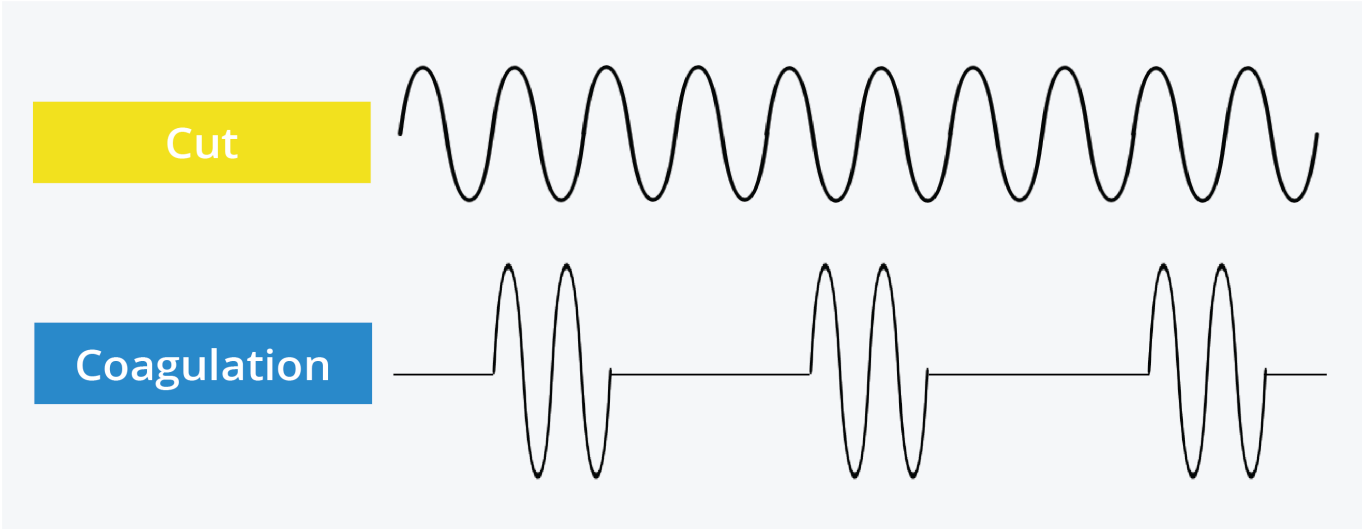

Figure 9: Tissue types

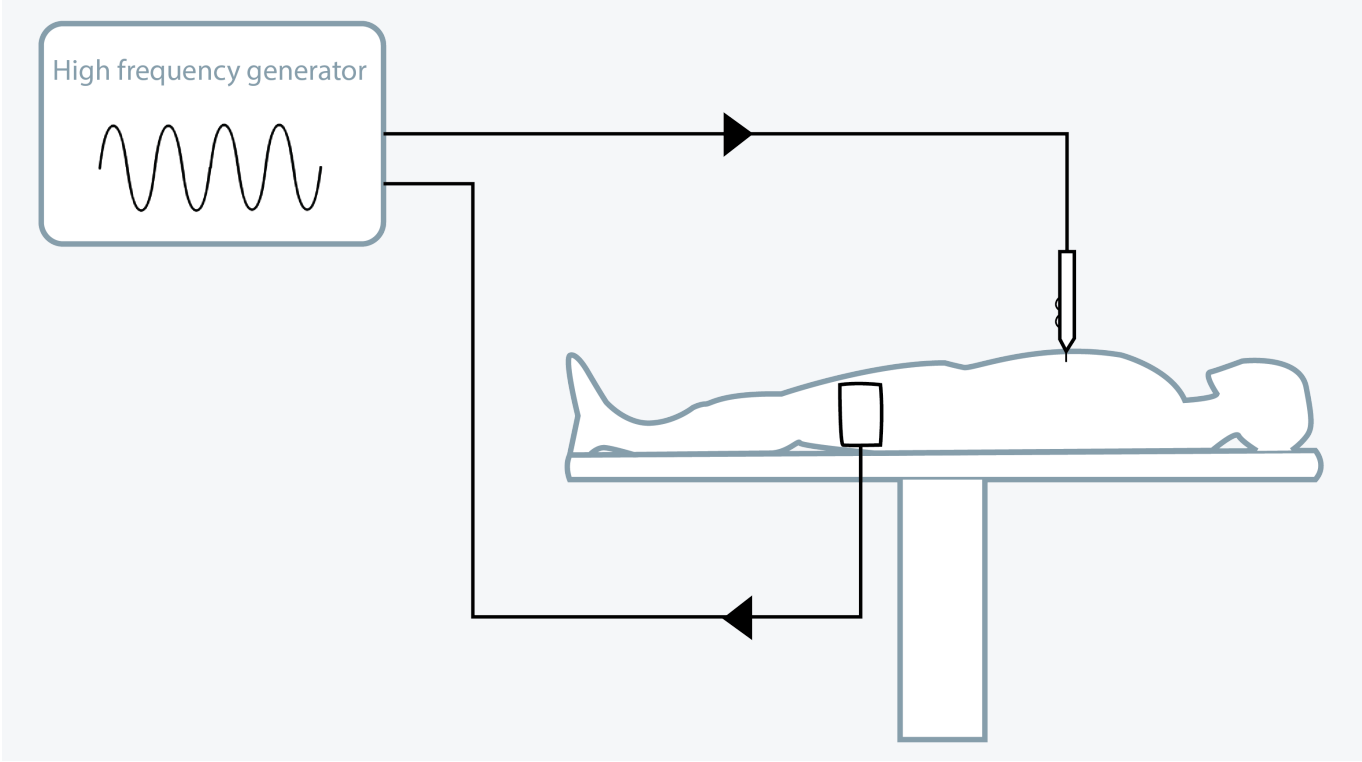

Figure 10: Monopolar electrosurgery

The Technology's potential safety risks

Risks concerning the electrode tip

Surgical smoke

While using the active electrode on the patient's tissue, surgical smoke will form. This smoke might have a negative effect on those exposed to it as it may contain toxic gases and vapors, like formaldehyde, dead and live cellular materials and bioaerosols. Bioaerosols produced at low temperature may contain live multidrug resistant mycobacterium tuberculosis, viral DNA of viruses like Hepatitis B and C, and HIV.

The electrosurgical smoke may cause upper respiratory tract irritation and create visual problems among the surgical team (Ulmer, 2008).

Fire risk

The occurrence of a fire in an operation theatre is rare, but still research shows that it is a real risk. Jones et. al (2015) state that about 200 to 240 fires occur in the operation theatres in the US every year. In 70% of those cases the electrosurgical equipment is the source of ignition. In order for a fire to occur three ingredients are necessary. These are heat, fuel and an oxidizing agent such as oxygen. During electrosurgery heat and oxygen are usually present simultaneously. Therefore, the medical staff should keep any potential fuel away from the surgical site. Alcoholic disinfectants for example have great potential to cause a fire when not being thoroughly dried prior to the procedure. Special attention should also be paid during surgeries

return electrode always makes full contact with the patients body. If the contact area is decreased the patient runs the risk of getting burn wounds.

One can attach different electrode tips to the monopolar hand-held. A tip with a small contact area is more suitable for cutting, since it increases the current density in the tissue at the point of contact, and a tip with an increased contact area reduces the current density and thereby makes it more suitable for coagulation (see figure 10) (Ouweltjes, 2018).

Bipolar electrosurgery

In bipolar surgery the handheld contains two active electrodes of different polarity connecting the tissue to the electrical circuit. In bipolar electrosurgery no additional dispersive electrode is needed. Only the grasped tissue between the two electrodes becomes a part of the electrical circuit and will be affected (see figure 11). Since no unintended tissue is exposed to current, the method is considered relatively safe. However, bipolar electrosurgery is not very suitable for cutting and only tissue that can be grasped can be affected (Masserweh et. al, 2006).

The handheld can be controlled by a footswitch, or sometimes using an automatic start-stop mechanism. In that case the device is automatically activated when tissue contact is detected through its resistance, and deactivated when a coagulum has formed (Ouweltjes, 2018).

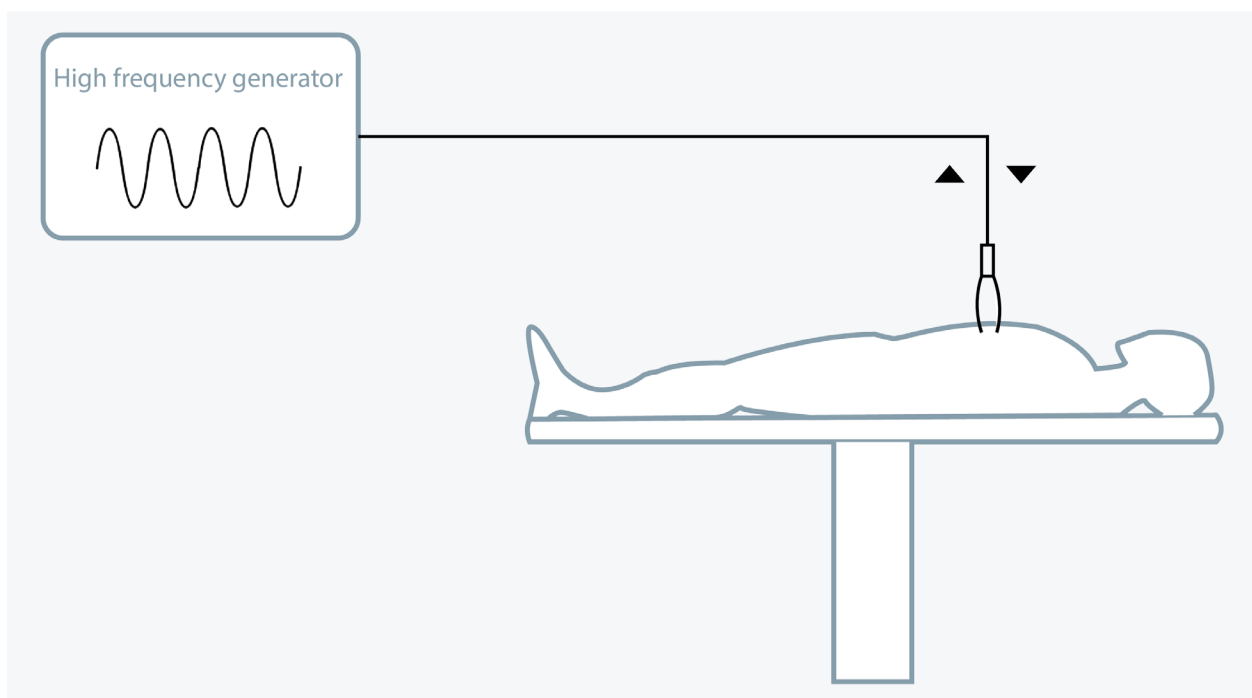

Figure 11: Bipolar electrosurgery

to the bowel, since it often contains fuel in the form of methane and hydrogen, and oxygen. Furthermore, as Jones et. al describe in an example case the team should pay special attention when draping the patient and using blankets, since the electrosurgical unit can cause a spark and thereby ignite the drapes and blankets. A precautionary action the staff should take, is to only activate the handheld when the active electrode tip is in view and deactivate it prior to leaving the surgical site. In figure x the risk is illustrated.

Accidental activation

The surgical team should not only pay attention to the ESU when using it. There is also a risk of fire and burn wounds when the handheld is not actively used during the procedure.

When not being in use the handheld should not be placed on top of the patient or flammable materials like bandages fueled with alcoholic disinfectants. Accidental activation could cause unintended burn wounds and accidental ignition of flammable materials. When not using the electrosurgical unit the handheld should not be placed on the patient's body / blankets, but instead in a holster. This will prevent patient burns in case the ESU will be activated accidentally (Jones et. al, 2015).

Residual heat

Residual heat is defined as the increased temperature that remains at the electrode tip after activation. Using the active electrode for a prolonged time leads to an increased residual heating of the hand-held electrodes. This can result in unintended burns when touching tissue shortly after the activation. It is recommended to make use of brief and intermittent activation. Also reducing the maximum power settings can reduce the amount of residual heat (Jones et. al, 2015).

Glove burn

During electrosurgery there is a risk for an operator to become a part of the electrical pathway. When the active electrode touches another metal instrument, held by someone, who is not in contact with the patient's tissue, the current will flow through the metal instrument and continue its path through the operator's hand (see figure 12). This can cause a glove to melt which can lead to burn wounds. Therefore, this event is known as glove burn. Additionally, the patient

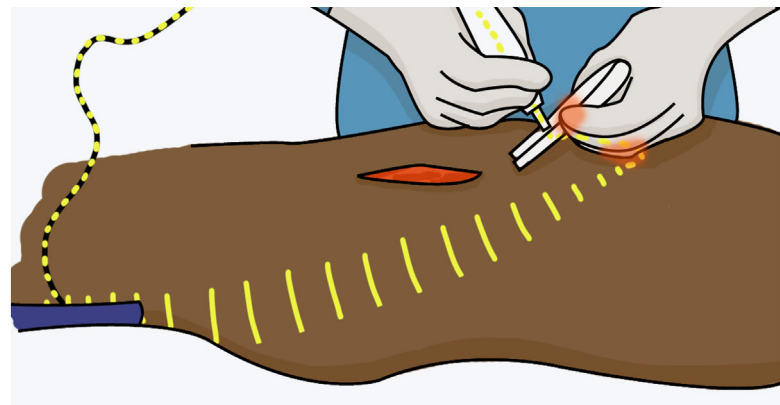

Figure 12: Glove burn

might also get burned, if the operator is touching the patient with his/her body (Hay, 2008).

A glove burn can also occur when a high voltage is used on fully coagulated and carbonated tissue, since the resistance of the of the tissue may be greater than the resistance of the pathway through the operator (Hay, 2008).

Eschar build-up

Excessive heating of the tissue may result in carbonization and tissue might stick to the electrode. When there is a lot of eschar build-up during the procedure carbonization of the sticking tissue continues and further increases the resistance of the electrode tip (see figure 13). The eschar build-up reduces the performance of the ESU. As a result medical staff might increase the power settings. To avoid these risks the user should keep the tip clean during the procedure (Masserweh, 2006).

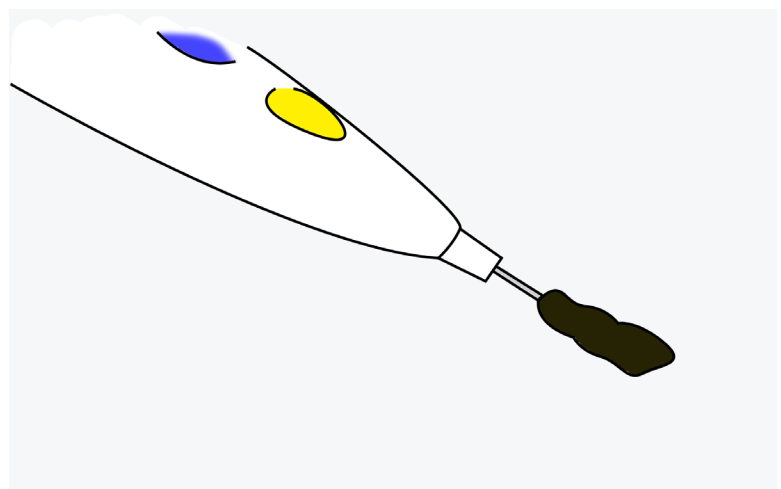

Figure 13: Eschar build-up

Risks concerning alternative pathways and current leakage

The risk of alternative electrical pathways

Most modern ESUs have isolated generators. This means that there is no longer a direct connection to the ground between the patient plate and the generator (see figure 14). Now the difference in current entering the body and returning via the patient plate can be measured. Therefore, it can immediately be detected if those values are not equal. In that case the generator will automatically deactivate the ESU. However, the machine has a small tolerance. When the difference in current is very small, the ESU will not immediately deactivate (Ouweltjes, 2018).

The leaking current will always seek the path of least resistance. Therefore, the medical staff should ensure that the patient is not in contact with any conductive object. Those objects might be operating tables, an IV stand and other conductive accessories. If the contact between patient and grounded conductive object is smaller than that of the patient return electrode, the patient might get burned (Ouweltjes, 2018).

The risk of implantables

One should pay special attention to patients who have implantables inside their body. The electricity may favor the electrical pathway towards conductive implantables like metal prosthesis or even a tattoo, and this could lead to high current density and burns. The effect could be even worse when the patient has a cardiac pacemaker or an cardioverter-defibrillator (ICD) inside his/her body. They may be negatively affected. If the electricity favors the pathway of the cardiac pacemaker or ICD, skipped beats, reprogramming of a pacemaker or firing of an ICD could be triggered. It is recommended to deactivate the implantables prior to the surgery if possible, or to only use short bursts of energy with a duration of less than six seconds. Furthermore, it is more safe to use bipolar electrosurgery, since a smaller and more confined area of tissue is affected by the active electrodes and therefore it is less likely that current reaches the implantable (Hay, 2008).

The risk of current leakage

During electrosurgery the high alternating current which flows through the cords between the HF generator and the electrodes, forms an electromagnetic field (see figure 15). When electrode cords are bundled or wrapped together, the energy levels of this field are

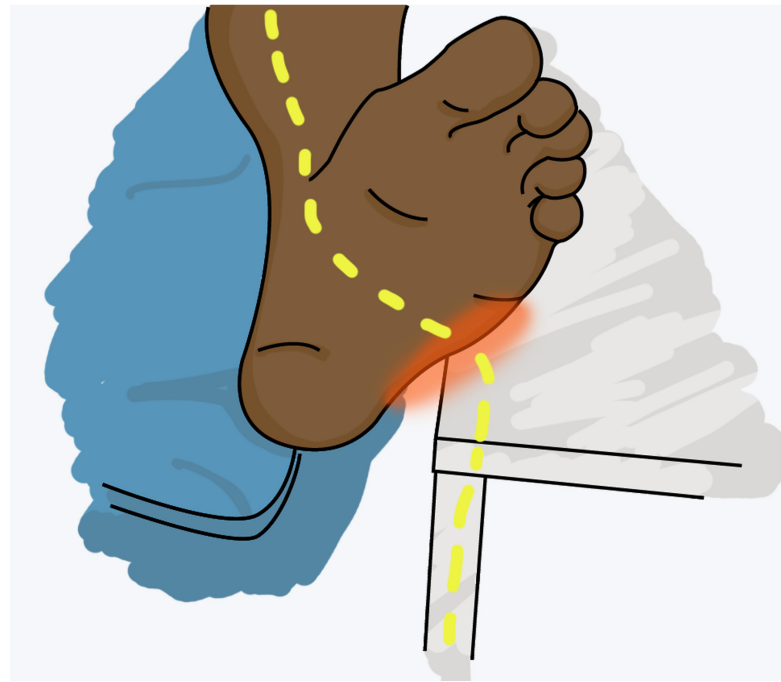

Figure 14: Alternative electrical pathway

increased. Conductive objects which are in that field like metal instruments, may be charged and current will run through them. The current might continue its way into the patient's body if the conductive object is touching it. This might lead to patient burns during prolonged exposure (Hay, 2008).

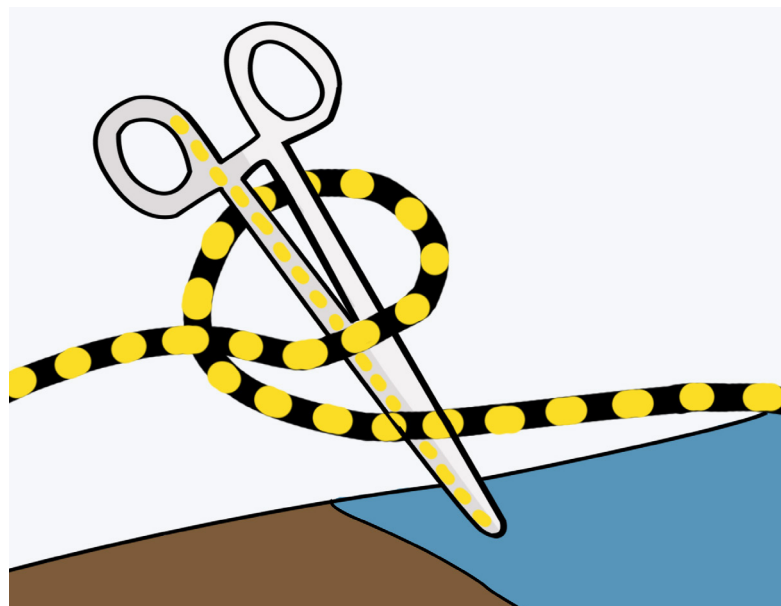

Figure 15: The risk of current leakage

Risks concerning the patient plate

Correct patient return electrode placement

In order for the patient return electrode to work properly and to prevent patient plate burns, it is important that it is correctly attached to the patient's body. The patient plate should be placed on a well-vascularized muscle mass, because this tissue type has a lower electrical resistance. One should avoid areas with irregular body contours, bony prominences, excessive hair and scarred tissue. Moreover, the areas where the patient touches the surgery table are to be avoided, because the blood circulation is reduced at these spots and therefore the resistance increases (Hay, 2008).

In general the patient plate should be placed as close as possible to the surgical site.

The risk of reduced contact area

As already mentioned, the patient plate should be many thousands of times larger than the contact area of the active electrode, because then the current density at the patient return electrode is very low and therefore less heating will occur. When the patient plate loses contact with the body, the current density will increase and might cause patient plate burns.

There are different types of patient plates. They can be made with either one or two conductive areas, called single and split electrodes. Nowadays, split patient return electrodes can be monitored with a Return Electrode Monitoring (REM) system. This technology will make sure that the ESU gets deactivated if the system detect a decreased contact area (Ouweltjes, 2018).

Take-aways technology study

Just as every technology electrosurgery comes with certain risks. The risks which have been analyzed in this literature study are risks which are generally related to electrosurgery. This means that they could occur all over the world. However, contextual factors such as the operation theatre layout, and user characteristics have big influence on product use. Therefore, different contexts and users might trigger different hazardous situations to occur.

This research focuses on low-resource healthcare contexts. This context will be introduced in the next chapter. At the end end of part 1.1 it is analyzed which risks related to electrosurgical equipment are triggered to occur in this specific context. But first the next chapter will present the different users who interact with the equipment in the low-resource healthcare setting.

1.2.2 The users' Knowledge and Concerns about Electrosurgery

The user and context study were conducted in a Kenyan national hospital. Before the results of the user study will be presented, first a short introduction to the country, its healthcare system and the national hospital will be provided.

Introduction into the context

Kenya

For this project Kenya is taken as a case study. The former British colony became independent in 1963. The country is divided into 47 semi-autonomous counties that are headed by governors. Kenya's economy is the largest in Eastern and Central Africa. Agriculture and the service industry are large economic drivers. They produce and export a lot of tea, coffee and fresh flowers, and the tourism is booming. However, Kenya is still considered a frontier market and one of the most unequal countries in the sub-region. About 46 percent of the 40 million inhabitants live below the poverty line (Unicef, 2014).

The country also has big contrasts when it comes to landscape and demographics, and there is a big variety in culture. English and Swahili are the two official languages. While English is widely spoken in commerce, schooling and government, Kenya's various ethnic groups typically speak their mother tongues within their own communities. Especially in the rural areas people often speak only their native language. In total there are 69 languages spoken in Kenya.





PUBLIC
TOILET
GENT

The Kenyan healthcare system

About half of Kenya's healthcare facilities are public hospitals and the other half are private (for-profit), mission, or NGO hospitals (Muga et. al, 2004).

Kenya's public healthcare system is structured in a hierarchical manner and aims to make healthcare services more effective and accessible to as many people as possible. Level 1, the community level, is the foundation of the hierarchy. Village Health Committees (VHC) are organised in each community through which households and individuals can participate and contribute to their own health and that of their village (Muga et. al, 2004).

Levels 2 and 3 (dispensaries, health centres, and maternity/nursing homes) handle activities related predominantly to promotive and preventive care, but also various curative services.

More complicated cases will be referred to higher levels of healthcare, namely levels 4 to 6 (primary, secondary and tertiary hospitals). Those levels will undertake mainly curative and rehabilitative activities and they will address to a limited extent preventive/

promotive care.

In order to be classified as a level 6 hospital, the hospital should not only provide sophisticated services but also operate as an educational facility. In Kenya there are two level 6 hospitals, namely the Kenyatta National Hospital in Nairobi and the Moi Referral and Teaching Hospital in Eldoret (Ouweltjes, 2018). The health services up to level 5 are organised by the county governments. The level 6 facilities are organised by the government and are therefore national hospitals (Muga et. al, 2004).

Electrosurgical equipment is used in level 4, 5 and 6 hospitals, since they provide surgical care. Differences in electrosurgery in those hospitals lie in the variety of surgical treatments. Level 5 and 6 hospitals provide more sophisticated and specialized surgery than level 4 hospitals and therefore use more specialized equipment such as bipolar electrodes (Ouweltjes, 2018).

Level	Type	Goal
1	Community	First line contact: provision of preventive healthcare services
2	Dispensaries	First line contact: provision of preventive healthcare services
3	Health centers	Ambulatory health services adapter to local needs
4	Primary referral facilities	Delivery of health services, plans and buget by county government
5	Secondary referral facilities	Referral hospital for level 1-4 provision of specialized care, plans and buget by county government
6 A-B	Tertiary referral facilities	Apex of the healthcare system providing sophisticated services , plans and buget by county government
Private or for profit	Healthcare systems & hospitals	Independent of the government, have to follow nation guidelines

Figure 16: Healthcare system

National hospital

This study was conducted in the national hospital in Eldoret. Eldoret is with 289,380 inhabitants the fifth largest city in Kenya. The hospital was founded in 1916 and has since then grown to a level six Hospital offering outpatient, inpatient, and specialized healthcare services. It offers a range of services to clients including; Oncology services, Renal Services,

Paediatric Surgery, Kidney Transplants, Alcohol and Rehabilitative, Spinal and Neurosurgical operations, Specialized Orthopedics and Trauma, Cardiology, and free Maternity Services among others. For this two week study I joined multiple surgeries at different departments.



The users - Insights into their knowledge and concerns

The observations and interviews revealed that there are a lot of different people interacting with the electrosurgical equipment. Nurses, biomechanical engineers (BMETs), surgeons, surgical assistants, students who are doing their attachment or residency and anaesthetists all interact with the electrosurgical equipment at least once during the equipment journey. In table 1 an overview of the number of users that were asked about their knowledge and concerns regarding electrosurgery is presented. Additionally, fourteen surgeries have been observed. The observations showed that the surgical assistant is usually a surgeon in training who is doing his/her residency or another surgeon. Since the interviews revealed that the professional surgeons and surgeons in training have similar theoretical knowledge about electrosurgery those two users will be represented in one user profile.

Consistently the data showed that the knowledge of the student and professional is comparable and therefore no separate user profiles were created for the students. However, the observations showed that the students are much more nervous when interacting with the electrosurgical equipment than the professionals. Reason for this might be their lack of experience.

During the fourteen observed surgeries only once an anaesthetist was operating the ESU. Also the interviews revealed that the anaesthetists are usually

Reminder research method

Objective:

- Map out all the users and their touchpoints with the equipment
- Explore the users' knowledge and concerns

Data collection:

- Observations
- Semi-structured interviews using small interview cards

Data analysis:

- Observation and interview data was gathered and clustered into related groups to reveal data patterns

not interacting with the machines. They did not learn anything about electrosurgery and the equipment during their education. However, when no one else is able to operate the ESU when needed, the anaesthetist will take over that task.

After collecting and organizing all the data a user profile for the nurse, surgeon and BMET was created. The profile specifies the tasks the user has during electrosurgery, the touchpoints with the electrosurgical equipment and the knowledge regarding electrosurgery. Furthermore, the profile presents concerns the user has regarding electrosurgery. In figure 17, 18, and 19 the different profiles are shown.

User group	Amount of Participants	Whereof students
Biomechanical engineers	n = 8	n = 2
Nurses	n = 6	n = 2
Surgeons / Surgical assistants	n = 6	n = 3

Table 1: Participant table user study

Knowledge about electrosurgery

The BMETs learn a lot about electrosurgery at college. They gain detailed knowledge about the principles behind electrosurgery and moreover, they learn a lot about electrosurgical units from different manufacturers. Additionally, every BMET students needs to do an attachment in which they gain practical experiences. Here they can observe and assist more experienced BMETs during their daily work.

“At college we learned a lot about electrosurgery. I wrote everything down in my booklet.”



Touchpoints with electrosurgical equipment

- When the hospital gets a new ESU a BMET gets trained by a technician from the the manufacturer on how to operate, maintain and repair the device
- Ideally, the BMET does a routine check of the ESUs every morning
- Ideally, the BMET should operate the ESU during surgery
- In case of a system error, the BMET will come and try to solve the issue
- The BMET is responsible for maintaining and repairing the ESU

Concern:

The BMETs do not always check all the ESUs prior to the first surgeries. Moreover, the BMETs cannot be present during every surgery to operate the ESU, because there are not enough BMETs around. As a result other staff members will take over this task.

Figure 17: BMET profile

Biomechanical engineering technician

Knowledge about electrosurgery

The nurses often operate the ESU during surgery, however, they have never learned anything about electrosurgery at college. The nurses do not know the theory behind electrosurgery and expect the surgeons to tell them on which power settings the device should be set. They recognize that the surgeon often wants to start with settings around 40W.

“They (teachers at college) only shortly mention that there is something such as electrosurgery and then go on. We learn to use the ESU at the job.”

(n=6)

Concern:

The workload of the nurses is very high, because there is a shortage of human resources. The nurses need to take over tasks from the BMET when (s)he cannot be around and help cleaning after the surgery. Also during the surgery the stress is high, because there is often no second nurse available to support.

Touchpoints with electrosurgical equipment

- Attach return electrode pad to patient’s body
- Connect handhels to HF generator
- Connect patient plate to HF generator
- Operate ESU (select and/or change power settings) if BMET is not around

“The patient plate should be placed on a well-vascularized area such as the upper leg”



Figure 18: Nurse profile

Nurse

Knowledge about electrosurgery

Just like the nurses the surgeons and surgical assistants do not learn anything about electrosurgery at university and they have never operated an ESU during their education. They gain all their experience with electrosurgery at the job by watching and learning from a more experienced surgeon.

“You first observe, then assist and finally perform while a more experienced surgeon is close by.”

(n=8)

Most surgeons do not select the power settings based on the type of surgery and tissue.

“Tissue is tissue, right?” (n=1)

Instead, they use two main rules as a guideline.

“With the power settings you usually start low, with 35 to 45 for adults and between 15 and 25W for children. Then you slowly increase if you feel it is necessary.”

(n=8)

Concern:

The surgeons/ surgical assistant did not learn anything about risks related to electrosurgery and about how to prevent them.



Touchpoints with electrosurgical equipment

- The surgeons only interact with the handheld (monopolar or bipolar)
- The surgeon communicates if the power settings need to change during the procedure
- The surgical assistant will sometimes operate the ESU if the BMET or nurse are not available

“Once you set the power settings you usually won’t change them during the surgery. And if you want to change them the BMET will adjust them accordingly or when (s)he is not around we will do it ourselves “

Surgeon / Surgical assistant

Figure 19: Surgeon profile

Takeaways user study

Ideally, the BMET operates the HF generator during the surgery, since (s)he knows most about electrosurgery and the different ESUs. However, in reality this is not manageable, because on average there are only three BMETs in the building with seven operation theatres. Therefore, other people in the operation theatre need to take over the task of operating the ESU. Often this is the nurse, but in case that there are not enough people around during the surgery, just someone who is close by and available at that moment will take over that task. It is striking that all the medical staff such as the surgeons, surgical assistants, nurses, and anaesthetists have never learned anything about electrosurgery and the related risks at university / college. Even the surgeons who operate the handheld and are responsible for selecting the power settings have their first experience with the device at the hospital. Since theoretical knowledge about the principles of electrosurgery is missing, they go for safe and always start with low settings and then slowly increase if necessary.

The lack of theoretical knowledge and human resources can have a big impact on the safety of electrosurgery. It might influence the way the users perform certain activities and judge the safety of an activity or situation. In the next chapter all the phases and activities the electrosurgical equipment is involved in will be presented.

After that in chapter 2.4 it will be analyzed how the user profiles influence the safety of the activities.

1.2.3 The Phases and Activities Electrosurgical Equipment is involved in during its Lifespan

In total fourteen procedures have been observed and four BMETs were interviewed using the card sets. Table 2 provides an overview of the phases and the amount of observations and interviews. The combination of observations and semi-structured interviews led to a complete overview of the phases the electrosurgical unit goes through during its lifespan. The journey contains the following phases: Procurement, Pre-treatment, Surgical treatment, Post treatment, Maintenance, Repair and Disposal. In order to create a comprehensive story also activities that are not directly related to the ESU are mentioned in the equipment journey.

The journey is a sequence of all the events that have been observed, and described by the hospital staff. Therefore, the here described journey is a combination of all the different findings. For every activity in the pre-treatment, surgical treatment and post-treatment phase it is indicated how often that activity was observed out of 14 journeys. This number can be found in the related visualisations (see pp. 31-44).

Reminder research method

Objective:

- Explore the different phases and activities the electrosurgical equipment is involved in during its lifespan

Data collection:

- Observations of the pre-treatment, surgical treatment and post-treatment phases
- Semi-structured interviews using card sets for the procurement, maintenance, repair and disposal phases

Data analysis:

- Observation and interview data was gathered and clustered into related groups to reveal data patterns
- The data was organized and put into chronological order to form a journey

Phase	Interviews with BMETs	Observations
Procurement	n = 4	
Pre-treatment		n = 14
Surgical treatment		n = 14
Post treatment		n = 14
Maintenance	n = 4	n = 3
Repair	n = 3	n = 2
Disposal	n = 3	

Table 2: Overview of the number of interviews and observations per phase

(1) At the beginning of the journey either the BMET or the surgeon is asking for new equipment. Main reason for ordering new equipment is a broken ESU, but sometimes the surgeons also ask for a new ESU which has for example more extended or specific features.

(2) A BMET then needs to set up a document with specifications for the new ESU. Therefore, (s)he has to walk to the calibration lab which located near the main workshop of the hospital. This is a five minute walk. The reason the BMET has to go there is that at the calibration lab there is the only computer all the BMETs have access to. The BMET does not need to write down new specifications every time (s)he wants to set up a new specification document. There are specification forms for all the different machines. Those are not specified for a certain manufacturer, but from time to time the forms are updated according to new technological developments. An important requirement is that the manufacturer provides training and contact details.

(3) The document with the specifications for a new ESU will then be sent to the procurement officer.

(4) (S)he will place a tender in the national newspaper, so that local distributors can react to it and hand in a bid.

(5 / 6) The local distributor that wins the bid will then send an engineering technician to install the new ESU and to provide training to the BMETs at the hospital. In some cases a BMET will fly to the location of the manufacturer to be trained. Later the (s)he will then tell his/her colleagues about what (s)he has learned.

Donated equipment

Additionally, a lot of the machines in the hospital are donated and those are often very outdated and not manufactured anymore. (7) The Moi Teaching and Referral Hospital has regulations for such donated equipment. Organizations who want to donate an ESU are obliged to provide manuals, a contact person and if possible training.

(8) A problem that often occurs, is that machines are already broken when they arrive. Main reason for this is transport. The roads in Kenya are very bumpy and not well maintained, and the machines are not well enough protected for that.

1

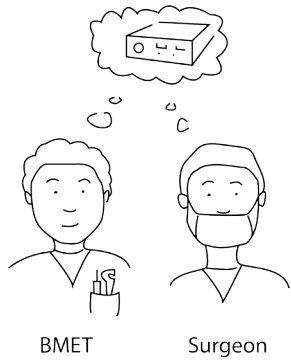

2

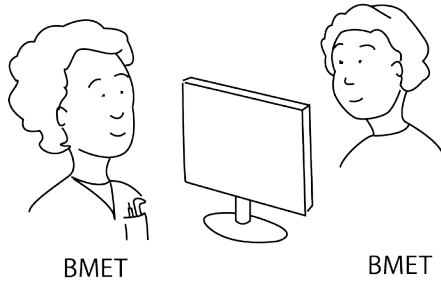

3

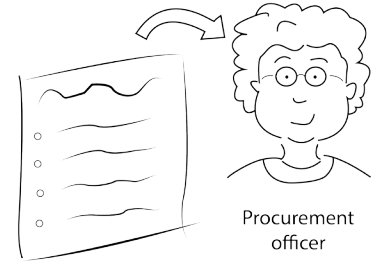

4

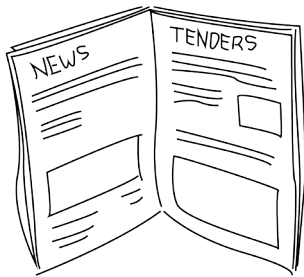

5

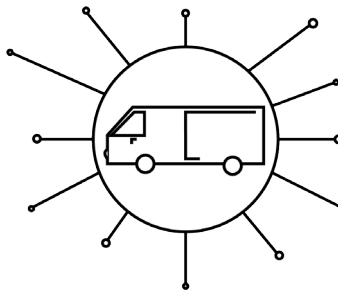

6

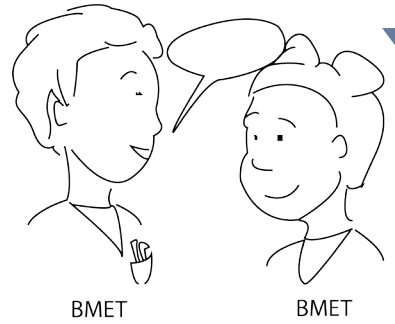

7

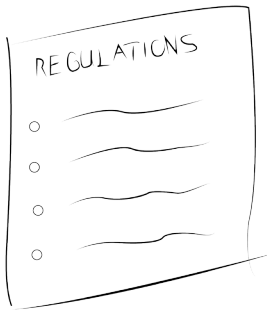

8

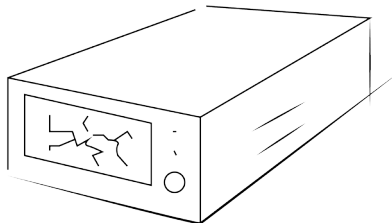

(1) Every morning starts with a shift change at around 8 am. Between 8.30 and 9 am the next surgeries will start with the new staff. Prior to surgery a lot of different activities need to be done. (2) Every member of the surgical team checks the surgery schedule at the beginning of the day in order to know for what surgery they are scheduled and in what operation theatre it takes place. The schedule is located at the patient entry hall.

(3) Prior to the surgeries the BMETs are supposed to do a routine check round. One of the three BMETs needs to walk through all the operation theatres and check the ESUs by running through the Routine Equipment Checklist. They should turn on the ESU and observe if the self-test is correctly completed. They should also check if there is still a functioning return electrode pad available.

This procedure of the routine check round appeared to be more a description of the ideal situation. In practice I have not seen a BMET doing the routine check or using the checklist.

(4) Ideally, there is a presentation for the whole surgical team once a week at around 8 am. The hospital hired someone to prepare weekly presentations about different topics. These are usually little refreshers on different topics, but it can also be a discussion about a rather new topic or something the hospital management wants the staff to do such as a risk assessment for example. These presentations offer the chance to educate the hospital staff about electrosurgery.

(5) Prior to surgery the nurses pick-up the boxes with instruments at the storage room. There are boxes for different types of surgeries (e.g. Orthopaedic surgery or Plastic surgery). The boxes are covered in blankets and have all been autoclaved. After autoclaving every box gets an expiration date. When the date is expired the boxes need to be autoclaved again, even if the instruments have not been used.

(6) In the operation theatre the circulation assistant or just someone who is standing close by (often a medical student) is dressing the nurse. They help the nurse to put on a sterile coat and a pair of gloves. (7) When the nurse is fully dressed (s)he goes to the room between the operation theatres and prepares the instrument trays. The instruments that are commonly used are sorted. The person who prepares the instrument trays needs to wear sterile clothes, however, that person

should not enter the sterile zone in the operation theatre when having passed the non sterile area or even touched other people.

(8) During the pre-surgical treatment phase there are usually two or three anaesthetists present in the operation theatre. After the patient is carried onto the surgery table, (s)he is brought into the right position for the upcoming surgery. They often place the patient's arm on a piece of wood and then connect the patient to the monitoring devices.

(9) While the anaesthetists are connecting the patient to the monitoring devices, the nurse is checking the most important patient details like the name, age and for example on which leg the wound is. These check ups happen while the surgeon is not around yet. Ideally though, the surgeon, the nurse and the anaesthetist are all present during this little briefing where they can introduce themselves to the patient. Although desirable the nurse does not use the official laminated checklist during these patient checks. That checklist would guide her through all the questions she needs to ask the patient. They do not use the list, because the hospital has no resources to photocopy the filled out checklists, print them and add them to the patient file. The surgical team might miss important information, such as the age and the vitality of the patient. These are both important factors when considering the power settings. (10) The anaesthetists are now administering the anaesthesia. After that two anaesthetists will leave the operation theatre. One will stay during the whole procedure and keep an eye on the anaesthetic machines and the patient. (11) The nurse puts Smugel Lubricating gel on the return electrode sticker to increase the conductivity of the sticker. This prevents patient plate burns. (12) The return electrode sticker is then attached underneath the upper leg of the patient. The weight of the body ensures that there is enough contact with sticker.

1

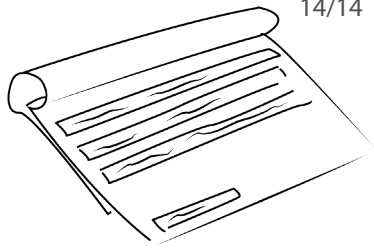

2

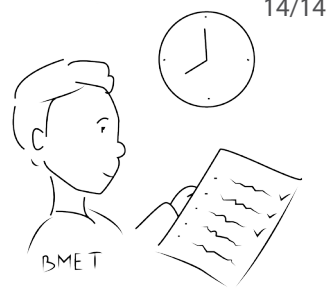

3

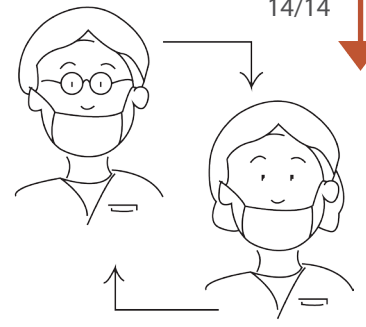

4

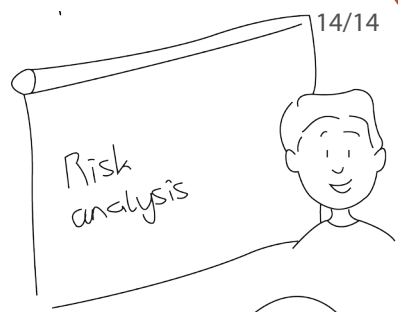

5

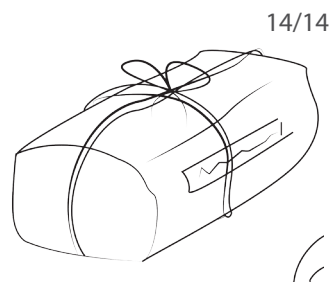

6

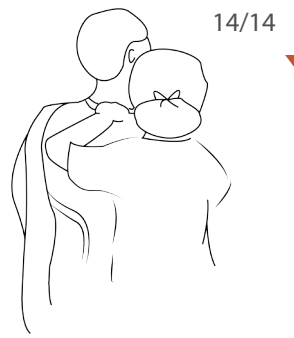

7



8

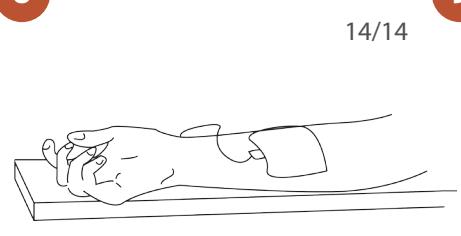

9

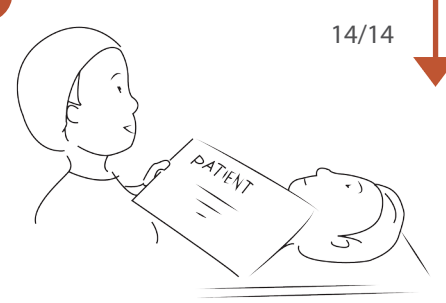

10

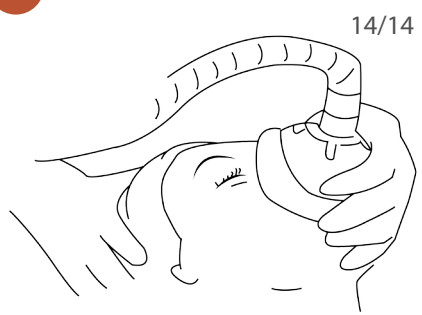

11

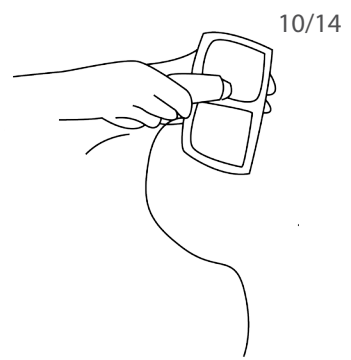

12

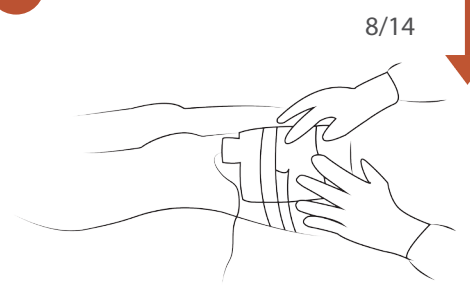

(13) Now also the surgical assistant and surgeon are entering the operation theatre. Someone who is not busy at the moment (often a medical student) helps them to get dressed with a sterile coat and gloves. (14) If necessary the surgical assistant shaves and afterwards cleans the surgical site with soap. After that (s)he puts spiritus on the surgical site. (15) When this is done the surgical assistant puts some iodine onto the surgical site. (16) The surgeon and the surgical assistant cover the patient with sterile blankets, before the patient plate is plugged in. Since the HF generator is still turned off at this point, the surgical team does not know yet if the return electrode plate is attached correctly to the patient's body. There is an possibility that if the plate is not correctly attached, the blankets need to be taken off again.

(17) The blankets are secured with clamps. (18) While the clamps are attached to the blankets, the ESU is turned on. Ideally, a BMET will come and turn on the HF generator, since (s)he knows the most about the machine. However, in practice the operator of the ESU will change according to the available staff. The BMETs cannot be around during every surgery, since there are only three BMETs on duty during the day and there are seven operation theatres. Often a nurse or the surgical assistant will then take over this task. But it can also be a medical student who is just standing next to the ESU. (19) After the HF generator is turned on it runs a self-check and selects the last used settings. In this case cut: 50 and coag: 45. Most nurses and surgical assistants check those settings and adjust them if they seem very high. However, there are some nurses and surgical assistants who assume that the BMET has pre-set the ESU during the morning routine check. However, the BMETs do not do this. (20) The nurse (but sometimes also the surgical assistant or a student) now plugs in the return electrode into the HF generator. The return electrode sign on the generator lights up in red and a soft alarm sound is on. No one detects the alarm sound due to its low volume. (22) The circulation assistant takes the monopolar handheld out of a box with Cidex which is located in the room between the operation theatres. The handheld is passed to the nurse. (23) The nurse taps the handheld and the plug onto the surgical table to dry them and to make sure that there is no more Cidex inside the handheld. (24) Next, the nurse attaches the electrode tip to the handheld. (25) The surgeon and surgical assistant wrap the cable of the

handheld around a metal clamp, so that the handheld cannot fall onto the ground during the procedure.

(26) A medical student, in close proximity to the generator, plugs in the handheld. Because she seems a bit insecure the surgical assistant watches her and gives her instructions.

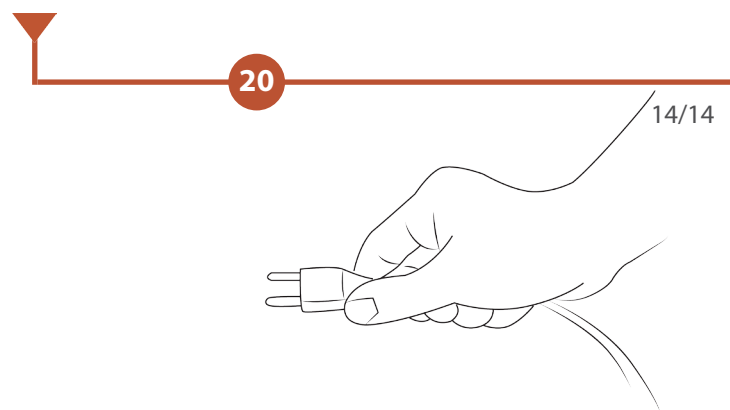
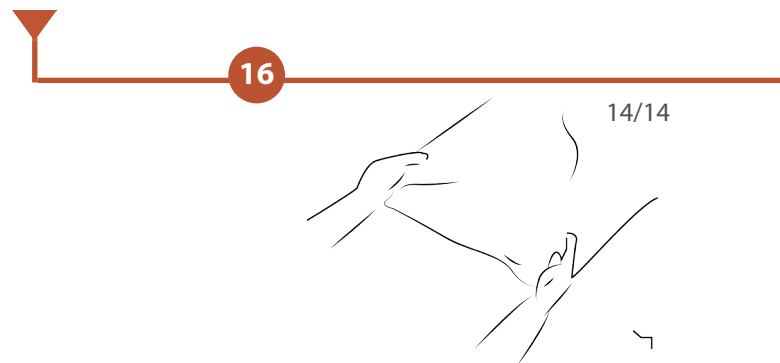

13

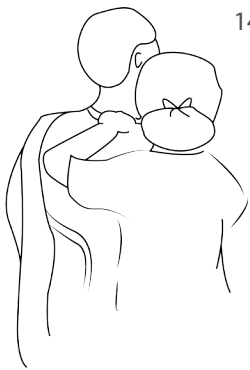

14/14

14

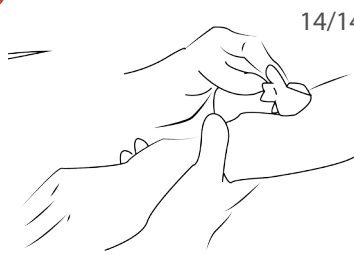

14/14

15

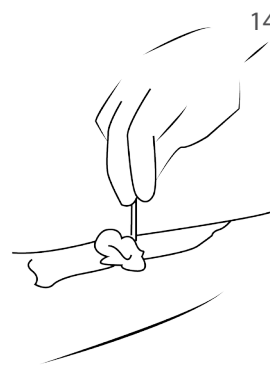

14/14

17



14/14

18

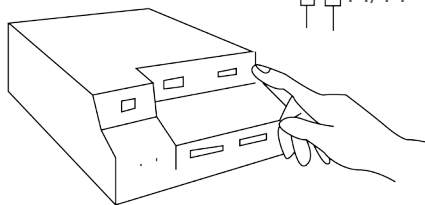

14/14

19

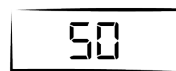

Cut

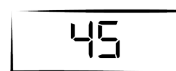

Coag.

21

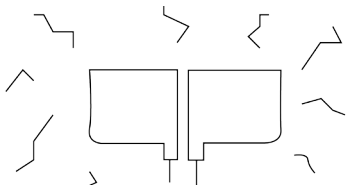

2/14

22

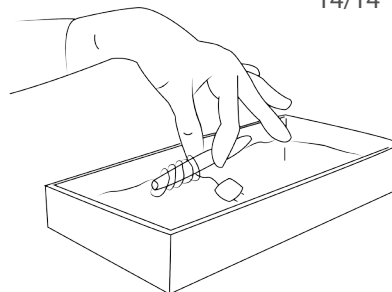

14/14

23

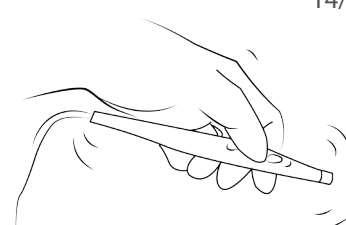

14/14

24

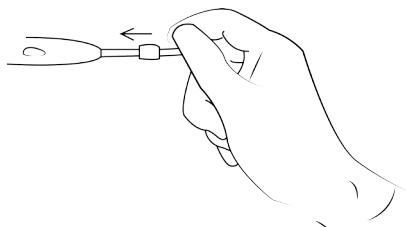

14/14

25

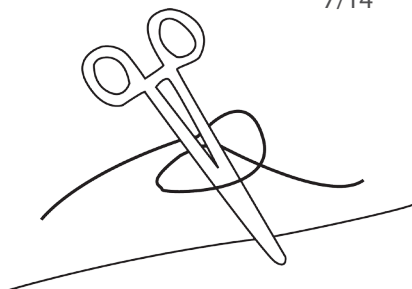

7/14

26

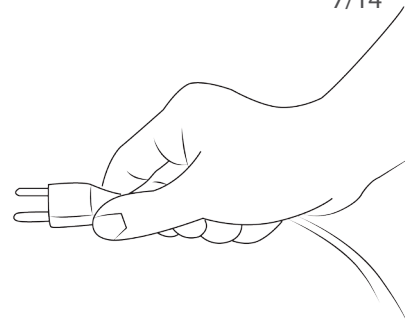

7/14

Surgical treatment

(1) While the surgeon does his/her first incision with a scalpel, the return electrode alarm is still on. In the meanwhile the alarm sound is getting louder, but still no one is paying attention to it.

(2) The surgical assistant is grabbing the connected handheld and is holding it in his/her hands, so that (s)he can pass it to the surgeon when (s)he is done with the first incision. Just when the surgical assistant passes the handheld, the surgeon notices the alarm sound. (S)he looks up and asks where that alarm sound comes from. Luckily the ESU has an REM system which makes sure that the active electrode cannot be used in case the system recognizes that the return electrode plate does not make enough contact with the patient's body. Otherwise, this situation could have led to serious burn wounds in case the alarm would not have been noticed prior to use.

(3) The circulation assistant takes a look at the HF generator and sees the return electrode sign lighting up in red. As a reaction (s)he presses against the return electrode sticker with his/her bare hands. However, the alarm is not going off.

(4) Therefore, (s)he is grabbing some tape and wraps it around the return electrode and leg. Since the alarm sound is not going off, (s)he adds more tape.

(5) Because the tape does not solve the issue, the nurse takes off the patient plate from the leg and replaces it underneath the shoulder.

(6) Finally, the alarm turns off and the return electrode sign lights up green again. This means that the surgery can proceed.

(7) Before the surgeon does his/her first incision with the electrosurgical unit, (s)he first tests the cut and coagulation mode by pressing the buttons on the handheld. While pressing the cut button the HF generator make a high sound and a yellow light on the interface blinks up. When the blue coagulation button is pressed a slightly lower sound can be heard and a blue light on the HF generator lights up.

(8) Throughout the surgery the surgeon alternates a lot between the cut and coagulation modes.

(9) When the handheld is not needed during surgery it is laid down on the blanket, on the table or sometimes even on metal instruments like clamps. In some occasions the active electrode tip is touching a piece of bandage which the surgical team uses to absorb blood from the wound.

(10) During the procedure the surgeon and surgical

assistant ask the nurse for different instruments. (11) The scrub nurse passes all the instruments to the surgical assistant, who then passes them to the surgeon. However, often it takes quite long to find some instruments in the big boxes.

(10) When the surgeon and surgical assistant work together, they sometimes ask for different instruments at the same time. This increases the workload for the nurses. Ideally, there should be two scrub nurses during complex procedures, but due to a shortage of human resources this is not possible.

(12) During the procedure the surgical assistant intentionally touches the metal tip of the suction tube with the active electrode. The suction tube is held by the surgeon. The current is flowing through the tip of the suction tube and creates a spark. This creates a coagulation effect at the patient's tissue.

(13) The use of the electrosurgical unit creates a lot of smoke. There is no ventilation in the operation theatre to absorb the smoke. Next to a very heavy smell, the smoke causes irritation of the eyes.

10

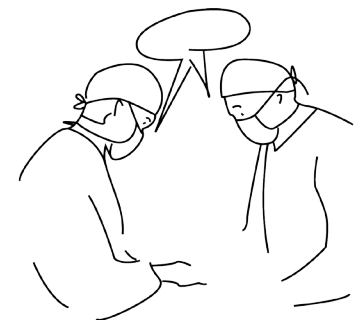

14/14

1

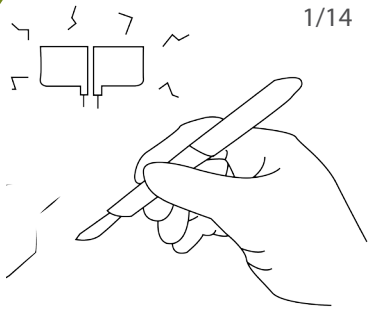

2



3

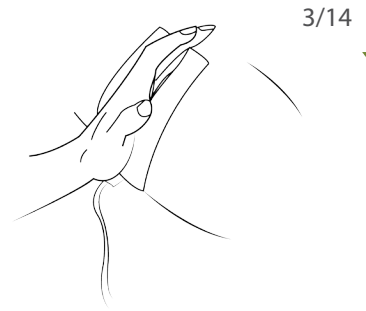

4

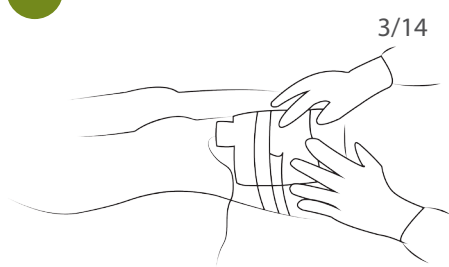

5

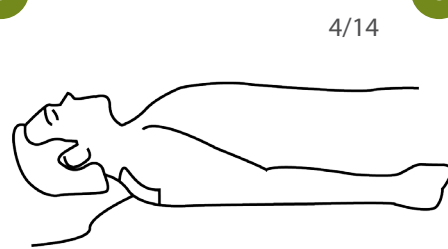

6

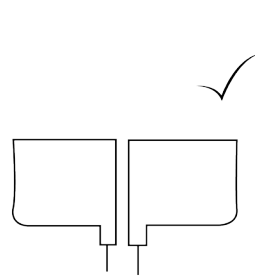

7

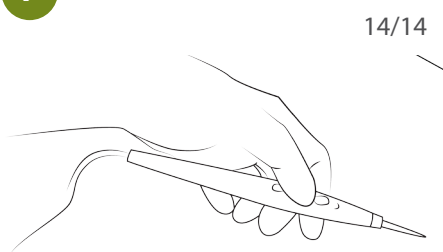

8

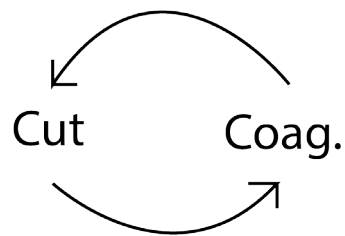

9

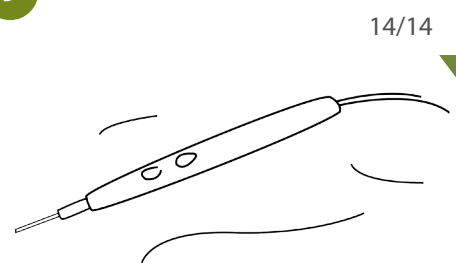

11

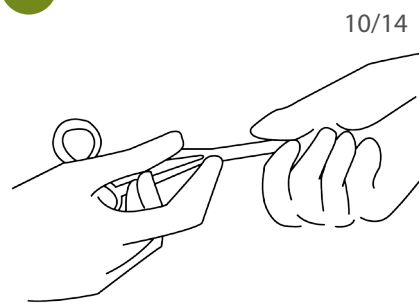

12

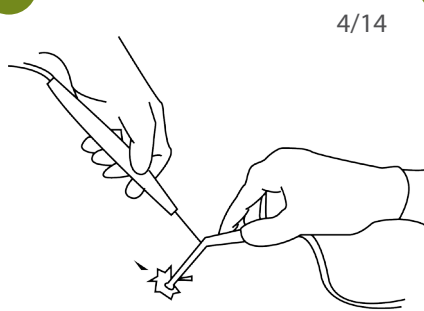

13



(14) Suddenly the ESU stays in continuous cut mode. There is a continuous cut sound and the yellow light on the HF generator is on. In the meanwhile the surgeon is busy with something else and the handheld is lying on top of the patient. For about 1 to 2 minutes no one reacts to the continuous sound.

(15) The circulation assistant then notices the sound and as a reaction the circulation assistant turns off the generator and after a few minutes back on.

(16) However, the continuous cut sound and light reappear and next to that the number 196 is displayed on the screen.

(17) The circulation assistant does not know what this number stands for and therefore is rushing to find a BMET. This takes some time, because the BMETs are not in the workshop at the moment. Then it is difficult to find them since there are only three around and they could be everywhere in the building. The staff has also no hospital phones to call each other.

(18) Finally, a BMET arrives. Also his/ her reaction is to turn off the HF generator and after a few seconds back on.

(19) Since the continuous mode and the number reappear, (s)he unplugs the monopolar handheld.

(20) Then the scrub nurse takes out the electrode tip and taps the handheld onto the surgical table to make sure that no Cidex is still inside. After that (s)he puts the electrode tip back into the handheld.

(21) Now the BMET is plugging the handheld back into the HF generator. For a second the issue seems to be solved.

(22) But the error message reappears. As a reaction the BMET smashes against the side of the HF generator. Now the error message is indeed gone.

(23) But not for long, after a few seconds the number 196 reappears on the screen.

(24) Therefore, the scrub nurse prepares a new handheld. (S)he taps the handheld onto the surgical table and puts in the electrode tip from the other handheld.

(25) Then the BMET plugs in the new handheld. And finally the error is solved. This incident caused a big delay of the surgery. In total it took the staff around 15 minutes to solve the error. The Valleylab manual explains how to react to system errors. In case of error 196 probably the handswitch or cut key is stuck. The manual is not kept in the operation theatre.

(26) After the incident the BMET leaves the operation theatre. (27) During the procedure a lot of people come and go. Most of the doors are open and sometimes there are up to almost 20 people in the operation

theatre. Most of them are medical students who are doing their attachment and therefore, observe the procedures. The surgeons often explain to the students what they are doing. The students are not wearing sterile clothes, but often stand within the sterile zone, which is outlined on the floor, to be able to see what exactly is going on. (28) The surgeon gives instructions to increase the power settings a little bit. (S)he is not addressing his/her message to someone specific in the room. Therefore, it takes a while until someone reacts.

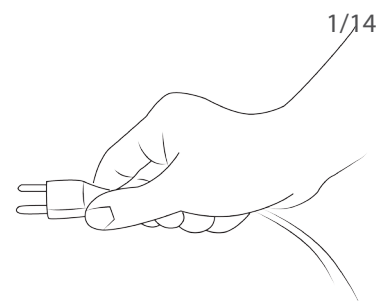
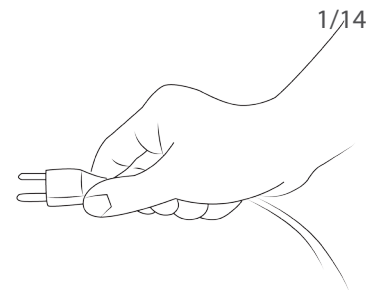
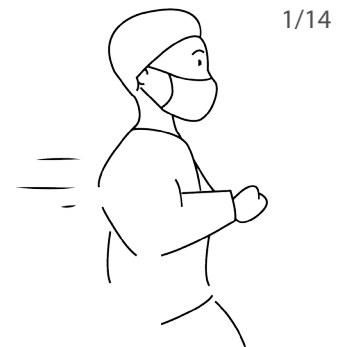

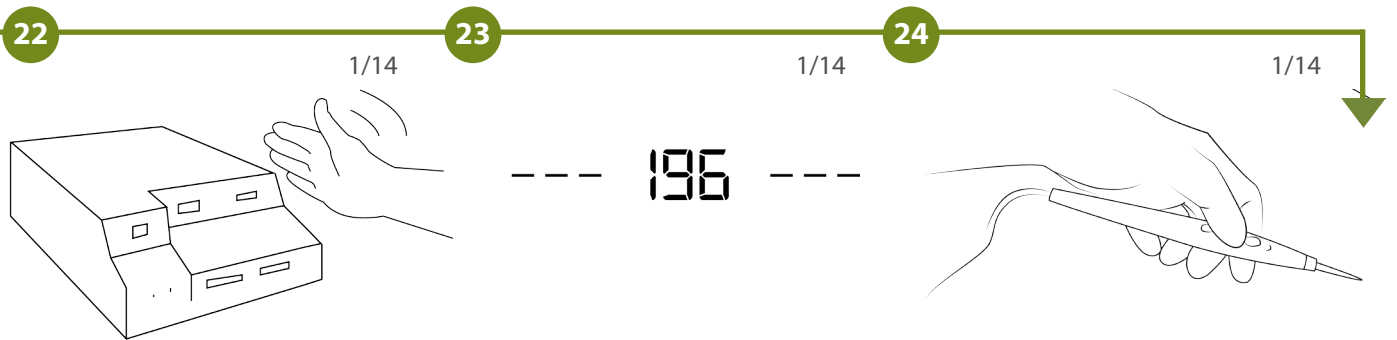
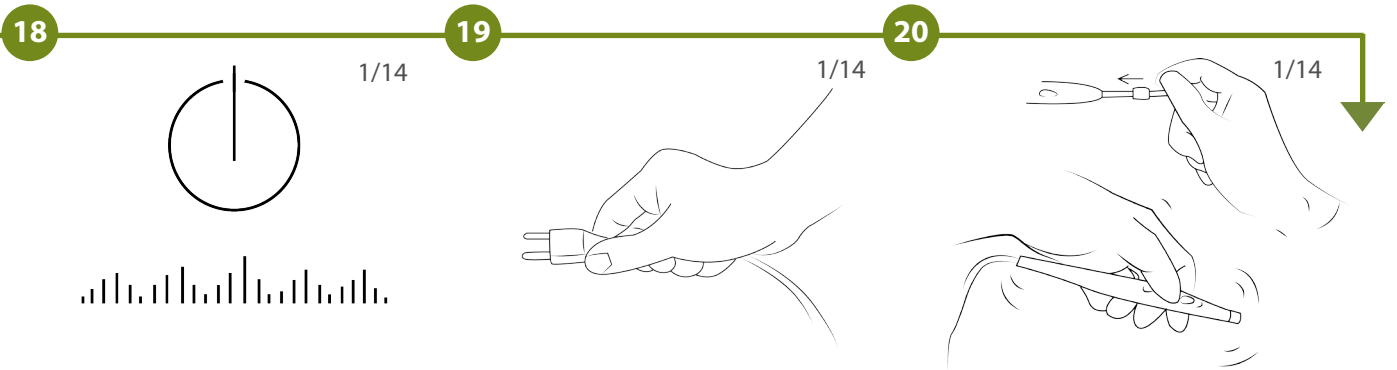
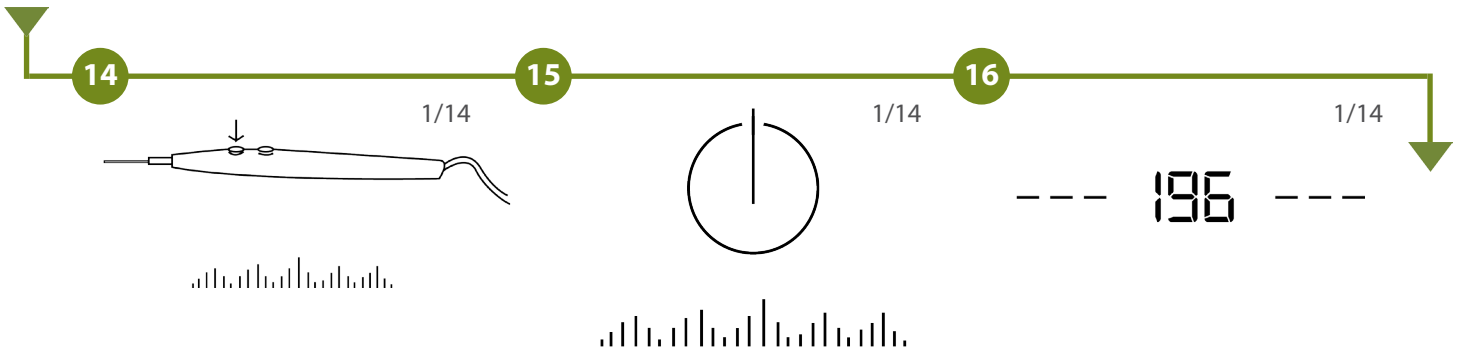

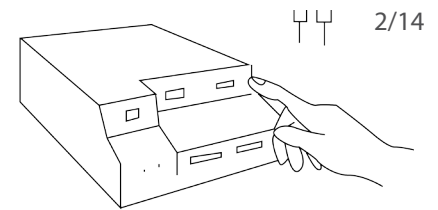

(29) At the moment the anaesthetist is standing next to the HF generator. Therefore, (s)he decides to increase the power settings by 10W by pressing the up-buttons. (30) After some time of use the eschar builds up on the active electrode tip. The staff waits very long before removing the eschar.

(31) Then the surgical assistant tries to remove the eschar build-up with his/her fingers.

(32) Since this does not remove all the eschar, the surgical assistant passes the handheld to the scrub nurse, who uses a forceps. With the forceps all the eschar build-up can be scrubbed off.

(33) Suddenly there is a power outage. As a result all the machines except for the anaesthetic machines turn off. (34) After a few minutes the power goes back on. This means that the ESU automatically turns on and selects its last used power settings. Therefore, the procedure can immediately continue.

(35) At the end of the surgery the surgical assistant closes the wound. Usually (s)he gets help from the scrub nurse, because the surgeon usually leaves at this point.

Post-surgical treatment

(1) When the wound is closed the scrub nurse turns off the HF generator. (Sometimes the generator is turned off earlier during the procedure when it is clear that the ESU is not needed anymore).

(2) The nurse then unplugs the return electrode, removes the return electrode sticker from the patient's body, and lays it on top of the HF generator. Often also other objects are placed on top of the generator and are touching the return electrode sticker. The disposable return electrode sticker is reused up to 50 times according to the staff. The return electrode is not protected against dust and dirt. During the reuse of the sticker it can not be cleaned because of the loss of stickiness. Therefore, the return electrode pad gets very dirty after a while.

(3) The nurse unplugs the handheld and puts it back into the box with Cidex which located in the room between the operation theatres.

(4) The nurse and scrub nurse tidy up the operation theatre. Used blankets, rubbish and the used instruments are passed through a little window to the cleaning room.

(5) After the rubbish is out of the theatre the entire room is cleaned by the cleaning staff by using a floor mop.

(6) Also all used instruments are cleaned by the cleaning staff. Afterwards the instruments are put back into the box unsorted.

30

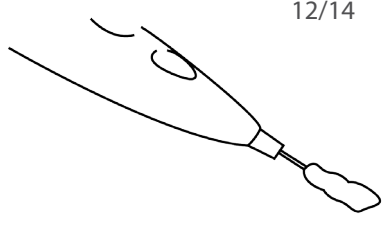

12/14

31

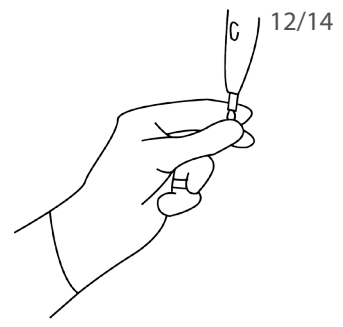

12/14

32

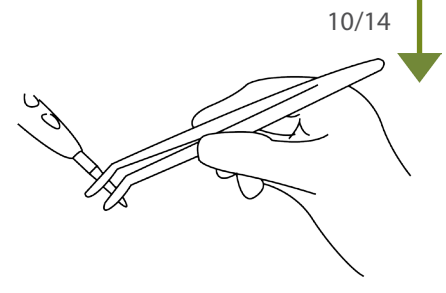

10/14

33



3/14

34

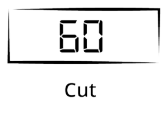

Cut

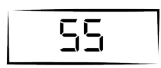

Coag.

3/14

35

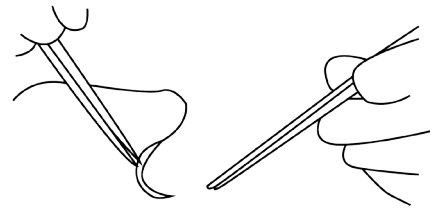

14/14

1

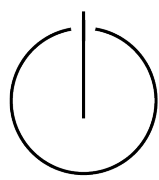

14/14

2

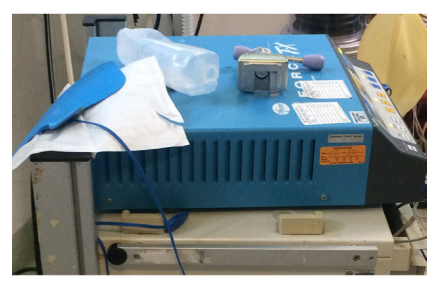

14/14

3



14/14

4

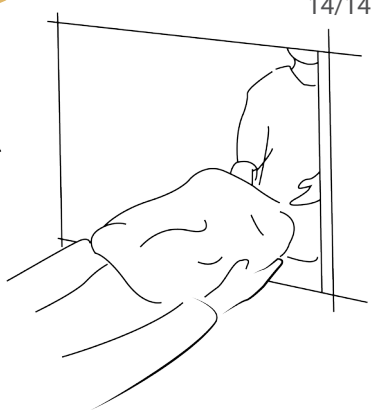

14/14

5

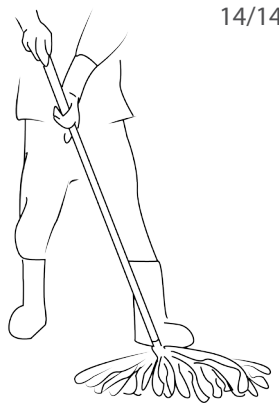

14/14

6



14/14

(7) Someone from the cleaning staff then brings the instruments to the autoclave room, (8) where the staff sorts the instruments and puts them into the correct boxes. They then wrap the boxes with blankets.
(9) These prepared boxes are put into the autoclave. After autoclaving every box gets a expiration date.

Maintenance

(1) From time to time a BMET cleans the machines. This is the only maintenance that is done with the ESUs. Ideally there should be a preventive maintenance on a six month basis. However, there are not enough resources to have spare parts in stock. The hospital management does not allow the BMETs to buy spare

parts if the machine is not broken yet. However, it can take weeks to receive a spare part, which is a problem when the machine is really broken.

Repair

(1) When an ESU is broken, they often use parts from another ESU to repair it. This is often done with the capacity. Then the ESU's do not need to be from the same manufacturer. In case of other broken parts they mostly need to order new spare parts. This can

take a long time or might even be impossible. This is especially difficult when the machine was donated and therefore very old and not manufactured anymore.

Disposal

(1) In case an ESU is broken and cannot be fixed anymore a BMET will report this to the disposal committee. After that a new machine is ordered.
(2) The disposal committee comes by to check if the ESU is really broken beyond repair and if a new one is needed.
(3) If the committee approves, the ESU will be disposed in a special container which is located at the hospital terrain. Or, sometimes the hospital decides to donate broken ESU's to the university or healthcare college, so that the BMETs can practice the repair of such machines.
(4) In case the ESUs are disposed, the hospital extracts the raw materials such as metal and sells it.

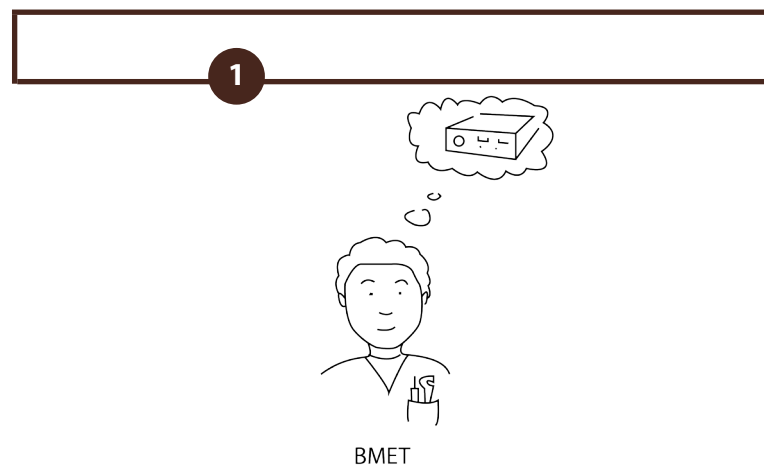

7



8



9

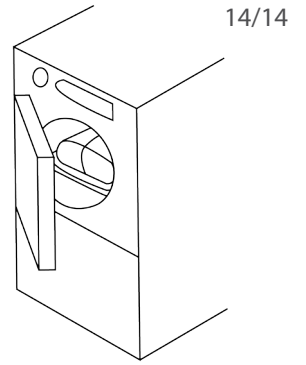

1

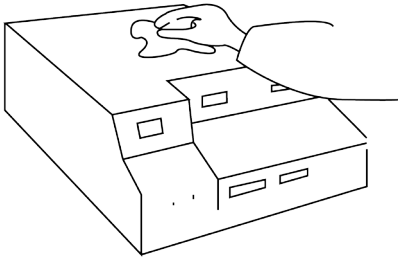

1

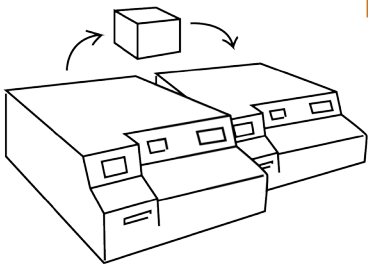

2

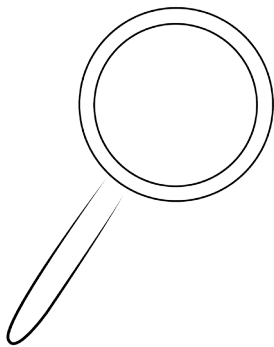

3

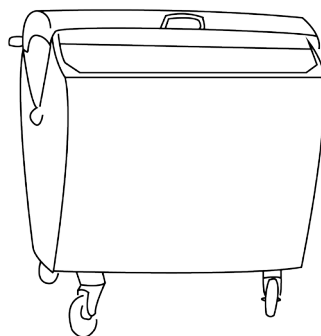

4

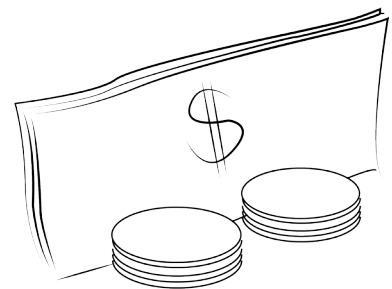

Takeaways context study

The presented phases and activities provide a detailed overview of the electrosurgical equipment journey. The goal was to describe the journey of the equipment without making a judgement about the safety.

In the next chapter the objective description of the activities and its stakeholders will be laid next to the technology related risks and the user profiles in order to judge the safety of the activities which occur within the equipment journey.

1.2.4 Pinpointing & Assessing Risks within the Electrosurgical Equipment Journey

The first aim of this research study was to fill the current knowledge gap and to map out the electrosurgical journey and its related risks for the Global Health project. So far the activities with the electrosurgical equipment and the users that are involved in those activities were mapped out in detail. Now, the insights from the three conducted studies about the technology, the context and the user will be combined to reveal the potential safety risks within the journey. Only when combining these insights it becomes clear which risks that are generally related to electrosurgical equipment are likely to be triggered by the low-resource context to occur.

In figure 20 it is shown how the different studies were layered to reveal the safety concerns. In this chapter only the activities which trigger hazardous situations are presented (see pp. 47 - 53).

Reminder research method

Objective:

- Pinpointing safety concerns within the equipment journey

Method:

- Pinpoint all the activities in which a user is involved and determine if the user characteristics influence the safety of that activity by laying the user profile next to it
- Investigate if the technology related risks are triggered by the context and influence the safety of the activities within the journey

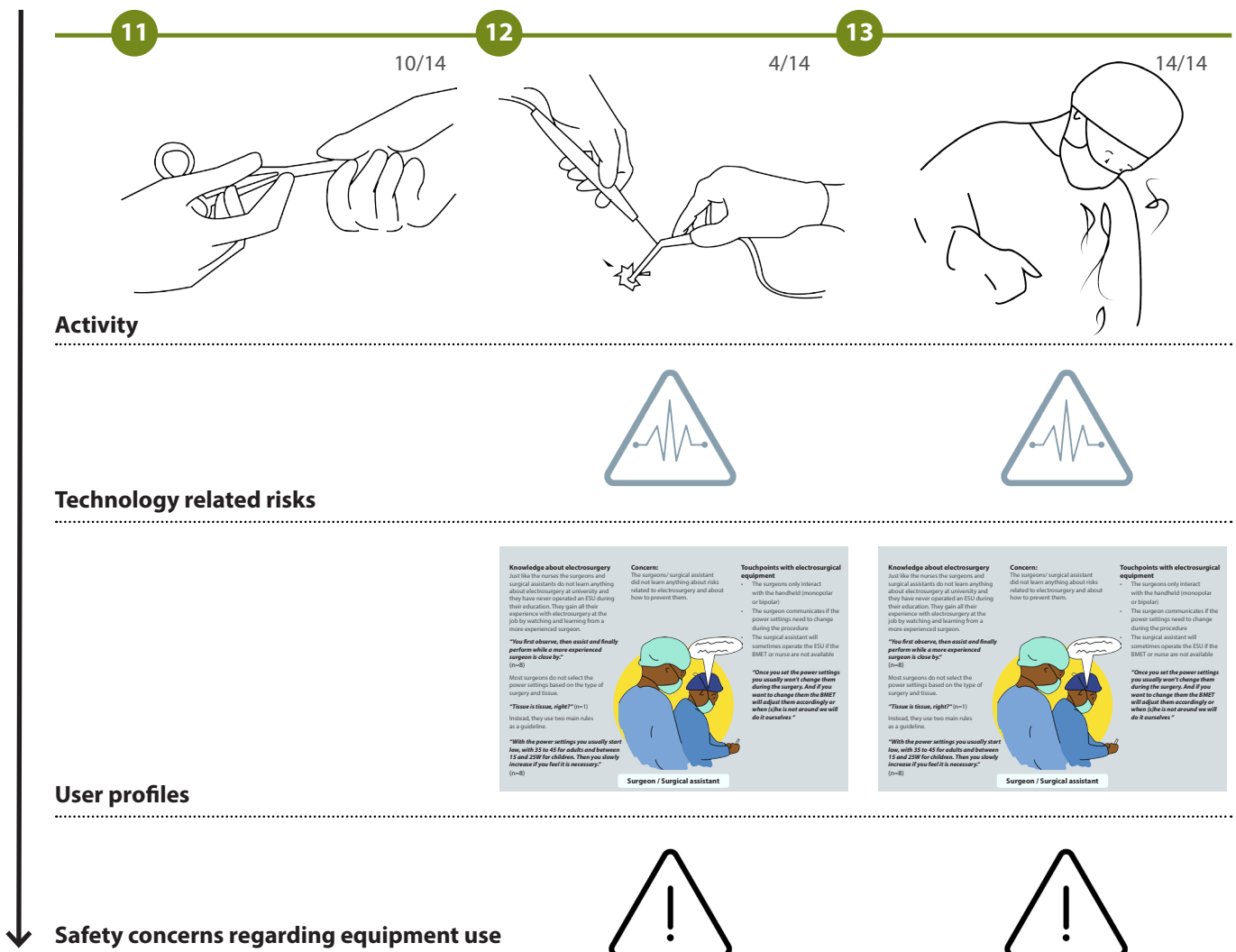
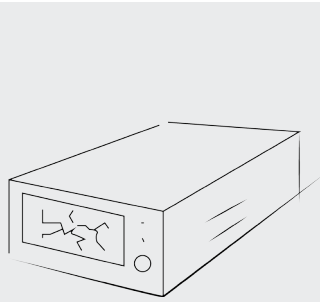

Figure 20: Discovering safety concerns by combining research insights



Broken due to transport

A problem that often occurs, is that machines are already broken when they arrive. Main reason for this is transport. The roads are very bumpy and not well maintained.

Often it takes some time to get spare parts and to be able to repair the machines. In case of donated equipment it is often even impossible. A broken machine means no electrosurgery and thereby disadvantages for the patient.

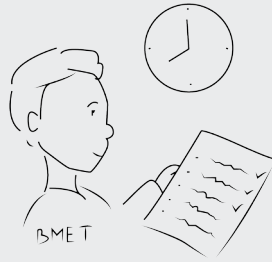

No daily routine check

The daily routine checks of the machines are not always done. And sometimes the BMET starts too late and then some surgeries are already ongoing. In that case a check of the machines is also not possible.

There is no schedule for the daily routine checks. Therefore, it is not clear for the BMETs who will do the check and if it has already been done.

Some ESUs might not work properly or might be broken. If this is not checked prior to the surgery, it can cause a delay during the procedure.



Leaving sterile zone

Nurse leaves sterile zone during procedure and enters again without taking necessary actions.

Often a shortage of human resources causes events such as described above. Sometimes there is no OR assistant around yet who can grab things from the unsterile zone and pass them to the nurse.

Leaving and re-entering the sterile zone when already wearing sterile clothes increases the infection risk for the patient. The nurse might get in contact with unsterile objects and people.

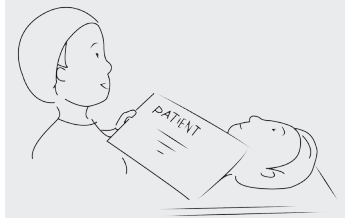

Not checking patient info

The surgical team does not go through the patient checklist together. Furthermore, the nurse usually does not use the designed checklist that would guide her through the questions.

The team might miss important information, such as age and vitality of the patient. These are both important factors when considering the power settings.

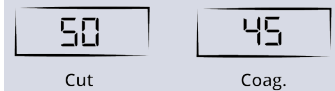
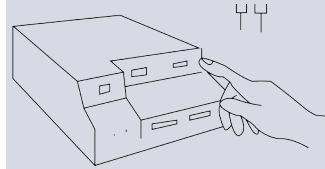
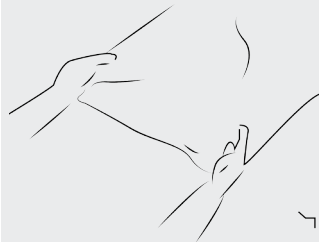

Context

Inproper placement patient plate

The return electrode sticker is re-used up to 50 times. After a while its stickiness is gone & the plate loses contact. Therefore, the nurses place the patient plate underneath the body to ensure contact. Often the plate is placed underneath the shoulder.

Technology

One should avoid areas with irregular body contours, bony prominences, excessive hair and scarred tissue. Moreover, the areas where the patient touches the surgery table are to be avoided, because the blood circulation is reduced at these spots.

User

The nurses did not receive any training during their education on how and where to place the patient return electrode.

Resulting Risk

No proper placement of the return electrode can cause patient plate burns and a delay in case the plate loses contact and needs to be re-attached.

Cover with blankets prior to connecting patient

The medical staff covers the patient with blankets before the patient plate is plugged into the HF generator. If the patient plate is not correctly attached and the alarm goes off, the blankets need to be taken off again.

Most modern ESUs have a Return Electrode Monitoring system, which makes sure that in case of a reduced contact area the machine gives an alarm and deactivates the handheld.

The medical staff has not learned anything about the right order of steps. Everyone is performing his/her tasks to prepare the surgery, but more guidance is needed to ensure a logical order.

When the patient plate is plugged in and the alarm goes off, the blankets need to be removed again so that the nurse is able to reattach or replace the patient plate. This delays the surgery.

Operating the ESU without experience

Often there is no clear task division. ESU operators change according to available staff. Someone who is in the OR and has no other task at the moment turns on the ESU. Not enough BMETs to be present during every surgery.

The ESU has an interface with a lot of different functions/modes.

Ideally a BMET should turn on the ESU and put it onto the right settings. But since there are not enough BMETs, often someone from the medical staff who has not much experience needs to take it over.

Especially new medical staff members might make use errors and for example put the ESU on too high power settings.

Select power settings without experience

A lot of nurses assume that the BMETs pre-set the ESU during their daily routine checks, and therefore do not change last used high settings. However, the BMETs do not select any settings prior to surgery.

High settings have a different tissue effect.

Ideally, the BMETs should operate the ESU and are responsible for the working of the machine. The medical staff knows that the BMETs are the expert of the ESUs and assume that they take care of the settings.

Medical staff might not change high start settings. This might lead to an undesired tissue effect.

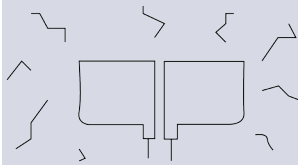

Miss alarm sounds

Users miss alarms when volume has been set too low. Moreover, there are a lot of other machines in the room such as the anaesthetic machines that make similar sounds. Additionally, the ESU is placed behind the staff's back and therefore they cannot really see the red alarm sign blinking.

User might miss alarms. No action can lead to different patient harms according to the type of error

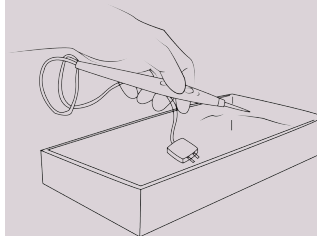

Handhelds put in Cidex

The handhelds are taken out off a box with Cidex by the OR assistant and are passed to the nurse who is drying it with a bandage and taps it onto the surgical table to make sure no Cidex is left inside.

The material of which the handhelds are made are not resistant to Cidex and will degrade after a while.

The medical staff has not learned anything about risks and risk prevention concerning electrosurgery during their education.

If the plug is not dried properly, the user who plugs in the handheld might get electrocuted.

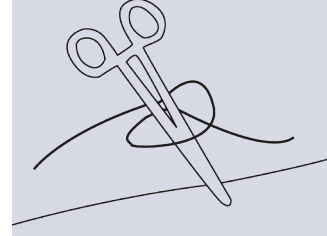

Current leakage

The surgeon and surgical assistant wrap the cables of the handhelds around metal clamps so that the handhelds cannot fall onto the ground during the procedure.

Conductive objects such as metal instruments, may be charged by the cords and current will run through them. The current might continue its way into the patient's body if the conductive object is touching it.

The medical staff has not learned anything about risks and risk prevention concerning electrosurgery during their education.

This might lead to patient burns during prolonged exposure.

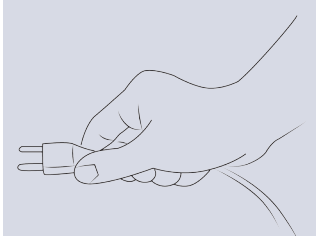

Plug in cables without experience

A medical student is asked to operate the HF generator and plug in the handheld, but has never done that before.

The ESU has an interface with a lot of different functions/modes.

She seems a bit insecure and needs guidance.

These situations might stress the user and lead to a delay of surgery.



Placement handheld

When not being in use the handheld is placed on the blanket, on the table or sometimes even on metal instruments such as clamps. In some occasions the active electrode tip is touching a piece of bandage which the surgical team uses to absorb blood from the wound.

The handheld should not be placed on top of the patient, conductive instruments and flammable materials such as bandages fueled with alcoholic disinfectants.

The medical staff has not learned anything about risks and risk prevention concerning electrosurgery during their education.

Accidental activation could cause accidental ignition of flammable materials and unintended burn wounds.

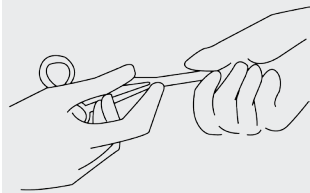

Look for instruments

Often it is hard for the nurse to find the right instruments in the big boxes. This delays the surgery. Especially when the surgeon and surgical assistant ask for instruments at the same time, the stress and workload increases.

There is often a shortage of human resources, which increases the workload for the staff.

This delays the surgery and causes stress for the nurse.

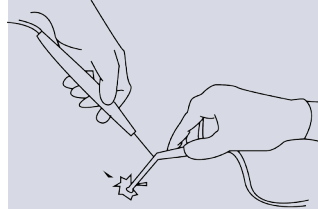

Direct coupling

During the procedure the surgical assistant intentionally touches the metal tip of the suction tube with the active electrode. The current is flowing through the tip of the suction tube and creates a spark. The tip is creating a coagulation effect at the patient's tissue.

When the active electrode touches a metal instrument that is not in touch with the patient's tissue, the current will pass through the operator's hand.

This can result in perforating the operator's gloves, and burn wounds.

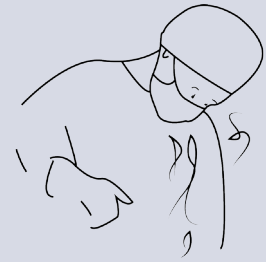

Electrosurgical smoke

The medical staff does not wear glasses to protect themselves from the electrosurgical smoke.

Electrosurgical smoke may contain toxic gases and vapors, such as formaldehyde, dead and live cellular materials and bioaerosols. The smoke may cause upper respiratory tract irritation and create visual problems among the surgical team.

The electrosurgical smoke may contain toxic gases and create visual problems among the surgical team.

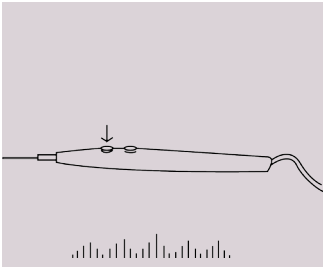

Continuous cut mode

Suddenly the ESU stays in continuous cut mode. There is a continuous cut sound and the yellow light on the HF generator is on. The surgeon is unable to change the setting with the handheld.

Due to extensive use the buttons on the handheld often get stuck after a while.

When this happens during the procedure the surgeon might accidentally cut tissue.



Unclear error messages

The staff has no idea what the number 196 on the screen stands for.

The current ESUs give no informative error message.

The medical staff has not learned how to react to a system alarm.

Not knowing what to do in case of an error delays the procedure.



Looking for BMET

Someone is rushing to find a BMET, but this takes time because no BMET is in the workshop. They have no hospital phones to call each other.

Looking for a specific person can take some time. The BMETs could be everywhere in the building. This delays the procedure.



People observing

Most of the doors are open and sometimes there are up to almost 20 people in the operation theatre.

The more people in the operation theatre and especially in the sterile zone, the higher the infection risk for the patient.

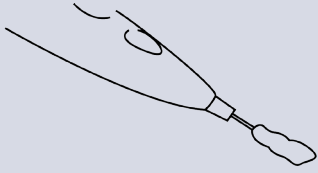

Eschar build-up

After some time of use the eschar builds up on the active electrode tip. The staff waits very long before removing the eschar.

A lot of eschar further increases the resistance of the electrode tip. The eschar build-up reduces the performance of the ESU.

As a result medical staff might increase the power settings.

Cleaning and storage patient plate

After the return electrode is removed from the patient's body it is placed on top of the HF generator. It is not being cleaned, because then the stickiness would completely disappear. Moreover, it has no protection against dust and dirt.

The return electrode stickers are not designed for re-use.

When the return electrode plate is not cleaned, and re-used multiple times it increases the infection risk for the patient, since it is placed close to the surgical site.

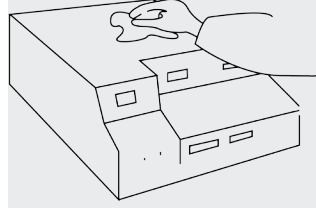

No proper preventive Maintenance

The only maintenance that is being done is undusting the machines from time to time. They have no resources to do preventive maintenance.

When no preventive maintenance is done the machines get broken more fast. A broken machine means no electrocautery.

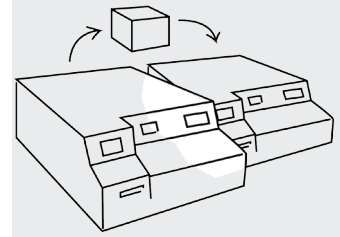





Difficult to get spare parts

Repairing the ESUs is a difficult tasks, since most ESUs are very old and not manufactured anymore. Therefore, ordering spare parts is often not possible.

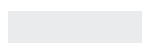
Without certain spare parts the machines cannot be repaired. If here are no back-up ESUs electrocautery might not be possible in every operation theatre.

The risk analysis shows that there are a lot of safety concerns regarding electrosurgery in a low-resource context. The potential safety risks were clustered into four groups based on their main root causes. The four clusters are Policy/ Organization, Information/ Interaction with interface, Patient plate design and Handheld design. To each risk category a color was assigned (see pp. 47 - 52). The color coding can be seen on the right.

-  Policy / Organization
-  Patient plate design
-  Information / Interaction with interface
-  Handheld design

Risk assessment

The potential safety risks which were identified by combining the insights from the context, technology and user study are also assessed on their severity. In order to determine the severity of a risk the probability for the risk to occur and the impact it would have on the user and/or patient were determined. The probability and impact were rated on a three-point Likert scale.

At first the probability that a certain situation, namely the interplay of an activity, a technology related risk and user characteristics, would harm the user and/or patient was determined. Therefore, it was looked at the frequency which was added to every activity in chapter 2.3. The more often an activity is likely to occur during the equipment journey, the more likely the interplay of factors will lead to an actual risk. For every safety concern previously identified it was estimated if the probability for a risk to occur was low (1), medium (2) or high (3) (see table 3).

Next, it was estimated if the impact that the risk would have on the user and/or patient would be low (1), medium (2) or high (3) (see table 3). Therefore, it was looked at how serious the direct impact on the user

Reminder research method

Objective:

- Assess the severity of the potential safety risks

Method:

- Determine the probability of the risk to occur
- Determine the impact the risk would have on the user and/or patient
- Calculate the severity of the risk

and/or patient would be. Many risks that occur during the surgery score a high value on impact, since the hazardous situation would have immediate and direct impact on the user and/or patient. Risks that are more related to organization often score lower on impact, because the hazardous situation does not directly harm the user and/or patient.

The calculations reveal that most of the high severe risks lie in the Information/ Interface interaction category. But also potential risks related to the patient plate and handheld design score high on severity.

Takeaways risk assessment

The identified risk categories show that the safety of electrosurgery is dependent on a complex system of factors. In order to improve the overall safety of electrosurgery in low-resource settings aspects of the organization in the hospital, the information provision for the stakeholders and the design of the equipment need to be improved. Design solutions need to address all these different layers of the system in order to improve the overall safety.

In part 2 of this project it is shown how to use the equipment journey to design an intervention that aims at preventing electrosurgical risks to occur (see part 2, pp. 61 - 80). Therefore, the risks from the Information/ Interface interaction category are taken as an example.

Additionally, the equipment journey was transformed into an online tool to serve other designers and researchers as a source of information. The usability and value of this tool in other projects was evaluated. The results can be found in chapter 1.3.

Safety concern	Probability	Impact	Severity
Broken due to transport	2	1	2
No daily routine check	3	2	6
Leaving sterile zone	3	2	6
Not checking patient info	3	2	6
Covering with blankets prior to plugging in patient plate	2	1	2
Struggle to find instruments	3	1	3
Not enough BMETs	1	2	2
People observing the procedures	3	2	6
Poor preventive maintenance	3	1	3
Trouble with ordering spare parts	3	1	3
Inproper placement patient plate	3	3	9
No cleaning patient plate	3	2	6
Storage patient plate	3	2	6
Operating ESU without experience	3	3	9
Select power settings without experience	3	3	9
Miss alarm sound	1	3	3
Current leakage	3	3	9
Incorrect placement handheld	3	3	9
Glove burn	2	3	6
Electrosurgical smoke	3	2	6
Unclear error message	1	3	3
Eschar build-up	3	2	6
Handheld put into Cidex	3	3	9
Continuous mode	1	3	3

Table 3: Healthcare system

1.3 Research Results Part B: Digital Equipment Journey

1.3.1 The digital Equipment Journey

The result from the research study about the electrosurgical equipment journey were processed in an online tool. Creating an interactive online journey enables other designers and researchers interested in the topic to get an insight into the whole equipment journey. The Journey was build in Invision and contains the results of the context, technology, user and risk study. The document is layered in order to show the interplay of the context, technology and user. At the bottom the resulting potential safety risks are displayed (see figure 22 & 23). Every step is

represented with an illustration or photo. The document contains a front page with all the phases of the journey and a short introduction to the users and their knowledge about electrosurgery (see figure 21). By clicking on a phase on the front page the user is directed to the activities within that phase.

Equipment Journey of the Electrosurgical unit Exploring safety concerns

In the illustration below you can see the overview of the equipment journey of the electrosurgical unit in a Kenyan hospital. By clicking on a phase you will be directed to activities within that phase. On every page there is a home button which will bring you back to this overview.



Experiences with electrosurgery

"We learn a lot about electrosurgery in college, like the basic principles between the electrosurgical unit from different manufactures."



"I haven't learned anything about electrosurgery at healthcare college. They only mentioned that such a thing exists."



"You just learn about electrosurgery at the job. First you observe, the assist and finally perform. You just need experience I guess"



"It is not that we have books for that where we can look it up. You just start low, between 35 and 45, and then you increase if necessary. It does not depend on tissue type, tissue is tissue, right?"



Figure 21: Front page equipment journey

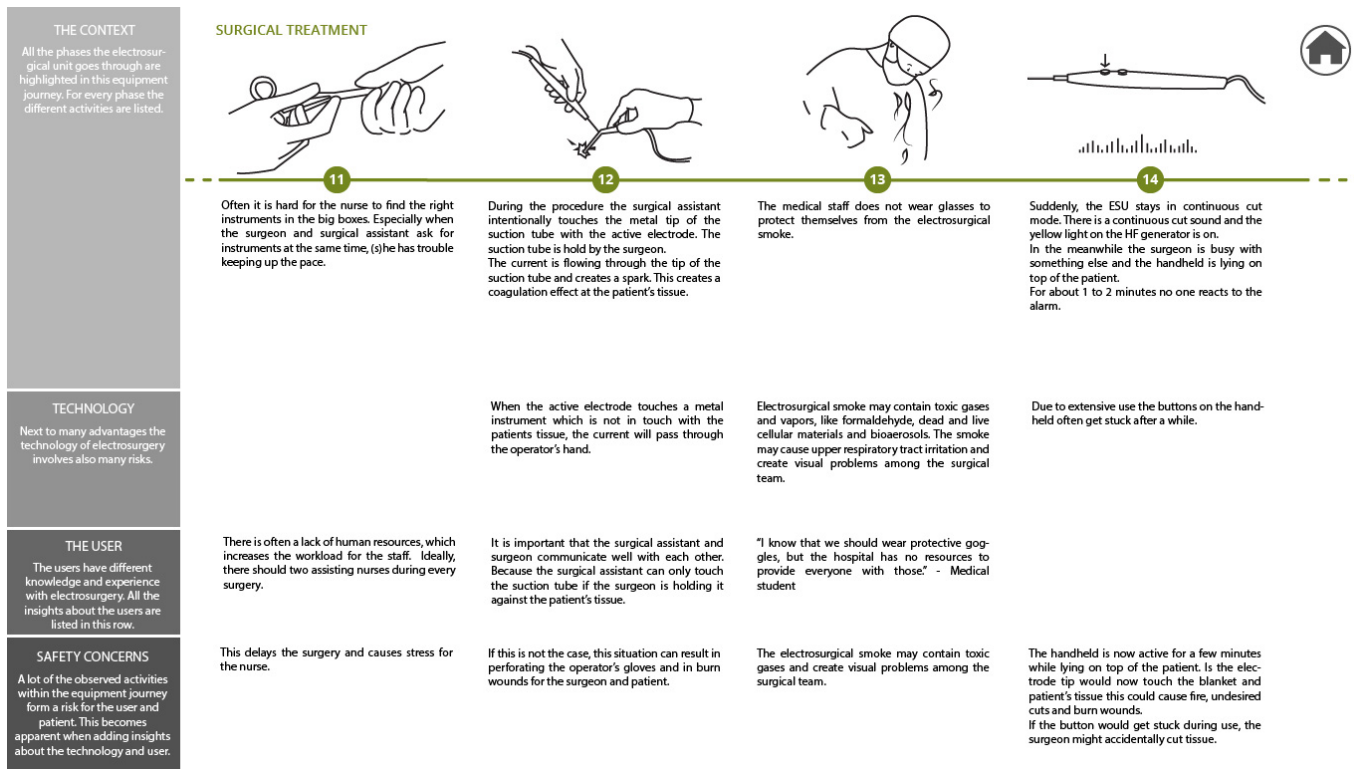

Figure 22: Surgical treatment phase digital equipment journey

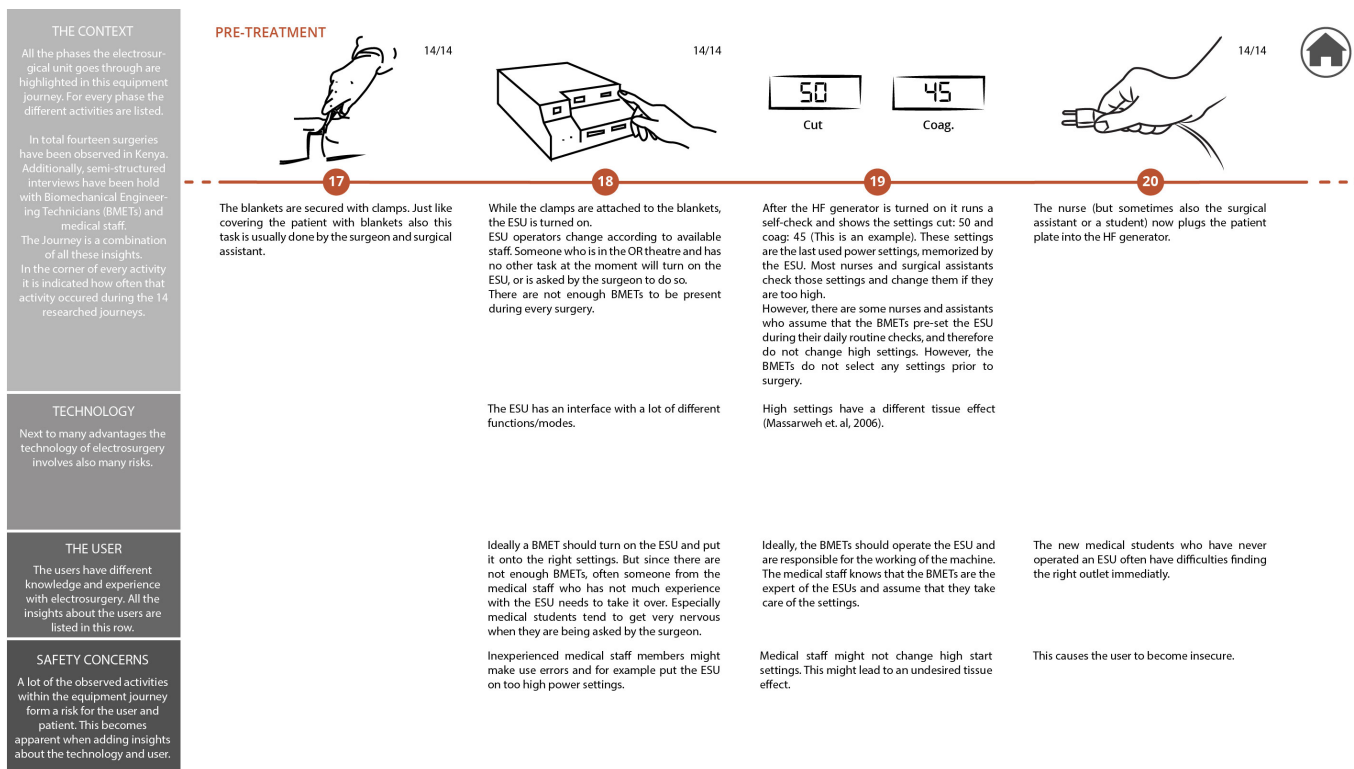

Figure 23: Pre-treatment phase digital equipment journey

1.3.2 Evaluation of the Equipment Journey as a Research Tool

The usability and value of the digital equipment journey for other designers and researchers was evaluated with five participants. The first three participants were Industrial designers with no experience of designing for healthcare settings. Some results of these first three evaluation sessions were processed prior to the last two sessions and led to an adjusted design of the digital equipment journey and session set-up. These changes will be described after the presentation of the results of the first three test sessions.

Feedback designers

Gaining new insights

All the three participants (referred to as P1, P2, P3) gained new insights from the equipment journey. As could be seen on their assumption forms and as they confirmed in the interview, they filled out the assumption form based on their own experiences as a patient in a Dutch hospital. Therefore, none of the participants thought about the biomechanical engineering technician, since this usually is not a stakeholder a patient directly interacts with. The participants expressed that they find the journey very interesting, because almost all the information was new for them.

P2 said that the journey gave her the impression that hospitals in low-resource countries need to cope with less staff members than in a Western country. But she was also astonished that it seems as if everything is quite well organised and that there is skilled staff available. Before reading through the journey she had the assumption that in a hospital in a low-income country the most basic equipment would be lacking and that everything would be much worse than presented in the journey. For another participant (P3) the journey revealed opposite insights in a sense that she expected some events much more comparable to Western standards. She for example did not expect that everything was still done on paper instead of on the computer such as filling out checklists.

Usage of the equipment journey in a project

All the three participants think that the equipment journey can be a valuable tool at the beginning of a

The interview data was sorted to reveal opinion patterns. At first it was evaluated if the participants gained new insights from the journey. Additionally, the participants' feedback about the usability of the journey in a project, the visual presentation and the presumed reliability of the equipment journey was collected. Moreover, the participants were asked to reflect if they miss certain information in the journey and if they have recommendations for improvement.

Reminder research method

Objective:

- Assess whether users gain new insights into the context
- Evaluate whether the tool helps users to empathize with the context and check if the tool is valuable for other projects
- Gather feedback on the journey's design

Participants:

- Designers who have no experience with designing for healthcare settings
- Biomechanical engineers who have some knowledge about operation theatre settings
- None of the participants has ever visited a hospital in a low or middle income country

Method:

- Fill out assumption form to check participants current knowledge about the context
- Explore the digital equipment journey
- Exit interview

Data analysis:

- Comparing assumption forms to interview answers to explore if participants gained new insights
- responses were gathered and organized into related groups to reveal opinion patterns

project. It provides important insights to the context, especially for project members who cannot witness the process in person. All the participants mention



that they would use the journey to define a focus at the beginning of the project. Two participants (P1 and P3) describe that they would look for all the touchpoints between user and equipment and would focus on the safety concerns mentioned in the journey. Then they would choose one or several of those moments to address in their project. P1 says that she would then dive deeper into these safety concerns by doing additional research and create a new journey which specifically focuses on the chosen situation.

P2 thinks that the equipment journey provides a useful starting point for the researcher, but that he/she also needs to gather additional insights into the problem afterwards. The journey makes it easier to formulate specific research questions for this additional study.

P1 thinks that the equipment journey can still be very useful in a later stage of the project. She would use the journey to look back at the steps which happen before and after the chosen safety concern to identify who is involved in the situation and where an intervention could be effective.

The visual representation of the journey

The visualization of the data in form of a journey was positively perceived by all the three participants. They prefer the information being split into steps and layers over a piece of text. The participants liked that there is an illustration of every activity. P1 and P2 think that the visuals are very self-explanatory and describe that the visuals help finding back specific information. The division of the text in steps supports this.

The participants agree upon the fact that a photo gives a better impression of the context than an illustration. However, the illustrations are better suited for leading the focus to a specific action. Therefore, the participants value the combination of illustrations and photos as long as the message comes across.

P1 states that she likes that the journey is divided into layers. P3 suggests to create a more interactive journey in which it is possible to manually show and hide the different layers. Additionally, P3 and P2 propose to implement the 3 30 300 rule, which means that within 3 seconds the user is attracted by the journey and grasps the topic, within 30 seconds the key message is understood, and within 300 seconds the entire page can be read.

P2 thinks that since the intention of the journey is to reveal safety concerns within the journey, this section should be highlighted to attract more attention. Currently, this information gets a bit lost.



Finally, P3 suggests to add a keyword to every activity in order for the user to know within seconds what that activity is about.

Missing information

Despite the generally positive reactions of the participants, there is some information which they currently miss in the journey. P2 and P3 would like to see an introduction into the context at the front page before diving into the details. P2 says that it would be a valuable addition to add some photos of the context at the front page such as the operation theatres, the hospital and the staff. This would help to get an idea of the setting in which the equipment journey takes place. A photo also immediately clarifies the differences and similarities with Western hospitals. P2 assumes that this will bring the users into the right mindset before reading through the equipment journey.

Another important insight from the evaluation was that for P1 it was not clear that the document represents the equipment journey in a low-resource healthcare context. At least the title should communicate the context in which the journey takes place.

Reliability

The participants said that while reading through the journey they did not question the reliability of the

journey. However, when further thinking about it P2 and P3 would prefer to have a short explanation of the used research method at the front page. P1 does not miss an overview of the method, but likes to see some more quotes and photos. Adding some more raw data would increase the reliability.

Changes to the test items & evaluation set-up

Prior to the last two evaluation sessions some changes have been made to the digital equipment journey and the evaluation set-up. Since two participants only managed to read until activity 12 and one participant until activity 8 out of the 35 activities within the pre-treatment phase, it was decided to focus the last two sessions only on the pre-treatment phase. This means that also the assumption form was adjusted, because all the questions related to the procurement phase were taken out. This also solved the problem that participants took much longer to fill out the assumption form than the expected five minutes.

Based on the participants feedback about the layout and reliability of the equipment journey some changes were made to the front page of the document (see figure 24). Since the first evaluation sessions revealed that the participants would like to see more information about the research method that was used

Journey of Electrosurgical Equipment in low-resource Settings

Exploring safety concerns

This document provides a representation of the electrosurgical equipment journey in low-resource settings. Next to describing the phases and activities the equipment goes through, this journey aims at revealing safety concerns related to electrosurgery. Therefore, also the technology and the stakeholders were researched. The interplay of context, technology and stakeholder reveals safety concerns.

Context study - Phases and activities of the electrosurgical equipment

As can be seen below the journey is divided into seven phases. By clicking on a phase you will be directed to activities within that phase. The number next to the name of each phase represents the amount of activities within that phase. On every page there is a home button which will bring you back to this overview.

The data for the pre-treatment, surgical treatment and post-treatment phase was collected by observing 14 surgeries in a Kenyan national hospital. The data for the procurement, maintenance, repair and disposal phase was mainly collected by conducting semi-structured interviews with 6 Biomechanical engineering technicians.



The Technology and its potential for hazards

In order to get an understanding about electrosurgery and risks that come along with this technology a literature study was conducted. Scientific papers and books about electrosurgical risks have been searched

on Google Scholar. Additionally, previous graduation reports on the topic of electrosurgery have been consulted. The described risks are generally related to electrosurgery and therefore also applicable for Western countries.

The users

On the right the different users are illustrated. In order to find out about the user's knowledge regarding electrosurgery, the use of the equipment, and their concerns semi-structured interviews have been conducted. The interviews were semi-structured to be able to ask follow-up questions to get deeper insights.



Safety concerns

A lot of the observed activities within the journey form a risk for the user and patient. This becomes apparent when looking at the interplay of context, technology and user.

Figure 24: Front page equipment journey

to gather the information, a short overview of the method was added to the front page. In line with that the layout of the front page is now more comparable to the rest of the journey. Based on the comment of P1 the title of the document was changed in order to make clear that the document is a presentation of the electrosurgical equipment journey in a low-resource healthcare setting.

The whole journey can be found by scanning the QR code.



Feedback biomechanical engineers

Gaining new insights

P4 said that he did not gain new insights. However, his assumption form shows that not all his assumptions map the reality. He for example assumes that disposable equipment is thrown away, instead of being reused. P5 does not mention specific insights that were new to him, but he explains that it is very valuable that the journey represents the reality. Especially, because literature often only describes how things should go, but not how they really are in the actual context.

Usage of the equipment journey in a project

P4 thinks that the journey is a good tool to get an overview of the whole situation. Papers are usually very focussed on a specific part of the journey or a certain problem. He thinks that the journey serves as an inspiration to choose a focus point for a project. After that the designer needs figure out himself where to intervene with a design, but the equipment journey helps with that, since it provides an overview of everything that is already done during the procedure. P5 sees the journey as unique source of information at the beginning of the project. He is currently trying to find a focus point for his PhD project which will also be part of the global health initiative. He says that the journey provides the type of information he

is currently looking for, namely information about the use of surgical equipment in real life. He thinks that the journey can be a helpful additional source of information which helps to define a focus within a project, especially when you are not yet able to go to the context. Once you defined a focus point the journey can be used to better understand that specific moment of use.

The visual representation of the journey

Both participants have no design background and journey mapping is completely new to them. However, both participants like that the information is split into steps and layers. They prefer this way of data presentation over an article. P4 said that he did not pay a lot of attention to the illustrations, but was primarily focussed on the text. P5 thinks that not for every activity an illustration is necessary. Both participants mention that photos add more value to the journey than the illustration, since they give an impression about the context. However, according to P5 illustrations are useful when aiming at demonstrating a specific action.

Missing information

P5 does not mention specific information that he misses in the journey. He says that he likes the journey as it is, but thinks that the journey cannot replace a literature study.

P4 would like to see more background information at the front page. He misses information about the hospital in which the equipment journey was researched. He would for example like to know what kind of surgeries are performed in the hospital, if patients need to pay for their stay, and if the hospital is sponsored.

Reliability

Both participants like that for every activity it is indicated how often it was observed out of fourteen surgeries. However, P4 thinks that an activity that was only observed once does not say a lot and he would not use that data, since it could just have been a coincidence.

P5 would prefer to see more raw data in the equipment journey, which he could filter out and translate the information into numbers and put it into tables.

Conclusion digital equipment journey

The digital equipment journey is intended to serve other designers and researchers as a tool to gain insight into electrosurgery in LMICs without needing to go to the context themselves. In this evaluation study it was tested if this tool fulfills this purpose.

All the participants imagined the tool to be a valuable source of information in a project. The equipment journey helps the users to empathize with the low-resource healthcare context and to define a scope / problem for a design project. For the participants with no previous knowledge about the healthcare setting most the information was new. The participants with a biomechanical engineering background especially valued the fact that the journey represents the reality and provides a detailed overview of the whole procedure. All the participants think that once a focus point defined by using the journey more in depth research is needed. However, knowing what happens before and after the chosen situation is valuable information for coming up with a design intervention. All the participants enjoyed the visual representation of the journey. The division of the information in steps and layers enables the user to easily process the large amount information. Photos provide more insight into the context than illustrations and they help users empathize with the context. In general the document currently lacks a bit of hierarchy. This makes it difficult for the user to filter out important information. Visually, it was not clear to all the participants that an important goal of the journey is to reveal safety concerns. Additionally, it is currently communicated well enough in which setting the equipment journey takes place.

After adding information regarding the research method to the front page based on the first three participants, the last participants did not mention that they miss insight into the method.

As a conclusion it can be stated that the equipment journey is a valuable tool for gaining insights into the activities, stakeholders and safety concerns related to electrosurgical equipment. Furthermore, it helps the user to empathize with a context in which they have never experienced before.

Recommendations

Despite that the equipment journey tool was perceived positively so far, there is still room for improvement. In this chapter some recommendations for future improvements will be presented.

- Before diving into the detailed presentation of all the activities within the journey, the user should be introduced to the low-resource healthcare context in which the research study took place
- In the future the journey should be made more interactive. The users should have the chance to show and hide certain layers of information according to what they are looking for
- There should be more hierarchy in the document, helping the user to coordinate through the information
- It should be considered to replace more illustrations with photos if the context of that activity contains valuable information
- More raw data should be integrated into the journey, especially quotes.

In general it should be researched if the equipment journey is also valuable for mapping out the journey and the related safety concerns of other surgical equipment.

1.4 Conclusion Part 1: The Equipment Journey

Part 1 was split into two parts. Part A aimed at mapping out the electrosurgical equipment journey and its related risks. There are many general risks related to electrosurgery such as patient plate burns, current leakage and glove burn, just to mention a few.

The interplay of different factors and characteristics of the low-resource healthcare context has the potential to trigger several of the electrosurgical risks to occur.

The field study in Kenya revealed that there are seven phases the equipment goes through, namely the procurement, the pre-treatment, the surgical treatment, the post treatment, the maintenance, the repair and the disposal phase. The interplay of some of those activities within those phases, the technology related risks and the user characteristics including their knowledge about electrosurgery lead to safety

concerns and potential safety risks. Many of the safety concerns are triggered by a shortage of human and equipment resources, and by a lack of knowledge about electrosurgery and its related risks.

The evaluation of the digital equipment journey in part B showed that also other designers and researchers can benefit from the tool. The equipment journey serves those users as a tool to get an insight in the real use of the equipment in a low-resource healthcare context. The journey helps users who have never visited the context to empathize with it and to gain information about safety concerns regarding equipment use.

In part 2 it will be presented how the equipment can be used to develop a design intervention which prevents certain risks from occurring.



PART 2

Improve the Safety of
Electrosurgical Equipment by
using the Equipment Journey in
the Design Process

As the previous chapter confirms the equipment journey is a valuable tool for designers and researchers to empathize with the low-resource healthcare context and to gain insights into the electrosurgical equipment journey and the related potential safety risks. In this part of the report an example of the impact of the use of the equipment journey on design will be illustrated. Since the Global Health project aims at designing safe and affordable electrosurgical equipment, the concept of a design intervention created in this project will also focus on improving the equipment itself.

In chapter 1.2.4 the potential safety risks were categorized into four different groups based on their main root causes. The categories are policy/organization, patient plate design, information/ Interface interaction, and handheld design. The first category, policy/organization contains different potential risks, but is out of scope for this project, since the goal is to come up with an improved ESU design. I furthermore pay no attention to the design of the handheld, since K. Ouweltjes already worked on a new handheld concept which would solve these issues to a great extent. Most potential safety risks arise due to missing knowledge. A design solution that bridges the users' knowledge gap and improves the usability of the user interface would therefore solve the most safety concerns. This is the reason why the focus of my design project will lie on this topic.

Finally, the category patient plate design contains three safety concerns. I will address those by giving some design recommendations, but I will not develop a detailed concept for a new patient plate design.

2.1 The chosen Safety Concerns and their Root Causes

When using the equipment journey to develop a new design concept the first step is to choose specific safety concerns which require a resolution. Additionally, the root causes should be determined. In table 4 the potential risks that are chosen to be focussed on in this design project and the related root causes are presented.

Safety concern	Harm for user/patient	Root cause
1 Inexperienced staff struggles to operate the ESU and to prepare it for surgery	Too high power settings can lead to undesired tissue effects. Selection of modes (e.g. spray mode) not desired by the surgeon can result in undesirable tissue effects. High stress level inexperienced staff.	ESU operators change according to available staff. A shortage of BMETs, therefore, other staff needs to take this task over. The current used ESUs have complex interfaces with a lot of different functionalities. It can be difficult to operate the machines for someone without knowledge about the principles and the machines.
2 Not changing last used high power settings prior to surgery	Undesirable tissue effects	A lot of staff members assume that the BMETs pre-set the ESU during their morning routine check, however, this is not the case. The ESU selects the last used power settings when being turned on.
3 Select too high power settings	Undesirable tissue effect	The medical staff has not learned anything about electrosurgery during their education. Due to a shortage of staff often also medical students are asked to turn on and prepare the machine. They lack experience.
4 Missing an alarm	No action can lead to different patient harms according to the type of error	The volume of an alarm is linked to the volume of general operation actions. If the user turns down the volume of the device also the volume of important alarm sounds is turned down.

Safety concern	Harm for user/patient	Root cause
5 Not knowing how to react to a system error during the surgical procedure	This leads to a delay of the procedure and means that the patient needs to be longer under anesthesia. The stress level of the surgical staff increases.	The current ESUs give no informative error message. They only display an error number, which links to information in the device manual. Often there is no BMET around during the surgery and finding one can take some time.
6 Wrapping the cables of the handheld around metal clamps which are used to secure the blankets on the patient	This can lead to patient burns during prolonged exposure	The surgeon and surgical assistant wrap the cables of the handhelds around metal clamps so that they cannot fall onto the ground during the procedure. The medical staff has not learned anything about electrosurgical risks and risk prevention during their education.
7 Placing the handheld on top of the patient when not being in use	Accidental activation could cause ignition of flammable materials and unintended burn wounds	Currently there are no design interventions available at the hospital which would prevent this risk (such as a non conductive holder for the handheld). The medical staff has not learned anything about electrosurgical risks and risk prevention during their education.
8 Using direct coupling during the surgical procedure	This could lead to glove burn when not being in touch with the patient's tissue	
9 Placing the patient plate underneath the shoulder	Patient plate burns	The return electrode stickers lose its stickiness when being reused multiple times. Then the sticker is placed underneath the patient's body to ensure contact. Most nurses do not know that placing the return electrode plate on areas with bony prominences can lead to patient burns.

Table 4: Potential risks and root causes

When looking at the root causes of the safety concerns it is apparent that several of the root causes lie in the knowledge gap of the medical staff about the principles and general risks of electrosurgery. For the first five safety concerns the root causes also lie partly in the current design of the ESU interface and hardware. Also the last safety concern regarding the placement of the return electrode plate is to a great extent caused by the design of the plate which is not designed for reuse.

In order to prevent the selected risks from occurring in the low-resource healthcare setting, a concept for a new ESU interface and information stickers and posters, displaying the correct and safe use of the electrosurgical equipment were designed within this project.

The different design interventions will be presented in the next chapters.

2.2 Design of the User Interface

In order to prevent the risks of users selecting undesired waveform modes and too high power settings, and thereby cause undesired tissue effects (see table 4, risk 1 & 3), the interface of the electro-surgical unit was redesigned (see figure 25).

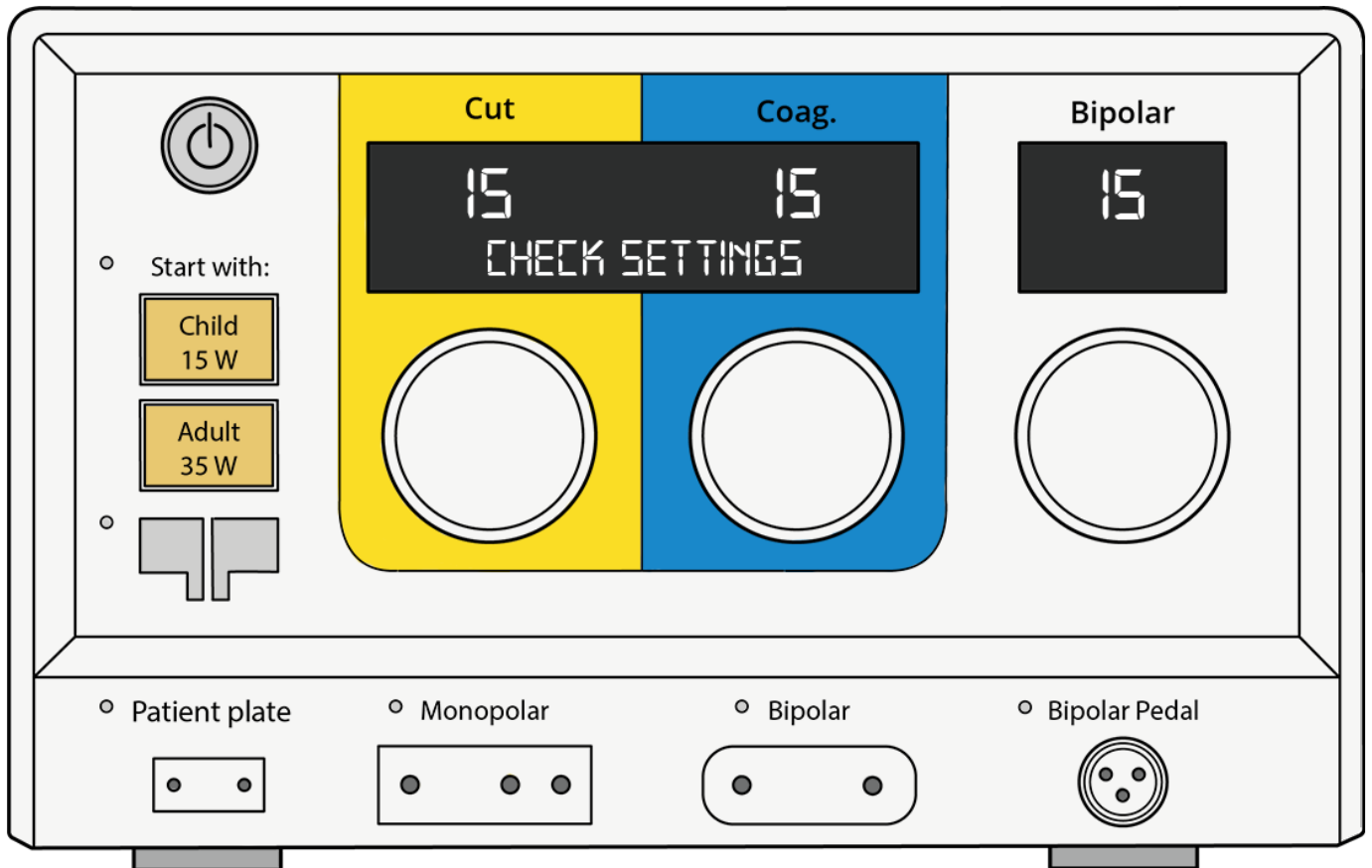

Figure 25: User interface concept

While developing the concept special attention was paid to the knowledge and experience levels of the medical staff. Furthermore, the hospital's resources and the users' way of working was taken into account. That is why the user interface incorporates their two currently used main rules concerning the selection of the start-power settings.

“With power settings you usually start low, with 35 to 45 for adults and between 15 and 25 for children. Then you increase if you think it's necessary.”

Since choosing 15W for children and 35W for adults is not dangerous, it was decided to incorporate this rule into the user interface and thereby giving the inexperienced users like the medical students some guidance in selecting the correct start settings. Thereby I deviated from the previous concept (see figure 26). It would cost the user an unnecessary amount of effort to learn new selection guidelines.

Basing the selection of the power settings on the type of surgery and tissue like the previous concept proposes, is something most users currently do not consider at all. Introducing those guidelines might therefore need additional knowledge and training and could lead to more use errors if this is not provided and therefore not correctly understood.

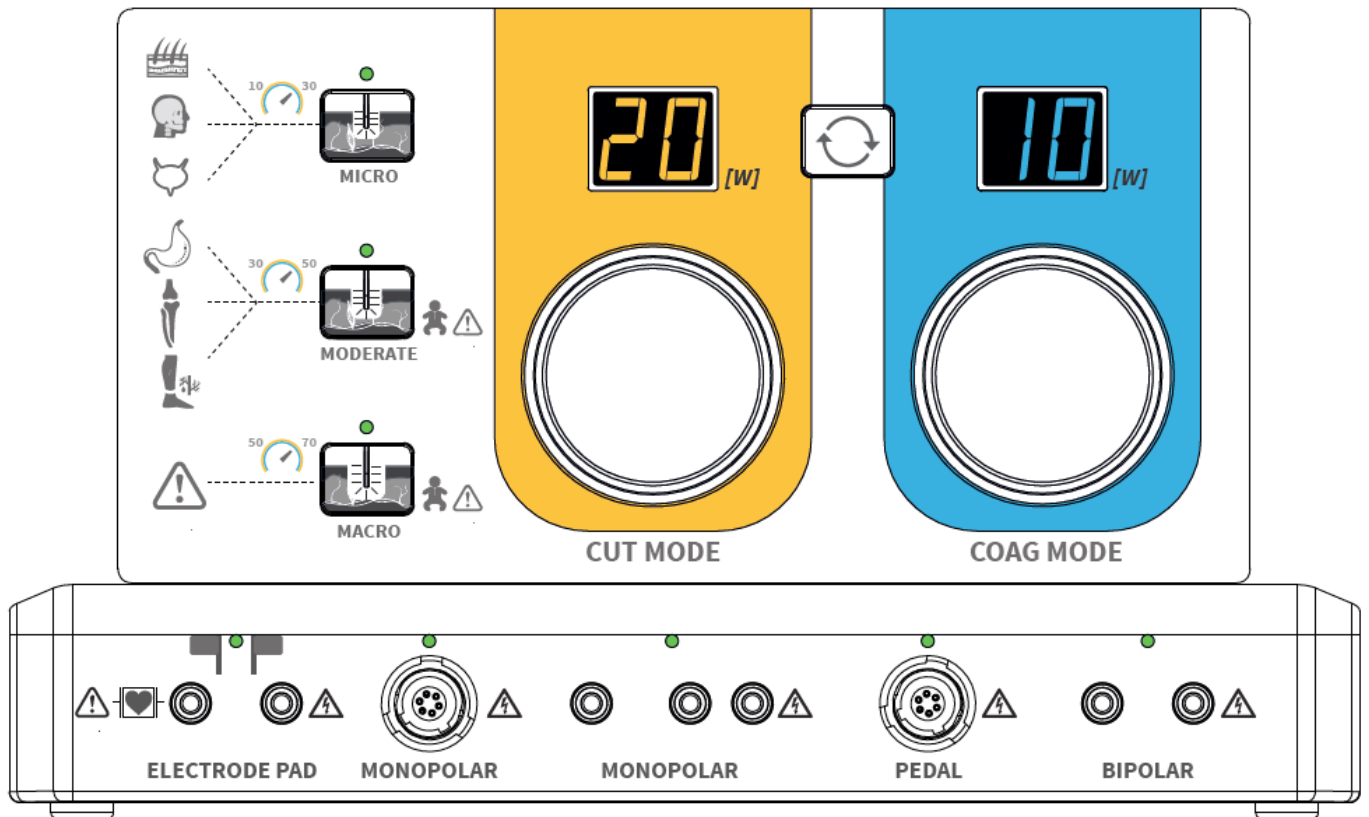

Figure 26: Previous user interface concept

When the user turns on the ESU by pressing the power button, the device will run a self-check. Thereby, the ESU will test if all the functionalities still work properly. While running through its different functions the green little lights turn on (see figure 27 for an example). When this is completed the ESU will select the lowest power settings, which is 15W and on the screen the message "Check settings" will start flashing for about 10 seconds. Simultaneously the buttons for the start power settings will light up. This way a visual link is formed between "check settings" and the start power setting options (see figure 28).

The user can choose to start with either 15W or 35W depending on whether the patient is a child or an adult. This increases the user-friendliness and accelerates the process since the user can just select the correct start settings out of two options. These

Insights from the Equipment Journey

- Some medical staff members assume that the BMET pre-sets the ESU prior to the surgery and therefore do not pay attention to the power settings -> *Therefore, automatically selecting the lowest power settings prevents the risk of too high settings*
- The medical staff did not learn anything about power settings during their education -> *Especially, for inexperienced staff the start power buttons provide simple guidance*

options are in line with their current way of working and give inexperienced users more confidence when operating the ESU for the first time. By pressing one of the start power button the user only sets the start value. It is still possible to change the settings during the procedure without any limitation (see figure x).

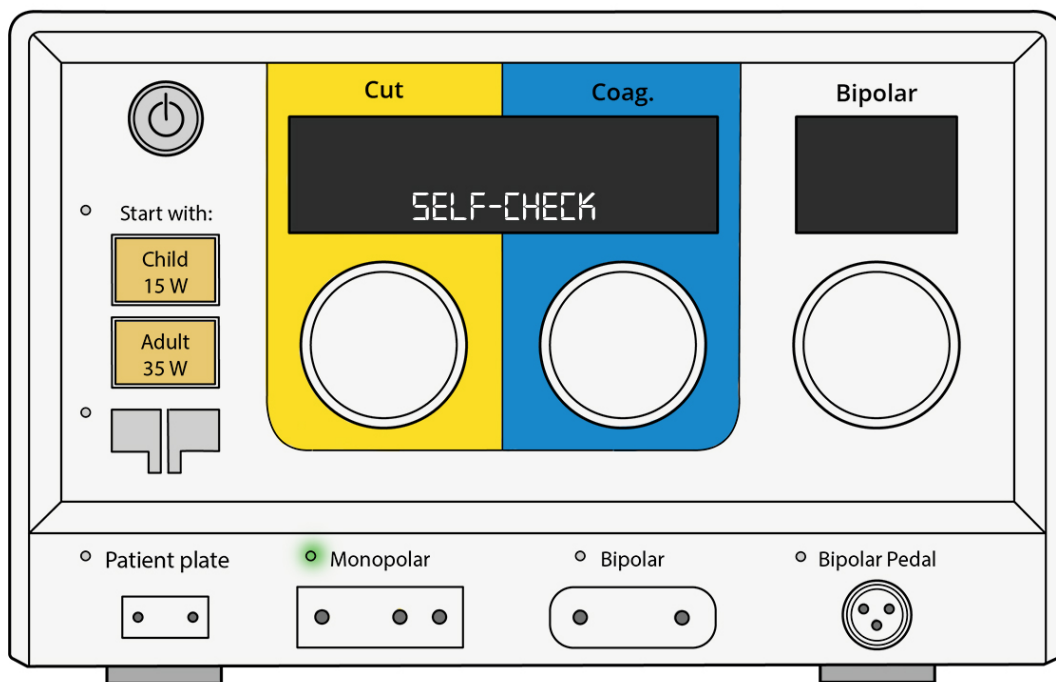

Figure 27: Self-check

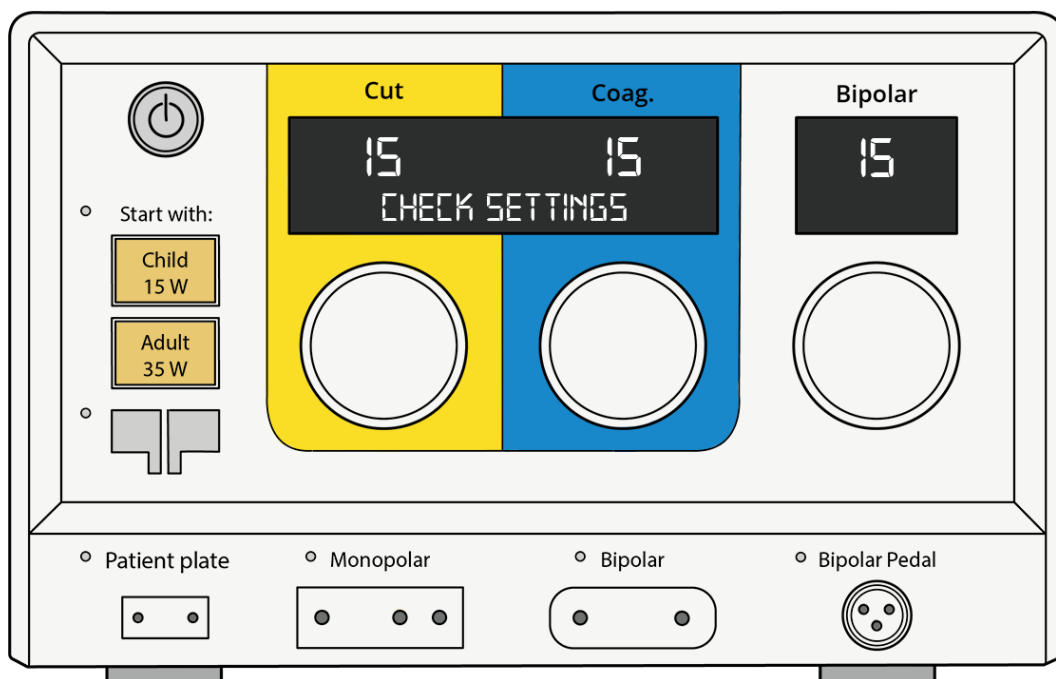

Figure 28: Check settings

Insights from the Equipment Journey

- Since most users did not learn anything about power settings related to electrosurgery, they might not pay special attention to very high settings -> *The message will make them aware*

However, when exceeding the value of 60W the screen will display a warning message to alert the user that the power settings are high, and that the ESU therefore should be used with special attention (see figure 29).

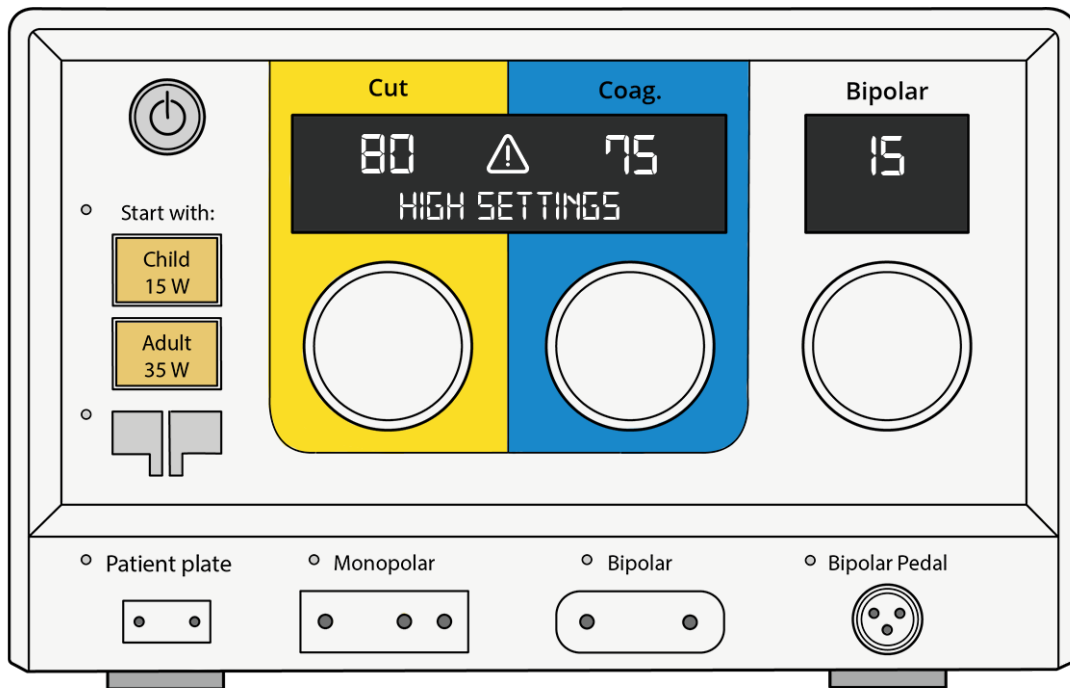

Figure 29: High settings

The layout of the interface is divided according to the order of steps that need to be taken to use the ESU. Starting on the left the user can find the power button, the start-power setting buttons, followed by the patient plate sign and outlet. In the middle there are the monopolar cut and coagulation mode, along with the monopolar outlet. Finally, on the right there is the bipolar mode. Compared to the Valleylab xForce design (see figure 30) I consciously decided to move the bipolar mode to the right side, because it is used less frequent than the monopolar mode and therefore should not attract the first attention. However, other than in the concept shown in figure 30, I still wanted to incorporate a separate screen for the bipolar power settings. I think merging the coagulation and bipolar settings by having them displayed on the same screen has a great potential for confusing the user and causing use errors. Having two separate screens for the monopolar coagulation and bipolar mode gives the user more insight in which power settings are used at the moment and while either quickly alternating between those modes or even using both modes

simultaneously. Moreover, my research showed no need for the development of a smaller and portable design which might otherwise be an argument for limiting the amount of screens. The ESU is placed on a cart or surgical tower and only leaves the operation theatre when it needs to be repaired or maintained. The turning knobs for changing the power settings should have some resistance so that the user does not accidentally selects too high settings. The resistance gives the user more control during this interaction.

Insights from the Equipment Journey

- The only handhelds used during the observations were monopolar handhelds which can be activated by buttons and bipolar handhelds which are activated by using a footswitch

The new ESU concept contains different outlets at the bottom of the user interface. Next to the outlet for the patient plate is the outlet for the monopolar handswitch followed by an outlet for a bipolar handheld which cannot be activated by itself. In order to activate it one needs to plug in a bipolar footswitch

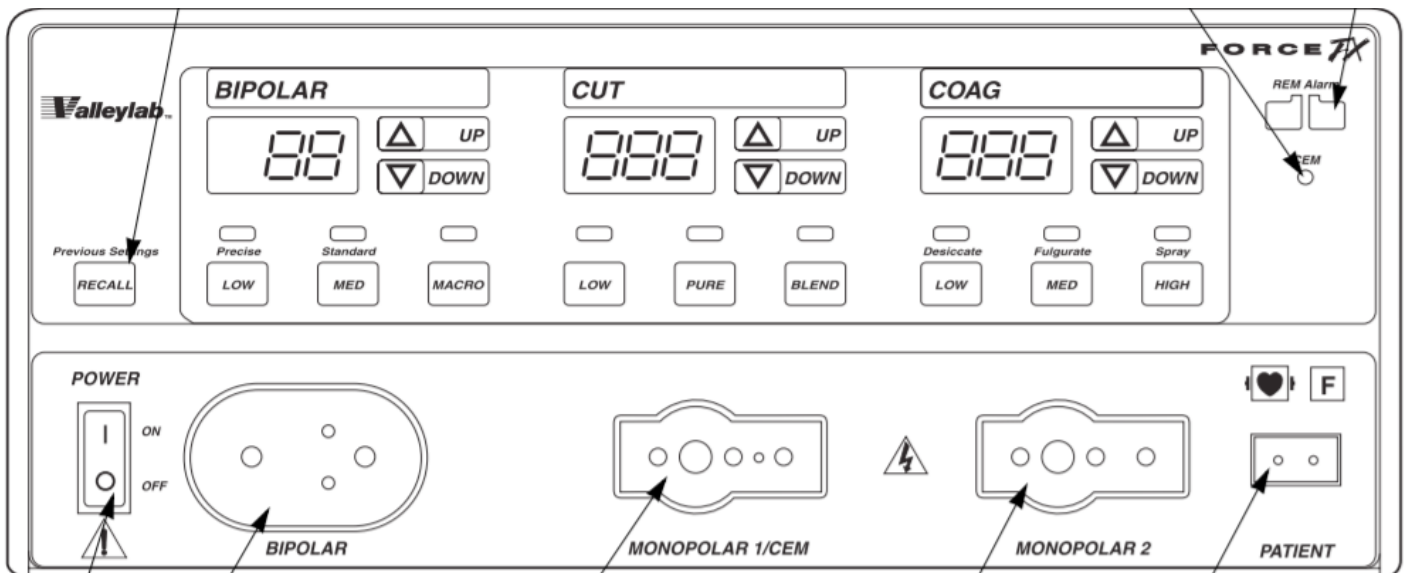

Figure 30: Valleylab user interface

in the outlet on the far right. It was decided to incorporate these specific outlets, because these are the only ones used at the national hospital in which the observations took place. The outlets are universal, which means that handhelds and foot pedals from different manufacturers can be connected to this electro-surgical unit.

In general it was decided to design an ESU concept which has all the basic and most needed functionalities. The goal is to ensure that surgeons in low and middle income countries can perform safe electro-surgery for an affordable price. Therefore, the ESU also contains only the standard modes. As can be seen in figure x the Valleylab xForce has three different modes for each bipolar, cut and coagulation. The observations have shown that in most cases the standard settings are chosen, which are MED (standard) bipolar, pure cut and MED (fulgurate) coagulation. Also other research shows that these modes are most commonly used (Montero et. al, n.d). A study done by Montero et al. shows that from all of their measured coagulation activations, the fulguration (MED) setting was used

more commonly than the Spray (High) setting (97.2% versus 2.8%, $p < 0.0001$). For cut activations, pure mode was used more frequently than the blend mode (80.7% versus 19.3%; $p < 0.0001$).

Insights from the Equipment Journey

- Only the standard modes were used during the observed surgeries

Despite the fact that these results support my findings and the choice of only incorporating the standard modes, it also shows that the blend mode is used quite often. This result is in line with a research study conducted by R. Oosting. Her results show that 28,8 % of 59 interviewed surgeons confirm that they use the blend mode from time to time.

Therefore, in the future and additional ESU version with extended features could be designed further to the basic ESU version presented here. The more

extended ESU version could contain a blend mode and for example an additional monopolar outlet, which enables the surgeon and surgical assistant to perform electrosurgery at the same time.

As stated earlier the lowest power settings will appear when the ESU is turned on. This increases the safety since it prevents the current risk of not changing high last used power settings. Currently some users assume that the BMET pre-sets the ESU prior to the surgery and additionally most users do not have a lot of knowledge about power setting selection. Therefore, they might not change very high settings. With this new design intervention the surgery will always start with safe settings.

After a power outage the ESU will automatically turn on when the power is back. This means the user does not need to press the power button and the ESU will not run a self-check. Instead the ESU will select the last used power settings so that the procedure can immediately proceed. This increases the user-friendliness of the design. In comparison to the first scenario there is no user interacting with the HF generator at this moment and therefore it would cost an unnecessary additional effort to manually select the last used power settings during the procedure.

Alarms

The new ESU has different alarm signals for warnings and system errors. An important one is the patient plate alarm. When the user, usually in this case the nurse, will attach the return electrode plate to the patient's body and then plugs it into the HF generator, the machine will check if the patient plate makes enough contact with the patient's tissue. This is done by the REM system. If the system detects full contact the patient plate sign on the generator will light up in green (see figure 31). In case of an reduced contact area the light will switch to red, an alarm sound appears and the message "Patient plate!" appears on the display (see figure 32). This visually and audibly informs the user about the warning. At the same time the ESU deactivates the handheld to prevent patient plate burns.

The alarm volume cannot be adjusted by the user. Therefore, the chance of not hearing an alarm is reduced.

Observation

During one surgery where both legs of a patient were amputated two surgeons worked simultaneously, each on one leg. Since there is only one monopolar handheld available for every surgery, one of the surgeons needed to work with a scalpel.

Observation

Power outages are a common phenomenon in the low-resource healthcare setting. The design should take this into account.

Insights from the Equipment Journey

Often it was not possible to hear the alarm sound, since someone had turned down the volume.

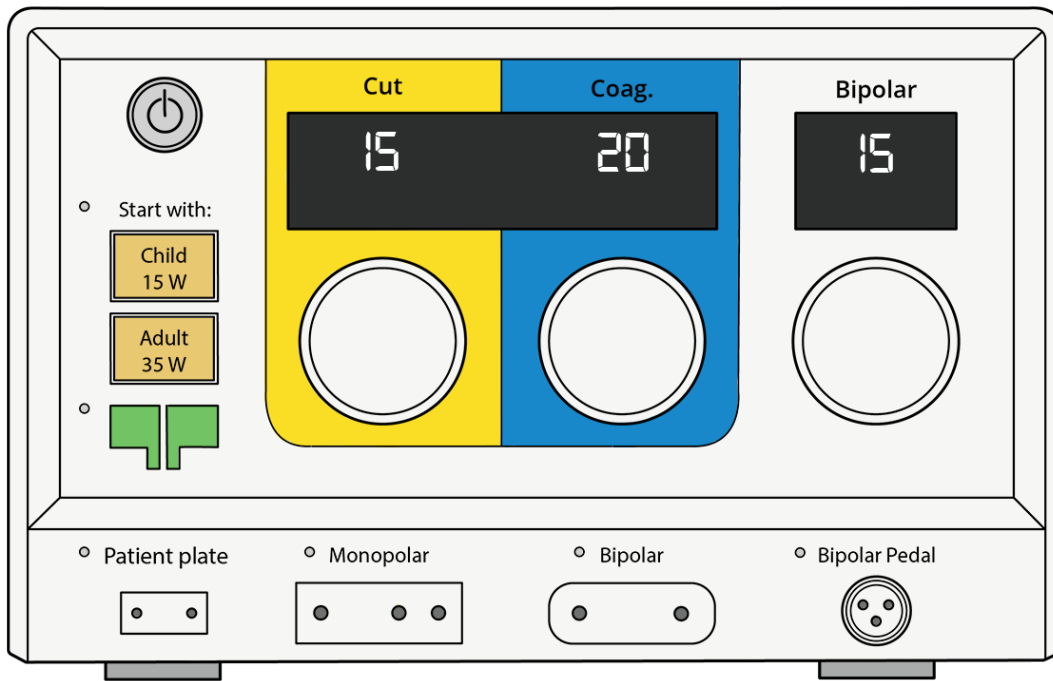

Figure 31: Green patient plate sign

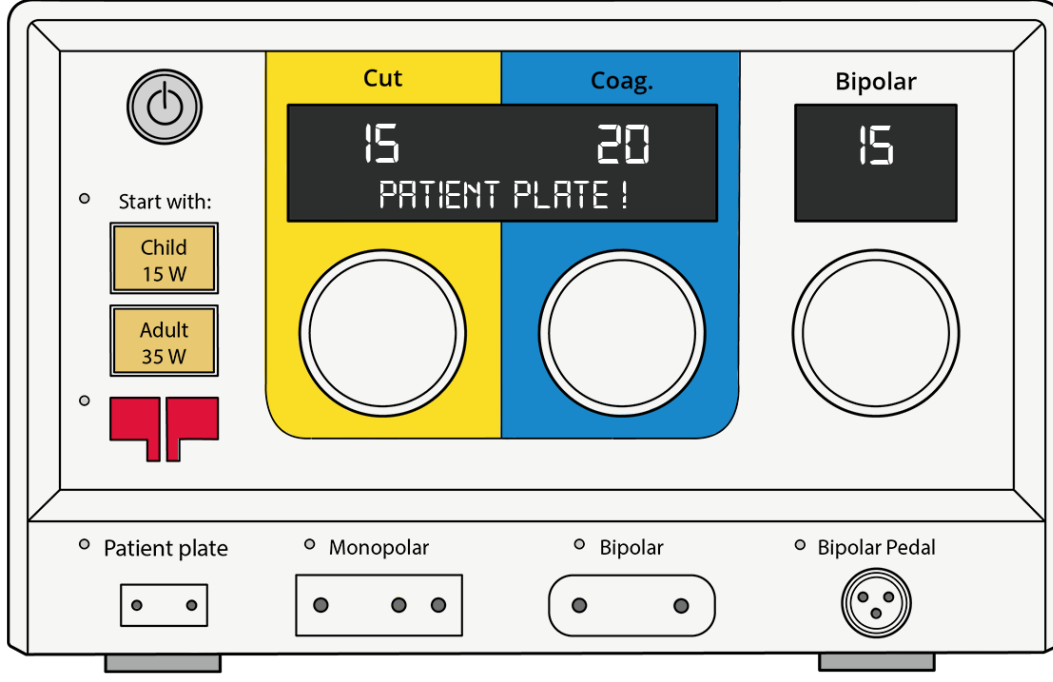

Figure 32: Patient plate alarm

Next to the patient plate alarm there are more system errors that can occur. In case of an error an error message will appear on the display (see figure 33). More about the error messages will be described in the next chapter.

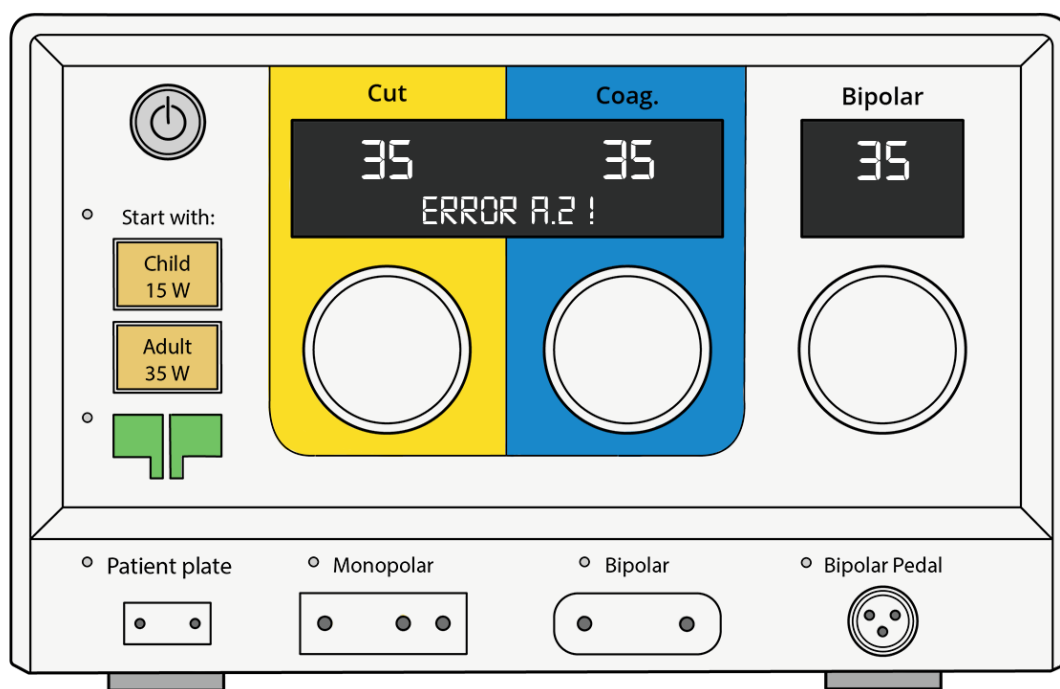

Figure 33: Error message

2.3 Information Sticker for correct ESU use

Some risks related to the use of electrosurgical equipment can only be prevented by providing the user with important information and knowledge. An information sticker which will be placed on top of the HF generator will guide inexperienced users through the process of preparing the device for surgery and provides guidelines on how to react in case of a system error. Immediate reaction and work efficiency reduce the stress levels of the users and the total surgery time.

Currently, when an error message occurs, the screen displays a number. The problem is that the users do not know what this error message stands for and more importantly how to react to it. For the new design all the possible system errors of the Valleylab xForce were analyzed and clustered according to the origin of the error. The Valleylab xForce was taken as an example,

because the new ESU design will have a lot of the same functionalities and therefore possible errors. The in total 272 system errors were clustered into 17 categories.

1. Microcontroller malfunctioning
2. Software malfunction
3. Internal diagnostics
4. Internal component malfunction
5. Calibration malfunction
6. Watchdog malfunction
7. Bipolar buttons (up arrow / down arrow) may be stuck
8. Cut buttons (up arrow / down arrow) may be stuck
9. Coagulation buttons (up arrow / down arrow) may be stuck
10. Monopolar 1 handswitch cut button may be stuck

- 11. Monopolar 2 handswitch cut button may be stuck
- 12. Monopolar 1 handswitch coag. button may be stuck
- 13. Monopolar 2 handswitch coag. button may be stuck
- 14. Bipolar handswitch or footswitch pedal may be stuck
- 15. Internal memory battery exhausted
- 16. Internal temperature limit exceeded

The error categories 7, 8, 9, 11 and 12 can be disregarded, because they are not applicable for the new ESU design. The new concept has turning knobs instead of buttons for the bipolar, cut and coagulation settings and those cannot get stuck. Moreover, the new concept contains only one monopolar outlet. The remaining error categories have then been clustered a second time according to the action that needs to be taken to solve the issue. The new cluster can be found in Table 5. As can be seen the recommended action by Valleylab is indeed focused on solving the issue and therefore very detailed. It

seems that their recommended action is very much intended for the BMET. However, in order to reduce the delay of the surgery, it is important that the users during the procedure, most likely the medical staff, knows the fastest action to be able to proceed the surgery. This can also mean that replacing the device is the best option at that moment. Therefore, I propose new recommended actions that are intended to let the surgery continue as quick as possible and which provide the staff clear guidance (see figure x, right column).

Insights from the Equipment journey

When the error message “196” appeared on the display, none of the staff knew what the error is about and how to solve it. Additionally, no BMET was around at that time. It took almost 15 minutes before the ESU could be used again.

Error description	Recommended action Valleylab	New recommended action
Microcontroller malfunctioning	Turn the power switch off (O) then on (I) again. If error reappears, replace the Control board. Refer to Control Board Replacement on page 7-4.	Turn the power switch off then on again. If error reappears, turn generator off and get a new HF generator.
Software malfunction	Turn off, then turn on the generator. If the alarm number reappears, record the number and call the Covidien Service Center.	Turn the power switch off then on again. If error reappears, turn generator off and get a new HF generator.
Internal diagnostics	Turn the power switch off (O) then on (I) again. If error reappears, replace the Control board. Refer to Control Board Replacement on page 7-4.	Turn the power switch off then on again. If error reappears, turn generator off and get a new HF generator.
Watchdog malfunction	Turn the power switch off (O) then on (I) again. If error reappears, replace the Control board. Refer to Control Board Replacement on page 7-4.	Turn the power switch off then on again. If error reappears, turn generator off and get a new HF generator.

Error description	Recommended action Valleylab	New recommended action
Internal component malfunction	<p>Do not attempt to use the generator. Record the number and call the Covidien Service Center.</p> <p>Calibrate the ECON factor. Refer to Calibrating the Generator on page 5-26. If the alarm number reappears, refer to Correcting T_ON ASIC Malfunctions on page 6-22.</p>	<p>Do not attempt to use the generator. Get a new HF generator.</p>
Calibration malfunction	<p>Repeat the failing calibration step. If the alarm number reappears, record the number and call the Covidien Service Center.</p>	<p>Do not attempt to use the generator. Get a new HF generator.</p>
Internal memory battery exhausted	<ol style="list-style-type: none"> 1. Replace the battery. Refer to Battery Replacement on page 7-3. 2. Calibrate the generator. Refer to Calibrating the Generator on page 5-26. If the alarm number reappears, record the number and call the Covidien Service Center. 	<p>Do not attempt to use the generator. Get a new HF generator.</p>
Internal temperature limit exceeded	<p>Verify that the location of the generator allows for adequate cooling. Use the lowest power setting that achieves the desired effect. Limit activation times, if possible.</p>	<p>Do not attempt to use the generator. Get a new HF generator.</p>
Monopolar 1 handswitch cut button may be stuck.	<ol style="list-style-type: none"> 1. Turn off, then turn on the generator. Do not press buttons or accessory activation devices during the self-test. 2. If the alarm number reappears, disconnect all accessories. Turn off, then turn on the generator again. If the alarm number reappears, record the number and call the Covidien Service Center. 	<p>Turn off and back on. If error reappears, connect new handheld / footswitch.</p>

Error description	Recommended action Valleylab	New recommended action
Monopolar 1 handswitch coag. button may be stuck.	<ol style="list-style-type: none"> 1. Turn off, then turn on the generator. Do not press buttons or accessory activation devices during the self-test. 2. If the alarm number reappears, disconnect all accessories. Turn off, then turn on the generator again. If the alarm number reappears, record the number and call the Covidien Service Center. 	Turn off and back on. If error reappears, connect new handheld / footswitch.
Bipolar handswitch or footswitch pedal may be stuck.	<ol style="list-style-type: none"> 1. Turn off, then turn on the generator. Do not press buttons or accessory activation devices during the self-test. 2. If the alarm number reappears, disconnect all accessories. Turn off, then turn on the generator again. If the alarm number reappears, record the number and call the Covidien Service Center. 	Turn off and back on. If error reappears, connect new handheld / footswitch.

Table 5: Error cluster

The user can find the short error description and the recommended action on the sticker which is placed on top of the HF generator (see figure 34). Every cluster is assigned to a specific letter and every error is numbered. On the screen of the user interface the error category letter and number will be displayed in case of an error (see figure 33). The user can look up the error and related action on the information sticker. The letter and number are visualized in the same font to create coherence and enable the user to easily find the correct information.

Eventually the user might be able to memorize the action that is related to one of the three letters and therefore might not need to look at the sticker anymore when an error occurs.

In addition to the section "How to react to system errors" there are also instructions for use. In a few illustrated steps the user is guided through the procedure to set up the ESU for the upcoming procedure. This information was added since observations in the context revealed

that the person who is asked to operate the machine varies according to who is available at that moment. Those people are almost always medical staff and they have not learned anything about electrosurgery neither about how to operate the different ESUs. For inexperienced and first time users the instructions provide guidance and confidence.

The steps are divided into monopolar and bipolar surgery. Depending on which surgery will be performed the user can follow the correct path.

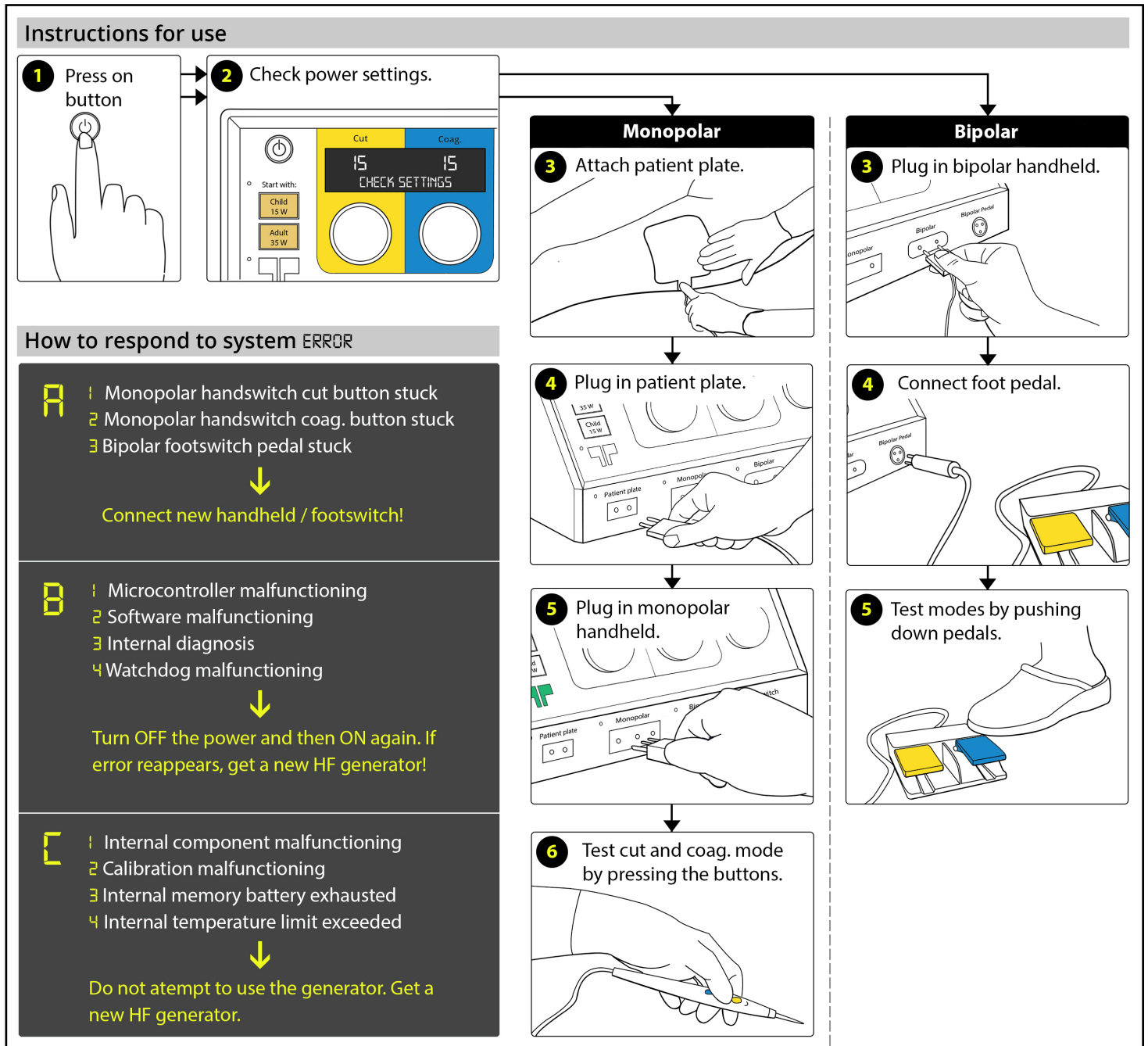

Figure 34: Information Sticker

2.4 Information Sticker for correct Patient Plate use

There are great safety concerns regarding the placement of the patient plate. Since the patient plate loses its stickiness after being reused for several times, the users are placing the plate underneath the body to ensure contact. However, one should avoid areas with irregular body contours, bony prominences, excessive hair and scarred tissue. Moreover, the areas where the patient touches the surgery table should not be selected, because the blood circulation is reduced at these locations. Instead, it is advised to place the patient plate onto a well-vascularized muscle mass such as the upper leg.

In order to make users aware of where it is safe to place the patient plate a sticker is placed on top of the patient plate (see figure 35). It shows which areas are safe for placing the electrode (green) and which areas should better be avoided (red).

The advantage of sticking the information on the patient plate is that the user gets confronted with

that information at the moment that it is valuable. Furthermore, the sticker serves as a guideline and makes sure that every user knows where to place the electrode.

However, in order for the user to follow these guidelines and place the patient plate on the recommended areas the patient plate design needs to enable this. Further to the provision of information a whole new reusable patient plate design is needed. The new design should stick to the body even if being cleaned and reused multiple times. The focus of this project did not lie on developing such a new return electrode plate, but in appendix 4 the documentation of a small patient plate study can be found. During this study Kenyan nurses were presented to concept designs focussing on the attachment of the patient plate. By evaluating these concepts a list of wishes and requirements was developed. These insights can be used to create a future reusable patient plate.

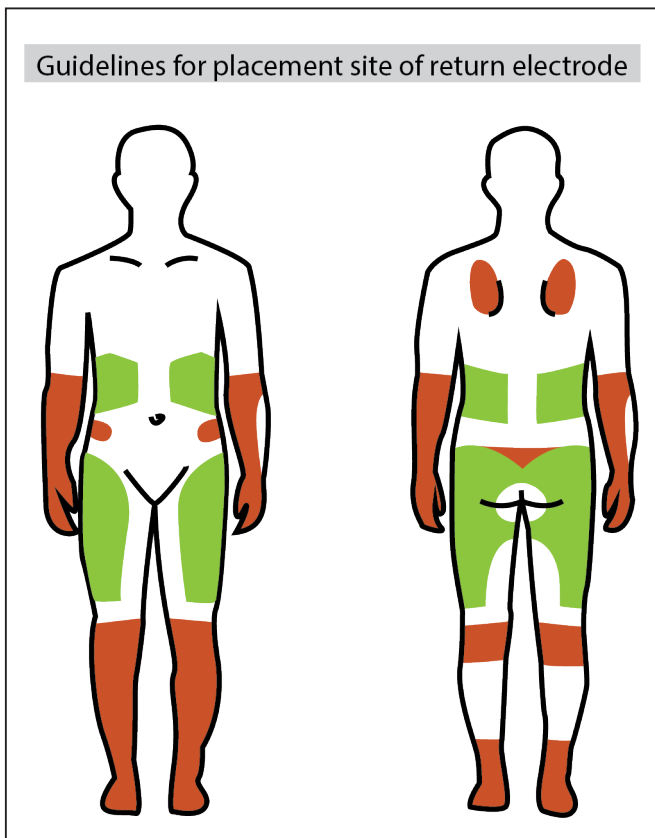

Figure 35: Patient Plate Information

Insights from the Equipment Journey

The patient plate is usually placed underneath the patient's body. When the return electrode does not stick to the upper leg it is often placed underneath the patient's shoulder.

2.5 Information Poster for safe Electrosurgery

The information sticker on top of the HF generator (see chapter 2.2) describes all the actions which are advised to follow. On the contrary, the information poster which is intended to hang on the wall in the operation theatre points out all the things the user should avoid in order to be able to perform safe electrosurgery. The information concerns electrosurgery in general and can therefore be used in combination with any type of ESU, regardless the specific manufacturer. The poster visualizes and describes six situations that should be avoided (see figure 36). The situations which have been observed most commonly during the context study such as wrapping cords around metal clamps or making use of direct coupling, are placed on top. Ideally, all the risks that come with electrosurgery would be solved by design. However, some risks such as current favoring metal pins inside the patient's body over the patient plate, cannot be avoided by design. This can only be prevented by creating awareness of this risk and providing knowledge on how to cope with those situations. Therefore, this poster plays an important role in accomplishing the overall goal of making electrosurgery more safe for the user and patient.

Insights from the Equipment Journey

- Surgeons and surgical assistants wrap the cables of the handheld around clamps to prevent the handheld from falling
- The surgical assistant often touches a metal instrument hold by the surgeon to create a certain tissue effect (direct coupling)
- Prior to surgery the handhelds are taken out of a box with Cidex. After tapping the handheld onto the surgical table to dry it, it is connected to the HF generator

Takeaways impact of the journey on design

The equipment journey was used to create a design intervention concept which prevents identified risks from occurring. In a first step the journey helps in defining the problems and scope of the project. In this case the safety concerns triggered by a lack of information and an user unfriendly interface design were chosen as a focus point. A second look at the journey reveals more in depth information about the root causes per safety concern. This information can be used by the designer to come up with design interventions which respond to the root cause and thereby solve the safety concern.

Safe Electrosurgery

How to increase your safety and thus of the patient?

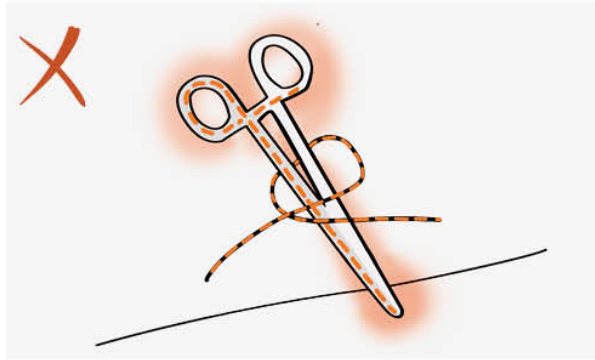

- 1** Do not wrap the handheld cord around any metal instruments!
This could activate these instrument and lead to patient burns.

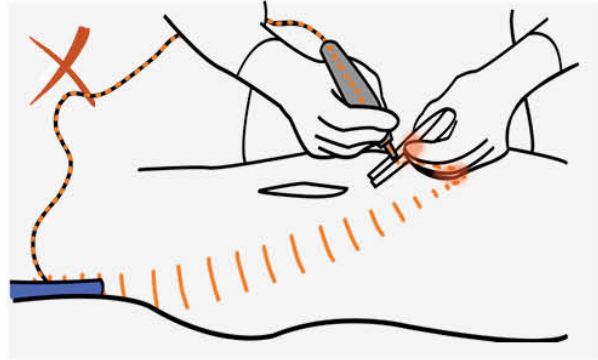

- 2** Do not activate the system when the active electrode is not in contact with tissue!
This can lead to glove burns (operator and patient burns).

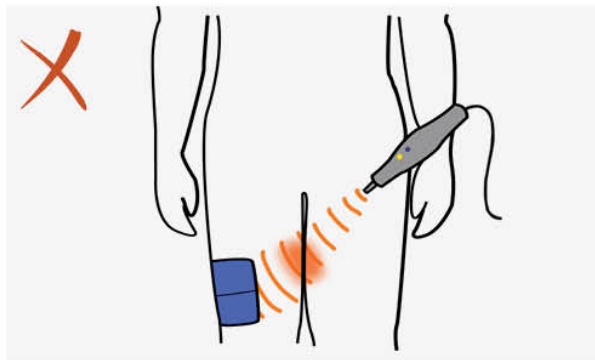

- 3** Avoid skin-to-skin contact.
This could lead to patient burns.



- 4** Make sure that the patient is not in contact with grounded metal objects!
This could lead to patient burns.

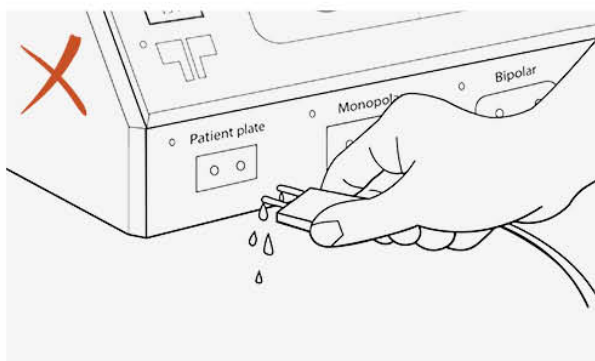

- 5** Do not plug wet accessories into the outlets of the HF generator.
This could lead to electrocution !

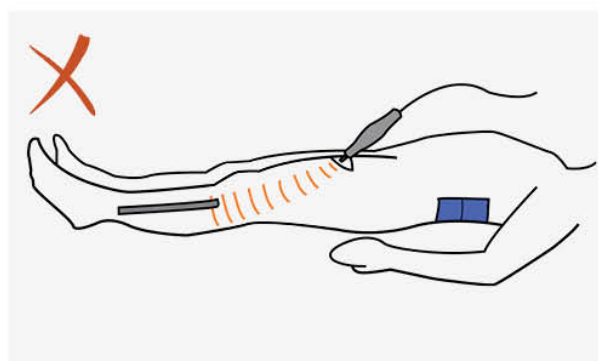

- 6** Make sure that the patient has no metal objects inside his body. This could influence the current flow and lead to burn wounds.

3 Final Conclusion

The main goal of this project was to map out the journey of the electrosurgical equipment in a low-resource healthcare context and discover the safety concerns which occur along this journey. In order to achieve this goal a mixed methodology was used. Next to a literature study, a qualitative case study in Kenya including observations and semi-structured interviews was conducted.

The results show that the electrosurgical equipment journey contains seven phases with therein a lot of different activities. The phases are procurement, pre-treatment, surgical treatment, post-treatment, maintenance, repair and disposal. The interplay of safety risks which are generally related to the technology of electrosurgery, the activities that are performed with the equipment, and the users' characteristics such as knowledge about electrosurgery triggers several safety concerns within the journey. The most severe safety risks can be found in the pre-treatment and surgical treatment phase, because in case a risk occurs in these phases direct harm to the patient or user would be the result. For several safety concerns the root cause lies in the combination of a shortage of equipment resources and a lack of users' knowledge about electrosurgery and its related safety risks.

The evaluation of the digital representation of the electrosurgical equipment journey showed that the equipment journey also serves other designers as a tool to gain insights into the journey and safety concerns, and to empathize with the low-resource healthcare context. The participants mention that the equipment journey provides an informative and detailed overview of the reality. Therefore, they think that the journey is an interesting source of information during a design project and helps to define a problem statement. Additionally, the root causes of the problem can be explored within the journey.

An example of the implementation of the equipment journey in a design project is illustrated in this report. By using the insights from the journey four different design interventions were developed to prevent amongst others safety risks such as the selection of too high power settings, not knowing how to react

to system errors and the incorrect placement of the patient plate. As a result a new user interface of the HF generator and information stickers which will be placed on top of the ESU and the patient plate, were designed. The information stickers close the current knowledge gaps of the users about electrosurgery and the equipment and guide the user in using the equipment safely.

In contrast, the designed information poster about safe electrosurgery in general tells the user which activities should be avoided.

In general the research shows that the safety of electrosurgery depends on a complex system of factors. In order to improve the overall safety of electrosurgery aspects from the hospital organization, the product design and the users' knowledge should be improved.

4 Discussion

The journey mapped out in this research project provides a detailed representation of how the electrosurgical equipment is used in the low-resource healthcare context. One of the most interesting findings is that the journey contains a lot of insights which were not part of the assumed journey (see Appendix 1) which was created prior to the field research based on previous research and literature. This shows that it is very difficult to formulate assumptions about a non-familiar context, and that first hand information of the context is very valuable data. Also this study revealed that there is often a difference in what people describe they do and in what they are actually observed doing. One reason for this might be that the interviewees feel the need to present the hospital and their practices in a positive way. Interviewees for example described that they dispose the patient plates after one-time use, however it was observed that they actually reuse the plates multiple times.

Another goal of this study was to discover safety concerns within the electrosurgical equipment journey in order to be able to design a new ESU which resolves those safety issues. The results reveal that certain conjunctions of contextual, technological, and user factors lead to potential safety risks. During this study none of these safety concerns was observed to harm the patient or user during the case study. This might raise the question why to consider these situations as risks and why to mitigate these by design.

The answer to this question is simple. The safety of the user and patient should always come first. Even though no harm to the user or patient was observed during the fourteen surgeries, the research showed that a number of contextual factors carry a great potential to trigger safety risks to occur and therefore to harm the user or patient. A product manufacturer should always aim to intervene with a design that prevents the safety risk to occur before it actually leads to harm.

Therefore, the electrosurgical equipment journey lays the foundation for designing new safe electrosurgical equipment.

The evaluation of the digital representation of the equipment journey showed that the journey also

serves other designers and researchers as a tool to gain insight into the low-resource healthcare context and the equipment and its related safety concerns.

The reader should bear in mind that the field research took place in one Kenyan national hospital and that therefore the findings are only valid for this specific context. Future research should focus on conducting the same study in multiple low-resource hospitals. Additionally, more surgeries should be observed and more interviews with users should be conducted in order to reveal if the findings are valid for low-resource hospitals in general.

Before conducting additional research the study approach might need some changes.

It was very difficult to prepare the field study very well, since the research context was unfamiliar to me. Collecting assumptions about the equipment journey by collecting data from previous research and literature helped to formulate research questions and design research tools. Many different tools were designed in order to be flexible during the field study. This appeared to be valuable, because during the field study many tools were used differently than planned and others appeared not to be useful in the context. Since no interview appointments could be planned prior to the field trip, it was difficult to conduct interviews with medical staff using card sets. Often the only moments where it was possible to speak to the medical staff was during the surgeries and in the breaks. For future research studies it is advised to plan interview appointments in order to be able to ask more follow up questions and to have more time for in-depth interviews.

Concerning the digital equipment journey future research should focus on exploring if the tool also works for mapping out the journey and safety concerns of other equipment. As such other surgical equipment in low-resource settings should be analyzed using the same format and method as was used for the electrosurgical equipment.

References

- Convidien. (2008). Principles of Electrosurgery [PDF]. Geraadpleegd op 30 november 2018, van https://www.asit.org/assets/documents/Principals_in_electrosurgery.pdf
- Hay, D. J. (2008). Electrosurgery. *Surgery (Oxford)*, 26(2), 66-69.
- Jones, D. B., Brunt, L. M., Feldman, L. S., Mikami, D. J., Robinson, T. N., & Jones, S. B. (2015). Safe energy use in the operating room. *Current problems in surgery*, 52(11), 447-468.
- Lemon, K. N., & Verhoef, P. C. (2016). Understanding customer experience throughout the customer journey. *Journal of marketing*, 80(6), 69-96.
- Massarweh, N. N., Cosgriff, N., & Slakey, D. P. (2006). Electrosurgery: history, principles, and current and future uses. *Journal of the American College of Surgeons*, 202(3), 520-530.
- McCarthy, S., O'Raghallaigh, P., Woodworth, S., Lim, Y. L., Kenny, L. C., & Adam, F. (2016). An integrated patient journey mapping tool for embedding quality in healthcare service reform. *Journal of Decision Systems*, 25(sup1), 354-368.
- Montero, P., Fox, M., Robinson, T., & Stiegmann, G. (n.d). 30-30 Cut/coag - Is Electrosurgical Monopolar Energy Technology Underused? - SAGES Abstract Archives. Geraadpleegd op 20 januari 2019, van <https://www.sages.org/meetings/annual-meeting/abstracts-archive/30-30-cutcoag-is-electrosurgical-monopolar-energy-technology-underused/>
- Muga, R., Kizito, P., Mbayah, M., & Gakuruh, T. (2005). Overview of the health system in Kenya. *Kenya service provision assessment survey 2004*, 13-26.
- Ouweltjes, K. (2018). Empowering the accessibility of safe global electrosurgery.
- Patil, S. A., Devani, R., Radhakrishna, V., & Patil, M. (2018). Electrosurgery versus steel scalpel for elective surgery: A prospective study. *Saudi Surgical Journal*, 6(2), 55.
- Ulmer, B. C. (2008). The hazards of surgical smoke. *AORN journal*, 87(4), 721-738.
- Unicef. (2014). UNICEF - Overview - Kenya at a Glance. Geraadpleegd op 24 februari 2019, van https://www.unicef.org/kenya/overview_4616.html



Who? _____
 Is the alternation going smooth? _____

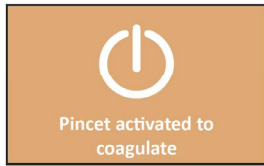

Who? _____



Who? _____
 Why does (s)he do that? _____

 Where is the handheld exactly placed? _____

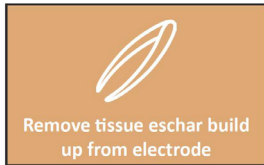

Who? _____
 How is the eschar removed? _____

General notes: _____

Observation sheet: Post - treatment

Who is present?	General surgeon	Specialist	Surgical assistant	Circulation assistant	Anaesthetist	Other:
How many people?	_____	_____	_____	_____	_____	_____

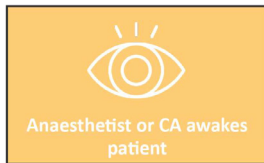

Who? _____

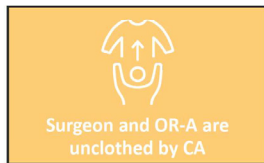

Who is undressing the surgeon and OR-A? _____

 Where are they unclothed? _____



Who? _____
 How is the electrode cleaned? _____





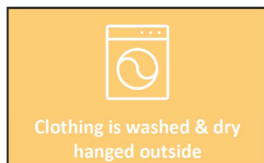







Who? _____
 How is the electrode cleaned? _____



Who? _____

General notes: _____

2 Interview Cards

<p>New equipment </p> <ul style="list-style-type: none"> Who indicates that a new ESU is needed? What requirements does the user usually have? How does the user communicate his wish for a new device? To whom does the user communicate that wish? 	<p>Product specifications - BMET </p> <ul style="list-style-type: none"> What product requirements does a BMET usually have? What are the specifications based on? Does the BMET take the wishes of the user into account? How does the BMET document the specifications? 	<p>Order - Procurement officer </p> <ul style="list-style-type: none"> What does the procurement officer exactly do? Does the procurement officer add new specifications or does (s)he only place the order with the specifications derived from the user and BMET? Are training and spare parts part of the order request?
<p>Tender - County government </p> <ul style="list-style-type: none"> What is the role of the county government in the procurement process? How do they decide to which distributor to send the tender? Are training and spare parts part of the order request? Does it play a role if local distributor has access to spare parts and training when it comes to choosing the distributor? What requirements weigh the most? 	<p>Winning bid - Distributor </p> <ul style="list-style-type: none"> Do the local distributors have biomedical knowledge? Do they offer training and spare parts? Are there issues related to the fact that the medical manufacturers are often located outside the country? 	<p>Installation - BMET </p> <ul style="list-style-type: none"> Does the BMET have access to training, manuals and instructions on how to install the device? Does the BMET get help from someone else? Is it always the BMET who does the installation?
<p>Donated equipment </p> <ul style="list-style-type: none"> Do you directly receive the donated equipment? Does donated equipment come with training, manuals and instructions? How do you get spare parts? Are there policies on donated equipment? 	<p>General - Barriers</p> <ul style="list-style-type: none"> What kind of barriers do you experience during the procurement process? Are there policies on medical equipment? What do you think of the costs of ESUs? 	<p>Maintenance</p> <ul style="list-style-type: none"> Do you maintain the ESU? Who maintains the device? What do you do to maintain the device? Do you have access to training and instructions on how to maintain the product? Do you have the needed tools available? Do you replace parts before they break? What are struggles/ barriers when it comes to maintenance?
<p>Repair</p> <ul style="list-style-type: none"> Do you repair ESUs when they break? Who repairs the device? Do you have access to training and instructions on how to repair the product? Do you have the needed tools available? Is it difficult to get spare parts? What are struggles/ barriers when it comes to reparation? 	<p>Request spare parts </p>	<p>Order - Procurement officer </p> <ul style="list-style-type: none"> What does the procurement officer exactly do? Does the procurement officer add new specifications or does (s)he only place the order with the specifications derived from the BMET?
<p>Spare part delivery - Distributor </p> <ul style="list-style-type: none"> How long does it usually take to get needed spare parts? What if the local distributor does not have access to those spare parts? 	<p>Disposal - General </p> <ul style="list-style-type: none"> When and how do you decide to dispose an ESU? How and where do you dispose the device? Do you need permission? Do you recycle parts of the device? Do you think it is important to recycle things? What happens to the products? Is someone picking them up? 	

<p>Where?</p>	<p>What?</p>	<p>How?</p>
<ul style="list-style-type: none"> To which university / medical school did you go? What was the first hospital you worked in? Who taught you something about electrosurgery? 	<ul style="list-style-type: none"> How much percent theory and how much practical skills? What kind of practical exercises did you do? What theory did you learn about electrosurgery? What did you learn about selecting the power settings? (How much Watt? What waveform mode?) How did you like this approach? 	<ul style="list-style-type: none"> In case you get a new device at the hospital, how do you get familiar with this new product? What do you think of this approach? Would you prefer something else? Is there a reason why you have this approach at your hospital and not another one?
<p>Feeling?</p>	<p>How often?</p>	
<ul style="list-style-type: none"> On a scale from 1 to 10 how confident did you feel after your training to actually perform electrosurgery on a real patient? (1 not confident at all; 10 very confident) Why? 	<ul style="list-style-type: none"> How often do you refresh your knowledge and skills? How often would you like to have a refresher? 	
<p>The device</p>	<p>Human factor</p>	<p>Communication / Interaction</p>
<ul style="list-style-type: none"> Did you ever face any complications when handling an electrosurgical unit / return electrode plate? Can you specify? What aspects of the ESU have (great) potential for risks? Which aspects of the ESU should be redesigned / improved according to your opinion? 	<ul style="list-style-type: none"> Did you ever experience a lack of human resources in a hospital you worked in? If yes, how did this effect the safety of a surgery? How would you rate the workload in your occupation? How does the lack of human resource influence the workload? How does a high workload effect the safety? 	<ul style="list-style-type: none"> Do you hold a briefing prior to surgery? Why or why not? Do you communicate a lot during surgery? Do you think that good communication prevents risks? How can bad communication cause risks? Do you think that in general there is enough time to communicate prior, during and after surgery with the team? Did you ever receive communication training or do you have access to communication tools?
<p>External factors</p>		
<ul style="list-style-type: none"> Are there factors in the OR that might be risky during an electrosurgery? Infections are a great risk when it comes to surgery? Would you like to perform more minimal invasive surgery in the future? Why is it currently not performed that often? 		

3 Evaluation Test Plan

Evaluation Equipment Journey

1 Hypotheses

Based on my own experiences with using the journey the following hypotheses have been formulated:

- The Equipment Journey provides designers and researchers with new insights into the journey of surgical equipment in low and middle income countries
- The Equipment Journey provides insights in the context and enables the user to empathize with the context and the involved stakeholders
- The journey helps determine risky moments within the context and it reveals insights into moments where they could intervene with a new design
- The Journey is also valuable for designers and researchers who are not focussing on improving electrosurgery

2 Evaluation Objective

The evaluation of the equipment journey is intended to assess the journey's usability and to test the hypotheses by interviewing potential users. It will be evaluated whether the journey serves as a tool to provide insights into the low-resource surgery setting and if it contains valuable data for other designers and researcher who are working on projects focussing on such a context. This evaluation is also intended to gather participants' feedback on the Journey's design.

3 Evaluation equipment

The participant is provided with the procurement and pre-surgical phase of the Equipment Journey. The online journey is presented on a laptop and is an interactive tool, in which the participant can navigate through the phases. The participants are only presented with the procurement and pre-surgical phase, because this are the phases in which the electrosurgical unit is less dominant than in the other phases. This is important since the participants do not have much or any knowledge about electrosurgery yet.

Additionally, there are an assumption form for the participant to be filled out during the evaluation, pen and paper in case the participant wants to take notes, and there is a video camera to record the session for analysis purposes.

4 Participants

4.1 Intended users

The intended users of the equipment journey are designers, design researcher and researchers who all work or plan on working on projects related to equipment in OR settings in low and middle income countries. The intended users have not visited this context yet and therefore have no first hand experience with this setting.

4.2 Participants

The participants of this evaluation will be designers and researchers who have not been in a low-resource healthcare setting before. The participant group can be divided into two sub-groups:

1. Laypeople: Participants who do not have a medical background and therefore do not have much or no knowledge about healthcare settings. They do not currently work on a project related to low and middle income countries, OR theatres or electrosurgery.
2. Biomechanical engineers: The second group of participants are biomechanical engineers who focus on developing medical instruments. These participants have some knowledge about the healthcare setting and medical equipment, but have never been to an OR theatre in a low or middle income country before.

5 Evaluation execution

The evaluation is expected to last about 40 minutes, which should provide enough time to let the participant fill out the assumption form, read through the two phases of the equipment journey and ask interview questions.

Each evaluation will include the following activities:

Welcome and orient participants

The test facilitator will begin each session by thanking the participant for taking part in the study. The test facilitator will introduce himself/herself and initiate “small talk” to create a friendly working atmosphere and reduce any tension that the participant might be experiencing.

Session introduction

Next, the test facilitator will read the test session introduction presented in the facilitator guide. This introduction will serve to describe the test session in general as well as encourage the participant to give honest feedback.

Fill out assumption form

If the participant feels ready, the facilitator will hand over a form in which the participant is asked to write down his assumption about the context and its stakeholders (see appendix A). Therefore, the participant is asked to answer nine questions. About 5 to 10 minutes are scheduled for this activity.

Exploring Equipment Journey

After filling out the assumption form the participant is given the chance to look through the equipment journey. The facilitator asks the participant to look for new insights. In case the participant wants to take notes, (s)he can do that on the paper which is laying on the table. In total the participant has about 15 minutes to read through the journey.

Administer exit interview

After the participant has explored the equipment journey, the test facilitator will conduct an exit interview. This interview will focus on evaluating if the participants have gained new insights. Next, the usability and added value of the equipment journey in design and research projects will be evaluated. Additionally, the interview will focus on gathering additional feedback on the design of the journey. Refer to the facilitator guide for a list of questions that the test facilitator will ask during the exit interview.

6 Data analysis

By comparing the responses to the assumption and interview questions it will be analyzed if the participants gained new insights.

All the responses to interview questions will be organized into related groups in order to reveal opinion patterns.

Facilitator Guide Evaluation Session

Thanks for being willing to take part in this evaluation session of the Surgical journey in low and middle income countries. The goal of this session is to collect feedback on the usability of the journey.

In a moment you will be asked to fill out a form, then you have time to explore the journey and at the end I will ask different questions related to the journey in general.

Feel free to give honest feedback, this will only help me in improving the journey.

This Equipment Journey represents the journey of electrosurgical equipment in a hospital in Kenya. For this evaluation we will only have a look at the first two phases of this journey, namely the procurement and the pre-surgical phase. You do not need to know anything about electrosurgery for this evaluation already, but I will give you a short explanation about electrosurgery before we start.

Electrosurgery is an effective tool to cut biological tissue and to coagulate it, which means heating up and drying out the tissue. The positive effect of this is that blood loss is kept to a minimum.

Cutting and coagulation are both achieved by heat generated due to a controlled amount of electricity flowing through the tissue. There is bipolar and monopolar electrosurgery (show both handhelds). Today we only focus on monopolar electrosurgery. In this case the handheld has one active electrode. In order to remove the current safely from the patient's body a patient plate is attached to the patient's body. This way the electrical circuit is closed.

The session is scheduled to last up to 40 minutes. You can take a break at any time. Also, you can end the session at any time if you are feeling unwell or uncomfortable.

Do you have any questions before we continue?

Assumption form

I would like you to take about 5 to 10 minutes to answer the questions on this form. There are no trick questions. I will not judge your answers, there are no right answers to these questions. It just about your opinion. Take your time and let me know if you are finished.

Exploration Equipment Journey

You have now about 15 minutes to look through the equipment journey. After this exploration we will evaluate if you have new insights into the context based on the journey. If you like you can use the pen and paper to make some small notes, but do not feel obligated.

Exit interview

- What is your first impression of the journey?
- When looking back at your first assumptions, what new insights did you gain?
- Are there any additional insights you found interesting?
- Do you think the equipment journey is a good way to communicate data? Why or why not?
- Would you prefer an article?
- What do you think about the combination of illustrations and photos?
- Imagine you will continue my project and try to improve the ESU design for LMICs. Do you have the feeling that the journey helps you empathize with the context without going there?
- How do you think the equipment journey could be used during projects?
- How trustworthy do you consider the information? Why?
- Do you miss any information?
- What do you like about the journey? Why?
- What do you dislike about the journey? Why?
- Do you have recommendations for improvements of the journey?

Assumption Form Designers

Surgery in low- and middle income countries

Focussing on the procurement and pre-surgery phases

What is your educational background?

Are you a designer / researcher / both ?

Have you ever visited an OR theatre in a low- or middle income country?

Which stakeholders do you think are involved in the procurement (inkoop / aanschaf) phase of new equipment? *Please name all the stakeholders and one or several of their tasks within this phase.*

In case you have not mentioned it yet, who do you think orders new machines for the OR theatres?

Do you think there are any complications / problems during the procurement phase? If yes, what kind?

Which stakeholders do you think are involved in the pre-surgical phase ? *Please name all the stakeholders and one or several of their tasks within this phase.*

Who do think is responsible for operating machines such as the electrosurgical unit, and needs to for example select the correct settings prior to surgery and during surgery?

Where do you think disposable equipment goes after use?

Assumption Form Biomechanical engineers

Surgery in low- and middle income countries

Focussing on the pre-surgery phase

What is your educational background?

Are you a designer / researcher / both ?

Have you ever visited an operation theatre in a low- or middle income country?

Which stakeholders do you think are involved in the pre-surgical phase ? *Please name all the stakeholders and one or several of their tasks within this phase.*

Who do think is responsible for operating machines such as the electrosurgical unit, and needs to select the correct settings prior to surgery and during surgery?

Where do you think disposable equipment goes after use?

Can you think of any safety concerns related to the pre-surgical phase?

4 Appendix - Patient plate study

The research shows that there are a lot of points for improvement regarding the current patient plate design. The patient plates which are mainly used in the Moi Teaching and Referral Hospital are the blue return electrode stickers from Valleylab (see figure 26). These are single use stickers. However, due to a shortage of resources the staff re-uses the patient plates up to 50 times. My research showed that this causes the following problems:

- The patient plate cannot be cleaned, because then it would lose its stickiness.
- The patient plate loses its stickiness after a while also if not being cleaned.

Those problems lead to the following hazardous situations:

- The return electrode often loses contact with the patient's tissue during the procedure (see figure 27). As a result the REM system deactivates the active electrode and the surgery gets interrupted. This delays the whole procedure.
- As a reaction to the lost stickiness the staff places the return electrode underneath the patient's body so that the weight will ensure contact. However, areas where the patient touches the surgical table and areas with very bony prominences should be avoided, since the blood circulation is very low at these spots. This could cause patient plate burns.
- Additionally, the patient plate gets very dirty after several times of use (see figure 28). Since the return electrode is usually placed as close as possible to the surgical site, it increases the infection risk for the patient.

The risk that users place the return electrode pad on areas with bony prominences or between the patient and surgical table is mitigated by the patient plate information sticker, presented in the previous chapter. A proper attachment of the patient plate and the ability to clean it should be facilitated by design. Therefore, I conducted a small study in which I evaluated three different design concepts.



Figure 26: Patient Plate from Valleylab



Figure 27: Loose patient plate



Figure 28: Dirty patient plate

Research goal

The goal of the patient plate study is to find out about the requirements and wishes of the user regarding a new patient plate design.

Research questions

1. Which concept do the users prefer and why?
2. What design features would they like to see in a new return electrode concept?
3. What aspects of the concepts do they not like? Why?

Research method

For this study I designed three concept ideas. I visualized every concept with a simple drawing and mock-up (see figure 29-32). I chose to make low fidelity mock-ups so that study participants do not hesitate to give critical feedback.

The first concept is called Tourniquet, since it contains the same attachment mechanism. The belt is very elastic so that it not restricts the blood flow. Within one step the plate can be attached around the patient's body. In order to be usable for different body dimensions, it is possible to change the belt. The hospital could for example have three belts of different length which they can change according to the size of the patient.



Figure 29: Patient plate mock-ups

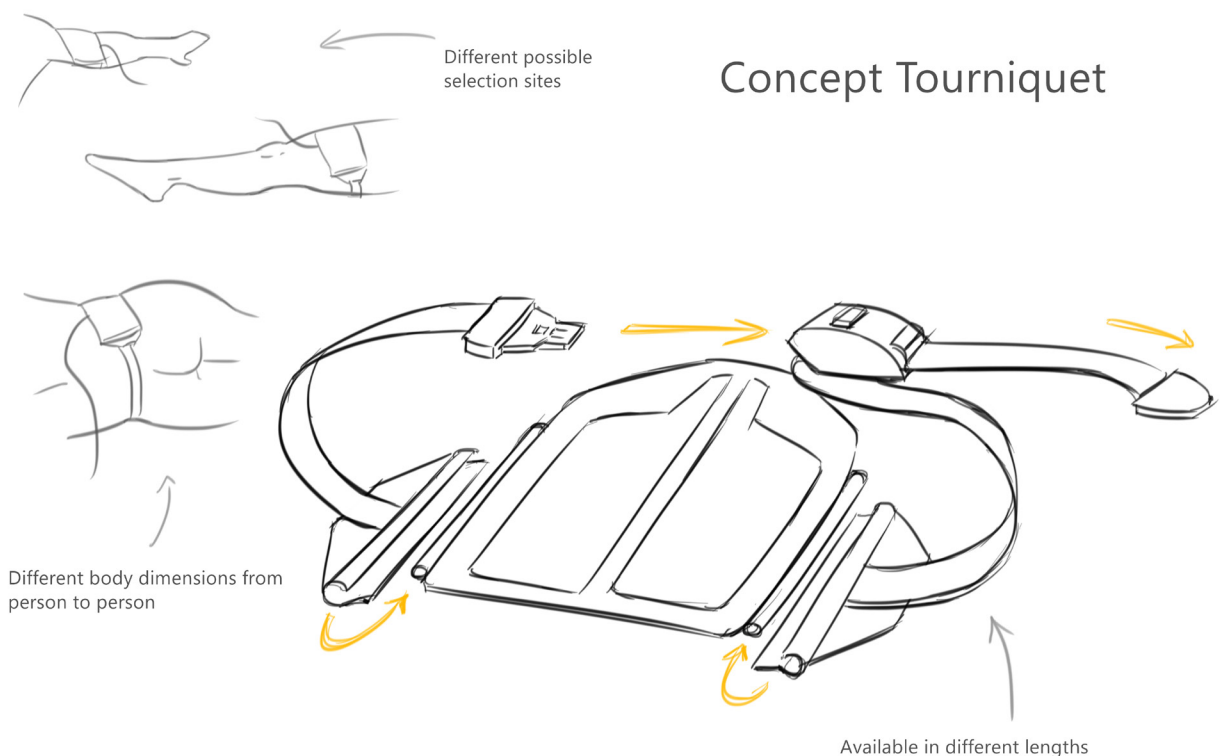

Figure 30: Concept Tourniquet

The second concept is called Velcro, because it contains a hook-and-loop fastener (see figure 31). Just like in concept one the belt is elastic and it is possible to adjust the length of the belt.

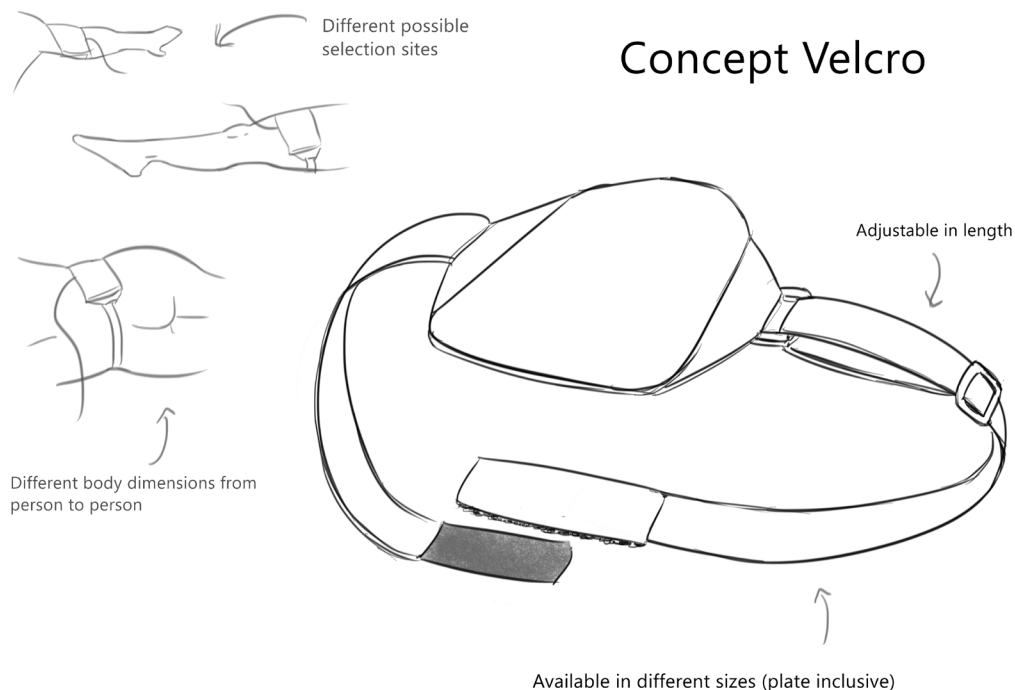

Figure 31: Concept Velcro

The last concept is Concept Tape. Unlike the other two concepts this patient plate concept has no belt (see figure 32). Instead, the user can use medical tape to attach the pad to the patient's body. In terms of attachment site this concept is more flexible than the other two. On top of the pad is a visualisation of how to attach and pad to the body.

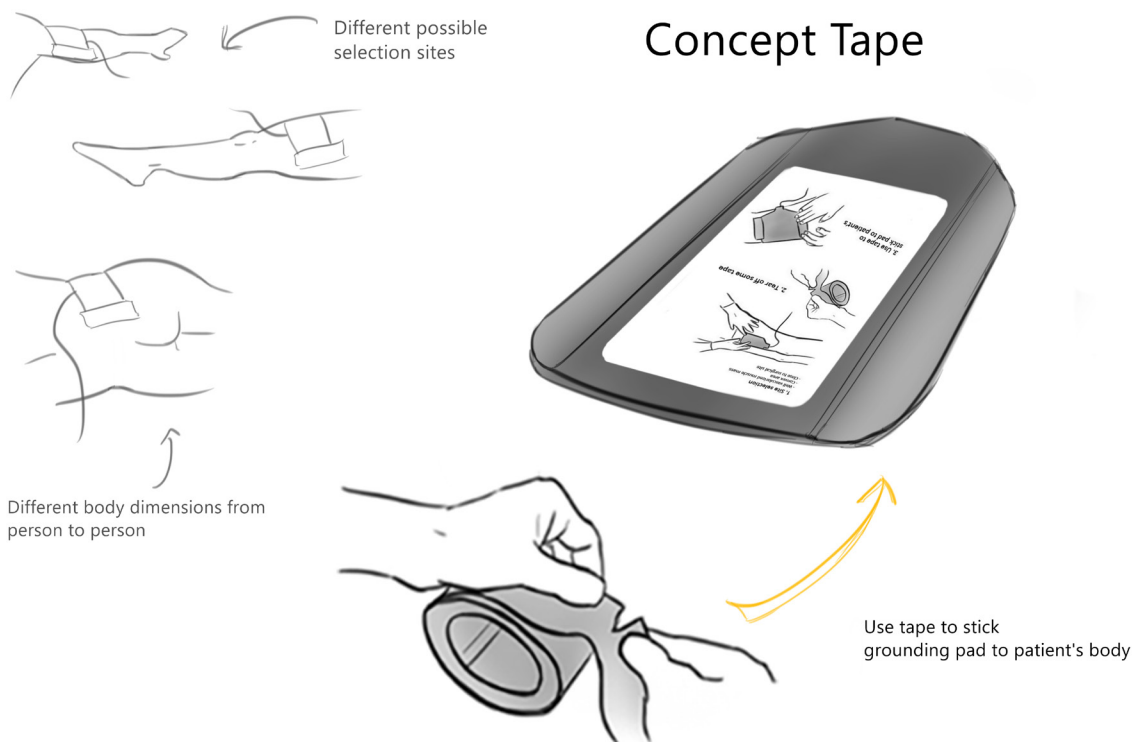

Figure 32: Concept Tape

I did not add the cable of the return electrode to the mock-ups. Even though the material of the electrode pads is not determined yet, the patient plates should be made out of a material which is resistant to Cidex. Therefore, none of the concepts contains glue.

I put the drawings and mock-ups on the table in the rest area, where the nurses have some tea during prior to the first surgeries.

Results

In total seven people (5 nurses and 2 BMETs) participated in the patient plate study and evaluated the three different concepts. The most interest was shown in the Velcro and Tourniquet concepts. Three people preferred the Velcro concept, two would like to

see a combination of the Velcro and Tape design, one participant preferred the Tourniquet concept and one participant had no preference.

In figure 33 a number of comments about the different concepts can be found.

Concept Tourniquet	Concept Velcro	Concept Tape
<p>"The Tourniquet looks a bit more complex than the Velcro. But it is nice to know that the plate will stick to the body during the whole procedure. Then you do not need to worry about it." (Nurse)</p>	<p>"I like this one. It seems very easy to put on. Only takes you a few steps. That's important, since we do not have much time." (Nurse)</p>	
<p>"What is nice about the tourniquet, is that it is the most adjustable. But I think it is not good for maintenance and it will break more easily since it is consisting of plastic parts." (Nurse)</p>	<p>"The one with Velcro looks very robust. Because we do not have many resources it should be long lasting." (Nurse)</p>	
<p>"I like the tourniquet design. Easy to adjust to body dimensions." (BMET)</p>	<p>"I think Velcro one is good if you need to place plate on top of body." (Nurse)</p>	
	<div data-bbox="654 1563 1412 1803" style="border: 1px solid black; padding: 5px;"> <p>I like the Velcro. It is easy to put around body and can be adjusted to size. But, if you need to place it onto shoulder or butt you cannot use the Velcro. Than we would use the one with tape. Because, the return electrode needs to be placed on well vascularized mass and close to surgical site. So we will use both.</p> </div>	
<div data-bbox="295 1848 1412 2083" style="border: 1px solid black; padding: 5px;"> <p>Depends on where you put return electrode. On shoulder you would not use the Velcro or tourniquet concept. But for on top of body, for example on leg, those would be great. Maybe you should have a combination of the tape and Velcro/tourniquet concept. It should be easy to clean, people are sometimes very lazy when it comes to cleaning. Things often fall on the dirty floor. When the plate falls on the floor it should not break.</p> </div>		

Figure 33: Feedback concepts

Recommendations for future patient plate design

The current results of this little study show a slightly preference for the Velcro design, since it seems robust, easy to attach to the patient's body and long lasting. The Tourniquet design scored lower, because it seems more fragile.

Two people proposed to come up with a design which combines the Velcro/ Tourniquet idea with the Tape concept. They argued that the concepts with a belt are good for attaching the patient plate to the side or on top of the body, but it is not very suitable for placing the plate for example underneath the shoulder. In that case they would prefer the Tape concept. This is an interesting suggestion, because it shows again that the users are not aware of the risks that are related to placing the plate between the patient and surgery table and on areas with bony prominences.

Therefore, a future concept should prevent this risk by design, which means that the design should not facilitate the selection of those areas such as the Tape concept apparently does.

For the future I would propose to create more iterations on patient plates that are containing a belt or are able to attach to the patient's upper legs and waist in a different way. I would advise to make a pad out of silicon, since it is a good conductor and therefore reduces the risk of patient plate burns. More usability studies with more participants should be conducted in order to come up with a concept that increases the safety for the patient and the user-friendliness for the user.

5 Lessons Learned

Doing field research in a country which is very different from the Netherlands in terms of cultural habits and values, infrastructure, and resources requires a different research preparation and methodology when compared to doing research in the Netherlands. There are several lessons I learned from my field study in Kenya. Those will be presented in this report in order to inspire other designers who are about to do research in a foreign low-resource healthcare setting.

Write down your assumptions. It is very helpful to write down all your assumptions about the expected data prior to going onto the field trip. I mapped out the whole equipment journey which I assumed based on previous research and interviews. Even though the equipment journey turned out to be very different in the end, it helped me to familiarize myself with the new context. Having an understanding of the context and possible phases and activities within the journey was important input for developing research questions, and for determining the research.

Additionally, mapping out assumptions and thereby already getting an idea of the context helps not to get too overwhelmed by all the new impressions when being in the field. Being in an operation theatre for the first time of your life in a low- or middle income country is an intense experience. Having at least some idea of what to expect prior to entering this new context can help to keep a cool head and provides some guidance during observations.

Prepare a flexible research method. Good preparation is key. It is always important to detailly plan a field study. However, for studies in a foreign low- or middle income country variables such as the number of participants, available interview time, and the test/interview environment are very difficult to organize and plan from the Netherlands. In order to gather all the needed data it is important to prepare a flexible research set-up and tools.

Gain people's trust. I learned that it is very important to gain people's trust, especially, when you attract a lot attention due to your different appearance. When I did my first observations in the operation theatres I had

not had the chance to introduce myself to everyone. When I asked questions while holding my little booklet in my hands a lot of people seemed very sceptical and hesitated to give me answers. Based on those experiences on my first day, I decided to take more time for introducing myself and even more important to do some small talk. Having a cup of tea together and showing my intention to learn something from them lead to a better and more relaxed atmosphere.

Pay attention to how to formulate questions, and ask multiple times. Another lesson I learned during this field research is that it is very important to pay attention to how questions are formulated. First of all questions should always be open-ended. However, during this study in Kenya I also learned that asking the same question slightly different for multiple times often leads you to different answers. When I for example asked "What happens now with the return electrode sticker?", the nurse hesitated and finally said that the stickers are thrown away after single use. However, I had already noticed that the sticker are reused multiple times. Therefore, I asked the following question a few minutes later: "So you can put the return electrodes into Cidex after the surgery?". Now she confirmed and gave me more information about how the patient plates are being reused. The first question is very open. The nurses know that the patient plates ideally should be disposed after single use and not put into Cidex. Since the question is open she more easily tends to talk about the ideal situation than when being asked question 2 in which I already show that I know that putting the plate into Cidex is an option. The combination of observations and interviews is therefore a good practice to get in-depth information. This also taught me that I should not always trust first information.

Furthermore, I learned that pretending that you have no idea about certain information you are after, helps to get people talking. When I introduced myself to people I told them that this was my first time in an operation theatre, that everything was very exciting and new, and that I came to learn more about electrosurgery. I then for example asked questions such as: "Oh but this

looks rather dangerous, is this safe you think?”. Even though literature study had already taught me about certain risks I did often not mention those insights in order to discover how the medical staff judges certain situations.

Get an understanding of cultural values. One of my interview questions was: “How (confident) did you feel when performing electrosurgery for the first time?” The surgeons’ answers were always very short. Usually nothing more than “Confident” was the answer. Additionally, they seemed to avoid further questions which were asked to get more information about their feelings. Later a BMET who had lived in Europe for a few months told me during coffee that he found it very funny that Europeans always ask about someone’s feelings such as “How do you feel about...?”. He said that in Kenya those expressions do not even exist. According to him Kenyans do not like to talk about their feelings. There are even some Kenyan sayings such as “Keep your feelings with you” and “Don’t bother others with your feelings”.

I found this information very interesting since this might be the reason for why questions about feelings did not generate a lot of useful data.

Therefore, a lesson is that it can be very useful for the research preparation to gain some insights into the culture and habits of the country you are about to visit.

