

## **Adaptive thermal comfort opportunities for dwellings**

### **Providing thermal comfort only when and where needed in dwellings in the Netherlands**

Alders, Noortje

**DOI**

[10.7480/abe.2016.13](https://doi.org/10.7480/abe.2016.13)

**Publication date**

2016

**Document Version**

Final published version

**Citation (APA)**

Alders, N. (2016). *Adaptive thermal comfort opportunities for dwellings: Providing thermal comfort only when and where needed in dwellings in the Netherlands*. [Dissertation (TU Delft), Delft University of Technology]. A+BE | Architecture and the Built Environment. <https://doi.org/10.7480/abe.2016.13>

**Important note**

To cite this publication, please use the final published version (if applicable). Please check the document version above.

**Copyright**

Other than for strictly personal use, it is not permitted to download, forward or distribute the text or part of it, without the consent of the author(s) and/or copyright holder(s), unless the work is under an open content license such as Creative Commons.

**Takedown policy**

Please contact us and provide details if you believe this document breaches copyrights. We will remove access to the work immediately and investigate your claim.



Architecture  
and the  
Built environment

#13  
2016



## Adaptive thermal comfort opportunities for dwellings

Providing thermal comfort only when and where needed in dwellings  
in the Netherlands

Noortje Alders



# Adaptive thermal comfort opportunities for dwellings

**Providing thermal comfort only when and where  
needed in dwellings in the Netherlands**

Noortje Alders

*Delft University of Technology, Faculty of Architecture and the Built Environment,  
Department of Architectural Engineering + Technology*

**Design:** Sirene Ontwerpers, Rotterdam

ISBN 978-94-92516-12-1

ISSN 2212-3202

© 2016 Noortje Alders

All rights reserved. No part of the material protected by this copyright notice may be reproduced or utilized in any form or by any means, electronic or mechanical, including photocopying, recording or by any information storage and retrieval system, without written permission from the author.

Unless otherwise specified, all the photographs in this thesis were taken by the author. For the use of illustrations effort has been made to ask permission for the legal owners as far as possible. We apologize for those cases in which we did not succeed. These legal owners are kindly requested to contact the publisher.

# Adaptive thermal comfort opportunities for dwellings

**Providing thermal comfort only when and where  
needed in dwellings in the Netherlands**

Proefschrift

ter verkrijging van de graad van doctor  
aan de Technische Universiteit Delft,  
op gezag van de Rector Magnificus prof. ir. K.C.A.M. Luyben,  
voorzitter van het College voor Promoties,  
in het openbaar te verdedigen op 16-09-2016 om 10:00 uur  
door Eleonora Elisabeth ALDERS  
Master of Science in Architecture, TU Delft  
geboren te Haarlem

## Dit proefschrift is goedgekeurd door de

---

promotor: Prof. dr. ir. A.A.J.F. van den Dobbelsteen  
copromotor: ir. A.C. van der Linden

## Samenstelling promotiecommissie bestaat uit

---

Rector Magnificus,	voorzitter
Prof. dr. ir. A.A.J.F. van den Dobbelsteen	promotor
ir. A.C. van der Linden	copromotor

## Onafhankelijke leden

---

Prof.dr.ing. U. Knaack,	Bouwkunde, TU Delft
Prof. dr. K. Blok,	TBM, TU Delft
Prof. dr. ir. D. Saelens,	Leuven University, Belgium
Prof. K. Steemers	University of Cambridge, UK
Prof. S. Roaf,	Heriot Watt University, UK
Prof. ir. M.F. Asselbergs,	Bouwkunde, TU Delft, reservelid

---

This research was partially funded by AgentschapNL and supervised by  
ir. E.R. van den Ham, which is thankfully acknowledged.

**Not everything that can be counted counts. Not everything that counts can be counted.**

*William Bruce Cameron*





# Acknowledgements

Firstly, I would like to thank my promotor Andy van den Dobbelsteen and my daily supervisors Kees van der Linden, Eric van den Ham and Stanley Kurvers for their support and guidance. I also thank Hans Cauberg for being my promotor until after his emeritus status. Furthermore, I would like to acknowledge the committee members Prof. Ulrich Knaack, Prof. Kornelis Blok, Prof. Dirk Saelens, Prof. Koen Steemers, Prof. Sue Roaf and Prof. Thijs Asselbergs for their valuable contribution.

I would like to thank the Dutch institute of AgentschapNL for giving me the opportunity and partly funding my PhD research participating in the research work-group DEPW. together with BouwhulpGroep, Cauberg Huygen and the university of Maastricht.

Thank you to all my (former) colleagues of the Faculty of Architecture for the moral support, good advice and a pleasant working environment. It was good to see us all sticking together even after the fire at the faculty of Architecture.

A special thanks for the for the very personal, cooperative and supporting attitude and many life saving efforts for Véro Crickx at Sirene Ontwerpers.

I would very much like to thank all my friends and family for their support and the relaxing company. A special thanks to Esther, Kelly and Frank who I got to see a lot less over the last years. and Christian, Valesca, Eline, Erik, Marjolein and Richard for the holidays (BANG!) and the "bakkies" and "kleintjes" we had together. The group of friends I made by dancing Cuban Salsa and Rueda not only for the relaxing, activating and soothing dances we did but also for the moral support and friendly environment.

My parents and brothers thank you for the patience and moral support and especially my father, who sadly can't experience my graduation.

Last but certainly not least I would like to thank Thijs for his patience, moral support and the very clarifying and inspiring drawings that enriched my thesis.



# Contents

Summary	17
Samenvatting	23
Nomenclature	31

## 1 Introduction 35

---

### 1.1 Thermal comfort and energy use 35

---

#### 1.1.1 The new stepped strategy 36

### 1.2 Research design 36

---

#### 1.2.1 Background hypotheses 38

#### 1.2.2 Problem definition 38

#### 1.2.3 Research objective 38

#### 1.2.4 Methodology 39

### 1.3 Research questions 40

---

### 1.4 Research context and boundaries 42

---

### 1.5 Expected results 43

---

### 1.6 Novelty 44

---

## **PART 1 Frame of reference**

---

## 2 Conditions for the Adaptive Thermal Comfort System 49

---

### 2.1 Introduction 49

---

2.2	Research Design	49
2.2.1	Problem statement	49
2.2.2	Research question	50
2.2.3	Structure	50
2.3	Thermal comfort assessment and occupancy profiles	51
2.3.1	Two most important thermal comfort theories and their limitations	51
2.3.2	Options for improvement in thermal comfort assessment in relation to the Adaptive Thermal Comfort System	56
2.3.3	Translating the Adaptive Temperature Model for the Adaptive Thermal Comfort System for dwellings	58
2.3.4	Considerations for presence and control in the Adaptive Thermal Comfort System	64
2.4	Weather and thermal comfort	67
2.4.1	Physiological Equivalent Temperature (PET)	68
2.4.2	The Dutch situation	69
2.4.3	Elaborate analysis of the Dutch weather in the context of thermal comfort	72
2.4.4	PET analysis of the recorded weather in the Netherlands and the test reference year of 2050 W+	74
2.4.5	Creating a sheltered environment for (pre)conditioning of the thermal environment	77
2.5	Conclusions	80
2.5.1	Occupant	80
2.5.2	Weather	81
3	Adaptive Opportunities for thermal comfort systems in dwellings	83
3.1	Introduction	83
3.2	Research Design	83
3.2.1	Problem statement	83
3.2.2	Research questions	84
3.2.3	Structure	84

3.3	Spatial layout	85
.....		
3.3.1	Adaptiveness of the spatial layout	85
.....		
3.4	Materialisation	91
.....		
3.4.1	Adaptive solar gain	91
3.4.2	Natural ventilation	98
3.4.3	Insulation	101
3.4.4	Thermal mass	105
.....		
3.5	HVAC	107
.....		
3.5.1	Mechanical ventilation supply	108
3.5.2	Thermal energy generation	109
3.5.3	Heat distribution and end units	112
.....		
3.6	Control of the Adaptive Thermal Comfort System	114
.....		
3.6.1	Usability	115
3.6.2	Controlling and controlled parameters in the Adaptive Thermal Comfort System	116
3.6.3	Obtaining the information about the controlling parameters	118
3.6.4	Control algorithm	120
.....		
3.7	Summary	121
.....		

## **PART 2 Calculations**

.....

4	Development and use of the used calculation methods.	127
.....		
4.1	Introduction	127
.....		
4.2	Research design	127
.....		
4.2.1	Problem statement	127
4.2.2	Research questions	128
4.2.3	Method	128

4.3	Results and Discussion	129
.....		
4.3.1	The parameters to be considered	129
4.3.2	Existing detailed and transient simulation programs	130
4.3.3	Lumped capacitance method	131
4.3.4	Comparison of the lumped capacitance models	137
4.3.5	Comparing the lumped capacitance model and the TRNSYS model	143
4.4	Conclusions	149
.....		
5	Adaptive Building Characteristics	151
.....		
5.1	Introduction	151
.....		
5.2	Research design	152
.....		
5.2.1	Problem statement	152
5.2.2	Research question	152
5.2.3	Research tools	152
5.2.4	Data, assumptions, cases and variants	153
5.2.5	Analysis	158
5.2.6	Energy use of reference situations	158
5.3	Results and Discussion	161
.....		
5.3.1	Energy saving effect of adaptive comfort delivery	161
5.3.2	Minimised heat loss coefficient	164
5.3.3	Adaptive heat loss coefficient	166
5.3.4	Adaptive solar factor	173
5.3.5	Adaptive heating, heat loss factor and solar factor combined	176
5.3.6	Orientation	181
5.3.7	Change rates of the Adaptive Thermal Comfort System	183
5.3.8	Automation versus manual operation	184
5.4	Conclusions and remarks	186
.....		
5.4.1	Energy saving potential of the adaptive measures	186
5.4.2	Required values for $H_{tot}$ and $f_{sol}$	189
5.4.3	Effect of the thermal mass	189
5.4.4	Effect of occupancy	190
5.4.5	Heat up and cool down speed	191

6	Implementation of Adaptive Thermal Comfort System concepts in the standard reference dwelling	193
6.1	Introduction	193
6.2	Research design	193
6.2.1	Problem statement	193
6.2.2	Research questions	194
6.2.3	Method	194
6.3	Example concepts based on the reference dwelling of AgentschapNL	194
6.3.1	Context: the occupant	194
6.3.2	Context: the weather	195
6.3.3	Considerations for the spatial layout	196
6.3.4	Concepts for materialisation	197
6.3.5	HVAC design	204
6.3.6	Controls	205
6.3.7	Simulated variants	205
6.3.8	Energy use of the reference situations	207
6.4	Results and discussion	208
6.4.1	Adaptive heating	208
6.4.2	Minimised ventilation	210
6.4.3	Adaptive ventilation by operable vents above the windows	212
6.4.4	Adaptive solar gain	215
6.4.5	Adaptive heating, ventilation and solar gain	217
6.4.6	Automation versus manual operation	219
6.4.7	Added energy saving potential of heat recovery	221
6.4.8	Auxiliary energy	222
6.5	Conclusions	223
6.5.1	Requirements for the Adaptive Thermal Comfort System	223
6.5.2	Energy saving potential of the of the Adaptive Thermal Comfort System in a standard reference dwelling	225



## PART 3 Synthesis

---

7	The Adaptive Thermal Comfort System	229
7.1	Introduction	229
7.2	Occupancy in the Adaptive Thermal Comfort System	231
7.3	Weather and the Adaptive Thermal Comfort System	233
7.4	Spatial layout of the Adaptive Thermal Comfort System	235
7.5	Materialisation of the Adaptive Thermal Comfort System	237
7.5.1	Solar gain	237
7.5.2	Natural ventilation	240
7.5.3	Insulation	243
7.5.4	Thermal mass	244
7.6	HVAC	246
7.7	Control systems for the Adaptive Thermal Comfort System	248
8	Conclusions and Recommendations	251
8.1	Introduction	251
8.2	Answering the research question	251
8.3	Main contributions to science and the building practice	258
8.4	Scope, limitations and prospect of the research	258
8.5	The Adaptive Thermal Comfort System for the Netherlands now and in the future	261
8.5.1	Improvements for the future	264

References	269
Appendix A	Occupancy profiles 273
Appendix B	Description and equations of the lumped capacitance models 289
Appendix C	Input calculations chapter lumped capacitance model 303
Appendix D	Input TRNSYS 309
Curriculum vitae	331
List of publications related to the PhD research	333



# Summary

The aim of the research presented in this thesis is to design the characteristics of an Adaptive Thermal Comfort System for Dwellings to achieve a significantly better energy performance whilst not compromising the thermal comfort perception of the occupants.

An **Adaptive Thermal Comfort System** is defined as the whole of passive and active comfort components of the dwelling that **dynamically adapts** its settings to **varying user comfort demands** and **weather conditions** (seasonal, diurnal and hourly depending on the aspects adapted), thus providing comfort **only where, when and at the level needed** by the user, to **improve possibilities of harvesting the environmental energy** (e.g. solar gain and outdoor air) when available and **storing it when abundant**.

In order to be able to create an Adaptive Thermal Comfort System to save energy knowledge is needed as to **where, when, what kind and how much energy is needed** to provide the thermal comfort. Therefore, this research aimed to gain insight in the dynamic behaviour of the weather and the occupant and the opportunities to design the characteristics of an Adaptive Thermal Comfort System for Dwellings to achieve a significantly better energy performance whilst not compromising the thermal comfort perception of the occupants answering the main research question;

*What are the most efficient strategies for delivering thermal comfort in the residential sector with respect to better energy performances and an increasing demand for flexibility in use and comfort conditions?*  
.....

To answer the main research question three steps were taken, which also represent the three parts of the research:

- 1 The dynamic information of the factors influencing the thermal heat balance of the dwelling was gathered in order to determine their opportunities for adaptivity. A multi-disciplinary approach to Thermal Comfort Systems is followed taking into account the dynamic of occupancy profiles, weather, building physics, HVAC and controls.

A different approach to the comfort boundaries used in modern standards was introduced, creating insight in the spread in activity patterns and the comfort demand in the context of individual preferences and vulnerabilities. Information of sociology and thermal comfort studies were brought together creating occupancy and thermal comfort profiles for the Dutch situation. By recognizing the differences in occupancy patterns it becomes possible to design adaptive systems to be able to deliver the comfort demanded only when and where necessary in different occupancy scenarios. This is an opportunity to achieve a significantly better energy performance.

Furthermore, a method for dynamic analysis of weather conditions related to the thermal comfort was proposed in order to map the opportunities and threats of weather change. This makes the system able to seize upon every reasonably to be expected situation to create an optimal dynamic filter for the outdoor to indoor thermal environment at any time and place. This preliminary study was performed by presuming a simple shelter that can create shielding from wind and solar radiation without any form of thermal storage or insulation.

In this study it is emphasised that there is no need for active cooling in the residential sector of the Netherlands if the dwelling is well designed; blocking solar radiation when needed and to allow built up excess heat to be discarded.

An inventory is provided of the possibilities for adaptivity for a thermal comfort system which are used in common practice and which improvements and new techniques can be implemented to increase these possibilities for adaptivity of the Adaptive Thermal Comfort System.

- 2 The effect of applying the detailed information and adaptive opportunities framed in step 1 on the energy saving and comfort delivery of the Thermal Comfort Systems was researched.

Firstly, the most appropriate calculation methods for the research were determined comparing various levels of detail and approaches in calculation. Control algorithms and strategies are researched. The thesis uses both the lumped capacitance model 3R1C based on the EN-ISO 13790 to benefit from its generic properties to be able to stimulate new concepts for adaptivity of the thermal comfort system to be developed and the TRNSYS model to verify the conclusions from the lumped capacitance model and research the short term practical implementation.

Through calculating various strategies in heating and prevention of overheating by using variable thermal insulation, ventilation and solar shading the advantages and disadvantages of the control strategies are researched. These calculations concluded that these can have a significant potential of reducing the energy demand of a dwelling whilst not compromising thermal comfort. The optimal behaviour of these building characteristics is described in part three of this thesis. The energy saving potential of the adaptive approach relative to the reference dwelling of AgentschapNL is very high regarding the following conditions;

The total energy saving potential for heating of the adaptive approach is around 61% on heating demand for the living room and 99% for the bedroom compared to the situation with adaptive thermal comfort delivery (providing heating only when and where needed), minimised ventilation and high insulation values.

This energy saving is achieved by adaptive and fast heating and adaptive increase of solar heat gain in case it would be possible in the future to harvest all solar radiation falling on the facade as heat.

Applying the variable building characteristics as described the cooling can be eliminated in most situations and will be 10% of the reference situation at most. The remaining cooling demand will be low enough to cancel the need for installation of active cooling. It is most effective to use both an adaptive heat loss factor and solar factor; however, to counter overheating controlling the solar factor is most effective of the separate measures assuming all solar radiation can be blocked from entering the room as heat.

In the reference cases the cooling load is significantly lower with higher thermal mass and the heating load does not significantly vary with thermal mass; this is due to the good basic insulation of the dwelling and sufficient solar gain which causes the drop in temperature during the non-heated periods to be very low regardless the thermal mass. The energy saving for cooling by the adaptive strategies is higher with higher thermal mass more drastically reducing the already much lower cooling demand for the references with higher thermal mass. In case of the North orientation it can be an option to build with lower thermal mass because there is significantly less solar radiation available to lower the heating demand; showing a slight increase in heating demand for the higher thermal mass variant. The advantages of adaptive solar shading are significantly lower with the North orientation due to the lower range of solar gain.

As the definition suggests the control of the thermal comfort system adaptive to the occupancy and the variable thermal comfort demand resulting from it is an essential part of the Adaptive Thermal Comfort System. This effect is most apparent in the case of adaptive heating; high occupancy means less heating demand than if a standard heating schedule is used because of higher internal gain while the heating demand with control for presence shows less deviation between the occupancy profiles and higher heating demands with higher occupancy. This means that the improvement of energy efficiency is larger the lower the occupancy level. Furthermore, the control algorithm designed in chapter 4 is significantly less accurate in case of the occupancy profile with highest occupancy especially because the temperature falls below the heating setpoint by the time the occupants re-enter the room resulting in higher heating demands than the reference, which can be prevented by prediction of the setpoint temperature. This effect decreases with higher thermal mass because of the slower temperature decrease during the night. Additionally, the occupancy has a great effect on the effectiveness of non-automated systems in case of overheating prevention meaning more effect of automation with lower occupancy rates. This emphasises the need for automated overheating protection by especially solar shading in case of larger periods of absence during the day.

- 3 The design recommendations for product development were provided and illustrated according to the design of an example dwelling with an Adaptive Thermal Comfort System, assessing some practical implementations. The guidelines and conclusions are categorised in 6 categories;



### Occupancy (§ 2.3)

The occupancy schedule was used to determine the dynamic demand on which the behaviour and energy saving potential of the adaptive building characteristic are calculated in this thesis. It is not possible or necessary to determine the exact comfort temperature for the occupant. Instead, a range was determined which should be easy to reach in an energy efficient way.

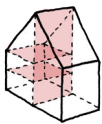
Great differences can exist in thermal comfort demand in occupancy of the spaces which makes the application of control according to presence a good way of increasing energy performance for thermal comfort. Relatively simple measures as occupancy sensors connected to the control of the heating can save up to 25% of heating demand depending on the occupancy profile.

### Weather (§ 2.4)



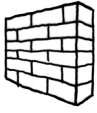
This thesis confirms the fact that in the Netherlands virtually **no overheating problems** are **caused directly by the weather** and that the **overheating occurring in dwellings** is due to the **trapping of heat** from incoming solar radiation and internal gains due to minimised heat loss combined with insufficient solar shading and possibilities to discard excess heat.

### Spatial layout (§ 3.3 & chapter 6)



According to this thesis there are some preconditions that will facilitate the functioning of the Adaptive Thermal Comfort System.

- To ensure the effectiveness of the adaptive ventilation the layout should not hinder the air flow through the building. In case of a heating demand this free air flow can be temporarily disabled by (automatically) closing doors and vents.
- The ventilation can be aided by designing the dwelling with increased cross ventilation, increased stack ventilation or a "venturi" chimney.
- To be able to profit optimally from the adaptive solar factor the rooms with the highest heating demand and/or very variable comfort demand should be oriented in the direction where most solar radiation comes from; if possible considering the time of day of the highest heating demand.



### Materialisation (§ 3.4 & chapter 5 & 6)

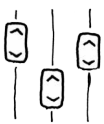
For energy saving in the heating season it is very effective to apply high insulation values and minimise ventilation to conserve energy together with allowing maximum solar radiation into the room. This can save up to around 80% in heating energy compared to the reference situation with constant ventilation and average insulation value in case it would be possible in the future to harvest all solar radiation falling on the facade as heat. These measures should be combined with adaptive solar gain and adaptive heat loss factor (more easily obtained by extra adaptive ventilation than adaptive thermal insulation) to prevent overheating problems outside the heating season. If it is possible to block all solar radiation this can eliminate practically all need for cooling.

The Adaptive Thermal Comfort System increases the stability in air temperature by optimizing the adaptive characteristics for the room temperature to remain closest to the comfort temperature without energy expenses. Therefore, no extra benefit for adaptive thermal mass in an Adaptive Thermal Comfort System is detected. High thermal mass is preferable for a dwelling with an Adaptive Thermal Comfort System as it is for all (sufficiently insulated) dwellings.



### HVAC (§ 3.5 & chapter 5 & 6)

To save energy in the heating season it is very effective to apply adaptive heating (around 25%); applying heat recovery has a significant added effect on energy saving (around 20% with a heat recovery efficiency of 60%). This needs to be regarded with the extra fan energy needed to operate the mechanical ventilation. Because the temperatures will fluctuate more than with constant heating and cooling the system needs to be able to heat up or cool down quickly, until approximately 6 °C in one hour. The extra energy saving gained by designing HVAC systems for an Adaptive Thermal Comfort System is applying techniques that, besides being energy efficient, can react fast and locally. Using high insulation in winter, high thermal mass and adaptive techniques as proposed in this thesis will stabilise the indoor temperature lowering the required heating speed to below 4 °C per hour with low thermal mass and below 0.5 °C per hour for high thermal mass which increases the possibility of applying different heating systems.



### Controls (§ 3.6)

It is very important to have a high level of automation in the Adaptive Thermal Comfort System because applying high insulation, no solar shading and minimised ventilation at absence of the occupant will lead to overheating problems. The energy saving potential of the automation for the adaptive ventilation decreases significantly for the profiles with least occupancy and lower thermal mass. The loss in effectiveness of the adaptive solar gain is dramatically decreased without automation with an average



of 75% less energy saving. The energy saving potential for the combined measures without automation drops with 30% on average increasing the required heat loss factor to discard excess heat. This makes the automation crucial for the Adaptive Thermal Comfort System and mostly for the solar gain.

Furthermore, prediction of the setpoint temperature in the near future (for instance with an Adaptive Model Predictive Control (self-learning control) (§ 3.6.4) system) can increase the efficiency of the system preventing the heating load to increase due to rapid temperature drop after a period of passive cooling especially with low thermal mass.

### **Energy saving potentials and ranges of adaptive settings (chapter 5 & 6)**

The need for cooling can be effectively diminished using the proposed adaptive measures and so the energy saving potential is nearly 100% for cooling. For heating the energy saving is around 25% compared to the reference by applying adaptive heating depending on the occupancy schedule and consequent heating demand and 66% for the living room and 90% for the bedrooms in the 3R1C model if the heat loss is minimised during the heating season. TRNSYS calculates an energy saving of around 45% for adaptive heating. An additional 20% can be saved on heating energy with heat recovery in the calculations with TRNSYS. In the lumped capacitance model it is shown that an additional 20% energy saving can be obtained compared to the TRNSYS calculations by increased solar gain (in case it would be possible in the future to harvest all solar radiation falling on the facade as heat) resulting in a total heating energy saving of around 80% on average.

# Samenvatting

Het doel van dit proefschrift is om de eigenschappen van een Adaptief Thermisch Comfortsysteem te ontwerpen voor woningen met aanzienlijk betere energieprestaties, terwijl de thermische comfort beleving van de bewoners gewaarborgd wordt.

Een Adaptief Thermisch Comfortsysteem in een woning wordt gedefinieerd als het **geheel van passieve en actieve** onderdelen van het comfortsysteem van de woning welke zich **dynamisch kan aanpassen** aan **wisselende comfort eisen van de gebruiker** en de **veranderende weersomstandigheden** (seizoensgebonden, per dag en per uur, afhankelijk van de adaptieve aspecten), waardoor het thermisch comfort geleverd wordt **alleen daar en wanneer en op het niveau dat nodig is voor de gebruiker**; om de mogelijkheden van het **oogsten van de omgevingsenergie** (bv zonnewarmte en buitenlucht) indien beschikbaar **optimaal te benutten** en energie **op te slaan** indien overvloedig aanwezig.

Om een Adaptief Thermisch Comfortsysteem te creëren teneinde energie te besparen is kennis nodig over **waar, wanneer, welk niveau en hoeveel energie nodig is** om het gevraagde thermische comfort te leveren. Daarom is dit onderzoek erop gericht om inzicht te krijgen in het **dynamisch gedrag van het weer en de bewoner** en de mogelijkheden om de **optimale eigenschappen van een Adaptief Thermisch Comfortsysteem** te ontwerpen voor woningen teneinde een **significant betere energieprestatie** te bereiken; terwijl de thermische comfort beleving van de bewoners wordt gewaarborgd. Dit wordt onderzocht middels het beantwoorden van de centrale onderzoeksvraag;

*Wat zijn de meest efficiënte strategieën voor het leveren van thermisch comfort in de residentiële sector met betrekking tot betere energieprestaties en een toenemende vraag naar flexibiliteit in het gebruik en het thermisch comfort?*

.....

Om de centrale onderzoeksvraag te beantwoorden werden drie stappen gezet, die ook de drie onderdelen van het onderzoek bedragen:

- 1 In stap 1 is de dynamische informatie van de factoren die de warmtebalans van de woning bepalen in kaart gebracht om de mogelijkheden voor adaptiviteit in het thermisch comfort systeem te bepalen. Een multidisciplinaire aanpak van Thermisch Comfort Systemen wordt gevolgd, rekening houdend met de dynamiek van de bewonersprofielen, het weer, bouwfysica, installaties en besturing.

Een andere benadering van de comfort grenzen dan gebruikelijk in de moderne standaarden werd geïntroduceerd; het creëren van inzicht in de spreiding van de activiteitspatronen en de comfortvraag, rekening houdend met individuele voorkeuren en kwetsbaarheden in tegenstelling tot een enkele gemiddelde comfort vraag.

Sociologisch informatie en informatie uit studies naar thermisch comfort werden samengebracht om bezettings- en thermisch comfort vraagprofielen te creëren voor Nederlandse woningen. Door het herkennen van de verschillen in bezettingspatronen wordt het mogelijk adaptieve systemen te ontwerpen die het comfort kunnen leveren waar en wanneer nodig in verschillende scenario's van bewoning en daarmee kan een aanzienlijke hoeveelheid energie bespaard worden.

Verder werd een methode voor de dynamische analyse van de weersomstandigheden met betrekking op het thermisch comfort voorgesteld, om de kansen en bedreigingen van de weersverandering in kaart te brengen. Dit stelt het systeem in staat om in te spelen op elke redelijkerwijs denkbare situatie om zo een optimaal dynamische filter tussen de thermische omgeving van binnen en buiten te creëren op elk gewenst moment en elke gewenste plaats. Deze analyse werd uitgevoerd door een eenvoudige beschutting te veronderstellen die afscherming van wind- en zonnestraling kan bieden zonder enige vorm van warmte-opslag of isolatie.

In deze studie wordt benadrukt dat er geen noodzaak voor actieve koeling van de woningen in Nederland is mits de woning goed ontworpen is; het blokkeren van zoninstraling wanneer nodig en het verwijderen van overtollig opgebouwde warmte.

Een inventarisatie is gemaakt van de adaptieve mogelijkheden voor een thermisch comfort systeem die worden gebruikt in de huidige praktijk en welke verbeteringen kunnen worden gemaakt alsmede het aangeven van nieuwe technieken die kunnen worden ontwikkeld om de adaptieve mogelijkheden te vergroten van het Adaptieve Thermisch Comfort System.

- 2 In stap 2 werd het effect van de toepassing van de gedetailleerde informatie en adaptieve mogelijkheden besproken in stap 1 op de energiebesparing en de levering van thermisch comfort door Thermisch Comfort Systemen onderzocht.

Allereerst werden de meest geschikte berekeningsmethoden voor het onderzoek bepaald met vergelijking van verschillende niveaus van detail en berekeningsmethode. Controle algoritmen voor de verschillende strategieën werden onderzocht. Het proefschrift maakt gebruik van zowel een lumped capacitance model (3R1C) op basis van de EN-ISO 13790 om te profiteren van de generieke eigenschappen om het ontwikkelen van nieuwe concepten voor adaptiviteit van Thermisch Comfort Systemen te stimuleren, als het TRNSYS-model om de conclusies te verifiëren van het lumped capacitance model en praktische implementatie op korte termijn te beoordelen.

Door middel van het berekenen van verschillende adaptieve controle strategieën voor het verlagen van de warmte- en koelvraag in woningen door het gebruik van variabele thermische isolatie, ventilatie en zonwering werden de voor- en nadelen van deze adaptieve controle strategieën onderzocht. Deze berekeningen lieten zien dat deze

strategieën een significant potentieel voor het verminderen van het energieverbruik van een woning hebben, terwijl het thermisch comfort in de woning gewaarborgd wordt. Het optimale gedrag van deze adaptieve gebouwkenmerken wordt beschreven in deel drie van dit proefschrift. Het energiebesparingspotentieel van de adaptieve benadering ten opzichte van de referentie-woning van AgentschapNL is zeer hoog met in acht neming van de volgende voorwaarden;

Het totale energiebesparingspotentieel voor verwarming van de adaptieve aanpak is ongeveer 61% van de verwarmingsvraag voor de woonkamer en 99% voor de slaapkamer in vergelijking met de referentie situatie (adaptieve thermisch comfort levering, geminimaliseerde vraaggestuurde ventilatie en hoge isolatiewaarden). Deze energiebesparing wordt bereikt door adaptieve en snelle verwarming (met een maximum van ca. 3 graden opwarming ten opzichte van de vorige tijdstap) en adaptieve verhoging van warmtewinst door zoninstraling; het laatste in het geval het in de toekomst mogelijk zou zijn alle zonnestraling die op de gevel valt als warmte te oogsten ten behoeve van het verwarmen van de ruimte.

Door het toepassen van de beschreven adaptieve strategieën in het Adaptieve Thermisch Comfort Systeem kan de koelvraag in de meeste gevallen worden geëlimineerd en zal ten hoogste 10% zijn ten opzichte van de referentie. De eventueel resterende koelvraag zal laag genoeg zijn om de noodzaak voor het installeren van actieve koeling te annuleren. Het toepassen van zowel een adaptieve warmteverliesfactor en zontoetredingsfactor is het meest effectief tegen oververhitting; echter het toepassen van een adaptieve zontoetredingsfactor is van de afzonderlijke maatregelen het meest effectief als verondersteld wordt dat het mogelijk is alle warmte van zonnestraling te blokkeren.

In de referenties is de koellast beduidend lager indien een hogere thermische massa aanwezig is; de warmtelast varieert niet significant met thermische massa. Dit is vanwege de goede basisisolatie van de woning en voldoende warmtewinst door zoninstraling die de temperatuurdaling tijdens de niet-verwarmde perioden (setback-temperatuur) vertraagt ongeacht de thermische massa. De energiebesparing van de adaptieve strategieën voor de koeling is groter bij hogere thermische massa door een drastische vermindering van de reeds veel lagere koelvraag van de referenties met een hogere thermische massa. Bij oriëntatie van de gevel op het Noorden kan overwogen worden om te bouwen met lagere thermische massa omdat er aanzienlijk minder zonnestraling mogelijk is om de warmtevraag te verlagen waardoor de hogere thermische massa variant een lichte stijging vertoont van de warmtevraag ten opzichte van de lagere thermische massa variant. Het toepassen van de adaptieve zoninstraling heeft ook minder effect op de energievraag door de geringere variatie.

Zoals de definitie luidt is de besturing van het thermisch comfort systeem aangepast aan de bezetting en de variërende vraag naar thermisch comfort een essentieel onderdeel van het Adaptieve Thermisch Comfort System. Dit effect is het duidelijkst

bij adaptieve verwarming; hoge bezettingsgraad betekent minder warmtevraag bij een standaard verwarmingsschema vanwege de hogere interne warmtelast, terwijl de vraag naar verwarming met besturing op aanwezigheid logischerwijs minder verschil toont tussen de bezettingsprofielen en een hogere verwarmingseis met een hogere bezettingsgraad. Dit betekent dat de verbetering van de energie-efficiëntie groter is naarmate de bezetting laag is. Verder is het controlealgoritme van hoofdstuk 4 aanmerkelijk minder nauwkeurig bij het profiel met de hoogste capaciteit omdat de temperatuur tot onder de comfort temperatuur daalt tegen de tijd dat de bewoners opnieuw de kamer betreden wat leidt tot hogere verwarmingsbehoefte dan bij de referentie (adaptieve verwarming en geminimaliseerd warmteverlies) wat kan worden voorkomen door het toepassen van voorspelling in de controle van de setpoint temperatuur. Dit effect neemt af bij hogere thermische massa vanwege de langzamere afname van de temperatuur gedurende de nacht. Daarnaast heeft de bezetting met name een groot effect op de effectiviteit van niet-geautomatiseerde systemen in het geval van voorkomen van oververhitting wat betekent dat het effect van automatisering groter is met een lagere bezettingsgraad. Dit benadrukt de noodzaak voor automatische maatregelen tegen oververhitting bij grotere periodes van afwezigheid tijdens de dag door met name zonwering.

- 3 In stap 3 werden ontwerpaanbevelingen voor productontwikkeling aangegeven gebaseerd op de voorgaande hoofdstukken en geïllustreerd naar aanleiding van het ontwerp van een referentiewoning met het Adaptieve Thermische Comfort Systeem; alsmede beoordelingen van mogelijke praktische implementaties in de nabije toekomst. De richtlijnen en de conclusies zijn ingedeeld in 6 categorieën;

### Bewoner (§ 2.3)



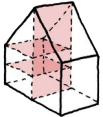
De gebruikersprofielen werden gebruikt om de dynamische vraag te bepalen waarop het gedrag en energiebesparing potentieel van het Adaptieve Thermische Comfort Systeem berekend in dit proefschrift zijn gebaseerd. In plaats van een enkele comforttemperatuur werd een bandbreedte bepaald welke gemakkelijk te bereiken moet zijn op een energie-efficiënte wijze.

Er kunnen zich grote verschillen voordoen in de vraag naar thermisch comfort tussen de bewoners en de ruimtes, waardoor de toepassing van de controle van het systeem op basis van de aanwezigheid een goede manier vormt om energie te besparen. Relatief eenvoudige maatregelen als aanwezigheidsdetectie verbonden met de besturing van de verwarming kan een besparing tot ongeveer 25% van de warmtevraag opleveren afhankelijk van de bezetting.



### Weer (§ 2.4)

Dit proefschrift bevestigt dat in Nederland vrijwel geen oververhitting direct veroorzaakt door het weer voorkomt. De huidige oververhitting die optreedt in woningen komt door het vasthouden van warmte uit zonnestraling en interne warmtelast, door geminimaliseerd warmteverlies, in combinatie met onvoldoende zonwering en mogelijkheden de warmte kwijt te raken indien nodig.

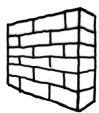


### Ruimtelijk ontwerp (§ 3.3 en hoofdstuk 5)

In dit proefschrift worden een aantal randvoorwaarden voorgesteld aan het ruimtelijk ontwerp die de werking van de Adaptieve Thermisch Comfort System zullen faciliteren of vergroten.

Om de effectiviteit van de adaptieve ventilatie te garanderen mag de luchtstroom door het gebouw niet gehinderd worden door obstakels. In het geval van een warmtevraag kan deze luchtstroom tijdelijk worden uitgeschakeld door (automatisch) sluitende deuren en ventilatieopeningen. De luchtstroom kan worden vergroot door het ontwerpen van de woning met een verhoogde dwarsventilatie, verhoogde thermiek of een "venturi" schoorsteen.

Om optimaal te profiteren van de adaptieve zontoetredingsfactor zullen de kamers met de hoogste vraag naar verwarming en/of een zeer variabele comfortvraag moeten worden georiënteerd in de richting waar de meeste zonnestraling vandaan komt; indien mogelijk rekening houdend met het tijdstip van de hoogste verwarmingsvraag en hoogste zoninstraling.



### Materialisatie (§ 3.4 en hoofdstuk 5 en 6)

Voor het besparen van energie in het stookseizoen is het zeer effectief om hoge isolatiewaarden toe te passen en de ventilatie te minimaliseren samen met de mogelijkheid om zoninstraling in de kamer te maximaliseren indien nodig. Dit kan oplopen tot ongeveer 80% warmtevraag ten opzichte van de referentiesituatie met een constante ventilatie en de gemiddelde isolatiewaarde indien het in de toekomst mogelijk zou zijn alle zonnestraling die op de gevel valt als warmte te oogsten ten behoeve van het verwarmen van de ruimte.

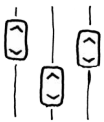
Deze maatregelen moeten worden gecombineerd met adaptieve zoninstraling en een adaptieve warmteverlies factor (gemakkelijker gerealiseerd door extra adaptieve ventilatie dan adaptieve thermische isolatie) om oververhitting buiten het stookseizoen te voorkomen. Als het mogelijk is om alle zoninstraling te blokkeren kan vrijwel alle koelvraag worden geëlimineerd en zal een actieve koelinstallatie niet nodig zijn.

Het Adaptieve Thermische Comfort Systeem verhoogt de stabiliteit van de operationele temperatuur door het optimaliseren van de adaptieve gebouweigenschappen voor de kamertemperatuur om het dichtst bij de comforttemperatuur te blijven zonder energie te gebruiken. Daarom wordt er geen extra voordeel gevonden voor adaptieve thermische massa voor een Adaptieve Thermische Comfort Systeem. Hoge thermische massa verdient de voorkeur voor een woning met een adaptief thermisch comfortstelsel als geldt voor alle (voldoende geïsoleerde) woningen.



### HVAC (§ 3.5 en hoofdstuk 5 en 6)

Om energie te besparen (ongeveer 25%) in het stookseizoen is het zeer effectief om adaptieve verwarming toe te passen; het toepassen van warmteterugwinning (in het TRNSYS-model) heeft een belangrijke toegevoegde effect op energiebesparing (ongeveer 20% bij een rendement van 60% voor de wtw). Dit moet uiteraard afgezet worden tegen het extra energieverbruik van de ventilatoren. Omdat de temperaturen met adaptieve verwarming meer fluctueren dan met constante verwarming en koeling moet het systeem snel kunnen opwarmen en snel afkoelen, tot ca. 6° C in een uur. Extra energiebesparing zou kunnen worden behaald door het verbeteren van HVAC-systemen voor een Adaptieve Thermische Comfort Systeem door het toepassen van technieken die, naast energie-efficiënt, snel en lokaal kunnen reageren. Met behulp van hoge isolatie in de winter, een hoge thermische massa en adaptieve technieken, zoals voorgesteld in dit proefschrift wordt de binnentemperatuur gestabiliseerd en de vereiste verwarmingssnelheid tot ongeveer 4° C per uur verlaagd voor hogere thermische massa en 0.5 °C per uur voor hoge thermische massa wat het toepassingsgebied van verwarmingssystemen vergroot.



### Controls (§ 3.6)

Het is zeer belangrijk om een hoge mate van automatisering toe te passen in het Adaptief Thermisch Comfortstelsel omdat een hoge isolatie, geen zonwering en minimale ventilatie bij afwezigheid van de bewoners kan leiden tot ernstige oververhitting. Het energiebesparingspotentieel van de adaptieve ventilatie vermindert aanzienlijk bij afwezigheid van automatisering, vooral voor de profielen met de minste bezetting en lagere thermische massa. Het verlies in effectiviteit van de adaptieve zoninstraling wordt dramatisch verminderd zonder automatisering met gemiddeld 75% minder energiebesparing. Het energiebesparingspotentieel voor de gecombineerde maatregelen zonder automatisering daalt met 30% gemiddeld en de ventilatie benodigd voor het verwijderen van de warmte is hoger. Dit maakt de automatisering van cruciaal belang voor het Adaptieve Thermische Comfort Systeem en vooral voor de zoninstraling.

Verder kan voorspelling van de setpoint temperatuur in de nabije toekomst (bijvoorbeeld met Adaptive Model Predictive Control (zelflerende regeling) (§ 3.6.4) systeem) de efficiëntie van het systeem in belangrijke mate vergroten door te voorkomen dat de warmtelast stijgt door de snelle temperatuurdaling na een periode van passieve koeling, met name met lage thermische massa.

### **Energiebesparing potentieel en bandbreedtes van de adaptieve instellingen (hoofdstuk 5 en 6)**

De behoefte aan koeling kan effectief worden verminderd met behulp van de voorgestelde adaptieve maatregelen en zo wordt het energiebesparingspotentieel bijna 100% voor de koeling. Voor de energiebesparing voor verwarming is ongeveer 25% door het toepassen van adaptieve verwarming ten opzichte van de referentie, afhankelijk van de bezetting en de daaruit voortvloeiende warmtevraag. Als het warmteverlies wordt geminimaliseerd tijdens het stookseizoen kan 66% van de energie voor verwarming worden bespaard in de woonkamer en 90% in de slaapkamers in het 3R1C model. TRNSYS berekent een energiebesparing van ongeveer 45% voor adaptieve verwarming in de totale referentiewoning. Een extra 20% kan worden bespaard op energie voor verwarming met warmteterugwinning in de berekeningen met TRNSYS. In het lumped capacitance model is aangetoond dat een aanvullende energiebesparing van 20% kan worden verkregen in vergelijking met de berekeningen van TRNSYS door verhoogde zoninstraling (indien het in de toekomst mogelijk zou zijn alle zoninstraling die op de gevel valt als warmte te oogsten ten behoeve van het verwarmen van de ruimte) resulterend in een totale energiebesparing voor verwarming van ca. 80% gemiddeld.





# Nomenclature

SYMBOLS		
a	-	constant (used in standard equation of ACA)
A	[m <sup>2</sup> ]	area
A <sub>c</sub>	[m <sup>2</sup> ]	collector area
ACPH	[1/h]	air changes per hour
A <sub>f</sub>	[m <sup>2</sup> ]	area of façade
A <sub>m</sub>	[m <sup>2</sup> ]	effective mass area
b	-	constant (used in standard equation of ACA)
C <sub>air</sub>	[J/K]	heat capacity of the internal airnode
C <sub>c</sub>	[J/K]	heat capacity of the construction
C <sub>CO<sub>2</sub></sub>	[ppm]	CO <sub>2</sub> concentration in the (indoor) air
C <sub>m</sub>	[J/K]	internal heat capacity
COP	-	coefficient of performance of a heat pump ( $q_{\text{heat,out}}/q_{\text{prim,in}}$ )
E <sub>res</sub>	[W]	heat loss by evaporation of moisture of respiration air
E <sub>sw</sub>	[W]	evaporative heat loss from skin
F <sub>c</sub>	-	shading factor, 0 for no shading; 1 for total block of solar radiation
f <sub>ex</sub>	-	exergy factor (exergy to energy ratio)
f <sub>glass</sub>	[%]	glass percentage
f <sub>sol</sub>	-	solar factor of façade ( $q_{\text{rad,gain}} / q_{\text{rad,inc}}$ )
G	-	solar gain factor of glass
H <sub>tot</sub>	[W/K]	total heat transfer coefficient
H <sub>tr,em</sub>	[W/K]	heat transfer coefficient for emission
H <sub>tr,is</sub>	[W/K]	coupling conductance between indoor air and surrounding surfaces
H <sub>tr,ms</sub>	[W/K]	coupling conductance between the active thermal mass and the surfaces
H <sub>tr,op</sub>	[W/K]	heat transfer coefficient due to opaque façade elements
H <sub>tr,w</sub>	[W/K]	heat transfer coefficient due to transparent façade elements
H <sub>tr</sub>	[W/K]	heat transfer coefficient for transmission through separation construction
H <sub>ve</sub>	[W/K]	heat transfer coefficient due to ventilation
M	[W]	metabolic heat production
PET	[°C]	Physiological Equivalent Temperature
p <sub>air</sub>	[Pa]	air pressure
p <sub>ext</sub>	[Pa]	external pressure on façade
Δp	[Pa]	pressure difference
Q <sub>hc,nd</sub>	[kWh]	energy consumption for heating and cooling
q <sub>met</sub>	[MET]	metabolic rate (Fanger, 1970)
q <sub>rad</sub>	[W/m <sup>2</sup> ]	solar radiation

>>>

## SYMBOLS

$Q_{rad}$	[kWh]	radiation budget
$q_{rad, gain}$	[W]	solar gain of the room
$q_{rad, inc}$	[W]	solar radiation on façade
$q_{sol}$	[W/m <sup>2</sup> ]	solar gain (outdoor environment)
$q_{sup}$	[W]	supply of thermal energy possible to be delivered by the chosen system
$q_v$	[m <sup>3</sup> /h]	ventilation capacity ([l/s] if explicitly mentioned)
RH	[%]	relative humidity
$R_{sol}$	[W]	radiative heat gain from sun
$R_{surf}$	[W]	radiative heat gain and loss surfaces
$S_{C_{ond}}$	[W]	sensible heat gain and loss by conduction
$S_{conv}$	[W]	sensible heat gain and loss by convection
$S_{res}$	[W]	sensible heat loss by respiration
t	[s]	time-step
$T_0$	[°C]	reference temperature for exergy
$T_a$	[°C]	ambient temperature
$T_c$	[°C]	comfort temperature
$T_{e, ref}$	[°C]	reference temperature for calculation of the comfort temperature (ACA)
$T_{glass}$	[°C]	temperature of glass
$T_i$	[°C]	indoor air temperature
$T_{lower}$	[°C]	lower temperature limit (ACA)
$T_n$	[°C]	statistical neutral temperature, considered as comfort temperature (ACA)
$T_{op}$	[°C]	indoor operative temperature
$T_{set}$	[°C]	setpoint temperature
$T_{upper}$	[°C]	upper temperature limit (ACA)
$\Delta T$	[°C]	change in temperature ([K if explicitly mentioned])
$v_{wind}$	[m/s]	wind speed
w	[°C]	width of the comfort band (ACA)
$\alpha$	-	statistical constant (ACA)
$\alpha_{azi}$	[degree]	solar azimuth angle
$\alpha_{inc}$	[degree]	angle of incidence of solar radiation
$\alpha_{sol}$	[degree]	solar angle with horizontal plane
$\alpha_{zen}$	[degree]	solar zenith angle
$\eta$	[%]	system efficiency
$\theta_{air}$	[°C]	indoor air temperature
$\theta_{air, 0}$	[°C]	indoor air temperature at previous time-step
$\theta_{air, t}$	[°C]	indoor air temperature at time-step
$\theta_{air, \infty}$	[°C]	indoor air equilibrium temperature with current circumstances
$\theta_e$	[°C]	outdoor air temperature
$\theta_m$	[°C]	temperature of the active thermal mass
$\theta_s$	[°C]	temperature of the surfaces surrounding the room

>>>

## SYMBOLS

$\theta_{sup}$	[°C]	supply temperature of the ventilation air
$\phi_{hc,nd}$	[W]	energy need for heating and cooling
$\phi_{int}$	[W]	internal heat gain by appliances and people
$\phi_{sol}$	[W]	solar heat gain

## ABBREVIATIONS

ATCS	Adaptive Thermal Comfort System
ACA	Adaptive Comfort Algorithm
CHP	Combined Heat and Power
FEM	Finite Elements Method
HTC	High Temperature Cooling
HTH	High Temperature Heating
LCM	Lumped Capacitance Model
LTC	Low Temperature Cooling
LTH	Low Temperature Heating
PET	Physiological Equivalent Temperature
PVT	Photo Voltaic and Thermal
PVT	Photo Voltaic
1_st	1 person household, student
1_soc	1 person household, with many visiting people at home
2_w	2 person household, both with job outside the house
2_h	2 person household, at least one partner working at home
4_sc	4 person household, both partners job outside the house two school-going children
4_sm	4 person household, two children under the age of 5
1_ref	reference
1a_ref	adaptive heating
1b_ref	minimised ventilation
1c_ref	minimised ventilation without cooling
2b_ventdyn	adaptive ventilation
2c_ventdyn	adaptive ventilation without cooling
2e_ventdyn	presence controlled ventilation
2f_ventdyn	presence controlled ventilation without cooling
3b_soldyn	adaptive shading
3c_soldyn	adaptive shading without cooling
3e_soldyn	presence controlled shading
3f_soldyn	presence controlled shading without cooling
4b_dyn	adaptive ventilation and solar gain
4c_dyn	adaptive ventilation and solar gain without cooling
4e_dyn	presence controlled ventilation and solar gain
4f_dyn	presence controlled ventilation and solar gain without cooling

## DEFINITIONS

adaptation	(Oxford, 2012) biology	The process of change by which an organism or species becomes better suited to its environment
adaptive control	(Oxford, 2012)	Control of a system, behaviour, etc., in which adjustments are (automatically) made in response to external conditions or stimuli; frequently attributive
Adaptive Thermal Comfort System (ATCS)	(this thesis)	The whole of passive and active comfort components of the dwelling that dynamically adapts its settings to varying user comfort demands and weather conditions (seasonal, diurnal and hourly depending on the aspects adapted), thus providing comfort only where, when and at the level needed by the user, to improve possibilities of harvesting the environmental energy (e.g. solar gain and outdoor air) when available and storing it when abundant.
bioclimatic design	(Yeang, 1999)	The passive low-energy design approach that makes use of the ambient energies of the climate of the locality (including the latitude and the ecosystem, through siting, orientation, layout and construction) to create conditions of comfort for the users of the building
comfort	(Oxford, 2012)	A state of physical and material well-being, with freedom from pain and trouble, and satisfaction of bodily needs; the condition of being comfortable.
ease of use	(Davis, 1989)	The degree to which a person believes that using a particular system would be free of effort
passive solar design	(Harris, 2006)	Building subsystem in which solar energy is collected and transferred predominantly by natural means; uses natural convection, conduction, or radiation to distribute thermal energy through a structure, within the limits of the indoor design temperature conditions
perceived usefulness	(Davis, 1989)	The degree to which a person believes that using a particular system would enhance his or her daily life
PET	Höppe (1999)	Physiological equivalent temperature at any given place (outdoors or indoors) and is equivalent to the air temperature at which, in a typical indoor setting, the heat balance of the human body is maintained with core and skin temperatures equal to those under the conditions being assessed.
thermal comfort	(De Dear et al., 1997)	That condition of mind which expresses satisfaction with the thermal environment; it requires subjective evaluation. Optimum thermal comfort is assumed to correspond with a thermal preference vote of "want no change".
thermal environment	(De Dear et al., 1997)	The characteristics of the environment which affect a person's heat loss.
thermal neutrality	(De Dear et al., 1997)	The indoor thermal index value (usually operative temperature) corresponding with a maximum number of building occupants voting "neutral" on the thermal sensation scale (Table 2.5, page 40)
vernacular architecture	(Harris, 2006)	Architecture that makes use of common regional forms and materials at a particular place and time

# 1 Introduction

---

## § 1.1 Thermal comfort and energy use

---

According to article 25 of the Universal Declaration of Human Rights of the United Nations, one of the basic human rights is adequate housing for health, well-being and safety. Adequate housing includes the creation of a suitable thermal environment to promote health, well-being and safety. In most countries, to provide the right thermal environment energy should be applied for heating or cooling during various periods of the year. The more the outdoor climate differs from the desirable indoor thermal environment, the more energy the comfort system uses to restore comfort. In total about 8.6% of all energy use in the Netherlands is for heating dwellings which accounts for almost 40 PJ a year and the average newly built home in 2006 uses 25% of the gas for heating of the average home of the entire building stock (CBS, 2014). This shows that much can be gained for newly build homes but especially from retrofitting the existing building stock. There are no numbers on the energy use for cooling in dwellings; however, while the newly built homes with very high insulation tend to overheat in summer, which causes people to install cooling. This makes it crucial to research both heating and cooling season to prevent the energy saving for heating to be frustrated by an increase in consumption of cooling energy.

The Brundtland report "Our common future" (Brundtland et al., 1987) stresses the importance of making sure that this comfort delivery is possible and still will be possible in the future; Therefore, the energy use should be limited as much as possible for the following reasons;

- The non-renewable energy sources on which most energy supply is depending is becoming depleted and the cost and the impact on the environment increases while it gets harder to harvest the energy resources that lay deeper and more distributed in the ground (IEA,2012).
- By the emission of CO<sub>2</sub> (among other things) the use energy from non-renewable energy sources is partly responsible for Global Climate Change, which causes the climates over the world to become more extreme, which can ultimately lead to more need for energy use to compensate for the growing difference between the outdoor climate and the desirable indoor thermal environment (IPCC, 2014).

- The use of renewable resources reduces the use of these non-renewable energy sources. However, although the development of producing renewable energy sources these resources are limited and variable in supply and hard to store which makes it necessary to apply them wisely (IEA,2012).
- As civilisation is advancing, the demand for thermal comfort is increasing, as is the case for any kind of comfort. In the Netherlands this increasing demand on comfort systems for dwellings becomes clear from recent and on-going developments, which ask for certain new concepts in the residential sector. Most of all there is a need of concepts that facilitate adaptability to user specific demand (BouwhulpGroep, 2007).

### § 1.1.1 The new stepped strategy

---

Andy van den Dobbelsteen introduced The New Stepped Strategy (Van Den Dobbelsteen, 2008), a further development of the Trias Energetica order (Lysen, 1996). The New Stepped Strategy adds an important intermediate step in between the reduction in consumption and the development of sustainable sources, and incorporates a waste products strategy. Furthermore, the last step is stimulated to be made redundant.

- 1 Reduce the demand (using smart and bioclimatic design)
- 2 Reuse waste flows
- 3 Use renewable sources and ensure that waste remaining does not disturb the environment or is used as food
- 4 Supply the remaining demand cleanly and efficiently

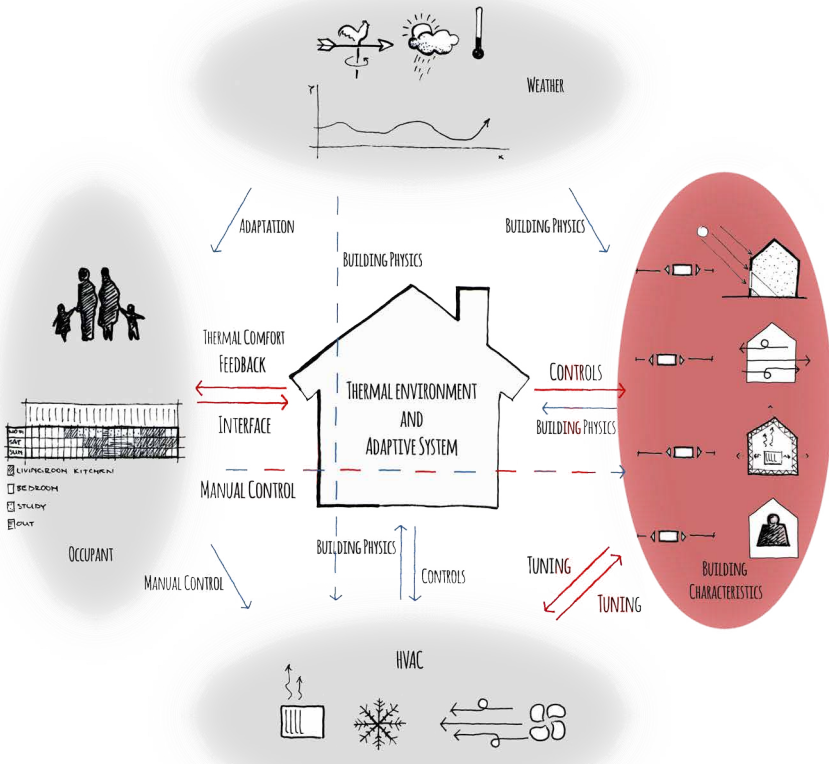
This thesis will mainly focus on step 1 of the New Stepped Strategy, which will make it easier to realise the next steps. To reduce energy demand for comfort, it is important to know when, where and at which level comfort is needed, so no more energy is used than necessary making optimal use of renewable resources.

## § 1.2 Research design

---

In this thesis, an **Adaptive Thermal Comfort System** (originally The Adaptive Dwelling (DEPW, 2006)) is defined as the whole of passive and active comfort components of the dwelling that **dynamically adapts** its settings to **varying user comfort demands** and **weather conditions** (seasonal, diurnal and hourly depending on the aspects

adapted), thus providing comfort **only where, when and at the level needed** by the user, to improve **possibilities of harvesting the environmental energy** (e.g. solar gain and outdoor air) when available and storing it when abundant ( [Figure 1.1](#)).



**FIGURE 1.1** The Adaptive Thermal Comfort System for dwellings with the adaptive building characteristics on the right

Figure 1.1 shows the various factors that determine the thermal environment in the Adaptive Thermal Comfort System and consequently the energy use for thermal comfort of the occupants which will be researched in [PART 2](#) of this thesis. The middle of the scheme is the thermal environment together with the control centre of the Adaptive Thermal Comfort System; from which the Adaptive Thermal Comfort System is driven. Around it are the four categories that influence the thermal environment and are influenced by the adaptive system or the thermal environment (except for the weather which is an autonomous process). The new part is to make the building characteristics of **solar gain, (natural) ventilation and insulation** adaptive to minimise



the demand for (thermal) energy. This is done by controls driven by the adaptive system. This requires information of the occupant and that can be obtained by an advanced interface with feedback to the user and the possibility to overrule the systems decision. Furthermore, the HVAC system and the settings of the building characteristics are mutually tuned to optimally profit from all energy saving measures.

### § 1.2.1 Background hypotheses

---

Based on the previous section, the following hypotheses can be produced on which the research of this thesis is based:

- Providing comfort only when and where and at the level needed will lead to significant energy saving compared to the current approach of delivering a predefined level of comfort based on averages of weather and occupant.
- Providing this comfort with an Adaptive Thermal Comfort System can significantly improve the energy efficiency of the dwelling.
- This Adaptive Thermal Comfort System does not compromise the comfort experience of the occupant.

### § 1.2.2 Problem definition

---

In order to be able to create an Adaptive Thermal Comfort System to improve energy efficiency knowledge should be acquired as to where, when, what kind and how much energy is needed to provide the thermal comfort. Therefore research should be done to gain more insight in the dynamic behaviour of the weather and the occupant to be combined with opportunities to adapt the thermal comfort system accordingly to save energy.

### § 1.2.3 Research objective

---

The aim of the research presented in this thesis is to design **adaptive concepts** of an Adaptive Thermal Comfort System for Dwellings to achieve a significantly better energy performance whilst not compromising the thermal comfort perception of the occupants. The adaptive concepts are meant to activate the future development of adaptive techniques beyond the nowadays available as well as stimulate improved application of existing techniques.

To do so, three steps will be taken, which also represent the three parts of the research:

- 1 **Gathering information about the dynamics** of the factors that influence the thermal heat balance of the dwelling and determine their opportunities for adaptivity. This requires a multi-disciplinary approach to Thermal Comfort Systems.
- 2 Researching the effect of applying the adaptive opportunities on the energy saving and comfort delivery of the Thermal Comfort Systems to determine the **optimal generic and individual physical characteristics** of an Adaptive Thermal Comfort System for dwellings.
- 3 Providing **design guidelines** for product development and the design of a dwelling with an Adaptive Thermal Comfort System and assessing some practical implementations.

## § 1.2.4 Methodology

---

The methodology of this thesis is based on the categorisation of the aspects influencing the level of thermal comfort demand and supply divided into the 6 domains used in this thesis, shown in [Table 1.1](#). These 6 domains can be grouped into the external variables (the variables that are the driving force for supply and demand of energy) and the actual components of the Adaptive Thermal Comfort System.

**The external variables** are the occupant which poses the demand on the Adaptive Thermal Comfort System and the weather which delivers the (energy) supply for the thermal environment

The next domains form the **actual Adaptive Thermal Comfort System** and this can be subdivided into a passive part which only need auxiliary energy to influence the thermal environment and an active part which uses energy to regulate the thermal environment. The **passive system** consists of the **spatial layout** or the organisation and shape of the rooms in the design and the **materialisation part** which sets the filter characteristics e.g. the permeability of the shell for heat air and solar radiation. The **active parts** of the system are the **HVAC system** which actively applies energy to tune the thermal environment like heating and cooling and it can discard energy by mechanical ventilation and **the control system** to tune the whole system in accordance with the demand and supply.



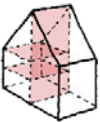
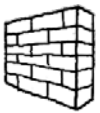

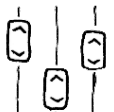
	domain	type	design phase	chapter	research type
occupancy		external variable	brief	2	literature
weather		external variable	brief	2	literature
layout		precondition	preliminary design	3	literature
material		passive ATCS	materialization	3 PART 2 PART 3	literature calculations integration
HVAC		active ATCS	mechanical installations	3 PART 2 PART 3	literature calculations integration
controls		control	mechanical installations	3	literature

TABLE 1.1 Domains of research in this thesis with reference to the research chapters

### § 1.3 Research questions

Resulting from the research objective and methodology the main research question is the following;

**MAIN** **What are the most efficient strategies for delivering thermal comfort in the residential sector with respect to better energy performances and an increasing demand for flexibility in use and comfort conditions?**

---

To answer this main question the following sub questions will each be researched and answered in a chapter creating the outline of the thesis (Figure 1.2).

**PART 1** **Frame of References**

---

**CH2** *What information about occupant demand for thermal comfort and weather circumstances is present in common practice to improve adaptivity in use and comfort conditions while increasing energy performance and which information should be added?*

---

This chapter describes a literature review to determine which level of obtaining and processing information about thermal comfort and energy demand (occupant) and supply (weather) is usual and which improvements and new techniques can be implemented to increase possibilities for adaptivity of the Adaptive Thermal Comfort System.

**CH3** *What adaptive techniques for a thermal comfort system (the whole of passive and active components of the building that influence the indoor thermal environment) of a dwelling are now available and which opportunities for improvement and development of new techniques are there?*

---

This chapter describes a literature review to determine which possibilities for adaptivity for a thermal comfort system are usual in practice and which improvements and new techniques can be implemented to increase these possibilities for adaptivity of the Adaptive Thermal Comfort System.

**PART 2** **Calculations**

---

**CH4** *Which calculation method is most suitable to determine boundaries and potentials of advanced adaptive building characteristics such as thermal insulation, ventilation and solar gain for energy performance of thermal comfort systems in dwellings?*

---

In this chapter the most appropriate calculation methods for the research are determined comparing various levels of detail and approaches in calculation. Control algorithms and strategies are researched.

**CH5** *What potential do **adaptive building characteristics as solar gain, ventilation and thermal insulation** have of increasing energy performance for thermal comfort of a dwelling delivering the required thermal comfort level and what is the optimal strategy to control these building characteristics?*

---

In this chapter requirements for the dynamic physical behaviour of the Adaptive Thermal Comfort System for Dwellings (whole of passive and active components) are derived. Through calculating various strategies in heating and prevention of overheating by using variable thermal insulation, ventilation and solar gain the advantages and disadvantages of the control strategies are researched in the context of the information obtained about demand and supply (in the Netherlands) acquired in chapter 2. In this chapter three levels of thermal mass are researched for their influence on the performance and control.

**CH6** *What are possible applications of **currently available techniques** for an Adaptive Thermal Comfort System in a standard reference dwelling and what is their potential in improvement of energy performance?*

---

This chapter shows examples of applications of various concepts of an Adaptive Thermal Comfort System that can be implemented with currently available techniques in the standard reference dwelling of AgentschapNL. This will be simulated in TRNSYS to assess the potentials in improvement of energy performance of the proposed adaptive solutions and their combinations.

### **PART 3** **Synthesis**

---

**CH7** *What are the implications of the adaptive strategies of an Adaptive Thermal Comfort System in the design of a dwelling and what are the most significant improvements that can be made in current building practice?*

---

This chapter describes what characterises an Adaptive Thermal Comfort System for Dwellings and what the implications are for the design and construction of the dwelling based on the conclusions of the previous chapters.

## **§ 1.4** **Research context and boundaries**

---

- The research is conducted in the area of the residential sector of the Netherlands and will research the commonly appearing scenarios for occupancy for their differences in dynamic behaviour. The Dutch climate will be regarded with its past behaviour and expected change in the future by climate change.

- This thesis will research the basic strategies for the Adaptive Thermal Comfort System and its components. Therefore, it does not aim to design the system and its components into detail but will give guidelines for improvement of applications of existing techniques in the Adaptive Thermal Comfort System and further development of components that enhance the Adaptive Thermal Comfort System.
- The scope of this research is to optimise the individual performance of the dwelling and research the intermittent behaviour of the energy demand to better be able to connect with availability of renewable energy and the district energy systems. In the future these can be combined with many interesting studies about district energy (Van Den Dobbelen et al., 2007; Roggema et al., 2011) renewable resources and exergy performance (Stremke et al., 2011; Jansen, 2013).
- The Adaptive Thermal Comfort System attempts to use as much environmental energy as possible (sun, outdoor air temperature) which in itself is the most sustainable renewable energy resource.
- Systems delivering thermal comfort (Thermal Comfort Systems) (can) make use of the same resources as domestic hot water (e.g. hot water for heating) and power (e.g. electricity for fans, pumps and control systems). However, the focus of this thesis is on thermal comfort, i.e. the satisfaction with the thermal environment.
- Energy saving **potentials** will be indicated in percentages of the references for the use of the various components. Actual energy use for the system will and cannot be predicted because there are many uncertainties in the use and performance of an actual thermal comfort system (Yang, 2012).
- Recommendations will be given for the spatial layout of a dwelling with an Adaptive Thermal Comfort System in the form of preconditions to promote the effect of the Adaptive Thermal Comfort Systems. Adaptive opportunities for the spatial layout will be briefly described for further research.

---

## § 1.5 Expected results

---

Firstly, this research focuses on mapping the information about commonly occurring patterns that determine the crucial characteristics of the adaptive system and its components to be able to stimulate application of existing techniques for adaptive thermal comfort and develop new techniques in the future. It develops a method of formulating different realistic thermal comfort demand profiles for Dutch dwellings and their occupants based on a combination of comfort theory and statistical analysis

of time use surveys and demographics. Furthermore, a dynamic analysis of the weather in the Netherlands is made in relation to the comfort demand. With this determination, boundary conditions will be put forward to provide thermal comfort in a new way, dynamic and adaptive to user, weather and the availability of renewable energy resources.

With this dynamic information of the various strategies to deliver thermal comfort for a dwelling in the Netherlands are developed. These strategies will be theoretical of nature to be able to identify opportunities for development of future components and techniques as well as improving the application of readily available techniques. These will be applicable to **new building design** as well as for **existing dwellings**.

---

## § 1.6 Novelty

---

The research in this thesis differs from other researches by providing an integration between the various domains that influence the thermal environment and thermal comfort in the residential sector (of the Netherlands):

- Researching **individual generic physical processes** as opposed to assuming and assessing existing technologies. The disconnection of these individual processes enable identification of opportunities to improve existing techniques but above all **develop new concepts and techniques beyond the existing** in accordance to the strategies for adaptive thermal comfort derived from this thesis.
- Applying a **multidisciplinary approach**; adaptive comfort theory, sociology and user profiles will be combined with the analysis of weather patterns in the context of thermal comfort, building physics, the indoor thermal environment and energy use to identify a broad spectrum of dynamic behaviour in comfort demand.
- Combining individual dynamic optimisation solutions and research their interdependency.

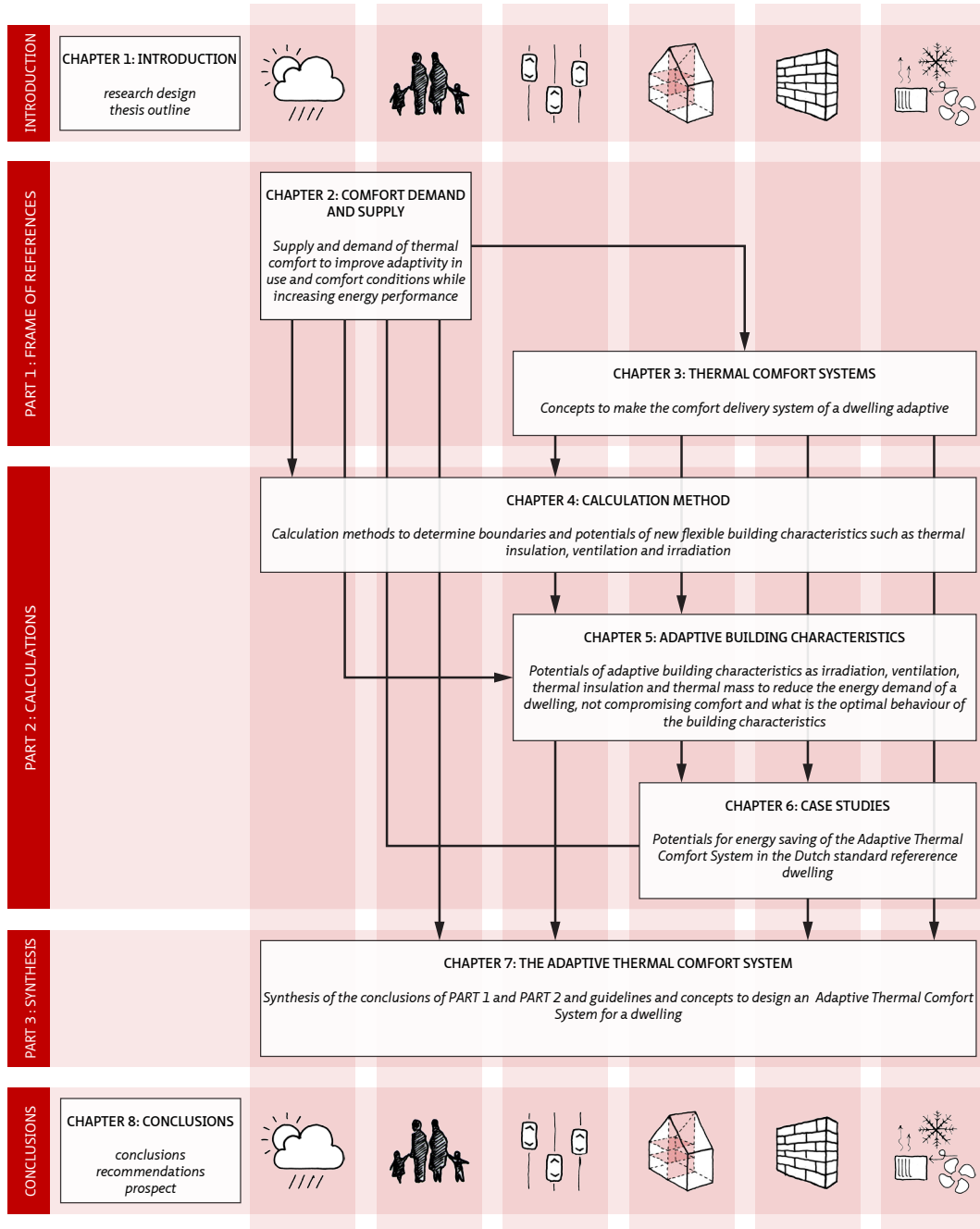


FIGURE 1.2 Thesis outline





# PART 1 Frame of reference



## 2 Conditions for the Adaptive Thermal Comfort System

---

### § 2.1 Introduction

---

To create an Adaptive Thermal Comfort System as defined in the introduction (§ 1.2) information needs to be present about what is exactly the supply and demand for thermal energy and how this information should be processed by the system to provide for this demand in an energy efficient way. This chapter describes a literature review to determine which level of obtaining and processing information is usual and which improvements and new techniques can be implemented to increase insight in the possibilities for adaptivity of the Adaptive Thermal Comfort System.

---

### § 2.2 Research Design

---

#### § 2.2.1 Problem statement

---

To be able to benefit optimally from the Adaptive Thermal Comfort System, current knowledge of the **varying user comfort demands** and **weather conditions** (seasonal, diurnal and hourly depending on the aspects adapted) needs to be mapped in order to know the points of improvement in information collection and processing to provide comfort **only where, when and at the level needed** by the user, to improve possibilities of **harvesting the environmental energy** (e.g. solar gain and outdoor air) when available and storing it when abundant.

## § 2.2.2 Research question

---

**What information about occupant demand for thermal comfort and weather circumstances is present in common practice to improve adaptivity in use and comfort conditions while increasing energy performance and which information should be added?**

## § 2.2.3 Structure

---

A literature study is performed to map the state of the art in thermal comfort delivery studies in the following sections complemented with points of improvement. An elaborate analysis will be performed of the weather as well as the occupant in relation to thermal comfort and energy use as well as what this means for the information supply and control system of the system. Profiles and patterns will be identified to determine the occurring comfort demand in detail to form a knowledge base for the calculations in PART 2 to determine optimal properties for the Adaptive Thermal Comfort System.

### Thermal comfort assessment and occupancy profiles (§ 2.3)

---



A brief history is given of the theory of thermal comfort assessment. The different approaches are explained and the choice to work with the Adaptive Thermal Comfort Theory is explained. The algorithms used in this thesis to predict the range in setpoint temperatures in the residential sector of the Netherlands, which are used in PART 2 and PART 3 are given with the improvements to be made to increase the adaptivity of the Adaptive Thermal Comfort System. Furthermore, an elaborate analysis is made to compile occupancy profiles to determine the thermal comfort demand.

### Weather and thermal comfort (§ 2.4)

---



The outdoor thermal environment, the weather, is the most important factor on the indoor thermal environment and thermal energy balance of the indoor environment. In this section the current approach to map the weather and climate data to design and assess buildings is briefly described as well as the Dutch situation and future changes, which will be the scope of the thesis. In the end an improved analysis is performed of the weather in relation to thermal comfort and the heat balance of the dwelling.

## § 2.3 Thermal comfort assessment and occupancy profiles



### Definitions of thermal comfort

**Comfort (Oxford, 2012):** a state of physical and material well-being, with freedom from pain and trouble, and satisfaction of bodily needs; the condition of being comfortable.

**Thermal environment (De Dear et al., 1997):** the characteristics of the environment which affect a person's heat loss.

**Thermal comfort (De Dear et al., 1997):** that condition of mind which expresses satisfaction with the thermal environment; it requires subjective evaluation. Optimum thermal comfort is assumed to correspond with a thermal preference vote of "want no change".

**Thermal neutrality (De Dear et al., 1997):** the indoor thermal index value (usually operative temperature) corresponding with a maximum number of building occupants voting "neutral" on the thermal sensation scale (Table 2.1).

### § 2.3.1 Two most important thermal comfort theories and their limitations

The thermal environment is defined by a number of physical parameters that determine heat content and heat exchange with objects or other environments. The most important parameters are air (ambient) temperature, radiative temperature, relative humidity and air velocity. According to Nicol (2012), there are three reasons for the importance of thermal comfort:

- To provide a satisfactory condition for people for health, comfort and delight
- To control energy consumption
- To suggest and set standards for quality assessment of buildings

Many studies have been performed to define the thermal circumstances under which (most) people feel comfortable. As early as 1936 by Bedford about the thermal comfort at the workplace, especially in factories (Bedford, 1936) and later on Victor Olgyay studied the thermal comfort of the outdoor environment related to the combination of ambient temperature, relative humidity, air velocity and solar radiation giving design guidelines in an the extensive book "Design with Climate" (Olgyay & Olgyay, 1963). Givony wrote a similar work called "Man, climate and architecture" (Givony, 1981).

### § 2.3.1.1 1. PMV/PPD

The first widely adopted method to predict the thermal comfort sensation is the PMV (predicted mean vote) method of professor Ole Fanger (1970). Fanger assumed that optimal conditions for thermal comfort could be expressed by the regression line of skin temperature and sweat rate by unit of metabolic rate, in data from experiments he conducted amongst 1300 students in a climate chamber. In this way an expression for optimal thermal comfort could be deduced from the metabolic rate, thermal insulation of clothing and environmental conditions. The model calculates the PMV on the ASHRAE scale for thermal sensation (Table 2.1; (ASHRAE, 2004)) for a group of people in a given environment. Correspondingly, the PPD (predicted percentage dissatisfied) can be derived from that (Figure 2.2). The equation is based on the thermal heat balance model of the human body (Figure 2.1).

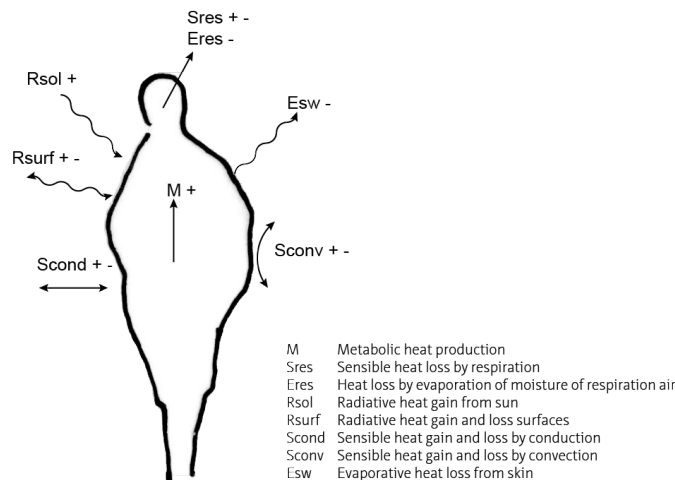


FIGURE 2.1 Energy balance of the human body and its environment

ASHRAE DESCRIPTIVE SCALE	NUMERICAL SCALE
Hot	+3
Warm	+2
Slightly warm	+1
Neutral	0
Slightly cool	-1
Cool	-2
Cold	-3

TABLE 2.1 ASHREA thermal sensation scale (ASHRAE, 2004)

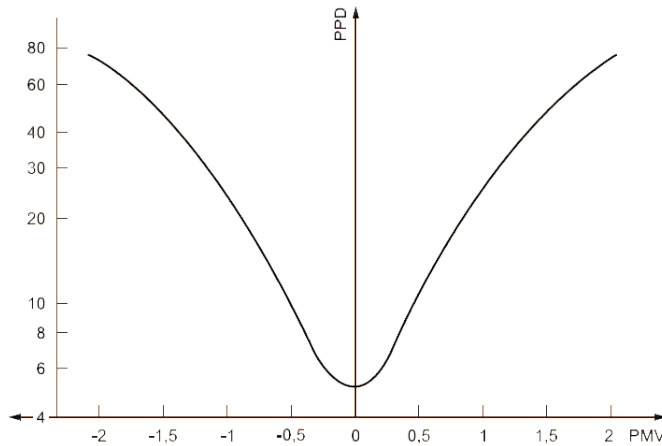


FIGURE 2.2 Relation between PMV and PPD (EN-ISO, 2005)

### Limitations and issues of the PMV model

#### Climate chambers

The main problem with this model, adopted by American ASHRAE 55 (2004) standard and European EN-ISO 7730 (2005) standard and thus very influential, is that the defining experiments were held in a climate chamber. This means a steady state and uniform environment, which seldom occurs in real life. Furthermore, it requires the knowledge of metabolic rate and type of clothing. This is often hard to predict as both variables are individually dependent. The value of clothing insulation used can be read from tables in which clothing insulation is listed against descriptions of items or ensembles of clothing. The values of clothing insulation were determined in experiments using heated manikins. The metabolic rate was similarly obtained from tables of activities for which the appropriate metabolic rate is given. This is based on averaging measurements of people performing these activities.

#### Global standardisation

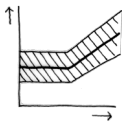
Globally standardizing thermal comfort led to what Shove calls social, architectural and environmental convergence (Shove, 2004), i.e. standards and expectations becoming increasingly similar across the world. Imposing this “ideal” situation to places all over the world, regardless of people’s diversity, caused a growing need for artificially created comfort in the built environment, instead of meeting pre-existent needs. So, creating the same thermal environment in every climate leads to excessive energy use.



Comfort however is culturally relative, framed by issues of social convention, symbolism and status and comfort. Fine & Leopold (1993) found that perception of comfort and that of the systems through which particular services are produced, delivered, distributed and used mutually influence each other and cannot be explained in terms of consumer demand alone.

### § 2.3.1.2 2. Adaptive Temperature Model

---



Various studies point out that, beside the physical parameters, the temperature of thermal comfort changes with adaptation: adjustment, acclimatisation, habituation and expectation. A theory that does take into account adaptation and is increasingly applied all over the world is the Adaptive Comfort Algorithm (ACA) which was developed by both Australian researchers for ASHREA as British researchers (De Dear et al., 1997; McCartney & Nicol, 2002). This approach regards thermal comfort as a result of physical, physiological and psychological aspects, both being dynamic (differing per day), thus rejecting a standard set point, as generated by Fanger. The factors beyond fundamental physics can include demographics (gender, age, economic status), context (building design, building function, season, climate, semantics, social conditioning), and perception (attitude, preference, and expectations).

The adaptive approach assumes that people get accustomed to the circumstances they are exposed to regularly, because of various actions of adaptation (De Dear et al., 1997; Humphreys & Nicol, 1998). According to De Dear et al. there are three categories of adaptation:

- 1 Behavioural Adjustment  
All modifications made to modify the thermal balance between body and environment such as adjusting clothing, activity, posture, windows, fans, moving to a different location, scheduling activities, siestas and dress codes.
- 2 Physiological Adjustment  
All changes in the physiological responses to thermal environmental factors which lead to a gradual diminution in the strain induced by these factors (sweating, changing metabolic rate, changing muscle tension).
- 3 Psychological  
Relaxation of indoor climatic expectations can be associated with the concept of habituation in psychophysics; repeated or chronic exposure to an environmental stressor leads to a reduction of the induced sensation's intensity. In this respect, the duration of exposure to a thermal environment is also important.

Developing a model based on so many uncertain variables was a challenge. Field studies were performed to determine the most appropriate marker for predicting the comfort temperature. Both De Dear et al. (1997) and Humphreys & Nicol (2002) found that recently experienced outdoor conditions best predict the thermal preference of people. Based on regression analysis of their extensive field surveys they derived similar linear equations to relate the outdoor temperatures of the past few days or month ( $T_{e,ref}$ ) to the comfort temperature.

The basic equation is as follows:

$$T_c = a * T_{e,ref} + b$$

**EQUATION 2.1** Calculating the comfort temperature  $T_c$

The constants a and b can vary per group of people or room function. The equations adopted by the standards are based on a wide group of occupants in office environments. Calculation of the reference temperature  $T_{e,ref}$  can also vary.

### Limitations and issues of the Adaptive Temperature Model

---

The method acknowledges the influence of perceived control (whether people feel in control over their thermal environment or not, regardless the real possibilities of control). With greater perceived control, the tolerance regarding the thermal environment significantly. However, this influence is hard to quantify and the adaptive method does not propose a method to do so.

The Adaptive Temperature Model better predicts the thermal sensation in non-conditioned spaces or situations with high level of control than the PMV model; however, in the way they are applied now in the standards, they still regard average people and the same standards are too easily applied trans-regional without regarding the differences of different populations.

From the thermal comfort models developed from the 1930s, the standards based on the adaptive comfort models (for example, ASHRAE 55 (ASHRAE, 2004) or EN15251 (EN-ISO, 2007)) best describe the situation in living rooms (Ubbelohde et al., 2003). However, all of these standards were developed for offices which means that a few aspects need to be taken into account. Therefore a translation needs to be made to the context of the dwelling and to make a few improvements as formulated in the next section (§ 2.3.3).

## § 2.3.2 Options for improvement in thermal comfort assessment in relation to the Adaptive Thermal Comfort System

---

### Individual and cultural differences

In spite of the extensive efforts to gain insight in thermal comfort and perception, the shortcomings of current assessment methods for thermal comfort in design practice are that they still take into account average users, (who do not exist), average occupancy hours, average comfort temperatures, average behaviour and average performances taken for a whole year. Since these aspects can vary greatly, it is important to know the variance in occurrence.

There can be all kinds of factors that determine the differences in thermal preference such as age, posture or culture. A few of these aspects have been researched by testing subjects in different categories to be try to better predict thermal preference of a specific group. In various studies it has been concluded, that women are more sensitive to thermal discomfort, both hot and cold and that in general they prefer a slightly higher temperature (Karjalainen, 2012) and that they are more sensitive to local discomfort (Schellen et al., 2012). Furthermore, differences have been found in vulnerability between young adults and elderly. Aged people have a thermal sensation that is approximately 0.5 lower (according to the thermal sensation scale of [Table 2.1](#)) than their younger counterpart, which makes them particularly vulnerable to cold. Additionally they have been proven to recover from cold more slowly (Kingma et al., 2011). However, this doesn't have an influence on the thermal sensation as felt during mild temperature drift (Schellen et al., 2010). Moreover, various studies point out that generally people prefer thermal circumstances at which they are exposed most. Needless to say this varies with lifestyle, occupation and culture. There have been insufficient studies to quantify these differences, but in a home one can expect these differences to be more prominent in offices and above all important to account for when designing the thermal comfort delivery system. It is difficult to quantify these differences, but it is sensible to expect that this can vary at least within the bandwidth usually assumed in which 85% of the occupants will be satisfied. This bandwidth is asymmetrical and approximately 6 K wide with a larger tolerance for temperatures above the comfort temperature. This research researches the required flexibility of the system to adapt to varying comfort demand.

### Temperature and other aspects

Furthermore, comfort is only expressed in terms of temperature and assumes a steady state. As exact as this seems to be, it is a pretence of accuracy. Not only is it impossible to predict an exact optimal comfort temperature, it is also unnecessary for the residential context. Rather than an optimum, comfort is a temperature range in which

the subject does not feel uncomfortable. In this temperature range, other aspects of comfort can play a significant role in the experience of comfort. A feeling of discomfort might not be caused by the actual temperature, but by feelings of lack of control, by air quality problems, visual effects or even illness of the perceiver.

The quality of the comfort system needs to be assessed in terms of the relative ease to reach comfort status, flexibility and energy needed to reach it rather than the actual comfort temperature reached in simulations.

### Health

There is a large number of studies that show spaces with the following characteristics cause more health issues and lower appreciation of thermal comfort (Leijten & Kurvers, 2007);

- Cooling, humidification and recirculation of ventilated air;
- Air treatment by means of induction units;
- Insufficient control on the affected temperature per space;
- Windows that cannot be opened for any reason;
- High density of users per space in large working areas.

A survey in 95 office buildings in the United States (Mendell & Mirer, 2009) shows that in winter more health issues occur when the temperature is on the warm side of the comfort margin. In summer there are more symptoms when the temperatures measured are lower than the comfort area. In summer many buildings were found to be colder than it should be according to the standards. Therefore there are more health symptoms when buildings are chilled too much in summer and when they are heated too much in winter. Because it also leads to unnecessary energy use, it is wise to avoid over conditioning of the space.

### Current development of the Dutch residential sector

With regard to the design of comfort systems for dwellings, recent and on-going developments ask for certain new concepts in the residential sector (BouwHulpGroep 2007). Most of all there is a need of concepts that facilitate adaptability to user specific demand regarding:

- Changing use of the dwelling and its spaces
- Individual differences in comfort experience
- Individual differences in health sensitivity
- Avoiding internal nuisance (e.g. noise, differences in thermal preference, privacy issues)

It will be a challenge to use the adaptive approach proposed in this thesis to save energy while providing for the increasing demand for quality and individual preferences.

### § 2.3.3 Translating the Adaptive Temperature Model for the Adaptive Thermal Comfort System for dwellings

---



The way this research deals with the Adaptive Temperature Model is different than the usual assessment approach used by the standards because it regards the models as “probabilistic” information rather than deterministic as well as taking into account the dynamics of comfort perception and taking into account more aspects than just the physical. In this section, the Adaptive Comfort Algorithm is translated to best describe the possible comfort demand occurrences, combining the models with data obtained from the report “Energiegedrag in de woning” (VROM, 2010) published by the Dutch Ministry for Housing, Spatial Planning and the Environment documents research about occupant behaviour in the Netherlands with respect to heating and energy saving.

The translation and difference in approach from previous studies is evident in the following points, which should be regarded to better provide the comfort demand and to achieve energy savings:

- 1 The bandwidth of acceptability of temperatures in the Adaptive Comfort Algorithm is usually given in percentages of expected dissatisfied occupants. However, the thermal sensitivity of people varies with the context and expectation. This means that **per individual, thermal sensation and comfort experience may vary, at constant thermal environmental factors**. These can be both physiological reasons (body weight, vaso-motion) and psychological (expectation, habituation) (De Dear et al., 1997; Humphreys & Nicol, 1998). In addition people’s thermal sensitivity may vary from person to person. Older people are more sensitive to discomfort and hypothermia or overheating due to reduced thermal perception and reduced physiological adaptation (Schellen et al., 2010; Kingma et al., 2011). This means there is no fixed temperature at which everyone feels comfortable in a given situation, so in this study, the comfort temperatures are not regarded as a precision. Because in the home, there is a small population which can control their own environment, **these bandwidths are regarded as a probability distribution of increasing improbability of occurrence** as opposed to an expected percentage of dissatisfied occupants. Even the width of the bandwidth can vary from person to person and even situation, according to the thermal sensitivity of people.
- 2 In homes the adaptive capabilities are greater than in offices by the possibility of customised clothing, activity, location and opening of windows and doors. This leads to

greater acceptance of the climatic conditions as well as a broadening of the bandwidth of accepted temperatures (De Dear et al., 1997; Humphreys & Nicol, 1998). More research will be needed to quantify this. However, **within the broad temperature limits that need to be secured, the controllability of the temperature and the thermal environment are at least as important as the temperature itself**. This means that the setpoint temperature is no instantaneous fixed value but a temperature range which can be easily adapted by the user within the given bandwidth and possibly even outside this bandwidth.

- 3 Adaptive Comfort Algorithms focus more on a steady state situation, with one comfort temperature per day. However, the activities change throughout the day and so is the assessment of the comfort. This is partly due to the expectation that the temperature on the day varies by the natural course of the outdoor temperature and the response of the dwelling and its comfort system. However, there is no research available (yet) to quantify this relation in (Dutch) dwellings
- 4 Different comfort bandwidths will be regarded for different room functions because of the difference in activity levels, expectations and adaptive opportunities. The bandwidths used for bedrooms and bathrooms are adopted from Peeters et al. (2009).
- 5 For children the indoor climate is controlled by the parents (or care-takers). It is assumed that in general they have larger physiological adaptation, but because they have fewer behavioural adaptive capabilities the comfort area will be within the same limits as for adults.
- 6 Adaptive comfort models can not directly be translated to use for actively cooled residences. However, this project will attempt to provide comfort without active cooling (the use of energy for the generation of cold) (Nicol, 2012).

### § 2.3.3.1 Thermal comfort in the context of the dwelling

---

In contrast to dwellings, in the office environment, where the set-point temperature often is to be controlled centrally, it is still useful to determine average comfort temperatures for the target group. In this way it is likely that, statistically, as many people as possible are satisfied, optimizing their productivity. However, in dwellings people are considered in charge of their own environment and they are able to control their set-point temperature individually. The dwelling and the comfort system should facilitate the occupant to create their own environment. These aspects shift the question for this thesis from an actual comfort temperature to be reached to a range of temperatures that should be avoided to ensure absence of discomfort likely to occur due to the thermal environment and the variability of this range as well as the constraints for other aspects that influence the perception of thermal comfort.

## Standard heating and thermostat use in the Netherlands

The report “Energiegedrag in de woning” (VROM, 2010) published by the Dutch Ministry for Housing, Spatial Planning and the Environment documents research about occupant behaviour in the Netherlands with respect to heating and energy saving. By asking the respondents to report the setpoint temperature per hour it concludes that the bigger part of the households in the Netherlands (48%) heats the home according to the pattern they call “standard” (Figure 2.3): at night (21:00 - 23:00) the thermostat is changed to approximately 16 °C. In the morning (6:00 - 8:00), the thermostat is set up to approximately 19 °C and stays there for the rest of the day. Somewhere between 16:00 and 19:00 the thermostat is turned up another slightly extra to approximately 20 °C. In the weekend the daytime temperature setting is slightly higher than the average daytime temperature setting during the week. This is usually accomplished by setting a clock thermostat and the fact there is no difference in schedule between weekend and weekdays leads to the assumption that the schedule is usually standardised regardless if the home is occupied or not. This type of heating will be regarded as the reference heating demand pattern in this research. It should be noted that **the settings for the thermostat must not be directly interpreted as the comfort temperature as other aspects such as household income, intention to save energy and capacity of the comfort system do influence the applied settings; however, they can serve as an indication of the standard comfort level.** As becomes clear from the next paragraph, the average setting of the thermostat in Belgium is approximately 1 degree higher.

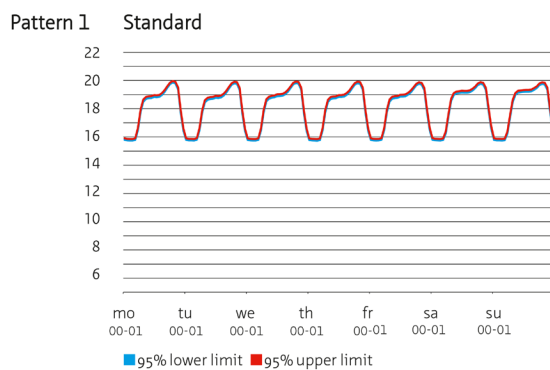


FIGURE 2.3 Standard heating pattern (set point temperature) of Dutch households

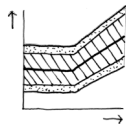
### § 2.3.3.2 Adaptive Temperature Model for Dutch dwellings

---

In a study in Belgian dwellings, Peeters et al (2009) found the equations displayed in Frame 5.1 for the bedroom, bathroom and other rooms. The study is based on measurements of thermostat settings in Belgian homes. However the equations suggest the calculated temperature to be the comfort temperature, caution should be exercised because these settings can, like mentioned on the previous page, be influenced by other aspects than thermal comfort. However, this is the only study known to the author that differentiates the various room functions in dwellings and though taken in Belgium, this is considered the most suitable study for predicting comfort temperatures in the Dutch residential practice. Though, in general the temperature at which most thermostats are set in the Netherlands is considered at 19 °C during the day and 20 °C during the evening as can be seen in Figure 5.1, while the temperature setpoint for heating according to Peeters equation will be around 21 °C on average. The algorithms used in this thesis will be the same as found by Peeters in Belgium, with a maximum for heating of 21.5 °C. The algorithm to calculate the reference temperature is Equation 2.2 in § 2.3.3.

#### The Adaptive Comfort Algorithm for different room functions

---



For the bedrooms and the bathroom, the algorithms used in this thesis are the ones developed for Belgian dwellings by Leen Peeters (2009). For cultural reasons this data cannot be translated directly for the Dutch situation. However, such data is not available for Dutch dwellings and the Belgian climate is very similar to the Dutch so it gives a good image of the dynamics of thermal comfort and the difference for different activities. However, the method of this research is fit to incorporate any algorithm relating outdoor climate and comfort with regard to the different activities deployed. The equations to be used for the comfort temperature in the different zones in this thesis are distilled to 5 equations (Equation 2.2 to Equation 2.6).

The bandwidths Peeters uses, are those of the 10% and 20% percentage dissatisfied, according to Fangers PPD scale. In this study, the bandwidth is not considered as such, but as a spread in desired comfort temperature. In this respect, a bandwidth equivalent to 20% PPD is chosen, since it can represent a larger diversity in population. However, it could well be that the bandwidth is bigger. This needs to be researched via comfort surveys conducted in the Netherlands, before one could truly decide on that. For adjustment for increased metabolic rate during light household work, a correction factor can be used according to ISSO\_74 (2004).

$$T_{e,ref} = (T_{today} + 0.8 \cdot T_{today-1} + 0.4 \cdot T_{today-2} + 0.2 \cdot T_{today-3}) / 2.4$$

EQUATION 2.2 Reference temperature (Humphreys & Nicol, 2002)



$$T_n = 20,4 + 0,06 \cdot T_{e,ref} \quad \text{for} \quad T_{e,ref} < 12,5 \text{ } ^\circ\text{C}$$

$$T_n = 16,63 + 0,36 \cdot T_{e,ref} \quad \text{for} \quad T_{e,ref} \geq 12,5 \text{ } ^\circ\text{C}$$

**EQUATION 2.3** Comfort temperature living area, reclining activity (Humphreys & Nicol, 2002)

$$T_{upper} = T_n + w \cdot \alpha$$

$$T_{lower} = \max(18, T_n - w(1 - \alpha))$$

**EQUATION 2.4** Bandwidth living area (Peeters et al., 2009)

$$T_n = 16 \quad \text{for} \quad T_{e,ref} < 0 \text{ } ^\circ\text{C}$$

$$T_n = 16 + 0,23 \cdot T_{e,ref} \quad \text{for} \quad 0 \text{ } ^\circ\text{C} \leq T_{e,ref} < 12,6 \text{ } ^\circ\text{C}$$

$$T_n = 9,18 + 0,77 \cdot T_{e,ref} \quad \text{for} \quad 12,6 \text{ } ^\circ\text{C} \leq T_{e,ref} < 21,8 \text{ } ^\circ\text{C}$$

$$T_n = 26 \quad \text{for} \quad T_{e,ref} \geq 21,8 \text{ } ^\circ\text{C}$$

**EQUATION 2.5** Comfort temperature sleeping area (Peeters et al., 2009)

$$T_{upper} = \min(26, T_n + w \cdot \alpha)$$

$$T_{lower} = \max(16, T_n - (1 - w) \cdot \alpha)$$

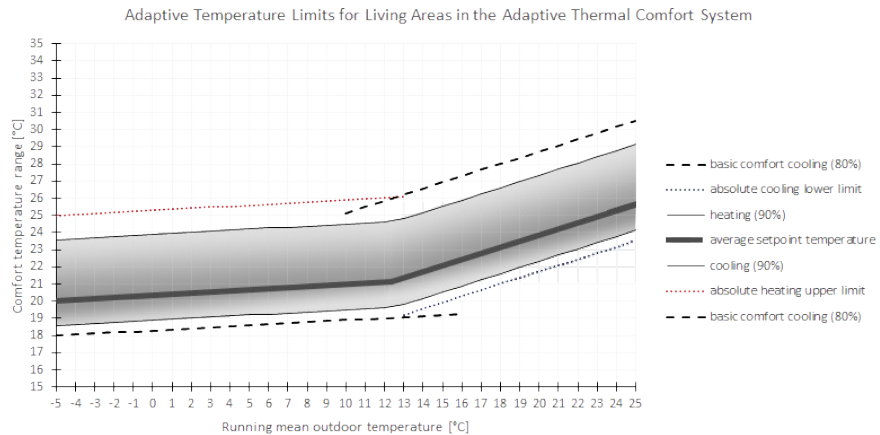
10% PPD:  $w = 5$ ;  $\alpha = 0,7$

20% PPD:  $w = 7$ ;  $\alpha = 0,7$

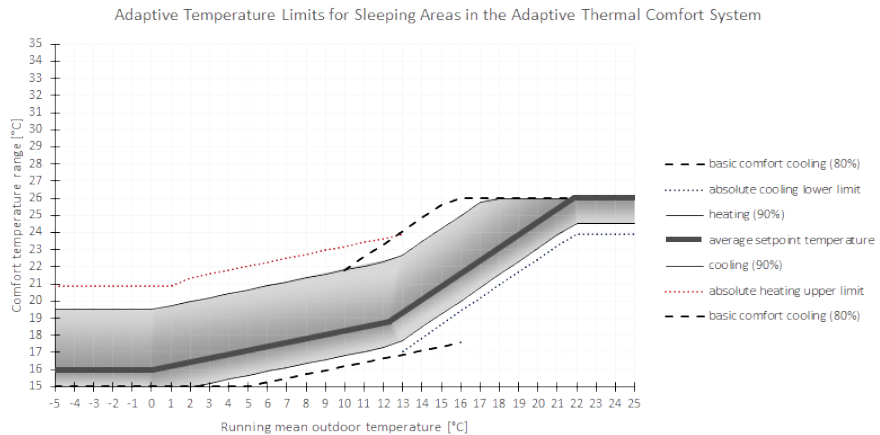
**EQUATION 2.6** Bandwidth sleeping area (Peeters et al., 2009)

With:

$T_n$ [ $^\circ\text{C}$ ]	Statistical neutral temperature, considered as comfort temp.
$T_{e,ref}$ [ $^\circ\text{C}$ ]	Outdoor reference temperature
$T_{upper}$ [ $^\circ\text{C}$ ]	Upper temperature limit
$T_{lower}$ [ $^\circ\text{C}$ ]	Lower temperature limit
$w$ [ $^\circ\text{C}$ ]	Width of the comfort band
$\alpha$	Statistical constant



### 1 Living area



### 2 Bedroom

**FIGURE 2.4** Interpretation of comfort temperature and bandwidth for living areas and bedrooms based on the equations by Peeters (2009)

The interpretation of the equations according to the 11 aspects for translation mentioned becomes clear in [Figure 2.4](#). The grey zones depict the temperatures at which most people feel comfortable. The bandwidth is delimited by the lines within 80% is comfortable and 90% is comfortable. It depends on the quality of the Thermal Comfort System if it can obtain the 80% limit or the 90% limit. To ensure a basic comfort level, the heating temperatures should not be below the basic comfort heating line and not above the basic comfort cooling line. To prevent health issues related to the comfort system as reported by Mendell & Mirer (2009) the room should never be heated above the upper limit for heating nor cooled below the lower limit for cooling.

## § 2.3.4 Considerations for presence and control in the Adaptive Thermal Comfort System

---

As argued in the Adaptive Thermal Comfort System it doesn't suffice to determine the average comfort temperature and demand. Therefore, this chapter aims at finding a spread in activity patterns and tries to see the comfort demand in the context of individual preferences and vulnerabilities by bringing together information of various disciplines. It presents a method of mapping user profiles and takes as an example the Dutch situation using a Time Use Survey performed by the NIWI (2002). Aim is not to predict occupant behaviour, but to give an insight in the possible demand and variability of this demand. The user profile information will be used for the calculations in [PART 2](#) of this thesis, to determine the optimal dynamic building characteristics for personal and flexible comfort demand with minimal use of fossil fuels.

### § 2.3.4.1 Demographics and Time Use Survey as data for the occupancy profiles

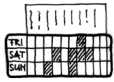
---

To know which occupancy profiles are most representative for the population of the Netherlands it is important to know what kind of household types live in the Netherlands. The website of the national institution for statistics of the Netherlands (CBS) gives information about the distribution of household types (CBS, 2009). Most of the households in the Netherlands are one or two person households.;However, the majority of the individuals live in 2 person households (29%) or in 4 person households (23%).

The profiles used in this research are based on a statistic analysis of a Time Use Survey performed by the NIWI (2002) in the Netherlands. This is a survey performed in the Netherlands, amongst 1813 respondent of various ages, from 12 till 102 years old, and different gender, household type, position in household, occupation, nationality and educational level as well as different types of environment (urban, "rural"), dwelling type and religions. However, it should be noticed that different nationalities than Dutch might be under represented due to language problems with the survey. The respondents were chosen by random sampling with an aim to get a representative sample for the whole population of the Netherlands (from the age of 12 years old).

### § 2.3.4.2 Compilation of user profiles for Dutch dwellings

---



The profiles used in this research are based on a statistic analysis of a Time Use Survey performed by the NIWI (2002) in the Netherlands. This is a survey performed in the Netherlands, amongst 1813 respondent of various ages, from 12 till 102 years old, and different gender, household type, position in household, occupation, nationality and educational level as well as different types of environment (urban, "rural"), dwelling type and religions. However, it should be noticed that different nationalities than Dutch might be under represented due to language problems with the survey. The respondents were chosen by random sampling with an aim to get a representative sample for the whole population of the Netherlands (from the age of 12 years old). From this study it can be derived which percentage of people in certain household types can be expected to be performing certain activities each quarter of an hour over the course of a week. From this, realistic occupancy and activity profiles are derived, which are used to determine the comfort demand likely to occur. The profiles consist of patterns of occupancy and activity per function area (e.g. living area; sleeping area; work area). The profiles contain information per hour of the day for a working day, a Saturday and a Sunday.

The profiles were categorised by the household types the respondents lived in reported in the survey. Per household type the profiles were "averaged" by determining if the majority of the respondents in that group was at home and if they were home, in which room was the majority. The average profile that then is created is used to find the actual profile (of one of the respondents) that corresponds most with the average profile. The averaged profile itself was not used, as in the process of averaging the details such as taking a shower or a quick breakfast were lost.

Most of the household types consist of more than one people. Therefore the profiles of people were combined to a household profile. The smaller children in the household (younger than 5 years old) are considered to be present where the partner taking care of them is. In the other occasions, the individual profiles of one household type are combined within the profiles for one household.

The profiles per room compiled now exists of information about presence (how many people are present) and activity level of the people present. The lowest activity level of the present people is assumed to be indicative for the comfort demand, because this will determine the lower limit of the comfort bandwidth. An example of part of a profile is depicted in [Table 2.2](#). The full profiles can be found in [Appendix A](#). The scale for activity the levels is explained in [Table 2.3](#).

4 person household, 2 children		pro.00	pro.01	pro.02	pro.03	pro.04	pro.05	pro.06	pro.07	pro.08	pro.09	pro.10	pro.11	pro.12	pro.13	pro.14	pro.15	pro.16	pro.17	pro.18	pro.19	pro.20	pro.21	pro.22	pro.23	pro.04	pro.01	pro.02	pro.03	pro.04	pro.05	pro.06	
Livingroom	amount people	0	0	0	0	0	0	0	0	0	1	1	1	1	1	0	0	0	2	2	2	2	2	2	2	2	0	0	0	0	0	0	0
	lowest activity level	0	0	0	0	0	0	0	0	0	1	1	1	1	1	0	0	0	0	0	0	0	0	0	0	0	0	0	0	0	0	0	
Master Bedroom	amount people	2	2	2	2	2	2	2	2	1	0	0	0	0	0	0	0	0	0	0	0	0	0	0	0	0	0	0	0	0	0	0	
	lowest activity level	1	1	1	1	1	1	1	1	1	0	0	0	0	0	0	0	0	0	0	0	0	0	0	0	0	0	0	0	0	0	0	
Work/Bedroom	amount people	1	1	1	1	1	1	1	1	0	0	0	0	0	0	0	0	0	0	0	0	0	0	0	0	1	1	1	1	1	1		
	lowest activity level	1	1	1	1	1	1	1	1	0	0	0	0	0	0	0	0	0	0	0	0	0	0	0	1	1	1	1	1	1	1		
Work/Bedroom 2	amount people	1	1	1	1	1	1	1	1	0	0	0	0	0	0	0	0	0	0	0	0	0	0	0	1	1	1	1	1	1	1		
	lowest activity level	1	1	1	1	1	1	1	1	0	0	0	0	0	0	0	0	0	0	0	0	0	0	0	1	1	1	1	1	1	1		
Bathroom	amount people	0	0	0	0	0	0	0	0	0	1	0	0	0	0	0	0	0	0	0	0	0	0	0	0	0	0	0	0	0	0	0	
	lowest activity level	0	0	0	0	0	0	0	0	1	0	0	0	0	0	0	0	0	0	0	0	0	0	0	0	0	0	0	0	0	0	0	

TABLE 2.2 Example of an occupancy profile with activity level, family with two children age 12-18 years old

NUMBER	ACTIVITY	METABOLIC EQUIVALENT
0	not present	-
1	sleep	0.9 MET
2	resting	1.0 MET
3	light (household) work	2.5 MET
4	household work	3.5 MET
c	working with computer (extra heatsource)	1.8 MET ( + ca. 75 W (computer))
cc	cooking (extra heat source)	2.5 MET ( + ca. 500 W (stove))

TABLE 2.3 Activity levels used in occupancy profiles (based on Fanger, 1970)

§ 2.3.4.3 Summary of the occupancy profiles to be used in the calculations

The occupancy profiles are compiled to account for the individual differences of occupancy of the rooms during the course of a day and week. The differences are significant and the different profiles can be found in detail in Appendix A. However there are some properties that can be summarised to be able to analyse the differences in performance of dynamic building characteristics in the following chapters. These are the occupancy rate (percentage of the time a room is occupied during the week), average occupancy (average amount of people present during the occupied hours) and the average activity (the average activity level during occupancy). Table 2.4 shows the characteristics of the analysed occupancy profiles. Depending on the household composition the second bedroom can be considered to be used as an office if one of the adults (sometimes) works at home.

The profiles are significantly different looking at the occupancy rates of all the rooms but the master bedroom. The activity levels are not significantly different amongst the profiles; however, they are per room. In the calculations per room (chapter 5) only the living room and the master bedroom are assessed as the variation per function (bedroom or day activity) is covered sufficiently.

	LIVING ROOM		KITCHEN		MASTER BEDROOM		BEDROOM 2 / OFFICE		BEDROOM 3							
characteristic	occupancy rate	average occupancy	average activity	occupancy rate	average occupancy	average activity	occupancy rate	average occupancy	average activity	occupancy rate	average occupancy	average activity	occupancy rate	average occupancy	average activity	not at home
profile																
1_st	10%	1.26	2.5	2%	1	3.25	33%	1	1	8%	1	2	-	-	-	53%
1_soc	17%	1.19	2.0	11%	1	3.30	34%	1	1	17%	1	2	-	-	-	6%
2_h	54%	1.35	2.0	14%	1	3.45	62%	1.39	1	54%	1	2	-	-	-	0%
2_w	18%	1.32	2.1	8%	1	3.25	39%	1.73	1	1%	1	2	-	-	-	41%
4_sc	30%	1.69	2.0	8%	1.55	3.70	40%	1.81	1	30%	1	1	46%	1	1	28%
4_sm	46%	1.70	2.4	15%	1.35	3.20	37%	1.77	1	43%	1	1	34%	1	1	16%
1_st	1 person household, student															
1_soc	1 person household, social with much visit															
2_h	2 person household, at least one with work from home or no job															
2_w	2 person household, both with job															
4_sc	4 person household, school going children															
4_sm	4 person household, two children under the age of 5															
*	The household types are based on the household types reported in the Time Use Survey (NIWI, 2002)															

TABLE 2.4 Summary of occupancy characteristics of occupancy profiles to be used in the calculations

## § 2.4 Weather and thermal comfort



In this section, basic knowledge of climatic aspects is briefly described, because this is the most important factor of the energy balance of a building when it comes to the thermal environment. Furthermore, as became clear from the previous section the weather has an important influence on the perception of thermal comfort.

Nowadays in architecture and construction of most buildings, the climate is seen as a burden, which influence should be kept away from the indoor climate as much as possible, in order to condition the indoor environment as we wish. To do so, buildings are sometimes literally sealed off (as with airtight buildings with very high thermal insulation rates) from the outside world as a thermos flask. However, there are some influences that are wanted to enter the buildings, such as daylight, sunlight and fresh air which can negatively influence the indoor thermal environment causing an energy demand to restore thermal comfort. Therefore it is important to know the climate with its variations to be able to seize opportunities to do so.

The conventional design of a building for thermal comfort will take into account average weather conditions, occupants and (when making use of renewable resources) average yields and efficiency of conversion systems.

### § 2.4.1 Physiological Equivalent Temperature (PET)

---

The experience and thermal energy exchange we have of the weather is not only determined by the ambient temperature. Solar radiation, wind speed and relative humidity have an influence on the thermal heat balance of the human body and therefore on the perception of heat and cold. The same factors affect the thermal heat balance of a building. The weather factors that most influence the heat balance of the human body and therefore the thermal comfort are the following;

- ambient temperature [ $^{\circ}\text{C}$ ]
- solar radiation [ $\text{W}/\text{m}^2$ ]
- wind speed [ $\text{m}/\text{s}$ ]
- relative humidity [%]

To be able to capture these parameters in one single index for outdoor comfort the Physiological Equivalent Temperature (PET) developed by Höppe (1999) will be used in this thesis which is a universal index for the bio-meteorological assessment of the thermal environment and it regards all four elements mentioned above. The definition of PET given by Höppe is:

*'PET is defined as the physiological equivalent temperature at any given place (outdoors or indoors) and is equivalent to the air temperature at which, in a typical **indoor** setting, the heat balance of the human body (work metabolism 80 W of light activity, added to basic metabolism; heat resistance of clothing 0.9 clo) is maintained with core and skin temperatures equal to those under the conditions being assessed.*

*The following assumptions are made for the **indoor** reference climate:*

- Mean radiant temperature equals air temperature ( $T_{\text{mrt}}=T_{\text{a}}$ )
- Air velocity is set to 0.1 m/s
- Water vapour pressure is set to 12 hPa (approximately equivalent to a relative humidity of 50% at  $T_{\text{a}}=20^{\circ}\text{C}$ )

The procedure for calculating PET consists of the following steps;

- Calculation of the thermal conditions of the body with MEMI for a given combination of meteorological parameters.
- Insertion of the calculated values for mean skin temperature and core temperature into the model MEMI (Munich energy balance model for individuals) and solving the equation system (Eqs. 1 and 3) for air temperature  $T_a$  (with  $v=0.1$  m/s,  $VP=12$  hPa and  $T_{mrt}=T_a$ )
- The resulting air temperature is equivalent to PET'

## § 2.4.2 The Dutch situation

---

The Netherlands is a small country with little height differences and bordering the North Sea, it has a maritime climate, with relatively cool summers and mild winters. In the Netherlands, the KNMI keeps records of all weather data from the early 20<sup>th</sup> century (KNMI, 2012). Table 2.5 shows the long term averages of the Dutch climate. The weather is very variable and rainfall occurs frequently throughout the year, although only half of the days a form of precipitation occurs, often alternating with dry periods. However, approximately 92% of the weighted hours per year there is no precipitation; nevertheless, if climate change progresses precipitation may increase significantly. The mean temperature is 2°C in January and 17°C in July, with an annual average of about 10°C. Due to the high relative humidity (with averages 75-85% in spring to 85-90% in winter) clouds generally appear every day, and in the winter months fog often abounds. From the long term averages for summer days (26 summer days annually and 4 tropical days annually) it can be concluded that if designed for energy conservation, besides the energy conservation needed in winter the possibility to discard heat in summer (and fall and spring) should not be forgotten. Furthermore, especially in winter as much daylight as possible may be allowed in.



WEATHER PARAMETER	VALUE	UNIT
Average Temperature (year)	10,1	°C
Average Temperature in Winter (1 dec.-28/29 febr.)	3,4	°C
Average Temperature in Summer (1 june-31 aug.)	17,0	°C
Average Daily minimum Temperature in Winter	0,5	°C
Average Daily maximum Temperature in Summer	21,9	°C
Ice Days (max. temp <0,0°C)	8	days
Frost Days (min. temp <0,0°C)	58	days
Summer Days (max. temp >=25,0°C)	26	days
Tropical Days (max. temp >=30,0°C)	4	days
Degree-days <sup>2)</sup>	2 951	degrees
Precipitation	887	mm
Relative Humidity	82	%
Days with precipitation >= 1,0 mm	131	days
Days with no Precipitation	122	days
Days with no Sun	61	days
Days with fog	63	days
Sunshine	1 602	hours
Global Radiation <sup>1)</sup>	354	kJ/cm <sup>2</sup>

TABLE 2.5 Long term averages of De Bilt in The Netherlands from 1981 to 2010 (KNMI, 2012)

Although the weather type in the country is roughly the same, slight geographical differences are noticeable. The average annual rainfall is about 74 in the middle of Limburg to 97.5 cm in Gelderland.

More sunshine occurs on the coast and gradually decreases moving land inward. The total hours of sunshine is approximately 1500 across the Netherlands. The maximum solar zenith is 62 degrees in summer and 15 degrees in winter and is not significantly different from North to South.

The average temperature doesn't vary much across the Netherlands (9.6 to 11.1 °C); however, the minimum temperature and maximum temperature distribution show that close to the coast the smallest temperature fluctuation is present due to the maritime climate.

### § 2.4.2.1 Implications of climate change for thermal comfort in the Netherlands

There is a growing concern about the use of fossil energy and its implications for the environment. After decades of debate, the human influence on the climate seems near to certain, supported by a vast majority of climate scientists gathered under the

International Panel on Climate Change (IPCC, 2014). NASA has identified eight effects of rapid climate change. These are: global temperature rise, warming oceans, shrinking ice sheets, declining Arctic sea ice, glacial retreat, sea level rise, extreme weather events and ocean acidification. The exact extent to which these effects of climate change will occur, and in which time-frame, is subject to uncertainty. Therefore the IPCC works with different variants, sets of probabilities, each leading to different outcomes for the temperature increase and sea level rise. T

The Royal Dutch Meteorological Institute (KNMI) has translated the IPCC variants to four main scenarios in the near future in 2050, divided as in a matrix of two times two: a moderate (G) and warm (W) scenario (+1 °C, +2 °C temperature increase respectively) versus unchanged or changed (+) air circulation patterns (KNMI, 2014). Recent insights indicate a greater probability towards W (Warm) and W+ (Warm+) rather than G (Moderate) and G+ (Moderate +), implying higher temperatures throughout the year as well as dryer summers and wetter winters. Table 2.6 presents an overview of climate characteristics for each of the four climate scenarios. The climate change implicates that care should be taken to prevent overheating for comfort delivery systems in the Netherlands.

		2050				2100			
Global rise in temperature		+1°C	+1°C	+2°C	+2°C	+2°C	+2°C	+4°C	+4°C
changes in air flow patterns in Western Europe		no	yes	no	yes	no	yes	no	yes
Winter	average temperature	+0.9°C	+1.1°C	+1.8°C	+2.3°C	+1.8°C	+2.3°C	+3.6°C	+4.6°C
	coldest winter day of the year	+1.0°C	+1.5°C	+2.1°C	+2.9°C	+2.1°C	+2.9°C	+4.2°C	+5.8°C
	average precipitation	+4%	+7%	+7%	+14%	+7%	+14%	+14%	+28%
	number of wet days (≥ 0.1mm)	+0%	+1%	+0%	+2%	+0%	+2%	+0%	+4%
	10 day precipitation sum exceeded once per decade	+4%	+6%	+8%	+12%	+8%	+12%	+16%	+24%
	highest-day-average wind speed per annum	+0%	+2%	-1%	+4%	-1%	+4%	-2%	-8%
Summer	average temperature	+0.9°C	+1.4°C	+1.7°C	+2.8°C	+1.7°C	+2.8°C	+3.4°C	+5.6°C
	warmest summer day of the year	+1.0°C	+1.9°C	+2.1°C	+3.8°C	+2.1°C	+3.8°C	+4.2°C	+7.6°C
	average precipitation	+3%	-10%	+6%	-19%	+6%	-19%	+12%	-38%
	number of wet days (≥ 0.1mm)	-2%	-10%	-3%	-19%	-3%	-19%	-6%	-38%
	day sum of precipitation sum exceeded once per decade	+13%	+5%	+27%	+10%	+27%	+10%	+54%	+20%
	potential evaporation	+3%	+8%	+7%	+15%	+7%	+15%	+14%	+30%
Sea level	absolute increase (cm)	15-25	15-25	20-35	20-35	35-60	35-60	40-85	40-85

TABLE 2.6 climate characteristics for each of the four climate scenarios (KNMI, 2014)

### § 2.4.3 Elaborate analysis of the Dutch weather in the context of thermal comfort

To fully seize the opportunities of the climate and account for the threats, as overheating after a period of cold outdoor temperatures, a more elaborate dynamic analysis needs to be made, combining the factors to assess the thermal comfort of the outdoor environment which are the dynamic boundary conditions for thermal comfort in the building regarding possible exceptions and weather swings.

#### Data



The weather data from the past years of 1980 to 2012, is obtained from the Dutch Royal Institute of Meteorology (KNMI, 2012) containing the hourly recordings from 1980 to 2012 of the weather station of De Bilt is analysed in relation to thermal comfort.

Furthermore, the climate scenario W+ for 2050 is researched by using the new test reference year supplied by TNO (NEN\_5060, 2008), which was developed according to the climate scenario 2050 W+ developed by KNMI (2014) based on the climate scenarios by IPCC (2007).

#### Standardised parameters for the PET calculation

To relate the outdoor thermal environment to the heat balance and thermal comfort experience the PET as described in § 2.4.1 is used for the analysis. The PET for the weather information is calculated by the computer tool Rayman (Matzarakis et al., 2010) using the parameters for the human body. Standard parameters are used to be able to analyse the fluctuations of the weather shown in Table 2.7.

VARIABLE	VALUE	DESCRIPTION
Metabolism	80 W	Light activity
Clothing	1.0 clo	Average indoor clothing
Age	35 y	
Gender	male	

TABLE 2.7 Input values Rayman calculation (Matzarakis et al., 2010)

## Analysis and visualisation

---

This research displays the weather data in distribution graphs with percentile lines. They represent the values recorded sorted by month and show the recordings per hour of the day. In all the graphs in this chapter, the horizontal axis shows the hour of the day of the recorded data and the vertical axis shows the temperature of these recordings. The red line represents the average and the black continuous line shows the median values. In the range between the percentile-lines of 0.8 and 0.2 are 80% of all recordings and between the 0.6 and 0.4 percentile-line 20% of all recordings can be found.

The data for the past years used is obtained from the Dutch Royal Institute of Meteorology (KNMI, 2012) and contains the hourly recordings from 1980 to 2012 of the weather station of De Bilt.

The weather in the Netherlands will be mapped to determine what is the average weather occurring over the year, per month, per day and per hour and the relation to thermal comfort by determining the hours exceeding, falling in and under-running the thermal comfort bandwidth of the Adaptive Comfort Method. More importantly, after determining the average, the weather of the past 33 years is analysed to determine the variance in weather over the months and step changes occurring (dramatic changes from day to day and hour to hour). The step changes can pose an extra strain on thermal comfort and energy use, as according to the adaptive comfort theory the comfort temperature changes with the weather circumstances but with a certain time lag in that relation.

## Used comfort model for assessment of the weather

---

The hourly weather data in PET is compared to the comfort temperature for that hour calculated by the Adaptive Comfort Algorithm (Nicol & Humphreys, 2002) as described in [Equation 2.4](#) to gain insight in the need for heating or cooling in general.

It should be noted that the Adaptive Comfort Algorithm method calculates indoor comfort temperatures. The acceptance of temperatures outdoors is much larger. However, this comparison is made to show the preconditioning of the outdoor thermal environment to create a comfortable indoor environment with the least energy consumption.

## § 2.4.4 PET analysis of the recorded weather in the Netherlands and the test reference year of 2050 W+

### PET in the recorded years 1980-2012

Figure 2.5 shows the distribution of the PET for the recorded hours during 1980 to 2012 per month.

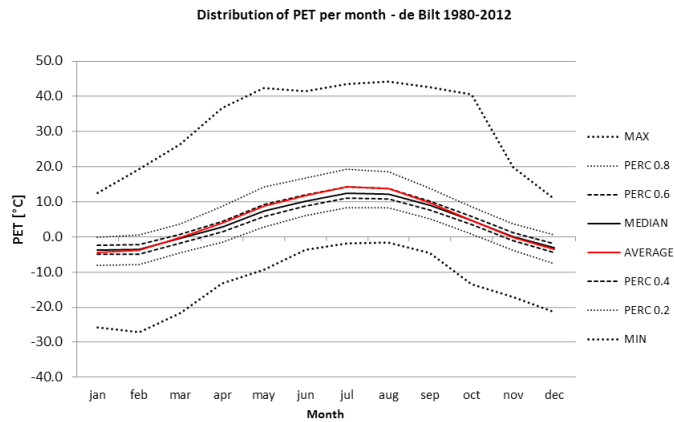
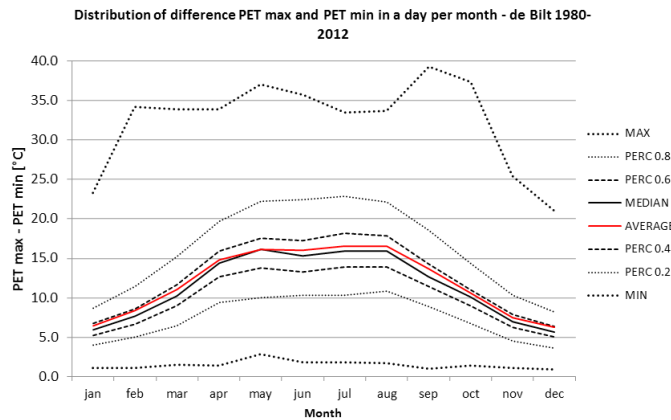


FIGURE 2.5 Distribution of recorded hourly PET per month in de Bilt from 1980 to 2012

Figure 2.5 shows the spread in PET is moderate but the extremes are significant. In the winter extremes of almost  $-30\text{ }^{\circ}\text{C}$  occur because of the wind chill. In summer the temperatures are both high to over  $40\text{ }^{\circ}\text{C}$  and lower to even temperatures slightly below  $0\text{ }^{\circ}\text{C}$ . This shows the great influence solar radiation and air movement can have on thermal perception. Furthermore, the average temperatures are around  $10\text{ }^{\circ}\text{C}$  lower in winter and  $5\text{ }^{\circ}\text{C}$  lower in summer than the ambient temperature, showing the prevailing influence of the wind in the Netherlands on thermal comfort and increasing the difference in temperature between the winter and summer and.



**FIGURE 2.6** Distribution of the difference between maximum and minimum PET per month in de Bilt from 1980 to 2012

The differences between maximum and minimum PET are almost twice as large as with the  $T_a$ . This is because the solar radiation can vary greatly from moment to moment which happens in the Netherlands quite often because of very variable weather. Clouds, rain and sunny periods can alternate fast. The ambient temperature doesn't change so fast with these swings, but the comfort experience can be as well as the thermal balance of a building (depending on the insulation, solar shading and thermal mass).

Extreme rising of the temperature up to 20 °C occurs especially around sun rise and the gradual decrease of temperature occurs during the entire day, implicating warming up by the sun occurs faster at sun rise than cooling down at sun set.

Also the day to day PET difference shows a larger distribution than the ambient temperature although less significant than the hour to hour difference. The increase of the day to day differences is especially eminent during the summer due to the longer days making larger differences in total sunshine hours possible. Furthermore, the solar radiation is more powerful in summer making the difference between no sunshine and sunshine larger.

### PET in the test reference year 2050 W+

Figure 2.7 shows the distribution of recorded hourly PET per month in de Bilt in the test reference year 2050 W+.

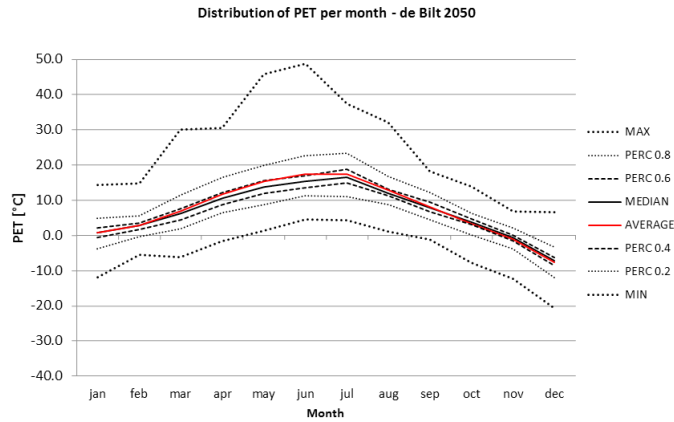
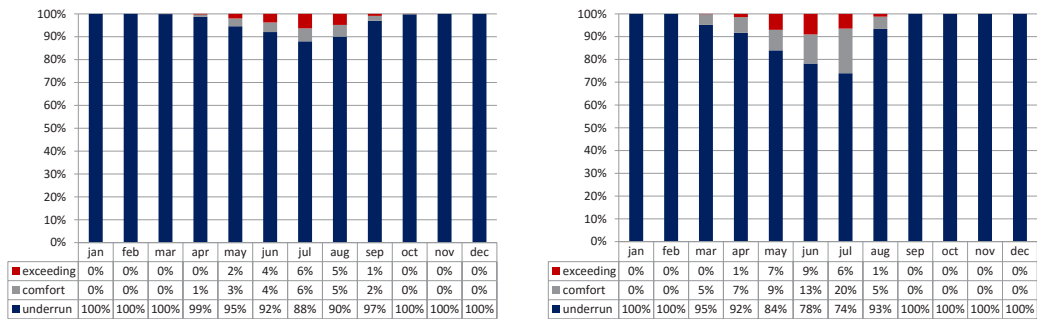


FIGURE 2.7 Distribution of recorded hourly PET per month in de Bilt in the test reference year 2050 W+

Figure 2.7 shows the trend for the future; higher PET during the first half of the year and a drop in the second half of the year with a higher distribution especially in the higher temperatures in summer and a larger difference between summer and winter. Extremes of a PET of almost 50 °C are expected and averages of 20 °C which stresses the need for preventing overheating even more.

### PET related to the comfort temperature

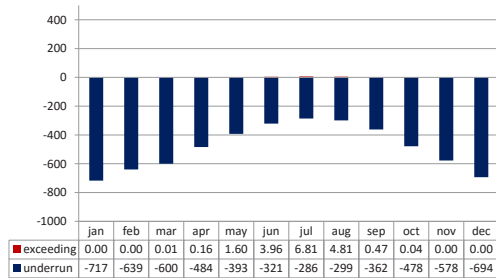
Figure 2.8 shows the hours of exceeding, comfort and underrun for PET respectively for 1980-2012 and 2050 W+. Figure 2.8 shows the exceeding and underrun in degree-days per month for the PET of respectively the averages of de Bilt 1980-2012 and the climate scenario for 2050 W+.



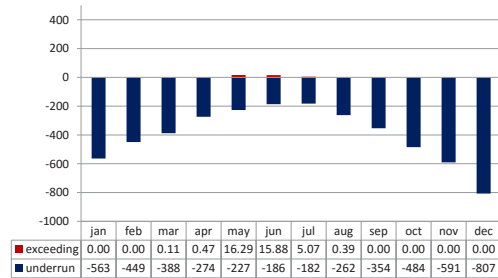
1 1980-2012

2 2050 W+

FIGURE 2.8 Hours of exceeding, comfort and underrun for PET



1 1980-2012

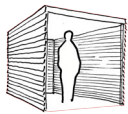


2 2050 W+

FIGURE 2.9 Degree-days of exceeding and underrun per month for PET

These figures show that the hours of exceeding is very low (2% for both 1980-2012 and 2050 W+), underrun occurs during most of the year (97% for 1980-2012 and 93% for 2050 W+) and comfortable hours are (2% for 1980-2012 and 5% for 2050 W+). Calculating the underrun and exceeding in degree-days per month Figure 2.8 shows that the average degree-days of exceeding per year is 17.85 °C degree-days in the past years and is defined as 38.2 °C degree-days in the climate scenario of 2050 W+ which is a significant difference between the recorded years and the climate scenario of 2050 W+; however not very high compared to the underrun with -5878 °C degree-days in the past years and -4767 °C degree-days in the climate scenario of 2050 W+.

## § 2.4.5 Creating a sheltered environment for (pre) conditioning of the thermal environment

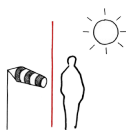


To keep comfortable besides wearing clothes people seek shelter. To determine what kind of shelter people need in the Dutch climate the PET is calculated without shelter, with shelter for the sun and shelter from the wind separately as well as combined. Finally, with the optimal setting for shelter per hour is calculated as an adaptive shelter. Table 2.8 shows the exceeding, comfort and underrun for the different forms of shelter in percentage of the year (%) and in degree day (degree-days).



### Shelter from the wind

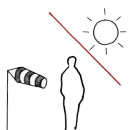
---



In the Netherlands, the wind is usually moderate to strong, greatly influencing outdoor thermal comfort. Using a simple windscreen can significantly decrease the hours of cold even allowing some comfortable hours in February in the 2050 W+ scenario increasing the hours of comfort to respectively 5% and 8% and decreasing the hours of cold to respectively 82% and 84% which can be called a significant improvement (see Table 2.8). However, the hours of overheating increase even more significantly amounting up to 13% for de Bilt from 1980 to 2012 and 8% for the climate scenario for 2050 W+. This shows that one measure taken for one situation can lead to a deterioration of thermal comfort in another situation underlining the need for adaptivity.

### Shelter from the sun

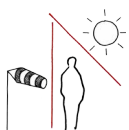
---



The beneficial influence of the sun becomes evident while in most occasions in the Netherlands assuming complete solar shading and no wind protection when calculating the PET. Just applying solar shading results in an underrun during the whole of recorded years and 98% of the test reference year of 2050 W+ (see Table 2.8).

### Shelter from the wind and the sun

---

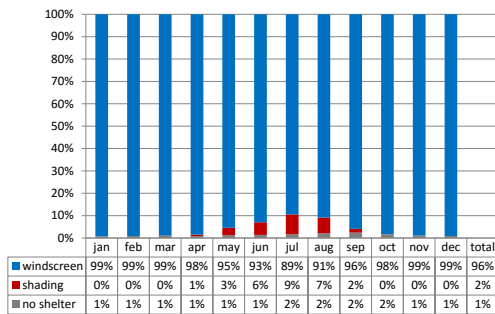


If a windscreen is combined with solar shading, the amount of comfortable hours doesn't change compared to applying just the wind screen and the hours of overheating are 8% for the years of 1980 to 2012 and 2% for the climate scenario of 2050 W+ which still means an increase of 300% in the recorded years opposed to the unsheltered environment; however the hours with underrun also increase again by approximately 5% (87% for 1980-2012 in de Bilt and 89% for 2050 W+ (see Table 2.8)).

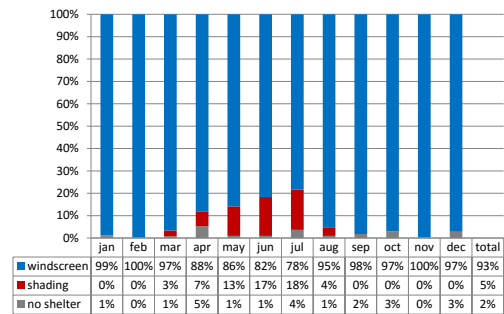
### Optimizing the outdoor thermal environment using adaptive shelter

---

Preconditioning of the outdoor thermal environment to create as optimal circumstances as possible for the indoor thermal environment by applying and controlling the amount of shading and windscreen in an optimal way should lead to the same low value for exceeding as for PET with shading and to at least as low value for underrun as with the PET with the windscreen, resulting in the highest number of comfortable hours. Figure 2.10 shows the distribution of measures in percentages of time per month to be taken to create the thermal environment closest to thermal comfort.



1 1980-2012



2 2050 W+

FIGURE 2.10 Distribution of measures to be taken to optimise urban thermal comfort for every month of the year for the adaptive PET

As noted in the previous section and confirmed by Figure 2.10 mostly protection from cold is needed in the Netherlands. The vast majority of hours a windscreen should be applied and a small amount of time shading should be applied and an even smaller amount of hours no shelter is needed. In the test reference year during 93% shelter from the wind is needed and only during 5% of the year shading is needed.

DE BILT 1980 - 2012											
Comfort state	No shelter		Shading		Windscreen		Full shelter		Adaptive shelter		
	%	dd	%	dd	%	dd	%	dd	%	dd	
exceeding	2	18	0	0	13	403	8	144	0	0	
comfort	2	-	0	-	5	-	5	-	18	-	
underrun	97	5850	100	6302	82	4140	87	4317	82	4140	

TEST REFERENCE YEAR 2050 W+											
Comfort state	No shelter		Shading		Windscreen		Full shelter		Adaptive shelter		
	%	dd	%	dd	%	dd	%	dd	%	dd	
exceeding	2	38	0.4	3	8	187	3	31	0.4	3	
comfort	5	-	1	-	8	-	8	-	16	-	
underrun	93	4767	98	5167	84	3960	89	4179	84	3951	

TABLE 2.8 Exceeding, comfort and underrun in percentage of hours (%) and degree-days (dd) for the different forms of shelter

Table 2.8 shows that the improvement for the adaptive variant is a combination of the improvement for underrun by a windscreen and the improvement for exceeding by shading which was predicted at the beginning of this section.

The need for heating can be decreased leaving approximately 25% less underrun in degree-days; from 5850 to 4140 in the recorded years and from 4767 to 3951 in the test reference year. In the scenario of the test reference year 2050 W+ the hours of

comfort can be increased from 5% to 18% of the year. This is a vast improvement. The degree-days for underrun in the climate scenario of 2050 W+ are even slightly lower for the adaptive variant compared to the variant with the windscreen although hardly significant.

Furthermore, [Table 2.8](#) shows that there is virtually no overheating left which leads to the conclusion that the overheating occurring in dwellings is due to the trapping of heat from incoming solar radiation and internal gains.

The analysis in this section tell us, that just optimizing this filter for sun and wind will bring the boundary conditions of the weather significantly closer to the comfort temperature and applying the same mechanisms in a building could reduce the energy demand for thermal comfort. Designing the building carefully will never have to lead to increase of the underrun nor the exceeding degree hours compared to these boundary conditions. In the next chapter, a step further is taken and insulation and airtightness (reduced infiltration and controlled ventilation) is introduced and regarded in the same way to gain the optimal filter for the thermal climate before applying energy.

---

## § 2.5 Conclusions

---

The information about variability and dynamics of the weather and the occupant can be regarded in much more detail than happens nowadays. One of the reasons why the information is regarded in averages is because most aspects to be controlled for spatial layout and materialisation are fixed anyway so an optimum during the whole year must be sought. For this averages are sufficient. However, if as in this thesis extra energy saving and thermal comfort is pursued by making otherwise fixed or semi-fixed building characteristics optimally dynamic it is required to regard the information of the controlling aspects of the thermal heat balance in more dynamic detail.

### § 2.5.1 Occupant

---



Analysis of the population for vulnerabilities and preferences together with time use studies, teaches us that comfort demand profiles can differ significantly in occupancy patterns and also the preferences for temperature. Most important differences in this research will be the occupancy of the rooms because these determine the comfort demand in time and space.

### Occupancy profiles

By recognizing the differences in occupancy patterns it becomes possible to design adaptive systems to be able to deliver the comfort demanded only when and where necessary in different occupancy scenarios. This is an opportunity to achieve a significantly better energy performance. In PART 2 of this research the influence of the different comfort demand profiles on the performance of the Adaptive Thermal Comfort System will be researched and the influence of occupancy on the energy saving potential of the Adaptive Thermal Comfort System.

### Comfort temperature

Because of the differences in vulnerability for the thermal environment between groups the emphasis of the Adaptive Thermal Comfort System should be to facilitate the occupant to create his own environment fitting to its current activities within certain bandwidths concerning energy consumption rather than controlling the setpoint to a rigid temperature as in the office environment. This shifts the focus from an actual comfort temperature to a range of temperatures likely to be demanded and their variability and bandwidth as well as the time and place of demand and this can help lower the energy demand for thermal comfort.

## § 2.5.2 Weather

---



### Patterns and weather swings

Besides clearly definable yearly and diurnal patterns in ambient temperature of mildly cold winters with an average temperature of around 5 °C and agreeable summer averages of 20 °C in august the deviations of these averages can be considerable. Above all, the comfort experience can vary a lot because of the strong cold winds and variability of solar radiation. Regarding the PET extremes of below -10 °C in a winter night occurring 10% during the winter months and above 30 °C occurring 10% of the summer months of the hours in the last 30 years cannot be ignored. A normal variation for the mean temperature in a bandwidth of 10 °C within a month for the PET can be expected.

Step changes are part of Dutch weather, especially day-to-day differences in weather are prominent and could have a significant influence on the heat balance of the building. Therefore, the systems should be flexible and able to switch swiftly; however, the temperature swings from day to day need to be dampened by for instance thermal mass.

### **Cooling load**

In theory, if well designed a building should not need to overheat as confirmed by this section. The overheating that does occur in practice is the result of trapping the heat accumulated by internal heat gain and solar radiation as a result of insulation, minimisation of ventilation and thermal mass. Ensuring enough ventilation in the summer season to discard the excess of heat and keeping out the solar radiation should be able to create an indoor temperature almost equal to the outdoor ambient temperature which in 99% of the hours will be below the maximum temperature for thermal comfort. Furthermore, during the remaining time of overheating the air movement created by the ventilation can provide an extra cooling effect.

### **Heating load**

The need for heating can be significantly decreased leaving approximately 25% less underrun in degree-days if there is an optimal use of the sun combined with windscreens. An adequate building intrinsically provides shelter from wind so in practice the wind should not negatively influence the comfort indoors in the heating season by draft. However, if the building is not sufficiently airtight the heat loss by infiltration can significantly increase with high wind speed.

### **Future climate**

In the future climate scenario developed by TNO (NEN\_5060, 2008) the heating load is expected to decrease with around 20% and the cooling load or overheating will likely be more than doubled; however this will still be a fraction of the time not resulting in a climate with a need for active cooling.

# 3 Adaptive Opportunities for thermal comfort systems in dwellings

---

## § 3.1 Introduction

---

The previous chapter described the external factors that influence the thermal heat balance of the building and the way dynamic information about these external factors can be obtained to improve the level of detail in information about supply of thermal energy by the outdoor thermal environment and thermal comfort demand by the occupant and how these two aspects can be combined to determine the influence on the indoor thermal environment by the control system of the Adaptive Thermal Comfort System.

This chapter describes a literature review to determine which possibilities for adaptivity are usual in practice and which improvements and new techniques can be implemented to increase these possibilities for adaptivity of the Adaptive Thermal Comfort System. Research questions will be defined for chapter 4 and 5 how to use this adaptivity of the elements. Furthermore, this chapter describes common practice in comfort delivery and their opportunities to improve adaptivity of these aspects.

---

## § 3.2 Research Design

---

### § 3.2.1 Problem statement

---

To create and Adaptive Thermal Comfort System, current knowledge of the ways to provide thermal comfort and to **dynamically adapt** building settings to provide comfort **only where, when and at the level needed** by the user, while **harvesting the energy delivered naturally** when available and determine opportunities for improvement of the current techniques and openings for development of new concepts to dynamically adapt these settings.

## § 3.2.2 Research questions

---

**What adaptive techniques for a thermal comfort system (the whole of passive and active components of the building that influence the indoor thermal environment) of a dwelling are now available and which opportunities for improvement and development of new techniques are there?**

---

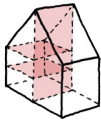
## § 3.2.3 Structure

---

A literature study is performed to map the state of the art in thermal comfort delivery for dwellings in the following sections, complemented with points of improvement for adaptivity and energy performance.

### Spatial layout (§ 3.3)

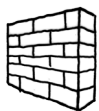
---



The various aspects of the spatial layout of the dwelling that influence the thermal environment which are very important to regard before designing the adaptiveness of the materialisation and the HVAC system are observed. These aspects will be taken into account in chapter 5 as preconditions to ensure the proper functioning of the Adaptive Thermal Comfort System. Additionally, adaptive opportunities to be researched for these aspects in the future are given.

### Materialisation (§ 3.4)

---



Current practice of materialisation of the dwelling to beneficially influence the thermal environment indoors without applying energy are described and the current methods to adapt the characteristics of the building. Additionally the opportunities of improvement are given as well as chances to develop new concepts for adaptivity.

### HVAC (§ 3.5)

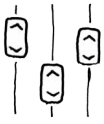
---



To correct the indoor thermal environment created by the weather and the building shell to fit the thermal comfort requirements of the occupants, HVAC systems are applied that use energy to influence the thermal environment. This section describes the current methods of the HVAC system to be controlled with the possibilities for improvement and new implementation of existing techniques.

## Control systems for thermal comfort systems (§ 3.6)

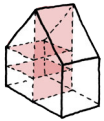
---



To correct the indoor thermal environment created by the weather and the building shell to fit the thermal comfort requirements of the occupants, systems are applied that use energy to influence the thermal environment. This section describes the methods of control of the thermal comfort system used and the necessity and methods to reduce the consumption of energy.

## § 3.3 Spatial layout

---



Much energy saving can be gained from “optimizing” the spatial layout and the building shell before the actual materialisation of the shell and installing the HVAC system. To optimally profit from the Adaptive Thermal Comfort System the spatial layout needs to be considered for the influence on the performance of the adaptive measures for materialisation and HVAC.

Furthermore, the design can improve the awareness of the outdoor thermal environment experienced by the occupant which benefits the comfort experience and health as described in § 2.3 (Healy, 2008).

### § 3.3.1 Adaptiveness of the spatial layout

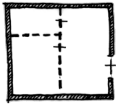
---

Making the spatial layout dynamic can be very labour intensive in the user phase because sometimes large building parts need to be moved and they can have high investment costs because of their complexity and amount of material needed. Furthermore, they are so design specific that it is a whole different field of research to determine the effects of these adaptive solutions; therefore, this will not be the scope of this thesis and this section will not produce research questions. However, there are many possibilities to do so and developing these possibilities to make them more lucrative can certainly enhance the concept of an Adaptive Thermal Comfort System; consequently, to be complete some implementations of the solutions are briefly described and examples in practice are given which are illustrations of thinkable scenarios for adaptive design. It should be noted that most examples influence more than one aspect of spatial layout.



## Partitioning

---



In recent history in the Netherlands many homes were built with a living space with en-suite separation doors (Figure 3.1). Those were often used to reduce the space to be heated in winter and in summer the doors can be left open to support cross ventilation. This technique can be used for different kind of rooms. Even the whole dwelling could be designed to be able to remove walls and doors.

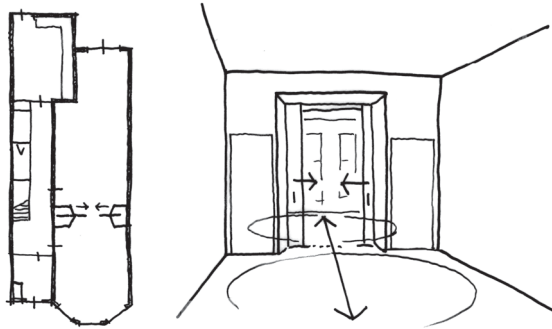


FIGURE 3.1 En-suite separation from 1920

## Flexible and multiple space use

---



The separation of the living space into two oppositely oriented rooms also gives the opportunity to swap the room functions from summer to winter, which creates flexible space use. An example of a flexible floor plan is the Rietveld Schröderhuis (Figure 3.2). This house can change from day setting to night setting, mainly designed to save space. However this principle could also be used to adapt to the changing climate or comfort demands. This solution is a combination of partitioning and multiple space use. To be able to switch functions rapidly some furniture can be made flexible as well. The flexible space layout can influence the air volume (D.1), the orientation (D.2), shell surface (D.3) and the ventilation design (D.4) of the function if one function can take place in more than one space.

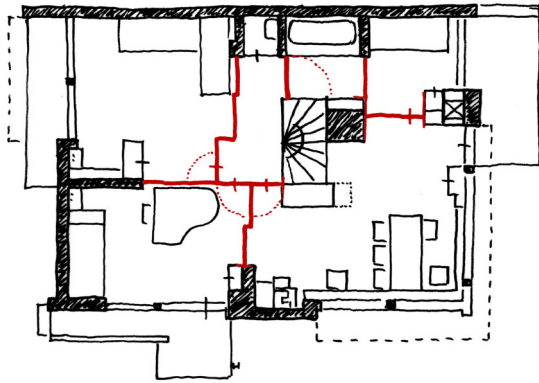


FIGURE 3.2 Rietveld Schröderhuis day and night layout and the kitchen (redrawn from (Rietveld, 1888-1964)

The use of multiple spaces with thermal diversity is researched in the book *Environmental Diversity in Architecture*, Chapter 12 (Merghani, 2004). The advantage of this multiple space use above the former mentioned flexible space use is that no conversions of furniture or moving around with doors and panels is required; however, the disadvantage of is that it takes a lot of space, which can be a problem in an urban environment. Figure 3.3 shows an example of a floor-plan of a vernacular house which allows the occupants to use multiple outdoor spaces for the same activities during the course of the day (Merghani, 2004).

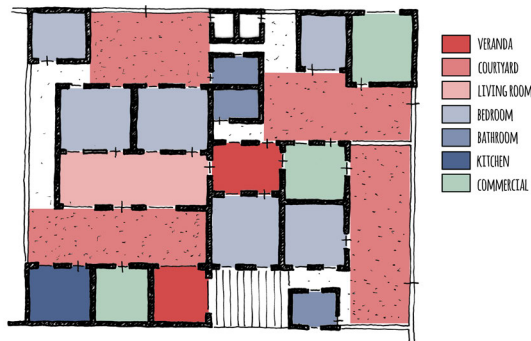
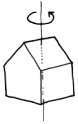


FIGURE 3.3 Example of a floor-plan with a large diversity in thermal environments, used in study for thermal comfort and spatial diversity (Merghani, 2004)

## Revolving structures



To change the orientation of the spaces relative to the sun without having to change room the house should be able to rotate. There are some experimental designs that incorporate this technique, as the Everingham Rotating House, designed and built by Luke Everingham in Australia (Figure 3.4) (Everingham, 2014). This technique is expensive and the possibilities are limited in high density residential areas.

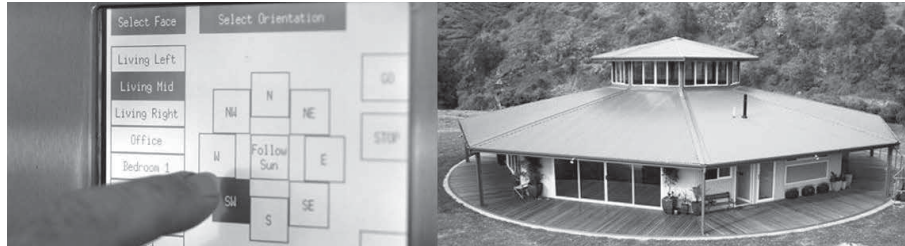
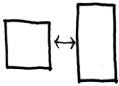


FIGURE 3.4 The Everingham Rotating House (Everingham, 2014)

## Surface to volume ratio



The geometry of the building shell can change, however not without affecting the volume of the indoor space. A closable patio or sun-space (Figure 3.7) can change the ratio between the surface of the external separation and the volume of the conditioned space. However, chances are the occupants will permanently use the pace as indoor space.

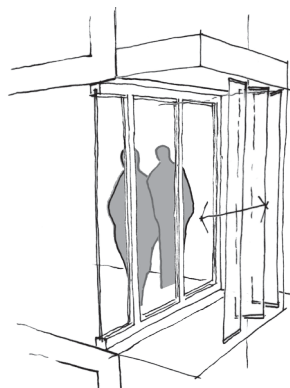
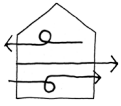


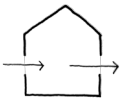
FIGURE 3.5 Closable balcony/sun-space

## Airflow propagation



The organisation of spaces and openings greatly determines the airflow through the building and this can be used to enhance possibilities for natural ventilation. There are several techniques that allow the spatial layout to influence the airflow through the building. By opening and closing openings the capacity of the ventilation can be controlled. Obstructions should be carefully considered. Three main principles can enhance the airflow;

### Cross ventilation:



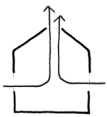
The circulation or flow of air through openings, such as doors, windows, or grilles, that are on opposite sides of a room (Online Dictionary of construction (WebFinance, 2016)).

Cross ventilation is the simplest way of ensuring a significant air flow and occurs where there are pressure differences between one side of a building and the other. The preconditions for cross ventilation are listed in Table 3.1. The cross-ventilation can be adapted by adaptive partitioning and adjusting the orientation by revolving structures.

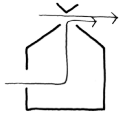
CROSS VENTILATION	
precondition	limitation
narrow building	limited space
wind exposed site	low density building
perpendicular to prevailing wind direction	may be conflicting with solar orientation less effective with variable wind directions
no internal barriers to obstruct air flow	limited in (fixed) partitioning
regular distribution of openings	limitations to façade design
openings on opposite sides of building	limitations to façade design

TABLE 3.1 preconditions for cross ventilation and limitations to spatial layout

### Stack effect (Chimney effect)



The process by which air, when heated, becomes less dense and rises. The rising gases in a chimney create a draft that draws in cooler gases or air from below. Stairwells, elevator shafts, and chases in a building often draw in cold air from lower floors or outside through this same process (Online Dictionary of construction (WebFinance, 2016)).



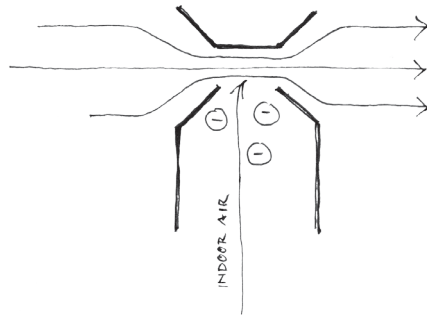
### Bernoulli and Venturi effect

The Bernoulli principle states that an increase of speed in a fluid (gas or liquid) causes a decrease in static pressure of that fluid. This principle was first published by Daniel Bernoulli in his book *Hydrodynamica* in 1738 ().

In a standard chimney the wind flowing over the opening will cause this under-pressure by the Bernoulli principle producing suction of the indoor air increasing the ventilation of the building ().

Named after physicist Giovanni Venturi (1746-1822), the Venturi effect refers to the increase in velocity of a fluid as it travels through a restricted area. As the fluid reaches the restricted area (throat) the velocity increases based on the principle of continuity (Technical Notebook: The Venturi Effect (Roberts, 2014)).

A Venturi shaped chimney exit increases the air speed through the chimney by increasing the Bernoulli effect and thus the ventilation. To increase the effectiveness of the Venturi effect the venturi shaped cap can be made to revolve in the direction of the wind (Figure 3.6).



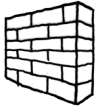
1 Principle of venturi shaped chimney exit



2 Application of venturi cowl rotating in wind direction; BedZED development in South London by the ZED factory (2002)

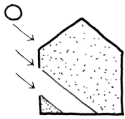
FIGURE 3.6 Venturi shaped chimney exit; principle and application

## § 3.4 Materialisation



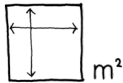
The main function of a building is to partly separate a space from the outdoors by a barrier or filter to create a (controllable) micro-climate appropriate for human beings to reside and develop activities. The characteristics of the filter determine which part of the outdoor climate is allowed in or rejected. There are numerous factors of the buildings materialisation that affect the thermal heat balance.

### § 3.4.1 Adaptive solar gain



The amount of incoming energy should be regulated deciding whether to use the incoming energy, store it or to discard it. Therefore, the first step is to determine the influence to be exerted on the solar energy that can enter the room. Before designing the adaptive solar gain control the following aspects need to be considered;

#### Surface area of separation construction



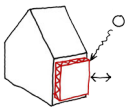
The surface area of the separation construction needs to be determined; the larger this surface, the more solar radiation can be harvested and thus the larger the range for control is.

#### Orientation

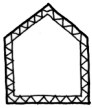


The orientation is very important for the effectiveness of the system, as the amount of solar radiation can vary from almost none to maximal. In this aspect both the horizontal orientation as the inclination is important (§ 5.3.6 & § 6.4.4).

#### Glass percentage



Maximizing the glazed area of the separation construction can have great influence on the thermal insulation of the building. The known transparent construction parts have a lower insulation value than opaque parts. This means that the glass percentage of the orientations with least solar radiation and thus least potential of harvesting solar heat must be considered to be low and the orientations with high potential solar gain can have a maximised transparent area (§ 5.3.6 & § 6.4.4).



## Insulation

Changes in U-value can occur while changing the solar factor. This influence is highest using movable insulating panels.

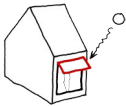
### § 3.4.1.1 Adaptive opportunities for solar gain control

---

Depending on the orientation of the windows the amount of solar radiation entering the room as heat can be easily controlled. There are many techniques available and in development which can be categorised in three categories, with different solutions. Some possibilities to control the solar gain and some innovative designs and solutions are described to illustrate the vast range of possibilities to bring the techniques into practice. In practice the solar factor will always be below 1 because transparent separations will always block some of the radiation. Usually well insulated glass has a G-value of around 0.6; however, developing transparent material with higher G-values and with good insulation properties can save heating energy (§ 5.3.4). It should be noted that with insufficient solar shading this can lead to overheating instead.

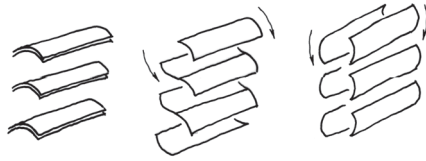
#### Adapt the area of incidence on the glass (solar shading)

---



The most common way of controlling the incoming solar heat is by controlling the area of incidence on the windows by traditional operable solar shading on the **outside of the façade**. There is a variety of products on the market of which the most important feature for the Adaptive Thermal Comfort System is that it is controllable and possible to be automated and every day more products are being developed. Depending on the placement of the shading compared to the glass plane (parallel or non-parallel) the solar radiation can be fully blocked while impairing the vision outdoors or just blocking the beam radiation conserving the vision out.

The “Resolver” designed by students of the TU Delft shows an advanced possibility to implement solar shading that is highly adaptive with a variety of settings for all kinds of different situations (Figure 3.7).



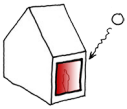
1 principle Resolver



2 Visualisation Resolver

**FIGURE 3.7** Resolver; concept of solar shading for Bucky Lab, TU Delft; Kiros Abdalla, Jeroen ter Haar, Robert van Houten (Bilow, 2015)

## Adapt the transparency of the glass



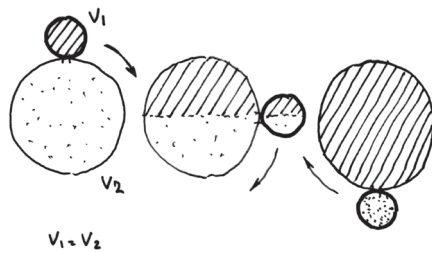
### Glass with coatings

In advanced practice coatings are used to adapt the transparency of the glass. In the cavity between two glass panels of the glazing, a coating can be applied that can change its transparency by means of heat (thermo-chromic), light (photo-chromic) or an electric current (electro-chromic) (Granqvist et al., 2009). Only the electro-chromic coating can be controlled by the Adaptive Thermal Comfort System Control System, the first two are Climate Responsive. The advantage of this system is that it is not vulnerable to mechanical damage and there is virtually no influence on the architecture. The range of  $f_{sol}$  however, is not so large due to the large influence on the entrance of visible light and the characteristics of the coatings. Recent research is performed on a new kind of polymer that to an extent can change the transparency for visible light and infrared light separately by selectively blocking a specific range of wavelengths by applying a specific voltage to the glass (Llordes et al., 2013).

### Using fluids

Another way of adapting the transparency of the glazing is using a coloured liquid to fill and drain the cavity between two glass panels which is implemented by students of the TU Delft in the concept called “Liquid Shading” (Figure 3.8). This concept uses two fluids with different densities, a reservoir to temporarily store the fluid. Turning the window will either put the reservoir up leaving the fluid with lower density in the reservoir or down leaving the fluid with the higher density in the reservoir. In this example the vision through the window is influenced by the colour of the fluid and the movement and the refractive index of the fluid.





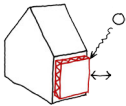
1 principle Liquid Shading



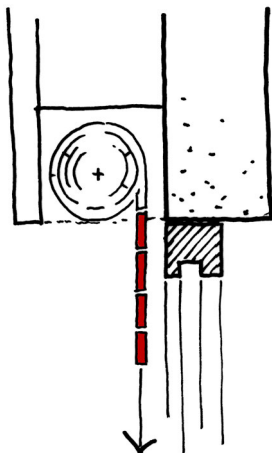
2 Visualisation Liquid Shading

**FIGURE 3.8** Liquid Shading: concept for adapting the transparency of the façade by using fluid replacement for Bucky, Lab TU Delft; Maurice Ridder, Vincent van de Aardeweg, Marc Nicolai

### Adapt the glass percentage of the façade



This concept uses the assumption that the ratio opaque insulated façade to transparent (less insulated) can change. This implies that the composition of the façade can change. A relatively easy way to do so is using insulated panels or shutters. (Figure 3.9) As the name implies, these have an effect on the insulation value as well (see § 3.4.3). because these are movable parts they cannot be too big and heavy. Therefore the thermal resistance is limited.



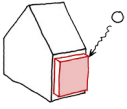
1 Principle of a thermal shutter



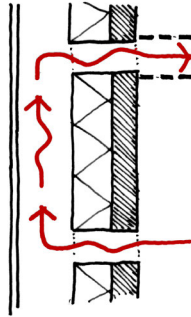
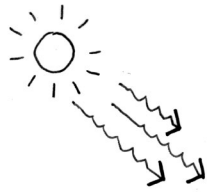
2 Visualisation of a thermal shutter

**FIGURE 3.9** Application of thermal shutter (photograph (Menk, 2015))

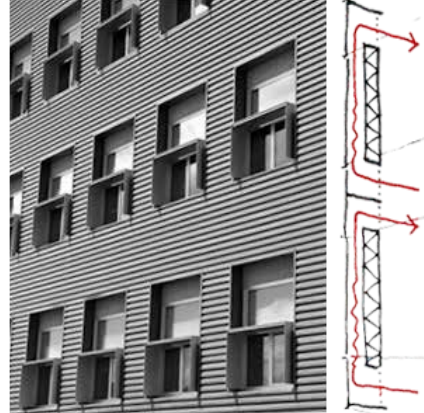
## Collector walls and roofs



There is also a possibility to make non-transparent parts of the façade to collect solar radiation and directly or indirectly using it for room heating. One well known example is the Trombe wall which collects the solar radiation in a thermal storage wall regulating the access of the heat to the room with ventilation (Figure 3.10). This principle is also commonly applied in transparent variants e.g. double skin façade.







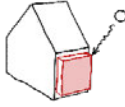


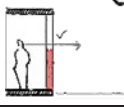


1 principle collector wall / roof



2 Application of collector wall (in opaque façade parts) RNEL (DeFreitas, 2010)

FIGURE 3.10 Collector wall principle and application example

Table 3.2 shows a summary of the characteristics of the described techniques that are important for implementation in the Adaptive Thermal Comfort System. The last column shows the preferences for adaptiveness and general preferences for application.

		irradiation	area of incidence	transparency		panels	collector
							
			conventional solar shading 	electronically controlled coatings 	liquids 	outdoor thermal hatch or panel 	collector walls or roofs 
adaptivity and control	switch	C	D / C	D / C	C	C	
	automation	moving parts	electric current	?	moving parts	air flow	
	control parameters	$T_{i}; T_{c}; q_{rad}$	$T_{i}; T_{c}; q_{rad}$	$T_{i}; T_{c}; q_{rad}$	$T_{i}; T_{c}; q_{rad}$	$T_{i}; T_{c}; q_{rad}$	
	transparency (G)	-	0.1 - 0.4	?	-	-	
	shading factor ( $F_c$ )	0 - 1	-	-	0 - 1	-	
	solar factor ( $f_{sol}$ )	$F_c \cdot \text{glass \%}$	$G_c \cdot \text{glass \%}$	$G_c \cdot \text{glass \%}$	$F_c \cdot \text{glass \%}$	$0 - \eta \cdot A_c / A_f$	
implementation	influence on transmission	-	-	possible	v	possible	
	auxiliary energy	moving parts	automation	pumps; moving parts	moving parts	fans; vents	
	space use	outside façade	-	pumps; moving parts	outside façade	in façade; fans	
	vision	blocking	altering colour	altering colour	blocking	-	
	architecture	façade design	-	façade design	façade design	façade design	
	vulnerability	mechanical damage	low	mechanical damage	mechanical damage	low	

- not applicable

v applicable

? unknown

C Continuous

D Dichotomous (ON / OFF)



applied in (common) practice

technique available; to be implemented (more)

to be developed

TABLE 3.2 Information table for the properties of techniques to vary the solar gain

### § 3.4.1.2 Improvements for solar gain control

---

Based on [Table 3.2](#) the following improvements can be made to these techniques.

#### **Control and automation**

All options for control of the solar gain should be able to be controlled and automated according to the heat load of the room. As with shading products there are many products on the market for control of shading; however, the implementation can leave much to be desired (Wienold, 2007; Meek & Brennan, 2011; Hashemi, 2014; Hoffmann et al., 2016). Therefore, care should be taken that the control algorithms are appropriate, the moving parts are least vulnerable for mechanical damage and that the nuisance to the occupant is minimised.

#### **Vulnerability and cost**

Especially the techniques with (heavy) mechanical parts are vulnerable to mechanical damage by wind or vandalism and usually shading systems are costly, the more if they are automated. Further development of these products might be needed to make implementation feasible. Coatings and fluids to control the transparency could be a promising concept to be developed further because of the relatively simple techniques with little or no moving parts.

#### **Visual comfort**

Solar shading can have a large impact on the visual comfort and can alter the colour of the view or totally block the view, which needs to be kept in mind. New techniques to be developed can be considered to disconnect the properties of visual transparency and solar gain.

#### **Range**

The possibility in range for the shading factor of the controllable shading is maximal with 0 to 100% shading. The control of transparency with available coatings is smaller; however, the development of new polymer coatings (Llordes et al., 2013) could change this.

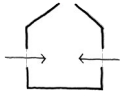
New techniques to be developed to increase the solar gain can include panels to increase the area of incidence (solar collectors integrated in the facade) and materials that actively conduct the heat from the radiation hitting the surface of the facade.

#### **Auxiliary energy**

All solutions besides the coatings need a motor to automatically operate the system. This is something to be taken into account when improving and developing products. Solar shading can be combined with PV cells to use the blocked solar radiation for electricity generation, which can be used to operate the shading.

## § 3.4.2 Natural ventilation

---

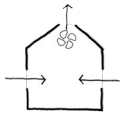


Natural ventilation indicates the process of supplying and removing air through an indoor space without using mechanical systems and it usually excludes the involuntary ventilation through unpredictable cracks in the construction called infiltration. In practice always some infiltration needs to be considered because it is impossible to make the structure completely airtight. However, the more airtight the construction is, the more control can be applied to the natural ventilation.

Natural ventilation can be used for passive cooling as commonly used in non-residential buildings often as night-ventilation. In the residential sector usually operable windows are present that can be manually operated for cooling. However, manual window operation is not possible during absence and can be erratic and is not necessarily beneficial for the indoor temperature and energy consumption (Andersen, 2009). This application can be extended to automated use in the residential sector.

### Natural supply and mechanical exhaust

---



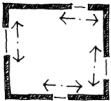
This system is commonly used because the incoming ventilation can be controlled by the exhaust ventilation flow. Relatively small and short ducts can be used and heat recovery can supply heat to pre-heat the domestic hot water.

## § 3.4.2.1 Adaptive opportunities for natural ventilation control

---

### Placing of operable exhaust openings

---

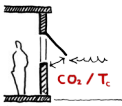


Natural exhaust is not common in newly built homes, because it is very dependent on wind pressure and temperature differences between indoor spaces and the outdoor. To ensure the right amount of ventilation to deliver fresh air this is considered too volatile. However, this can be a good technique to increase ventilation during a need for heat discarding. In this case, the placing of the openings is crucial to create sufficient air flow. The book *Sun, Wind and Light* (Brown & DeKay, 2000, p. 242) gives a table about the placement of openings and their effect on the air velocity relative to the wind velocity  $45^\circ$  to the opening (Table 3.3).

AVERAGE INTERIOR AIR VELOCITY			
window height as fraction of wall height	1/3	1/3	1/3
(total) window width as fraction of wall width	1/3	2/3	3/3
single opening	12% - 14%	13% - 17%	16% - 23%
two openings in the same wall	-	22%	23%
two openings in adjacent walls	37% - 45%	37% - 45%	40% - 51%
two openings in opposite walls	35% - 42%	37% - 51%	47% - 65%

TABLE 3.3 Average interior air velocity as a percentage of the exterior wind velocity (range = wind 45° to perpendicular to opening) (Brown & DeKay, 2000, p. 242)

### Controlling the ventilation openings



Electronically controlled registers are available and they are combined with the control of the exhaust fan to create an airflow on demand. In practice this demand is usually determined by the minimum amount of ventilation required for fresh air and can be determined by measuring CO<sub>2</sub> levels that mark the amount of pollution to be removed by the ventilation air (Fisk, 1998). This system is commonly applied for saving energy in the heating season. For the Adaptive Thermal Comfort System this system can easily be extended by a control mechanism that incorporates temperature as a parameter to be controlled. Openings can be increased when heat needs to be discarded to passively cool the space. In the same fashion larger openings like windows can be controlled. This extra ventilation can be enhanced by extra capacity of the extraction fan but if the openings can be large enough and the layout of the building allows it this might not be necessary for the required ventilation rate.

### § 3.4.2.2 Improvements for natural ventilation control

#### Control and automation

The existing techniques for control and automation can be improved to be controlled not only for fresh air but also for automated temperature control, which is not usually applied in the residential sector.

#### Range

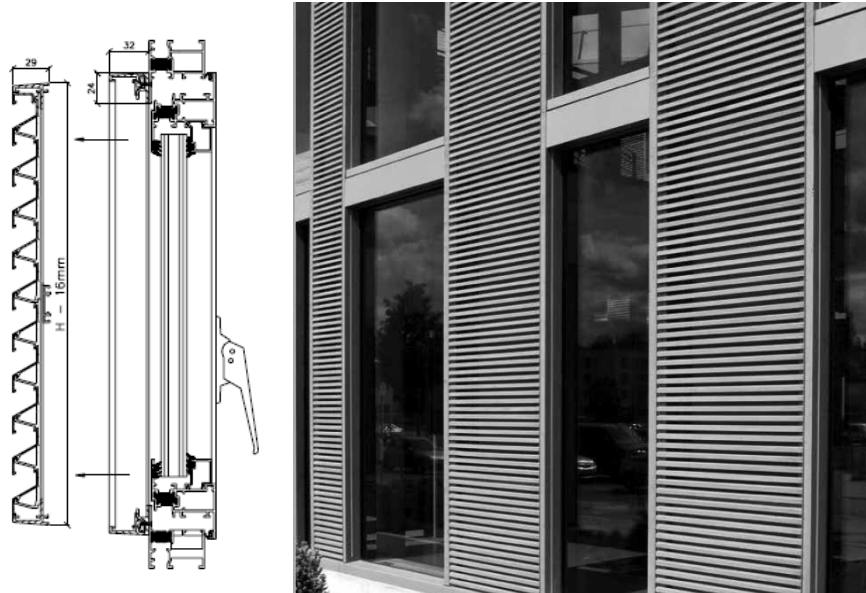
The possible range of heat transfer by ventilation is very large compared to the range for heat transfer by transmission. Per air exchange of the room per hour a  $H_{tot}$  of 0.33 W/K per m<sup>3</sup> of room volume. However, the nuisance of draft should be avoided and therefore the placement of the openings should be carefully chosen and preferably high in the wall so the air velocity drops before reaching the habitable zone. Furthermore, aiding the extra natural ventilation supply by mechanical extraction could mean large ducts and high capacity extraction fans.

### Vulnerability and cost

Electronically controlled registers are widely used in practice and have proved their cost effectiveness and robustness. Larger controllable openings as windows should be designed robust and burglary proof with for instance protective grids. An example of larger ventilation openings are the openings used in the Healthy School Concept® by Renson (2014) shown in [Figure 3.11](#).

### Auxiliary energy

All solutions need a motor to operate the system. This is something to be taken into account when improving and developing products. PV cells on the façade (for instance on the solar shading as mentioned in [§ 3.4.1](#)) can be considered to be integrated directly into the controlled component for this purpose.



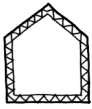
1 Technical representation

2 Application in Headquarters of Solon AG in Berlin (Schulte-Frohlinde Architekten)

**FIGURE 3.11** Example of burglary proof larger ventilation openings of the Healthy School Concept of Renson (2014)

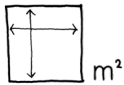
### § 3.4.3 Insulation

---



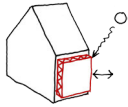
Insulation is the next aspect of the heat loss factor to be considered for this is the most difficult aspect to make adaptive and has the least bandwidth. It can be considered to fix the insulation value all together and therefore it is best to determine the insulation design to aid the more flexible ventilation. Before designing the insulation control the following aspects need to be considered;

#### Surface area of separation construction



The surface area of the separation construction needs to be determined; the possible  $H_{\text{tot}}$  and thus the range for control increase with the increase of the area of this surface.

#### Glass percentage



Maximizing the glazed area of the separation construction can have great influence on the thermal insulation of the building. The known transparent construction parts have a lower insulation value than opaque parts and changing the insulation value of the transparent parts can have direct influence on the solar gain and the view out (§ 3.4.1).

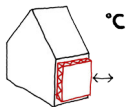
### § 3.4.3.1 Adaptive opportunities for thermal insulation

---

There are no examples of variable insulation in common practice. However, some experimental solutions are applied and there are scenarios that are or can be researched for future use. These concepts to make the U-value variable are described below. It should be noted that the range for the heat loss factor with adaptive ventilation is only around 10% from the range to be obtained by ventilation (§ 5.3.3).

#### Movable insulation

---



The most obvious way to change the insulation value of a separation construction is by removing and adding the insulation in one or more layers such as thermal shutters or removable panels. Thermal shutters however are nowadays mainly used to be placed in front of transparent parts of the façade (windows) and therefore also influence the solar factor ( $f_{\text{sol}}$ ). Usually they are applied during the night diminishing irradiation to the night sky. The effectiveness of the thermal shutters and their influence on the solar factor depends on the placement of the panels. They could also be placed in front of opaque separation constructions to enhance the thermal insulation.



### Gas or fluid replacement

---



°C

Gas or fluid filled panels can vary the U-value of the construction by inflating and deflating chambers with a gas or fluid. Depending on the used gas or fluid, the insulation value of the inflated panel can range from approximately  $R_c \approx 1 \text{ W/K}$  to  $R_c \approx 3$ . Stacking the panels can increase the total  $R_c$  value; however great care should be taken to minimise cold bridges at joints and fixtures. Some prototypes of examples for implementation have been developed (Louise, 2000; Buster, 2010; Al-Nimr et al, 2009). Horn et al. (2000) propose a “switchable insulation” by a metal hybrid that changes the  $H_2$ -gas pressure within a panel. In their simulations they show that the conductivity can be altered by a factor 50.

### Dynamic Insulation Material

---

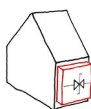


°C

There might be materials that change their heat resistance characteristics by for instance applying an electric current. At this moment there is no application in building practice of such materials known to the writer of this dissertation. However, in the clothing industry it is being applied, like a fibre material that expands in cold temperatures to allow more air into the fabric to insulate better (Durant, 2015). Furthermore an idea of a dynamic insulation material is described by Jelle (2010) as a future building material (beyond state-of-the-art).

### Bi-directional thermal diode

---



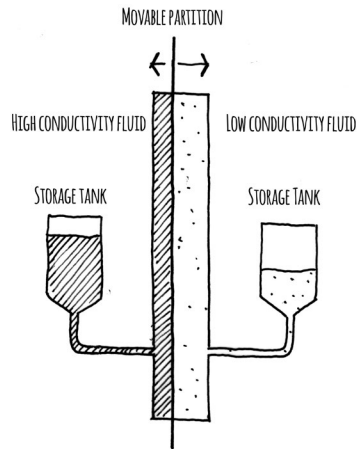
°C

Another way of influencing the heat transfer through a construction is applying the principle of a thermal diode. A diode allows the heat flow in only one direction and making it bi-directional allows the system to alter the flow direction. There are various ways of creating a bi-directional thermal diode and there are a few studies that propose methods to do so (Chun & Chen, 2002; Rylewski, 2005).

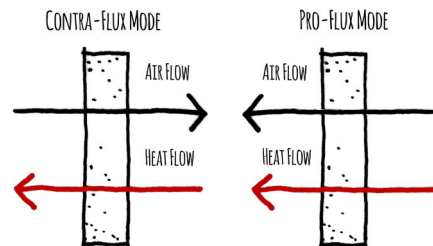
One other example of applying the principle of a thermal diode is by changing the permeability of the construction and the direction of the airflow through the construction, proposed by Baker (2003);

*‘The concept of dynamic insulation is to draw air from the outside into a building through air permeable insulation, thereby collecting heat usually lost to the outside by conduction. The insulation therefore acts as a counter-flow heat exchanger. This results in a characteristically curved temperature profile through the insulation, reduced conduction losses and a pre-heated ventilation air supply. The performance of the dynamic insulation can be characterised by a dynamic U-value, which is a function of the air velocity’*

The technique of dynamic insulation is in development and the performance needs to be researched more. The U-value range of the tested case by Baker (2003) is approximately  $0.1 \text{ W/m}^2\text{K}$  to  $0.26 \text{ W/m}^2\text{K}$ . It should be noted that the dynamic insulation is combined with the ventilation system by acting as a heat exchanger and thus directly influences the ventilation system.



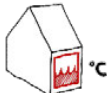
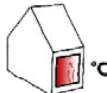
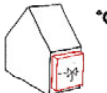

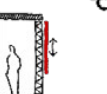
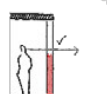




**FIGURE 3.12** Example of fluid replacement using two types of fluid and a movable partition (Al-Nimr et al, 2009)



**FIGURE 3.13** Bi-directional thermal diode by control of the airflow through the façade (Baker, 2003)

Table 3.4 shows a summary of the characteristics of the described techniques that are important for implementation in the Adaptive Thermal Comfort System.

		insulation	thermal shutters	gas or fluid	DIM	thermal diode
			 °C	 °C	 °C	 °C
			in front of opaque construction  °C	in opaque construction  °C	climate responsive materials 	dynamic insulation  °C
adaptivity and control	switch		D / C	D / C	?	D / C
	automation		moving parts	?	?	air flow
	control parameters		$T_i; T_e; T_c$	$T_i; T_e; T_c$	$T_i; T_e; T_c$	$T_i; T_e; T_c$
implementation	irradiation	-	-	possible influence	possible influence	-
	ventilation	-	-	-	possible influence	possible influence
	auxiliary energy	-	moving parts	pumps; moving parts	?	fans; pumps; moving parts
	space use	-	storage panels	pumps; moving parts	?	fans; pumps; moving parts
	vulnerability	-	mechanical damage	pumps; moving parts	?	fans; pumps; moving parts
	architecture	-	façade design	façade design	façade design	façade design

- not applicable

v applicable

? unknown

C Continuous

D Dichotomous (ON / OFF)



applied in (common) practice

technique available; to be implemented (more)

to be developed

TABLE 3.4 Information table for the properties of techniques to vary the insulation

### § 3.4.3.2 Improvements to insulation control

---

Based on [Table 3.4](#) the following improvements can be made to these techniques.

#### Control and automation

All options for control of the insulation should be able to be controlled and automated according to the heat load of the room. This means that the control system needs an accurate control algorithm which can anticipate the need for admitting or discarding solar radiation keeping into mind the user aspects (perceived usefulness and use of control, avoiding visual and auditive nuisance), described in [§ 3.6](#).

#### Vulnerability and cost

Especially the techniques with (heavy) mechanical parts are vulnerable to mechanical damage by wind or vandalism and usually shading systems are costly, the more if they are automated. This is a very important aspect to be considered when developing the new techniques. Coatings and fluids to control the transparency could be a promising concept to be developed further because of the relatively simple techniques with little or no moving parts. However, the newly developed coatings can be costly in the beginning.

#### Range

Much is still unsure about the range of thermal insulation of the new products. However, this is a very important aspect to be considered and should be compared to the range obtainable by ventilation control. The total  $H_{\text{tot}}$  depends on the total surface area of the separation construction to the room volume and the U-value. Higher ranges can be reached with large surface to volume ratio; however this can compromise the energy conserving possibilities in winter.

#### Auxiliary energy

The use of auxiliary energy is still very uncertain. Together with the range and total installation cost this should be incorporated to make a cost and effect analysis.

### § 3.4.4 Thermal mass

---



Because the influence of the thermal mass on the temperature fluctuation and thus on the effectiveness of the adaptive measures it is important to determine the strategy for thermal mass available in the Adaptive Thermal Comfort System consistent with the techniques for the variation of the solar factor, the heat loss factor and the heating system. Besides making the thermal mass flexible, it is also recommended making choices about the level of thermal mass if fixed.

### § 3.4.4.1 Adaptive opportunities for thermal mass

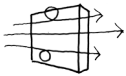
---

The thermal capacitance can be varied in a few different ways. P.J. Hoes (2014) has done a PhD research at the University of Technology in Eindhoven about Hybrid Adaptive Thermal Storage (HATS). Two concepts to make the thermal capacitance adaptable with possible implementations from the thesis of P.J. Hoes are described below; adapting the heat transfer to the thermal mass and adapting the capacity of the thermal mass.

#### Adapting the heat transfer towards the thermal mass

---

##### Convection



Convection can be easily adapted by using fans to increase or decrease the airflow along the thermal storage medium and can be combined with the (conventional) ventilation. A concept that is used in common practice is night ventilation with or without a lowered ceiling.

##### Radiation



Changing the radiation between the room and the storage medium can be done by introducing an adaptable intermediate layer. The mechanisms to change the radiation of this intermediate layer are the same as for adapting the solar factor ( $f_{sol}$ ) in described in § 3.4.1. Another way of changing the heat transfer by radiation is to apply a coating on the thermal mass that can alter the absorption coefficient (e.g. colour change from black to white), which is a concept that could be researched to be developed by nano technology or material science.

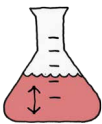
##### Conduction



Changing the conduction between room and storage medium requires an intermediate layer between the two. The solutions to change the conduction are the same as for adapting the transmission to influence the  $H_{tot}$  of the building as described in § 3.4.3.




#### Adapting the capacity of the thermal mass

---



The capacity of the thermal mass is the product of mass [kg] and the specific heat capacity [J/kg·K]. This means that the thermal capacity can be changed by altering the mass of the storage medium or altering the specific heat capacity. The most feasible solution is to change the mass of the storage medium for instance using fluid in the storage element which can be removed and replaced (changing the volume of the available storage). A commonly used example of this technique is concrete core activation but P.J. Hoes gives more options to change the thermal capacity in his thesis.

Table 3.5 shows a summary of the characteristics that are important for implementation in the Adaptive Thermal Comfort System.

		thermal mass	storage capacity	heat transfer to storage		
						
adaptivity and control	switch	C	C	?	?	
	automation	liquid flow	air flow	intermediate panel	intermediate panel	
	control parameters	$\Delta T$	$\Delta T$	$\Delta T$	$\Delta T$	
implementation	auxiliary energy	pumps	fans	switch panels	switch panels	
	space use	core; storage tank	storage; fans	storage; panels	storage; panels	
	vulnerability	pumps / pipes	fans / pollution	see solar factor	see insulation	
	architecture	solid core	solid core	intermediate panel	intermediate panel	

- not applicable

v applicable

? unknown

C Continuous

D Dichotomous (ON / OFF)



applied in (common) practice

technique available; to be implemented (more)

to be developed

TABLE 3.5 Information table for the properties of techniques to vary the thermal mass

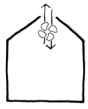
## § 3.5 HVAC



The active comfort system is formed by the HVAC in a dwelling. Operating these aspects adaptively it is possible to apply energy only when and where needed. Therefore, most equipment should be operated and applied locally, temporarily and at optimised power to obtain an Adaptive Thermal Comfort System. For **all HVAC components** in the Adaptive Thermal Comfort System it is **important** to be **fast** in reaction time and effect on the thermal environment as well as the possibility to be applied **locally**. In this section categories for HVAC are briefly elaborated.

### § 3.5.1 Mechanical ventilation supply

---

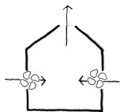


Mechanical ventilation supply has some great advantages for the Adaptive Thermal Comfort System because it is a system with a high level of control. By tuning the fans and valves of the system the right amount of ventilation can be carefully realised both locally as fast. Furthermore, a fully mechanical ventilation system can save a vast amount of energy for heating by applying a heat recovery system to pre-heat the ventilation air with the heat from the exhaust air that otherwise would be lost. Residential heat recovery systems can have nominal efficiencies of up to around 90% (presented by the manufacturer running on specific settings); however, depending on the actual circumstances (air flow rate, exhaust air temperature, setpoint temperature, outdoor air temperature) in practice the efficiencies are much lower with an average of around 70% (Merzkirch et al., 2016).

One of the biggest disadvantages is that the equipment can be expensive and take up a lot of space. Ducts need to be large enough not to produce nuisance of sound and they need to be leading to all conditioned spaces. For extra ventilation required in the Adaptive Thermal Comfort System this can mean very large ducts that cannot be integrated in floors. Furthermore, the system is vulnerable for pollution. The filters need to be changed regularly and in practice this is not always done properly which can lead to unhealthy air. Finally, the system needs a significant amount of electrical energy to power the fans especially at high capacities. This should be taken into account when assessing the energy saving by the system.

#### Mechanical supply and natural exhaust

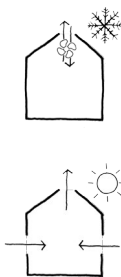
---



This system is not commonly used because it is easier to control the ventilation flow with the exhaust flow. Furthermore, this system takes up space for the supply ducts but doesn't have a possibility of heat recovery.

#### Mechanical ventilation with heat recovery during heating season and natural ventilation for overheating protection

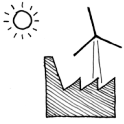
---



This combination can be very useful for an Adaptive Thermal Comfort System. During the heating season the ventilation is minimised and heat recovery can be applied which saves heating energy. The capacity in the heating season will be low because no extra ventilation for cooling purposes has to be applied and therefore the ducts and the fans can be small. During the rest of the year and especially in summer, when the ACPH should be large controlled natural ventilation with large openings can be applied. For the Adaptive Thermal Comfort System to function optimally the openings should be operable at all times by the system. This means the openings should be burglary proof and automated.

## § 3.5.2 Thermal energy generation

---



There are many ways of generating heat and cold in the home and a few possibilities to generate electricity on site. Since the kind and quality of energy is of great influence on energy consumption and on the comfort delivery system, on-site energy generation as well as modern energy saving techniques and storage is discussed in this section.

### § 3.5.2.1 Exergy

---

There are two kinds of energy that are used in the built environment. These are heat (and cool), for space heating and domestic hot water, and electricity. Virtually every home in the Netherlands is connected to the electricity grid and has supply of natural gas. How these are provided until the connection to the individual home is not in the scope of this research. However, it is important to distinguish the various types of energy because this partly determines the amount of fossil fuels used. Therefore, the concept of exergy is briefly described. Usually, heat for space heating and domestic hot water is obtained via conversion processes that transform chemical energy into heat, typically in various steps. Chemical energy from fossil fuels (like coal or natural gas) are so-called high-quality energy sources from which it is possible to obtain various forms of energy. According to the law of conservation of energy during the conversion **no energy is lost**; however, something must be lost in the process because it is not reversible meaning it is not possible to get the same amount of chemical energy from the heat generated by it without adding energy. What is lost we call exergy, which is often referred to as "quality of energy".

Sabine Jansen graduated in 2013 as a PhD on Exergy in the built environment and describes exergy as follows;

*'Exergy, which is based on the second law of thermodynamics, addresses the ideal convertibility of a form of energy given a reference environment. It is defined as the theoretical maximum work obtainable from a system when it comes to thermodynamic equilibrium with the reference environment. It thus "evaluates the potential of the system as a source of work" (Gaggioli 1962) and could in short be defined as 'ideal work potential'. The theoretical maximum work is obtained using a reversible process, which means the work potential of the output of this process equals the work potential of the input. In all real processes however exergy is always destroyed, sometimes a little but more often in large amounts...'*

Also in her dissertation she describes the concept of the exergy factor ([Equation 3.1](#)) and sums exergy factors of various energy types and fuels ([Table 3.6](#));



'To indicate the thermodynamic potential or quality of a certain form of energy an exergy factor (or quality factor) is often used. It gives the ideal work potential per unit of energy, given the reference environment, and is therefore defined as the ratio of exergy to energy (Van Gool, 1997)...'

$$f_{ex} = \text{exergy/energy}$$

EQUATION 3.1 Exergy factor (Jansen, 2013)

ENERGY FORM	EXERGY FACTOR (EXERGY TO ENERGY RATIO), FEX
Kinetic energy	1
Gravitational potential energy	1
Electrical energy	1
Solar radiation	0.9336 (Szargut, 2005 p. 39)
Chemical exergy of some fuels:	
Coal	1.03 *
Wood	1.05 *
Natural gas	0.94 *
Exergy of heat (for $T_0 = 5^\circ\text{C}$ ):	
Heat at $1600^\circ\text{C}$	0.85
$1000^\circ\text{C}$	0.78
$200^\circ\text{C}$	0.41
$60^\circ\text{C}$	0.17
$20^\circ\text{C}$	0.05

\* ratio of chemical exergy of the fuel to the higher heating value (Szargut, 2005)

TABLE 3.6 Exergy factors of various forms of energy and fuels (Jansen, 2013)

### The importance of low-exergy systems for the built environment

Space heating is considered low-level heat because the delivery temperature is room temperature, which is typically around  $20^\circ\text{C}$ . For heating of domestic hot water, a medium level of heat is required. Furthermore, for all our appliances electricity is needed, which is the highest quality of exergy. However, normally these energy demands are fulfilled with the same high quality energy sources, typically natural gas. However, there are many other, more exergetically sound ways to provide this energy. The ACTS system uses low-ex resources as direct solar heat gain and outdoor air to decrease the demand for primary energy as there is no need for conversion of high quality energy to low quality energy.

### Low temperature heating and high temperature cooling

From the exergetic point of view it is sensible to use a supply temperature for heating and cooling systems closer to the environmental temperature. Lower quality sources and thus more exergy efficient can be used for these purposes, like waste heat and solar collectors. Furthermore, less heat is lost during storage and distribution because the temperature difference between the medium and the environment is smaller so less heat transfer will take place. These aspects make low temperature heating and high temperature cooling especially fit for renewable energy, heat pumps and storage and buffering. One great advantage of them is that they can be combined with cooling.

## § 3.5.2.2 Alternative thermal energy generation the Adaptive Thermal Comfort System

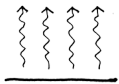
Besides efficiently supplying the thermal energy by low-ex solutions the ATCS can incorporate on site energy harvesting and thermal storage.

### Solar collector



A solar collector absorbs solar radiation to collect heat to warm water to distribute the heat to the location where it is needed. Conventional solar collectors can be flat plate collector panels placed on roof tops, but tarmac surfaces can also function as a solar collector by running water underneath the surface and even façades and roofs can be turned into solar collectors if the surface has a high absorption factor for solar radiation (§ 3.4.1). This makes it possible to realise large surfaces to collect as much heat as possible.

### Evaporative cooling



Evaporation of water uses energy, which is subtracted from the direct environment which cools it down. This can be used to cool air or water for space cooling. This method works better the dryer the air. In the Netherlands, the relative humidity is usually very high, especially in summer, which makes this method less applicable.

### Storage

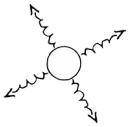


The heat that is rejected with cooling can be stored to be used later to heat the space. The heat can be stored short term in a water tank or long term in the ground, which is called seasonal thermal energy storage. Usually heat storage is combined with a heat pump to collect the heat and apply the right temperature to the water or air to

heat or cool the space. It should be noted that the Adaptive Thermal Comfort System is designed to prevent overheating by preventing it to enter the system or discard it. If seasonal storage is applied this method can cause imbalance between heating and cooling because the heat from the solar radiation is not stored. This can be solved by harvesting the solar radiation that is blocked to be stored for heating demand by for instance solar collectors in the façade (§ 3.4.1).

### § 3.5.3 Heat distribution and end units

---



After generation the heat or cold should be distributed to be applied in the right place for which the possibilities are briefly described in this section.

The most important characteristic of the distribution and end units for the Adaptive Thermal Comfort System is the **locality and speed** of heat and cold delivery.

#### Distribution with water

---



The distribution of heat is the most common way of distributing the heat or cold from the central heat or cold generation equipment to the various spaces. The end-units that deliver the heat can use radiative heat transfer, convective heat transfer or a combination of the two;

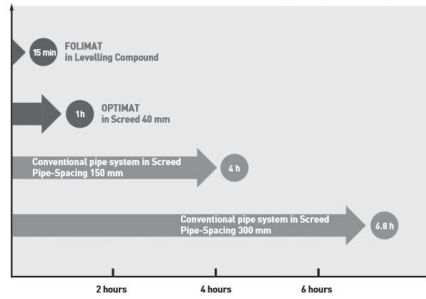
#### Radiative surface heating

Radiative heating is the most comfortable way of heating and low temperature heating can be applied because if the surface is large (e.g. a floor or wall). Cooling is also possible. However, conventional surface heating and cooling is less appropriate for the Adaptive Thermal Comfort System because of the long heat up time of the concrete used to distribute the heat evenly.

To improve the speed of radiative surface heating "dry systems" use different material than concrete for heat distribution such as a metal sheet, which makes them much quicker (RadiantCoolingCorporation, 2013).

Another example is the use of capillary mats in the BioClima system (Clima, 2016) which consist of tubes with a small diameter (4.3 mm outer diameter) and can therefore be incorporated in a much thinner layer of concrete or in the BioClima Levelling Compound) and they have a more dense network. These two properties result in shorter heating time (1 hour for the conventional installation with concrete and 15 minutes if installed in the Levelling Compound).

**Underfloor heating with parquet heating time up to a heating power of 45 W/m<sup>2</sup>**



1 Comparison of the heating times of the BioClina capillary tube mats system with traditional underfloor heating (Glück, 1999)

2 installation of the capillary tube mats directly in the Levelling Compound (Clina, 2016)

Average water temperature 28 °C

Room temperature 20 °C

**FIGURE 3.14** Example of a quick underfloor heating and cooling system; Clina capillary system (Clina, 2016)

### Convective heating

A convector is a common solution for heating in the residential sector and has a relatively fast heat-up time. The convection can be produced naturally if the outlet of the warm air is faced upwards because the convection will come about naturally by the stack effect. However, this requires high temperatures and therefore the systems are not low-ex. Convection can also be created by a fan if the placement cannot create natural convection making it possible to use lower temperatures and enable faster heating. Furthermore, in this way cooling also can be supplied.

### Distribution with (ventilation) air



Air heating, centralised or decentralised, is the fastest way of distributing heat for space heating. However, the supply temperature of the air cannot be too high because of comfort problems. Therefore, the heating power is limited. The air can be heated centrally or per space. If the air is heated per space or per zone, the distribution of the heat to the space or zone by water or locally generated with electricity or combustion. In this way the distribution system is combined. Air heating responds quickly to controls. Air heating devices can usually also provide cooling. An advantage of air heating is that it can easily be used in combination with heat recovery pre-heating the ventilation air.

### Local generation of heat and cold

---



To generate the required heat or cold on the spot where it is needed can save space for distribution pipes and ducts. Furthermore it eliminates distribution losses and the units can be used locally, only when and where needed.

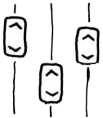
A local high radiation unit can be fuelled by combustion or by electricity. Because of the high temperature of the heaters the exergetic efficiency is very low and they are relatively slow which makes them unfavourable for the Adaptive Thermal Comfort System. Plug-in electrical compressor air conditioning units for heating and cooling are also available, which can heat, cool or do both. They use convection as heat exchange by a fan and are a fast way of heating and cooling; however the exergy efficiency is relatively low due to the high exergy losses by converting electricity into heat or cold.

A modern way of surface heating is the use of radiative electrical panels or even applying heating mats in floors and walls. The advantage is that there is no need for distribution pipes and ducts and that the panels heat up faster than conventional underfloor and wall heating. These systems don't have the possibility of cooling.

---

## § 3.6 Control of the Adaptive Thermal Comfort System

---



To maintain the optimum balance between the energy efficiency and the internal indoor conditions any modern comfort system needs to be controlled to some extent. However, controls need to be designed to operate with respect to a number of different requirements. The outdoor conditions as well as the availability of renewable resources are variable, and so is the demand for the indoor climate, depending on factors like activities, preferences and time of day. If well designed, controls can provide the right conditions for the inhabitants and the activities at the given moment, while saving energy by only providing it when and where necessary. However, in practice many controls turn out to be poorly functioning, causing discomfort to the user and nearly always leading to inefficient operation of the systems (Bordass & Leaman, 2007). Therefore, the most important aspects to design proper functioning controls are described here.

### § 3.6.1 Usability

---

As all (new) technologies, in order for people to accept them and to propagate the desired behaviour to make the system efficient, a number of factors need to be considered first before designing and being able to pronounce in the end on energy saving or quality of the building. The two most important factors are Perceived Usefulness and Ease of Use, like described in the Technology Acceptance Model (TAM) used in sociology and information management (Davis, 1989):

**Perceived Usefulness;** The degree to which a person believes that using a particular system would enhance his or her daily life. This is determined by 4 factors;

- Motivation  
The occupant needs to know why a facility is there. For heating or cooling this is evident, but for ventilation this is not always the case, let alone if the ventilation system is combined with the heating or cooling system. Saving costs in energy is usually not so obvious. The energy bill is usually only presented in the end of the year and mostly people don't know exactly how and where energy is saved.
- Transparency in operation  
The occupant needs to experience in one way or another, why the system is doing what it's doing. If there are too many things going on of which the occupant doesn't know what the purpose is, this can lead to stress, discomfort and irrational counteractions to alleviate this discomfort, which can lead to more energy consumption, system failure and even more discomfort.
- Control  
It is important that occupants experience as much control as is practically possible because various studies point out that when occupants can control their (thermal) environment, the tolerance for inconveniences increases (§ 2.3.1.2).
- Flexibility  
The settings should be flexible to be sufficient in all conceivable scenarios.

**Ease of Use;** The degree to which a person believes that using a particular system would be free of effort (Bordass & Leaman, 2007). The main aspects are;

- Intuitive  
To increase the ease of use for most occupants, the controls need to be intuitive as there is no possibility for training, other than a written guide.

- Feedback of control  
If the control is used, there should be an immediate feedback that shows the system status. This could be a tangible feedback like a click, or an indicator light indicating the system had “read” the control input.
- Feedback of effect  
The intended effect of the control should be noticeable. This could be the heating of the radiators that shows the furnace is on.



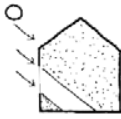
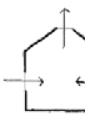

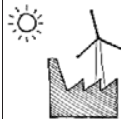
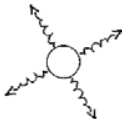
### **Adaptation**

To be able to provide people with the essential control over their environment, while regarding energy efficiency, it is important to understand some basics of human behaviour to regulate thermal comfort, which is called adaptation. This mechanism is explained in § 2.3.1 (De Dear et al., 1997).





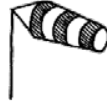


## **§ 3.6.2 Controlling and controlled parameters in the Adaptive Thermal Comfort System**

---

Table 3.7 shows a summary of the controlled parameters (1) in the Adaptive Thermal Comfort System and their associated controlling parameters (2). The table gives information of the parameter symbol and the used unit. For the controlled parameters the table provides information of the interval for switching and the last row shows the controlling parameters associated with it. For the controlling parameters the table shows the locality (place where the information should be collected) and the source of information.

	PASSIVE				ACTIVE		
	thermal mass	irradiation	insulation	natural ventilation	mechanical ventilation	thermal energy generation	end units
							
parameter [unit]	$C_m$ [J/K]	% of $Q_{inc}$	$H_{trans}$ [W/K]	$H_{vent}$ [W/K] $H_{tot}$ [W/K]		$Q_{HC,ND}$ [W]	$Q_{HC,ND}$ [W]
interval of control	diurnal	instantaneous	instantaneous	instantaneous	instantaneous	instantaneous	instantaneous
info [unit]	$\Delta T$ [°C] $\Delta T_i$ [°C] $\Delta T_a$ [°C]	$T_c$ [°C] $T_i$ [°C] $q_{rad}$ [W/m <sup>2</sup> ]	$T_c$ [°C] $T_i$ [°C] $T_a$ [°C]	$T_c$ [°C] $T_i$ [°C] $T_a$ [°C] $P_{air}$ [Pa] $CO_2$ [ppm]	$T_c$ [°C] $T_i$ [°C] $T_a$ [°C] $CO_2$ [ppm]	$Q_{HC,ND}$ [W]	$T_c$ [°C] $T_i$ [°C] $(T_a$ [°C])

### 1 Controlled parameters

	comfort demand	control automation	ambient temperature	solar radiation	wind pressure	relative humidity	indoor operative temperature
							
parameter [unit]	$T_c$ [°C]	on / off	$T$ [°C]	$q_{rad}$ [W/m <sup>2</sup> ]	$P_{air}$ [Pa]	RH [%]	$T_{op}$ [°C]
locality	room	room	facades, roofs, vents	windows	facades, roofs, vents, vulnerable equipment	facades, roofs, vents	room
info source	interface prediction	interface prediction	thermometer	pyranometer	anemometer	hygrometer pluviometer	thermometer

### 2 Controlling parameters

TABLE 3.7 Summary of controlling parameters of occupancy and weather and controlled parameters for the passive and active elements of the Adaptive Thermal Comfort System



### § 3.6.3 Obtaining the information about the controlling parameters

---

Table 3.7 showed the source of information for the controlling parameters which are elaborated on and how the information is processed to automate the adaptive techniques.

#### Occupancy

---



The settings of the Adaptive Thermal Comfort System are to optimise the thermal comfort of the occupant at minimum energy use. Therefore the most optimal control of the setpoint temperature is with presence. In simulation this is easy as all the parameters are known beforehand. In practice the presence can be manually input by an interface (thermostat), with sensors or with prediction (self learning thermostat). Using prediction can be useful if the amount of time to heat up or cool down the room is long. However, in an Adaptive Thermal Comfort System the insulation value is high and the other adaptive features make sure the room temperature deflects as little as possible from the comfort temperature so it is expected the room will be at the right temperature fast enough. Therefore at this moment the most accurate way of indicating presence of the occupant to control the heating (and cooling) time is by occupancy sensors.

#### Interface

---



A modern way of controlling the heating (and cooling) in dwellings is by means of an app on smart-phone or tablet which communicates via Wi-Fi with the control system in the dwelling. This can be used for the occupant to control the system from a distance but these apps can also be integrated with location detection like GPS to detect proximity and possible near arrival of the occupant. However, this can also be tricky if the occupant decides to visit a neighbour for instance. A thinkable technique could be an app that asks the occupant a question if he will be coming home soon at the moment the occupant is approaching the dwelling.

#### Sensors

---



In practice the presence can be measured by occupancy sensors. These can react on movement which are used regularly to control lighting, but they could also be detecting heat production or CO<sub>2</sub>. The latter is nowadays used as a marker to detect pollution by bio-organisms and thus how much ventilation is needed to provide fresh air. Movement detection can be tricky as people can stay in a room almost motionless to the sensors when for instance watching TV or reading a book.

## Weather

---



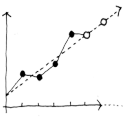
It is relatively easy to monitor the present weather by a combination of sensors but for the slower processes of heat transfer it can be useful to use prediction. A thorough consideration should be made to optimise between information needed and complexity of the measuring system.

## Sensors



Placement of sensors should be carefully chosen, as there can be large local differences due to local air movement and absorption of solar radiation. It can be useful to use multiple sensors to measure the local thermal environment and calculate averages.

## Prediction and time interval



The temperature doesn't rise instantly and so doesn't the relative humidity. However, the solar radiation can vary a great deal from moment to moment and the wind is even more variable with wind gusts and changing in directions. The heat balance of the building is, as the ambient temperature and relative humidity, a relatively slow process depending on the factors of solar gain, heat loss and thermal mass. Therefore, short term weather forecast can be useful for the system to be able to anticipate on weather changes. For even slower processes such as the thermal mass for diurnal heat storage, weather forecast for a few days ahead can be useful.

## Level of automation

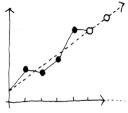
---



Not all variables will be monitored by the control system. The use of control variables depend on the components that need to be controlled and the type of control strategy that will be implemented. If all information is processed by the system, taking action without interference of the occupant, the system is fully automated. There is also a possibility that the user is the one that processes the information to take certain action without any form of artificial intelligence, this is the lowest level of automation. Usually it will be a combination of the control system taking the decisions and the user being able to influence this decision by tuning or overruling. Because the perceived control is important for the functioning of the thermal comfort system as described in the previous section it is important for the user to be able to influence the control. Before designing the control system it needs to be determined which level of automation is required. Chapter 6 will research the influence of automation on the effectiveness of the adaptive measures in the Adaptive Thermal Comfort System.

### § 3.6.4 Control algorithm

---



At any given control interval it might be possible to determine the setting with the least energy consumption to reach the comfort goal. This can be achieved by using a relatively simple cost function;

$$Q_{\text{tot}} = Q_{\text{heat}} / \eta_{\text{heat}} + Q_{\text{cool}} / \eta_{\text{cool}}$$

#### Model Predictive Control

However, passive cooling to a too low threshold can cause an increase in heating demand a few hours later. Therefore, a form of predictive control can be necessary to fine-tune the control to minimise the total energy consumption. Model Predictive Control for building related applications such as climate control is a technique that is getting increasing attention in research. It was first used in chemical process industry and Dussault, Sourbron and Gosselin (2016) describe Model Predictive Control as follows;

*'... MPC refers to a class of control algorithms that use an explicit model of a system to predict its future response over a finite-time horizon. At each control time step, the MPC algorithm optimizes the sequence of control values over the prediction horizon  $H_p$  based on the predictions of the model. In other words, the best control as predicted by the model is applied to the system. The first input of that optimal sequence (the control input at the current time) is sent to the system and the process is then repeated for the next control decision. In its standard form, the optimisation is performed online (in real time) within the controller...'*

#### Adaptive control

This method can be used for building simulations but in practice usually no explicit model is available. In this case use can be made of an adaptive model or self-learning mechanism as is used by Lindelöf et al. (2015) in their field studies in which the strategy yielded an energy saving with an average of  $28\% \pm 4$ ;

*Figure 3.15: '... The self-adaptive building (top) and climate (bottom) models used by the NiQ. At each timestep, all the building's sensors are sampled and used by the models to predict the current indoor temperature, the outdoor temperature, and the solar irradiance. Comparing these predictions with the real values yields a certain error, which is fed back to the adaptive algorithm. The algorithm adjusts the models' internal parameters in order to reduce future prediction errors...'*

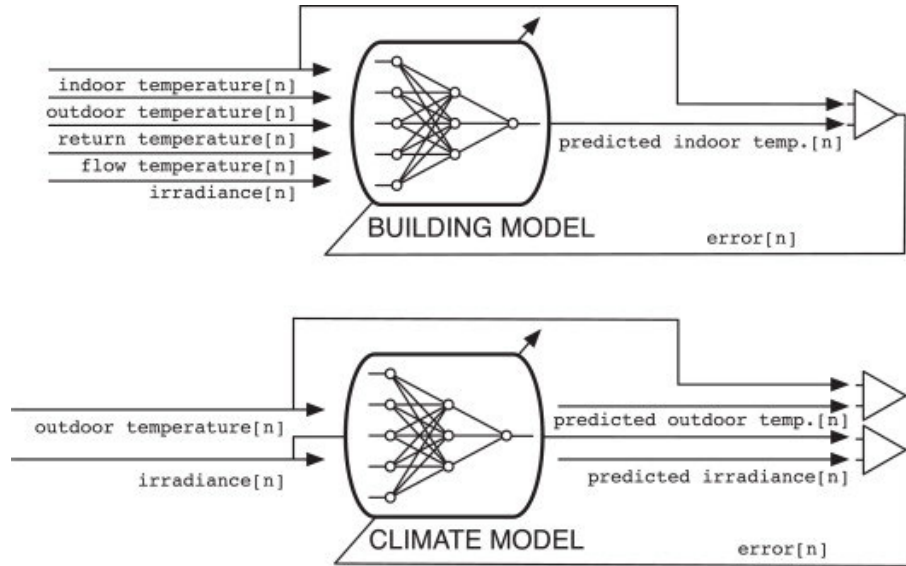


FIGURE 3.15 Adaptive model predictive control used by Lindelöf et al. (2015) in their field studies

It should be noted that in the calculations just hourly average values can be used for the weather information because this is the most detailed information available. The influence of the time interval for measuring the weather and changing settings should be tested in a prototype installation. However, these aspects with advantages and disadvantages should be carefully considered while designing the system.

Furthermore, it should be noted that, if the system would react on every single change in the solar radiation or wind by for instance changing the solar radiation, this can lead to nuisance by constantly moving parts at the façade.

---

## § 3.7 Summary

---

The aspects of adaptive measures that need to be considered to be able to predict the required behaviour and energy saving potential of the characteristics of the Adaptive Thermal Comfort System are summarised in Table 3.8. This table displays a summary of improvements, concerns and opportunities for the techniques for adaptive control described in this chapter.

### **General improvements of existing techniques**


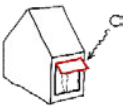
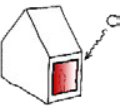
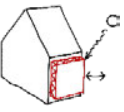
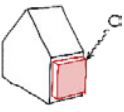
The points of focus for improvement of existing techniques for use in the Adaptive Thermal Comfort System (e.g. shading, transparency of the glass, insulating panels, concrete core activation) already used in common practice are summarized in [Table 3.8](#) and mainly concerns optimisation of control algorithms to provide passive cooling that can be automated including Model Predictive Control and self-learning algorithms. Furthermore, they can be improved to be less vulnerable to failure or mechanical damage and new applications can be costly which can hinder implementation in practice. The main concern for energy delivery systems based on distribution of heat by water is heating and cooling speed; the thermal capacitance and conductance of the material to dissipate the heat mainly determines the speed.

### **Concerns for development and application of techniques**

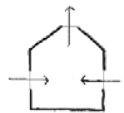
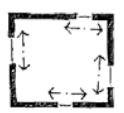
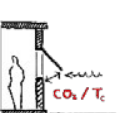
The main concern for almost all techniques is the use of auxiliary energy to drive fans, pumps and moving parts; coatings in the glass to adapt the transparency sometimes use an electric current to be switched or even to remain switched on. Ventilation systems are usually associated with draft and mechanical systems are vulnerable for air pollution or noise from the fans or air movement through ducts.

### **Opportunities**

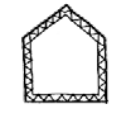
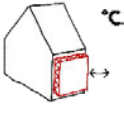
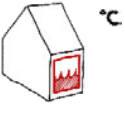

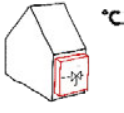
Opportunities per adaptive concept are summarised in [Table 3.8](#).

category		methods for adaptivity in practice			
irradiation		area of incidence 	transparency 	panels 	collector 
	improvements	control; vulnerability	control; cost	control; vulnerability	control
	concerns	auxiliary energy	auxiliary energy	auxiliary energy	auxiliary energy
	opportunities		implementation of fluid replacement	implementation	implementation control


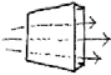
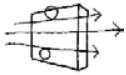


### 1 Solar gain

category		methods for adaptivity in practice			
natural ventilation		placement of the openings 	control of openings 		
	improvements		temperature control; cost		
	concerns	draft	auxiliary energy		
	opportunities	design			

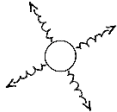
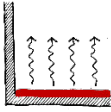
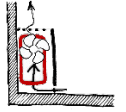

### 2 natural ventilation

category		methods for adaptivity in practice			
insulation		insulative panels 	gas or fluid replacement 	DIM 	bi-directional thermal diode 
	improvements	control; vulnerability	control; cost		
	concerns	auxiliary energy	auxiliary energy	auxiliary energy	auxiliary energy
	opportunities	implementation	implementation of fluid replacement	to be developed	to be developed

### 3 Insulation

category		methods for adaptivity in practice			
thermal mass		storage capacity 	heat transfer by convection 	heat transfer by radiation 	heat transfer by conduction 
	improvements	control	control		
	concerns	auxiliary energy		auxiliary energy	auxiliary energy
	opportunities	extending application	extending application	to be developed	to be developed

#### 4 thermal mass

category		methods for adaptivity in practice			
thermal energy delivery		radiative 	convective 	air 	
	improvements	speed	speed	comfort	
	concerns			draft; pollution; noise	
advantages	comfort	comfort	fast		

#### 5 thermal energy delivery

TABLE 3.8 Improvements, opportunities and concerns for the techniques for adaptive control in the Adaptive Thermal Comfort System

## PART 2 Calculations





# 4 Development and use of the used calculation methods.

---

## § 4.1 Introduction

---

In this chapter the calculation methods for this thesis will be described. This method needs to be able to calculate the heat balance for various strategies in energy conservation for the winter and prevention of overheating in summer for various occupancy profiles to assess the advantages and disadvantages of the strategies.

---

## § 4.2 Research design

---

### § 4.2.1 Problem statement

---

To research the potential of flexible building characteristics for energy saving for thermal comfort, an appropriate model should be chosen to calculate. The purpose of the model is to research the effect and potential of the separate variable building characteristics that otherwise are fixed and variable boundary conditions on comfort, flexibility and energy consumption. Furthermore, the influence of thermal mass on the effectiveness of these flexible characteristics needs to be researched and the possibility to make the thermal mass adaptive as well.

## § 4.2.2 Research questions

---

**Which calculation method is most suitable to determine boundaries and potentials of advanced adaptive building characteristics such as thermal insulation, ventilation and solar gain for energy performance of thermal comfort systems in dwellings?**

---

## § 4.2.3 Method

---

Various existing building simulation programs and models will be discussed in this chapter and assessed for their possibilities to calculate and assess the necessary parameters as adaptive. The criteria for the assessment of the models are;

- Possibility to regard all the variables separately as listed in [Table 4.1 \(1\)](#)
- Possibility to vary the building characteristics as listed in [Table 4.1 \(1\)](#) per time-step during the simulation according to the supply of and demand for thermal energy
- Possibility to calculate a large amount of variants in a relatively short time
- Comprehensibility of the basic effect of varying the separate building characteristics without side effects of the technical implementation
- Validation of the simulation program or model

There will be roughly two levels of detail; very high detail by transient simulation programs and analytical lumped capacitance models. These two levels of detail will be compared in exploratory calculations. In the end the appropriate control algorithms and methods for the adaptive building characteristics are determined.

## § 4.3 Results and Discussion

### § 4.3.1 The parameters to be considered

The control parameters or independent variables parameters for the control system of the Adaptive Thermal Comfort System have been specified in the previous chapter. The calculation model to assess the performance of the Adaptive Thermal Comfort System needs to be able to incorporate the same parameters and their adaptivity. Because the research aims to improve existing techniques as well as develop new concepts an analytical approach needs to be taken that is not limited to the specific technical properties of existing materials and products. Therefore the parameters of the previous chapter are simplified to more generic parameters in [Table 4.1](#) which shows the control parameters and controlled parameters to be considered in the calculations. Using the wind speed and angle as well as the relative humidity and precipitation are not required because of the little influence on the thermal balance. In practice, the wind speed and angle can influence the ventilation but in this study it is no point of research how this ventilation is brought about but just the amount of ventilation. Furthermore, in this study the generation of thermal energy is not considered. More information about the generation of heat is discussed in [§ 3.5.2](#).

In the table the characteristics of the control parameters and the controlled parameters are listed with their parameters and units and the time interval of the available information of the control parameters and the time of interval at which the parameter should be adaptive. Furthermore, the incentives for the settings of the controlled parameters are given to show to which control parameters they should be reacting to. The characteristics of the Adaptive Thermal Comfort System are simplified as much as possible, taking the natural ventilation (with infiltration) and the mechanical ventilation as one heat loss factor and the heat loss factor by transmission and ventilation can also be regarded together as one heat loss factor ( $H_{\text{tot}}$  [W/K]). A more detailed model with more specific parameters as displayed in [Table 4.1](#) can be used to verify the results and the applicability of existing techniques for the Adaptive Thermal Comfort System.

	PASSIVE				ACTIVE		
	thermal mass	irradiation	insulation	natural ventilation	mechanical ventilation	thermal energy generation	end units
parameter [unit]	$C_m$ [J/K]	% of $Q_{inc}$	$H_{trans}$ [W/K]	$H_{vent}$ [W/K]	$H_{tot}$ [W/K]	$Q_{HC,ND}$ [W]	$Q_{HC,ND}$ [W]
interval of control	-	timestep of calculation	timestep of calculation	timestep of calculation	timestep of calculation	timestep of calculation	timestep of calculation
control parameter [unit]	$\Delta T$ [°C] $\Delta T_i$ [°C] $\Delta T_a$ [°C]	$T_c$ [°C] $T_i$ [°C] $q_{rad}$ [W/m <sup>2</sup> ]	$T_c$ [°C] $T_i$ [°C] $T_a$ [°C]	$T_c$ [°C] $T_i$ [°C] $T_a$ [°C] $P_{air}$ [Pa] $CO_2$ [ppm]	$T_c$ [°C] $T_i$ [°C] $T_a$ [°C] $CO_2$ [ppm]	$Q_{HC,ND}$ [W]	$T_c$ [°C] $T_i$ [°C] ( $T_a$ [°C])

### 1 Controlled parameters

	comfort demand level	comfort control	ambient temperature	solar radiation	wind pressure	relative humidity	indoor operative temperature
parameter [unit]	$T_c$ [°C]	on / off	$T$ [°C]	$q_{rad}$ [W/m <sup>2</sup> ]	$P_{air}$ [Pa]	%	$T_{op}$ [°C]
information interval in simulation	15 minutes	15 minutes	hour	hour	hour	hour	timestep of calculation

### 2 Controlling parameters

TABLE 4.1 Parameters to be considered in the calculations

## § 4.3.2 Existing detailed and transient simulation programs

There are various validated energy simulation programs used in scientific building physics research. Crawley et al. (2008) perform a review of twenty existing energy simulation programs of which the best available in Europe are;

- TRNSYS
- Energy Plus (DesignBuilder uses Energy Plus as engine)
- ESP-r
- Ecotect

These building simulation programs can calculate expected energy use for a building on a very detailed basis by inputting material, geometry, weather and occupancy information. This means the values for the building construction represent a specific material and geometry and therefore are restricted to present techniques. However, the possibility to enter individual flexible building characteristics as listed in [Table 4.1](#) are limited. Variable ventilation is mostly possible in these programs as is solar shading, but geometry, insulation value, glass percentage and thermal mass are fixed. In this research this is a serious limitation because the research aims to research new possibilities for new concepts of solutions. The possibility of considering theoretical values for the building characteristic therefore is a requirement. ESP-r gives the possibility to manipulate the source code to input flexible building characteristics, however this requires very good programming skills in the program languages C, C++ and/or FORTRAN. Furthermore it still uses built in modules and “hidden” equations, which makes it hard to understand and monitor the actual processes to be researched without the side effects of other hidden parameters (Crawley et al., 2008). In [§ 4.3.5](#) some exemplary calculations are made with TRNSYS (Wisconsin, 2012) to compare the detailed approach to the lumped capacitance model described in the next section. To assess the concepts that are generated by the research will be possible by a detailed program which will be done in [chapter 6](#) using TRNSYS.

### § 4.3.3 Lumped capacitance method

---

To research the thermal behaviour of a room with flexible building characteristics the thermal heat balance of a room can be simplified to a lumped capacitance model (Bergman, 2011), also called lumped system, with a network of resistors and capacitors analogue to an electrical network reducing a thermal system to a number of discrete “lumps”. The essence of the lumped capacitance method is the assumption that the temperature of the solid is spatially uniform at any instant during the transient process. This assumption implies that temperature gradients within the solid are negligible. This approximation is useful to simplify otherwise complex differential heat equations which reduced the calculation time and this makes the method especially fit to do a large amount of calculations like in this thesis. It was developed as a mathematical analogue of electrical capacitance.

The EN-ISO 13790 standard (2008) uses a lumped capacitance model with 3 indoor thermal nodes, 2 outdoor thermal nodes, 5 resistances and 1 capacitance (5R1C). This model is developed and validated for quick building assessment. The three internal nodes are the indoor air node ( $\theta_{air}$ ), the temperature node of the active thermal mass ( $\theta_m$ ) and the fictive surface node ( $\theta_{st}$ ). As explained in the EN-ISO 13790 standard the temperature of the surface node ( $\theta_{st}$ ) is a mixture between the temperature of the air

node ( $\theta_{air}$ ) and the mean radiant temperature ( $\theta_{r,mn}$ ). The construction of this fictive surface node ( $\theta_{st}$ ) by Y- $\Delta$  transform first described by A.E. Kennelly (1899) is used to simplify the calculations of the more complicated representation of the heat balance.

Figure 4.1 shows the electrical scheme used in the standard and Figure 4.2 shows a graphical representation. A full description and the equations for calculating the node temperatures can be found in [Appendix B](#).

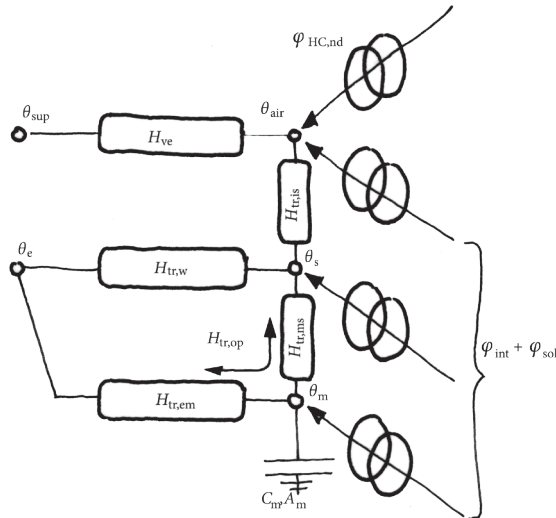


FIGURE 4.1 Representation of the 5R1C model (EN-ISO, 2008)

With:

- $\theta_{sup}$  supply temperature of the ventilation air [ $^{\circ}\text{C}$ ]
- $\theta_e$  outdoor air temperature [ $^{\circ}\text{C}$ ]
- $\theta_{air}$  indoor air temperature [ $^{\circ}\text{C}$ ]
- $\theta_{st}$  temperature of the surface node\* [ $^{\circ}\text{C}$ ]
- $\theta_m$  temperature of the active thermal mass [ $^{\circ}\text{C}$ ]
- $\Phi_{HC,nd}$  energy need for heating and cooling [W]
- $\Phi_{int}$  internal heat gain by appliances and people [W]
- $\Phi_{sol}$  solar heat gain [W]
- $H_{ve}$  heat transfer coefficient due to ventilation [W/K]
- $H_{tr,rs}$  coupling conductance between indoor air and surrounding surfaces [W/K]
- $H_{tr,w}$  heat transfer coefficient due to transparent façade elements [W/K]
- $H_{tr,op}$  heat transfer coefficient due to opaque façade elements [W/K]
- $H_{tr,ms}$  coupling conductance between the active thermal mass and the surfaces [W/K]
- $H_{tr,em}$  heat transfer coefficient for emission [W/K]

- $C_m$  internal heat capacity [J/K]  
 $A_m$  effective mass area [m<sup>2</sup>]  
 \* the surface node is a fictive star node or central node obtained by Y-Δ transform

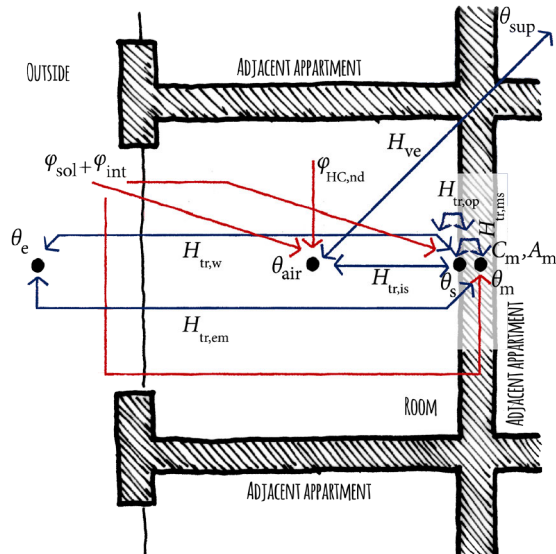


FIGURE 4.2 Graphical representation of the 5R1C model

The description given in the standard is:

'Principle:

The model is a simplification of a dynamic simulation, with the following intention:

- same level of transparency, reproducibility and robustness as the monthly method.
- clearly specified limited set of equations enabling traceability of the calculation process;
- reduction of the input data as much as possible;
- unambiguous calculation procedures;
- with main advantage over the monthly method that the hourly time intervals enable direct input of hourly patterns.

In addition, the model

- makes new development easy by using directly the physical behaviour to be implemented,
- keeps an adequate level of accuracy, especially for room-conditioned buildings where the thermal dynamic of the room behaviour is of high impact.



*The model used is based on an equivalent resistance-capacitance (R-C) model. It uses an hourly time step and all building and system input data can be modified each hour using schedule tables (in general, on a weekly basis).*

*The model makes a distinction between the internal air temperature and mean temperature of the internal (building zone facing) surfaces (mean radiant temperature). This enables its use in principle for thermal comfort checks and increases the accuracy of taking into account the radiative and convective parts of solar, lighting, and internal heat gains, although the results of the simple method at hourly level are not reliable. The calculation method is based on simplifications of the heat transfer between the internal and external environment...'*

*'The heating and/or cooling need is found by calculating for each hour the need for heating or cooling power,  $\Phi_{HC,nd}$  (positive for heating and negative for cooling), that needs to be supplied to, or extracted from, the internal air node,  $\theta_{air}$ , to maintain a certain minimum or maximum set-point temperature. The set-point temperature is a weighted mean of air and mean radiant temperature. The default weighting factor is 0,5 for each.*

*Heat transfer by ventilation,  $H_{ve}$ , is connected directly to the air temperature node,  $\theta_{air}$ , and to the node representing the supply air temperature,  $\theta_{sup}$ . Heat transfer by transmission is split into the window part,  $H_{tr,w}$  taken as having zero thermal mass, and the remainder,  $H_{tr,op}$ , containing the thermal mass which in turn is split into two parts:  $H_{tr,em}$  and  $H_{tr,ms}$ . Solar and internal heat gains are distributed over the air node,  $\theta_{air}$ , the central node,  $\theta_s$  (a mix of  $\theta_{air}$  and mean radiant temperature  $\theta_{r,mn}$ ) and the node representing the mass of the building zone,  $\theta_m$ . The thermal mass is represented by a single thermal capacity,  $C_m$ , located between  $H_{tr,ms}$  and  $H_{tr,em}$ . A coupling conductance is defined between the internal air node and the central node. The heat flow rate due to internal heat sources,  $\Phi_{int}$ , and the heat flow rate due to solar heat sources,  $\Phi_{sol}$ , are split amongst the three nodes.'*

The equations for calculating the node temperatures as well as the distribution of the heat flow of the solar heat can be found in [Appendix B](#). The heating is modelled as air heating. For the purpose of this thesis this is sufficient as the focus is not on the actual heating system but on reducing energy demand by adaptive building characteristics. However, it should be taken into account that the heating and cooling speed in these calculations is fast and that the heating and cooling systems in the Adaptive Thermal Comfort Systems need to meet this criteria of speed to function properly.

### § 4.3.3.1 Reducing the existing lumped capacitance model

The 5R1C model can be used for the purpose of assessing single solutions of adaptive opportunities like insulation for opaque building construction or ventilation or solar gain. However, for assessing the whole mechanism together the multitude of variables can blur the results. Therefore simplifications of the model are researched in the following section.

Two simplifications of the 5R1C model are regarded, in which the heat transfer coefficients are simplified to 4 or 3 resistances;

- 4R1C (simplified 5R1C)
- 3R1C (simplified 5R1C)

#### 4R1C

This model is based on the previous 5R1C model, but bundles the total of heat transfer coefficients for transmission (opaque and transparent) to one resistance  $H_{tr}$  ( $H_{tr,op} + H_{tr,w}$ ). The model uses the same equations as the 5R1C model and uses 0 as the value for the  $H_{tr,em}$  (heat transfer coefficient for emission [W/K]) and replaces  $H_{tr,w}$  by  $H_{tr}$ . Figure 4.3 shows the electrical scheme of the 4R1C model.

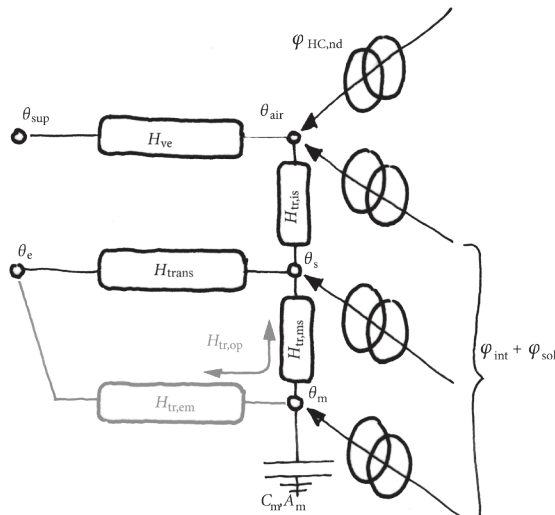


FIGURE 4.3 Representation of the simplified 4R1C model

With:

$$\begin{aligned}
 H_{tr} &= H_{tr,op} + H_{tr,w} && \text{total heat transfer coefficient due to transmission [W/K]} \\
 H_{tr,em} &= 0 && \text{heat transfer coefficient for emission [W/K]}
 \end{aligned}$$

### 3R1C; $H_{tot}$ between $\theta_e$ and $\theta_{air}$

This model is based on the previous 4R1C model, but bundles all heat transfer coefficients to outdoor air in one heat transfer coefficient  $H_{tot}$  ( $H_{tr} + H_{ve}$ ) between the indoor air node ( $\theta_{air}$ ) and the outdoor air node ( $\theta_e$ ) to be able to research the effect of a flexible heat transfer coefficient without determining what the technique will be. The same equations are used as in the original 5R1C model and uses 0 as the value for  $H_{tr}$  (total heat transfer coefficient due to transmission [W/K]) and  $H_{tr,em}$  (heat transfer coefficient for emission [W/K]) and replaces  $H_{ve}$  by  $H_{tot}$ . This means that all heat transfer with the outdoor air is assumed to go via the indoor air. The nodes  $\theta_{sup}$  (supply temperature of the ventilation air [ $^{\circ}$ C]) and  $\theta_e$  (outdoor air temperature [ $^{\circ}$ C]) are also combined assuming the room is ventilated by outdoor air.

Figure 4.4 shows the electrical scheme and Figure 4.5 a graphical representation of the 3R1Ca model.

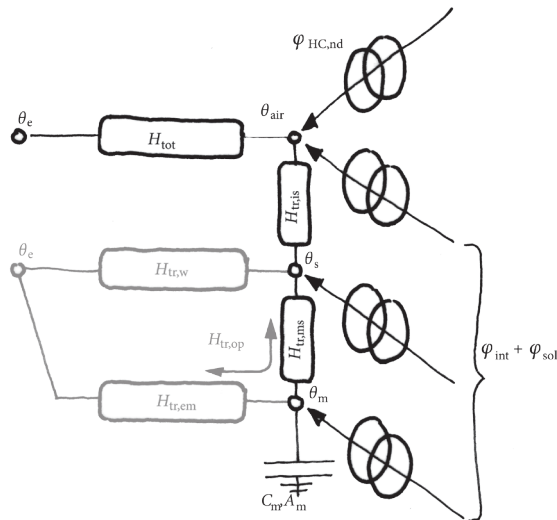


FIGURE 4.4 Representation of the simplified 3R1C model.

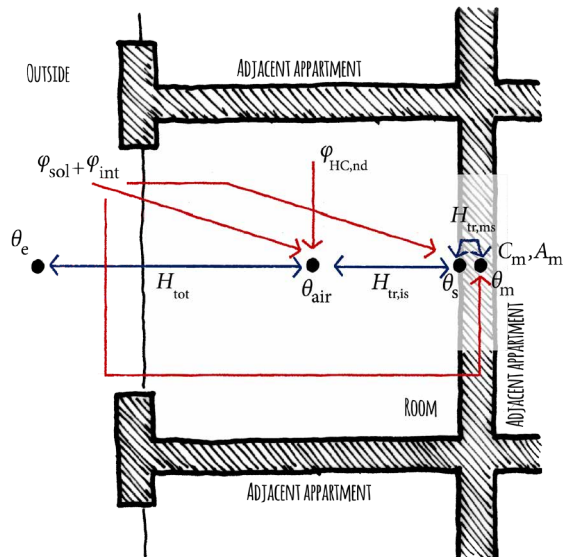


FIGURE 4.5 Graphical representation of the 3R1C model

With:

$H_{\text{tot}}$	$= H_{\text{tr,op}} + H_{\text{tr,w}} + H_{\text{ve}}$	total heat transfer coefficient to outdoor [W/K]
$H_{\text{tr,em}}$	$= 0$	heat transfer coefficient for emission [W/K]
$\theta_{\text{sup}}$	$= \theta_e$	room is ventilated with outdoor air

### § 4.3.4 Comparison of the lumped capacitance models

Calculations have been made all the models by calculating one step several times, while varying all building characteristics to be researched. The node temperatures are calculated with all the models varying each parameter around the average separately. The results of the four models are compared in one graph per parameter to vary. The standard values are given in Table 4.2 and are calculated according to the EN-ISO 13790 standard (2008) and Appendix B. Furthermore, a representative week in winter and summer is calculated to research the influence on the dynamic calculations more detailed.

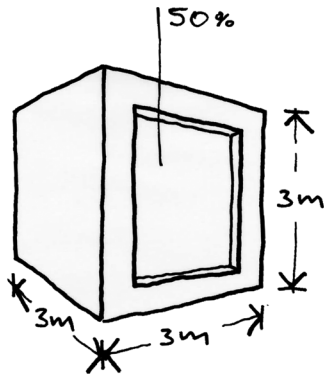
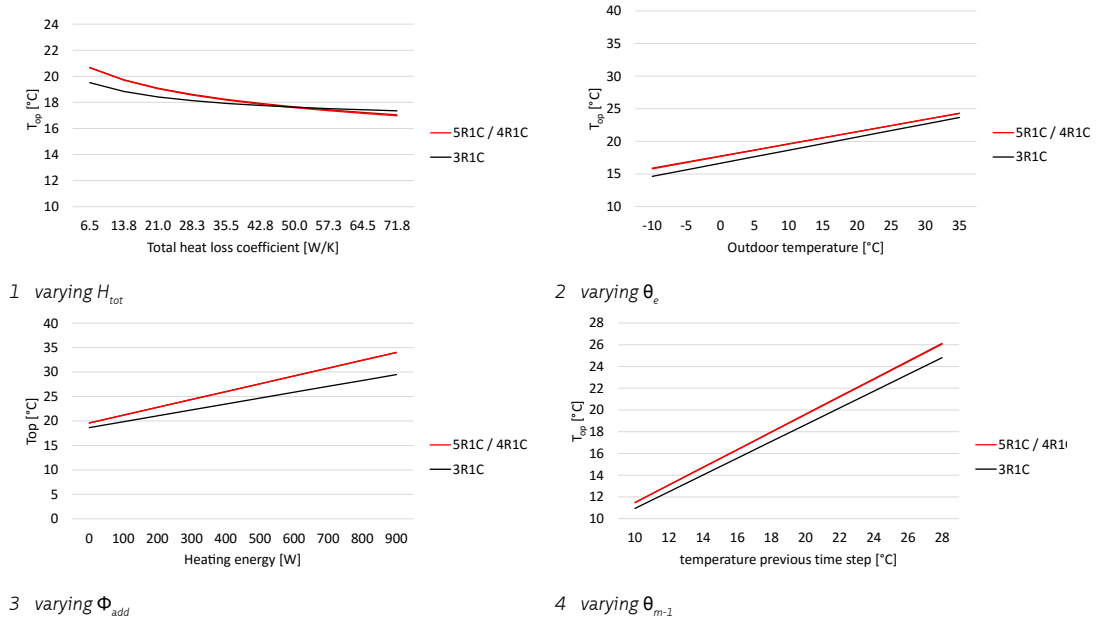


FIGURE 4.6 Representation of the simplified 4R1C model

Figure 4.7 shows the operative temperature calculated with the various models for respectively varying the parameters of the total heat transfer coefficient ( $H_{tot}$ ), added heating power ( $\Phi_{add}$ ), outdoor temperature ( $\theta_e$ ) and thermal mass temperature s the previous time step ( $\theta_{m-1}$ ) separately according to Table 4.2. Other parameters are varied as well according to Table 4.2 but have been found of insignificant difference in influence on the operative temperature result.

CHARACTERISTIC	PARAMETER [ UNIT ]	STANDARD	RANGE
floor area conditioned space	$A_g$ [m <sup>2</sup> ]	9	
glass percentage of façade	$p_{glass}$ [%]	50	
volume of conditioned space	$V_{room}$ [m <sup>3</sup> ]	27	
internal gain per floor area	$\Phi_{int}$ [W/m <sup>2</sup> ]	10	
surface area active thermal mass	$A_m$ [m <sup>2</sup> ]	22.5	
G-value of the glass	$G_{glass}$	0.6	
thermal mass temperature previous time step	$\theta_{m-1}$ [°C]	20	
incidence radiation on total façade	$\Phi_{sol,inc}$ [W/m <sup>2</sup> ]	100	50 to 450
heating / cooling power	$\Phi_{add}$ [W]	0	0 to 900
outdoor air temperature	$\theta_e$ [°C]	10	-10 to 35
heat loss transmission, opaque façade	$H_{tr,op}$ [W/K]	0.9	0.5 to 2.75
	$Rc_{tr,op}$ [W/m <sup>2</sup> K]	5	9 to 1.6
heat loss transmission, transparent façade	$H_{tr,w}$ [W/K]	6.75	1 to 19
	$U_{tr}$ [W/m <sup>2</sup> K]	1.5	0.2 - 4.2
heat loss through ventilation	$H_{ve}$ [W/K]	9	5 to 50
	ACPH [1/h]	1	0.6 - 5.6
active thermal mass	$C_m$ [kJ/K]	148.5	720 to 3330

TABLE 4.2 Standard values and range of variations in the comparing calculations for the various lumped capacitance models



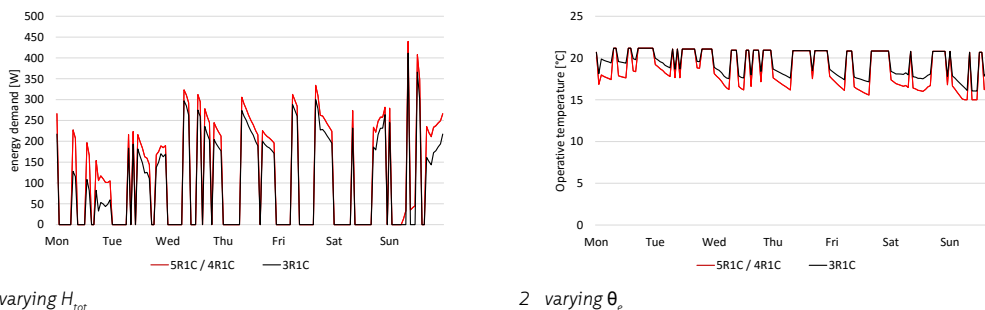
**FIGURE 4.7** Comparing the calculation of the operative temperature calculated with the various models, varying the total heat transfer coefficient ( $H_{tot}$ ), added heating power ( $\Phi_{add}$ ), outdoor temperature ( $\theta_e$ ) and thermal mass temperature s the previous time step ( $\theta_{m-1}$ )

From Figure 4.7 it can be concluded that all three models based on the 5R1C model from EN-ISO 13790 describe the same trend and have slight deflection in results of around 5%, regarding the operative temperature.

Regarding the separate heat loss coefficients in practical ranges (Table 4.2) for their effect on the operative temperature the differences are very small. The largest difference is in the ventilation rate. This is mainly because of the fact that the practical range in heat loss by ventilation is the largest and in case of the 3R1C model all heat transfer ultimately passes the resistance that in the original model represented the ventilation. In the lower ranges of the total heat loss factor the operative temperature in the 3R1C model is around 6% lower than in the original model which deflection decreases with the increase of the total heat loss factor; in the higher ranges of the total heat loss factor the operative temperature in the 3R1C model is around 2% higher than in the original model. This illustrates the influence of the variation in the heat loss factor will be slightly underestimated. This is confirmed with the dynamic calculations.

The added heating energy has significantly less influence on the operative temperature of the 3R1C model which is something that should be regarded when analysing the results of the calculations, meaning that the total heating demand will be underestimated.

Furthermore, the resulting capacity of the thermal mass to store heat is decreased in case of the 3R1C model because all the heat from the thermal mass is transferred from through the coefficients  $H_{tr,ms}$ ,  $H_{tr,is}$  and  $H_{tot}$  while in the 5R1C model part of the heat transfer from the thermal mass is transported through  $H_{tr,em}$  only or  $H_{tr,ms}$  and  $H_{tr,w}$ . Subsequently, this causes the total heat flow between the thermal mass node and the outdoor air node to be higher in the 3R1C model and also the heat resistance between the star node and the outdoor thermal node. This effect can be seen by the influence of the added heating power on the operative temperatures in the various models (Figure 4.7,3) as well as the decreased influence of the thermal mass temperature in the previous time step (Figure 4.7,4). This will lead to a difference in the dynamic calculation underestimating the effect of the variation in the heat loss factor and the needed heating or cooling power. This is confirmed by the results in Figure 4.8 showing the calculation of the operative temperature calculated with the various models, varying the total heat transfer coefficient ( $H_{tot}$ ), added heating power ( $\Phi_{add}$ ), outdoor temperature ( $\theta_e$ ) and thermal mass temperatures the previous time step ( $\theta_{m-1}$ ).



1 varying  $H_{tot}$

2 varying  $\theta_e$

**FIGURE 4.8** Comparing the calculation of the operative temperature calculated with the various models, varying the total heat transfer coefficient ( $H_{tot}$ ), added heating power ( $\Phi_{add}$ ), outdoor temperature ( $\theta_e$ ) and thermal mass temperatures the previous time step ( $\theta_{m-1}$ )

In the dynamic simulation the course of the operative temperature has an average deflection of 3%; however, with apparent differences in distribution of the temperature between the various thermal nodes. In Figure 4.8,2 it is shown that the operative temperature decreases less rapidly during absence of heating power than in the original model. This is because the thermal mass cools down less rapidly because there is less exchange of heat between the thermal mass node and the other thermal nodes as explained above. Therefore, in the dynamic simulation less energy is needed to re-heat the room to the setpoint temperature as shown in Figure 4.8,1. Although there is a significant difference in energy use between the models (approximately 15% less energy use for the 3R1C model compared to the 5R1C model) in the dynamic simulations the effect of the variation of parameters (outdoor temperature, setpoint temperature, solar radiation, heat loss factor and thermal mass variants) show a similar trend in all models.

Regarding the overall comparison of the models the 3R1C model is fit for the objective of this research; identification of the effect of these dynamic parameters on energy efficiency of the system.

#### § 4.3.4.1 Control of the adaptive solar factor and heat transfer coefficient in the lumped capacitance model

---

With the chosen 3R1C model, control algorithms for varying the  $H_{tot}$  and the  $f_{sol}$  factor are explored. These control algorithms should be designed to optimise the  $H_{tot}$  and  $f_{sol}$  value settings to minimise the need for thermal energy to meet the comfort demand. The algorithms to determine the optimal values for  $H_{tot}$  and  $f_{sol}$  in the calculations can vary from the strategies in practice. This is mainly due to the different availability of information and calculation time-step of the thermal heat balance. In the 3R1C calculations, all information is present at the calculation time step and regarded as equal during the whole time step of an hour (or an average of the whole hour is regarded). Due to the interdependence in heat exchange rate between the various thermal nodes ( $\theta_{air}$ ,  $\theta_s$ ,  $\theta_m$ ) during the hour it will be difficult to calculate because this heat exchange is expressed in a combination of complicated equations. In practice, all values vary momentarily and all information for the heat balance is present. Therefore it can be possible to adapt the settings momentarily. Slower processes as the change in ambient temperature during the day can be obtained by prediction and consequently the need for thermal mass could be monitored with a self learning process.

#### Control of the solar factor ( $f_{sol}$ )

---

For practical reasons, first  $f_{sol}$  is calculated. The calculation is based on the value of  $H_{tot}$  of the previous time step and performed with a similar method as used in the EN-ISO 13790 (Appendix B) for the determination of the required heating or cooling power ( $\Phi_{HC,nd}$ ); the temperatures of the thermal nodes are calculated in case of a solar factor of 1 and a solar factor of 0. The operative temperature  $\theta_{op}$  is determined as a linear function of the incoming solar radiation  $\Phi_{sol}$ . The optimised solar factor can be calculated by Equation 4.1 which is determined by performing a multiple linear regression analysis (Appendix C).



$$f_{sol} = 0.49 + -0.22 * \theta_{op,0,sol} - 0.08 * \theta_{op,max,sol} + 0.30 * \theta_{comf}$$

**EQUATION 4.1**  $f_{sol}$  based on the linear relation between  $\theta_{op}$  and  $\Phi_{sol}$

With:

$\theta_{comf}$	[°C]	Required operative temperature or comfort temperature
$\theta_{op,0,sol}$	[°C]	Operative temperature in case of a solar factor of 0
$\theta_{op,max,sol}$	[°C]	Operative temperature in case of a solar factor of 1
$f_{sol}$		fraction of solar radiation on total façade surface entering the the room as heat

Because  $f_{sol}$  is a fraction  $0 \leq f_{sol} \leq 1$ .

This solution was tested in the model and was compared with the cooling demand with a solar factor of 0 all year and the heating demand with a solar factor of 1 all year. The algorithm is able to optimise the  $f_{sol}$  accurately to decrease the cooling demand compared to the reference situation with minimised  $H_{tot}$  and standard solar factor of 0.4. However, **the ultimate energy saving potential for heating and cooling can be higher in practice if there is some form of prediction by an Adaptive Model Predictive Control (self-learning control) (§ 3.6.4) with anticipation of future comfort demand** as the calculations for the heating demand with a solar factor of 1 all year show a significantly lower heating demand.

Because the passive heating in case of the adaptive solar gain is reduced to the comfort bandwidth even at absence as opposed to the situation with solar factor 1, the room temperature can be lower at the end of the day causing the threshold for heating to be reached earlier as result of the gradual temperature drop during the night. This effect will be discussed in chapter 5.

### Control of the $H_{tot}$

Consequently, the  $H_{tot}$  will be adjusted to narrow the gap between the ideal situation and the existing situation even more. The optimised  $H_{tot}$  will be determined with the same method as the solar factor;

The temperatures of the thermal nodes are calculated in case of a minimum and maximum  $H_{tot}$ . The operative temperature  $\theta_{op}$  is determined as a linear function of the total heat loss factor  $H_{tot}$ . The ideal heat loss factor can be calculated by [Equation 4.1](#) based on the linear regression described in [Appendix C](#).

$$H_{\text{tot}} = -40.89 - 5.34 \cdot \theta_{\text{op,max,H}} + 55.23 \cdot \theta_{\text{op,min,H}} - 47.16 \cdot \theta_{\text{comf}}$$

**EQUATION 4.2**  $H_{\text{tot}}$  based on the linear relation between  $\theta_{\text{op}}$  and  $H_{\text{tot}}$

With:

$\theta_{\text{comf}}$	[°C]	Required operative temperature or comfort temperature
$\theta_{\text{op,max,H}}$	[°C]	Operative temperature in case of $H_{\text{tot,max}}$
$\theta_{\text{op,min,H}}$	[°C]	Operative temperature in case of $H_{\text{tot,min}}$
$H_{\text{tot}}$		Total heat loss factor

$$H_{\text{tot,min}} \leq H_{\text{tot}} \leq H_{\text{tot,max}}$$

This solution was tested in the model and was compared with the cooling demand with a maximum  $H_{\text{tot}}$  all year and the heating demand with a minimum  $H_{\text{tot}}$  all year. The algorithm is able to optimise the  $H_{\text{tot}}$  accurately to decrease the cooling demand compared to the reference situation with minimised  $H_{\text{tot}}$  and standard solar factor of 0.4. However, **the ultimate energy saving potential for heating and cooling can be higher in practice if there is some form of prediction by an Adaptive Model Predictive Control (self-learning control) (§ 3.6.4) with anticipation of future comfort demand** as the calculations for the heating demand with a  $H_{\text{tot,min}}$  all year show a significantly lower heating demand. Because the heat loss reduction in case of the adaptive heat loss coefficient is reduced to the comfort bandwidth even at absence as opposed to the minimised heat loss factor the room temperature can be lower at the end of the day causing the threshold for heating to be reached earlier as result of the gradual temperature drop during the night. This effect and the counteractions will be discussed in § 5.3.3.

### § 4.3.5 Comparing the lumped capacitance model and the TRNSYS model

To test the viability of the conclusions drawn from the calculations with the 3R1C model, some test variants are calculated in TRNSYS and compared to the results with the 3R1C model. A series of calculations has been made in both the 3R1C model and TRNSYS and they are compared for trends in the results varying the ventilation strategy and solar gain strategy as well as in different variants for thermal mass and occupancy profile. The calculated cases are shown in Table 4.3. The assumptions for the comparing calculations are shown in Table 4.4. The variants for control that are calculated are shown in Table 4.5.

### § 4.3.5.1 Levelling out the differences in assumptions between the TRNSYS model and the 3R1C model

---

Because the 3R1C model assumes some theoretical properties which is not possible in TRNSYS the assumptions for the TRNSYS model will be different. To still be able to compare the results, these assumptions are adopted in modified calculations in the 3R1C model. The modifications are;

- In TRNSYS it is not possible to change the transparency of the glass without influencing the U-value of the glass. Theoretical combinations of a low U-value belonging to triple glazing and a G-value of 1 as used in the 3R1C model are not possible to be used in TRNSYS. Furthermore, the 3R1C model assumes the theoretical possibility to enlarge the solar radiation receiving area of the façade to 100% without changing the U-value, this means a far smaller range for the  $f_{sol}$ . Therefore;
  - The glass percentage is considered to be fixed and equal to the reference dwelling of AgentschapNL.
  - The G-value of the glass is considered to be fixed and equal to that of triple glazing (0.6)
  - The variation of the  $f_{sol}$  is solely due to solar shading ( $F_c$ ) which can be varied from 1 (no solar shading) to 0 (sun totally blocked)
- In TRNSYS it is not feasible to reliably vary the U-value value of the building shell per time step (chapter 6). As stated in chapter 3 the possibilities to do so in practice are quite limited and difficult compared to the possibilities of varying the  $H_{tot}$  with ventilation, in the TRNSYS model the ventilation is used as sole method to vary the  $H_{tot}$ . This has a small effect on the possible range for the  $H_{tot}$ . The range of  $H_{tot}$  in the 3R1C model is adjusted accordingly for the comparison.
- The time step of the calculations are different; the lumped capacitance model uses a time step of an hour and the TRNSYS uses a time step of a minute. In TRNSYS this time step is needed for controlling the ventilation by a thermostatic control which uses the settings on and off. The average ventilation rate over one hour is regarded as the setting for that hour compared to the lumped capacitance model.
- Because in TRNSYS the time step for the calculation is set to 1 minute to control the adaptive ventilation and solar shading and the data for occupancy is per 15 minutes, this will lead to small differences in the occupancy profiles. This could be levelled out by using hourly occupancy data in TRNSYS as in the Excel model. However, the differences in the living room are very small.

- The calculation of the capacitance in TRNSYS is different than for the 3R1C model. This can lead to different outcomes for heat storage and can prove different effectiveness for the adaptive measures.

CASES					
Thermal mass	3R1C (per m <sup>2</sup> floor area)		TRNSYS (all adjacent opaque surfaces)		
	[J/Km <sup>2</sup> ]		capacitance [J/kgK]	density [kg/m <sup>3</sup> ]	
low	80.000		840	525	
high	370.000		840	2500	
year					
2050 W+	test reference year, warm				
Occupancy profiles	code	people in household	occupancy rate	av. am. people present	average activity level
couple both with job	2_w	2	18%	1.32	2.1
couple with 2 small children	4_sm	4	46%	1.70	2.4

TABLE 4.3 Calculated cases in comparing calculations between the 3R1C model and TRNSYS

ASSUMPTIONS			
Boundary	Type	U-value [W/m <sup>2</sup> K]	G-value
external	wall	0.193	
	window	1.6	
ground (TRNSYS 10 C; Excel Ta)	ground floor	0.193	0.6
identical	separation wall	-	
identical	internal floor	-	
identical	internal wall	-	
Operation			
ventilation [1/h]	1.25	(0.9 l/sm <sup>2</sup> )	
infiltration [1/h]	0	-	
heating setpoint	absence 15 °C; presence T <sub>conf</sub>		
cooling setpoint	absence 30 °C; presence T <sub>conf</sub> + 2		
comfort temperature level	ACA	Adaptive Temperature Model	
Internal gain	Equipment [W/m <sup>2</sup> ]	People [W]	
absence (occupancy schedule)	1	-	
presence (occupancy schedule)	10	75 * (amount of people)	

TABLE 4.4 Assumptions for comparing calculations between the 3R1C model and TRNSYS

VARIANT	CONTROL $H_{TOT}$			CONTROL $F_{SOL}$	
	code	automation	$Q_{ve}$ [l/h]	automation	$F_c$ (shading factor)
reference	1a_ref	-	1.25	-	0
minimised ventilation	1b_ref	-	$\min_{pres}$	-	0
adaptive ventilation	2_vent_dyn	+	$\min_{pres}-10$	-	0
adaptive solar gain	3_sol_dyn	-	$\min_{pres}$	+	0-1
adaptive dwelling	4_dyn	+	$\min_{pres}-10$	+	0-1
-	<b>no automation</b>				
+	<b>automation</b>				
$\min_{pres}$	<b>minimised ventilation for presence</b>				

TABLE 4.5 Calculated control variants in comparing calculations between the 3RIC model and TRNSYS

### § 4.3.5.2 Difference in control of the $H_{tot}$ and the $f_{sol}$ value in the two models

Because the 3RIC model is a lumped capacitance model implemented in Excel where every detail can be controlled by the user, the appropriate  $H_{tot}$  and the  $f_{sol}$  value can be directly estimated by using an equation. It is an hourly model and because a numerical solution for the equation could not be found (Appendix B), it is an estimate based on the calculation of the node temperature from the time step before.

In TRNSYS the calculation can easily be executed in time steps much smaller than 1 hour. Combined with the fact that the calculation to the user is performed by iteration of a large number of differential equations it is impractical to determine a control algorithm in this research the ventilation and the solar gain are controlled with thermostatic control similar to heating and cooling control.

A thermostat controls the setting of the shading and the ventilation to be minimum or maximum according to the indoor temperature (Appendix D). The average value of these settings over an hour can be regarded as the hourly setting as if it were controlled hourly.

### § 4.3.5.3 Results

Figure 4.9 shows the heating and cooling load for the different adaptive concepts as mentioned above for the low thermal mass variant and occupancy profile 4\_sm as calculated by the TRNSYS model and the Excel model. The top two graphs are the results of the TRNSYS model and the bottom two are the results of the EXCEL model.

The left two graphs are the results for the heating demand and the right two are the results for the cooling demand. On the left axis is the heating or cooling demand and the bars each represent the yearly energy demand for one of the strategy variants. Table 4.6 shows the main differences in the models.

MAIN DIFFERENCES	TRNSYS	EXCEL
type	Finite Elements Method (FEM)	Lumped Capacitance Model (LCM)
level of detail	high	low
thermal mass	per surface (FEM)	in thermal node (LCM)
control adaptive features	instantaneous (thermostatic)	algorithm
temperature below floor	static at 10 °C	outdoor temperature
time step	1 min	1 hour

TABLE 4.6 Main differences between the calculation models

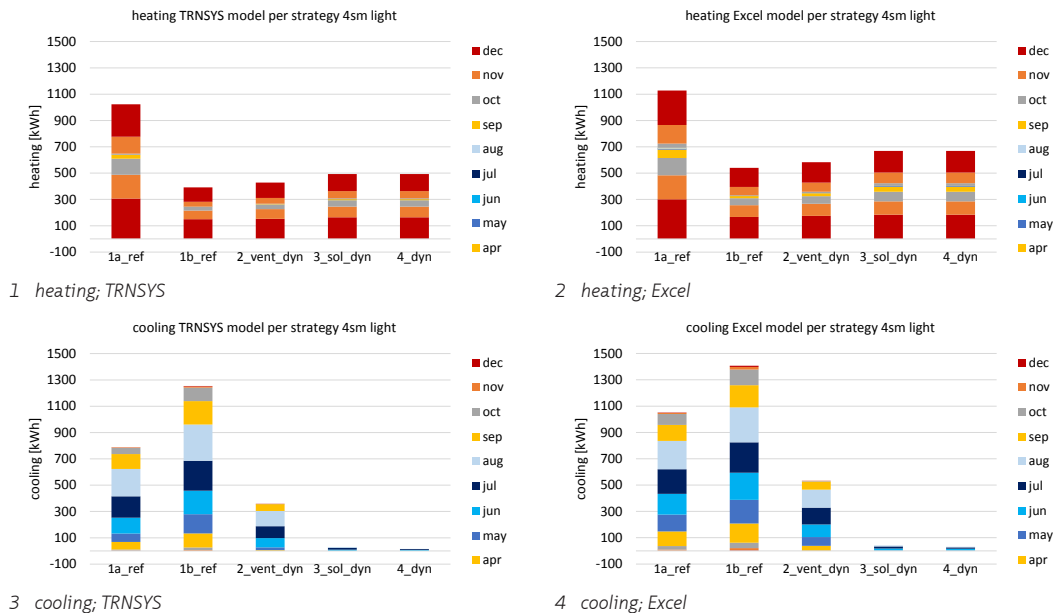
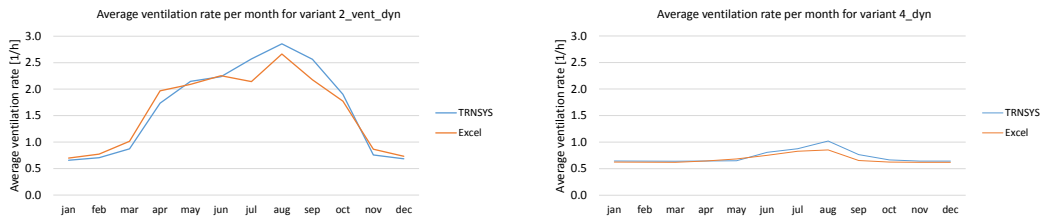


FIGURE 4.9 heating and cooling load for the different strategies for (adaptive) comfort delivery calculated by TRNSYS and by Excel for the occupancy profile 4\_sm and low thermal mass level

From Figure 4.9 the first difference in the two models that is visible is that both the heating load and cooling load are higher in the Excel model (approximately 135% of the TRNSYS heating load in the reference situation). Furthermore, the effect of the different ventilation strategies **on the heating demand** is slightly larger in the TRNSYS model. This effect can be explained by the way the heat transfer between the indoor

temperatures in the models influenced by the thermal mass and the way the thermal mass is defined and this is consistent with the conclusions of § 4.3.4. In the Excel model the heat loss by ventilation is directly imposed on the air node and distributed to the thermal mass via the central node. The distribution of the heat loss in the TRNSYS model is more gradual and slower by the use of the FEM calculation.

Both models show significant reduction in heating load while minimizing the ventilation in variant 1b\_ref as well as a significant increase in cooling load. Both the models show that the cooling load can be almost eliminated by using adaptive solar gain and significantly reduced by using ventilation for overheating control. The decrease in cooling load with adaptive ventilation though in the Excel model is significantly less than in the TRNSYS model. This can lead to an underestimation of the effect of ventilation (or heat loss coefficient) in the Excel model. Furthermore, both models show difficulty with the control of the dynamic values as the heating slightly goes up applying adaptive ventilation and /or solar gain. This effect is slightly higher in the Excel model. These differences in efficiency of the ventilation corresponds with the differences in average ventilation rates in the models. Figure 4.10 shows the average ventilation rates for the two models per month for the two variants in which the ventilation is adaptive.



1 average ventilation rate 2b\_vent\_dyn (4\_sm\_light)

2 average ventilation rate 4b\_dyn (4\_sm\_light)

FIGURE 4.10 ventilation rates during the months of the year for the excel and TRNSYS model with adaptive ventilation only and adaptive ventilation and solar factor

The ventilation rates seen in Figure 4.10 in the case only adaptive ventilation is applied (1) and no adaptive solar gain show a similar trend; although the ventilation in the Excel model is somewhat lower than in the TRNSYS model. In case both ventilation and solar gain are adaptive (2) in both models the ventilation rates reduce drastically.

Given the fact that the trends are similar in both models but more manifest in the TRNSYS model than in the Excel model the Excel model is a good model to do an exploratory analysis without the risk of overestimation of the effect because it is easier to calculate a wide variety of variants with shorter calculation time than with the

TRNSYS model. Above all, the Excel model includes the possibility to disconnect the variance of the solar factor and the heat loss factor which makes it more suitable for the research objective; revealing possibilities for new techniques assuming less restrictions for technical implementation. The TRNSYS model is fit to do more detailed simulations closer to present reality to verify the conclusions and get a closer idea of what the behaviour would be in current practice. Especially the effect of the thermal mass should be carefully reconsidered.

Both models show an increase of heating demand from minimised ventilation to adaptive ventilation and adaptive solar gain. This illustrates the benefit for Adaptive Model Predictive Control (self-learning control) (§ 3.6.4) and stresses the need for more research in practice.

---

## § 4.4 Conclusions

---

Using both detailed simulation with the transient simulation program TRNSYS as well as the less detailed but more analytical method of a lumped capacitance model in this thesis will allow to benefit from the advantages of both levels of detail to generate new concepts by the lumped capacitance model (3RC1) and to verify the conclusions and research the practical implementation in TRNSYS.

As mentioned in the introduction of this chapter the research is focused on control strategies for insulation, ventilation, shading and thermal mass to minimise the energy demand for heating and cooling. Existing detailed transient programs are precarious and laborious in simulating variable insulation, glass percentage and thermal mass and are based on existing technical solutions leaving no possibility of fully disconnecting the solar factor and the heat loss factor; therefore they are not appropriate to research the energy saving potential of new concepts to be developed. However, they are able to better predict the behaviour of techniques in practice which makes them useful to assess the concepts created by this thesis and verify the applicability in the near future in chapter 6. Furthermore, when the new concepts proposed are being developed the detailed approach can help fine-tuning and assessment.

A simple lumped capacitance model is able to model generic physical properties and through the schematic setup it becomes clear what influence all measures have, without conflicting effects of many confounding variables and the limitations of properties of existing technologies and materials. This method is used in chapter 5 of this thesis to research the generic characteristics of the concepts for the Adaptive Thermal Comfort System for adaptive heating and cooling, adaptive heat loss factor



(for ventilation and transmission combined) and adaptive solar gain. Moreover, the calculation time of a lumped capacitance model is short and the process can be easily automated as a parametric study which allows calculation of a large amount of variants in a relatively short time. Consequently guidelines for new concepts for materials and techniques can be developed easiest with a lumped capacitance model.

The existing 5R1C model of EN-ISO (2008) is modified to a 3C1R model for the purpose of this thesis; in the original model the  $H_{tot}$  is split up in heat loss by transparent façade elements, opaque façade elements and ventilation. In the 3C1R the H for transmission ( $H_{ve}$ ) and ventilation are combined to a theoretical heat transfer coefficient, to give most flexibility as to which technologies to be used. This means the values don't necessarily represent a specific technique and therefore there are even less restrictions due to existing techniques than the 5R1C model. The results from the calculations made for comparing the models obtained from the 3R1C model closely resemble the results from the validated 5R1C model. The following connotations should be made using the simplified 3R1C model;

- The effect of the increase of the heat loss factor can be underestimated in the model which means that the resulting range in heat loss factor can be less in practice. This is verified in the case studies of chapter 6.
- The results are no prediction of actual energy use but merely an identification of effect on energy efficiency.
- The distribution of the temperatures between the separate air nodes can be somewhat unreliable making it crucial to regard the operative temperature when comparing results.

Using both the detailed transient simulation in TRNSYS and the 3R1C lumped capacitance model based on the EN-ISO 13790 (Appendix B) in this thesis will allow to benefit from the advantages of both levels of detail to verify the conclusions from the lumped capacitance model and research the practical implementation.

# 5 Adaptive Building Characteristics

---

## § 5.1 Introduction

---

In § 2.4 an **optimal dynamic filter** for sun and wind in the outdoor thermal environment (the weather) was used to bring the micro-climate in a simple shelter closest to the comfort temperature as defined by the Adaptive Comfort Algorithm (ACM). In § 2.3 the dynamic demand for thermal comfort in dwellings in the Netherlands was researched. § 2.4 shows that with the right **dynamic filter**, there should be no significant overheating problems in Dutch dwellings and that the heating demand could be lowered by increasing solar radiation entering the room when there is a heating demand. Furthermore, it proposes the building as a **tunable dynamic filter** to the outdoor thermal environment that can be adapted dynamically according to the circumstances and demand.

In this chapter generic and dynamic physical properties for the behaviour of the Adaptive Thermal Comfort System (whole of passive and active components) are derived. The implementation will be discussed in chapter 7. Through calculating various strategies in heating and prevention of overheating by using the building shell as a dynamically adaptable filter between outdoor and indoor thermal environment (variable thermal insulation, ventilation and solar gain) the advantages and disadvantages of the control strategies are researched. The 3R1C model described in the previous chapter will be used to research these flexible building characteristics for applicability with the occupant profiles of § 2.3 and they use the weather data of the year 2050 W+ described in § 2.4 to find solutions for flexible and user specific thermal comfort.

Chapter 6 will translate the results and conclusions of this chapter to practical concepts and solutions and will verify their effectiveness by means of case studies.

## § 5.2 Research design

### § 5.2.1 Problem statement

The purpose of the calculations in this chapter are to examine the impact and potential of variable and controllable building properties like thermal insulation, ventilation and solar gain on the comfort delivery and energy consumption for heating and cooling. Furthermore, the effects of thermal mass on the effectiveness of these dynamic properties are examined and the influence the thermal mass has on the ranges of these dynamic measures. The optimisation goal will be to minimise the need for additional energy for heating and cooling by applying a conceptual filter that can keep out and in the optimal amount of energy to approach the comfort temperature.

### § 5.2.2 Research question

**What potential do adaptive building characteristics as solar gain, ventilation and thermal insulation have of increasing energy performance for thermal comfort of a dwelling delivering the required thermal comfort level and what is the optimal strategy to control these building characteristics?**

### § 5.2.3 Research tools

In chapter 4, the most appropriate calculation method for researching the thermal behaviour of a room with flexible building characteristics were determined. As illustrated in § 2.3 this research uses a lumped capacitance model based on an analogy of an electric scheme. The model was derived from the 5R1C model developed for the simple hourly method of EN-ISO 13790 (2008) and will calculate 3 thermal nodes (Indoor air temperature ( $\theta_{air}$ ), The surface or star node temperature ( $\theta_s$ ) and the temperature of the thermal mass ( $\theta_m$ )) has 3 resistances (the total heat transfer coefficient between the outdoor air and the indoor air ( $H_{tot}$ ), the heat transfer coefficient between the indoor air and the star node ( $H_{tri,s}$ ) and the heat transfer coefficient between the star node and the thermal mass node ( $H_{tr,ms}$ )) and 1 thermal capacitance (The capacitance of the active thermal mass ( $C_m$ )).

It should be noted that the research and calculations are not based on existing technologies but will approach the questions in a theoretical way, which can set the boundaries for future research to the practical implementation. The heat loss coefficients for ventilation ( $H_{ve}$ ) and transmission ( $H_{tr}$ ) will be combined to one value ( $H_{tot}$ ) and the shading, glass percentage and G-value together will determine the solar factor ( $f_{sol}$ ) which is the fraction of all solar radiation falling onto the surface of the façade (or roof) that actually enters the room as heat. The variable building characteristics are represented in the calculation as shown in Table 5.1.

ADAPTIVE CHARACTERISTICS		
Parameter to be varied		
$H_{tot}$	W/K	The specific heat loss coefficient of the regarded space in W/K. This value is a result of the insulation value of the building shell and the ventilation rate, possibly combined with heat recovery. This parameter can vary per time step
$f_{sol}$	-	The solar factor is a combined parameter of the percentage of the façade which is transparent (glass percentage), the shading factor ( $F_c$ ) and the G value ( $\%F_c * G$ ). Together this will determine the fraction of all solar radiation falling onto the surface of the façade (or roof) that actually enters the room as heat. This parameter can vary per time step
$C_m$	J/K	Thermal capacitance of the active thermal mass. This factor will be regarded in three variants (high thermal mass, middle thermal mass and low thermal mass)
Parameter to be minimised; energy consumption for thermal comfort		
$\Phi_{HC,nd}$	W	Added energy for thermal comfort
Added Heating Power		To keep the temperature on the heating setpoint temperature
Added Cooling Power		To keep the temperature in the room on the setpoint temperature is calculated as an indicator of the overheating that will occur. In practice, the goal is not to install active cooling
Comfort demand to be fulfilled		
heating setpoint		absence 15 °C; presence $T_{comf}$
cooling setpoint		absence 30 °C; presence $T_{comf} + 2$

TABLE 5.1 Researched parameters for the Adaptive Thermal Comfort System

## § 5.2.4 Data, assumptions, cases and variants

The weather data used for the calculations is described in this section as well as the assumptions for the building structure, the calculated cases of user profiles, room and thermal mass level and the variants for control of the building characteristics for thermal comfort.

### § 5.2.4.1 Weather

---

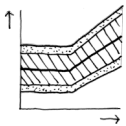


The test reference year of KNMI, scenario W+ will be used in the calculations to research the Adaptive Thermal Comfort System for effectiveness in the expected near future. In § 2.4 this test reference year is analysed and compared to the past 33 years of 1980-2012 in the Bilt.

The global radiation and cloud factor from the weather data files are used in TRNSYS to generate separate diffuse and direct solar radiation on all surfaces with different orientations. The weather data is in UTC and doesn't incorporate daylight saving. In the model this is corrected and all results and analysis are shown in MET with daylight saving.

### § 5.2.4.2 Comfort algorithms

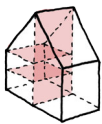
---



To determine the comfort demand the comfort algorithms used are the algorithms of Leen Peeters (Equation 2.2 to Equation 2.6 in § 2.3.3). The algorithms can be refined with preferential differences like: comfort bandwidth (0, 1, 2 or 3 degrees) and preference for cool (-1 or 2), normal (0) or warm (+1 or 2). However, in this thesis this possibility is not regarded. This can alter the exact outcome of the calculations but will not influence the processes and mechanisms researched.

### § 5.2.4.3 Building

---



The reference apartment of AgentschapNL is used (DGMR, 2006). Appendix D shows a full description of this reference dwelling. This apartment type can hold all three different types of household. Because of the theoretical character of the calculations, the most important factor for the room is the volume. The composition of the façades can follow from the results of this chapter.

### § 5.2.4.4 Initial values

---

Table 5.2 shows an overview of the initial values used in the reference situations. These values remain the same unless in a variant is stated otherwise.

INITIAL VALUES			
Boundary	Type	U-value [W/m <sup>2</sup> K]	G-value
external	wall	0.193	
	window	1.6	
	ground floor	0.193	0.6
identical	separation wall	-	
identical	internal floor	-	
identical	internal wall	-	
Operation			
ventilation [1/h]	1.25	(0.9 l/sm <sup>2</sup> )	
infiltration [1/h]	0	-	
Schedule living room	Heating setpoint [°C]	Cooling setpoint [°C]	
0:00 - 6:00	15	30	
6:00 - 23:00	20.5	25	
13:00 - 0:00	15	30	
Schedule bedroom	Heating setpoint [°C]	Cooling setpoint [°C]	
0:00 - 6:00	18	25	
6:00 - 23:00	15	30	
13:00 - 0:00	18	25	
Internal gain	Equipment [W/m <sup>2</sup> ]	People [W]	
absence (occupancy schedule)	1	-	
presence (occupancy schedule)	10	75 * (amount of people present)	

TABLE 5.2 Initial values for the reference situations

### § 5.2.4.5 Cases

The regarded cases of thermal mass and occupancy profiles with their properties are listed in Table 5.3. Each combination between thermal mass level (3), year (3), occupancy profile (3) and room (2) is calculated in the control variants mentioned in § 5.2.4.6. The total of cases will amount up to 54.

CASES					
Thermal mass (Appendix C)		capacitance [J/Km <sup>2</sup> ] (per m <sup>2</sup> floor area)			
low		80.000			
middle		165.000			
high		370.000			
year					
2050 W+		test reference year by TNO (NEN_5060, 2008)			
room		volume [m <sup>3</sup> ]			
living room		85			
bedroom		42			
Occupancy profiles	code	people in household	occupancy rate	average amount of people present	average activity level
1 student	1_st	1	10%	1.26	2.5
couple both with job	2_w	2	18%	1.32	2.1
couple with 2 small children	4_sm	4	46%	1.70	2.4

TABLE 5.3 Calculated cases

#### § 5.2.4.6 Variants for control

To determine the effectiveness of the adaptive measures for heating, the  $H_{tot}$  and the solar factor Table 5.4 shows the variants that are calculated for each case of § 5.2.4.5.

It should be noted that the range for the solar factor ( $f_{sol}$ ) is preferably from 0 to 1. However, this would be practically impossible, because a G-value of 1 would imply there is no glass inside and this would influence the  $H_{tot}$  too much. This is why the calculation is made with the range of 0 to 1. In practice a G-value of the glass of 1 is not practically possible (yet) and the G-value of the glass will always influence the  $H_{tot}$  to an extent; however, this was not considered in the calculations for this thesis because the calculations do not assume specific existing materials and techniques and encourages developing glass and other techniques to reach these values.

The  $H_{tot}$  value is varied in the theoretical combination of a U-value for the opaque separation construction of 0.1 W/m<sup>2</sup>K to 0.2 W/m<sup>2</sup>K, a U-value for the transparent separation construction of 1.2 W/m<sup>2</sup>K to 1.6 W/m<sup>2</sup>K and a ventilation rate of minimal for fresh air to a maximum of 30 l/h.

VARIANTS	CONTROL $\Phi_{HC,ND}$		CONTROL $H_{TOT}$				CONTROL $F_{SOL}$			
	timing	setpoint	automation	frequency	range $U_{opaque}$ [W/m <sup>2</sup> K]	range $U_{gl}$ [W/m <sup>2</sup> K]	range $Q_{ve}$ [L/h]	automation	frequency	range $f_{sol}$
reference	s	hi/lo	-	-	0.2	1.6	1.25	-	-	$0.6 \cdot f_{glass}$
adaptive heating	p	ACA	-	-	0.2	1.6	1.25	-	-	$0.6 \cdot f_{glass}$
maximum heat loss	p	ACA	-	-	0.2	1.6	30	-	-	0
minimum heat loss	p	ACA	-	-	0.1	1.2	min <sub>pres</sub>	-	-	1
adaptive $H_{tot, hour}$	p	ACA	+	h	0.1-0.2	1.2-1.6	min <sub>pres</sub> -30	-	-	$0.6 \cdot f_{glass}$
adaptive $H_{tot, day}$	p	ACA	+	d	0.1-0.2	1.2-1.6	min <sub>pres</sub> -30	-	-	$0.6 \cdot f_{glass}$
adaptive $H_{tot, season}$	p	ACA	+	s	0.1-0.2	1.2-1.6	min <sub>pres</sub> -30	-	-	$0.6 \cdot f_{glass}$
adaptive $H_{tot, month}$	p	ACA	+	m	0.1-0.2	1.2-1.6	min <sub>pres</sub> -30	-	-	$0.6 \cdot f_{glass}$
presence $H_{tot, hour}$	p	ACA	-	h	0.1-0.2	1.2-1.6	min <sub>pres</sub> -30	-	-	$0.6 \cdot f_{glass}$
adaptive $f_{sol, hour}$	p	ACA	-	-	0.2	1.6	min <sub>pres</sub>	+	h	0-1
adaptive $f_{sol, day}$	p	ACA	-	-	0.2	1.6	min <sub>pres</sub>	+	d	0-1
adaptive $f_{sol, season}$	p	ACA	-	-	0.2	1.6	min <sub>pres</sub>	+	s	0-1
adaptive $f_{sol, month}$	p	ACA	-	-	0.2	1.6	min <sub>pres</sub>	+	m	0-1
presence $f_{sol, hour}$	p	ACA	-	-	0.2	1.6	min <sub>pres</sub>	-	h	0-1
adaptive $H_{tot, hour} f_{sol, hour}$	p	ACA	+	h	0.1-0.2	1.2-1.6	min <sub>pres</sub> -30	+	h	0-1
adaptive $H_{tot, day} f_{sol, day}$	p	ACA	+	d	0.1-0.2	1.2-1.6	min <sub>pres</sub> -30	+	d	0-1
adaptive $H_{tot, season} f_{sol, season}$	p	ACA	+	s	0.1-0.2	1.2-1.6	min <sub>pres</sub> -30	+	s	0-1
adaptive $H_{tot, month} f_{sol, month}$	p	ACA	+	m	0.1-0.2	1.2-1.6	min <sub>pres</sub> -30	+	m	0-1
presence $H_{tot, hour} f_{sol, hour}$	p	ACA	-	h	0.1-0.2	1.2-1.6	min <sub>pres</sub> -30	-	h	0-1
s	schedule (Table App.C.4)									
p	presence									
hi/lo	setpoint and setback (Table App.C.4)									
ACA	Adaptive Comfort Algorithm									
-	none									
+	automation									
h	hourly switch									
d	daily switch									
s	seasonally switch									
m	monthly switch									
$f_{glass}$	percentage of glass in façade									

TABLE 5.4 Calculated control variants



## § 5.2.5 Analysis

---

The  $H_{\text{tot}}$  is a combination of  $H_{\text{ve}}$  and  $H_{\text{tr}}$  and these are not regarded separately, because their effect on the thermal balance is similar. In current practice however,  $H_{\text{ve}}$  will be significantly larger in range and easier to vary by just using fans and controlling the openings and therefore this is the easiest way to achieve these variable  $H_{\text{tot}}$ . There are also numerous techniques to vary the  $f_{\text{sol}}$ , however the ways this variation is obtained is not relevant for the calculation. In chapter 3, the various techniques to vary the  $H_{\text{tot}}$  and the  $f_{\text{sol}}$  are discussed.

For each calculation the added heating and cooling power is outputted as well as the variance in  $H_{\text{tot}}$  and  $f_{\text{sol}}$ . For all calculations the maximal, minimal and average values will be given for the  $H_{\text{tot}}$  and  $f_{\text{sol}}$  and later on in the analysis also the percentiles will be regarded to see the occurrence of the values. Furthermore, as a check, underrun and exceeding of the comfort range will be analysed in degree-days and hours of occurrence. All information will be regarded for each month of the year and the whole year.

## § 5.2.6 Energy use of reference situations

---

All the combinations of occupancy profiles and thermal mass variants are calculated for their energy demand for heating and cooling in the three years regarded. Table 5.5 shows the assumptions for the reference situations of the cases. The bedroom and the living room are calculated separately and it is considered that there is no significant heat exchange between rooms in the house because the temperature differences between the rooms will be relatively small compared to the temperature difference between outdoors and indoors. The cooling demand is used as a quantification of overheating problems to occur.

ASSUMPTIONS VARIANT MINIMISED HEAT LOSS					
Assumption		Living room		Bedroom	
Parameter [unit]	Value	Parameter [unit]	Value	Parameter [unit]	Value
<b>property</b>	<b>average</b>	$H_{tot,min}$ [W/K]		$H_{tot,min}$ [W/K]	
$R_c$ [Km <sup>2</sup> /W]	5	$H_{tr,w}$ [W/K]	16.1	$H_{tr,w}$ [W/K]	6.1
$U_w$ [W/m <sup>2</sup> K]	1.6	$H_{tr,op}$ [W/K]	8	$H_{tr,op}$ [W/K]	4.7
$q_v$ [l/h]	1.25	$H_{ve}$ [W/K]	35.8	$H_{ve}$ [W/K]	17.9
<b>Solar gain</b>					
$f_{sol}$	$0.6 * f_{glass}$	$f_{sol}$	0.4	$f_{sol}$	0.2
<b>Heating and cooling control</b>					
schedule (Table 5.2)					

TABLE 5.5 Assumptions reference situations

Figure 5.1 shows the results of the heating and the cooling load for 2050 W+. The picture shows the energy use for a year for all the cases for heating on the left side (1,3) and cooling on the right (2,4). The top two graphs show the results for the living room (1,2) and the lower graphs are for the bedroom (3,4).

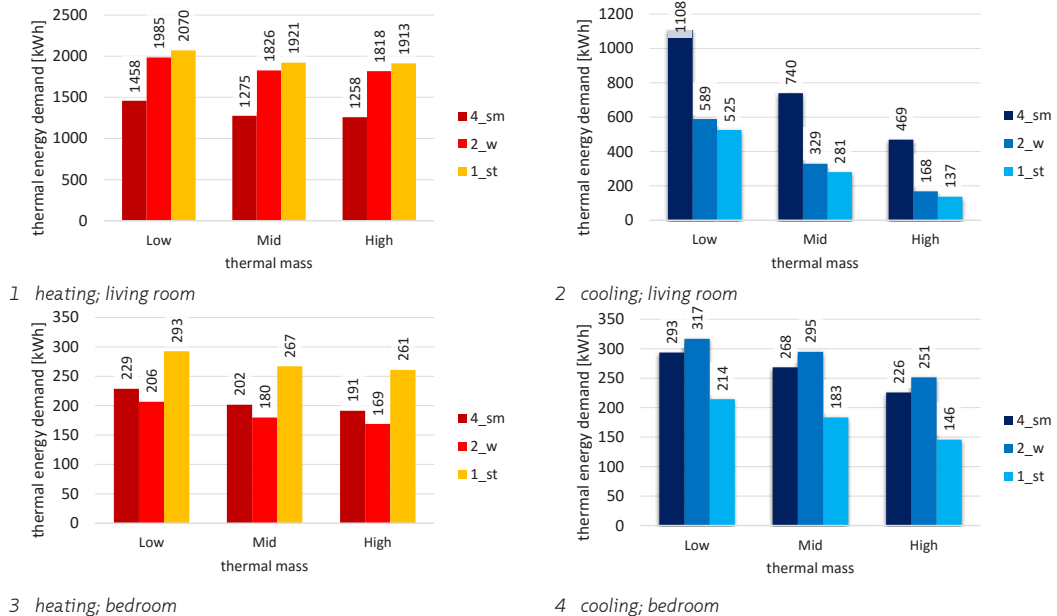


FIGURE 5.1 Thermal energy demand heating and cooling in a year for the living room and bedroom in the reference situations (Table 5.5) comparing occupancy profiles

### Differences per profile and room function

In general, the heating is highest with the lowest occupancy rate (2070 kWh for the living room profile 1\_st and 1458 kWh for the profile 4\_sm, which is a difference of more than 25%) due to the fact that the heating schedules are all the same for all the profiles because it is programmed by the thermostat and the more occupancy, the more internal gain to lower the demand for heating. The opposite is true for the cooling load, because in this case extra internal heat increases the cooling load significantly. This means that for the profiles with high occupancy a large portion of the cooling load is due to internal gain.

### Differences per thermal mass level

As can be expected, the cooling load is significantly lower with higher thermal mass level. The cooling load for the profile 4\_sm in the living room with low thermal mass (1108kWh) is almost twice as high as the load for the same situation but with high thermal mass level (469 kWh). The cooling load in case of the living room occupied by the one person household in the low thermal mass variant is almost 4 times as high as the high thermal mass variant.

The differences in heating demand are very little between the thermal mass levels. This is due to sufficiently high insulation level ( $R_c = 5 \text{ W/m}^2\text{K}$ ) and thus small fluctuations in the indoor temperature. Even with this little difference, for heating the same effect can be seen; with higher thermal mass, the heating demand decreases. This can be explained by the fact that the high thermal mass preserves the incoming solar radiation better and thus has a lower fluctuation of temperature, leading to a higher remaining temperature at the end of a period of absence. Therefore, in the reference dwelling with sufficient solar gain higher thermal mass is preferred for both heating as cooling load.

## § 5.3 Results and Discussion

### § 5.3.1 Energy saving effect of adaptive comfort delivery

The first step to create an Adaptive Thermal Comfort System is to implement adaptive heating and cooling providing thermal comfort only when and where needed, thus when the occupant is present. Figure 5.2 shows the heating load on the left (1,3) and the cooling load on the right (2,4) both absolute in kWh as the relative energy use compared to the day and night setting for heating (§ 5.2.6). The upper two graphs (1,2) are for the living room and the lower for the bedroom (3,4). Table 5.6 shows the assumptions for this variant.

It should be noted that in the calculations it is assumed that the heating and cooling power is **unlimited** and has a **response time equal to the calculated time step**. This means that inertia of the heating delivery system by its thermal mass is not regarded. Systems in practice could therefore be less effective the slower they are.

ASSUMPTIONS VARIANT MINIMISED HEAT LOSS					
Assumption		Living room		Bedroom	
Parameter [unit]	Value	Parameter [unit]	Value	Parameter [unit]	Value
<b><math>H_{tot,min}</math> [W/K]</b>					
<b>level</b>	<b>average</b>	<b><math>H_{tot,min}</math> [W/K]</b>		<b><math>H_{tot,min}</math> [W/K]</b>	
$R_c$ [Km <sup>2</sup> /W]	5	$H_{tr,w}$ [W/K]	16.1	$H_{tr,w}$ [W/K]	6.1
$U_w$ [W/m <sup>2</sup> K]	1.6	$H_{tr,op}$ [W/K]	8	$H_{tr,op}$ [W/K]	4.7
$q_v$ [l/h]	1.25	$H_{ve}$ [W/K]	35.8	$H_{ve}$ [W/K]	17.9
<b>Solar gain</b>					
$f_{sol}$	$0.6 \cdot f_{glass}$	$f_{sol}$	0.4	$f_{sol}$	0.2
<b>Heating and cooling control</b>					
presence					

TABLE 5.6 Assumptions variant adaptive heating and cooling

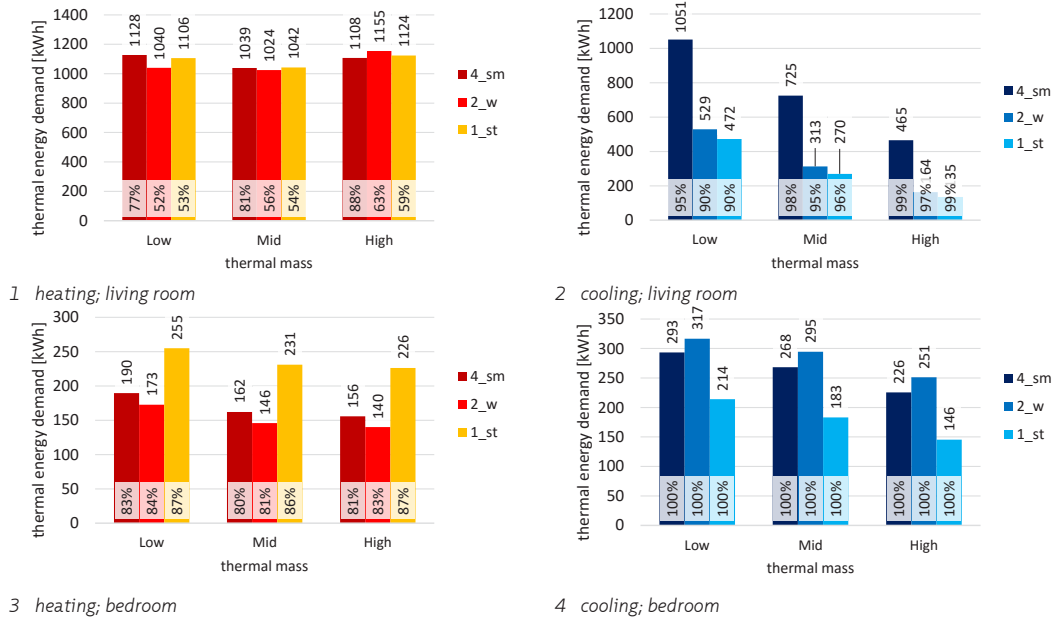


FIGURE 5.2 Thermal energy use for heating and cooling for the living room and bedroom for adaptive heating (Table 5.6) as a percentage of the reference situations (Table 5.5), for all occupancy profiles.

The absolute heating demand in Figure 5.2 doesn't show much difference anymore between the occupancy profiles. The relative heating demand however, shows that for the living room the energy saving can amount up to almost 50% energy saving in the case of the single person (1\_st) and the couple without children (2\_w). The energy saving for the household with 2 small children (4\_sm) is lowest around 15% due to the fact that the occupancy rate is very high. As we could see in Table 5.3 the master bedroom is occupied at standard hours in all profiles which causes the bedrooms to show less energy saving; at most this is 20%. The energy saving for adaptive heating in the bedrooms is similar for all thermal mass levels and occupancy profiles and for the living room the energy saving is slightly lower with higher thermal mass, resulting in a remaining heating load slightly higher for lower thermal mass as in the reference situations.

Heat up and cooling down temperature are an important characteristic of heating systems. In these calculations it is assumed that the heating power is unlimited and there is no limit to the speed. In practice this will not be the case; therefore the required heating step changes are analysed. Figure 5.3 shows the required heat up speed by showing the 95% percentiles for the step change in indoor air temperature at times of change in setpoint temperature (heat up or cool down after a period of absence). It should be noted that these changes occur in the model from one time-step to another, meaning one hour of heating up. In practice it will be required to either heat up or cool down swiftly after the occupant enters the room (eg. 15 minutes) or prepare the

system to heat up or cool down to the required temperature before the occupant enters the room, which requires a short term prediction of the change in setpoint. When designing the system to deliver the heating this should be kept in mind.

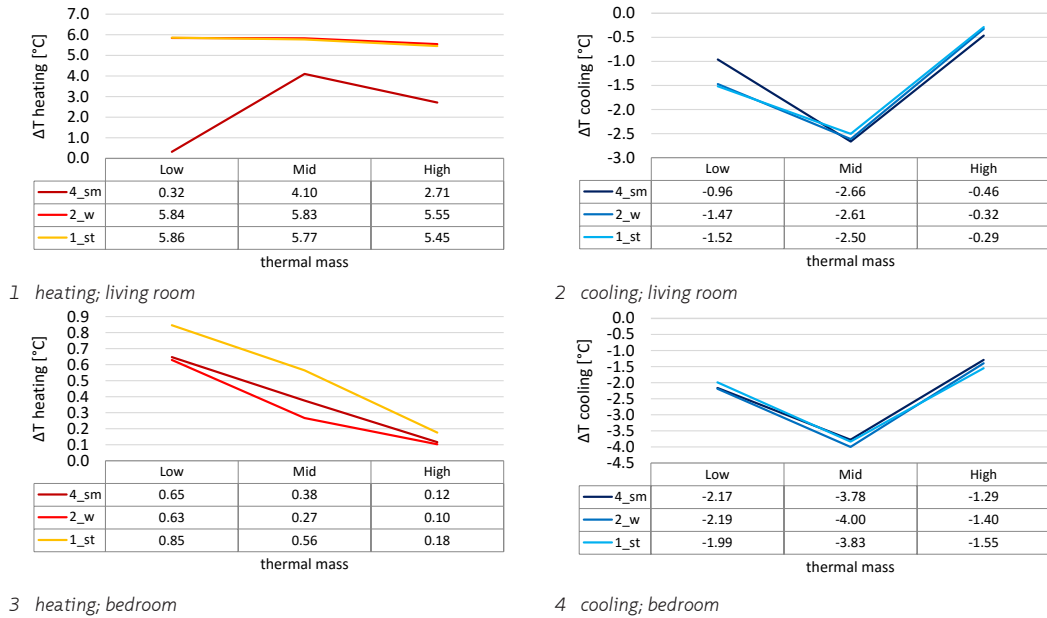


FIGURE 5.3 Heat-up-speed and Cool-down-speed 95% percentiles living room and bedroom for adaptive heating (Table 5.6);  $\Delta T$  = temperature difference to be made by heating or cooling from one time-step to the next at change of setpoint temperature, maximum in 95% of the time

From Figure 5.3 it becomes clear that 5 % of the time the required heat up is quite high for the living room depending on the thermal mass and occupancy profile with approximately 6 °C and the cool down speed is between 1 °C and 2 °C. With higher thermal mass, the required heat up step will be smaller; however, the heat up speed will be lower as well. In 20% of the time the heat required heat up speed will be significantly lower; however still high with around 4 °C. Stabilising the indoor temperature by minimising heat loss will lower the required heat-up or cooling-down speed. In the bedrooms the required heating up speed will be much lower (below 1 °C) and the cool down speed will be significantly higher (between 2 °C and 4 °C). This is because of the difference in setpoint temperature between the living room and the bedroom. The required high heat up and cooling down speed can be a serious limitation for the concept of adaptive heating, emphasizing the importance of heat-up speed for the system to be chosen. Stabilising the indoor temperature around the comfort temperature by minimising heat loss will lower the required heat-up or cooling-down speed as shown in the next sections.

## § 5.3.2 Minimised heat loss coefficient

A widely used method to save heating energy for heating is to minimise the ventilation together with high insulation. As discussed in the introduction and the previous chapter the heat loss coefficient for ventilation and transmission are combined to one value  $H_{\text{tot}}$  and the variation in the heat loss factor are disconnected to the influence of solar radiation on transmission to study the possibility of new techniques to be developed that might in the future not have this interdependency. In practice this means that care should be taken that heating up of the construction by solar radiation doesn't lead to increased heat flow; for instance by venting the facade. Figure 5.4 shows the thermal energy demand during a year for heating and cooling for the living room and bedroom with minimised heat loss, assuming the windows not to be operable. The optimisation involves the assumptions shown in [Table 5.7](#).

ASSUMPTIONS VARIANT MINIMISED HEAT LOSS					
Assumption		Living room		Bedroom	
Parameter [unit]	Value	Parameter [unit]	Value	Parameter [unit]	Value
<b><math>H_{\text{tot,min}}</math> [W/K]</b>					
<b>level</b>	<b>min</b>	<b><math>H_{\text{tot,min}}</math> [W/K]</b>		<b><math>H_{\text{tot,min}}</math> [W/K]</b>	
$R_c$ [Km <sup>2</sup> /W]	10	$H_{\text{tr,w}}$ [W/K]	12.1	$H_{\text{tr,w}}$ [W/K]	4.3
$U_w$ [W/m <sup>2</sup> K]	1.2	$H_{\text{tr,op}}$ [W/K]	4.1	$H_{\text{tr,op}}$ [W/K]	2.4
$q_v$ [l/h]	$0.5 + 0.2 \cdot p$	$H_{\text{ve}}$ [W/K]	$14.3 + 5.7 \cdot p$	$H_{\text{ve}}$ [W/K]	$7.2 + 2.9 \cdot p$
<b>Solar gain</b>					
$f_{\text{sol}}$	$0.6 \cdot f_{\text{glass}}$	$f_{\text{sol}}$	0.4	$f_{\text{sol}}$	0.2
<b>Heating and cooling control</b>					
presence					

TABLE 5.7 Assumptions variant minimised heat loss

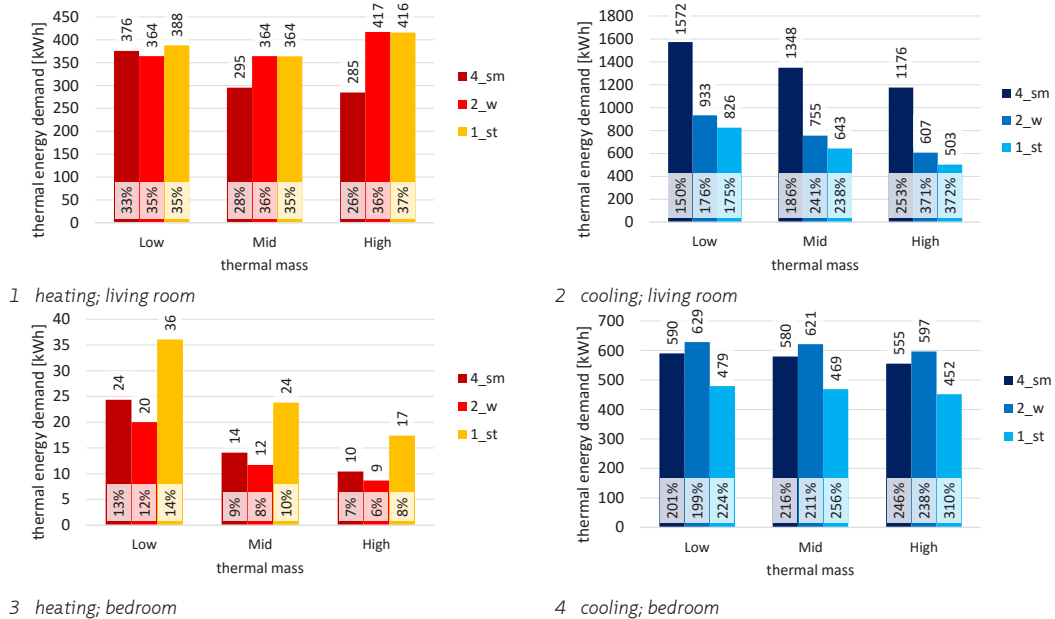


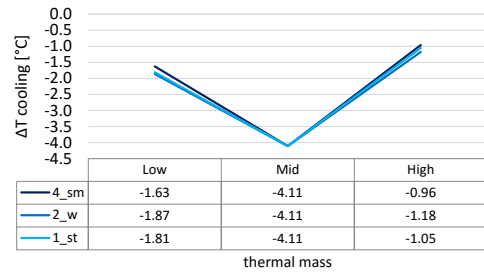
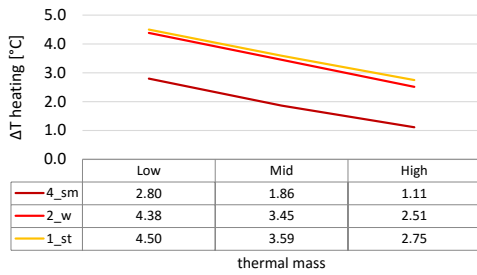
FIGURE 5.4 Thermal energy demand during a year for heating and cooling for the living room and bedroom with minimised heat loss factor (Table 5.7) relative to the reference with adaptive comfort delivery (Table 5.6).

It becomes clear from Figure 5.4 that this measure can save 63% to 74% on heating demand for the living room and even almost 95% in the bedroom. However, as expected if the summer situation is not accounted for this can lead to vast overheating or cooling demand from doubled to up to more than 4 times as much.

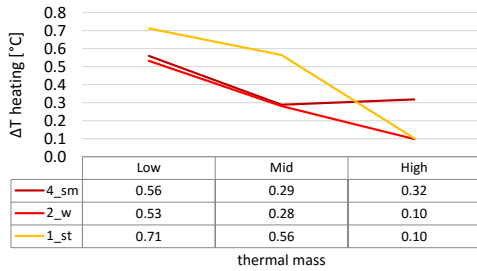
There is no large difference in energy saving for heating between the different occupancy profiles and thermal mass showing the same trend as the heating demand for the variant with adaptive heating. The energy saving potential for heating in the living room shows no significant differences between thermal mass variants; however the remaining heating demand is still higher for low thermal mass than for the variants with high thermal mass. The energy saving potential for reducing the heating demand in the bedroom shows a significant improvement with higher thermal mass resulting in larger differences in remaining heating demand between high and low thermal mass. In all cases the high thermal mass variant is still in advantage.

Figure 5.5 shows the required heat up speed by showing the 95% percentiles for the step change in indoor air temperature at times of change in setpoint temperature (heat up or cool down after a period of absence).

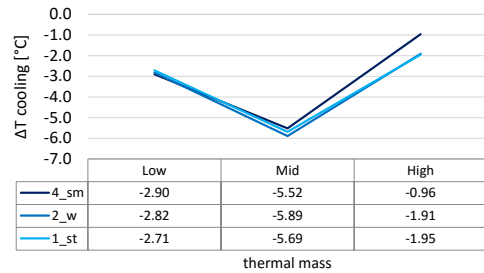




1 heating; living room



2 cooling; living room



3 heating; bedroom

4 cooling; bedroom

**FIGURE 5.5** Heat-up-speed and Cool-down-speed 95% percentiles living room and bedroom with minimised heat loss factor (Table 5.7);  $\Delta T$  = temperature difference to be made by heating or cooling from one time-step to the next at change of setpoint temperature, maximum in 95% of the time

From Figure 5.5 it becomes clear that by stabilising the temperature by minimising the heat loss factor the heat up speed will be significantly lower with values around 4 °C; however, the required cool down is significantly higher especially in the bedrooms.

### § 5.3.3 Adaptive heat loss coefficient

To combine the energy conservation in winter with the possibility to discard excess heat when needed the heat loss factor ( $H_{tot}$ ) can be made adaptive. In the heating season, the insulation is high ( $R_c$  10 K m<sup>2</sup> /W;  $U_{tr}$  1.2 W/m<sup>2</sup>K) and the ventilation is minimised to provide enough fresh air and during warm times the heat loss factor can be increased by lowering the  $R_c$  but more effectively raising the ventilation rate. It is assumed that if the optimal  $H_{tot}$  can be found the energy use for heating will be equal to the variant for minimised heat loss (Figure 5.4). Table 5.8 shows the assumptions to calculate the energy saving potential for cooling demand for adaptive ventilation. As mentioned in chapter 4 the use of an adaptive heat loss factor can be suboptimal because of the possible increase in heating demand and lower effect on the cooling demand caused by the change of setpoint temperatures during the day. Figure 5.6 shows the absolute energy consumption in kWh and relative to the reference with adaptive comfort delivery and minimised heat loss factor of § 5.3.2.

ASSUMPTIONS VARIANT ADAPTIVE HEAT LOSS COEFFICIENT					
Assumption		Living room		Bedroom	
Parameter [unit]	Value	Parameter [unit]	Value	Parameter [unit]	Value
<b>H<sub>tot</sub> [W/K] (theoretical composition of the H<sub>tot</sub> in transmission and ventilation)</b>					
<b>property</b>		<b>H<sub>tot</sub> [W/K]</b>	<b>34 - 920</b>	<b>H<sub>tot</sub> [W/K]</b>	<b>16 - 449</b>
R <sub>ζ</sub> [m <sup>2</sup> K/W]	2.5 - 10	H <sub>tr,w</sub> [W/K]	4 - 15	H <sub>tr,w</sub> [W/K]	2.5 - 9
U <sub>w</sub> [W/m <sup>2</sup> K]	1.2 - 5	H <sub>tr,op</sub> [W/K]	10 - 40	H <sub>tr,op</sub> [W/K]	5 - 19
q <sub>v</sub> [l/h]	0.5 - 30	H <sub>ve</sub> [W/K]	14 - 860	H <sub>ve</sub> [W/K]	7 - 424
<b>Solar gain</b>					
f <sub>sol</sub>	0.6*f <sub>glass</sub>	f <sub>sol</sub>	0.4	f <sub>sol</sub>	0.2
<b>Heating and cooling control</b>					
<b>during</b>	<b>presence</b>	<b>absence</b>			
Heating setpoint [°C]	T <sub>comf</sub>	15			
Cooling setpoint [°C]	T <sub>comf</sub> + 2	30			
Setpoint for H <sub>tot</sub> [°C]	T <sub>comf</sub> + 2	T <sub>comf</sub> + 2			

TABLE 5.8 Assumptions variant adaptive heat loss coefficient (approximate values for the distribution of the H<sub>tot</sub>)

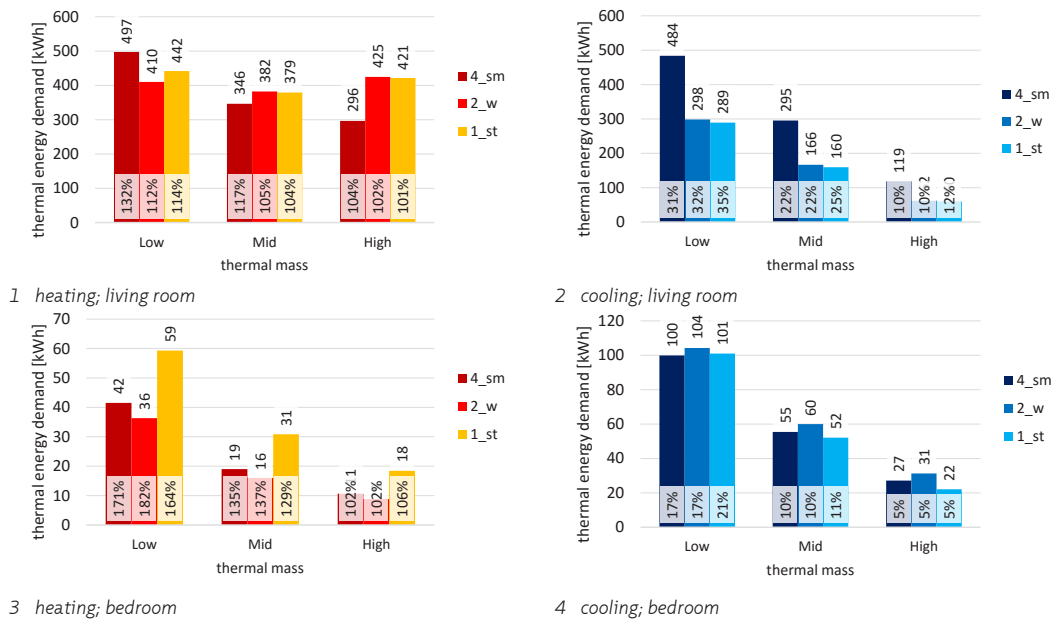


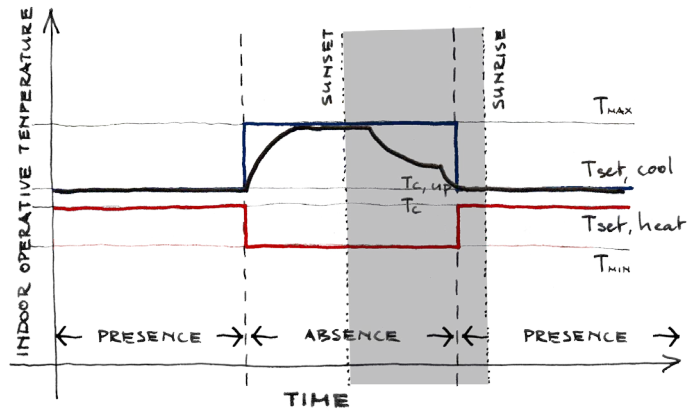
FIGURE 5.6 Thermal energy demand during a year for heating and cooling with adaptive heat loss coefficient (Table 5.8) relative to the reference with adaptive comfort delivery and minimised heat loss factor (Table 5.7).

Figure 5.6 shows that this strategy can save the majority of cooling demand; however, the heating demand goes up as also noted developing the control algorithm in § 4.3.4.1. Figure 5.7 shows the differences in the course of operative temperature that explains the increase in heating.

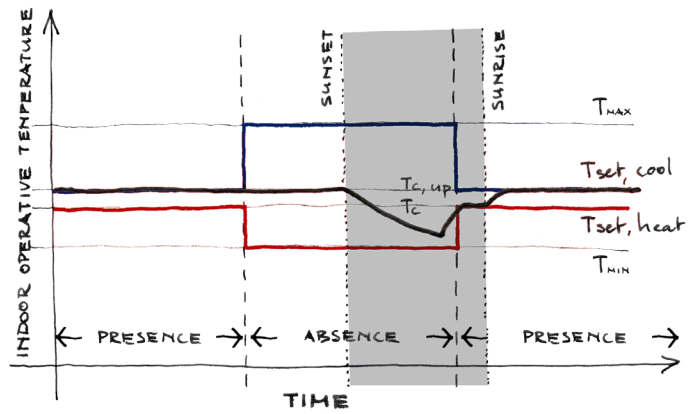
The upper graph (1) depicts an exaggerated version of the course of temperature while the heat loss is minimal. The active cooling keeps the temperature at the upper comfort bandwidth at presence. If the occupants leave the room the setpoint for cooling goes up to the upper limit of 30 °C having the temperature rise rapidly to that threshold due to the solar radiation. The moment the temperature reaches the upper setpoint of 30 °C the active cooling makes sure the temperature doesn't rise above this setpoint. At sunset the temperature begins decreasing (depending on the thermal mass and outdoor temperature) but by the time the occupants arrive and the setpoint for cooling goes down to the upper band of thermal comfort the temperature is still too high so the cooling has to compensate again. This leads to a significant increase of cooling energy but there is no heating demand.

The middle graph (2) depicts the course if the algorithm ([Equation 4.2](#)) is used for adaptive heat loss. This algorithm uses the threshold of the upper comfort bandwidth at absence as well as presence. Therefore, the temperature is kept at this level during absence by adjusting the heat loss factor. As with the former variant the temperature starts decreasing at sunset but the initial temperature is much lower leading the temperature to drop below the comfort temperature which is used as setpoint for heating at presence. The moment the occupants arrive this leads to a heating demand which wasn't there with minimum heat loss.

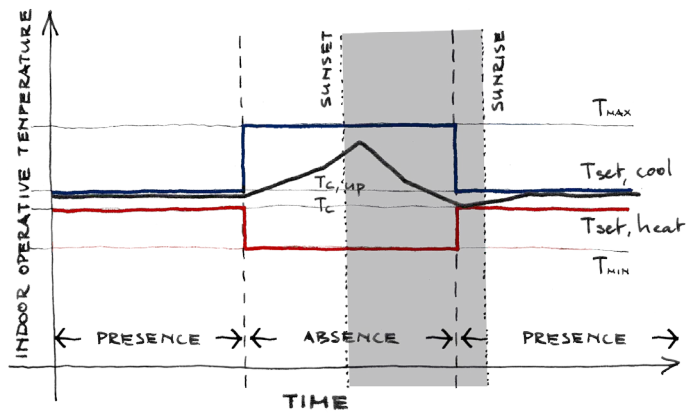
The bottom graph (3) represents the ideal course of temperature having the temperature rise enough during absence to have the temperature decrease during the night not to cause a heating demand. To know what this maximum temperature is before decrease a self learning mechanism could be able to predict the behaviour of the temperature in the course of time using parameters of future demand, outdoor temperature and preferably the change in outdoor temperature during the night.



1 minimum heat loss factor



2 adaptive algorithm



3 predictive adaptive algorithm

FIGURE 5.7 Courses of temperature with different strategies for the heat loss factor

Increasing the threshold temperature to the maximum temperature during absence for passive cooling by increasing the heat loss factor will compromise the energy saving for cooling as in case the occupant arrives after a period of absence the room would have to be cooled actively to the comfort bandwidth. This shows that the control of the heat loss factor can be fine tuned with predictive properties to be dynamically optimised preventing the heat loss factor to cool too much resulting in a heating demand in the near future without compromising the cooling effect.

The full potential of the adaptive approach for an adaptive and predictive algorithm can be seen in Figure 5.8 where the calculations are made for the heating consumption where the setpoint for the heat loss factor is  $T_{max}$  combined with the calculations for cooling with the setpoint for the heat loss factor is  $T_{comf}$ . This shows that the heating load is almost equal to the variant with minimised heat loss factor and only slightly higher in case of low thermal mass. Furthermore, the cooling is reduced more efficiently in case of the lower threshold. Higher thermal mass is favoured above lower thermal mass as the temperatures are more stable and thus the variation in heat loss factor can be more stable. Therefore, an additional measure could be adding extra storage the excessive heat diurnally as what happens with higher thermal mass. To increase the thermal storage a PCM or a dynamic thermal storage (HATS) as described in § 3.4.4 could be applied.

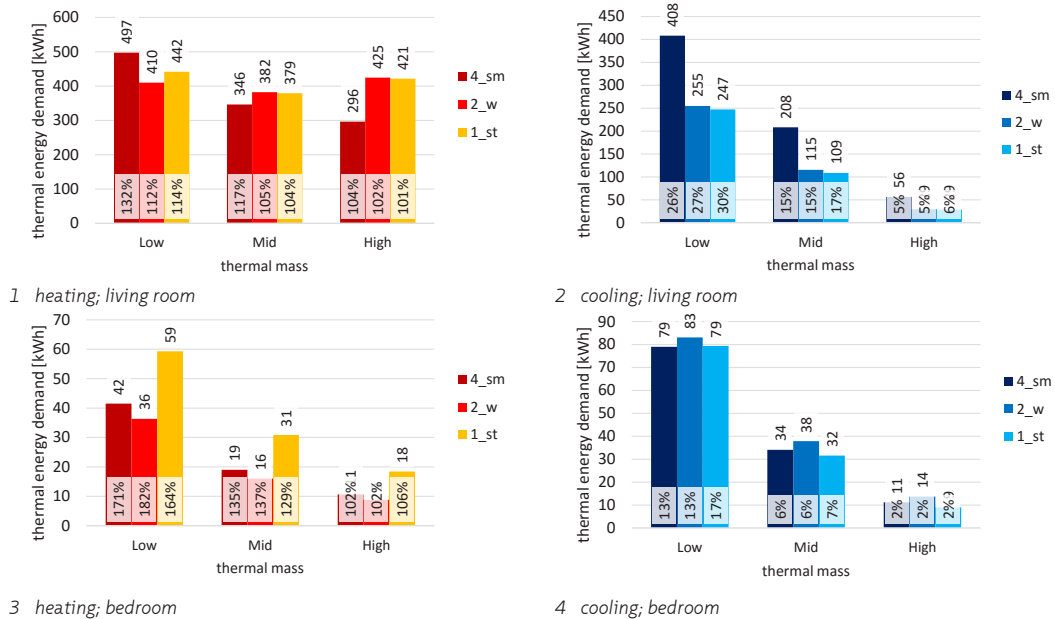
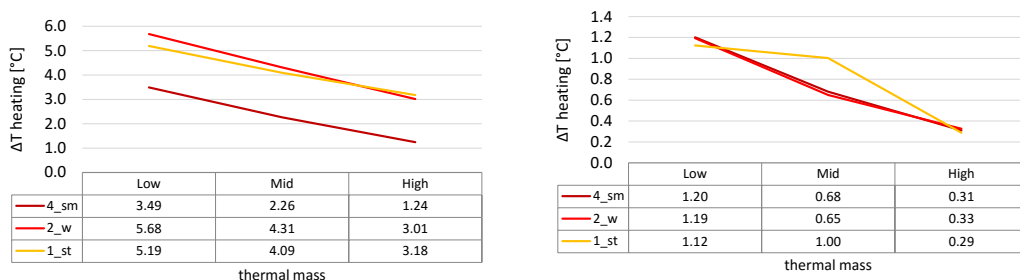


FIGURE 5.8 Thermal energy demand during a year for heating with optimised setpoint temperature for the heat loss factor (Table 5.8) relative to the reference with adaptive comfort delivery and minimised heat loss factor (Table 5.7)

Figure 5.9 shows the required heat up speed by showing the 95% percentiles for the step change in indoor air temperature at times of change in setpoint temperature (heat up or cool down after a period of absence).



1 heating; living room

2 heating; bedroom

FIGURE 5.9 Heat-up-speed a 95% percentiles living room and bedroom with adaptive heat loss factor (Table 5.8);  $\Delta T$  = temperature difference to be made by heating or cooling from one time-step to the next at change of setpoint temperature, maximum in 95% of the time

From Figure 5.9 it becomes clear that by stabilising the temperature by an adaptive heat loss factor the heat up speed will be similar to the adaptive heating variant with lower thermal mass; however, significantly lower with high thermal mass with values around 4 °C.

### § 5.3.3.1 Required range of heat loss factors

Figure 5.10 shows the 95% percentiles (1,2) and average values (3,4) of the desired  $H_{tot}$ . In the data tables below the figures the desired  $H_{tot}$  is expressed in the ventilation rate (ACPH [1/h]) required to obtain the  $H_{tot}$  for all the cases as well as the insulation value ( $U$  [W/m<sup>2</sup>K]) to provide the required  $H_{tot}$  for 95% percentiles(1,2) and average values (3,4) for an Adaptive Thermal Comfort System with adaptive  $H_{tot}$  (Table 5.8).

During 5% of the year the required heat loss coefficient to reach the comfort temperature still is very high up to 11.6 1/h equivalent ventilation rate. This means that there are very high extremes; however, most of the year the values are in a practical value and the average heat loss coefficients are much lower. If the  $H_{tot}$  should be reached by changing the transmission this would mean creating  $U$ -values of over 6 W/m<sup>2</sup> resulting in negative  $R_c$  values which means the resistance of the air boundary air layers of 0.17 m<sup>2</sup>K/W would be already blocking too much heat transmission. This means that to change the  $H_{tot}$  by increasing the transmission is far less feasible than changing the ventilation rate unless highly conductive materials could be combined with low conductivity material. The average  $U$ -values are in a more feasible range but still would result in near zero  $R_c$  values. Removing the façade element all together

would increase the  $H_{tot}$  but this would be mainly because of the direct heat loss by ventilation. Thus, developing new techniques for increasing the heat loss factor by transmission is only competitive to ventilation if these high conductive properties can be incorporated in new materials or techniques.

The required heat loss factors are significantly lower if the thermal mass is higher in both the extreme situations as the average and the required heat loss factor increases with the occupancy rate. This corresponds with the overall effect that the high thermal mass variant requires less cooling and a high occupancy rate corresponds with higher cooling demand (§ 5.2.6).

It should be noted that the required ventilation rate will be much lower if also adaptive solar gain is applied which emphasises interdependence of the two strategies making the passive cooling by increasing the heat loss factor by transmission more feasible (§ 5.3.5).

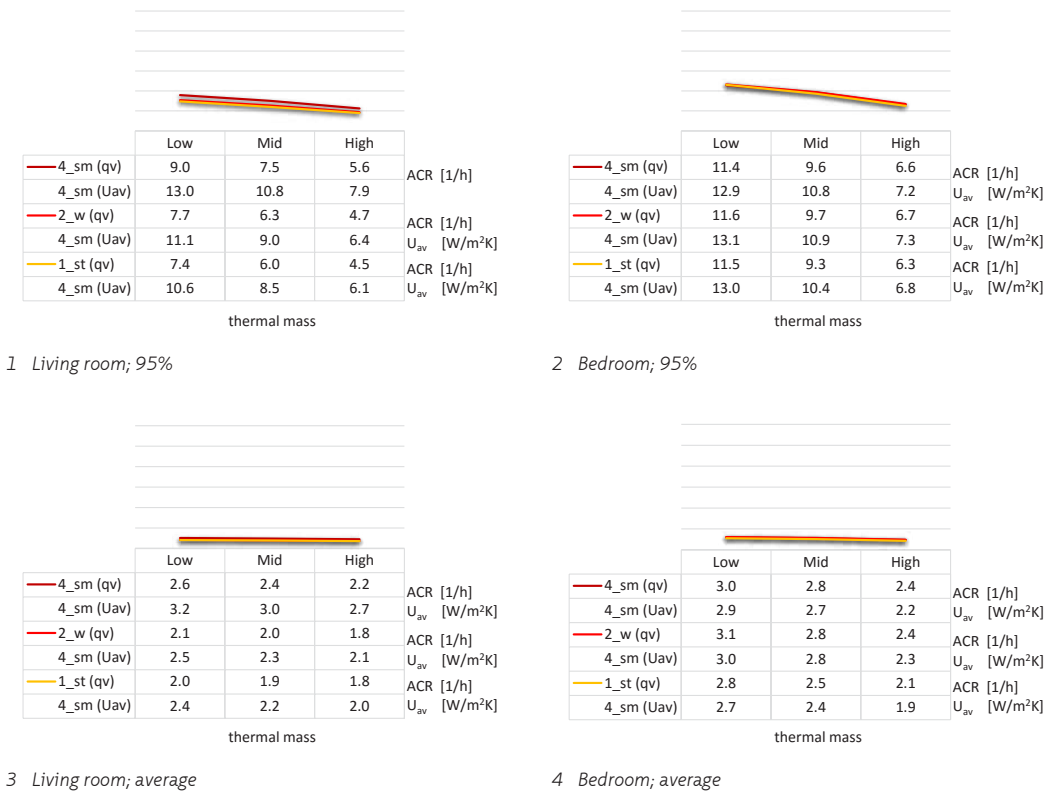


FIGURE 5.10 Ventilation rate (ACPH [1/h]) and insulation ( $U_{av}$  [W/m<sup>2</sup>K]) to provide the required  $H_{tot}$  for 95% of the time (1,2) and average (3,4) for an Adaptive Thermal Comfort System with adaptive  $H_{tot}$  only

### § 5.3.4 Adaptive solar factor

Another way to optimise between heating season and summer is to combine a fixed insulation level and minimised ventilation with maximum solar gain in the winter and blocking the sunlight when overheating is impending. Figure 5.11 shows Thermal energy demand during a year for heating and cooling for the living room and bedroom for adaptive solar factor with the assumptions of Table 5.9 absolute in kWh and relative to the reference with minimised heat loss coefficient of § 5.3.2. As mentioned in chapter 4 the use of an adaptive solar can be suboptimal because of the possible increase in heating demand and lower effect on the cooling demand caused by the change of setpoint temperatures during the day as explained in Figure 5.7.

ASSUMPTIONS VARIANT ADAPTIVE SOLAR FACTOR					
Assumption		Living room		Bedroom	
Parameter [unit]	Value	Parameter [unit]	Value	Parameter [unit]	Value
<b><math>H_{tot,min}</math> [W/K]</b>					
<b>property</b>	<b>min</b>	<b><math>H_{tot,min}</math> [W/K]</b>		<b><math>H_{tot,min}</math> [W/K]</b>	
$R_{\zeta}$ [Km <sup>2</sup> /W]	10	$H_{tr,w}$ [W/K]	12.1	$H_{tr,w}$ [W/K]	4.3
$U_w$ [W/m <sup>2</sup> K]	1.2	$H_{tr,op}$ [W/K]	4.1	$H_{tr,op}$ [W/K]	2.4
$q_v$ [l/h]	0.5 + 0.2*p	$H_{ve}$ [W/K]	14.3+5.7*p	$H_{ve}$ [W/K]	7.2+2.9*p
<b>Solar gain</b>					
<b>maximal solar factor</b>					
$f_{sol,max}$	1	$f_{sol}$	1	$f_{sol}$	1
<b>minimal solar factor</b>					
$f_{sol,min}$	0	$f_{sol}$	0	$f_{sol}$	0
<b>Heating and cooling control</b>					
<b>during</b>	<b>presence</b>		<b>absence</b>		
Heating setpoint [°C]	$T_{comf}$		15		
Cooling setpoint [°C]	$T_{comf} + 2$		30		
Setpoint for $H_{tot}$ [°C]	$T_{comf} + 2$		$T_{comf} + 2$		

TABLE 5.9 Assumptions variant adaptive solar factor



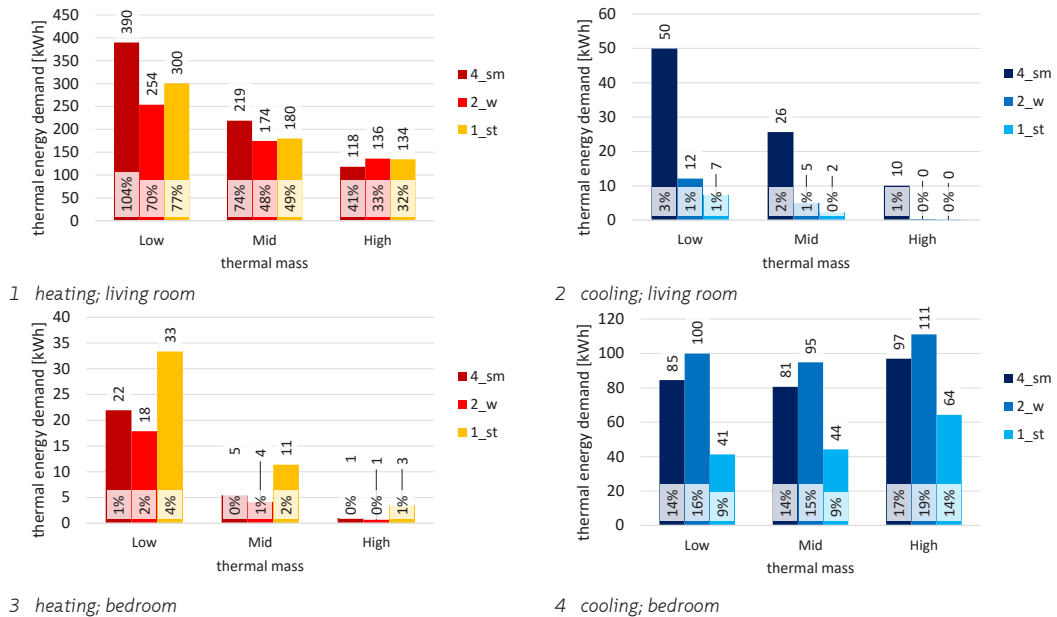
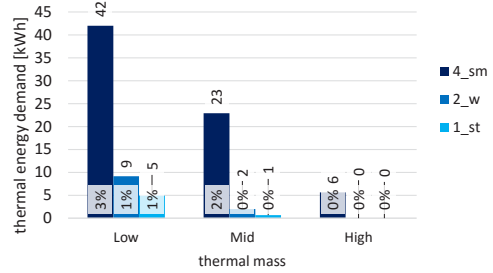
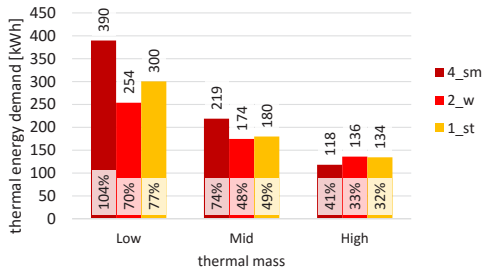


FIGURE 5.11 Thermal energy demand during a year for heating and cooling with adaptive  $f_{soi}$  absolute [kWh] and relative [%] to the reference with minimised heat loss factor and adaptive comfort delivery (Table 5.7).

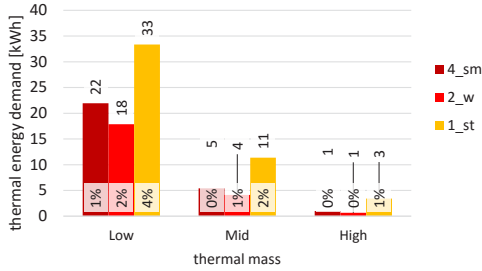
Figure 5.11 shows that this strategy is more effective against overheating than the strategy with adaptive  $H_{tot}$  especially for the living room where very little cooling demand is remaining. There is a significant difference between the thermal mass variants with higher cooling load for the lower thermal mass; however, only for the 4 people household there is still a notable amount of cooling demand. The bedroom still has a significant cooling load; while, this is decreased with around 85%. In the bedrooms lower temperatures are appreciated than in the living room and during the day heat can build up especially with lower thermal mass. In the bedrooms the effectiveness of the adaptive solar gain for overheating prevention is similar to the effectiveness of the previous measure (adaptive heat loss factor).

Figure 5.11 also shows that with the occupancy profile of the 4 person household the heating load for the living room goes up slightly relative to the fixed solar factor because of the instability of the room temperature as described in § 5.3.3 of the reference and in the other occupancy cases the heating load decreases significantly.

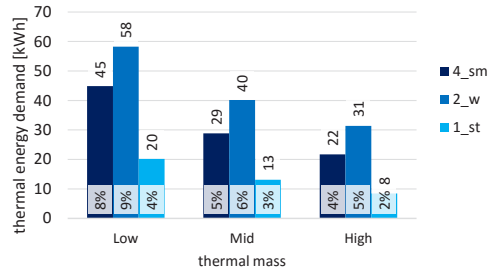
However, the full potential of the adaptive approach for an adaptive and predictive algorithm can be seen in where the calculations are made for the heating consumption where the setpoint for the heat loss factor is  $T_{max}$  combined with the calculations for cooling with the setpoint for the heat loss factor is  $T_{comf}$ .



1 heating; living room



2 cooling; living room



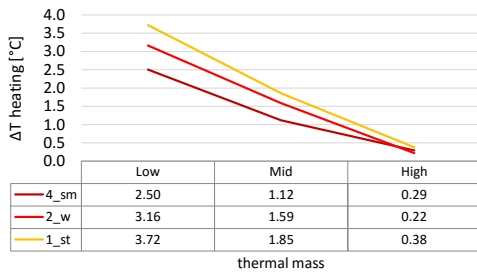
3 heating; bedroom

4 cooling; bedroom

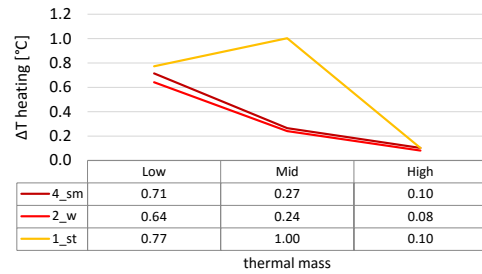
FIGURE 5.12 Thermal energy demand during a year for heating and cooling with optimised setpoint temperature for the solar factor absolute [kWh] and relative [%] to the reference with minimised heat loss factor and adaptive comfort delivery (Table 5.7).

Figure 5.12 shows that possibly increasing the solar factor could yield more energy saving in all cases if the setpoint temperature for the solar factor is optimised. This leads to the conclusion that the algorithm can be fine-tuned with predictive characteristics as with the algorithm for the heat loss factor in the previous section. Furthermore, adding extra diurnal thermal storage can increase the energy saving potential for both heating as cooling as described in § 5.3.3

Figure 5.13 shows the required heat up speed by showing the 95% percentiles for the step change in indoor air temperature at times of change in setpoint temperature (heat up or cool down after a period of absence).



1 heating; living room



2 heating; bedroom

**FIGURE 5.13** Heat-up-speed 95% percentiles living room and bedroom with adaptive solar factor (Table 5.9);  $\Delta T$  = temperature difference to be made by heating or cooling from one time-step to the next at change of setpoint temperature, maximum in 95% of the time

From Figure 5.13 it becomes clear that by added solar gain the needed heat up speed will be significantly lower with values of under 4 °C with lower thermal mass and lower than 0.5 °C with higher thermal mass. This emphasises the usefulness of thermal mass to stabilise the indoor temperature.

### § 5.3.5 Adaptive heating, heat loss factor and solar factor combined

The Adaptive Thermal Comfort System combines the former three adaptive strategies of the adaptive thermal comfort delivery, adaptive heat loss factor ( $H_{tot}$ ) and adaptive solar factor ( $f_{sol}$ ). Figure 5.14 shows the Thermal energy demand during a year for heating and cooling for the different combinations of occupancy profile and thermal mass level for the combination of dynamic  $H_{tot}$  and  $f_{sol}$  for the living room and bedroom, relative to the reference situation with adaptive heating and cooling. Figure 5.16 shows the Thermal energy demand during a year for heating and cooling with optimised setpoint temperature for  $H_{tot}$  and  $f_{sol}$ . Table 5.10 shows the assumptions for the calculations of the Adaptive Thermal Comfort System.

ASSUMPTIONS VARIANT ADAPTIVE HEAT LOSS COEFFICIENT					
Assumption		Living room		Bedroom	
Parameter [unit]	Value	Parameter [unit]	Value	Parameter [unit]	Value
<b><math>H_{tot}</math> [W/K] (theoretical composition of the <math>H_{tot}</math> in transmission and ventilation)</b>					
property		$H_{tot}$ [W/K]	34 - 920	$H_{tot}$ [W/K]	16 - 449
$R_{\zeta}$ [m <sup>2</sup> K/W]	2.5 - 10	$H_{tr,w}$ [W/K]	4 - 15	$H_{tr,w}$ [W/K]	2.5 - 9
$U_w$ [W/m <sup>2</sup> K]	1.2 - 5	$H_{tr,op}$ [W/K]	10 - 40	$H_{tr,op}$ [W/K]	5 - 19
$q_v$ [l/h]	0.5 - 30	$H_{ve}$ [W/K]	14 - 860	$H_{ve}$ [W/K]	7 - 424
<b>Solar gain</b>					
$f_{sol}$	0 - 1				
<b>Heating and cooling control</b>					
during	presence	absence			
Heating setpoint [°C]	$T_{comf}$	15			
Cooling setpoint [°C]	$T_{comf} + 2$	30			
Setpoint for $H_{tot}$ [°C]	$T_{comf} + 2$	$T_{comf} + 2$			

TABLE 5.10 Assumptions variant Adaptive Thermal Comfort System (approximate values for the distribution of the  $H_{tot}$ )

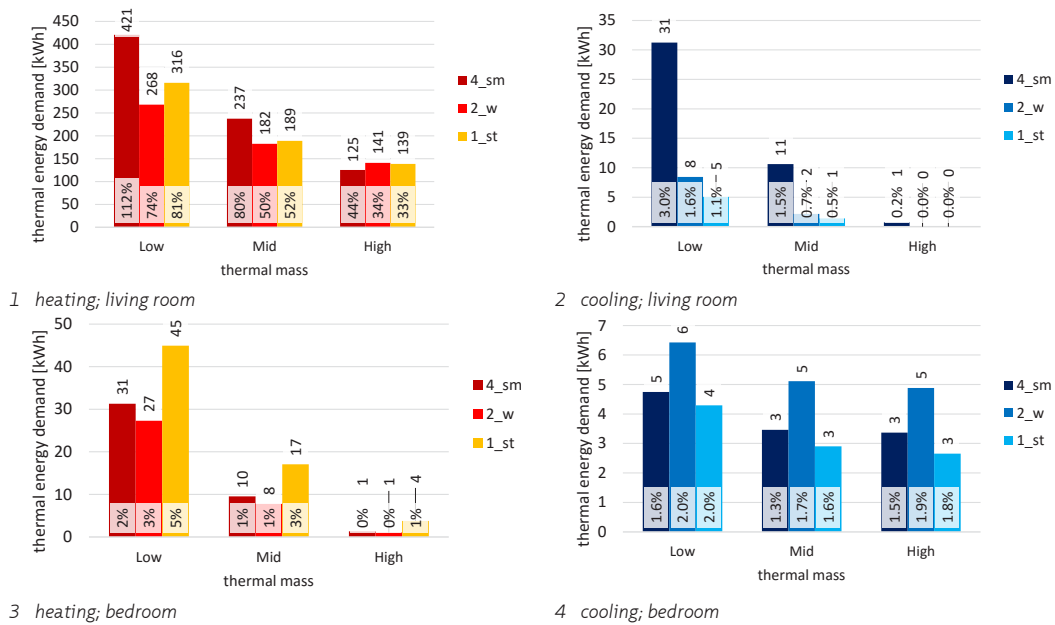


FIGURE 5.14 Thermal energy demand during a year for heating and cooling with adaptive  $H_{tot}$  and  $f_{sol}$  absolute [kWh] and relative [%] to the reference (Table 5.5).

Figure 5.14 shows that in all cases the need for cooling can be effectively decreased to less than 2.5 kWh per year (except for the low thermal mass variant in the living room with the 4 person household, still 5.7 kWh remains) even in the reference year 2050 W+. This is presumably effective enough to eliminate the need to install active cooling.

There is an energy saving for heating but the adaptive heat loss factor does increase the heating demand in case of the low thermal mass with the four person household. This leaves an extra heating demand compared to the reference situation with minimised heat loss factor and average solar factor as is the case with the adaptive heat loss factor in § 5.3.3. Furthermore, the energy demand for heating is higher than with only adaptive solar factor. This shows that the control of the heat loss factor can be fine tuned with predictive properties to be dynamically optimised preventing the heat loss factor to cool too much resulting in a heating demand in the near future without compromising the cooling effect.

The full potential of the adaptive approach for an adaptive and predictive algorithm can be seen in Figure 5.16 where the calculations are made for the heating consumption where the setpoint for the heat loss factor and solar factor is  $T_{max}$  combined with the calculations for cooling with the setpoint for the heat loss factor and solar factor is  $T_{comf}$ . This shows that by optimizing the setpoint temperature the heating can be drastically lowered. Higher thermal mass is favoured above lower thermal mass as the temperatures are more stable and thus the variation in heat loss factor can be more stable. Therefore, an additional measure could be adding extra storage the excessive heat diurnally as what happens with higher thermal mass. To increase the thermal storage a PCM or a dynamic thermal storage (HATS) as described in § 3.4.4 could be applied.

Figure 5.15 shows the required heat up speed by showing the 95% percentiles for the step change in indoor air temperature at times of change in setpoint temperature (heat up or cool down after a period of absence).

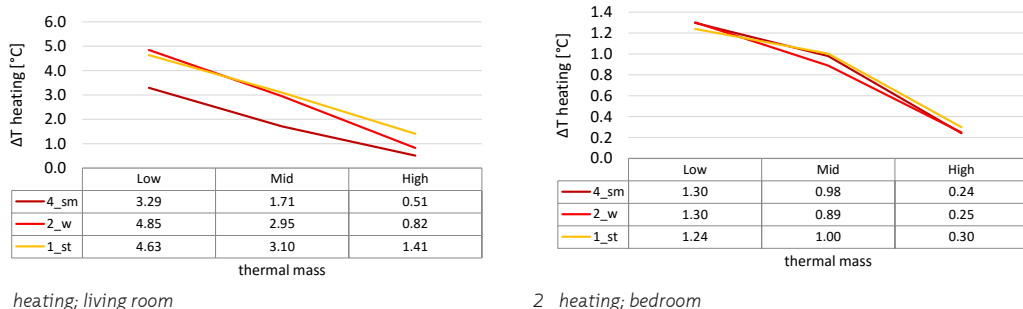


FIGURE 5.15 Heat-up-speed 95% percentiles living room and bedroom with adaptive heat loss factor and solar factor (Table 5.10);  $\Delta T$  = temperature difference to be made by heating or cooling from one time-step to the next at change of setpoint temperature, maximum in 95% of the time

From Figure 5.15 shows that with combined adaptive measures the heat up speed will be closer to realistic requirements for existing heating systems especially with higher thermal mass mainly due to the added solar gain. This emphasises the usefulness of thermal mass to stabilise the indoor temperature.

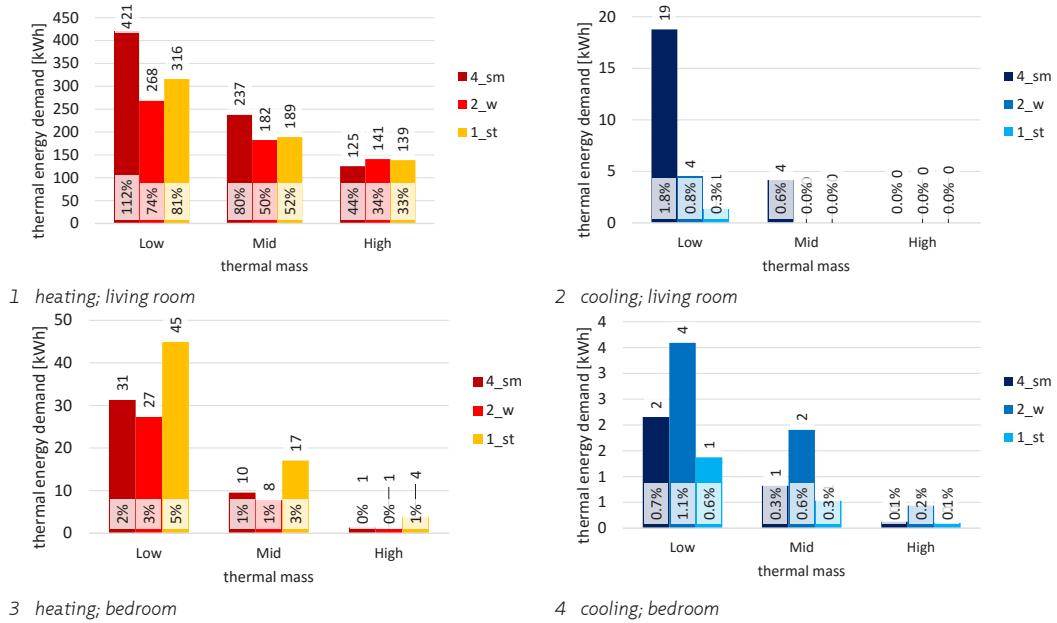
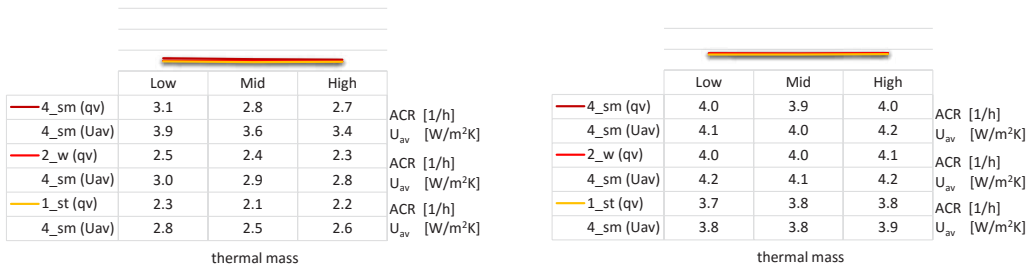


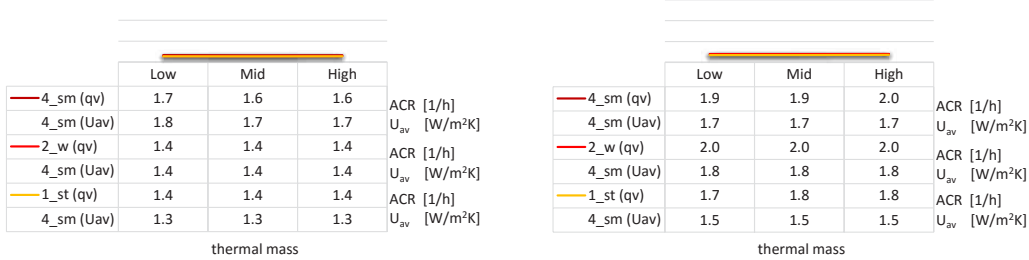
FIGURE 5.16 Thermal energy demand during a year for heating and cooling with optimised setpoint temperature for both the heat loss factor and the solar factor absolute [kWh] and relative [%] to the reference (Table 5.5)

Figure 5.17 shows the 95% percentiles (1,2) and average values (3,4) of the desired  $H_{tot}$  in case both the heat loss factor as the solar factor are adaptive. In the data tables below the figures the desired  $H_{tot}$  is expressed in the ventilation rate (ACPH [1/h]) required to obtain the  $H_{tot}$  for all the cases as well as the insulation value ( $U$  [W/m<sup>2</sup>K]) to provide the required  $H_{tot}$  for 95% percentiles(1,2) and average values (3,4) for an Adaptive Thermal Comfort System with adaptive  $H_{tot}$  (Table 5.8).



1 Living room; 95%

2 Bedroom; 95%



3 Living room; average

4 Bedroom; average

FIGURE 5.17 Ventilation rate (ACPH [1/h]) and insulation (U<sub>av</sub> [W/m<sup>2</sup>K]) to provide the required H<sub>tot</sub> for 95% of the time (1,2) and average (3,4) for an Adaptive Thermal Comfort System with adaptive H<sub>tot</sub> combined with adaptive f<sub>sol</sub>

The values for the heat loss coefficient are drastically lower than if only the heat loss factor is adaptive. This could be expected because most of the overheating will already be prevented by blocking the solar radiation when needed. During 5% of the year the required heat loss coefficient to reach the comfort temperature still is a feasible value requiring around 2 1/h ACPH if only created by extra ventilation and U-values of 1 to 2 if the ventilation is minimised. This means that in combination with adequate adaptive solar gain the option of adapting the heat loss by transmission becomes more feasible. In the future thermal diodes as mentioned in § 3.4.3 might become an alternative to increasing ventilation.

As with the adaptive heat loss factor without solar radiation the required heat loss factors are lower with higher thermal mass in both the extreme situations as the average and in the profiles with higher occupancy rate higher maximum heat loss factors are required; however, the differences are smaller because of the solar radiation already preventing most of the overheating.

### § 5.3.6 Orientation

For the  $f_{sol}$  the orientation of the room plays a significant role. Therefore the calculation is repeated with the orientation to the North. Figure 5.18 shows the absolute energy use [kWh] for respectively heating and cooling in case of adaptive heating for the North orientation and relative to the South orientation [%].

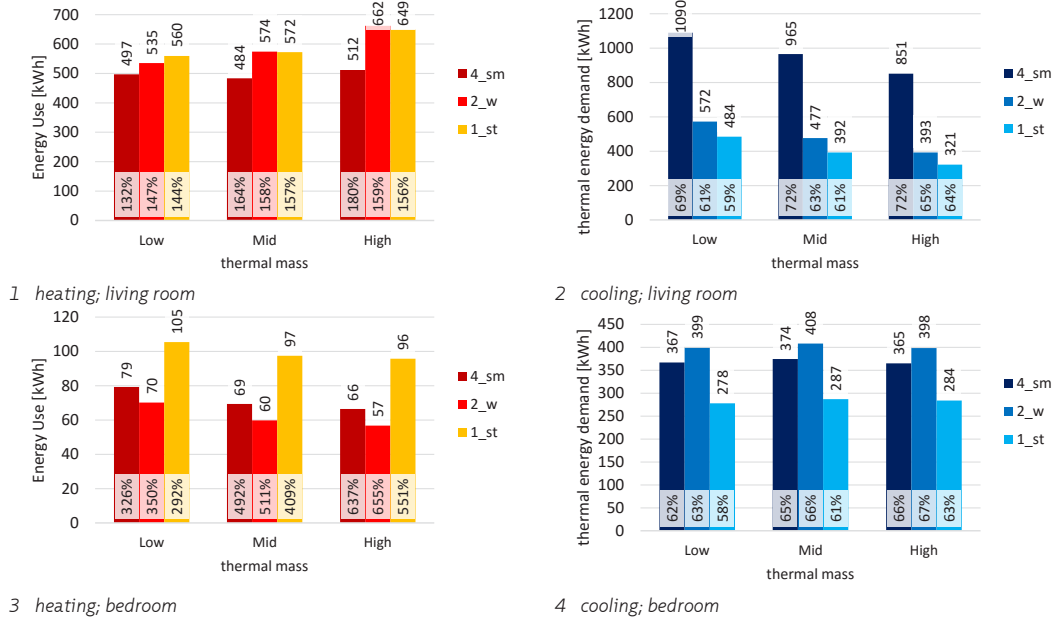


FIGURE 5.18 Thermal energy demand during a year for heating and cooling in the reference situation with adaptive heating and minimised ventilation (Table 5.7) North orientation absolute [kWh] and relative to the South orientation [%]

As can be expected, the heating load in the situation with minimised ventilation and adaptive heating is around 50% higher in the living room and around many times higher for the bedroom than for the South orientation and the cooling load is around 40% lower. It stands out that in the reference cases for the North orientation the heating demand is significantly higher with high thermal mass. This confirms the conclusion of the former sections that the lower heating demand for higher thermal mass is in fact due to the accumulation of the solar radiation. In case of the North orientation with average solar factor this doesn't occur.

Figure 5.18 shows the absolute energy use [kWh] for respectively heating and cooling in case of an adaptive solar factor (with minimised ventilation and adaptive heating) for the North orientation and relative to the South orientation [%].



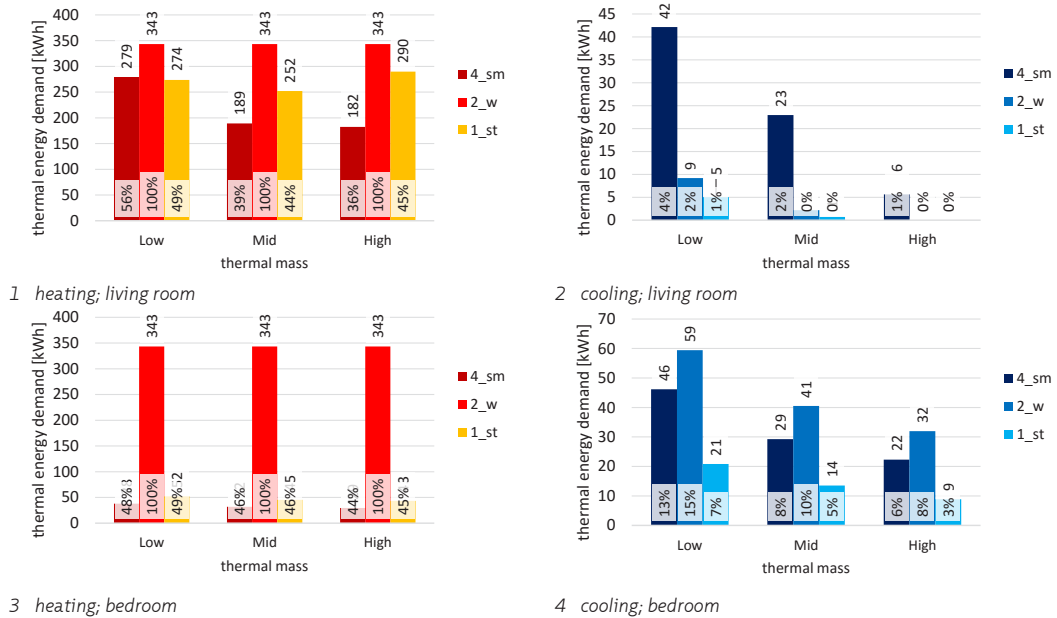


FIGURE 5.19 Thermal energy demand during a year for heating in the case of maximum solar factor and cooling in case of minimum solar factor (Table 5.9) absolute [kWh] and relative to the reference situation [%] (Table 5.7); North orientation

Figure 5.18 clearly shows that raising the solar factor in winter results in significantly higher remaining heating loads than if the orientation was to the South. There is an energy saving potential of increasing the solar factor in winter (approximately 70% for the South orientation compared to approximately 50% for the North orientation with in case of the living room with highest occupancy an increase in heating); though the resulting energy demand for heating is 1.5 to 4 times as high as with the South orientation. It is remarkable that the thermal mass has significantly lower impact influence on the energy saving potential in the North orientation depending on the occupant schedule. This emphasises the beneficial effect of the accumulation of solar radiation by thermal mass.

As expected the resulting cooling load with the adaptive solar factor is the same as with the South orientation; however because the original cooling for the reference situation is much lower for the North orientation the energy saving is much lower. The influence of adapting the solar factor on both heating and especially cooling is significantly less than with the Northern orientation. Because of the smaller effect with large ranges in solar factor together with the fact that the cooling load is already significantly lower for the Northern orientation, adapting the solar factor on the Northern façade can be considered to be omitted.

## § 5.3.7 Change rates of the Adaptive Thermal Comfort System

Figure 5.20 shows the energy use for heating and cooling for the living room in the low and high thermal mass case for four different frequencies of switching the heat loss coefficient and solar factor; fixed values (reference), seasonal optimisation, monthly optimisation, daily optimisation and hourly optimisation. The latter is optimisation per time step as used in § 5.3.3, § 5.3.4 and § 5.3.5. The shown situation is the profile with 2 occupants because in this situation both heating and cooling is decreased by the heat loss algorithm (Equation 4.1) and solar factor algorithm (Equation 4.2). To calculate the values for the controlled periods (season; month; day; hour) the average of the values for the  $H_{tot}$  and  $f_{sol}$  for that particular period for the dynamic behaviour on hourly base are calculated and used as the optimal setting for that particular period (e.g. season; month; day; hour).

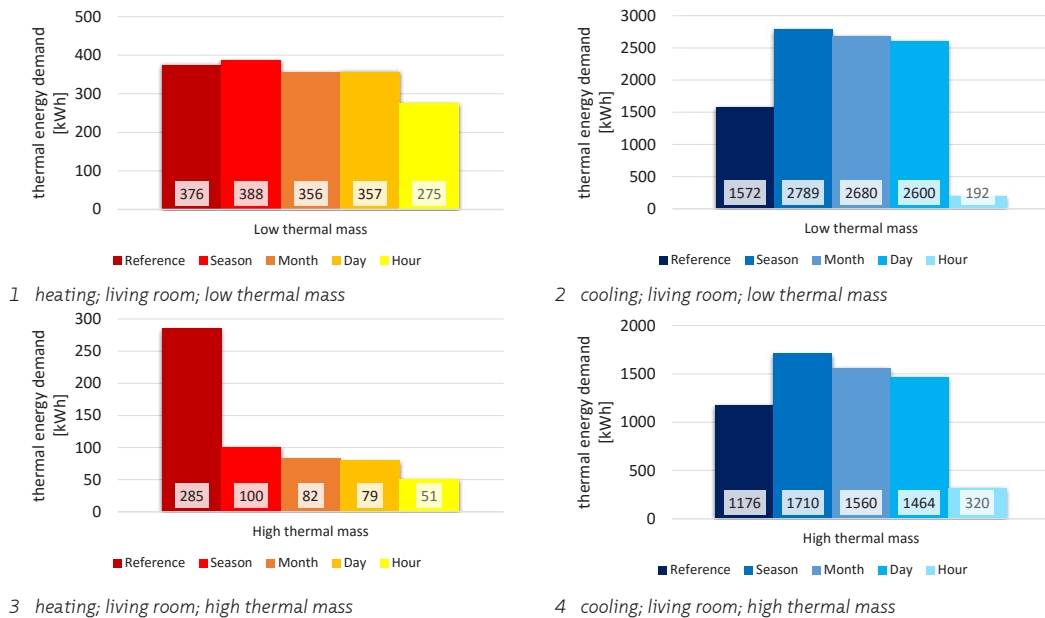


FIGURE 5.20 Energy use heating and cooling for the living room (4-sm; high and low thermal mass) for different frequencies of switching the  $H_{tot}$  and the  $f_{sol}$

From Figure 5.20 it can be seen that the switching frequency of the values is very important for cooling especially. If applied in frequencies lower than hourly the cooling demand increases compared to the reference situation while the heating demand decreases according to the increase of the frequency. Hourly switch clearly has the

largest energy saving potential which makes other switching frequencies not viable. It should be noted that these calculations are made with optimisation of the setpoint temperature for the adaptive heat loss factor and solar factor as described in § 5.3.3, § 5.3.4 and § 5.3.5.

### § 5.3.8 Automation versus manual operation

Figure 5.21 to Figure 5.23 show the energy saving potential for heating and cooling for automated operation and operation during presence for the living room in all combinations of occupancy profiles and thermal mass level, by comparing the energy consumption with the reference situation for the living room which has the highest occupancy differences between profiles.

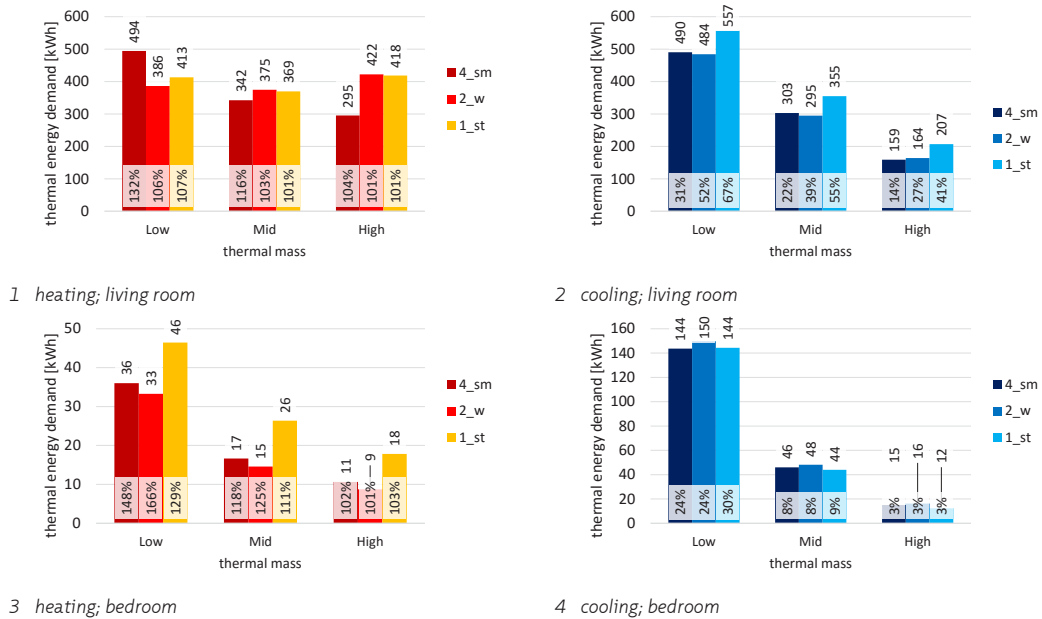
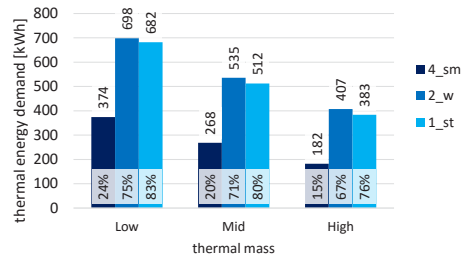
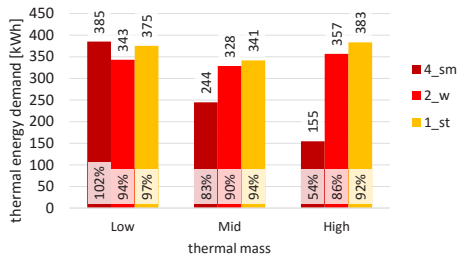
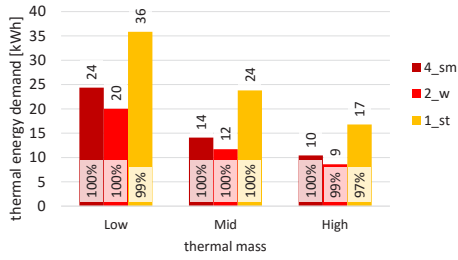


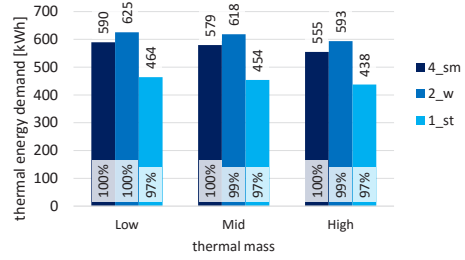
FIGURE 5.21 Energy use heating and cooling (4\_sm) for adaptive  $H_{tot}$  only operated at presence



1 heating; living room



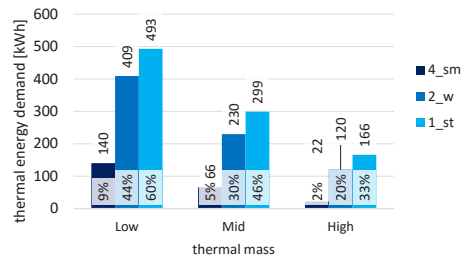
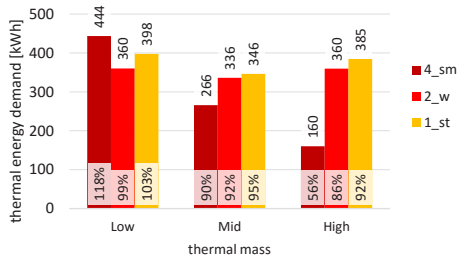
2 cooling; living room



3 heating; bedroom

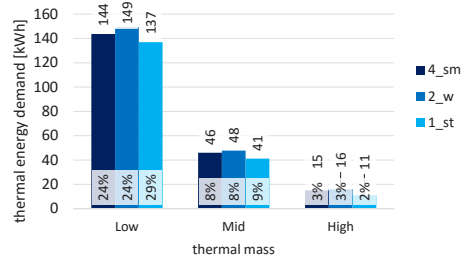
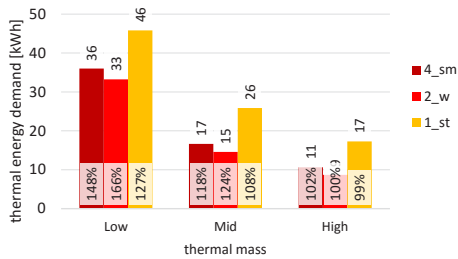
4 cooling; bedroom

FIGURE 5.22 Energy use heating and cooling (4\_sm) for adaptive  $f_{sol}$  only operated at presence



1 heating; living room

2 cooling; living room



3 heating; bedroom

4 cooling; bedroom

FIGURE 5.23 Energy use heating and cooling (4\_sm) for adaptive  $H_{tot}$  and  $f_{sol}$  only operated at presence

Figure 5.21 to Figure 5.23 show that as expected there is a significant advantage in energy saving for cooling in the case of automated control and the heating increases without automation. Therefore, it is essential for the Adaptive Thermal Comfort System to be able to control the building characteristics also during absence of the occupant. Table 5.11 shows the increase in efficiency of automation opposed to non-automated control. Automation has most effect on lower thermal mass as with no automation the stabilizing effect of the temperature is compromised during absence. Furthermore, as expected automation had significant more effect with low occupancy rates.

---

## § 5.4 Conclusions and remarks

---

In this chapter requirements for the dynamic behaviour of the Adaptive Thermal Comfort System (physical properties of the whole of passive and active components) were derived. Through calculating various strategies in heating and prevention of overheating by using the building shell as a dynamically adaptable filter between outdoor and indoor thermal environment (individually variable thermal insulation, ventilation, solar gain and thermal mass) the advantages and disadvantages of the control strategies are researched. The values mentioned below are based on the proportions of the reference dwelling of AgentschapNL and in the Dutch climate.

### Generic physical properties

The calculations are based on generic physical properties that are regarded to be disconnected (e.g. adapting the glass percentage for the solar factor has no influence on the transmission properties of the facade) to be able to isolate the individual parameters in order to encourage development of new concepts for materials and techniques.

### § 5.4.1 Energy saving potential of the adaptive measures

---

Dynamic physical properties as solar gain, ventilation and thermal insulation do have a significant potential of reducing the energy demand of a dwelling whilst not compromising thermal comfort. The energy saving potential of the adaptive approach relative to the reference dwelling of AgentschapNL is very high regarding the following conditions;

### Solar gain for passive heating

Above the energy saving of adaptive heating and minimizing the heat loss factor by high insulation values and ventilation controlled by presence the adaptive approach offers the possibility of increasing the solar gain without causing overheating. This significant amount of energy saving can only be obtained in the theoretical case if the solar factor can be disconnected from the heat loss factor and a 100% of the solar radiation hitting the facade can be used as heat gain (Solar factor 1). (§ 5.3.3 and § 5.3.4). However, **the ultimate energy saving potential for heating and cooling can be higher in practice if there is some form of prediction by an Adaptive Model Predictive Control (self-learning control) (§ 3.6.4) with anticipation of future comfort demand** because the passive cooling by adaptive solar gain (as well as the adaptive heat loss factor) controls the indoor temperature to the comfort bandwidth even at absence; this means that as opposed to controlling at higher set point temperature during absence the room temperature can be lower at the end of the day causing the threshold for heating to be reached earlier as result of the gradual temperature drop during the night. A self learning mechanism could be able to predict the behaviour of the temperature in the course of time using parameters of future demand, outdoor temperature and the drop in outdoor temperature during the night.

### Cooling

Applying the variable building characteristics as described in this chapter the cooling can be eliminated in most situations and will be 10% of the initial value at most. The remaining cooling demand will be low enough to cancel the need for installation of active cooling. It is most effective to use both an adaptive heat loss factor and solar factor; however, of the two the solar factor is most effective.

### Optimizing between heating and cooling

It is crucial for the Adaptive Thermal Comfort System to be controlled to optimise between heating and cooling. However, cooling uses more primary energy than heating and if there is no significant overheating in the dwelling an active cooling system is not necessary as opposed to a heating system. Therefore, the goal is to decrease cooling to an absolute minimum with as little added heating load as possible. This requires a fine tuning of the control system with predictive properties (§ 5.3.3 ; § 5.3.4 ; § 5.3.5).

The energy saving potentials of the separate solutions are given in [Table 5.11](#). It should be noted that these energy saving potentials cannot just be added together to determine the potential of the combined measures. The total energy saving potential of the added measures is therefore mentioned in the bottom of [Table 5.11](#). An additional measure could be adding extra storage the excessive heat diurnally as what happens with higher thermal mass. To increase the thermal storage a PCM or a dynamic thermal storage (HATS) as described in [§ 3.4.4](#) could be applied.

		4SM		2W		1ST		AVERAGE	
		living room	bedroom	living room	bedroom	living room	bedroom	living room	bedroom
adaptive heating	energy saving potential <sup>1</sup>								
	heating	12% - 23%	17% - 20%	37% - 48%	16% - 19%	41% - 47%	13% - 14%	34%	16%
	overheating	-	-	-	-	-	-	-	-
minimised heat loss	ACPH [1/h]	0.5+0.2*p		R <sub>c,op</sub> [Km <sup>2</sup> /W]		10		U <sub>w</sub> [W/ Km <sup>2</sup> ]	1.2
	energy saving potential <sup>1</sup>								
	heating	67% - 74%	87% - 93%	64% - 65%	88% - 94%	63% - 65%	86% - 92%	66%	90%
	overheating !	-	-	-	-	-	-	-	-
adaptive heat loss	ACPH [1/h] <sup>2</sup>	0.5 - 30		R <sub>c,op</sub> [Km <sup>2</sup> /W]		2.5 - 10		U <sub>w</sub> [W/ Km]	1.2
	energy saving potential <sup>1,3</sup> (*)								
	heating !!	-5% - 0%	-2% - 0%	-1% - 0%	-3% - 0%!!	-1% 0%!!	-2% - 0%!!	-1%	-1%
	automated <sup>6</sup>	3% - 32%	1% - 12%	1% - 7%	0% - 15%	1% - 8%	0% - 6%	9%	6%
	overheating	74% - 95%	78% - 98%	73% - 95%	87% - 98%	70% - 94%	83% - 98%	84%	92%
	automated <sup>6</sup>	5% - 9%	1% - 11%	22% - 25%	0% - 11%	35% - 38%	1% - 14%	22%	6%
adaptive solar factor	F <sub>c</sub>	0 - 1							
	energy saving potential <sup>1,4</sup> (*)								
	heating !!	33% - 83%	69% - 100%	53% - 81%	72% - 100%	48% - 81%	66% - 93%	63%	83%
	automated <sup>6</sup>	36% - 52%	96% - 100%	49% - 68%	72% - 99%	46% - 74%	66% - 90%	54%	83%
	overheating	97% - 100%	92% - 96%	99% - 100%	91% - 95%	99% - 100%	96% - 98%	99%	95%
	automated <sup>6</sup>	15% - 21%	96% - 92%	67% - 74%	90% - 94%	76% - 82%	93% - 95%	56%	93%
ACTS	energy saving potential <sup>1,5</sup>								
	heating	27% - 82%	99% - 100%	50% - 80%	99% - 100%	44% - 81%	99% - 100%	61%	99%
	automated <sup>6</sup>	36% - 50%	101% - 114%	50% - 68%	100% - 117%	49% - 74%	97% - 105%	55%	105%
	overheating	98% - 100%	100%	99% - 100%	100%	100%	100%	100%	100%
	automated <sup>6</sup>	2% - 7%	3% - 24%	20% - 43%	2% - 23%	33% - 59%	2% - 28%		

- 1 These values are based on the generic calculations of this chapter and are based on the reference dwelling of AgentschapNL. The variation in energy saving potential per situation depends on the thermal mass level.
- 2 The range of H<sub>tot</sub> is given in the amount of ventilation needed with the average values of insulation (R<sub>c</sub> = 5 m<sup>2</sup>K/W and U<sub>w</sub> = 1.6 W/m<sup>2</sup>K)
- 3 For the energy saving potential on cooling by adaptive heat loss coefficient this amount depends on the thermal mass level and (less) on the level of maximum heat loss coefficient (§ 5.3.3)
- 4 The energy saving potential of the f<sub>sol</sub> for heating is due to the maximisation of the solar gain in the heating season (§ 5.3.4)
- 5 The total energy saving potential of **all discussed measures** compared to the reference situation with average insulation, average solar factor and constant ventilation [1.25/h]
- 6 Automated control; shows the added energy saving of automated control above non-automated control
- Not applicable
- ! Overheating escalates without additional measures in summer
- !! Heating can be increased by lack of prediction and thermal storage

TABLE 5.11 Summary of energy saving potential of the Adaptive Thermal Comfort System based on the calculations of this chapter

## § 5.4.2 Required values for $H_{\text{tot}}$ and $f_{\text{sol}}$

---

The energy saving potential calculated in this chapter is based on theoretical values for the ranges of the  $H_{\text{tot}}$  and  $f_{\text{sol}}$  in a more or less realistic but theoretical range; consequently, the actual energy saving potential can vary according to the actual ranges of the variable building characteristics.

Varying the heat loss factor is more feasible with increasing the ventilation because this can more easily reach very high heat loss factors. Developing new techniques for increasing the heat loss factor by transmission is only competitive to ventilation if high conductive properties can be incorporated in new materials or techniques (§ 3.4.3.2). Nevertheless, in case the ventilation cannot be controlled increasing the heat loss factor by transmission can be able to provide some passive cooling in summer additional to adaptive solar gain.

In this study, it is shown that the advantage of increasing the solar gain in the heating season is significant. However, varying the solar factor between the values assumed in the calculations from 0 to 1 is not possible with current techniques. Blocking all solar radiation is difficult without blocking all vision out and glazing will always block a percentage of the heat making it impossible to reach the value of 1 by currently available materials. New techniques could include new materials for advanced radiation transfer or harvesting more solar radiation by increasing the surface of incidence (§ 3.4.1.2).

A more detailed study to existing practical solutions and their energy saving potentials are researched in chapter 6. The ranges of the separate solutions are given in Table 5.11.

## § 5.4.3 Effect of the thermal mass

---

The most important conclusion about thermal mass in these calculations is that the control of the heat loss factor and the solar factor is significantly more stable with the higher thermal mass. The application of passive cooling by increasing the heat loss factor and/or decreasing the solar gain in case of low thermal mass leads to an increase in heating demand due to the temperature drop during absence (Figure 5.7).

As shown in section § 5.2.6 in the reference cases the cooling load is significantly lower for higher thermal mass and the heating load does not significantly vary with thermal mass due to the good basic insulation of the dwelling and sufficient solar gain.



As the previous sections show, the energy saving for cooling by the adaptive strategies is higher with high thermal mass more drastically reducing the already much lower cooling demand for higher thermal mass. This can be explained by the fact that the thermal mass causes the heat to be lost to spread more evenly amongst the hours which means the peaks for heat to be discarded will be much lower.

In case of the North orientation it can be an option to build with lower thermal mass especially if there is no increase of solar gain available because the solar radiation has significantly less effect on the heating demand showing a slight increase in heating demand for higher thermal mass.

#### § 5.4.4 Effect of occupancy

---

The control of the thermal comfort system according to the occupancy and the resulting comfort demand is an essential part of the Adaptive Thermal Comfort System as the definition suggests.

The difference between the energy saving is apparent in the case of adaptive heating; where high occupancy means less heating demand if a standard heating schedule is used because of higher internal gain the heating demand with control for presence shows less deviation between the occupancy profiles. This means that the energy saving is larger with lower the occupancy level (§ 5.3.1).

Furthermore, the control algorithms are significantly less accurate in case of the occupancy profile 4\_sm with high occupancy especially because the temperature falls below the heating setpoint by the time the occupants re-enter the room resulting in higher heating demands than the reference, emphasizing the benefit of a predictive algorithm or system with optimised setpoint temperature as described in § 5.3.3, § 5.3.4 and § 5.3.5. This effect decreases with higher thermal mass because of the slower temperature decrease.

Additionally, the occupancy has a great effect on the effectiveness of non-automated systems in case of overheating prevention. This emphasises the need for automated overheating protection by especially solar shading in case of larger periods of absence during the day (§ 5.3.8).

## § 5.4.5 Heat up and cool down speed

---

Heat up and cooling down speed are important characteristics of heating systems. In these calculations it is assumed that the heating power is unlimited and there is no limit to the speed. From the calculations it becomes clear that 5 % of the time the required heat up for adaptive heating is quite high for the living room depending on the thermal mass and occupancy profile with approximately 6 °C and the cool down speed is between 1.5 °C and 0 °C. With higher thermal mass, the required heat up step will be smaller; however, the heat up speed will be lower as well. In 20% of the time the heat required heat up speed will be significantly lower; however still high with around 4 °C. Stabilising the indoor temperature by minimising heat loss will lower the required heat-up or cooling-down speed and added solar gain lowers the required speed even more until below 4 °C for lower thermal mass and below 0.5 °C for higher thermal mass, provided that the set point temperature is optimised as described in § 5.4.4. In the bedrooms the required heating up speed will be much lower and the cool down speed will be slightly higher. This can be a serious limitation for the concept of adaptive heating, emphasizing the importance of heat-up speed for the system to be chosen.



# 6 Implementation of Adaptive Thermal Comfort System concepts in the standard reference dwelling

---

## § 6.1 Introduction

---

In the previous chapter, desired behaviour and potentials of flexible building characteristics have been researched. For both the solar factor ( $f_{sol}$ ) and the specific heat loss coefficient ( $H_{tot}$ ) optimal ranges and switching frequencies have been found. However, the approach was to disconnect their characteristics from (existing) techniques not to be hindered by technical limitations beforehand. In this chapter the techniques of chapter 3 are linked to the conclusions of chapter 5 to be translated to practical concepts and constraints for these concepts. Some of the concepts will be evaluated for applicability and efficiency in a Reference Dwelling of AgentschapNL in various occupancy scenarios and with high and low thermal mass. It reconnects the conclusions found to design practice and gives guidelines how to design an Adaptive Thermal Comfort System.

---

## § 6.2 Research design

---

### § 6.2.1 Problem statement

---

The conclusions from the previous chapter give guidelines and abstract concepts for the Adaptive Thermal Comfort System for Dwellings and they need to be evaluated for effectiveness in practice to connect the concepts to practice in the near future.

## § 6.2.2 Research questions

---

**What are possible applications of currently available techniques for an Adaptive Thermal Comfort System in a standard reference dwelling and what is their potential in improvement of energy performance?**

---

## § 6.2.3 Method

---

In this chapter the knowledge discussed in [PART 1](#) and the knowledge from [PART 2](#) are used to produce example concepts that can be assessed by TRNSYS simulations for energy efficiency. Furthermore, guidelines are given to which improvements can be made to the example concepts and the techniques to be developed.

---

## § 6.3 Example concepts based on the reference dwelling of AgentschapNL

---

### § 6.3.1 Context: the occupant

---



The target group will determine the need for flexibility in the home. The target group can be one specific family (e.g. an elderly couple), an undefined family (which can exist of one or more occupants, with undefined composition) or a family home that is life course stable. The variability of demand in time and location determines the level of flexibility and adaptivity the Adaptive Thermal Comfort System needs to have. An analysis in detail is performed in [§ 2.3](#) for three well represented household types in the Netherlands and they are researched for their differences in occupancy patterns. This method can be applied to map other demographic groups and households or a specific household in the design phase.

The Dwelling of the example concepts will be a family home which can be occupied by an undetermined family. The house has to be flexible and be able to accommodate a single occupant to a larger family. The dwelling has to be life course stable. This means the house should be very flexible to provide a large bandwidth and adapt to changing comfort demand. Therefore, the calculations to assess the energy saving potential

of the Adaptive Thermal Comfort System will be made with the same three occupant profiles used in chapter 5 with the occupancy profiles and characteristics as shown in Table 2.4.

§ 6.3.2 Context: the weather



The climate needs to be assessed for heating and cooling load as well as variability of the weather. Is the weather very variable from season to season, from day to day as well as diurnally? How often does the demand change from heating to cooling and vice versa? With strongly variable weather, higher demand for adaptivity is required and the benefit for energy efficiency of the adaptive approach is significant.

The Dwelling for the example concepts will be situated in the Netherlands, which has a dominant heating demand (in winter). However, as concluded in § 2.4 the summers are hot and sunny enough to cause overheating problems if the dwelling is designed to predominantly save heating energy by insulating the dwelling very well without extra measures in summer. Figure 6.1 shows a summary of the incoming solar radiation per month for the reference dwelling of AgentschapNL oriented with the back façade to the South and the maximum, average and minimum ambient temperature per month for the test reference year of 2050 W+.

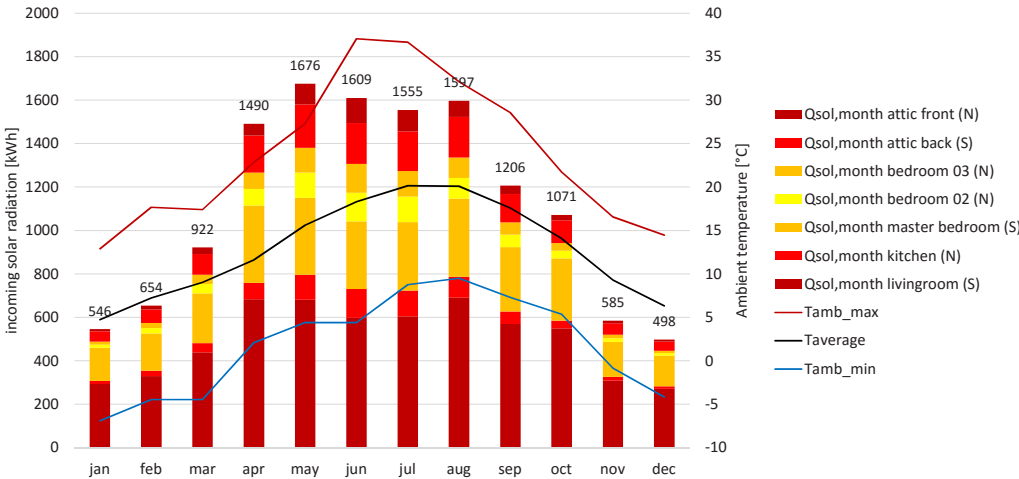
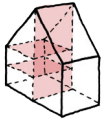


FIGURE 6.1 Incoming solar radiation through the windows for the whole house together with the average ambient temperature per month (2050 W+)

### § 6.3.3 Considerations for the spatial layout

---



The second step is to determine the spatial layout and determine if there are any adaptive opportunities to be seized in the design (§ 3.3). More importantly, the spatial layout determines the effectiveness of the adaptive measures for materialisation and HVAC.

#### To optimally benefit from the adaptive solar gain the following aspects should be considered

- To be able to optimally control the solar radiation, the façades (especially those which border rooms with high heating or highly variable comfort demand) should be as transparent as possible to have the highest possible range in solar factor. It should be considered that usually the transparent separation constructions have a lower insulation value than opaque separation constructions, which can lead to higher heating demand.
- Functions with highest heating demand or highest variability in heating demand preferably oriented to the orientation where most solar radiation is during the occupancy time (West / South / East). The more radiation falling on the façade, the larger the range of control is because the surplus of heat can be rejected by using adaptive solar gain .
- Functions with low heating demand and relatively high cooling demand (bedroom) can be oriented to the orientation with least solar radiation (North). If only small amounts of radiation are needed in the room it can be better to limit the solar radiation coming in to limit the risk of overheating, allowing the rooms with more heating demand to be oriented to the orientation where most solar radiation is during the occupancy time (West / South / East).

#### For the adaptive ventilation to function properly the following needs to be taken care of

- Create possibilities for good airflow through the building. To be able to optimally control the ventilation rate mechanically but above all naturally (E.4 and F.1) the spatial layout must contain sufficient possibilities for the ventilation air to flow freely from room to room if necessary. By controlling openings the air flow can then be tweaked to fit the requirements for ventilation of the Adaptive Thermal Comfort System at any moment.

In this example concept the spatial layout of the attached reference dwelling by AgentschapNL (DGMR, 2006) is chosen as a base, which is regarded as a standard Dutch dwelling. Figure 6.2 shows the floor plans of this dwelling. The living room is oriented South and has large windows to be able to optimally allow in or block solar radiation.

The bedrooms are oriented South or North and have smaller windows. In the test cases the flow through the dwelling can be stimulated by opening the windows or vents above the internal doors. These can be controlled according to the ventilation strategy.



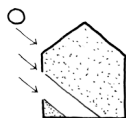
FIGURE 6.2 Floor plans of dwelling used for case study

### § 6.3.4 Concepts for materialisation



This section shows the considerations for the materialisation of the Adaptive Thermal Comfort System for Dwellings and the concepts to be evaluated by the TRNSYS simulations are described.

#### § 6.3.4.1 Concepts for the adaptive solar factor



To design the concept for the solar factor the following information needs to be present:



### Orientation and ratio of transparency

For optimisation of the South, West and East façades should have a large ratio of transparent to opaque area. The  $f_{sol}$  of the North façade has less influence on the total energy budget.

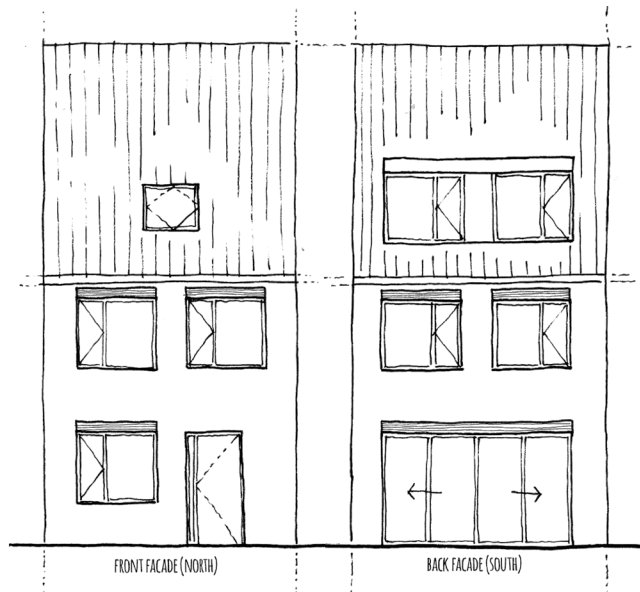


FIGURE 6.3 Façade design for the case study

### Room function and transparency of the façade

For maximum solar control high transparency rate (except the North façade).

The south façade of the example dwelling of the living room has a glass percentage of 75%. The other façades have a glass percentage of approximately 40%. The highest glass percentage is on the South façade of the living room which has the highest range in comfort demand as well as the highest heating demand. This is favourable as becomes clear in chapter 5.

In the example, with a G-value of the glass of 0.6 (HR++), the maximum range of solar factor for the South façade of the living room is 45% to 0%. For the rest of the façades this is 25% to 0%. In the TRNSYS simulation the  $f_{sol}$  of the North façade will be varied, however is expected not to have much effect because of the little solar radiation during the summer season.

A combination between screens and controllable awnings is chosen in the form of awnings with a reflective surface on the outside that can also be placed parallel to the glass with a cavity that can be vented to prevent overheating of the screen (Figure 6.4). With this solution (otherwise it will be completely dark when people are home) it is possible to reach the maximum range for solar shading; however, it should be noted that with this setting, also the visual light and view out are blocked. In practice this might not be desirable. However, the beam radiation can be blocked and shading values of 0.15 can easily be reached with the awning setting. Therefore, during presence the maximum solar shading will be a G-value of 0.15. Furthermore, when the screen is parallel to the glass, a cavity between the glass and the screen should be created to ventilate the heat from the surface of the screen that will be heated up by the sun, to make sure no significant solar radiation will “leak” into the space.

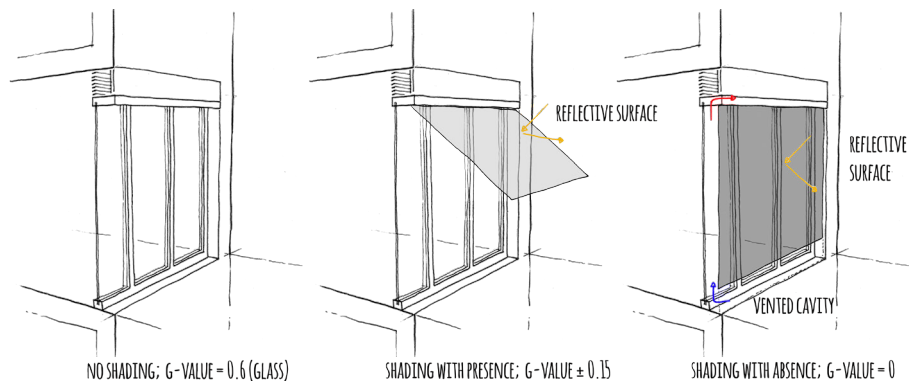


FIGURE 6.4 Concept for varying the  $f_{sol}$  combined screens and awnings

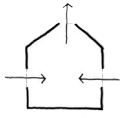
In the example concepts (Table 6.4) the technique to vary the solar factor used is the marquiselette, because this is at the moment the easiest and most effective way of controlling the solar shading being able to block all solar radiation at absence of the occupant and allowing view out at presence of the occupants (with a remainder of 15% solar radiation allowed in). The solar factor ranges for this example are given by Table 6.1.

FAÇADE	GLASS PERC.	G-VALUE	MAX $F_{SOL}$	MIN $F_{SOL}$ PRES.	MIN $F_{SOL}$
living room back	75 %	0.6	0.45	0.068	0
other	40 %	0.6	0.24	0.036	0

TABLE 6.1 Range for solar factors for the example concepts

### § 6.3.4.2 Concepts for the adaptive heat loss factor

---



Because the combination of natural supply and mechanical exhaust is almost inevitable both natural ventilation as mechanical ventilation are described here and the section about HVAC will only describe the heating and cooling. To design the concept for the ventilation and the cooperation between natural ventilation and mechanical ventilation the following information needs to be present:

- The volume of the room to determine the capacity needed to supply an ACPH of about 10 l/h. In the calculations of the previous chapter values of almost 30 l/h were reached; however, this was in just 5% of the time. Preliminary calculations showed that using this high ACPH values the heating demand will go up drastically.
- Possibility and room to integrate equipment for ventilation (ducts, registers etc.)
- Influence of decisions made in previous steps

Now there are roughly two ways to influence the heat loss factor due to air exchange ( $H_{ve}$ ). This can be done by varying the volume of the air exchange and varying the heat recovery capacity. In Table 6.2 the required ventilation capacities are given for fresh air (Dutch Standard (NEN\_1087, 2007)), purge ventilation and the capacity for the Adaptive Thermal Comfort System. Furthermore, for the three options of mechanical supply and exhaust, natural supply and exhaust and natural supply and mechanical exhaust the dimensions of the openings or canals are given for these capacities for adaptive ventilation. For the purge ventilation for temperature control considerable openings should be present as shown in the example in Figure 6.5 which will be simulated in the TRNSYS variants for assessment (Table 6.4). The concepts assessed in the example concepts for control of the natural ventilation supply are;

- Pressure controlled inlet (constant inlet flow)
- CO<sub>2</sub> controlled ventilation (minimal ventilation)
- Temperature and CO<sub>2</sub> controlled ventilation

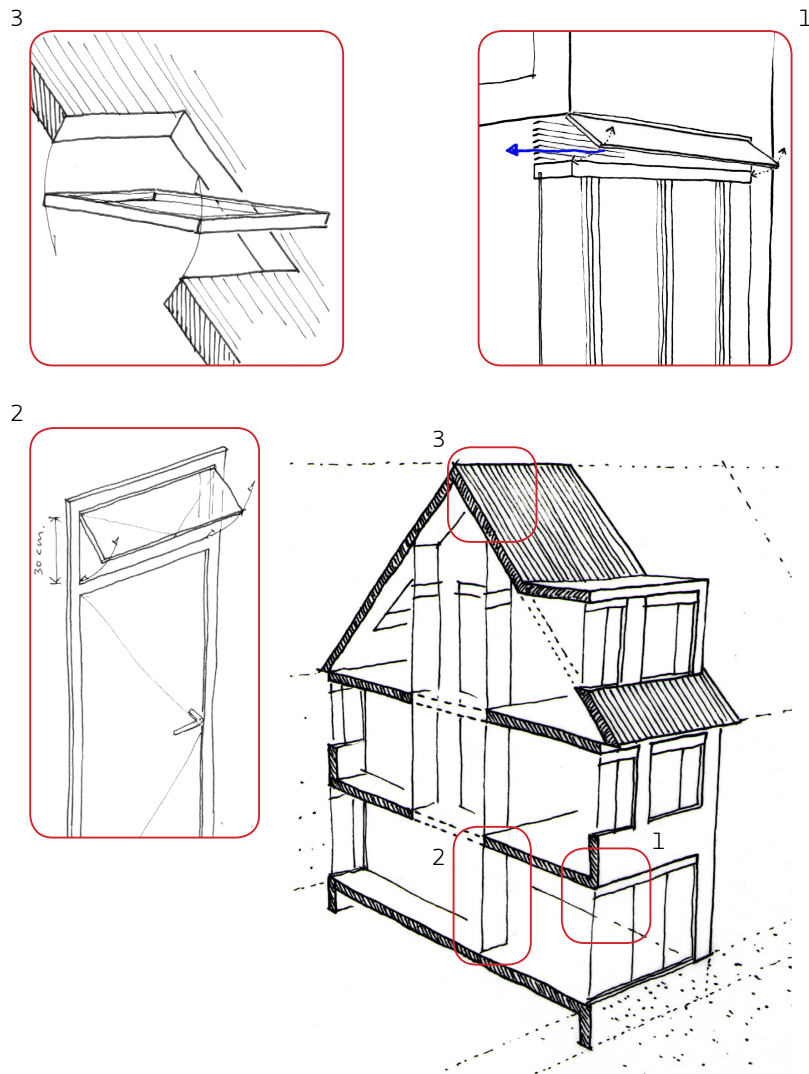
ROOM	A [m <sup>2</sup> ]	V [m <sup>3</sup> ]	vent (Dutch Standard) [m <sup>3</sup> /h]	purge ventilation (Dutch Standard) [m <sup>3</sup> /h]	Adaptive ventilation [m <sup>3</sup> /h] (AER 10/h)	Mechanical ventilation duct size [Ø mm] (air speed 3 m/s)	Natural ventilation net opening size [m <sup>2</sup> ]	Natural supply / mechanical exhaust net opening size [m <sup>2</sup> ] (air speed 0.8 m/s)
Living room / kitchen	37	97	120	799	962	340	2.67	0.33
Bedroom 01	16	42	52	346	420	223	1.17	0.15
Bedroom 02	10	26	33	216	260	180	0.72	0.09
Bedroom 03	5	14	17	115	140	130	0.36	0.05
Attic 01	8	42	27	180	420	230	1.17	0.15
Attic 02	-	22	-	-	220	160	0.61	0.08
<b>TOTAL</b>	<b>76</b>	<b>241</b>	<b>246</b>	<b>1642</b>	<b>2412</b>	<b>530</b>	<b>6.70</b>	<b>0.84</b>

TABLE 6.2 Ventilation capacity for legislation (Dutch Standard (NEN\_1087, 2007)) and the Adaptive Thermal Comfort System and the dimensions of various techniques to provide this capacity.

### Improvements and new concepts

The existing systems for controlling the mechanical ventilation are quite advanced and therefore the improvements are limited to noise reduction, efficiency (both in energy use for fans as material and space use) and draft reduction. Furthermore, the ventilation is nowadays controlled mainly to limit heat loss, while providing enough fresh air, thus the minimum amount of ventilation is applied for discarding the measured or predicted air pollution. However, chapter 5 shows that it is very much recommended to control ventilation both to pollution as well as temperature, to be able to prevent overheating. Improvements should therefore focus on the control mechanisms like sensors and algorithms.

For the ventilation to be fully beneficial the equipment needs to be operational during absence of the occupants as well. For registers and other openings this means that they need to be designed burglar proof (especially if operable windows are incorporated this is a point of concern) and automated. For the whole automation of the system this means that it needs to be designed to be sturdy.

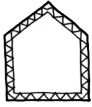


- 1: Vents above windows of 30 cm height controlled for adaptive ventilation for passive cooling
- 2: Vents above internal doors of 30cm height opened together with vents above windows in the corresponding room to enhance airflow through the building
- 3: Rooflight in staircase opened with either window vent in the house to enhance airflow through the building

**FIGURE 6.5** Concept for varying the natural ventilation for passive cooling by purge ventilation in the TRNSYS simulations (combined with base minimised ventilation natural supply, mechanical exhaust)

### § 6.3.4.3 Concepts for the adaptive heat loss factor by transmission

---



To design the concept for the transmission the following information needs to be present:

- The ratio of the area of the building shell to the volume of the space
- Influence of decisions made in previous steps

At the moment this dissertation is written the options to vary the insulation value of the building shell are limited. Because the range of  $H_{\text{tot}}$  that can be obtained with these measures compared to the range that can be obtained by changing the ventilation rate, more research and development needs to be done to make this truly viable. The example concept will therefore assume fixed insulation and variable ventilation. The basic insulation value will be a standard value of  $R_c = 5 \text{ m}^2\text{K}/\text{W}$  and a U-value of the glass of  $1.6 \text{ W}/\text{m}^2\text{K}$ .

### § 6.3.4.4 Concepts for the thermal mass

---



As becomes clear from chapter 5 because of the high insulation values and adaptive building characteristics, the temperature fluctuations are so little, high thermal mass has no significant negative influence on the heating demand. Higher thermal mass means a lower cooling load in the reference situations; however, in most situations the cooling load is eliminated by the Adaptive Thermal Comfort System in all thermal mass cases. This means that it will not be useful to vary the thermal mass together with the other building characteristics so different aspects will determine the level of thermal mass. In general it is preferred to build in high thermal mass. In the example two levels of thermal mass will be researched; low and high to reassess the influence of the thermal mass on the performance of the Adaptive Thermal Comfort System (Table 6.3).

CASES					
Thermal mass			capacitance [kg/m <sup>2</sup> ] (per floor area)		
low			80.000		
high			370.000		
year					
2050 W+			test reference year, warm		
Occupancy profiles	code	people in household	occupancy rate	average amount of people present	average activity level
1 student	1_st	1	10%	1.26	2.5
couple both with job	2_w	2	18%	1.32	2.1
couple with 2 small children	4_sm	4	46%	1.70	2.4

TABLE 6.3 Calculated cases

### § 6.3.5 HVAC design



The example concepts will consider central mechanical ventilation with heat recovery with the same control strategies for the ventilation rate as the variants with natural supply. The extra ventilation for temperature control will both be considered to be obtained by natural ventilation or mechanical ventilation;

- Constant air flow (1/h)
- CO<sub>2</sub> controlled ventilation (minimal ventilation)
- Temperature and CO<sub>2</sub> controlled ventilation
- Extra ventilation by natural ventilation

#### § 6.3.5.1 Concepts for adaptive heating and cooling generation and distribution

If the previous steps are followed, to meet the remaining heating demand, a flexible and adaptable strategy for heating and cooling can be chosen (active cooling will not be necessary in the case of the Netherlands). The heating and cooling concept roughly exist of two parts; the generation of heat and cold and the delivery of this heat and cold. As explained in the former section, some choices for ventilation will have implications for the choice for heating and cooling. Therefore it is always advisable to regularly check back on the other steps. To design the concept for the heating and cooling the following information needs to be present:

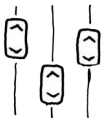
- The maximum demand for heating capacity and cooling capacity
- Possibilities and room to integrate equipment for heating and cooling (radiators etc.)
- Influence of decisions made in previous steps

The example concepts don't consider the method of generation or delivery of the heating and cooling energy as the model in TRNSYS considers an ideal heating; all heating and cooling energy is directly transmitted to the room air by radiation and convection as this is not an aspect that is determined by the Adaptive Thermal Comfort System.

It should be noted that in the simulations it is assumed that the heating and cooling power is **unlimited** and has a **response time equal to the calculated time step**. This means that inertia of the heating delivery system by its thermal mass is not regarded. Systems in practice could therefore be less effective the slower they are.

### § 6.3.6 Controls

---



In this step all information about the weather and the occupant should be linked with the chosen systems so these can be tuned. In [Table 3.7](#) the important information flows are described and all information needed for the Adaptive System about the control parameters with their unit for the heat balance calculation and ways to obtain the information by sensor, interface or prediction. An Adaptive Model Predictive Control (self-learning control) ([§ 3.6.4](#)) with anticipation of future comfort demand can optimise between heating and cooling to increase energy saving potential. The specific needed information will be ultimately determined by the actual applied techniques.

### § 6.3.7 Simulated variants

---

The design example is calculated in TRNSYS with the different cases ([Table 6.4](#)) and the calculation variants shown in [Table 6.5](#). There are two reference situations; one with a fixed ventilation rate of 1.25 l/h based on the Dutch standard (ref) and one with minimised ventilation. This is to determine the energy saving due to the minimisation of heat loss in the winter, which is a measure commonly used in practice and therefore not primarily due to the application of dynamic temperature controlled ventilation. However, as we could see in [chapter 5](#) this can lead to serious overheating in summer. The energy use due to overheating is calculated by assuming a cooling installation.



However, to determine the real gravity of the situation the overheating of the house is also calculated in case if no cooling is applied. The overheating is measured in degree hours above cooling setpoint. At presence this is the upper limit of the comfort bandwidth and at absence this is 30 °C.

Table 9.4 shows the list of variants to be compared so the energy saving potentials can be related to thermal mass, occupancy profile, and adaptive strategy. The design will be regarded as a whole house and all the performances of the rooms will be summed or averaged.

CONTROL VARIANTS		HEATING & COOLING		VENTILATION		SHADING			
(all variants except for the presence controlled variants (e&f) are calculated with natural ventilation supply as well as with mechanical ventilation supply with heat recovery)									
variant	code	s / p	hi-lo / ACA	+ / -	a / p	base ventilation rate [L/h]	0 / 1	a / p	0 / 1
reference	1_ref	s	hi/lo	+	-	1.25	0	-	0
adaptive heating	1a_ref	p	ACA	+	-	1.25	0	-	0
minimised ventilation	1b_ref	p	ACA	+	-	min <sub>pres</sub>	0	-	0
minimised ventilation nc	1c_ref	p	ACA	-	-	min <sub>pres</sub>	0	-	0
adaptive ventilation	2b_ventdyn	p	ACA	+	a	min <sub>pres</sub>	0-1	-	0
adaptive ventilation nc	2c_ventdyn	p	ACA	-	a	min <sub>pres</sub>	0-1	-	0
presence ventilation	2e_ventdyn	p	ACA	+	p	min <sub>pres</sub>	0-1	-	0
presence ventilation nc	2f_ventdyn	p	ACA	-	p	min <sub>pres</sub>	0-1	-	0
adaptive ventilation	3b_soldyn	p	ACA	+	-	min <sub>pres</sub>	0	a	0-1
adaptive ventilation nc	3c_soldyn	p	ACA	-	-	min <sub>pres</sub>	0	a	0-1
presence ventilation	3e_soldyn	p	ACA	+	-	min <sub>pres</sub>	0	p	0-1
presence ventilation nc	3f_soldyn	p	ACA	-	-	min <sub>pres</sub>	0	p	0-1
adaptive ventilation	4b_dyn	p	ACA	+	a	min <sub>pres</sub>	0-1	a	0-1
adaptive ventilation nc	4c_dyn	p	ACA	-	a	min <sub>pres</sub>	0-1	a	0-1
presence ventilation	4e_dyn	p	ACA	+	p	min <sub>pres</sub>	0-1	p	0-1
presence ventilation nc	4f_dyn	p	ACA	-	p	min <sub>pres</sub>	0-1	p	0-1
s / p	s = schedule (Table App.D.2) / p = presence controlled (adaptive heating)								
hi-lo / ACA	hi-lo = setpoint and setback (Table App.D.2) / ACA Adaptive Comfort Algorithm (Equation 2.2 to Equation 2.6 in § 2.3.3)								
+ / -	+ = cooling / - = no cooling, calculating overheating in degree hours								
a / p	a = adaptive control (automated) / p = operated with presence (non automated)								
0 / 1 (ventilation)	0 = no extra ventilation / 0-1 = extra ventilation on or off								
0 / 1 (shading)	0 = no solar shading / 0-1 = shading on or off								

TABLE 6.4 Calculated control variants

### § 6.3.8 Energy use of the reference situations

First the reference situations for all combinations of all cases are calculated, with assumptions shown below in [Table 6.6](#).

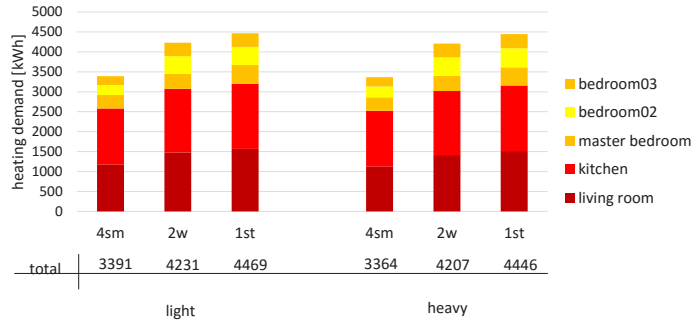
INITIAL VALUES		
Operation		
ventilation [l/h]	1.25	(0.9 l/sm <sup>2</sup> )
Schedule living room		
	Heating setpoint [°C]	Cooling setpoint [°C]
0:00 - 6:00	15	30
6:00 - 23:00	20.5	25
13:00 - 0:00	15	30
Boundary		
	Heating setpoint [°C]	Cooling setpoint [°C]
0:00 - 6:00	18	25
6:00 - 23:00	15	30
13:00 - 0:00	18	25
Boundary		
	Equipment [W/m <sup>2</sup> ]	People [W]
absence (occupancy schedule)	1	-
presence (occupancy schedule)	10	75 * (amount of people)

TABLE 6.5 Initial values for the reference situations

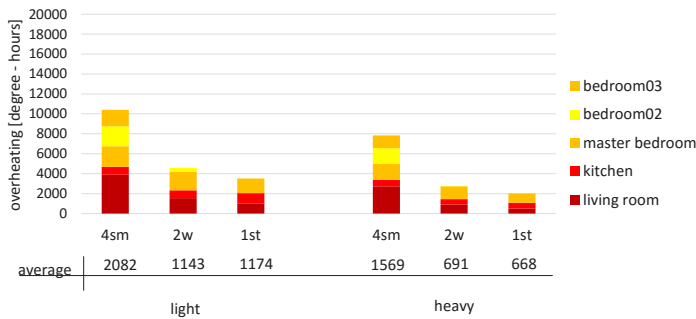
[Figure 6.6 \(1\)](#) shows the annual heating demand for each combination of occupancy profile and thermal mass variant together with the distribution of that energy demand over the months of the year. [Figure 6.6 \(2\)](#) shows the overheating in degree-hours. The overheating numbers in the graphs are the average of overheating degree-hours of all used rooms in the occupancy profiles. In the 2 person household the second bedroom is used sparingly and the third bedroom is unused. In the 1 person household both the second and third bedrooms are unused ([Table 2.4](#)).

The heating demand doesn't vary much between high thermal mass and low thermal mass in [Figure 6.6](#) and is slightly higher for the low thermal mass which is the same conclusion taken from [§ 5.2.6](#). Furthermore as in [§ 5.2.6](#) the heating is significantly higher the lower the occupancy pattern which is caused by the equal heating hours for each profile but more internal gain for the profiles with higher occupancy.

The overheating also shows similar trends to the calculations from [chapter 5](#); significantly higher overheating for lower thermal mass and significantly higher overheating for higher occupancy rates. The rooms that are not used in the profiles show no overheating degree-hours because the hours are only measured at presence.



1 heating [kWh]



2 overheating [degree-hours]

FIGURE 6.6 Energy use for heating (1) in kWh and overheating (2) in degree-hours in the whole house in the reference situations with fixed ventilation and day and night setting for heating

## § 6.4 Results and discussion

### § 6.4.1 Adaptive heating

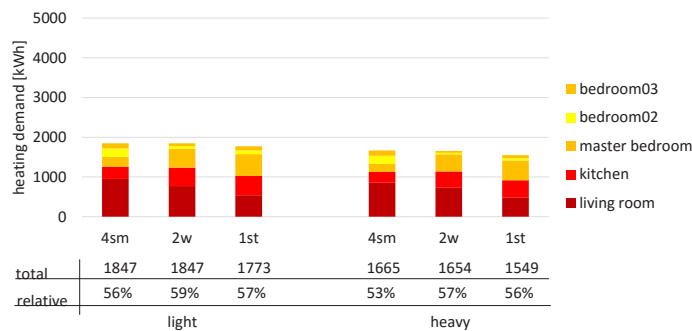
The next step is researching the energy saving potential for adaptive heating; providing heating only when and where needed at the level needed as opposed to fixed day and night temperatures. The comfort temperature will be calculated by the ACA method and the heating will only function at presence of the occupants or if the temperature falls below the setback temperature of 15 °C. In practice the temperature will never fall below this 15 °C because the insulation is high enough to prevent this.



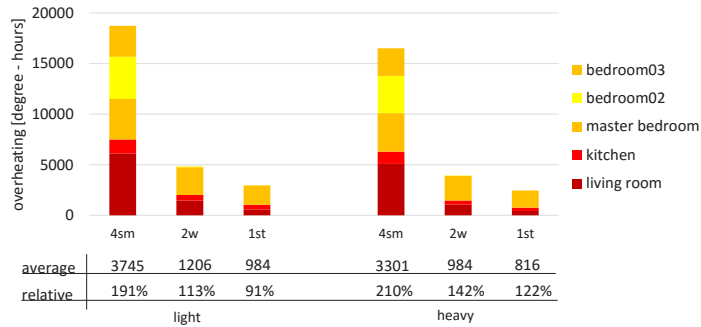
As becomes clear by Figure 6.7 (1) adaptive heating can achieve a significantly better energy performance for the whole house as per room in chapter 5. The energy saving is very little (around 5%) for the family with two children (4\_sm) because their occupancy profile mostly resembles the standard heating times set by the thermostat and the 1 person household with the lowest occupancy rate and the least people in the household can gain almost 40% energy saving by the adaptive approach, which is a similar amount as concluded in the previous chapter. The overheating is similar to the reference situation showing slight decrease in the light variant. This is because extra heating can cause a slight cooling demand later on depending on the occupancy of the rooms and incoming (extra) heat by solar radiation. It is remarkable that the rooms that are not in use still show a heating demand. This can be explained by the fact that the heating setpoint at absence in every room is still 15 °C as opposed to 16 °C to 18 °C at presence in the bedrooms and the ventilation is standardised at an ACPH of 1.25 1/h which is quite high.

## § 6.4.2 Minimised ventilation

To be able to clearly see the energy saving potential for adaptive ventilation first the energy saving for heating by minimizing the ventilation is calculated taking into account the fact that this significantly increases overheating. Figure 6.8 (1) shows the absolute energy consumption [kWh] for heating by minimised ventilation and relative to the situation of adaptive heating [%] and Figure 6.8 (2) shows the overheating in degree hours above cooling setpoint in house reference situations with minimised ventilation. The overheating numbers in the table are the average of overheating degree-hours of all used rooms in the occupancy profiles.



1 heating [kWh / %]



## 2 overheating [degree-hours / %]

**FIGURE 6.8** Energy use for heating (1) in kWh and overheating (2) in degree-hours in the whole house for minimised ventilation absolute and relative to reference situation (Figure 6.7) with adaptive heating [%]

From Figure 6.8 (1) it can be concluded that the energy saving of minimizing the ventilation in the heating season is very effective (almost 50%) and most effective with the most heating hours which is in the case of the profile with the couple with two children (4\_sm) in addition to the energy saving by adaptive heating. It is now noticeable that the unoccupied bedroom show a higher decrease in heating demand than the living room, kitchen and the master bedroom because now the ventilation is always low at an ACPH of 0,5 l/h.

However, Figure 6.8 (2) shows that the overheating problems are significant if no counteractions are taken. This problem aggravates with rising occupancy because the overheating degree hours are only calculated for the presence hours. Furthermore, it shows that the overheating is significantly higher for lower thermal mass. The energy saving potential for heating in case of minimised ventilation is slightly lower for higher thermal mass; however, the remaining heating demand is still lower for higher thermal mass.

Furthermore, the energy saving potential is around 20% less than concluded in the previous chapter. It should be noted that in the study with the TRNSYS model the insulation level of all variants has an  $R_c$  of 5 m<sup>2</sup>K/W and a  $U_w$  of 1.6 W/m<sup>2</sup>K, while the insulation level in the 3R1C calculations of the previous chapter varies along with the ventilation.

### § 6.4.3 Adaptive ventilation by operable vents above the windows

To benefit from the energy saving for heating with minimised ventilation without the disadvantage of the overheating problems the ventilation can be increased whenever there is a surplus of heat in the dwelling. In the example concept of this chapter this is done by opening vents above the windows of 30 cm of height combined with vents above the internal doors of 30 cm that are opened simultaneously to aid the flow through the dwelling. Additionally, in the staircase there is a roof-light that is opened if there are one or more rooms with opened window vents (Figure 6.5). In the simulation the vents are either opened or closed and the wind pressure determines the actual ACPH and speed of the air. There is no extra extraction of air by the mechanical system. Figure 6.9 shows the remaining overheating in summer by adaptive ventilation absolute [degree-hours] and compared to the reference situation of Figure 6.8 [%]. The overheating numbers in the table are the average of overheating degree-hours of all used rooms in the occupancy profiles.

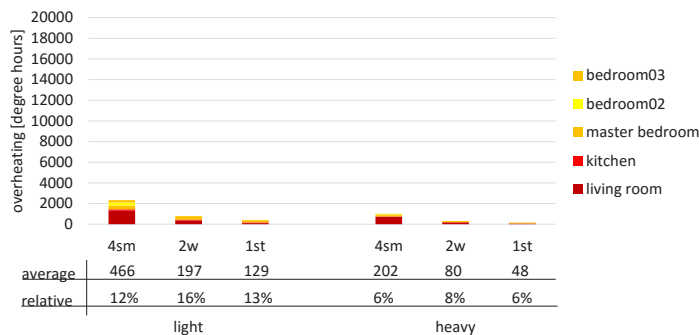
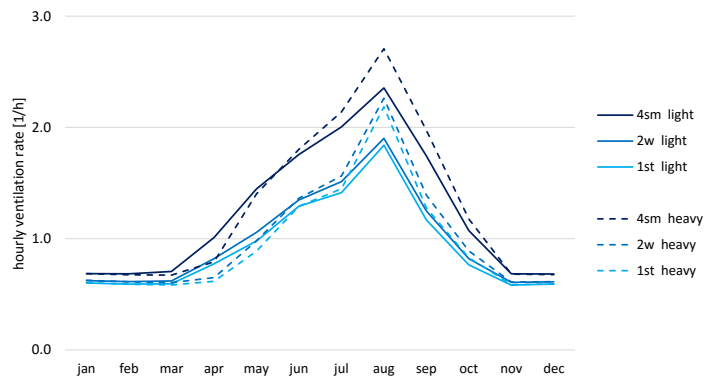


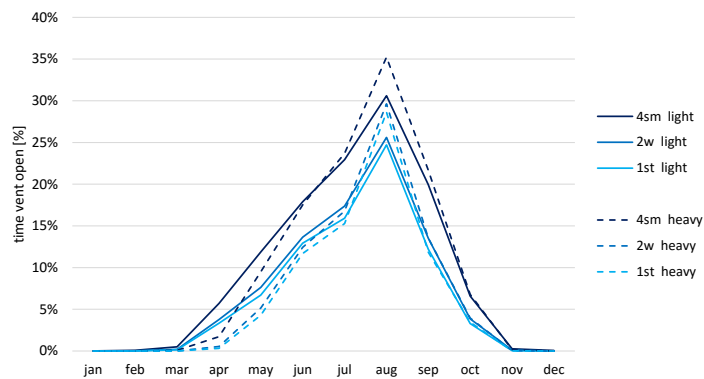
FIGURE 6.9 Remaining overheating with adaptive ventilation absolute [degree hours] and relative to minimised ventilation [%] (Figure 6.8)

As can be seen from Figure 6.9 compared to Figure 6.8 the overheating has diminished significantly but it can still be desirable to have an additional cooling system especially for the low thermal mass variant for the family with small children (4sm) with around an average of 549 degree-hours left in the living room, kitchen and three bedrooms on the first floor but it will have significantly less energy demand. The decrease in overheating can be around 10% larger if the ACPH is not depending on the wind pressure and opening size but at a constant of 10 l/h at opening of the window vents. This means that there is room for improvement in the design to control the air flow for passive cooling.

To determine the impact of this strategy on the house and comfort the ventilation rate and the occurring ventilation rates are researched as well. Figure 6.10 (1) shows the average ventilation rate of the conditioned spaces during the course of the year for each combination of occupancy profile and thermal mass level produced by opening the vents above the windows and the internal doors without additional measures to propagate air flow. Figure 6.10 (2) shows the average portion of the time the vents are open [%] in conditioned spaces with dynamically controlled ventilation.



1 Average ACPH [l/h] as a result of opening the window vents



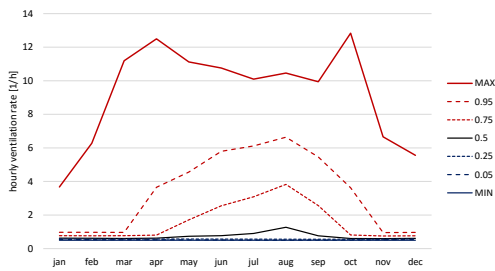
2 Portion window vents open per hour [%]

FIGURE 6.10 Average ACPH [l/h] and average portion of the time the vents are open [%] in conditioned spaces with dynamically controlled ventilation

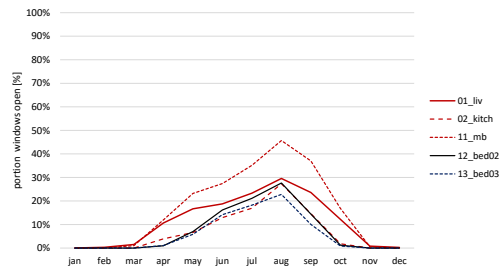
The shape of the two graphs are almost identical and this shows that opening the vents works quite consistently to produce the required ventilation rates. We can also see that the profile with the highest occupancy rate (4\_sm) also has significantly higher ventilation rates. The ventilation rate needed is higher for lower thermal mass as is concluded in § 5.3.3.



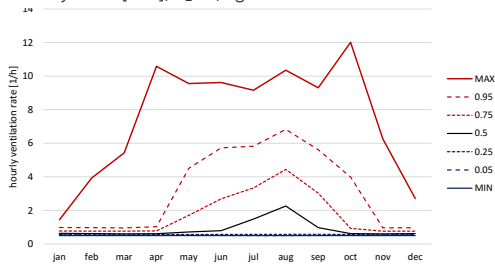
For the two variants with the highest ventilation rates (4\_sm heavy and light), the spread in hourly ventilation rate (ACPH [1/h]) is plotted in Figure 6.11 (1,3) and the average ventilation rate per room (2,4). The percentile figures display the percentile lines for the year and the maximum and minimum. This means that the maximum line plots the maximum value of hourly ventilation rate for the whole house and that 95% of the time the ventilation rate is below the 95% line and so on.



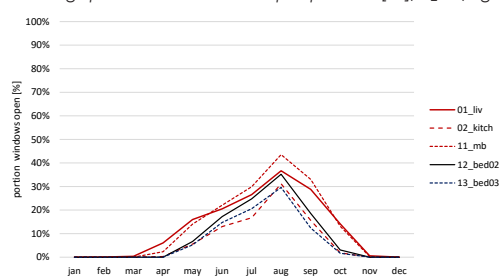
1 hourly ACPH [1/h]; 4\_sm; light



2 average portion window vents open per hour [%]; 4\_sm; light



3 hourly ACPH [1/h]; 4\_sm; heavy



4 average portion window vents open per hour [%]; 4\_sm; heavy

**FIGURE 6.11** Percentiles of hourly ACPH [1/h] for the whole house and portion of opening of the window vents [%] per room for the variant with adaptive control of ventilation for temperature; occupancy profile 4\_sm

Figure 6.11 shows that a considerable amount of time the window vent is either opened or closed all hour. The maximum ACPH is very high in the summer months with around 12 1/h. These rates only occur in less than 5% of the hours and the percentile line of 95% is significantly lower with around 6 1/h in summer. The ventilation rates in the master bedroom are highest because of the cooler setpoint in bedrooms and the fact that this bedroom is oriented South.

These are still high air velocities; however, they only occur at times the indoor temperature is in the high ranges of the comfort bandwidth so a cooling breeze is beneficial for comfort. Furthermore, because of the high placing of the vents, the air speed in the living space of the rooms will have decreased significantly. This can be researched into more detail with CFD simulations. The ventilation rates for the light

building shows a slightly higher peak and the window vents are open slightly more often. This confirms the fact that lower thermal mass has more risk of overheating and thus has more heat to discard which could also be concluded from the calculations with the lumped capacitance model in § 5.3.3. Furthermore, Figure 6.11 (2,4) shows that the window vents in the rooms oriented South (01\_liv; 11\_mb) are significantly opened more than the other rooms oriented North (02\_kitch;12\_bed02;13\_bed03) due to less solar radiation. Nevertheless even in the summer months the vents should be opened in less than 50% of the time and in the winter months they are hardly opened at all.

## § 6.4.4 Adaptive solar gain

The overheating problem caused by the minimum ventilation can be counteracted by blocking solar radiation as well. Figure 6.12 shows the overheating left in case of adaptive solar gain strategy absolute in degree hours and compared to the reference situation of minimised ventilation [%].

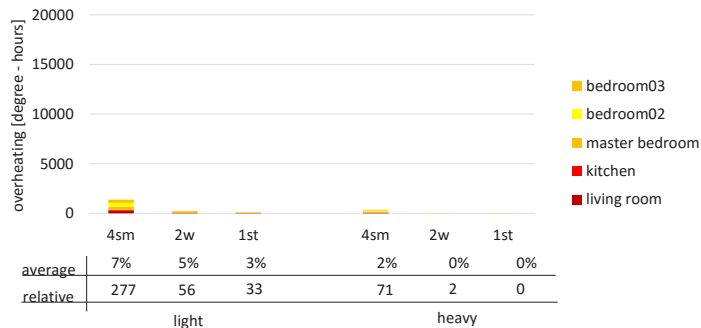
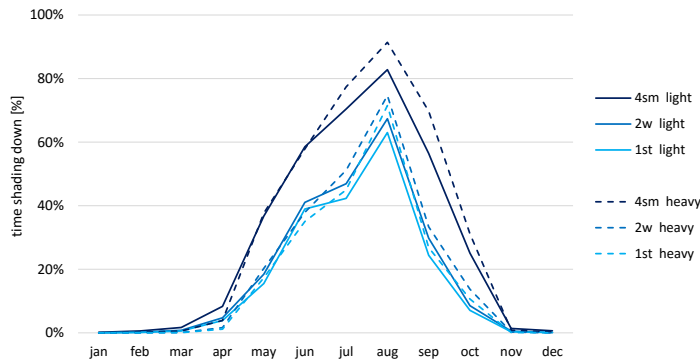


FIGURE 6.12 Remaining overheating with adaptive solar gain absolute [degree hours] and relative to minimised ventilation [%] (Figure 6.8)

From Figure 6.12 it can be concluded that the problems that occur in summer due to the minimisation of ventilation can be significantly decreased by blocking unwanted solar radiation, more so than with adaptive ventilation. In this situation, not applying cooling will only lead to significant overheating problems in case of a light construction with occupancy by the 4 person household (4\_sm) with an average of 277 degree-hours left in the living room, kitchen and three bedrooms on the first floor. Countering overheating with solar shading is around twice as effective as adaptive ventilation as concluded in § 5.3.4.

To determine the impact of this strategy on the house and comfort [Figure 6.13](#) shows the actual average percentage of the time the shading is down during the year in the conditioned spaces.



**FIGURE 6.13** Portion of time the solar shading is down [%] blocking all solar radiation in the conditioned spaces with dynamically controlled solar gain and minimum ventilation

The shape of the graph in [Figure 6.13](#) is very similar to the graph that show the settings of the ventilation opening above the windows ([Figure 6.10](#)). This is not surprising because the same incentive is used to control both the ventilation rate as the solar gain. However, the ventilation settings graph is steeper and less high. This leads to the conclusion that shading is used more often. This is due to the fact that the threshold temperature for the ventilation is set one degree °C higher than the threshold for solar shading to prevent too much cooling by ventilation which will lead to more heating. In practice this threshold can be fine tuned by self learning control with anticipation on future demand as concluded in [§ 5.3.3](#). We can also see that the profile with the highest occupancy rate (4\_sm) also uses significantly more solar shading than the other profiles as we could see with the ventilation.

Solar shading is also applied on the North façades. However less effective than shading on the South façade, it is still saving some energy because due to diffuse solar radiation and reflection there is always some solar radiation coming in. However, if this excess solar radiation is vented out there is no need for solar shading.

## § 6.4.5 Adaptive heating, ventilation and solar gain

According to chapter 5 applying both adaptive ventilation and solar gain is the most effective way of energy saving for the dwelling because this can result in almost eliminating of the cooling demand with less ventilation rates required so the openings for ventilation can be smaller in theory because most excess heat is already blocked by the shading. In the calculations of this chapter the same vent openings are used but they will be equipped significantly less because most of the excess heat is already blocked by the solar shading. This will result in less frequently used vent openings and lower average ventilation rates.

Figure 6.14 shows the overheating left in case of adaptive ventilation and solar gain strategy absolute in degree hours and compared to the reference situation of minimised ventilation [%].

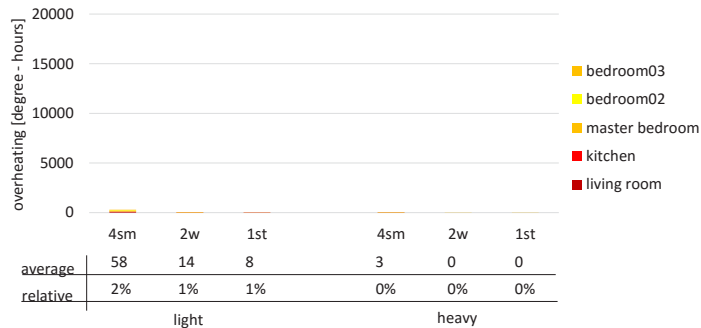
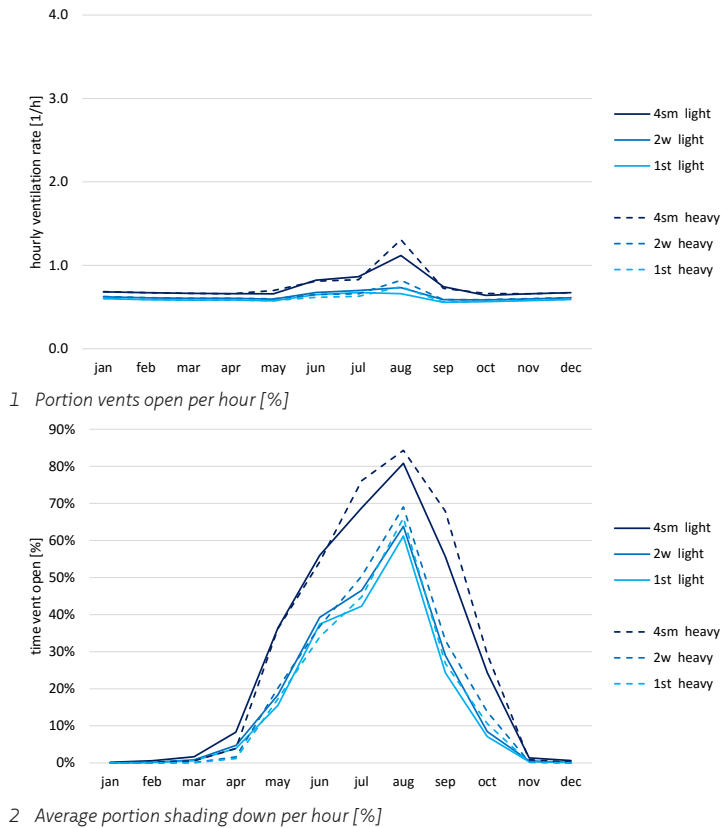


FIGURE 6.14 Remaining overheating with adaptive ventilation and solar gain absolute [degree hours] and relative to minimised ventilation [%] (Figure 6.8)

From Figure 6.14 it can be concluded that as expected the combination of the two measures will almost eliminate virtually all demand for cooling. In case of the light dwelling occupied by the 4 person household 2% of the original overheating is left. With 58 degree-hours left on average in the whole house it is unlikely that active cooling will be required.

To determine the impact of this strategy on the house and comfort Figure 6.15 (1) shows the average ventilation rate during the year in the conditioned spaces and Figure 6.15 (2) shows the actual average percentage of the time the shading is down during the year in the conditioned spaces.



**FIGURE 6.15** Average ventilation rates and the use of shading in the conditioned spaces with dynamically controlled ventilation and solar gain

In [Figure 6.15 \(2\)](#) the portion of the time the solar shading is down shows a slight decrease compared to the situation where only shading is applied while the ventilation rate is dramatically decreased compared to just applying adaptive ventilation without solar shading. The great decrease of ventilation is due to the fact that as predicted in the beginning of this section the fact that most excess heat is already blocked by the shading.

Even though the separated measures of dynamic ventilation control and solar shading can prevent most overheating of the home and thus cooling demand, there are clearly benefits in a combination. The vents above the windows could be significantly smaller which decreases the risk of draught and uses less space in the façade. Furthermore, the smaller the openings the easier it is to make them burglary proof. Additionally, less effective solar shading could be applied as well which increases the possibilities for materials and techniques and will allow for saving in the cost of the shading. In practice these measures can be optimised together. Furthermore, the need for shading on the North façade can be omitted totally which can significantly save costs.

## § 6.4.6 Automation versus manual operation

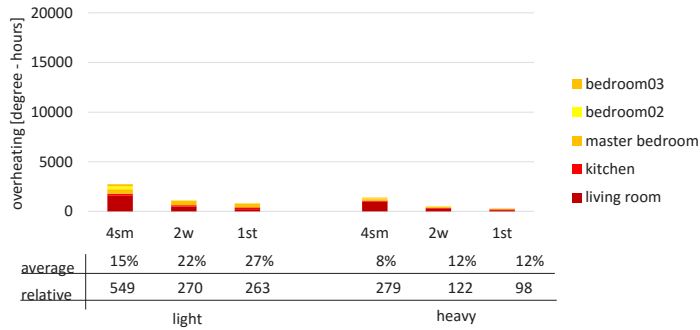
---

The energy saving potentials of the three strategies in the past sections all assume there is automated control of the settings that choose the right setting for every situation, even when the occupants are not present. This requires advanced domotics with moving mechanical parts to change the position of the window vents and solar shading which can be vulnerable to break down and intentionally inflicted damage and they can be very costly. To be able to make an informed decision about the level of automation chosen in a design the energy saving potential of all the measures is calculated if applied only during presence of the occupants as if they could adjust the ventilation and solar shading by hand preferably with an intelligent system of sensors that gives a warning when something should be adjusted.

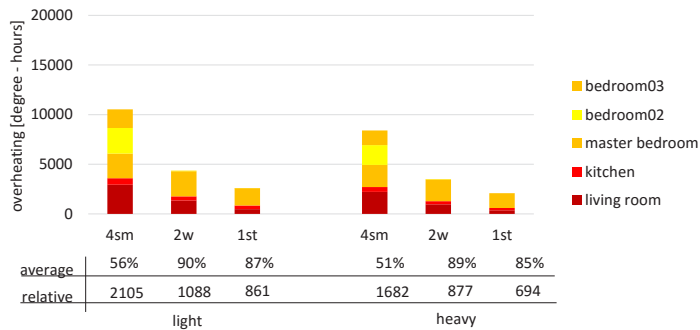
Figure 6.16 (1) shows the remaining overheating with adaptive ventilation only when present for all combinations of occupancy profiles and thermal mass in degree-hours and relative to the reference situation of minimised ventilation [%].

Figure 6.16 (2) shows the remaining overheating with adaptive solar shading only when present for all combinations of occupancy profiles and thermal mass in degree-hours and relative to the reference situation of minimised ventilation [%].

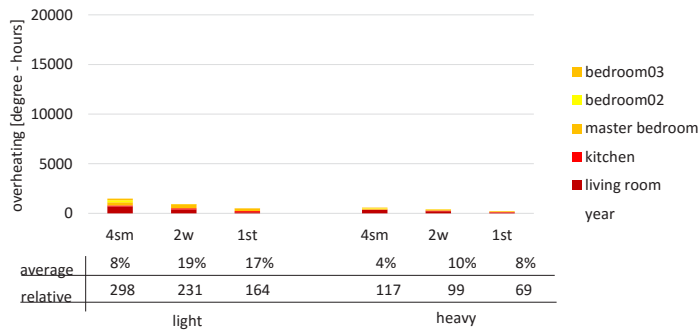
Figure 6.16 (3) shows the remaining overheating with adaptive ventilation and solar shading only when present for all combinations of occupancy profiles and thermal mass in degree-hours and relative to the reference situation of minimised ventilation [%].



1 overheating non-automated adaptive ventilation absolute [degree-hours] and relative to the reference situation of minimised ventilation [%]



2 overheating non-automated adaptive solar gain absolute [degree-hours] and relative to the reference situation of minimised ventilation [%]



3 overheating non-automated adaptive ventilation and solar gain absolute [degree-hours] and relative to the reference situation of minimised ventilation [%]

FIGURE 6.16 Remaining overheating with adaptive measures only when present for all combinations of occupancy profiles and ]thermal mass absolute [Degree Hours] and relative to the minimised ventilation variant [%]

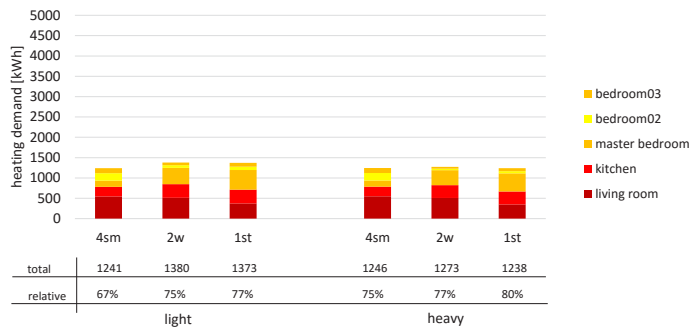
As evidently becomes clear from the previous figures the energy saving potential of automation is significant especially for solar shading. In the bedrooms there is no decrease in overheating with presence controlled solar shading because the sun will only shine significantly in the non-occupied hours when the solar shading is not operated. For the adaptive ventilation the differences are significant but considerably less prominent especially in case of the profile with the highest occupancy rate. The more the people are present, the less the difference between automated and presence operated and the difference is higher with high thermal mass than low thermal mass. Applying solar shading only when the occupants are present will be significantly less effective than automated solar shading leaving overheating levels almost similar to no solar shading with a decrease in effectiveness of up to 90%. If both measures can be applied only during presence the overheating is still considerable; at most for the family with young children (4sm) there will be an average of 298 degree hours left in the low thermal mass variant and 117 degree hours in the high thermal mass variant. Nevertheless this is still a decrease of around 90% compared to the reference situation with minimised ventilation which is enough to consider to omit the automation which can be costly and might not be preferred by the users.

#### § 6.4.7 Added energy saving potential of heat recovery

---

Following from the previous sections the energy saving potential for adaptive heating and minimised ventilation compared to the reference situation with heating by a standard schedule and a constant ACPH based on the Dutch ventilation standard (1.25 l/h) is dramatic and can save up to 50% for the highest occupancy rate (4\_sm) to 68% for the lowest occupancy rate. Applying heat recovery in the heating season can increase energy saving even more. [Figure 6.17](#) depicts the extra energy consumption for heating by mechanical ventilation with heat recovery (efficiency = 60%) absolute [kWh] and relative to [%] natural ventilation without heat recovery in case of minimised ventilation.





1 heating [kWh / %]

FIGURE 6.17 Extra energy saving by mechanical ventilation with heat recovery (60%) compared to natural ventilation without heat recovery in case of adaptive ventilation and solar gain

Figure 6.17 shows that the extra energy saving of 20% to 33% with heat recovery is still significant even if the heat loss by ventilation is decreased by minimised ventilation. High occupancy rates lead to higher energy saving potential because the heat recovery will have more heat to be recovered by more internal heat and higher ventilation rates. This is the case for both high thermal mass level and low thermal mass level. Though the energy saving in percentage is higher for the low thermal mass variants the remaining energy demand for heating is higher than for the high thermal mass variant; however, the differences are small.

## § 6.4.8 Auxiliary energy

Regarding energy saving for (new) techniques it is important to also incorporate the energy for operation of fans and control systems, the so-called auxiliary energy. In case of the natural ventilation, no extra energy for operation fans is needed, only the fan energy for the mechanical extraction which is less the less ventilation is applied. Extra auxiliary energy is needed for the operating system and communication as well as the automation of the ventilation openings and solar shading. Communication nowadays is present in most systems, wireless or wired. Most homes will have a network present at which the system can be connected to the Internet to communicate with the components of the systems and also enable the occupant to control the settings at a distance via Internet. It is not expected that the extra electricity for this communication will be anywhere near the energy saving it provides. To make sure no excess energy is spent, the components on the façade can be provided with PV cells that will provide the little energy needed to operate and they can contribute to the electricity needed to communicate with the system. In this design the solar cells can be applied on the hatch of the window vent. Furthermore, solar cells can be added to the solar screen; however they would only operate when solar shading is needed. With the further development of the components and the system, these aspects should be taken into account.

---

## § 6.5 Conclusions

---

### § 6.5.1 Requirements for the Adaptive Thermal Comfort System

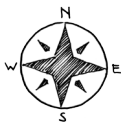
---

This chapter combined the knowledge of techniques for the adaptivity of the thermal comfort system described in chapter 3 with the conclusions of the calculations of chapter 5. Comparing these techniques shows that there is not one perfect system or solution and per project all considerations should be made to design an optimal system. Even though there are numerous techniques to construct an Adaptive Thermal Comfort System and the energy saving potential depends on various aspects and the collaboration between the applied techniques in specific scenarios some of which are already available and some are in various stages of development. In this chapter the possibilities of an Adaptive Thermal Comfort System for the near future is researched. Furthermore, the important aspects to consider about the comfort demand and natural thermal energy supply by the weather and how they should be combined are once more stressed to show the approach needed to design the Adaptive Thermal Comfort System. The conditions for the spatial layout of the dwelling to enable effectiveness of the adaptive measures is described as well as the aspects needed to be considered for control of the systems.

#### Preconditions for the effectiveness of an Adaptive Thermal Comfort System

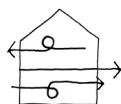
---

##### Orientation



To optimise effectiveness of the adaptive solar gain for both saving energy for heating allowing maximum solar radiation in and blocking maximum solar radiation the rooms with the highest heating demand and/or very variable comfort demand should be oriented in the direction where most solar radiation comes from if possible considering the time of day of the highest heating demand.

##### Ventilation



To ensure the effectiveness of the adaptive ventilation the layout should not hinder the air flow through the building. In case of a heating demand this free air flow can be temporarily disabled by (automatically) closing doors and vents. From the calculations in this chapter it becomes clear that the concept (Figure 7.6) with extra large operable vents above the windows of 30 cm together with operable vents above the internal doors and an additional opening in the roof in the stair case has significant reduction of

overheating. To be able to reduce the overheating more by ventilation the next chapter describes a concept to enhance the ventilation more by stack ventilation and a venturi shaped chimney (Figure 7.3). These will have an additional advantage of lowering the need for fan energy for the mechanical exhaust.



### **Automation**

An optimal Adaptive Thermal Comfort System is automated and therefore the system should be provided with sufficient information about the weather and occupant at the right time. For this a design should be made for the sensors and information transfer to the control unit.

This automation also implies communication between the control unit and the end units which should be able to operate automatically by a signal without interaction with the user. In this design it is crucial to research the acceptance of the user of this fully automated system according to the aspects mentioned in § 3.6.

### **Composition of the adaptive components of an Adaptive Thermal Comfort System in a standard reference dwelling in the near future**

---

#### **Adaptive heating**

Heating only where and when needed at the level needed by the user.

#### **Automated solar shading**

Solar shading controlled to block solar radiation when needed to prevent overheating and allowing maximum amount of solar radiation in the heating season to decrease the heating demand.

#### **Automated ventilation either by natural supply or mechanical supply.**

Adaptive ventilation (preferably by natural ventilation to save fan energy and space for ducts) controlled to discard excessive heat when needed to prevent overheating and minimise ventilation for fresh air in the heating season to decrease the heating demand.

The conclusion chapter shows a visualisation of a full concept of applying an Adaptive Thermal Comfort System into a standard reference dwelling with techniques nowadays available (Figure 8.2).

## § 6.5.2 Energy saving potential of the of the Adaptive Thermal Comfort System in a standard reference dwelling

---

In this chapter, the conclusions made in chapter 5 are verified with the concepts developed in this chapter as examples for an Adaptive Thermal Comfort System to be applicable in a current design. It shows that minimizing the ventilation in winter can save almost half of the energy used for heating and that by adaptively blocking the solar radiation and raising the ventilation can prevent overheating that can occur for an important part as a result of this minimised ventilation. This shows that with techniques already available a dwelling can be highly reactive to the changes in the weather optimizing the thermal heat balance for the majority of occurring situations. It also shows that the measures to vary the ventilation and the solar factor are well within the range of possibilities already available with common techniques.

It should be noted that there is no energy saving due to increasing the solar gain as there are no readily available techniques to do so dynamically. The ventilation openings above the window of approximately 30cm can create a high enough ventilation rate together with openings above the internal doors of also 30cm to prevent the dwelling from overheating. The ACPH can rise up to 12 l/h; however, this is a peak value that only occurs less than 5% during the summer months. It should be noted that the adaptive ventilation works better in the TRNSYS model than the adaptive heat loss factor in the lumped capacitance model. The prevention of overheating can be enhanced by additional measures to propagate natural air flow for ventilation as well as minimizing the needed for fan energy for mechanical extraction.

The need for cooling can be effectively diminished using the proposed flexible measures;. practically this means that there should be no need for installing active cooling in the dwelling and thus an energy saving potential of 100% can be reached. For saving energy on heating the situation of minimised ventilation with heat recovery is clearly the best option. The total energy saving compared to fixed natural ventilation is dramatic (almost 50% energy saving). However, as seen before applying all measures for energy conservation in the heating season needs counteractions in the cooling season to prevent overheating. [Table 6.6](#) shows a summary of the characteristics and energy saving potential for all separate measures and in the end of all measures together. In all cases the remaining heating demand is less than half of the original demand ranging from 41% to 29%. The loss in effectiveness of the adaptive solar gain is dramatically decreased without automation with an average of 75% less energy saving, which effect is most apparent with lower occupancy rate. The energy saving potential for the combined measures without automation drops with 30% on average. This makes the automation crucial for the Adaptive Thermal Comfort System.

		4SM		2W		1ST		AVERAGE
		light	heavy	light	heavy	light	heavy	
adaptive heating	<b>energy saving potential<sup>1</sup></b>							
	heating	3%	7%	25%	31%	31%	37%	22%
	overheating	-	-	-	-	-	-	-
minimised ventilation	ACPH [1/h]	0.5 + 0.2*p						
	<b>energy saving potential<sup>1</sup></b>							
	heating	44%	47%	41%	43%	43%	44%	44%
	overheating !	-	-	-	-	-	-	-
adaptive heat loss coefficient	ACPH [1/h]	0.5-10						
	<b>energy saving potential<sup>1</sup></b>							
	heating	-	-	-	-	-	-	-
	overheating	88%	94%	84%	92%	87%	94%	90%
	automation <sup>2</sup>	-2%	-2%	-6%	-4%	-14%	-6%	-6%
adaptive solar factor	F <sub>c</sub>	0 - G <sub>w</sub> * f <sub>g</sub>						
	<b>energy saving potential<sup>1</sup></b>							
	heating	-	-	-	-	-	-	-
	overheating	93%	98%	95%	100%	97%	100%	97%
	automation <sup>2</sup>	-49%	-49%	-86%	-89%	-84%	-85%	-74%
heat recovery	efficiency of HR	60%						
	<b>energy saving potential<sup>1</sup></b>							
	heating	24%	21%	19%	16%	18%	14%	19%
	overheating	-	-	-	-	-	-	-
ATCS	<b>energy saving potential<sup>1,3</sup></b>							
	heating	59%	61%	66%	68%	68%	71%	65%
	overheating	98%	100%	99%	100%	99%	100%	99%
	automation <sup>2</sup>	-6%	-3%	-18%	-10%	-16%	-8%	-10%

- 1 These values are based on the calculations with the assumptions of this chapter and are based on the reference dwelling of AgentschapNL. The variation in energy saving potential per situation depends on the thermal mass level.
- 2 In this row the negative percentage represents the decrease in effectiveness against overheating if the adaptive measure is not automated
- 3 The total energy saving potential of **all discussed measures** compared to the reference situation with average insulation, average solar factor and constant ventilation [1.25/h]
- Not applicable
- ! Overheating escalates without additional measures in summer

TABLE 6.6 Summary of energy saving potential of the Adaptive Thermal Comfort System based on the generic calculations of this chapter

# PART 3 Synthesis



# 7 The Adaptive Thermal Comfort System

## § 7.1 Introduction

In this chapter the information and conclusions of the previous chapter is combined and connections are made between the various categories and all is regarded how to work together to form an Adaptive Thermal Comfort System.

From the previous chapters the most important aspects for the Adaptive Thermal Comfort System in Dwellings are;

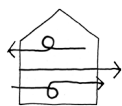
### Preconditions for the effectiveness of an Adaptive Thermal Comfort System

#### Orientation



To optimise effectiveness of the adaptive solar gain for both saving energy for heating allowing maximum solar radiation in and blocking maximum solar radiation the rooms with the highest heating demand and/or very variable comfort demand should be oriented in the direction where most solar radiation comes from if possible considering the time of day of the highest heating demand.

#### Ventilation



To ensure the effectiveness of the adaptive ventilation the layout should not hinder the air flow through the building. In case of a heating demand this free air flow can be temporarily disabled by (automatically) closing doors and vents. From the calculations in this chapter it becomes clear that the concept (Figure 7.6) with extra large operable vents above the windows of 30 cm together with operable vents above the internal doors and an additional opening in the roof in the stair case has significant reduction of overheating.





### **Automation**

An optimal Adaptive Thermal Comfort System is automated and therefore the system should be provided with sufficient information about the weather and occupant at the right time as well as predictive properties. For this a design should be made for the sensors and information transfer to the control unit.

This automation also implies communication between the control unit and the end units which should be able to operate automatically by a signal without interaction with the user. In this design it is crucial to research the acceptance of the user of this fully automated system according to the aspects mentioned in [§ 3.6](#).

### **Composition of the adaptive components of an Adaptive Thermal Comfort System**

---

#### **Adaptive heating**

Heating only where and when needed at the level needed by the user.

#### **Automated solar gain**

Solar gain controlled to block solar radiation when needed to prevent overheating and allowing maximum amount of solar radiation in the heating season to decrease the heating demand.

#### **Automated ventilation either by natural supply or mechanical supply.**

Adaptive ventilation (preferably by natural ventilation to save fan energy and space for ducts) controlled to discard excessive heat when needed to prevent overheating and minimise ventilation for fresh air in the heating season to decrease the heating demand.

## § 7.2 Occupancy in the Adaptive Thermal Comfort System



In § 2.3 analysis of the population for vulnerabilities and preferences together with time use studies, teaches us that comfort demand profiles can differ significantly in occupancy patterns and also the preferences for temperature. Most important differences in this research will be the occupancy of the rooms because these can significantly influence the comfort demand in time and space.

### Comfort temperature

Because of the differences in vulnerability for the thermal environment between groups the emphasis of the Adaptive Thermal Comfort System should be to facilitate the occupant to create his own environment fitting to its current activities within certain bandwidths concerning energy consumption rather than controlling the setpoint to a rigid temperature as in the office environment. This shifts the focus from an actual comfort temperature to a range of temperatures likely to be demanded and their variability and bandwidth (depicted in Figure 7.1) as well as the time and place of demand and this can help lower the energy demand for thermal comfort;

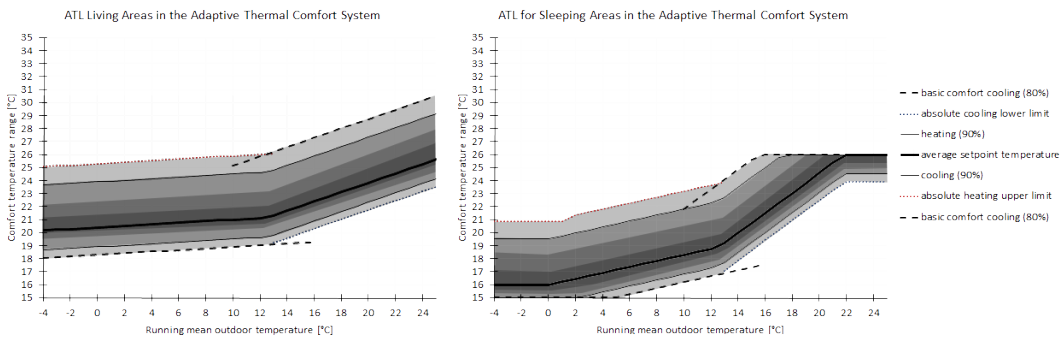


FIGURE 7.1 Interpretation of comfort temperature and bandwidth for living areas and bedrooms based on the equations by Peeters (2009)

### Occupancy profiles

By recognizing the differences in occupancy patterns it becomes possible to design adaptive systems to be able to deliver the comfort demanded only when and where necessary in different occupancy scenarios. This is an opportunity to achieve a significantly better energy performance. Table 7.1 shows a summary of characteristics of the 3 occupancy profiles used in the calculations. Especially the living room has large differences in occupancy rates and amount of people present.

characteristic	LIVING ROOM			KITCHEN			MASTER BEDROOM			BEDROOM 2 / OFFICE		BEDROOM 3			not at home	
	occupancy rate	average occupancy	average activity	occupancy rate	average occupancy	average activity	occupancy rate	average occupancy	average activity	occupancy rate	average occupancy	average activity	occupancy rate	average occupancy		average activity
profile																
1_st	10%	1.26	2.5	2%	1	3.25	33%	1	1	8%	1	2	-	-	-	53%
2_w	18%	1.32	2.1	8%	1	3.25	39%	1.73	1	1%	1	2	-	-	-	41%
4_sm	46%	1.70	2.4	15%	1.35	3.20	37%	1.77	1	43%	1	1	34%	1	1	16%
1_st	1 person household, student															
2_w	2 person household, both with job															
4_sm	4 person household, two children under the age of 5															

TABLE 7.1 Summary of occupancy characteristics of occupancy profiles to be used in the calculations

In chapter 5 and 6 it becomes clear that there is no large difference in effect on relative energy saving between the three occupancy profiles, because this system adapts to the occupancy demand. However, this means that the control of the thermal comfort system according to the occupancy and the resulting comfort demand is an essential part of the Adaptive Thermal Comfort System as the definition suggests.

Therefore, the difference is apparent in the case of adaptive heating; where high occupancy means less heating demand if a standard heating schedule is used because of higher internal gain the heating demand with control for presence shows less deviation between the occupancy profiles. This means that the energy saving is larger the lower the occupancy level.

Furthermore, the control algorithms is significantly less accurate in case of the occupancy profile 4\_sm with high occupancy especially because the temperature falls below the heating setpoint by the time the occupants re-enter the room resulting in higher heating demands than the reference. This effect decreases with higher thermal mass because of the slower temperature decrease.

Additionally, the occupancy has a great effect on the effectiveness of non-automated systems in case of overheating prevention. This emphasises the need for automated overheating protection by especially solar shading in case of larger periods of absence during the day.

### Prediction and control

To cater to these dynamic aspects of occupancy an adequate control system is very important (§ 7.7). The fine-tuning of the control for the Adaptive Thermal Comfort System would be helped by prediction in future occupancy but also for the comfort temperature. Adaptive Model Predictive Control (self-learning control) (§ 3.6.4) systems can provide this information and future research in thermal comfort and occupancy behaviour can be helpful in the future.

---

## § 7.3 Weather and the Adaptive Thermal Comfort System

---



The most important conclusions about the weather in relation to the Adaptive Thermal Comfort System from § 2.4 are;

### Cooling load

In theory, if well designed a building should not need to overheat as shown by this section. The overheating that does occur in practice is the result of trapping the heat accumulated by internal heat gain and solar radiation. Ensuring enough ventilation in the summer season to discard the excess of heat and keeping out the solar radiation should be able to create an indoor temperature almost equal to the outdoor ambient temperature which in 99% of the hours will be below the maximum temperature for thermal comfort.

This can be confirmed by the calculations from chapter 5 and 6 showing that the cooling demand can be effectively diminished by using both adaptive heat loss coefficient together with adaptive solar gain as shown in Table 7.7 depicting a summary of the average energy saving potential of the different adaptive measures separately and applied together calculated in chapter 5 (3R1C) and 6 (TRNSYS).

### Heating load

The need for heating can be significantly decreased leaving approximately 25% less underrun in degree-days if there is an optimal use of the sun combined with windscreens. An adequate building intrinsically provides this shelter from wind so in practice the wind will not influence the comfort indoors.

The calculations of § 5.3.4 show that the heating could be significantly reduced by approximately 60% for the living room and 90% for the bedroom oriented to the South maximizing the yield of solar radiation on the façade with a solar factor of 1 (harvesting 100% of the total radiation falling on the façade as heat) instead of the average solar factor of 0.4.

### **Variability of the weather**

Step changes are part of Dutch weather, especially day-to-day differences in weather are prominent and could have a significant influence on the heat balance of the building. Therefore, the systems should be flexible and able to switch swiftly; however, the temperature swings from day to day need to be dampened by for instance thermal mass.

In the calculations this can be confirmed by the fact the algorithm has difficulties to anticipate on future changes in demand and weather changes (§ 5.3.4, § 5.3.5 & § 5.3.5).

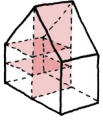
### **Future climate**

In the future climate scenario the heating load is expected to decrease with around 20% and the cooling load or overheating will likely be more than doubled.

### **Prediction and control**

From the calculations of chapter 5 and 6 it becomes clear that for optimisation of control it would be beneficial to have predicted values for temperature and solar radiation budget. The temperature, nowadays can be predicted quite accurately; however the actual sunshine locally is hard to predict. Therefore, more research on the prediction of local solar radiation could help fine-tuning the control for solar gain.

## § 7.4 Spatial layout of the Adaptive Thermal Comfort System



As discussed in § 3.3 the spatial layout of the dwelling can have great effect on the thermal comfort system and thus on the effectiveness of the Adaptive Thermal Comfort System especially on the ventilation and solar gain. Enforced by the calculations of chapter 5 and 6 some techniques are proposed based on improvements for the existing reference dwelling.

### Ventilation

To ensure the effectiveness of the adaptive ventilation the layout should not hinder the air flow through the building. In case of a heating demand this free air flow can be temporarily disabled by (automatically) closing doors and vents. From the calculations in chapter 6 it becomes clear that the concept (Figure 7.6) with extra large operable vents above the windows of 30 cm together with operable vents above the internal doors and an additional opening in the roof in the stair case has significant reduction of overheating (Table 7.7). For adaptive cross ventilation it can be beneficial to design an open floor plan which can be partitioned if no cross ventilation is required. Furthermore, if this is not possible a plenum can provide cross ventilation streams (Figure 7.2).

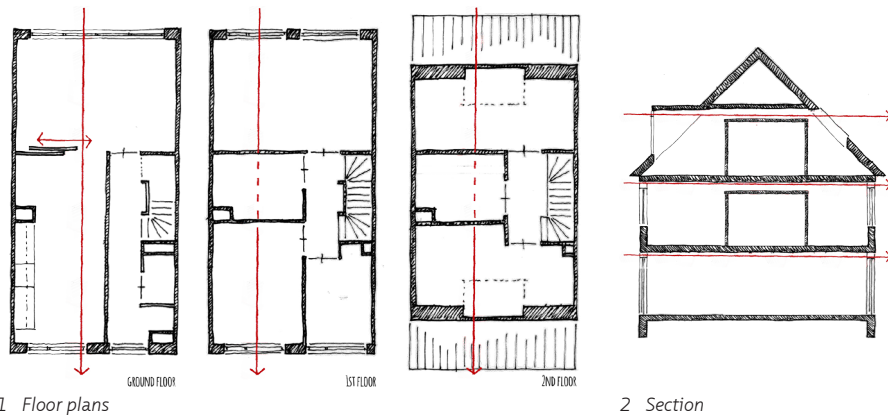
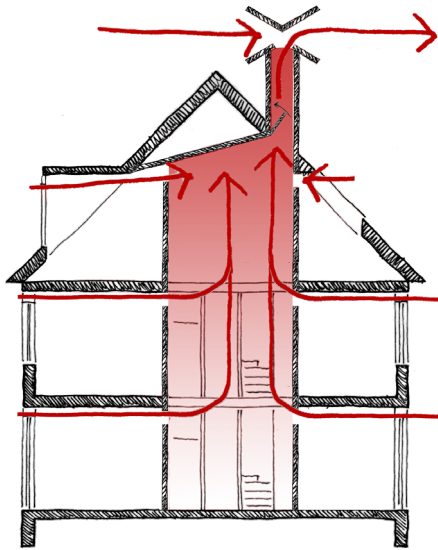
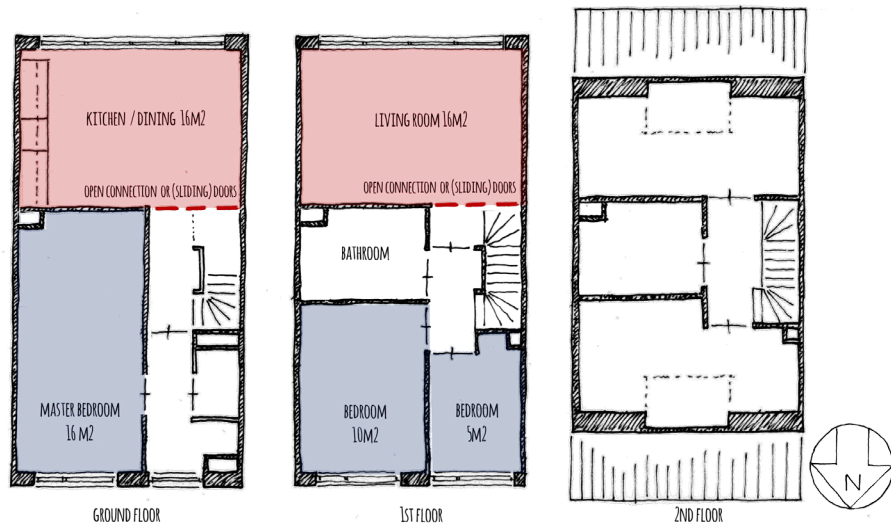


FIGURE 7.2 Extra ventilation in the reference dwelling by controllable en-suit separation on the ground floor and ventilation through plenum to “by-pass” the service spaces in the centre of the dwelling.

Furthermore, in a terraced dwelling usually the staircase will be able to provide some stack effect to enhance the extraction of air placing a controllable opening in the top of the staircase (Figure 7.3). Adding a venturi shaped chimney exit will increase the ventilation more. To make it adaptable the openings should be closable.



**FIGURE 7.3** Using the staircase to enhance air flow by extra extraction by the stack effect and the venturi shaped chimney exit



**FIGURE 7.4** Optimisation of the spatial layout of the reference dwelling to increase effectiveness of the adaptive solar factor

### Solar gain

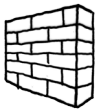
To optimise effectiveness of the adaptive solar gain for both saving energy for heating allowing maximum solar radiation in and blocking maximum solar radiation the rooms with the highest heating demand and/or very variable comfort demand should be oriented in the direction where most solar radiation comes from if possible

considering the time of day of the highest heating demand. Figure 7.4 proposes an alternative layout for the reference dwelling orienting the living spaces with highest heating demand and most variable demand to the South (most solar radiation) and the bedrooms with less heating demand but more cooling demand to the North (least radiation).

---

## § 7.5 Materialisation of the Adaptive Thermal Comfort System

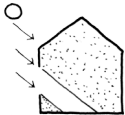
---



In § 3.4 possibilities to make the building characteristics of solar gain, natural ventilation, thermal insulation and thermal mass adaptive. Chapter 5 and 6 various concepts of this materialisation are assessed with calculations. For the four categories of materialisation the main conclusions for the Thermal Adaptive Comfort System are discussed in this section.

### § 7.5.1 Solar gain

---



From the inventory of § 3.4.1 it becomes clear that the possibilities for adaptive solar factor are ample although there are some points of improvement (Table 7.2).

#### Control and automation

All options for control of the solar gain should be able to be controlled and automated according to the heat load of the room. As with shading products there are many products on the market for control of shading; however, the implementation can leave much to be desired (Wienold, 2007; Meek & Brennan, 2011; Hashemi, 2014; Hoffmann et al., 2016).

#### Vulnerability and cost

Especially the techniques with (heavy) mechanical parts are vulnerable to mechanical damage by wind or vandalism and usually shading systems are costly, the more if they are automated. Further development of these products might be needed to make implementation feasible. Coatings and fluids to control the transparency could be a promising concept to be developed further because of the relatively simple techniques with little or no moving parts.



### Visual comfort

Solar shading can have a large impact on the visual comfort and can alter the colour of the view and totally block the view, which needs to be kept in mind.

### Range

The possibility in range for the G-value of the controllable shading is maximal with 0 to 100% shading. The control of transparency with available coatings is smaller; however, the development of new polymer coatings (Llordes et al., 2013) could change this.

### Auxiliary energy

All solutions besides the coatings need a motor to operate the system. This is something to be taken into account when improving and developing products. Solar shading can be combined with PV cells to use the blocked solar radiation for electricity generation, which can be used to operate the shading.

### Insulation

It should be noted that changes in U-value can occur while changing the solar factor. This influence is highest using movable insulating panels. Furthermore, increasing the glass percentage of the façade to enhance the benefits of solar radiation (usually) leads to a decrease in insulation as transparent constructions have a lower insulation level than most opaque constructions. For this reason the glass percentage on the North façade should be considered to be less because the benefit of solar radiation will be significantly less. Furthermore, constructions to increase the insulation value such as thermal hatches can cancel this negative effect of higher glass percentage on the insulation level.



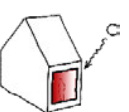
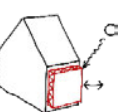

category		methods for adaptivity in practice			
irradiation		area of incidence 	transparency 	panels 	collector 
	improvements	control; vulnerability	control; cost	control; vulnerability	control
	concerns	auxiliary energy	auxiliary energy	auxiliary energy	auxiliary energy
	opportunities		implementation of fluid replacement	implementation	implementation control

TABLE 7.2 Improvements, concerns and opportunities for adaptive solar factor.

The energy saving potential calculated in chapter 5 and 6 of the adaptive solar factor is very high as shown in Table 7.7. The overheating can be diminished effectively and by virtually raising the solar factor to 1 (meaning 100% of all incidence solar radiation on the façade enters the room as heat) can save around 60% on heating demand in the living room and kitchen and around 90% in the South oriented bedroom. It should be noted that the heating demand for the bedroom is already low and therefore needs less solar radiation to reduce this demand dramatically. In the calculations of chapter 6 there is no energy saving for heating by the adaptive solar factor because the glass percentage is not considered to be adaptive and the existing glass types only allow for G-values of 0.6 which means that the highest solar factor is 0.4 as opposed to 1 in the 3R1C Excel calculations of chapter 5.

To be able to optimally control the solar radiation, the façades (especially those which border rooms with high heating or highly variable comfort demand) should be as transparent as possible to have the highest possible range in solar factor. It should be considered that usually the transparent separation constructions have a lower insulation value than opaque separation constructions, which can lead to higher heating demand.

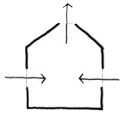
Continuing with the adapted spatial layout of § 7.4 in Figure 7.4 the reference dwelling can be improved by increasing the glass percentage on the South façade where the living room and the kitchen are situated with controllable solar shading and the glass percentage of the North façade can remain relatively low to be complemented with thermal hatches to increase the thermal insulation when needed (Figure 7.5).



FIGURE 7.5 Optimisation of the façade increasing the glass percentage of the South using screens or awnings for adaptive solar gain on the South façade and thermal hatches on the North façade.

## § 7.5.2 Natural ventilation

---



Because of the good opportunities for control of natural ventilation already applicable in practice the improvements are mainly to increase the existing possibilities in automation and reducing the cost and auxiliary energy (Table 7.3).

### Control and automation

The existing techniques for control and automation can be improved to be controlled not only for fresh air but also for temperature control.

### Range

The possible range of heat transfer by ventilation is very large. Per air exchange of the room per hour a  $H_{\text{tot}}$  of 0.33 W/K per  $\text{m}^3$  of room volume. However, the nuisance of draft should be avoided and therefore the placement of the openings should be carefully chosen.

### Vulnerability and cost

Electronically controlled registers are widely used in practice and have proved their cost effectiveness and robustness. Larger controllable openings as windows should be designed robust and burglary proof with for instance protective grids. An example of larger ventilation openings are the openings used in the Healthy School Concept® by Renson (2014) shown in [Figure 3.11](#).

### Auxiliary energy

All solutions need a motor to operate the system. This is something to be taken into account when improving and developing products. PV cells on the façade (for instance on the solar shading as mentioned in [§ 3.4.1](#)) can be considered to be integrated for this purpose.

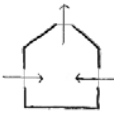
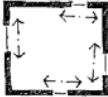
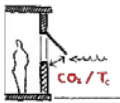
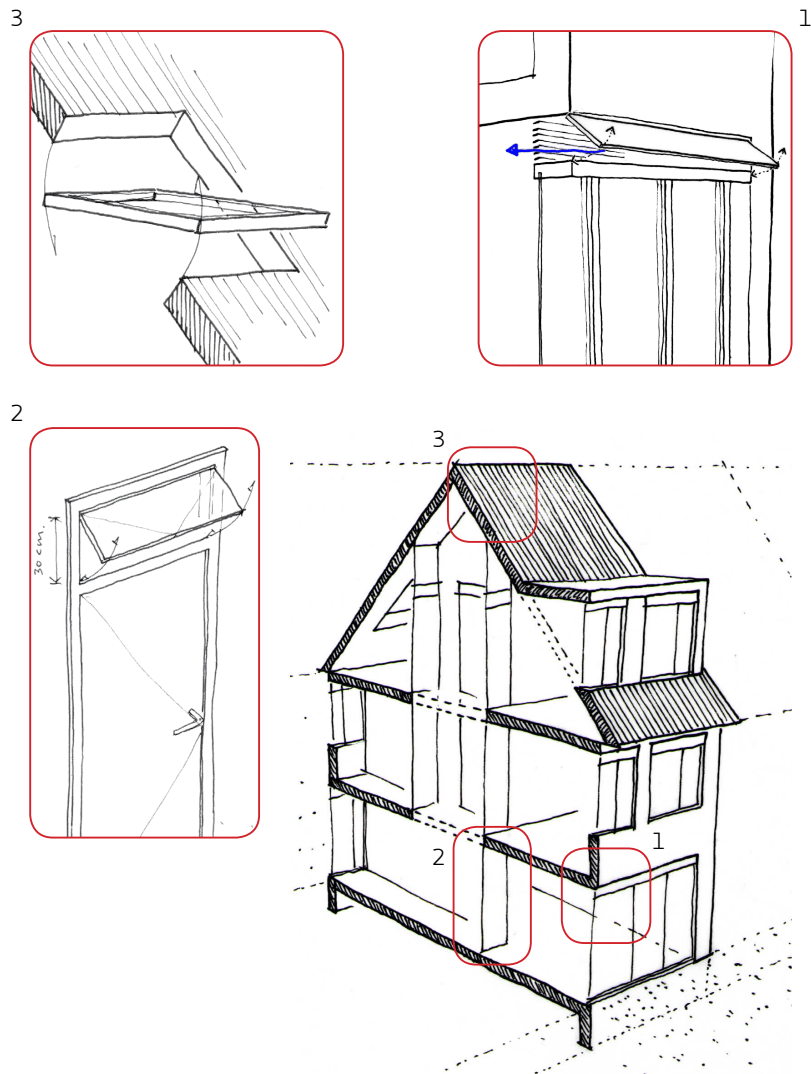
category		methods for adaptivity in practice			
natural ventilation		placement of the openings 	control of openings 		
	improvements		temperature control; cost		
	concerns	draft	auxiliary energy		
	opportunities	design			

TABLE 7.3 Improvements, concerns and opportunities for adaptive natural ventilation

### Energy saving potential and concepts for adaptive ventilation as passive cooling

Minimisation of the ventilation to reduce heat loss is a wide spread technique as discussed in § 3.5.1. Chapter 5 concludes that if optimally controlled with no extra infiltration loss the energy saving can be as much as 66% on average for the living room and 90% for the bedroom (Table 7.7). The more detailed calculations with TRNSYS in chapter 6 show a total energy saving for the whole reference dwelling of 44% average energy saving can be realised which is significantly less. This is because of the differences in the models if it comes to heat distribution along the thermal nodes as argued in § 4.3.5 and the fact that the TRNSYS model has some heat loss by infiltration through the modelled cracks (Appendix D). Furthermore, the TRNSYS model calculates a whole house and the heat exchange between the heated rooms and non-heated rooms contributes to the extra heat loss. However, the energy saving in both models is considerable and both show a drastic increase in overheating of twice to 5 times compared to the reference with constant ventilation rate (ACPH) of 1.25 l/h.

The adaptations made to the materialisation of reference dwelling of AgentschapNL (Figure 7.6) in chapter 6 make it possible to decrease the overheating with an average of 70% with controlled natural ventilation without extra mechanical extraction (Table 7.7).

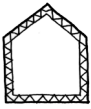


- 1: Vents above windows of 30 cm height controlled for adaptive ventilation for passive cooling
- 2: Vents above internal doors of 30cm height opened together with vents above windows in the corresponding room to enhance airflow through the building
- 3: Rooflight in staircase opened with either window vent in the house to enhance airflow through the building

**FIGURE 7.6** Concept for varying the natural ventilation for passive cooling by purge ventilation in the TRNSYS simulations (combined with base minimised ventilation natural supply, mechanical exhaust)

### § 7.5.3 Insulation

---



As argued by § 3.4 and confirmed by the calculations in § 5.3.3 the possible range in heat loss factor by transmission is significantly less than for the heat loss factor by ventilation. Therefore, steps should be taken in developing new techniques and concepts for adaptivity in insulation to be able to compete with the much easier variation in heat loss by ventilation focussed on high heat conductivity. One option to drastically increase heat loss through the façade is to remove the façade construction all together; however, this would above all increase the heat loss by ventilation. In case there is adequate solar shading the option of adaptable insulation becomes more feasible because lower heat loss coefficients are needed. The possible improvements and new developments discussed in § 3.4.3 are summarised in Table 7.4 and can be listed as follows;

#### Control and automation

All options for control of the insulation should be able to be controlled and automated according to the heat load of the room. This means that the control system needs an accurate control algorithm which can anticipate the need for admitting or discarding solar radiation keeping into mind the user aspects (perceived usefulness and use of control, avoiding visual and auditive nuisance), described in § 3.6.

#### Vulnerability and cost

Especially the techniques with (heavy) mechanical parts are vulnerable to mechanical damage by wind or vandalism and usually shading systems are costly, the more if they are automated. This is a very important aspect to be considered when developing the new techniques. Coatings and fluids to control the transparency could be a promising concept to be developed further because of the relatively simple techniques with little or no moving parts. However, the newly developed coatings can be costly in the beginning.

#### Range

Much is still unsure about the range of thermal insulation of the new products. However, this is a very important aspect to be considered and should be compared to the range obtainable by ventilation control. The total  $H_{tot}$  depends on the total surface area of the separation construction to the room volume and the U-value. Higher ranges can be reached with large surface to volume ratio; however this can compromise the energy conserving possibilities in winter.

## Auxiliary energy

The use of auxiliary energy is still very uncertain. Together with the range and total installation cost this should be incorporated to make a cost and effect analysis.

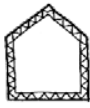
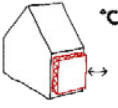



category		methods for adaptivity in practice			
insulation		insulative panels 	gas or fluid replacement 	DIM 	bi-directional thermal diode 
	improvements	control; vulnerability	control; cost		
	concerns	auxiliary energy	auxiliary energy	auxiliary energy	auxiliary energy
	opportunities	implementation	implementation of fluid replacement	to be developed	to be developed

TABLE 7.4 Development, improvements, concerns and opportunities for adaptive thermal insulation

## § 7.5.4 Thermal mass



In § 3.4.4 it is argued that it is very experimental and elaborate to make the thermal mass adaptive; though, P.J. Hoes (2014) has done a PhD research at the University of Technology in Eindhoven about Hybrid Adaptive Thermal Storage (HATS) and describes some experimental methods to do so. The most feasible solution is to change the mass of the storage medium for instance using fluid in the storage element which can be removed and replaced. A commonly used example of this technique is concrete core activation. Table 7.5 shows the opportunities for development of adaptive thermal mass with the concerns as described in § 3.4.4.


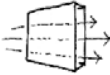
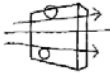


category		methods for adaptivity in practice			
thermal mass		storage capacity 	heat transfer by convection 	heat transfer by radiation 	heat transfer by conduction 
	improvements	control	control		
	concerns	auxiliary energy		auxiliary energy	auxiliary energy
	opportunities	extending application	extending application	to be developed	to be developed

TABLE 7.5 Development, improvements, concerns and opportunities for adaptive thermal mass

Additionally, from the calculations of chapter 5 and 6 that there is no need for adaptive thermal mass in **well insulated** dwellings with **sufficient solar radiation** because in these the cooling is significantly lower for all rooms and occupancy profiles if high thermal mass is applied and even the heating is slightly lower with high thermal mass because the incoming solar radiation is used more beneficial by the thermal mass accumulating the heat to be used later on to decrease heating demand.

Furthermore, in the Adaptive Thermal Comfort System the energy saving for cooling by the adaptive strategies is higher with high thermal mass more drastically reducing the already much lower cooling demand for higher thermal mass. This can be explained by the fact that the thermal mass causes the heat to be lost to spread more evenly amongst the hours which means the peaks for heat to be discarded will be much lower.

In case of the North orientation it can be an option to build with lower thermal mass combined with lower glass percentages as proposed in § 7.5.1 because the solar radiation with average glass percentage has significantly less effect on the heating demand showing a slight increase in heating demand for the higher thermal mass. Decreasing the glass percentage will increase the opportunity to use high insulation.



## § 7.6 HVAC



The main concerns for the HVAC systems in the Adaptive Thermal Comfort System that can be more important than for traditional dwellings is **controllability, locality and above all speed** of heating and cooling (Table 7.6), giving the opportunity to deliver thermal comfort only when and where needed at the level needed according to the definition of an Adaptive Thermal Comfort System. Chapter 5 calculates that doing so can save around 35% on average in the living rooms with a maximum of around 45% in the occupant profiles with the least occupied hours compared to a fixed heating schedule. In the bedrooms the energy saving is less because the occupancy in all cases is similar to the standard fixed heating schedules as well as the fact that less heating is required for the bedrooms because of lower comfort temperatures. Chapter 6 shows significantly less energy saving on heating. As with the minimisation of the heat loss factor described in § 7.5.2 this is because of the differences in the models if it comes to heat distribution along the thermal nodes as argued in § 4.3.5 and the fact that the TRNSYS model has some heat loss by infiltration through the modelled cracks (Appendix D). Furthermore, the TRNSYS model calculates a whole house and the heat exchange between the heated rooms and non-heated rooms contributes to the extra heat loss.

Chapter 6 shows that for the mechanical ventilation the **additional** energy saving potential for heating in the Adaptive Thermal Comfort System of heat recovery is around 20%.

Heat up and cooling down speed are important characteristics of heating and cooling systems. In the calculations of this thesis it is assumed that the heating power is unlimited and there is no limit to the speed. From the calculations with the 3R1C model it becomes clear that 5 % of the time the required heat up for adaptive heating is quite high for the living room depending on the thermal mass and occupancy profile with approximately 6 °C and the cool down speed is between 1.5 °C and 0 °C. With higher thermal mass, the required heat up step will be smaller; however, the heat up speed will be lower as well. In 20% of the time the heat required heat up speed will be significantly lower; however still high with around 4 °C. Stabilising the indoor temperature by minimising heat loss will lower the required heat-up or cooling-down speed and added solar gain lowers the required speed even more until below 4 °C for lower thermal mass and below 0.5 °C for higher thermal mass, provided that the set point temperature is optimised as described in § 5.4.4. In the bedrooms the required heating up speed will be much lower and the cool down speed will be slightly higher. This can be a serious limitation for the concept of adaptive heating, emphasizing the importance of heat-up speed for the system to be chosen. Therefore improvements for HVAC systems will involve heating up and cooling down speed.

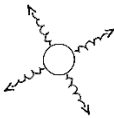
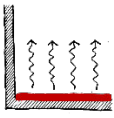
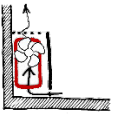

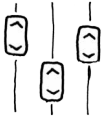
category		methods for adaptivity in practice			
thermal energy delivery		radiative 	convective 	air 	
	improvements	speed	speed	comfort	
	concerns			draft; pollution; noise	
	advantages	comfort	comfort	fast	

TABLE 7.6 Improvements, concerns and opportunities for heating and cooling delivery

## § 7.7 Control systems for the Adaptive Thermal Comfort System



There is a distinct difference in control between the lumped capacitance model and the TRNSYS model. Because the 3R1C model is a lumped capacitance model implemented in Excel where every detail can be controlled by the user, the appropriate  $H_{\text{tot}}$  and the  $f_{\text{sol}}$  value can be directly estimated by using an equation. It is an hourly model and because a numerical solution for the equation could not be found (Appendix B), it is an estimate because the calculation assumes the node temperature from the time step before.

In TRNSYS the calculation can easily be executed in time steps much smaller than 1 hour. Combined with the fact that the calculation to the user is largely a black box in this research the ventilation and the solar shading are controlled as follows; A thermostat controls the setting of the shading and the ventilation to be minimum or maximum according to the indoor temperature. The average value of these settings over an hour can be regarded as the hourly setting as if it were controlled hourly.

As discussed in chapter 5 (§ 5.3.3 & § 5.3.4) it is a challenge to find the appropriate control for the adaptive heat loss factor and solar factor because cooling too much can cause an extra heating demand. In the TRNSYS calculations of chapter 6 this effect is less apparent but the cooling effect of the extra ventilation and solar shading is also less than the larger ranges in the calculations of chapter 5. Furthermore, the temperature in the TRNSYS calculations show more stability because of the way the heat transfer between the indoor temperatures in the models influenced by the thermal mass and the way the thermal mass is defined. In the Excel model the heat loss by ventilation is directly imposed on the air node and distributed to the thermal mass via the central node. The distribution of the heat loss in the TRNSYS model is more gradual and slower by the use of the FEM calculation.

These differences show how important the control of the Adaptive Thermal Comfort System is. Above all it becomes clear from both § 5.3.8 as chapter § 6.4.6 that it is crucial to automate the Adaptive Thermal Comfort System to be adaptable during absence as well. This poses extra constraints on the control and quality of the adaptive components and the prediction in comfort demand and weather.

Last but not least, § 5.3.7 shows that it is crucial to operate the adaptive components with a high frequency (instantaneous or in the calculations equal to the simulation time step).

AVERAGES		3RIC		TRNSYS
		living room	bedroom	whole house
adaptive heating	energy saving potential <sup>1</sup>			
	heating	34%	16%	22%
	overheating	-	-	-
minimised heat loss	ACPH [1/h]	0.5 + 0.2 * p		
	energy saving potential <sup>1</sup>			
	heating	66%	90%	44%
	overheating !	-	-	-
adaptive heat loss coefficient	ACPH [1/h]	0.5 - 30 <sup>2</sup>		0.5 - 10 <sup>3</sup>
	energy saving potential <sup>1</sup> (*)			
	heating	-1%	-1%	-
	automation <sup>3</sup>	9%	6%	-
	overheating	84%	92%	90%
	automation <sup>3</sup>	22%	6%	6%
adaptive solar factor	F <sub>c</sub>	0 - 1		0 - G <sub>w</sub> * f <sub>g</sub>
	energy saving potential <sup>1</sup> (*)			
	heating <sup>4</sup>	63%	83%	-
	automation <sup>3</sup>	54%	83%	-
	overheating	99%	95%	97%
	automation <sup>3</sup>	56%	93%	74%
heat recovery	efficiency HR	60 %		
	energy saving potential <sup>1</sup>			
	heating	-	-	19%
	overheating	-	-	-
ATCS	energy saving potential <sup>1</sup> (*)			
	heating	61%	99%	65%
	automation <sup>3</sup>	55%	105%	-
	overheating	100%	100%	99%
	automation <sup>3</sup>	27%	14%	10%

- 1 Based on the generic calculations with the assumptions in Appendix C and Appendix D and on the reference dwelling of AgentschapNL.
- 2 The range of H<sub>tot</sub> for the 3RIC model is given in the amount of ventilation needed with the average values of insulation (R<sub>c</sub> = 5 m<sup>2</sup>K/W and U<sub>w</sub> = 1.6 W/m<sup>2</sup>K)
- 3 In this row the percentage represents the decrease in effectiveness against overheating if the adaptive measure is not automated
- 4 The energy saving potential of the solar factor for heating is due to the maximisation of the solar gain in the heating season (§ 5.3.4)
- 5 The total energy saving potential of **all discussed measures** compared to the reference situation with average insulation, average solar factor and constant ventilation [1.25/h]
- Not applicable
- ! Overheating escalates without additional measures in summer

TABLE 7.7 Summary of average energy saving potential of the Adaptive Thermal Comfort System based on the calculations of this thesis



# 8 Conclusions and Recommendations

---

## § 8.1 Introduction

---

A dwelling with an **Adaptive Thermal Comfort System** is a dwelling in which the whole of passive and active comfort components **dynamically adapts** its settings to **varying user comfort demands** and **weather conditions** - seasonal, diurnal and hourly - thus providing comfort **only where, when and at the level needed** by the user, whilst **harvesting the energy delivered naturally** when available and storing it when abundant. In this thesis the opportunities for such an **Adaptive Thermal Comfort System** with an **Adaptive Thermal Comfort System** were researched. Not only the weather, the occupant and the settings of the mechanical installations are regarded as dynamic, but also the building characteristics insulation, solar gain and thermal mass are considered adaptive.

The research investigated the possibilities to make a dwelling adaptive and calculated the energy saving potentials of flexible insulation, solar gain, ventilation and thermal mass answering the main research question;

*What are the most efficient strategies for delivering thermal comfort in the residential sector with respect to better energy performances and an increasing demand for flexibility in use and comfort conditions?*

---

## § 8.2 Answering the research question

---

In the Netherlands there is predominantly a need for protection against cold and if well designed there should be no need for active cooling in a dwelling. The cooling need that occurs in practice is for the greater part caused by trapping the heat produced by solar radiation and indoor thermal gain. Even in the projected climate scenario W+ for 2050 this is still the case. High thermal mass can decrease the overheating by the dampening effect on temperature fluctuations (§ 2.4; § 5.3.5; § 6.4.6).

It becomes clear that energy saving in winter is relatively simple. Through efforts of energy conservation by applying high thermal insulation, very airtight construction and minimizing ventilation losses the energy for heating can be significantly decreased by around 50% and additionally applying optimised solar gain can result in an energy saving potential of even around 80% (§ 5.3.2; § 6.4.2).

However, failing to take into account the overheating problem while optimizing for winter can become a serious problem. To be able to fully profit of energy saving techniques both in heating and summer season the energy balance can be optimised by adaptive building characteristics as the heat loss by predominantly ventilation (in the future insulation might be optimised as well) together with solar shading that blocks most of the solar radiation before overheating will occur (§ 5.3.5; § 6.4.6). To optimise between heating and cooling load needs some form of prediction by Adaptive Model Predictive Control (self-learning control) (§ 3.6.4) and preferably thermal storage (e.g. high thermal mass of HATS) to prevent passive cooling to cause an increase in heating demand.

Another important conclusion is that the energy saving potential of the Adaptive Thermal Comfort System significantly increases if the heat loss and especially the solar gain are controlled automatically during absence of the occupant (§ 5.3.8; § 6.4.6).

The Adaptive Thermal Comfort System can be successfully applied in newly built homes as well as part of refurbishment of existing dwellings without significant restrictions for architecture provided that the following points are taken into account;

### Occupancy (§ 2.3)

---



The occupancy schedule is used to determine the dynamic demand on which the behaviour and energy saving potential of the adaptive building characteristic are calculated in this thesis (Table 8.1). Great differences can exist in thermal comfort demand in occupancy of the spaces which makes the application of control according to presence a good way of saving energy for heating. Relatively simple measures as occupancy sensors connected to the control of the heating can save up to 25% of heating demand.

It is not possible nor necessary to determine the exact comfort temperature for the occupant. Instead, a range is determined which should be easy to reach in an energy efficient way. This thesis uses the Adaptive Temperature Model to assess comfort as this is proven to be most reliable for dwellings. However, some reservations need to be made as the analysis that provided the algorithms are not performed in the Dutch residential sector. Slight differences might occur in preferences.

## Weather (§ 2.4)

---



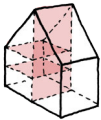
In this section it is confirmed that there is virtually **no overheating problems** are **caused directly by the weather** and that the **overheating occurring in dwellings** is due to the **trapping of heat** from incoming solar radiation and internal gains.

Regarding the weather as a dynamic combination of the main variables ambient temperature, solar radiation and wind in relation to thermal comfort by using the PET (Physiological Equivalent Temperature) reveals that the weather is much more variable than one concludes at first sight.

A simple adaptive shelter with a separate adaptive solar shading and windscreen can precondition the local thermal environment to bring it closer to the comfort temperature can significantly improve the comfort experience without a building. In the Netherlands this means that the greater part of the year protection from the wind is needed.

## Spatial layout (§ 3.3 & chapter 6)

---



The layout of the dwelling in the Adaptive Thermal Comfort System is not necessarily adaptive; this can be very cumbersome and has great practical implications. There are some possibilities and these are described in this thesis (§ 3.3) for possible further research. However, there are some preconditions that will facilitate the functioning of the Adaptive Thermal Comfort System.

### Ventilation

To ensure the effectiveness of the adaptive ventilation the layout should not hinder the air flow through the building. In case of a heating demand this free air flow can be temporarily disabled by (automatically) closing doors and vents. To increase the ventilation for passive cooling in a standard dwelling in the Netherlands it is sufficient to provide large openings above the windows of around 30cm in height. To enhance the ventilation more additional measures can be taken for example applying a venturi shaped chimney and using stack ventilation (Figure 8.2).

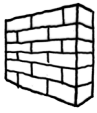
### Solar gain

To be able to profit optimally benefit from the adaptive solar factor the rooms with the highest heating demand and/or very variable comfort demand should be oriented in the direction where most solar radiation comes from if possible considering the time of day of the highest heating demand.



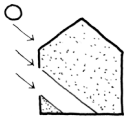
## Materialisation (S 3.4 & chapter 5 & 6)

---



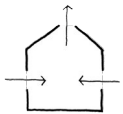
For energy saving in the heating season it is very effective to apply high insulation values and minimise ventilation to conserve energy together with allowing maximum solar radiation into the room. This can save up to around 80% in heating energy compared to the reference situation with constant ventilation and average insulation value (Table 8.1). This measure should be combined with adaptive solar shading and adaptive heat loss factor to prevent overheating problems outside the heating season. If it is possible to block all solar radiation this can eliminate practically all need for cooling (Table 8.1). Figure 8.2 shows an example of a full Adaptive Thermal Comfort System that can be applied to a standard reference dwelling in the Netherlands.

### Solar gain



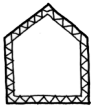
To optimise effectiveness of the adaptive solar gain for both saving energy as for heating allowing maximum solar radiation in and blocking maximum solar radiation by the glass percentage preferably should be maximal especially in the rooms with high heating demand and/or very variable comfort demand. In the calculations a fictive solar factor of  $1 - 0$  is used, meaning that it is possible to harvest all solar radiation falling on the facade as heat and blocking all of the solar radiation, which indicates the potential of new concepts to be developed making this possible. Preferably these glass surfaces combine high insulation level with high G-value. Blocking all solar radiation might not always be possible due to the absence of a vented cavity or the desire to preserve view out. The solar shading can be combined with high insulative properties to provide extra insulation if there is a heating demand and insufficient solar radiation by means of thermal hatches. Examples of solar gain control are illustrated in Figure 8.2.

### Ventilation



Increasing the ventilation at times of eminent overheating can significantly decrease the need for cooling. However, at times high ventilation rates are needed for that especially if there is no possibility for (adaptive) solar shading. To increase the ventilation for passive cooling in a standard dwelling in the Netherlands it is sufficient to provide large openings above the windows of around 30cm in height. Care should be taken that the air flow is not obstructed. In a dwelling it might not (always) be possible to provide sufficient ACPHs of around 10 because of the lack of cross ventilation properties. Therefore, the ventilation can be aided by fans or by designing the dwelling with increased cross ventilation, increased stack ventilation or a "venturi" chimney.

### Adaptive insulation



In the near future the adaptivity of insulation is not significantly effective compared to adaptive ventilation. Depending on the separation surface to heated volume ratio of the room the ventilation contributes to 90% of the heat loss factor in cooling situations and 2/3<sup>rd</sup> in the heating situations. Furthermore, the techniques that are available or in development in the time this thesis was written are expensive and laborious in comparison to varying ventilation. Making adaptive insulation competitive to adaptive ventilation research to develop new techniques and materials should emphasise highly heat conductive properties for passive cooling.

### Thermal mass



Thermal mass can cause to rise heating demand if the fluctuations in the air temperature are high. However, a well insulated dwelling with sufficient radiation will compensate for rapid temperature drops in the air and the thermal mass can store the solar radiation for later use so there is no counter effect on heating by thermal mass if sufficient solar radiation is available. The Adaptive Thermal Comfort System itself increases the stability in air temperature by optimizing the adaptive characteristics for the room temperature to remain closest to the comfort temperature without energy expenses. Therefore, no benefit for adaptive thermal mass in an Adaptive Thermal Comfort System is detected. High thermal mass is preferable for a dwelling with an Adaptive Thermal Comfort System as it is for all (sufficiently insulated and irradiated) dwellings. In case of the North situation or the lack of windows the thermal mass could be lowered.

### HVAC (§ 3.5 & chapter 5 & 6)

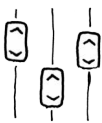
---



To save energy in the heating season it is very effective to apply adaptive heating (around 25%); providing heating only when and where needed at the level needed by the user and applying heat recovery has a significant added effect on energy saving (around 20%) for heating in the Adaptive Thermal Comfort System. HVAC systems are inherently adaptive because they need control systems to operate. The extra energy saving gained by designing HVAC systems for an Adaptive Thermal Comfort System is applying techniques that, besides being energy efficient, can react fast and locally.

### Controls (§ 3.6)

---



It is very important to have a high level of automation in the Adaptive Thermal Comfort System because applying high insulation, no solar shading and minimised ventilation at absence of the occupant will lead to overheating problems. The energy saving potential of the automation for the adaptive ventilation decreases significantly for

the profiles with least occupancy and lower thermal mass. The loss in effectiveness of the adaptive solar gain is dramatically decreased without automation with an average of 75% less energy saving. The energy saving potential for the combined measures without automation drops with 30% on average. This makes the automation crucial for the Adaptive Thermal Comfort System and mostly for the solar gain (Table 8.1).

Furthermore, prediction (for instance with a Adaptive Model Predictive Control (self-learning control) (§ 3.6.4) system) can increase the efficiency of the system preventing the heating load to increase due to rapid temperature drop after a period of passive cooling especially with low thermal mass.

### Energy saving potentials and ranges (chapter 5 & 6)

---

Table 8.1 shows the averages of the energy saving potential for all separate measures and in the end of all measures together for the generic calculations in chapter 5 without technical specifications and for the calculations of chapter 6 to assess the Adaptive Thermal Comfort System with current solutions. The table shows that the need for cooling can be effectively diminished using the proposed adaptive measures and so the energy saving potential is nearly 100%. An additional 20% can be saved on heating energy with heat recovery in the calculations with TRNSYS. In the lumped capacitance model an additional 63% energy saving can be obtained for the living room and 83% for the bedroom compared to the TRNSYS calculations by increased solar gain. This is in case it is possible to harvest all solar radiation falling on the facade as heat and blocking all of the solar radiation, which indicates the potential of new concepts to be developed making this possible.

AVERAGES		3RIC		TRNSYS
		living room	bedroom	whole house
adaptive heating	energy saving potential <sup>1</sup>			
	heating	34%	16%	22%
	overheating	-	-	-
minimised heat loss	ACPH [1/h]	0.5 + 0.2 * p		
	energy saving potential <sup>1</sup>			
	heating	66%	90%	44%
	overheating !	-	-	-
adaptive heat loss coefficient	ACPH [1/h]	0.5 - 30 <sup>2</sup>		0.5 - 10 <sup>3</sup>
	energy saving potential <sup>1</sup> (*)			
	heating	-1%	-1%	-
	automation <sup>3</sup>	9%	6%	-
	overheating	84%	92%	90%
	automation <sup>3</sup>	22%	6%	6%
adaptive solar factor	F <sub>c</sub>	0 - 1		0 - G <sub>w</sub> * f <sub>g</sub>
	energy saving potential <sup>1</sup> (*)			
	heating <sup>4</sup>	63%	83%	-
	automation <sup>3</sup>	54%	83%	-
	overheating	99%	95%	97%
	automation <sup>3</sup>	56%	93%	74%
heat recovery	efficiency HR	60 %		
	energy saving potential <sup>1</sup>			
	heating	-	-	19%
	overheating	-	-	-
ATCS	energy saving potential <sup>1</sup> (*)			
	heating	61%	99%	65%
	automation <sup>3</sup>	55%	105%	-
	overheating	100%	100%	99%
	automation <sup>3</sup>	27%	14%	10%

- 1 Based on the generic calculations with the assumptions in Appendix C and Appendix D and on the reference dwelling of AgentschapNL.
- 2 The range of H<sub>tot</sub> for the 3RIC model is given in the amount of ventilation needed with the average values of insulation (R<sub>c</sub> = 5 m<sup>2</sup>K/W and U<sub>w</sub> = 1.6 W/m<sup>2</sup>K)
- 3 In this row the percentage represents the decrease in effectiveness against overheating if the adaptive measure is not automated
- 4 The energy saving potential of the solar factor for heating is due to the maximisation of the solar gain in the heating season (§ 5.3.4)
- 5 The total energy saving potential of **all discussed measures** compared to the reference situation with average insulation, average solar factor and constant ventilation [1.25/h]
- Not applicable
- ! Overheating escalates without additional measures in summer

TABLE 8.1 Summary of average energy saving potential of the Adaptive Thermal Comfort System based on the calculations of this thesis

---

### § 8.3 Main contributions to science and the building practice

---

This thesis shows how taking a step back from the detailed real world and regarding the complicated matter of the thermal heat balance opens up opportunities to develop new techniques and solutions for sustainably creating a comfortable thermal environment in a building. The research took apart the complicated heat balance and regarded all parameters separately and on a theoretical level without regarding existing techniques with their conflicting characteristics and limitations, which made it possible to have an open view on techniques possible to be developed (Table 8.2 to Table 8.6). Therefore the prospect after this thesis is a range of solutions and techniques to be developed which can enrich the vocabulary of techniques to design sustainable and flexible thermal comfort systems. The sub-domains the research contributes to are;

- Insight in the individual effects of the dynamic behaviour of different building characteristics on the thermal heat balance of a building.
- Insight in the effects of the dynamic behaviour of the weather and the occupant and its individual characteristics on the thermal comfort system.
- Knowledge of how to use existing techniques in a more adaptive way.
- Knowledge to develop more techniques for adaptive opportunities to create an Adaptive Thermal Comfort System.

---

### § 8.4 Scope, limitations and prospect of the research

---

The scope of the dissertation is to have an overview of all important aspects that play a role in the dynamic heat balance of a dwelling and to map the dynamic behaviour of the different aspects to be able to tune these aspects independently to work together and enhance each other aspects in creating an Adaptive Thermal Comfort System. The development of a specific technique is not the scope of this thesis but to highlight the possibilities to develop those new techniques and to show the possibilities to enhance existing techniques in their adaptability. Therefore a highly analytical approach has been chosen with a very high level of abstraction.

#### **Area researched**

All calculations and detailed analysis of this theses are done in the residential sector of the Netherlands with weather data of the Dutch climate (KNMI, 2012) and demographic and sociological information of the Dutch population (NIWI, 2002; CBS, 2009). For the simulations the reference dwelling of AgentschapNL (DGMR, 2006)

is used that represents a very common dwelling type which can be occupied by many different household types. However, the method of analysis and calculation can be applied to other climates and populations as well as building types.

### **Analytical versus detailed approach**

By researching on this analytical level without regarding existing techniques is an advantage as well as a limitation. Other aspects such as technical limitations, interactions and cost are not considered in this approach. Chapter 6 has made the connection to practice to relate the conclusions of chapter 5 to the technical information about the methods and solutions described in chapter 3. Simulations were made based on existing techniques in a very high level of detail. This shows that the concept of the Adaptive Thermal Comfort System can be realised with existing techniques provided that they can be controlled by the system and can be operated even when the occupants are not present. However, the new techniques to be developed cannot be simulated yet into such detail because much is still uncertain about their limitations and interactions with other materials and techniques. This is something to be researched in the course of the development of the new techniques.

### **Availability of information for simulation**

One of the major limitations of this research is the time step available in information. The 3R1C model processes all information per hour, however the TRNSYS model uses hourly weather information (hourly averages), the occupancy is regarded per 15 minutes and the simulation step in TRNSYS is 1 minute, to be able to simulate the short term heat accumulation more accurately. Especially the lack in weather behaviour within the hour makes it harder to define the best strategy for controlling the adaptive features, especially the solar gain, because there is no way of testing the frequency of switch for shorter than an hour. Moreover, there is no possibility to analyse the effect of short term weather swings, in which solar radiation is the most variable factor. In the future, more research should be performed on which interval of solar gain operation is most effective and still acceptable for the occupant, as the constant change of the adaptive solar gain can cause visual annoyance.

### **Control**

The lack of predictive properties of the control in both the lumped capacitance model as the TRNSYS simulations can result in a higher heating demand than would be required if the heat loss and solar radiation would be optimised for energy conservation. This effect is especially apparent with lower thermal mass as the temperature fluctuations are larger. It will be a challenge to develop a control system in the shape of a Adaptive Model Predictive Control (self-learning control) (§ 3.6.4) system to determine an appropriate predictive control that anticipates occupancy and weather changes.

### Heat up and cooling down time

The simulations assumed that the heating and cooling power is unlimited in power and speed. Sometimes the required speed for the described systems can be up to 6 °C temperature difference from one time step to another. This can be a serious limitation for the concept of adaptive heating, emphasizing the importance of heat-up speed for the system to be chosen. Therefore improvements for HVAC systems will involve heating up and cooling down speed as well as prediction in change of setpoint temperature to be able to anticipate future heating or cooling demand. Using adaptive measures and thermal mass can help stabilise the indoor temperature to decrease the required heat up and cool down speed.

### Adaptive space

Chapter 3 argues that much can be gained from adaptive space layout. A next step for research could be investigating the possibilities of adaptive space to support the Adaptive Thermal Comfort System in its flexibility. For this research controlling the parameters in this research in their ranges can be a guideline. More research projects could be set up, or workshops with professionals in architecture or an assignment in architectural education to explore as much possibilities as possible to get an elaborate overview of possibilities. It would be wise to involve architects and students in this process as it has significant influence on the architecture and because the creative minds can help invent new ideas and techniques.

### Implementation in prototypes

Simulation in TRNSYS is a good way of getting an idea of the effectiveness of the Adaptive Thermal Comfort System; however, to be able to fully understand the implications and effectiveness of the adaptive measures the only way is to make and test prototypes. This will be a logical step for the example concepts described in chapter 7 and in the future the newly developed concepts.

### User acceptance

For a new technology to be truly successful it needs to be accepted and embraced by the user. It will be crucial for implementation to test the interaction of the user with the new concepts to research possible sources of ambiguity or nuisance that can compromise the effectiveness of the Adaptive Thermal Comfort System.

---

## § 8.5 The Adaptive Thermal Comfort System for the Netherlands now and in the future

---

Figure 8.2 shows the combinations of the adaptive concepts developed in this thesis to improve the standard reference dwelling of AgentschapNL with the following elements which can be implemented in practice immediately;

- 1 Automated adaptive shading that can be used both as screens and awnings. At façades with high solar radiation this method is most effective.
- 2 At the façades with lower solar radiation it is beneficial to have thermal hatches which can increase the insulation especially during the night.
- 3 Automated adaptive vents above the windows for passive cooling by ventilation.
- 4 Indoor automated adaptive vents (above the doors) to increase (effectiveness of) the ventilation by extracting the air to the staircase.
- 5 Automated closable venturi shaped chimney and stack effect in the staircase to increase airflow by extraction of the air from the staircase to outdoor.

### North

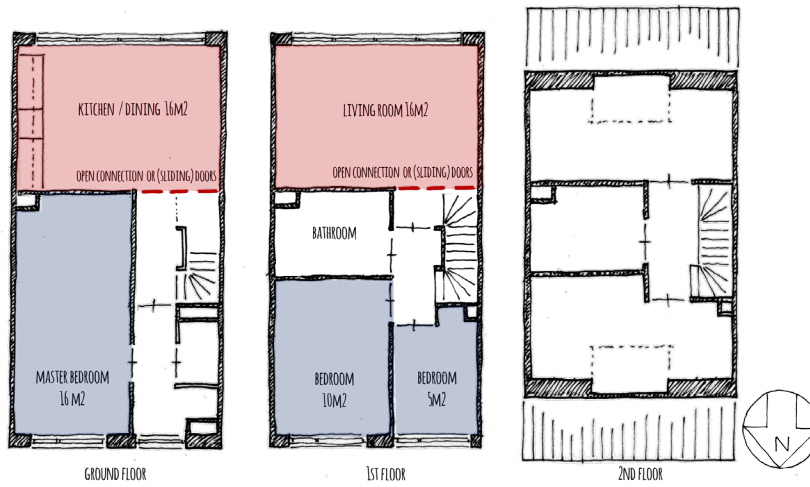
The night functions (bedrooms) are best oriented to the façade with the least solar radiation and can have small windows to increase thermal insulation. Low thermal mass can be beneficial in this orientation as the heating demand can be higher with higher thermal mass in case of a lack of solar radiation.

### South

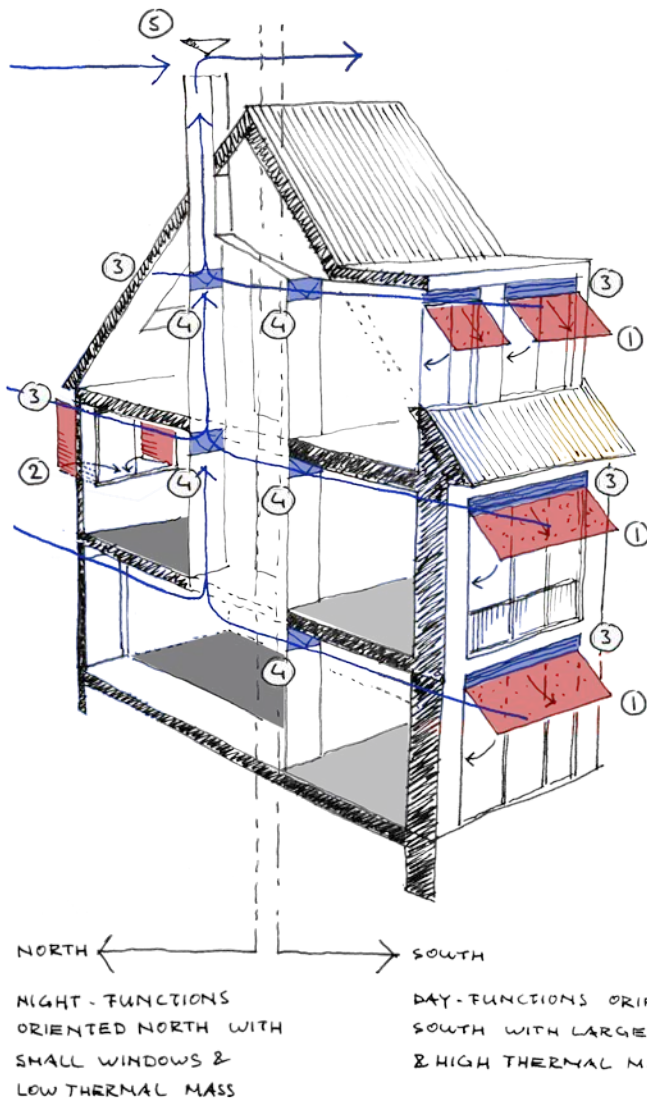
The day functions (e.g. living room and kitchen) are best oriented to the façade with the most solar radiation with large windows to increase the range in solar control. High thermal mass is preferable to optimally benefit from the solar radiation by balancing the temperature in time.

Figure 8.1 shows the alteration of the floor-plan of the standard reference dwelling by AgentschapNL with living room and kitchen oriented South and all bedrooms oriented North.





**FIGURE 8.1** Optimisation of the spatial layout of the reference dwelling to increase effectiveness of the adaptive solar factor



- ① ADAPTIVE SHADING USED AS SCREENS & AWNINGS
- ② THERMAL HATCHES ON NORTH FAÇADE
- ③ ADAPTIVE VENTS ABOVE WINDOWS FOR PASSIVE COOLING BY VENTILATION
- ④ INDOOR ADAPTIVE VENTS TO EXTRACT AIR TO STAIRCASE
- ⑤ CLOSEABLE VENTURI CHIMNEY AND STACK EFFECT INCREASE AIRFLOW BY EXTRACTION

FIGURE 8.2 Elements of an Adaptive Thermal Comfort System in a standard Dutch dwelling

## § 8.5.1 Improvements for the future

---

### Thermal comfort preferences in the Dutch residential sector

---



Although the scope of this thesis was to provide flexibility to account for as many weather situations and thermal preferences, increasing the knowledge of the comfort perception and preferences in the residential sector in the Netherlands can even be more beneficial for the fine tuning of Adaptive Thermal Comfort System. Showing the importance of flexibility and the effect of differences in thermal preferences could be an incentive to do more research on the thermal preferences in The Netherlands and especially to pinpoint the differences in thermal perception and the factors that cause these differences like gender, age, body mass index, perceived control, social position etcetera. Furthermore, the progressive insight in climate change will also contribute to the development of the Adaptive Thermal Comfort System. This thesis can be used as a framework to follow the changes and developments in respect to flexibility and adaptiveness for thermal comfort.

### Weather; prediction and control

---



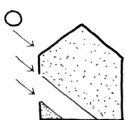
From the calculations of chapter 5 and 6 it becomes clear that for optimisation of control it would be beneficial to have predicted values for temperature and solar radiation budget. The temperature, nowadays can be predicted quite accurately; however the actual sunshine locally is hard to predict. Therefore, more research on the prediction of local solar radiation could help fine-tuning the control for solar gain.

### Development of new techniques

The focus of this thesis was on the research of possibilities to create an Adaptive Thermal Comfort System. The domains and categories that can be researched for improving currently available techniques and developing new techniques for the Adaptive Thermal Comfort System are shown in Table 8.2 to Table 8.6 which gives direction to the future development of these techniques by pinpointing the important fields for research and development.

### Solar gain

---



From the inventory of § 3.4.1 it becomes clear that the possibilities for adaptive solar factor are ample although there are some points of improvement (Table 8.2), which are described in § 7.5.1. These are mainly the increase of control possibilities for temperature and techniques to harvest more solar radiation by increasing the

surface area of incidence and improving the G-value of the transparent surfaces, making it possible to achieve solar factors of near 1 to harvest a maximum of solar heat; preferably without negatively influencing the insulation value of the separation construction.

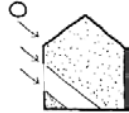
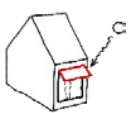
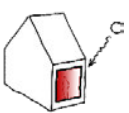

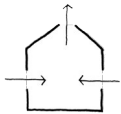
category		methods for adaptivity in practice			
irradiation		area of incidence	transparency	panels	collector
					
	improvements	control; vulnerability	control; cost	control; vulnerability	control
	concerns	auxiliary energy	auxiliary energy	auxiliary energy	auxiliary energy
opportunities		implementation of fluid replacement	implementation	implementation control	

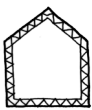
TABLE 8.2 Improvements, concerns and opportunities for adaptive solar factor.

### Natural ventilation



Because of the good opportunities for control of natural ventilation already applicable in practice the improvements are mainly to increase the existing possibilities in automation for the ventilation openings for temperature and reducing the cost and auxiliary energy (Table 8.3) as described in § 7.5.2.

### Insulation



As argued by § 3.4 and confirmed by the calculations in § 5.3.3 the possible range in heat loss factor by transmission is significantly less than for the heat loss factor by ventilation. Therefore, big steps should be taken in developing new techniques and concepts for adaptivity in insulation to be able to compete with the much easier variation in heat loss by ventilation. One option to drastically increase heat loss through the façade is to remove the façade construction all together; however, this would above all increase the heat loss by ventilation. In case there is adequate solar shading the option of adaptable insulation becomes more feasible because lower heat loss coefficients are needed. The possible improvements and new developments discussed in § 3.4.3 are summarised in Table 8.4 and is described in § 7.5.3.

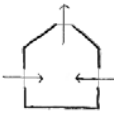
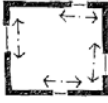

category		methods for adaptivity in practice			
natural ventilation		placement of the openings 	control of openings 		
	improvements		temperature control; cost		
	concerns	draft	auxiliary energy		
	opportunities	design			

TABLE 8.3 Improvements, concerns and opportunities for adaptive natural ventilation


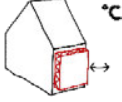
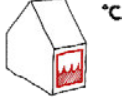


category		methods for adaptivity in practice			
insulation		insulative panels 	gas or fluid replacement 	DIM 	bi-directional thermal diode 
	improvements	control; vulnerability	control; cost		
	concerns	auxiliary energy	auxiliary energy	auxiliary energy	auxiliary energy
	opportunities	implementation	implementation of fluid replacement	to be developed	to be developed

TABLE 8.4 Development, improvements, concerns and opportunities for adaptive thermal insulation

### Thermal mass



In § 3.4.4 it is argued that it is very experimental and elaborate to make the thermal mass adaptive; though, P.J. Hoes (2014) has done a PhD research at the University of Technology in Eindhoven about Hybrid Adaptive Thermal Storage (HATS) and describes some experimental methods to do so. The most feasible solution is to change the mass of the storage medium for instance using fluid in the storage element which can be removed and replaced. A commonly used example of this technique is concrete core activation. Table 8.5 shows the opportunities for development of adaptive thermal mass with the concerns as described in § 3.4.4.


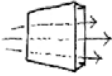
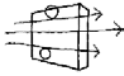


category		methods for adaptivity in practice			
thermal mass		storage capacity 	heat transfer by convection 	heat transfer by radiation 	heat transfer by conduction 
	improvements	control	control		
	concerns	auxiliary energy		auxiliary energy	auxiliary energy
	opportunities	extending application	extending application	to be developed	to be developed

TABLE 8.5 Development, improvements, concerns and opportunities for adaptive thermal mass

## HVAC



The main concerns for the HVAC systems in the Adaptive Thermal Comfort System that can be more important than for traditional dwellings is **controllability, locality and above all speed** of heating and cooling (Table 8.6), giving the opportunity to deliver thermal comfort only when and where needed at the level needed according to the definition of an Adaptive Thermal Comfort System.

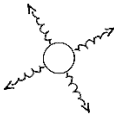
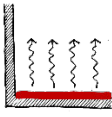
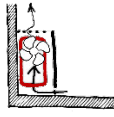

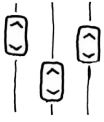
category		methods for adaptivity in practice			
thermal energy delivery		radiative 	convective 	air 	
	improvements	speed	speed	comfort	
	concerns			draft; pollution; noise	
	advantages	comfort	comfort	fast	

TABLE 8.6 Improvements, concerns and opportunities for heating and cooling delivery

## Control systems for the Adaptive Thermal Comfort System

---



As discussed in chapter 5 (§ 5.3.3 & § 5.3.4) it is a challenge to find the appropriate control for the adaptive heat loss factor and solar factor because (passively) cooling too much can cause an extra heating demand especially when there is little thermal storage capacity (low thermal mass). Therefore, additional research in predictive information gathering and control could greatly influence the effectiveness of Adaptive Thermal Comfort Systems. An Adaptive Model Predictive Control (self-learning control) (§ 3.6.4) mechanism could find the appropriate predictive algorithm per dwelling and household preferably combined with weather forecast.

# References

- Al-Nimr, M. A., K. R. Asfar and T. T. Abbadi (2009). "Design of a smart thermal insulation system." *Heat Transfer Engineering* 30(9): 762-769.
- Andersen, R. V. (2009). Occupant Behaviour with regard to Control of the Indoor Environment, Technical University of Denmark (DTU).
- ASHRAE, A. S. o. H., **Refrigerating and Air-Conditioning Engineers, Inc.** (2004). Thermal environmental conditions for human occupancy. 55. ASHRAE, ASHRAE.
- Baker, P. H. (2003). "The thermal performance of a prototype dynamically insulated wall." *Building Services Engineering Research and Technology* 24(1): 25-34.
- Bakker, E.-J., J. van der Garde, K. Jansen, R. Traversi and P. Wagener (2010). *Gaswarmtepompen; Efficiënt verwarmen en koelen met aardgas*. Groningen, GasTerra / Castel International Publishers.
- Bedford, T. (1936). *The Warmth Factor in Comfort at Work: A Physiological Study of Heating and Ventilation*, H. M. Stationery Office.
- Bergman, T. L. (2011). *Fundamentals of heat and mass transfer*. Hoboken, J. Wiley & Sons.
- Bilow, M. (2015). "BuckyLab." Retrieved 30-10-2015, 2015, from <http://www.buckylab.blogspot.nl/p/pictures.html>.
- Bordass, B. and A. Leaman (2007). Controls For End Users, BCIA.
- BouwhulpGroep (2007). Duurzaam Bouwen, Werken en Wonen Na 2015 - WP 0. *Duurzaam Bouwen, Werken en Wonen Na 2015*. Eindhoven, Bouwhulp Groep: 52.
- Brown, G. Z. and M. DeKay (2000). *Sun, Wind & Light: Architectural Design Strategies*, Wiley.
- Brundtland, G., M. Khalid, S. Agnelli, S. Al-Athel, B. Chidzero, L. Fadika, V. Hauff, I. Lang, M. Shijun, M. Morino de Botero, M. Singh, S. Okita and A. Others (1987). *Our Common Future ('Brundtland report')*, Oxford University Press, USA.
- Buster, C. (2010). "Variable Insulation (1/2)." 2015, from <http://rad.daniels.utoronto.ca/2010/11/variable-insulation-12/>.
- CBS (2009). Huishoudens; grootte, samenstelling, positie in het huishouden, 1 januari Centraal Bureau voor de Statistiek.
- CBS. (2014). "Energieverbruik." *Compendium voor de leefomgeving* Retrieved 31-10-2015, 2015, from <http://www.compendiumvoordeleefomgeving.nl/dossiers/nl0048-energieverbruik.html?i=6-40>.
- Chun, W., K. Chen and H. T. Kim (2002). "Performance study of a bi-directional thermodiode designed for energy-efficient buildings." *Journal of Solar Energy Engineering, Transactions of the ASME* 124(3): 291-299.
- Clina (2016). Capillary systems for environmentally friendly heating and cooling C. H.-u. K. GmbH.
- Crawley, D. B., J. W. Hand, M. Kummert and B. T. Griffith (2008). "Contrasting the capabilities of building energy performance simulation programs." *Building and Environment* 43(4): 661-673.
- Davis, F. D. (1989). "Perceived usefulness, perceived ease of use, and user acceptance of information technology." *MIS Quarterly: Management Information Systems* 13(3): 319-339.
- De Dear, R. J., G. Brager and D. Cooper (1997). Developing an adaptive model of the thermal comfort and preference. *Final Report ASHRAE RP-884*.
- DeFreitas, S. (2010). "Earth Techling." 2015, from <http://earthtechling.com/2010/08/nrel-installs-transpired-solar-collector/>.
- DEPW (2006). Modelprojectplan EOS; Duurzame Projectontwikkeling Gebaseerd op Duurzaam Bouwen, Renoveren en Wonen na 2015.
- DGMR, B. B. (2006). Brochure Referentiewoningen Nieuwbouw. VROM. Sittard, SenterNovem.
- Durant, B. (2015). "Variloft - Adaptive Thermal Insulation." Retrieved 08-09-2015, 2015, from <http://www.mide.com/technology/variloft.php>.
- EN-ISO (2005). Moderate thermal environments-determination of PMV & PPD indices as specifications of the conditions for thermal comfort. *International Standard ISO 7730. 7730*.
- EN-ISO (2007). Indoor environmental input parameters for design and assessment of energy performance of buildings addressing indoor air quality, thermal environment, lighting and acoustics.
- EN-ISO (2008). 13790 - Energy performance of buildings - Calculation of energy use for space heating and cooling. *ISO/TC 163/SC 2*. Geneva: 162.
- Everingham, L. (2014). 2015, from <http://www.everinghamrotatinghouse.com.au/EveringhamRotatingHouse.html>.



- Fanger, P. O. (1970). *Thermal comfort; analysis and applications in environmental engineering*. Copenhagen, Danish Technical Press.
- Fine, B. and E. Leopold (1993). *The World of Consumption*. London, New York.
- Fisk, W. J. W. W. J. (1998). "Sensor-based demand-controlled ventilation: A review." *Energy and Buildings* 29(1): 35-45.
- Gaggioli, R. A. (1962). "The concepts of thermodynamic friction, thermal available energy, chemical available energy and thermal energy." *Chemical Engineering Science* 17(7): 523-530.
- Givoni, B. (1981). *Man, climate and architecture*. London, Applied Science Publ.
- Glück, B. (1999). *Thermische Bauteilaktivierung*. Hamburg, RUD. OTTO MEYER-UMWELT-STIFTUNG.
- Granqvist, C. G., S. Green, E. K. Jonson, R. Marsal, G. A. Niklasson, A. Roos, Z. Topalian, A. Azens, P. Georén, G. Gustavsson, R. Karmhag, J. Smulko and L. B. Kish (2008). "Electrochromic foil-based devices: Optical transmittance and modulation range, effect of ultraviolet solar shading, and quality assessment by 1/f current noise." *Thin Solid Films* 516(17): 5921-5926.
- Harris, C. M. (2006). *Dictionary of architecture & construction*, McGraw-Hill.
- Hashemi, A. (2014). "Daylighting and solar shading performances of an innovative automated reflective louvre system." *Energy and Buildings* 82: 607-620.
- Healy, S. (2008). "Air-conditioning and the "homogenisation" of people and built environments." *Building Research & Information* 36(4): 312 - 322.
- Hoes, P. (2014). Computational performance prediction of the potential of hybrid adaptable thermal storage concepts for lightweight low-energy houses. *Architecture, Building and Planning*. Eindhoven, Technical University of Eindhoven. PhD: XII, 150p.
- Hoffmann, S., E. S. Lee, A. McNeil, L. Fernandes, D. Vidanovic and A. Thanachareonkit (2016). "Balancing daylight, glare, and energy-efficiency goals: An evaluation of exterior coplanar shading systems using complex fenestration modeling tools." *Energy and Buildings* 112: 279-298.
- Höppe, P. (1999). "The physiological equivalent temperature - A universal index for the biometeorological assessment of the thermal environment." *International Journal of Biometeorology* 43(2): 71-75.
- Horn, R., R. Neusinger, M. Meister, J. Hetfleisch, R. Caps and J. Fricke (2000). "Switchable thermal insulation: Results of computer simulations for optimisation in building applications." *High Temperatures - High Pressures* 32(6): 669-675.
- Humphreys, M. A. and J. F. Nicol (1998). *Understanding the adaptive approach to thermal comfort*. ASHRAE Transactions, San Francisco, CA, USA, ASHRAE.
- IEA (2012). *World Energy Outlook 2012*. Paris
- IPCC (2014). *Climate Change 2014: Synthesis Report*. Contribution of Working Groups I, II, III to the Fifth Assessment Report of the Intergovernmental Panel on Climate Change, Core Writing Team. R. K. Pachauri and L. A. Meyer. Geneva, IPCC.
- ISSO\_74 (2004). *Thermische behaaglijkheid - Eisen voor de binnentemperatuur in gebouwen*. Rotterdam, Stichting ISSO
- Jansen, S. C. (2013). Exergy in the built environment. *Climate Design and Sustainability*. Delft, Delft University of Technology. PhD.
- Jelle, B. P., A. Gustavsen and R. Baetens (2010). "The path to the high performance thermal building insulation materials and solutions of tomorrow." *Journal of Building Physics* 34(2): 99-123.
- Karjalainen, S. (2007). "Gender differences in thermal comfort and use of thermostats in everyday thermal environments." *Building and Environment* 42(4): 1594-1603.
- Kennelly, A. E. (1899). "Equivalence of triangles and three-pointed stars in conducting networks." *Electrical World and Engineer* 34: pp. 413-414.
- Kingma, B. R. M., A. J. H. Frijns, W. H. M. Saris, A. A. van Steenhoven and W. D. van Marken Lichtenbelt (2011). "Increased systolic blood pressure after mild cold and rewarming: Relation to cold-induced thermogenesis and age." *Acta Physiologica* 203(4): 419-427.
- KNMI (2012). *Klimatologie; Informatie over Het Weer in het Verleden* Dutch Meteorological Institute.
- KNMI (2014). *Klimaatscenario's voor Nederland*. Zwolle.
- Llodes, A., G. Garcia, J. Gazquez and D. J. Milliron (2013). "Tunable near-infrared and visible-light transmittance in nanocrystal-in-glass composites." *Nature* 500(7462): 323-326.
- Louise, F. P. (2000). A material with variable insulation properties, Google Patents.
- Lysen, E. H. (1996). *The Trias Energica; Solar Energy Strategies for Developing Countries*. *Eurosun Conference*. Freiburg, Germany.
- Matzarakis, A., F. Rutz and H. Mayer (2010). "Modelling radiation fluxes in simple and complex environments: Basics of the RayMan model." *International Journal of Biometeorology* 54(2): 131-139.

- McCartney, K. J. and J. F. Nicol (2002). "Developing an adaptive control algorithm for Europe." *Energy and Buildings* 34(6): 623-635.
- Meek, C. and M. Brennan (2011). *Automated and manual solar shading and glare control: A design framework for meeting occupant comfort and realized energy performance*. 40th ASES National Solar Conference 2011, SOLAR 2011.
- Mendell, M. J., Q. Lei-Gomez, A. G. Mirer, O. Seppänen and G. Brunner (2008). "Risk factors in heating, ventilating, and air-conditioning systems for occupant symptoms in US office buildings: The US EPA BASE study." *Indoor Air* 18(4): 301-316.
- Mendell, M. J. and A. G. Mirer (2009). "Indoor thermal factors and symptoms in office workers: findings from the US EPA BASE study." *Indoor Air* 19(4): 291-302.
- Mendell, M. J. and A. H. Smith (1990). "Consistent pattern of elevated symptoms in air-conditioned office buildings: A reanalysis of epidemiologic studies." *American Journal of Public Health* 80(10): 1193-1199.
- Menk. (2015). "Rolluiken." from <http://www.menkrolluiken.nl/particulier/rolluiken/>.
- Merghani, A. (2004). *Environmental Diversity in Architecture*. K. Steemers and M. A. Steane: 195-213.
- Merzkirch, A., S. Maas, F. Scholzen and D. Waldmann (2016). "Field tests of centralized and decentralized ventilation units in residential buildings - Specific fan power, heat recovery efficiency, shortcuts and volume flow unbalances." *Energy and Buildings* 116: 373-383.
- NEN\_1087 (2007). *Ventilatie van gebouwen - Bepalingsmethoden voor nieuwbouw*. Delft, ICS. 1087.
- NEN\_5060 (2008). *NEN\_5060+A2.xlsx+B2.xlsx+C2.xlsx; Hygrothermal performance of buildings - Climatic reference data*. Delft, NNI.
- Nicol, F., M. Humphreys and S. Roaf (2012). *Adaptive thermal comfort: principles and practice*, Routledge.
- Nicol, J. F. and M. A. Humphreys (2002). "Adaptive thermal comfort and sustainable thermal standards for buildings." *Energy and Buildings* 34(6): 563-572.
- NIWI (2002). *Tijdsbestedingsonderzoek 2000 TBO'2000*, Netherlands Institute for Scientific Information Services.
- Olgay, V. and A. Olgay (1963). *Design with climate; bioclimatic approach to architectural regionalism*. Princeton, Princeton University Press.
- Oxford. (2012). "Oxford Dictionaries." Retrieved 03-01-2013, 2013, from <http://oxforddictionaries.com/definition/english/comfort?q=comfort>.
- Peeters, L., R. d. Dear, J. Hensen and W. D'Haeseleer (2009). "Thermal comfort in residential buildings: Comfort values and scales for building energy simulation." *Applied Energy* 86(5): 772-780.
- RadiantCoolingCorporation. (2013). 2015, from <http://www.radiantcooling.org/faq.html>.
- Renson (2014). *Healthy School Concept*.
- Rietveld, S. a. G. T. (1888-1964). "Gerrit Thomas Rietveld 1888-1964." from <http://www.gerrit-rietveld.nl/>.
- Roberts, C. C. J., Ph.D., P.E. (2014). "Technical Notebook: The Venturi Effect." Retrieved 15-03-2016, 2016, from <http://www.propertycasualty360.com/2014/02/19/technical-notebook-the-venturi-effect?slreturn=1458037953>.
- Roggema, R., A. van den Dobbelsteen, S. Stremke and W. Mallon (2011). *Spatial-Energy framework aiming at breakthroughs brings goals beyond policy objectives within reach*. *Climate Change Adaptation: Ecology, Mitigation and Management*: 127-150.
- Rylewski, E. (2005). *Device for heat transfer between two walls*, Google Patents.
- Schellen, L., M. G. L. C. Loomans, M. H. de Wit, B. W. Olesen and W. D. v. M. Lichtenbelt (2012). "The influence of local effects on thermal sensation under non-uniform environmental conditions — Gender differences in thermophysiology, thermal comfort and productivity during convective and radiant cooling." *Physiology & Behavior* 107(2): 252-261.
- Schellen, L., W. D. van Marken Lichtenbelt, M. G. L. C. Loomans, J. Toftum and M. H. de Wit (2010). "Differences between young adults and elderly in thermal comfort, productivity, and thermal physiology in response to a moderate temperature drift and a steady-state condition." *Indoor Air* 20(4): 273-283.
- Seppänen, O. and W. J. Fisk (2002). "Association of ventilation system type with SBS symptoms in office workers." *Indoor Air* 12(2): 98-112.
- Shove, E. (2004). "Social, architectural and environmental convergence." *Environmental Diversity in Architecture*: 19-30.
- Solar-Energy-Laboratory (2010). *TRNSYS 17 Standard Component Library Overview*. Madison, Wisconsin.
- Stremke, S., A. Van Den Dobbelsteen and J. Koh (2011). "Exergy landscapes: Exploration of second-law thinking towards sustainable landscape design." *International Journal of Exergy* 8(2): 148-174.
- Szargut, J. (2005). *Exergy method: technical and ecological applications*, WIT.
- Ubbelohde, M. S., G. M. Loisos and R. McBride (2003). *Comfort Reports*, California Energy Commission.

- Van Den Dobbelsesteen, A. (2008).** *Towards closed cycles - New strategy steps inspired by the Cradle to Cradle approach.* PLEA 2008 - Towards Zero Energy Building: 25th PLEA International Conference on Passive and Low Energy Architecture, Conference Proceedings.
- Van Den Dobbelsesteen, A., S. Jansen, A. L. Vernay and L. Gommans (2007).** Building within an energetic context - Low-exergy design based on local energy potentials and excess or shortage of energy. Sun, Wind and Architecture - The Proceedings of the 24th International Conference on Passive and Low Energy Architecture, PLEA 2007.
- Van Gool, W. (1997).** Energy Policy: Fairy Tales and Facts. *Innovation and Technology — Strategies and Policies.* O. D. Soares, A. M. da Cruz, G. C. Pereira, I. R. T. Soares and A. P. S. Reis, Springer Netherlands: 93-105.
- VROM, m. v. (2010).** Energiegedrag in de woning; Aanknopingspunten voor de vermindering van het energiegebruik in de woningvoorraad. Den Haag.
- WebFinance. (2016).** "Dictionary of construction." Retrieved 15-03-2016, 2016, from <http://www.dictionary-ofconstruction.com>
- Wienold, J. (2007).** *Dynamic simulation of blind control strategies for visual comfort and energy balance analysis.* IBPSA 2007 - International Building Performance Simulation Association 2007.
- Wisconsin, U. o. (2012).** TRNSYS. Wisconsin.
- Yang, Z. (2012).** Method to assess the performance of domestic ventilation systems considering the influence of uncertainties. Building Technology. Delft, Delft University of Technology. **PhD.**
- Yeang, K. (1999).** *The Skyscraper Bioclimatically Considered.* London, John Wiley & Sons.
- ZED-factory. (2002).** "BedZED." Retrieved 15-03-2016, 2016, from <http://www.zedfactory.com/zed/?q=node/102>

## Appendix A Occupancy profiles

The occupancy profiles used in this thesis are compiled with weekly schedules with information per 15 minutes, like the Time Use Survey (NIWI, 2002) used to create them. There are 6 household types which have an individual schedule. Based on the information of the Time Use Survey the presence (in which functional zone) and activity level of the separate household members are identified and combined per household to occupancy profiles per room or function zone. The possible household members which are shown in Table A.1 and the compositions of the households of which the occupancy profiles are compiled are shown in Table A.2 are based on the demographic studies (CBS, 2009). Table A.3 shows the functional zones that are described and information contained by the occupancy profiles. Finally, Table A.4 to Table A.17 show the occupancy profiles for a whole week per 15 minutes for the 6 household compositions.

CODE	DESCRIPTION
mp	main provider or main occupant
pmp	partner of the main provider or secondary occupant
c1	oldest child
c2	youngest child

TABLE APP.A.1 Household members of the used profiles

CODE	COMPOSITION	MP	PMP	C1	C2
1_st	1 person household, student	out	-	-	-
1_soc	1 person household, with many visiting people	out	-	-	-
2_w	2 person household, both with job outside the home	out	out	-	-
2_h	2 person household, at least one partner working at home	out/in	out/in	-	-
4_sc	4 person household, both partners job out, 2 schoolchildren	out	out	age>5	age>5
4_sm	4 person household, two children under the age of 5	out	in	age<5	age<5
out	job, study or school outside the home				
in	working or studying from home or (caring for) small children				
age>5	child going to school during the day				
age<5	child staying at home during the day				

TABLE APP.A.2 Household compositions of the occupancy profiles compiled in this thesis

NO.	ROOM	ACA TYPE	PRESENCE [N]	ACTIVITY	INTERNAL GAIN
01	living room	living room	0-10	0-4	light/tv/computer
02	kitchen	living room	0-10	0-4	light/cooker
11	master bedroom	bedroom	0-2	0-1	light
12	bedroom 2	bedroom	0-1	0-2	light/computer
13	bedroom 3	bedroom	0-1	0-2	light/computer
14	bathroom	-	0-2	0-2	light/shower

TABLE APP.A.3 Household compositions of the occupancy profiles compiled in this thesis

































## Appendix B Description and equations of the lumped capacitance models

---

### Description of the 5RC1 model of EN ISO 13790 (2008)

---

The description given in the norm is:

*'Principle:*

*The model is a simplification of a dynamic simulation, with the following intention:*

- *same level of transparency, reproducibility and robustness as the monthly method.*
- *clearly specified limited set of equations enabling traceability of the calculation process;*
- *reduction of the input data as much as possible;*
- *unambiguous calculation procedures;*
- *with main advantage over the monthly method that the hourly time intervals enable direct input of hourly patterns.*

*In addition, the model*

- *makes new development easy by using directly the physical behaviour to be implemented,*
- *keeps an adequate level of accuracy, especially for room-conditioned buildings where the thermal dynamic of the room behaviour is of high impact.*

*The model used is based on an equivalent resistance-capacitance (R-C) model. It uses an hourly time step and all building and system input data can be modified each hour using schedule tables (in general, on a weekly basis).*

*The model makes a distinction between the internal air temperature and mean temperature of the internal (building zone facing) surfaces (mean radiant temperature). This enables its use in principle for thermal comfort checks and increases the accuracy of taking into account the radiative and convective parts of solar, lighting, and internal heat gains, although the results of the simple method at hourly level are not reliable. The calculation method is based on simplifications of the heat transfer between the internal and external environment...'*

*'The heating and/or cooling need is found by calculating for each hour the need for heating or cooling power,  $\Phi_{HC,nd}$  (positive for heating and negative for cooling), that needs to be supplied to, or extracted from, the internal air node,  $\theta_{air}$ , to maintain a certain minimum or maximum set-point temperature. The set-point temperature is a weighted mean of air and mean radiant temperature. The default weighting factor is 0,5 for each.*

*Heat transfer by ventilation,  $H_{ve}$ , is connected directly to the air temperature node,  $\theta_{air}$ , and to the node representing the supply air temperature,  $\theta_{sup}$ . Heat transfer by transmission is split into the window part,  $H_{tr,w}$  taken as having zero thermal mass, and the remainder,  $H_{tr,op}$ , containing the thermal mass which in turn is split into two parts:  $H_{tr,em}$  and  $H_{tr,ms}$ . Solar and internal heat gains are distributed over the air node,  $\theta_{air}$ , the central node,  $\theta_s$  (a mix of  $\theta_{air}$  and mean radiant temperature  $\theta_{r,mn}$ ) and the node representing the mass of the building zone,  $\theta_m$ . The thermal mass is represented by a single thermal capacity,  $C_m$ , located between  $H_{tr,ms}$  and  $H_{tr,em}$ . A coupling conductance is defined between the internal air node and the central node. The heat flow rate due to internal heat sources,  $\Phi_{int}$ , and the heat flow rate due to solar heat sources,  $\Phi_{sol}$ , are split amongst the three nodes.'*

---

*Equations for calculation of the node temperatures and thermal energy with the 5RIC model of EN ISO 13790 (2008)*

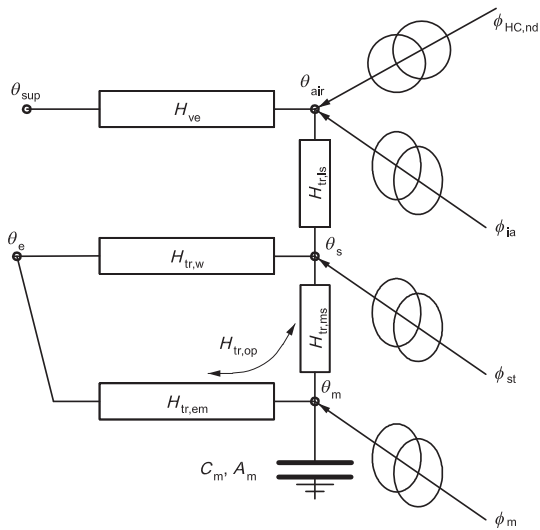
---

*(pdf EN-ISO 13790 2008)*

**Annex C**  
(normative)

**Full set of equations for simple hourly method**

**C.1 Introduction**



**Figure C.1 — RC network heat flows**

The general scheme and equations are presented in 7.2.2.

This annex describes the additional calculation procedure for calculating:

- the internal and solar heat gains to the internal nodes (see Clause C.2);
- the temperature nodes when  $\phi_{HC,nd}$  is known (see Clause C.3);
- the actual heating or cooling need,  $\phi_{HC,nd,ac}$ , and the corresponding internal temperatures taking into account the possibility of imposing a maximum available heating or cooling power (C.4).

### C.2 Calculation of heat flows from internal and solar heat sources

The heat flow rates from internal and solar heat sources  $\phi_{\text{int}}$  and  $\phi_{\text{sol}}$ , expressed in watts, are split between the air node,  $\theta_{\text{air}}$ , and the internal nodes,  $\theta_{\text{int}}, \theta_{\text{m}}$ , as follows:

$$\phi_{\text{ia}} = 0,5 \phi_{\text{int}} \quad (\text{C.1})$$

$$\phi_{\text{m}} = \frac{A_{\text{m}}}{A_{\text{t}}} (0,5 \phi_{\text{int}} + \phi_{\text{sol}}) \quad (\text{C.2})$$

$$\phi_{\text{st}} = \left( 1 - \frac{A_{\text{m}}}{A_{\text{t}}} - \frac{H_{\text{tr,w}}}{9,1 A_{\text{t}}} \right) (0,5 \phi_{\text{int}} + \phi_{\text{sol}}) \quad (\text{C.3})$$

The heat flow rates from internal and solar heat sources  $\phi_{\text{int}}$  and  $\phi_{\text{sol}}$ , expressed in watts, are derived by dividing  $Q_{\text{int}}$  and  $Q_{\text{sol}}$ , expressed in magajoules, by 0,036.

The heat flow rate from internal heat sources  $\phi_{\text{int}}$  is obtained from 10.2 and the heat flow rate from solar heat sources  $\phi_{\text{sol}}$  is obtained from 11.2.

$A_{\text{t}}$  is obtained from 7.2.2.2 and  $A_{\text{m}}$  is obtained from 12.2.2.

### C.3 Determination of the air and operative temperatures for a given value of $\Phi_{\text{HC,nd}}$

The solution model is based on a Crank-Nicholson scheme considering a time step of one hour. The temperatures are the average over one hour except for  $\theta_{\text{m},t}$  and  $\theta_{\text{m},t-1}$  which are instantaneous values at time  $t$  and  $t - 1$ .

For a given time step,  $\theta_{\text{m},t}$ , expressed in degrees centigrade, is calculated at the end of the time step from the previous value  $\theta_{\text{m},t-1}$  by:

$$\theta_{\text{m},t} = \{ \theta_{\text{m},t-1} [(C_{\text{m}}/3 \ 600) - 0,5 \times (H_{\text{tr},3} + H_{\text{tr,em}})] + \Phi_{\text{mto}} \} / [(C_{\text{m}}/3 \ 600) + 0,5 \times (H_{\text{tr},3} + H_{\text{tr,em}})] \quad (\text{C.4})$$

with

$$\Phi_{\text{mto}} = \Phi_{\text{m}} + H_{\text{tr,em}} \theta_{\text{e}} + H_{\text{tr},3} \{ \phi_{\text{st}} + H_{\text{tr,w}} \theta_{\text{e}} + H_{\text{tr},1} [(\phi_{\text{ia}} + \Phi_{\text{HC,nd}})/H_{\text{ve}}] + \theta_{\text{sup}} \} / H_{\text{tr},2} \quad (\text{C.5})$$

$$H_{\text{tr},1} = \frac{1}{1/H_{\text{ve}} + 1/H_{\text{tr,is}}} \quad (\text{C.6})$$

$$H_{\text{tr},2} = H_{\text{tr},1} + H_{\text{tr,w}} \quad (\text{C.7})$$

$$H_{\text{tr},3} = \frac{1}{1/H_{\text{tr},2} + 1/H_{\text{tr,ms}}} \quad (\text{C.8})$$

$H_{\text{tr,em}}, H_{\text{tr,w}}, H_{\text{ve}}$ , expressed in watts per kelvin, and  $\theta_{\text{e}}, \theta_{\text{sup}}$ , expressed in degrees centigrade, are obtained from Clauses 8 and 9.

$C_{\text{m}}$ , expressed in joules per kelvin, is obtained from Clause 12.

For the considered time step, the average values of nodes temperatures are given by:

$$\theta_{\text{m}} = (\theta_{\text{m},t} + \theta_{\text{m},t-1})/2 \quad (\text{C.9})$$

$$\theta_{\text{s}} = \{ H_{\text{tr,ms}} \theta_{\text{m}} + \phi_{\text{st}} + H_{\text{tr,w}} \theta_{\text{e}} + H_{\text{tr},1} [ \theta_{\text{sup}} + (\phi_{\text{ia}} + \Phi_{\text{HC,nd}})/H_{\text{ve}} ] \} / (H_{\text{tr,ms}} + H_{\text{tr,w}} + H_{\text{tr},1}) \quad (\text{C.10})$$

$H_{tr,ms}$ , expressed in watts per kelvin, is obtained from 7.2.2.1.

$$\theta_{air} = (H_{tr,is} \theta_s + H_{ve} \theta_{sup} + \Phi_{ia} + \Phi_{HC,nd}) / (H_{tr,is} + H_{ve}) \tag{C.11}$$

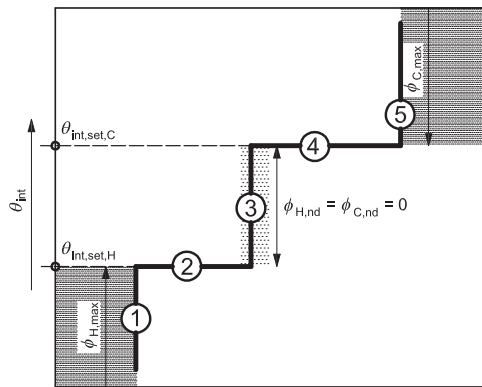
and the operative temperature by

$$\theta_{op} = 0,3 \times \theta_{air} + 0,7 \times \theta_s \tag{C.12}$$

NOTE This is an approximation. The operative temperature is a weighted average of the air and mean radiant temperatures, weighted by the internal surface convective (3/8) and radiative coefficients (5/8). The value of  $\theta_s$  is a mix between air and mean radiant temperature.

## C.4 Calculation of internal temperature and required heating or cooling power

### C.4.1 General description



**Key**

Symbols: see text

1-5 building zone temperature behaviour, referring to the five situations described in the text

**Figure C.2 — Building zone temperature behaviour versus system behaviour**

For each hour, the RC network enables the calculation of the internal temperature for any amount of heating or cooling need,  $\Phi_{HC,nd}$ . The resolution scheme is such that the internal temperature is determined as a linear function of  $\Phi_{HC,nd}$ .

For a given hour, the building zone behaviour line is known by applying equations described in Clause C.3 for two values of  $\Phi_{HC,nd}$ .



## ISO 13790:2008(E)

The heating and cooling power delivered to the building zone can be represented on the same graph by the  $\theta_{\text{int,H,set}}$  and  $\theta_{\text{int,C,set}}$  temperatures and the maximum available heating and cooling power (which can vary for each hour<sup>2</sup>).

The resulting indoor temperature and heating and cooling needs are derived from the intersection of the two curves.

Five situations can occur:

- 1) The building zone requires heating and the heating power is not sufficient to obtain the set-point. The heating need is limited to the maximum available heating power and the calculated internal temperature is lower than the heating set-point  $\theta_{\text{int,H,set}}$ . This usually happens in the boost period.
- 2) The building zone requires heating and the heating power is sufficient. The internal temperature is equal to  $\theta_{\text{int,H,set}}$  and the calculated heating need is lower than its maximum value.
- 3) The building zone requires neither heating nor cooling (free floating conditions). No heating or cooling is applied, and the internal temperature is calculated.
- 4) The building zone requires cooling and the cooling power is sufficient. The internal temperature is equal to  $\theta_{\text{int,C,set}}$  and the calculated cooling need is lower than its maximum value.
- 5) The building zone requires cooling and the cooling power is not sufficient. The cooling need is limited to the maximum available cooling power. The calculated internal temperature is higher than the cooling set-point  $\theta_{\text{int,C,set}}$ .

### C.4.2 Calculation procedure

The procedure in this subclause is based on the air temperature,  $\theta_{\text{air}}$ , as set-point temperature. To use the operative temperature as set-point, the operative temperature shall be calculated (see Equation C.11) and the procedure given in this subclause shall be adapted accordingly.

The procedure calculates the actual internal temperature,  $\theta_{\text{air,ac}}$ , and the actual heating or cooling power,  $\Phi_{\text{HC,nd,ac}}$ . In all cases, the value of  $\theta_{\text{m,t}}$  [see Equation (C.8)] is also calculated and stored, as it is used for the following time step.

Step 1: Check if cooling or heating is needed (case 3 of Figure C.2).

Take  $\Phi_{\text{HC,nd}} = 0$  and apply Equations (C.7) to (C.11).

Name the resulting  $\theta_{\text{air}}$  as  $\theta_{\text{air,0}}$  ( $\theta_{\text{air,0}}$  is the air temperature in free floating conditions).

If  $\theta_{\text{int,H,set}} \leq \theta_{\text{air,0}} \leq \theta_{\text{int,C,set}}$ , no heating or cooling is required so that  $\Phi_{\text{HC,nd,ac}} = 0$  and  $\theta_{\text{air,ac}} = \theta_{\text{air,0}}$ , and no further calculations are needed.

If not: apply step 2.

Step 2: Choose the set-point and calculate the heating or cooling need.

If  $\theta_{\text{air,0}} > \theta_{\text{int,C,set}}$ , take  $\theta_{\text{air,set}} = \theta_{\text{int,C,set}}$

If  $\theta_{\text{air,0}} < \theta_{\text{int,H,set}}$ , take  $\theta_{\text{air,set}} = \theta_{\text{int,H,set}}$

NOTE 1 Conditions might have to be added to separate the set-pos (hysteresis), to prevent oscillations.

2) The scheme could be modified to take into account a maximum heating or cooling power depending on internal temperature.

Apply Equations (C.7) to (C.11) taking  $\Phi_{\text{HC,nd}} = \Phi_{\text{HC,nd}10}$  with  $\Phi_{\text{HC,nd}10} = 10 A_f$ .

$A_f$  is obtained from 6.3.2.

Name the resulting  $\theta_{\text{air}}$  as  $\theta_{\text{air}10}$  ( $\theta_{\text{air}10}$  is the air temperature obtained for a heating power of 10 W/m<sup>2</sup>).

Calculate  $\Phi_{\text{HC,nd,un}}$  (unrestricted heating or cooling need to reach the required set-point temperature;  $\Phi_{\text{HC,nd,un}}$  is positive for heating and negative for cooling).

$$\Phi_{\text{HC,nd,un}} = \Phi_{\text{HC,nd}10} (\theta_{\text{air,set}} - \theta_{\text{air},0}) / (\theta_{\text{air},10} - \theta_{\text{air},0}) \quad (\text{C.13})$$

Step 3: Check if the available cooling or heating power is sufficient (case 2 or case 4 of Figure C.2).

If  $\Phi_{\text{HC,nd,un}}$  is between  $\Phi_{\text{H,max}}$  (maximum heating power) and  $\Phi_{\text{C,max}}$  (maximum cooling power):

$$\Phi_{\text{HC,nd,ac}} = \Phi_{\text{HC,nd,un}}$$

$$\theta_{\text{air,ac}} = \theta_{\text{air,set}}$$

and the calculation is completed.

If not: apply step 4.

Step 4: Calculate the internal temperature (case 1 or case 5 of Figure C.2).

If  $\Phi_{\text{HC,nd,un}}$  is positive, take  $\Phi_{\text{HC,nd,ac}} = \Phi_{\text{H,max}}$ . If  $\Phi_{\text{HC,nd,un}}$  is negative, take  $\Phi_{\text{HC,nd,ac}} = \Phi_{\text{C,max}}$ .

Calculate  $\theta_{\text{air,ac}}$  by using Equations (C.5) to (C.9).

NOTE 2 In this case, the set-point temperature is not attained.

The energy need for heating or cooling for a given hour,  $Q_{\text{HC,nd}t}$ , expressed in megajoules, is equal to  $0,036 \times \Phi_{\text{HC,nd,ac}}$ . The value is positive in the case of heating need and negative in the case of cooling need.

## Deduction of equations from the 5R1C model of EN ISO 13790 (2008) to the 4R1C and 3R1C model

The 5R1C model can be used for the purpose of assessing single solutions of adaptive opportunities as insulation for opaque building construction, ventilation or solar shading. However, for assessing the whole mechanism together the multitude of variables can blur the results. Therefore simplifications of the model are researched in the following section.

Two simplifications of the 5R1C model are regarded, in which the heat transfer coefficients are simplified to 4 or 3 resistances;

- 4R1C (simplified 5R1C)
- 3R1C (simplified 5R1C)

### From 5R1C to 4R1C

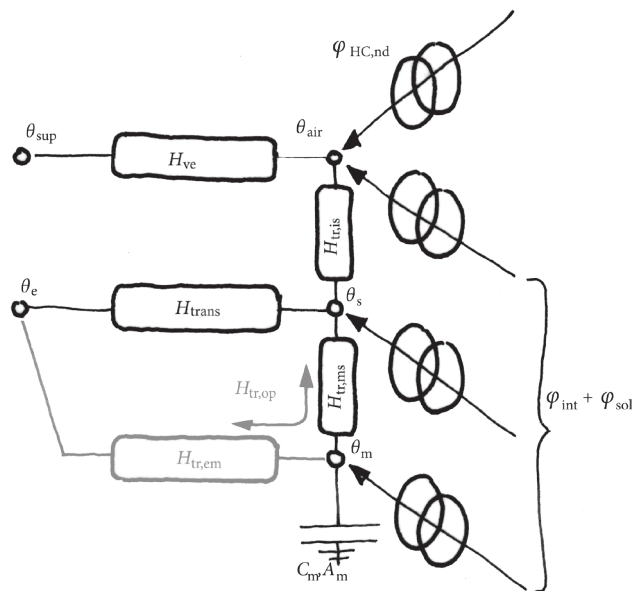


FIGURE APP.B.6 Representation of the simplified 4R1C model

This model is based on the previous 5R1C model, but bundles the total of heat transfer coefficients for transmission (opaque and transparent) to one resistance  $H_{tr}$  ( $H_{tr,op} + H_{tr,w}$ ). The model uses the same equations as the 5R1C model and uses 0 as the value for the  $H_{tr,em}$  (heat transfer coefficient for emission [W/K]) and replaces  $H_{tr,w}$  by  $H_{tr}$ . Figure App.B.6 shows the electrical scheme of the 4R1C model. The term  $H_{tr,em} * \theta_e$  in the original equation C.5 of the 5R1C model disappears because  $H_{tr,em} = 0$

### Changed equations

$$\Phi_{st} = (1 - A_m / A_t - H_{trans} / 9.1A_t) (0.5 \Phi_{int} + \Phi_{sol})$$

**EQUATION APP.B.1** Equation C.3 of EN ISO 13790 (2008) with  $H_{trans} = H_{tr,op} + H_{tr,w}$

$$\theta_{m,t} = (\theta_{m,t-1} * ((C_m / 3600) - 0.5 * H_{tr,3}) + \Phi_{m,tot}) / ((C_m / 3600) + 0.5 * H_{tr,3})$$

**EQUATION APP.B.2** Equation C.4 of EN ISO 13790 (2008) with  $H_{tr,em} = 0$

$$\Phi_{m,tot} = \Phi_m + H_{tr,3} (\Phi_{st} + H_{trans} * \theta_e + H_{tr,1} (((\Phi_{ia} + \Phi_{HC,nd}) / H_{ve}) + \theta_{sup})) / H_{tr,2}$$

**EQUATION APP.B.3** Equation C.5 of EN ISO 13790 (2008) with  $H_{trans} = H_{tr,op} + H_{tr,w}$  and  $H_{tr,em} = 0$

$$H_{tr,2} = H_{tr,1} + H_{trans}$$

**EQUATION APP.B.4** Equation C.7 of EN ISO 13790 (2008) with  $H_{trans} = H_{tr,op} + H_{tr,w}$  and  $H_{tr,em} = 0$

$$\theta_s = (H_{tr,ms} * \theta_m + \Phi_{st} + H_{trans} * \theta_e + H_{tr,1} (\theta_{sup} + (\Phi_{ia} + \Phi_{HC,nd}) / H_{ve})) / (H_{tr,ms} + H_{trans} + H_{tr,1})$$

**EQUATION APP.B.5** Equation C.10 of EN ISO 13790 (2008) with  $H_{trans} = H_{tr,op} + H_{tr,w}$  and  $H_{tr,em} = 0$

## From 4R1C to 3R1C

### 3R1C

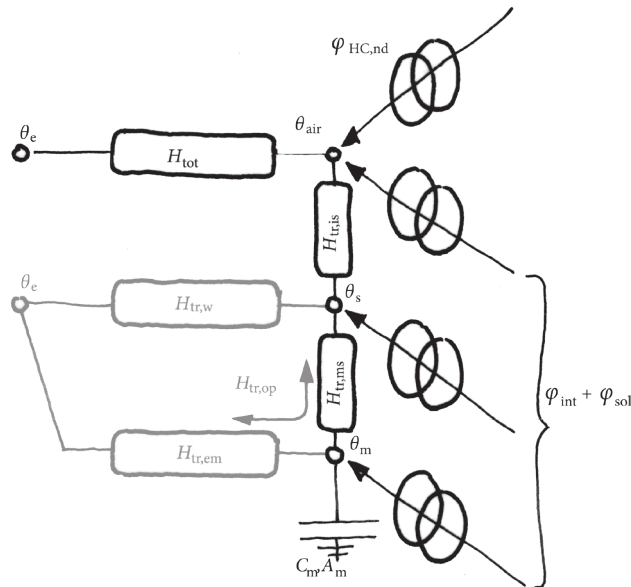


FIGURE APP.B.7 Representation of the simplified 3R1C model.

This model is based on the previous 4R1C model, but bundles all heat transfer coefficients to outdoor air in one heat transfer coefficient  $H_{tot}$  ( $H_{tr} + H_{ve}$ ) to be able to research the effect of a flexible heat transfer coefficient without determining what the technique will be. The same equations are used as in the original 5R1C model and uses 0 as the value for  $H_{tr}$  (total heat transfer coefficient due to transmission [W/K]) and  $H_{tr,em}$  (heat transfer coefficient for emission [W/K]) and replaces  $H_{ve}$  by  $H_{tot}$ . This means that all heat transfer with the outdoor air is assumed to go via the indoor air. The nodes  $\theta_{sup}$  (supply temperature of the ventilation air [°C]) and  $\theta_e$  (outdoor air temperature [°C]) are also combined assuming the room is ventilated by outdoor air.

Figure App.B.7 shows the electrical scheme of the 3R1C model.

## Changed equations

$$\Phi_{st} = (1 - A_m / A_t - H_{tot} / 9.1A_t) (0.5 \Phi_{int} + \Phi_{sol})$$

**EQUATION APP.B.6** Equation C.3 of EN ISO 13790 (2008) with  $H_{tot} = H_{tr,op} + H_{tr,w} + H_{ve}$

$$\theta_{m,t} = (\theta_{m,t-1} * ((C_m / 3600) - 0.5 * H_{tr,3}) + \Phi_{m,tot}) / ((C_m / 3600) + 0.5 * H_{tr,3})$$

**EQUATION APP.B.7** Equation C.4 of EN ISO 13790 (2008) with  $H_{tr,em} = 0$

$$\Phi_{m,tot} = \Phi_m + H_{tr,3} (\Phi_{st} + H_{tr,1} (((\Phi_{ia} + \Phi_{HC,nd}) / H_{tot}) + \theta_{sup})) / H_{tr,2}$$

**EQUATION APP.B.8** Equation C.5 of EN ISO 13790 (2008) with  $H_{tot} = H_{tr,op} + H_{tr,w} + H_{ve}$  and  $H_{tr,em} = 0$

$$H_{tr,1} = 1 / ((1 / H_{tot}) + (1 / H_{tr,3}))$$

**EQUATION APP.B.9** Equation C.6 of EN ISO 13790 (2008) with  $H_{ve} = 0$

$$H_{tr,2} = H_{tr,1}$$

**EQUATION APP.B.10** Equation C.7 of EN ISO 13790 (2008) with  $H_{ve} = 0$

$$\theta_s = (H_{tr,ms} * \theta_m + \Phi_{st} + H_{tr,1} * (\theta_{sup} + (\Phi_{ia} + \Phi_{HC,nd}) / H_{tot})) / (H_{tr,ms} + H_{tr,3})$$

**EQUATION APP.B.11** Equation C.10 of EN ISO 13790 (2008) with  $H_{tot} = H_{tr,op} + H_{tr,w} + H_{ve}$  and  $H_{tr,em} = 0$

$$\theta_{air} = (H_{tr,is} * \theta_s + H_{tot} * \theta_{sup} + \Phi_{ia} + \Phi_{HC,nd}) / (H_{tr,is} + H_{tot})$$

**EQUATION APP.B.12** Equation C.11 of EN ISO 13790 (2008) with  $H_{tot} = H_{tr,op} + H_{tr,w} + H_{ve}$  and  $H_{tr,em} = 0$

## Regression to obtain the algorithms for control of the solar factor and heat loss factor

For the control algorithm for both the solar factor as the heat loss factor the goal seek function of Excel is used to calculate the optimal setting for each hour in four weeks (1st - 7th of January for winter, 1st to 7th of April for spring, 1st to 7th of July for summer and 1st to 7th of October for autumn) in case of the lower thermal mass in the living room with occupancy by the 4 people household. These optimal settings are only calculated in case  $\theta_{op,max\_sol} < \text{comfort bandwidth} < \theta_{op,min\_sol}$  or  $\theta_{op,max\_H} < \text{comfort bandwidth} < \theta_{op,min\_H}$ . The data of these hours was then filtered out and a multiple linear regression was performed both on the relation between  $\theta_{op,max\_sol}$ ,  $\theta_{op,min\_sol}$  and  $\theta_{comf}$  with  $F_{sol,ideal}$  as the relation between  $\theta_{op,max\_H}$ ,  $\theta_{op,min\_H}$  and  $\theta_{comf}$  with  $H_{tot,ideal}$  resulting in the following equations (regression output [Figure App.B.8](#));

$$f_{sol} = 0.49 + -0.22*\theta_{op,0,sol} - 0.08*\theta_{op,max,sol} + 0.30*\theta_{comf}$$

**EQUATION APP.B.13**  $f_{sol}$  based on the linear relation between  $\theta_{op}$  and  $\Phi_{sol}$

With:

$\theta_{comf}$	[°C]	Required operative temperature or comfort temperature
$\theta_{op,0,sol}$	[°C]	Operative temperature in case of a solar factor of 0
$\theta_{op,max,sol}$	[°C]	Operative temperature in case of a solar factor of 1
$f_{sol}$		fraction of solar radiation on total façade surface entering the the room as heat

$$H_{tot} = -40.89 - 5.34*\theta_{op,max,H} + 55.23*\theta_{op,min,H} - 47.16*\theta_{comf}$$

**EQUATION APP.B.14**  $H_{tot}$  based on the linear relation between  $\theta_{op}$  and  $H_{tot}$

With:

$\theta_{comf}$	[°C]	Required operative temperature or comfort temperature
$\theta_{op,max,H}$	[°C]	Operative temperature in case of $H_{tot,max}$
$\theta_{op,min,H}$	[°C]	Operative temperature in case of $H_{tot,min}$
$H_{tot}$		Total heat loss factor

$$H_{tot,min} \leq H_{tot} \leq H_{tot,max}$$

SUMMARY OUTPUT

<i>Regression Statistics</i>	
Multiple R	0.72
R Square	0.52
Adjusted R	0.50
Standard Error	0.22
Observations	75.00

ANOVA					
	<i>df</i>	<i>SS</i>	<i>MS</i>	<i>F</i>	<i>Significance F</i>
Regression	3.00	3.74	1.25	25.91	0.00
Residual	71.00	3.42	0.05		
Total	74.00	7.16			

	<i>Coefficients</i>	<i>Standard Error</i>	<i>t Stat</i>	<i>P-value</i>	<i>Lower 95%</i>	<i>Upper 95%</i>	<i>Lower 95.0%</i>	<i>Upper 95.0%</i>
Intercept	0.49	0.76	0.65	0.52	-1.03	2.01	-1.03	2.01
$\theta_{op\_0\_sol}$	-0.22	0.05	-4.42	0.00	-0.32	-0.12	-0.32	-0.12
$\theta_{op\_max\_t}$	-0.08	0.02	-5.32	0.00	-0.11	-0.05	-0.11	-0.05
Tcplus	0.30	0.06	4.58	0.00	0.17	0.42	0.17	0.42

1 Regression results  $F_{sol}$

SUMMARY OUTPUT

<i>Regression Statistics</i>	
Multiple R	0.85
R Square	0.73
Adjusted R	0.72
Standard Error	14.82
Observations	195.00

ANOVA					
	<i>df</i>	<i>SS</i>	<i>MS</i>	<i>F</i>	<i>Significance F</i>
Regression	3.00	111680.05	37226.68	169.50	0.00
Residual	191.00	41948.20	219.62		
Total	194.00	153628.25			

	<i>Coefficients</i>	<i>Standard Error</i>	<i>t Stat</i>	<i>P-value</i>	<i>Lower 95%</i>	<i>Upper 95%</i>	<i>Lower 95.0%</i>	<i>Upper 95.0%</i>
Intercept	-40.89	46.74	-0.87	0.38	-133.07	51.29	-133.07	51.29
$\theta_{op\_max\_l}$	-5.34	1.03	-5.17	0.00	-7.38	-3.30	-7.38	-3.30
$\theta_{op\_min\_t}$	55.23	2.94	18.76	0.00	49.42	61.04	49.42	61.04
Tcplus	-47.16	3.10	-15.23	0.00	-53.27	-41.05	-53.27	-41.05

2 Regression results  $H_{tot}$

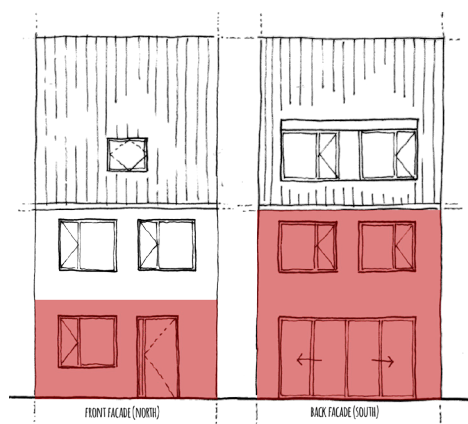
FIGURE APP.B.8 Regression results for optimal  $F_{sol}$  and  $H_{tot}$





# Appendix C Input calculations chapter lumped capacitance model

## Geometry



1 Façades



2 Floor plans

TABLE APP.C.1 Façades and floor plans living room and bedroom of the reference dwelling used in chapter 6

## Initial values

LIVING ROOM / KITCHEN			
A [m <sup>2</sup> ]	33.04		
volume [m <sup>3</sup> ]	85.91		
boundary	type	A [m <sup>2</sup> ]	orientation
external	wall	4.90	north
	window	2.55	
external	wall	3.66	south
	window	9.60	
ground	ground floor	33.04	-
identical	separation wall	20.59	-
identical	internal floor	33.04	-
identical	internal wall	31.86	-

TABLE APP.C.2 Geometry of the living room

MASTER BEDROOM			
A [m <sup>2</sup> ]	16.29		
volume [m <sup>3</sup> ]	42.35		
boundary	type	A [m <sup>2</sup> ]	orientation
external	wall	8.16	south
	window	5.10	
identical	separation wall	13.26	-
identical	internal floor	32.58	-
identical	internal wall	17.08	-

TABLE APP.C.3 Geometry of the bedroom

## Initial values

INITIAL VALUES			
boundary	type	U-value [W/m <sup>2</sup> K]	G-value
external	wall	0.193	
	window	1.6	0.6
ground	ground floor	0.193	
identical	separation wall	-	
identical	internal floor	-	
identical	internal wall	-	
operation			
ventilation [1/h]	1.25	(0.9 l/sm <sup>2</sup> )	
infiltration [1/h]	0		
schedule living room	heating setpoint	cooling setpoint	
0:00 – 6:00	15 °C	30 °C	
6:00 – 23:00	20.5 °C	25 °C	
23:00 – 0:00	15 °C	30 °C	
schedule bedroom	heating setpoint	cooling setpoint	
0:00 – 7:00	18 °C	25 °C	
7:00 – 23:00	15 °C	30 °C	
23:00 – 0:00	18 °C	25 °C	
internal gains	equipment	people	
absence (occ. schedule)	1 W/m <sup>2</sup>	-	
presence (occ. schedule)	10 W/m <sup>2</sup>	75W *(no. of people present)	

TABLE APP.C.4 Initial values for the reference situations

## Cases

CASES					
thermal mass	capacitance [J/Km <sup>2</sup> ] per m <sup>2</sup> floor area (A <sub>f</sub> )				
low	80000				
mid	165000				
high	370000				
occupancy profiles (for full profile appendix A)	code	no. of people in household	occupancy rate	av. no. of peo- ple present	av. activity level
1 student	1_st	1	10%	1.26	2.5
couple both with job	2_w	2	18%	1.32	2.1
couple with 2 small children	4_sm	4	46%	1.70	2.4

TABLE APP.C.5 Cases for thermal mass level and occupancy profile

## Control variants

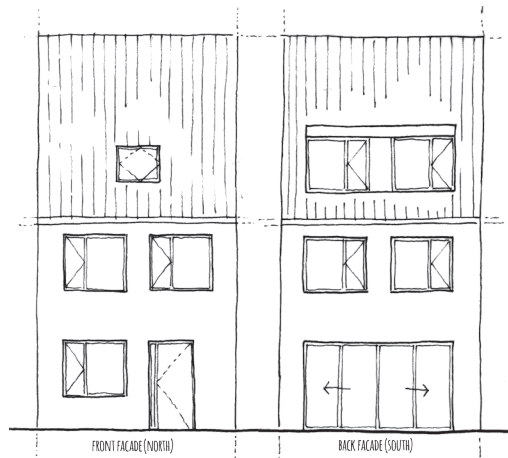
		$\Phi_{HC,ND}$		$H_{TOT}$			$F_{SOL}$				
		timing	setpoint	automation	frequency	range Utr [W/m <sup>2</sup> K]	range Uopaque [W/m <sup>2</sup> K]	range Qve [l/h]	automation	frequency	range fsol
reference	s	hi/lo	-	-	0.2	1.6	1.25	-	-	0.6* %	
adaptive heating	p	ACA	-	-	0.2	1.6	1.25	-	-	0.6* %	
max heat loss	p	ACA	-	-	0.2	1.6	30	-	-	0	
min heat loss	p	ACA	-	-	0.1	1.2	minpres	-	-	1	
adaptive $H_{tot,hour}$	p	ACA	+	h	0.1-0.2	1.2-1.6	minpres-30	-	-	0.6* %	
adaptive $H_{tot,day}$	p	ACA	+	d	0.1-0.2	1.2-1.6	minpres-30	-	-	0.6* %	
adaptive $H_{tot,season}$	p	ACA	+	s	0.1-0.2	1.2-1.6	minpres-30	-	-	0.6* %	
adaptive $H_{tot,month}$	p	ACA	+	m	0.1-0.2	1.2-1.6	minpres-30	-	-	0.6* %	
presence $H_{tot,hour}$	p	ACA	-	h	0.1-0.2	1.2-1.6	minpres-30	-	-	0.6* %	
adaptive $f_{sol,hour}$	p	ACA	-	-	0.2	1.6	1.25	+	h	0-1	
adaptive $f_{sol,day}$	p	ACA	-	-	0.2	1.6	1.25	+	d	0-1	
adaptive $f_{sol,season}$	p	ACA	-	-	0.2	1.6	1.25	+	s	0-1	
adaptive $f_{sol,month}$	p	ACA	-	-	0.2	1.6	1.25	+	m	0-1	
presence $f_{sol,hour}$	p	ACA	-	-	0.2	1.6	1.25	-	h	0-1	
adaptive $H_{tot,hour} f_{sol,hour}$	p	ACA	+	h	0.1-0.2	1.2-1.6	minpres-30	+	h	0-1	
adaptive $H_{tot,day} f_{sol,day}$	p	ACA	+	d	0.1-0.2	1.2-1.6	minpres-30	+	d	0-1	
adaptive $H_{tot,season} f_{sol,season}$	p	ACA	+	s	0.1-0.2	1.2-1.6	minpres-30	+	s	0-1	
adaptive $H_{tot,month} f_{sol,month}$	p	ACA	+	m	0.1-0.2	1.2-1.6	minpres-30	+	m	0-1	
presence $H_{tot,hour} f_{sol,hour}$	p	ACA	-	h	0.1-0.2	1.2-1.6	minpres-30	-	h	0-1	
s	schedule (Table App.C.4)										
p	presence										
hi/lo	setpoint and setback (Table App.C.4)										
ACA	Adaptive Comfort Algorithm (Equation 2.3 to Equation 2.6)										
-	none										
+	automation										
h	hourly switch										
d	daily switch										
s	seasonally switch										
m	monthly switch										

TABLE APP.C.6 Variants of control for heating and cooling ( $Q_{HC,nd}$ ), heat loss coefficient ( $H_{tot}$ ) and solar factor ( $f_{sol}$ )



# Appendix D Input TRNSYS

## Geometry



1 Façades



2 Floor plans

**FIGURE APP.D.1** Façades and floor plans of the reference dwelling of AgentschapNL used in the TRNSYS calculations



AIR NODE PROPERTIES										
TRNSYS zone	floor	area [m2]	volume [m3]	function	conditioning					
AN01_livingroom	GF	16.5	42.9	living room	ACA_liv					
AN02_kitchen	GF	16.3	42.3	kitchen	ACA_liv					
AN03_stairs_gf	GF	12.7	33.0	traffic	-					
AN11_master_bedroom	1st	16.5	42.9	bedroom	ACA_bed					
AN12_bedroom_02	1st	10.2	26.4	bedroom	ACA_bed					
AN13_bedroom_03	1st	5.6	14.6	bedroom	ACA_bed					
AN14_bathroom	1st	6.1	15.9	bathroom	13°C-18°C					
AN15_stairs_1st	1st	7.1	18.4	traffic	-					
AN21_attic_back	2nd	16.5	26.7	miscellaneous	-					
AN22_attic_front	2nd	12.8	16.1	miscellaneous	-					
AN23_technique	2nd	9.1	32.9	utility	-					
AN24_stairs_2nd	2nd	7.1	25.7	traffic	-					
boundary conditions										
BND_WALL	identical									
GROUND_FLOOR	10 °C									
External nodes	height	orientation	wind pressure coefficient (cpvalue)							
			0°	45°	90°	135°	180°	225°	270°	315°
EN01	1.8	South	-0.19	-0.15	-0.19	0.09	0.09	0.10	-0.20	-0.15
EN02	1.8	North	0.20	0.19	-0.18	-0.15	-0.12	-0.13	-0.18	0.13
EN03	1.8	North	0.20	0.14	-0.18	-0.13	-0.12	-0.15	-0.18	0.18
EN11	4.7	South	-0.19	-0.15	-0.20	0.10	0.09	0.10	-0.20	-0.15
EN12	4.7	North	0.20	0.19	-0.18	-0.15	-0.12	-0.13	-0.18	0.13
EN13	4.7	North	0.2	0.14	-0.18	-0.13	-0.12	-0.15	-0.18	0.19
EN21	7.5	South 45°	-0.47	-0.31	-0.20	-0.41	-0.33	-0.42	-0.20	-0.31
EN22	7.5	North 45°	-0.23	-0.37	-0.17	-0.21	-0.16	-0.21	-0.17	-0.36
EN31a	9.4	South 45°	-0.34	-0.3	-0.19	-0.3	-0.31	-0.39	-0.19	-0.33
EN31b	9.4	South 45°	-0.34	-0.33	-0.19	-0.38	-0.31	-0.31	-1.9	-0.3
EN32a	9.4	North 45°	-0.21	-0.30	-0.17	-0.21	-0.16	-0.24	-0.16	-0.32
EN32b	9.4	North 45°	-0.21	-0.32	-0.16	-0.24	-0.16	-0.22	-0.17	-0.29
EN41b	10.6	top	-0.29	-0.30	-0.18	-0.25	-0.23	-0.30	-0.17	-0.33

TABLE APP.D.1 Properties of the air nodes, boundary conditions and external nodes for the TRNSYS model

CONSTRUCTIONS AND LAYERS							
wall type	layer	thickness [m]	U [W/m <sup>2</sup> K]	R-value [m <sup>2</sup> K/W]	capacitance [J/kgK]	density [kg/m <sup>3</sup> ]	
						low	high
<b>EXT_ROOF</b>	<b>total</b>	<b>0.208</b>	<b>0.196</b>	<b>4.97</b>	-	-	-
	PLASTERBOARD	0.013	-	0.081	840	950	-
	PLYWOOD	0.020	-	0.133	1200	800	-
	POLY_URETHANE	0.140	-	3.877	2000	40	-
	CAVITY	-	-	0.17	-	-	-
	ROOFDECK	0.100	-	0.714	900	530	-
<b>EXT_WALL</b>	<b>total</b>	<b>0.370</b>	<b>0.193</b>	<b>5.05</b>	-	-	-
	LIMESTONE	0.100	-	0.077	840	525	2500
	POLY_URETHANE	0.170	-	4.7	2000	40	-
	CAVITY	-	-	0.17	-	-	-
	CLINCKER	0.100	-	0.104	1000	2000	-
<b>GROUND_FLOOR</b>	<b>total</b>	<b>0.190</b>	<b>0.195</b>	<b>4.98</b>	-	-	-
	CONCRETE_SLAB	0.100	-	0.088	840	525	2500
	POLY_URETHANE	0.170	-	4.7	2000	40	-
	AIRLAYER	-	-	0.17	-	-	-
<b>BND_WALL</b>	<b>total</b>	<b>0.360</b>	<b>1.520</b>	<b>0.487</b>	-	-	-
	CONCRETE_SLAB	0.180	-	0.159	840	525	2500
	CAVITY	-	-	0.17	-	-	-
	CONCRETE_SLAB	0.180	-	0.159	840	525	2500
<b>ADJ_WALL</b>	<b>LIMESTONE</b>	<b>0.070</b>	<b>4.467</b>	-	<b>840</b>	<b>525</b>	<b>2500</b>
<b>ADJ_CEILING</b>	<b>CONCRETE_SLAB</b>	<b>0.260</b>	<b>2.499</b>	-	<b>840</b>	<b>525</b>	<b>2500</b>
window type	glass type	U <sub>glass</sub> [W/m <sup>2</sup> K]		glass percentage	G-value		
<b>EXT_WINDOW</b>	<b>ASH_A-17.37a</b>	<b>1.2</b>		<b>70%</b>	<b>0.612</b>		
<b>EXT_DOOR</b>	<b>ASH_A-17.37a</b>	<b>1.2</b>		<b>30%</b>	<b>0.612</b>		

TABLE APP.D.2 Materialisation properties of the separation walls for the TRNSYS model

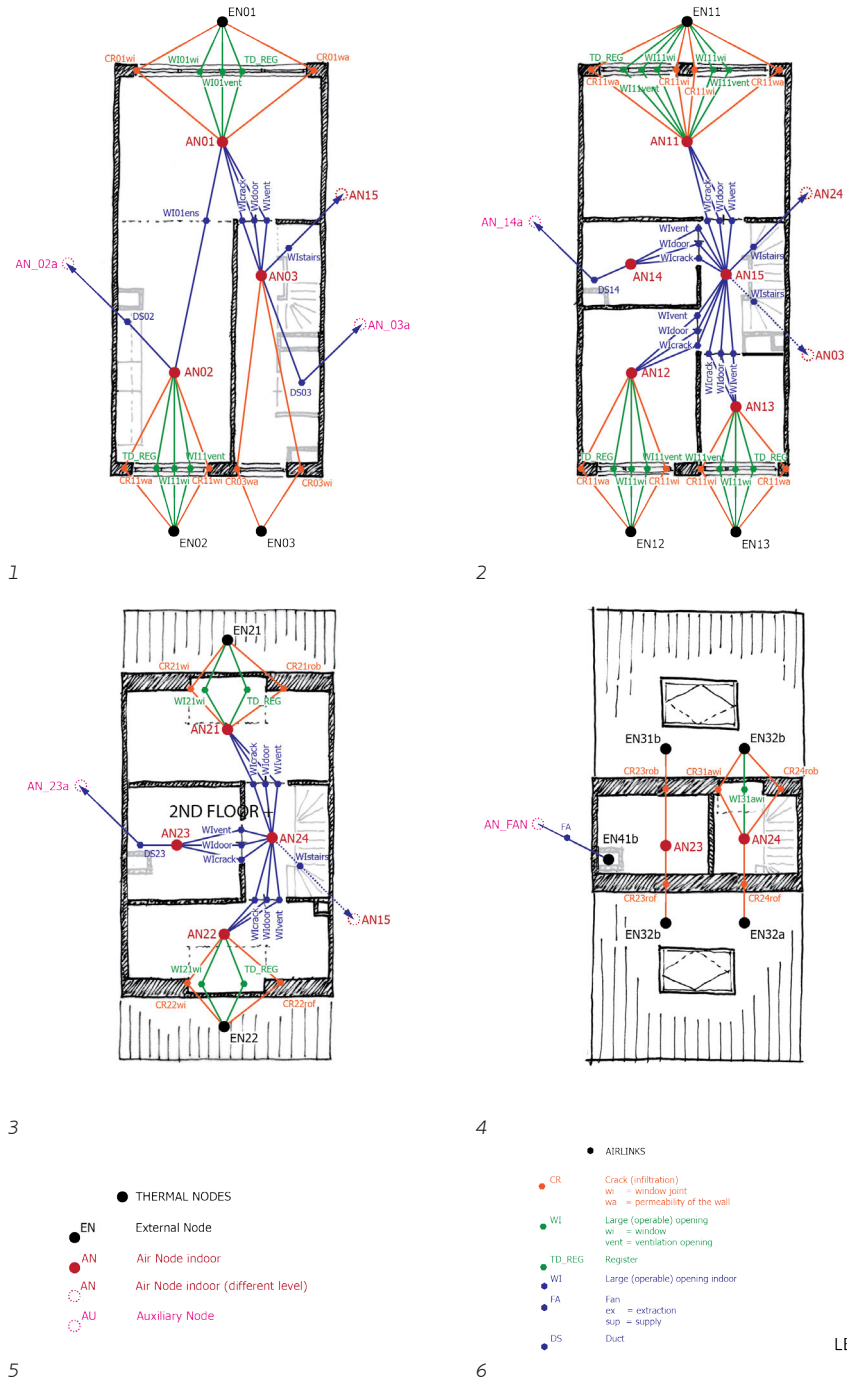
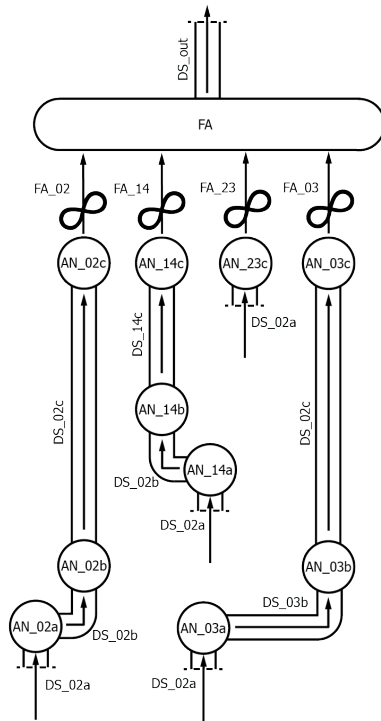


FIGURE APP.D.2 Visualisation of the air node and air link model without the ductwork for mechanical ventilation (Figure D.3 & Figure D.4)



**FIGURE APP.D.3** Air link model with ducts, fans and auxiliary nodes for the variants with natural supply and mechanical exhaust; in reality there is one fan and the ducts are joined where possible.

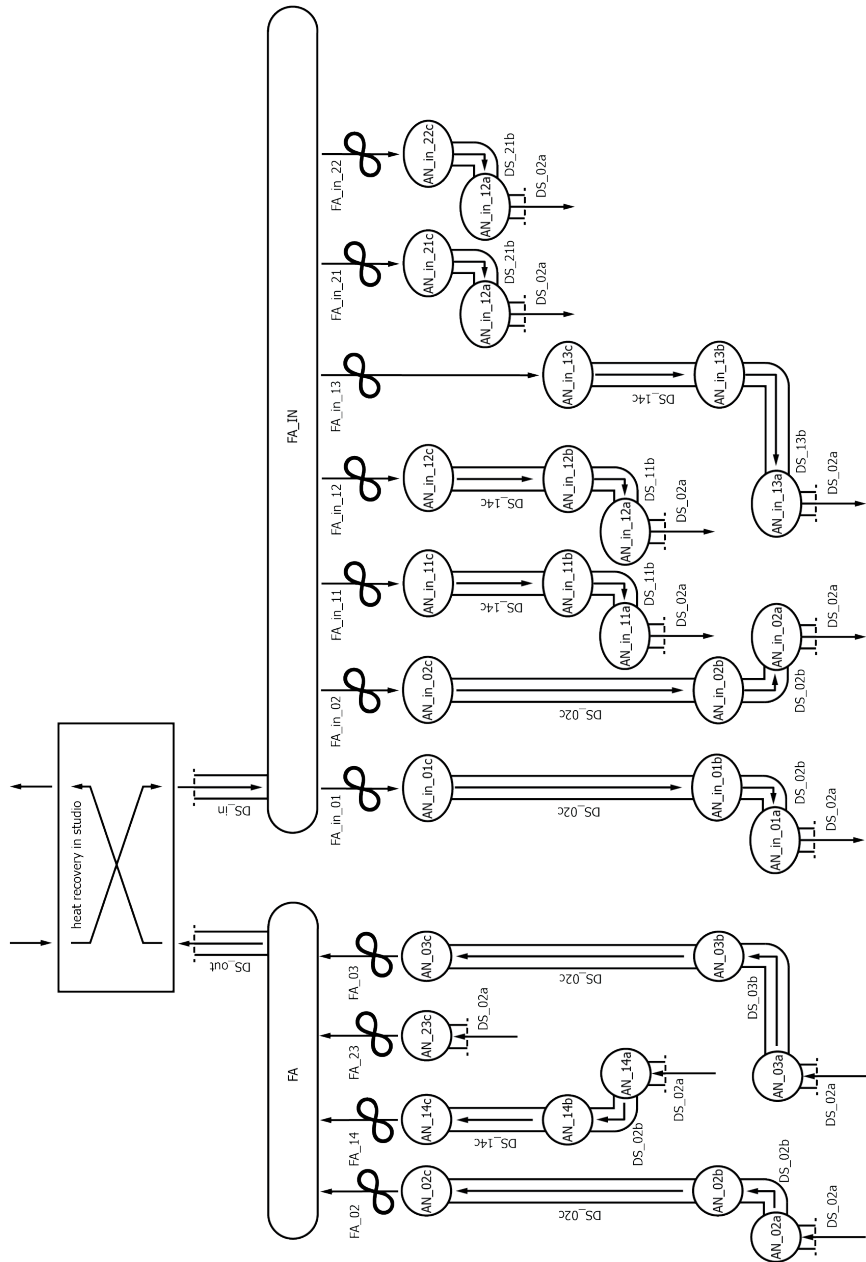


FIGURE APP.D.4 Air link model with ducts, fans and auxiliary nodes for the variants with mechanical supply and mechanical exhaust; in reality there is one exhaust fan and one supply fan and the ducts are joined where possible.

AN01_LIVINGROOM								
walls and windows								
adjacent to	orientation	area [m <sup>2</sup> ]	construction <sup>a</sup>			U-value [W/m <sup>2</sup> K]	G-value	
External	South	3.0	EXT_WALL			0.2	-	
External	South	10.3	EXT_WINDOW			1.2	0.6	
Boundary (ground)	-	16.5	GROUND_FLOOR			0.2	-	
Boundary (identical)	-	8.4	BND_WALL			1.5	-	
Boundary (identical)	-	8.4	BND_WALL			1.5	-	
AN03_stairs_gf	-	5.8	ADJ_WALL			4.5	-	
AN02_kitchen	-	7.5	open connection			-	-	
AN11_master_bedroom	-	16.5	ADJ_CEILING			2.5	-	
air flow network								
link to air node	name	type	mass flow at 1PAb			ventilation rate [1/h]	max opening	
			kg/s/m	kg/s/m <sup>2</sup>	comp [n] <sup>c</sup>		width [m]	height [m]
EN01	CR01wi	crack, window	3.3e-5	-	0.6	-	-	-
	CR01wa	crack, wall	-	2.5e-5	0.85	-	-	-
	WI01wi	operable window	2e-5	-	0.7	-	3.8	2.3
	WI01vent	operable vent	5e-6	-	0.7	-	3.8	0.3
	TD_REG	register	-	-	-	studio <sup>f</sup>	-	-
AN02_kitchen	WI01ens	sliding doors	0.05	-	0.7	-	2.9	2.6
AN03_stairs_gf	WIcrack	crack under door	5e-5	-	0.7	-	0.8	0.02
	WIdoor	door	5e-5	-	0.7	-	0.8	2.3
	WIvent	operable vent	5e-5	-	0.7	-	0.8	0.2
AN01_IN <sup>e</sup>	DS02	inlet duct	-	-	-	studio <sup>f</sup>	-	-

a construction of separation walls as defined in Table App.D.2

b based on technical information obtained from Orme et al. (1998)

c air flow component [n] (Orme et al., 1998)

d auxiliary node for ductwork mechanical exhaust divided according to Figure App.D.3

e auxiliary node for ductwork mechanical supply variant divided according to Figure App.D.4

f air flow rate controlled in TRNSYS studio according to the variants of ventilation supply (Table App.D.17)

TABLE APP.D.3 Thermal zone connections and air link properties of the living room

AN02_KITCHEN								
walls and windows								
adjacent to	orientation	area [m <sup>2</sup> ]	construction <sup>a</sup>			U-value [W/m <sup>2</sup> K]	G-value	
External	North	4.8	EXT_WALL			0.2	-	
External	North	2.7	EXT_WINDOW			1.2	0.6	
Boundary (ground)	-	16.3	GROUND_FLOOR			0.2	-	
Boundary (identical)	-	14.8	BND_WALL			1.5	-	
AN01_living room	-	7.5	open connection			-	-	
AN03_stairs_gf	-	14.8	ADJ_WALL			4.5	-	
AN12_bedroom02	-	10.2	ADJ_CEILING			2.5	-	
AN14_bathroom	-	6.1	ADJ_CEILING			2.5	-	
air flow network								
link to air node	name	type	mass flow at 1PA <sup>b</sup>			ventilation	max opening	
			kg/s/m	kg/s/m <sup>2</sup>	comp [n] <sup>c</sup>		rate [1/h]	width [m]
EN02	CR11wi	crack, window	3.3e-5	-	0.6	-	-	-
	CR11wa	crack, wall	-	2.5e-5	0.85	-	-	-
	W11wi	operable window	2e-5	-	0.7	-	1.5	1.5
	W11vent	operable vent	5e-6	-	0.7	-	1.5	0.3
	TD_REG	register	-	-	-	studio <sup>f</sup>	-	-
AN01_living room	WI01ens	sliding doors	0.05	-	0.7	-	2.9	2.6
AN02 <sup>d</sup>	DS02	duct inlet	-	-	-	studio <sup>f</sup>	-	-
AN02_IN <sup>e</sup>	DS02	duct inlet	-	-	-	studio <sup>f</sup>	-	-

a construction of separation walls as defined in Table App.D.2

b based on technical information obtained from Orme et al. (1998)

c air flow component [n] (Orme et al., 1998)

d auxiliary node for ductwork mechanical exhaust divided according to Figure App.D.3

e auxiliary node for ductwork mechanical supply variant divided according to Figure App.D.4

f air flow rate controlled in TRNSYS studio according to the variants of ventilation supply (Table App.D.17)

TABLE APP.D.4 thermal zone connections and air link properties of the kitchen

AN03_STAIRS_GF (TRAFFIC AND TOILET)								
walls and windows								
adjacent to	orientation	area [m <sup>2</sup> ]	construction <sup>a</sup>			U-value [W/m <sup>2</sup> K]	G-value	
External	North	3.0	EXT_WALL			0.2	-	
External	North	2.8	EXT_DOOR			1.2	0.6	
Boundary (ground)	-	12.7	GROUND_FLOOR			0.2	-	
Boundary (identical)	-	14.8	BND_WALL			1.5	-	
AN01_living room	-	5.8	ADJ_WALL			4.5	-	
AN02_kitchen	-	14.8	ADJ_WALL			4.5	-	
AN13_bedroom03	-	5.6	ADJ_CEILING			2.5	-	
AN14_bathroom	-	6.1	ADJ_CEILING			2.5	-	
air flow network								
link to air node	name	type	mass flow at 1PA <sup>b</sup>			ventilation rate [l/h]	max opening	
			kg/s/m	kg/s/m <sup>2</sup>	comp [n] <sup>c</sup>		width [m]	height [m]
EN02	CR03do	crack, door	5.5e-4	-	0.6	-	-	-
	CR03wa	crack, wall	-	2.5e-5	0.85	-	-	-
AN01_living room	Wlcrack	crack under door	5e-5	-	0.7	-	0.8	0.02
	Wldoor	door	5e-5	-	0.7	-	0.8	2.3
	Wlvent	operable vent	5e-5	-	0.7	-	0.8	0.2
AN15_stairs_1st	Wl_stairs	open connection	-	-	-	-	1.2	3.7
AN03 <sup>d</sup>	DS02	duct inlet	-	-	-	studio <sup>f</sup>	-	-

a construction of separation walls as defined in Table App.D.2

b based on technical information obtained from Orme et al. (1998)

c air flow component [n] (Orme et al., 1998)

d auxiliary node for ductwork mechanical exhaust divided according to Figure App.D.3

e auxiliary node for ductwork mechanical supply variant divided according to Figure App.D.4

f air flow rate controlled in TRNSYS studio according to the variants of ventilation supply (Table App.D.17)

TABLE APP.D.5 Thermal zone connections and air link properties of the traffic zone of the ground floor



AN11_MASTER BEDROOM								
walls and windows								
adjacent to	orientation	area [m <sup>2</sup> ]	construction <sup>a</sup>			U-value [W/m <sup>2</sup> K]	G-value	
External	South	7.9	EXT_WALL			0.2	-	
External	South	2.7	EXT_WINDOW			1.2	0.6	
External	South	2.7	EXT_WINDOW			1.2	0.6	
Boundary (identical)	-	8.4	BND_WALL			1.5	-	
Boundary (identical)	-	8.4	BND_WALL			1.5	-	
AN14_bathroom	-	7.5	ADJ_WALL			4.5	-	
AN15_stairs_1 <sup>st</sup>	-	5.8	ADJ_WALL			4.5	-	
AN01_living room	-	16.5	ADJ_CEILING			2.5	-	
AN21_attic back	-	16.5	ADJ_CEILING			2.5	-	
air flow network								
link to air node	name	type	mass flow at 1PAb			ventilation	max opening	
			kg/s/m	kg/s/m <sup>2</sup>	comp [n] <sup>c</sup>	rate [1/h]	width [m]	height [m]
EN11	CR11wi	crack, window	3.3e-5	-	0.6	-	-	-
	CR11wa	crack, wall	-	2.5e-5	0.85	-	-	-
	W111wi	operable window	2e-5	-	0.7	-	1.5	1.5
	W111vent	operable vent	5e-6	-	0.7	-	1.5	0.3
	TD_REG	register	-	-	-	studiof	-	-
	CR11wi	crack, window	3.3e-5	-	0.6	-	-	-
	CR11wa	crack, wall	-	2.5e-5	0.85	-	-	-
	W111wi	operable window	2e-5	-	0.7	-	1.5	1.5
	W111vent	operable vent	5e-6	-	0.7	-	1.5	0.3
	TD_REG	register	-	-	-	studiof	-	-
AN15_stairs_1 <sup>st</sup>	Wicrack	crack under door	5e-5	-	0.7	-	0.8	0.02
	WIdoor	door	5e-5	-	0.7	-	0.8	2.3
	Wivent	operable vent	5e-5	-	0.7	-	0.8	0.2
AN11_IN <sup>e</sup>	DS02	duct inlet	-	-	-	studiof	-	-

a construction of separation walls as defined in Table App.D.2

b based on technical information obtained from Orme et al. (1998)

c air flow component [n] (Orme et al., 1998)

d auxiliary node for ductwork mechanical exhaust divided according to Figure App.D.3

e auxiliary node for ductwork mechanical supply variant divided according to Figure App.D.4

f air flow rate controlled in TRNSYS studio according to the variants of ventilation supply (Table App.D.17)

TABLE APP.D.6 Thermal zone connections and air link properties of the master bedroom

AN12_BEDROOM02								
walls and windows								
adjacent to	orientation	area [m <sup>2</sup> ]	construction <sup>a</sup>			U-value [W/m <sup>2</sup> K]	G-value	
External	North	4.8	EXT_WALL			0.2	-	
External	North	2.7	EXT_WINDOW			1.2	0.6	
Boundary (identical)	-	9.2	BND_WALL			1.5	-	
AN14_bathroom	-	7.5	ADJ_WALL			4.5	-	
AN15_stairs_1 <sup>st</sup>	-	3.3	ADJ_WALL			4.5	-	
AN13_bedroom03	-	6.5	ADJ_WALL			4.5	-	
AN02_kitchen	-	10.2	ADJ_CEILING			2.5	-	
AN22_attic front	-	7.2	ADJ_CEILING			2.5	-	
AN23_technique	-	3.0	ADJ_CEILING			2.5	-	
air flow network								
link to air node	name	type	mass flow at 1PA <sup>b</sup>			ventilation	max opening	
			kg/s/m	kg/s/m <sup>2</sup>	comp [n] <sup>c</sup>		rate [l/h]	width [m]
EN12	CR11wi	crack, window	3.3e-5	-	0.6	-	-	-
	CR11wa	crack, wall	-	2.5e-5	0.85	-	-	-
	WI11wi	operable window	2e-5	-	0.7	-	1.5	1.5
	WI11vent	operable vent	5e-6	-	0.7	-	1.5	0.3
	TD_REG	register	-	-	-	studio <sup>f</sup>	-	-
AN15_stairs_1 <sup>st</sup>	Wlcrack	crack under door	5e-5	-	0.7	-	0.8	0.02
	Wldoor	door	5e-5	-	0.7	-	0.8	2.3
	Wlvent	operable vent	5e-5	-	0.7	-	0.8	0.2
AN12_IN <sup>e</sup>	DS02	duct inlet	-	-	-	studio <sup>f</sup>	-	-

a construction of separation walls as defined in Table App.D.2

b based on technical information obtained from Orme et al. (1998)

c air flow component [n] (Orme et al., 1998)

d auxiliary node for ductwork mechanical exhaust divided according to Figure App.D.3

e auxiliary node for ductwork mechanical supply variant divided according to Figure App.D.4

f air flow rate controlled in TRNSYS studio according to the variants of ventilation supply (Table App.D.17)

TABLE APP.D.7 Thermal zone connections and air link properties of the second bedroom

AN13_BEDROOM03								
walls and windows								
adjacent to	orientation	area [m <sup>2</sup> ]	construction <sup>a</sup>			U-value [W/m <sup>2</sup> K]	G-value	
External	North	4.8	EXT_WALL			0.2	-	
External	North	2.7	EXT_WINDOW			1.2	0.6	
Boundary (identical)	-	9.2	BND_WALL			1.5	-	
AN15_stairs_1 <sup>st</sup>	-	5.8	ADJ_WALL			4.5	-	
AN12_bedroom02	-	6.5	ADJ_WALL			4.5	-	
AN03_stairs_gf	-	5.6	ADJ_CEILING			2.5	-	
AN22_attic front	-	5.6	ADJ_CEILING			2.5	-	
air flow network								
link to air node	name	type	mass flow at 1PA <sup>b</sup>			ventilation rate [1/h]	max opening	
			kg/s/m	kg/s/m <sup>2</sup>	comp [n] <sup>c</sup>		width [m]	height [m]
EN13	CR11wi	crack, window	3.3e-5	-	0.6	-	-	-
	CR11wa	crack, wall	-	2.5e-5	0.85	-	-	-
	W11wi	operable window	2e-5	-	0.7	-	1.5	1.5
	W11vent	operable vent	5e-6	-	0.7	-	1.5	0.3
	TD_REG	register	-	-	-	studio <sup>f</sup>	-	-
AN15_stairs_1 <sup>st</sup>	W1crack	crack under door	5e-5	-	0.7	-	0.8	0.02
	W1door	door	5e-5	-	0.7	-	0.8	2.3
	W1vent	operable vent	5e-5	-	0.7	-	0.8	0.2
AN13_IN <sup>e</sup>	DS02	duct inlet	-	-	-	studio <sup>f</sup>	-	-

a construction of separation walls as defined in Table App.D.2

b based on technical information obtained from Orme et al. (1998)

c air flow component [n] (Orme et al., 1998)

d auxiliary node for ductwork mechanical exhaust divided according to Figure App.D.3

e auxiliary node for ductwork mechanical supply variant divided according to Figure App.D.4

f air flow rate controlled in TRNSYS studio according to the variants of ventilation supply (Table App.D.17)

TABLE APP.D.8 Thermal zone connections and air link properties of the third bedroom

AN14_BATHROOM									
walls and windows									
adjacent to	orientation	area [m <sup>2</sup> ]	construction <sup>a</sup>			U-value [W/m <sup>2</sup> K]	G-value		
Boundary (identical)	-	5.6	BND_WALL			1.5	-		
AN15_stairs_1st	-	5.6	ADJ_WALL			4.5	-		
AN11_master bedroom	-	7.5	ADJ_WALL			4.5	-		
AN12_bedroom02	-	7.5	ADJ_WALL			4.5	-		
AN02_kitchen	-	6.1	ADJ_CEILING			2.5	-		
AN23_technique	-	6.1	ADJ_CEILING			2.5	-		
air flow network									
link to air node	name	type	mass flow at 1PA <sup>b</sup>			ventilation rate [1/h]	max opening		
			kg/s/m	kg/s/m <sup>2</sup>	comp [n] <sup>c</sup>		width [m]	height [m]	
AN15_stairs_1st	Wlcrack	crack under door	5e-5	-	0.7	-	0.8	0.02	
	Wldoor	door	5e-5	-	0.7	-	0.8	2.3	
	Wlvent	operable vent	5e-5	-	0.7	-	0.8	0.2	
AN14 <sup>d</sup>	DS02	duct inlet	-	-	-	studio <sup>f</sup>	-	-	

a construction of separation walls as defined in Table App.D.2  
b based on technical information obtained from Orme et al. (1998)  
c air flow component [n] (Orme et al., 1998)  
d auxiliary node for ductwork mechanical exhaust divided according to Figure App.D.3  
e auxiliary node for ductwork mechanical supply variant divided according to Figure App.D.4  
f air flow rate controlled in TRNSYS studio according to the variants of ventilation supply (Table App.D.17)

TABLE APP.D.9 Thermal zone connections and air link properties of the bathroom

AN15_STAIRS_1 <sup>ST</sup>								
walls and windows								
adjacent to	orientation	area [m <sup>2</sup> ]	construction <sup>a</sup>			U-value [W/m <sup>2</sup> K]	G-value	
Boundary (identical)	-	11.5	BND_WALL			1.5	-	
AN11_master bedroom	-	5.8	ADJ_WALL			4.5	-	
AN12_bedroom02	-	3.3	ADJ_WALL			4.5	-	
AN13_bedroom03	-	5.8	ADJ_WALL			4.5	-	
AN14_bathroom	-	5.6	ADJ_WALL			4.5	-	
air flow network								
link to air node	name	type	mass flow at 1PA <sup>b</sup>			ventilation	max opening	
			kg/s/m	kg/s/m <sup>2</sup>	comp [n] <sup>c</sup>	rate [1/h]	width [m]	height [m]
AN11_master bedroom	Wlcrack	crack under door	5e-5	-	0.7	-	0.8	0.02
	Wldoor	door	5e-5	-	0.7	-	0.8	2.3
	Wlvent	operable vent	5e-5	-	0.7	-	0.8	0.2
AN12_bedroom02	Wlcrack	crack under door	5e-5	-	0.7	-	0.8	0.02
	Wldoor	door	5e-5	-	0.7	-	0.8	2.3
	Wlvent	operable vent	5e-5	-	0.7	-	0.8	0.2
AN13_bedroom03	Wlcrack	crack under door	5e-5	-	0.7	-	0.8	0.02
	Wldoor	door	5e-5	-	0.7	-	0.8	2.3
	Wlvent	operable vent	5e-5	-	0.7	-	0.8	0.2
AN14_bathroom	Wlcrack	crack under door	5e-5	-	0.7	-	0.8	0.02
	Wldoor	door	5e-5	-	0.7	-	0.8	2.3
	Wlvent	operable vent	5e-5	-	0.7	-	0.8	0.2
AN03_stairs_gf	WI_stairs	open connection	-	-	-	-	1.2	3.7
AN24_stairs_2nd	WI_stairs	open connection	-	-	-	-	1.2	3.7

a construction of separation walls as defined in Table App.D.2  
b based on technical information obtained from Orme et al. (1998)  
c air flow component [n] (Orme et al., 1998)  
d auxiliary node for ductwork mechanical exhaust divided according to Figure App.D.3  
e auxiliary node for ductwork mechanical supply variant divided according to Figure App.D.4  
f air flow rate controlled in TRNSYS studio according to the variants of ventilation supply (Table App.D.17)

TABLE APP.D.10 Thermal zone connections and air link properties of the traffic zone on the first floor

AN21_ATTIC BACK								
walls and windows								
adjacent to	orientation	area [m <sup>2</sup> ]	construction <sup>a</sup>	U-value [W/m <sup>2</sup> K]	G-value			
External	South 45°	21.6	EXT_ROOF	0.2	-			
External	South 45°	1.8	EXT_WINDOW	1.2	0.6			
Boundary (identical)	-	5.2	BND_WALL	1.5	-			
Boundary (identical)	-	5.2	BND_WALL	1.5	-			
AN23_technique	-	9.3	ADJ_WALL	4.5	-			
AN24_stairs_2 <sup>nd</sup>	-	7.2	ADJ_WALL	4.5	-			
AN11_master bedroom	-	16.5	ADJ_CEILING	2.5	-			
air flow network								
link to air node	name	type	mass flow	flow rate	max			
			at 1PA <sup>b</sup>	[1/h]	opening	width [m]	height [m]	
			kg/s/m	kg/s/m <sup>2</sup>	comp [n] <sup>c</sup>			
EN21	CR21wi	crack, window	3.3e-5	-	0.6	-	-	-
	CR21rob	crack, roof	-	2.5e-3	0.59	-	-	-
	WI21wi	operable window	2e-5	-	0.7	-	0.9	0.9
	TD_REG	register	-	-	-	studio <sup>f</sup>	-	-
AN24_stairs_2 <sup>nd</sup>	Wicrack	crack under door	5e-5	-	0.7	-	0.8	0.02
	Widoor	door	5e-5	-	0.7	-	0.8	2.3
	Wivent	operable vent	5e-5	-	0.7	-	0.8	0.2
AN21_IN <sup>e</sup>	DS02	duct inlet	-	-	-	studio <sup>f</sup>	-	-

a construction of separation walls as defined in Table App.D.2

b based on technical information obtained from Orme et al. (1998)

c air flow component [n] (Orme et al., 1998)

d auxiliary node for ductwork mechanical exhaust divided according to Figure App.D.3

e auxiliary node for ductwork mechanical supply variant divided according to Figure App.D.4

f air flow rate controlled in TRNSYS studio according to the variants of ventilation supply (Table App.D.17)

TABLE APP.D.11 Thermal zone connections and air link properties of the miscellaneous room at the garden side of the attic

AN22_ATTIC FRONT									
walls and windows									
adjacent to	orientation	area [m <sup>2</sup> ]	construction <sup>a</sup>			U-value [W/m <sup>2</sup> K]	G-value		
External	North 45°	16.7	EXT_ROOF			0.2	-		
External	North 45°	1.8	EXT_WINDOW			1.2	0.6		
Boundary (identical)	-	3.2	BND_WALL			1.5	-		
Boundary (identical)	-	3.2	BND_WALL			1.5	-		
AN23_technique	-	7.2	ADJ_WALL			4.5	-		
AN24_stairs_2nd	-	5.6	ADJ_WALL			4.5	-		
AN12_bedroom02	-	7.2	ADJ_CEILING			2.5	-		
AN13_bedroom03	-	7.2	ADJ_CEILING			2.5	-		
air flow network									
link to air node	name	type	mass flow at 1PA <sup>b</sup>			ventilation	max opening		
			kg/s/m	kg/s/m <sup>2</sup>	comp [n] <sup>c</sup>	rate [l/h]	width [m]	height [m]	
EN22	CR21wi	crack, window	3.3e-5	-	0.6	-	-	-	-
	CR21rof	crack, roof	-	2.5e-3	0.59	-	-	-	-
	WI21wi	operable window	2e-5	-	0.7	-	0.9	0.9	
	TD_REG	register	-	-	-	studio <sup>f</sup>	-	-	
AN24_stairs_2 <sup>nd</sup>	Wlcrack	crack under door	5e-5	-	0.7	-	0.8	0.02	
	Wldoor	door	5e-5	-	0.7	-	0.8	2.3	
	Wlvent	operable vent	5e-5	-	0.7	-	0.8	0.2	
AN22_IN <sup>e</sup>	DS02	duct inlet	-	-	-	studio <sup>f</sup>	-	-	

a construction of separation walls as defined in Table App.D.2

b based on technical information obtained from Orme et al. (1998)

c air flow component [n] (Orme et al., 1998)

d auxiliary node for ductwork mechanical exhaust divided according to Figure App.D.3

e auxiliary node for ductwork mechanical supply variant divided according to Figure App.D.4

f air flow rate controlled in TRNSYS studio according to the variants of ventilation supply (Table App.D.17)

TABLE APP.D.12 Thermal zone connections and air link properties of the miscellaneous room at the entrance side of the attic

AN23_TECHNIQUE									
walls and windows									
adjacent to	orientation	area [m <sup>2</sup> ]	construction <sup>a</sup>			U-value [W/m <sup>2</sup> K]	G-value		
External	North 45°	7.9	EXT_ROOF			0.2	-		
External	South 45°	5.0	EXT_ROOF			0.2	-		
Boundary (identical)	-	11.5	BND_WALL			1.5	-		
AN24_stairs_2 <sup>nd</sup>	-	9.5	ADJ_WALL			4.5	-		
AN21_attic_back	-	9.3	ADJ_WALL			4.5	-		
AN22_attic_front	-	7.2	ADJ_WALL			4.5	-		
AN12_bedroom02	-	3.0	ADJ_CEILING			2.5	-		
AN14_bathroom	-	6.1	ADJ_CEILING			2.5	-		
air flow network									
link to air node	name	type	mass flow at 1PA <sup>b</sup>			ventilation max opening			
			kg/s/m	kg/s/m <sup>2</sup>	comp [n] <sup>c</sup>	rate [l/h]	width [m]	height [m]	
EN31b	CR23rob	crack, roof	-	2.5e-3	0.59	-	-	-	-
EN32b	CR23rof	crack, roof	-	2.5e-3	0.59	-	-	-	-
AN24_stairs_2 <sup>nd</sup>	WIcrack	crack under door	5e-5	-	0.7	-	0.8	0.02	
	WIdoor	door	5e-5	-	0.7	-	0.8	2.3	
	WIVent	operable vent	5e-5	-	0.7	-	0.8	0.2	
AN23 <sup>d</sup>	DS02	duct inlet	-	-	-	studio <sup>f</sup>	-	-	

a construction of separation walls as defined in Table App.D.2

b based on technical information obtained from Orme et al. (1998)

c air flow component [n] (Orme et al., 1998)

d auxiliary node for ductwork mechanical exhaust divided according to Figure App.D.3

e auxiliary node for ductwork mechanical supply variant divided according to Figure App.D.4

f air flow rate controlled in TRNSYS studio according to the variants of ventilation supply (Table App.D.17)

TABLE APP.D.13 Thermal zone connections and air link properties of the technique space on the second floor



AN24_STAIRS_2ND									
walls and windows									
adjacent to	orientation	area [m <sup>2</sup> ]	construction <sup>a</sup>	U-value [W/m <sup>2</sup> K]	G-value				
External	North 45°	6.3	EXT_ROOF	0.2	-				
External	South 45°	3.9	EXT_ROOF	0.2	-				
Boundary (identical)	-	11.5	BND_WALL	1.5	-				
AN21_attic_back	-	7.2	ADJ_WALL	4.5	-				
AN22_attic_front	-	5.6	ADJ_WALL	4.5	-				
AN23_technique	-	9.5	ADJ_WALL	4.5	-				
air flow network									
link to air node	name	type	mass flow at 1PA <sup>b</sup>			ventilation rate [1/h]	max opening		
			kg/s/m	kg/s/m <sup>2</sup>	comp [n] <sup>c</sup>		width [m]	height [m]	
EN31a	CR31awi	crack, window	3.3e-5	-	0.6	-	-	-	
	CR24rob	crack, roof	-	2.5e-3	0.59	-	-	-	
	WI31awi	operable window	2e-5	-	0.7	-	0.4	0.4	
EN32a	CR24rof	crack, roof	-	2.5e-3	0.59	-	-	-	
AN21_attic_back	Wlcrack	crack under door	5e-5	-	0.7	-	0.8	0.02	
	Wldoor	door	5e-5	-	0.7	-	0.8	2.3	
	Wlvent	operable vent	5e-5	-	0.7	-	0.8	0.2	
AN22_attic_front	Wlcrack	crack under door	5e-5	-	0.7	-	0.8	0.02	
	Wldoor	door	5e-5	-	0.7	-	0.8	2.3	
	Wlvent	operable vent	5e-5	-	0.7	-	0.8	0.2	
AN23_technique	Wlcrack	crack under door	5e-5	-	0.7	-	0.8	0.02	
	Wldoor	door	5e-5	-	0.7	-	0.8	2.3	
	Wlvent	operable vent	5e-5	-	0.7	-	0.8	0.2	
AN15_stairs_1 <sup>st</sup>	WI_stairs	open connection	-	-	-	-	1.2	3.7	

a construction of separation walls as defined in Table App.D.2

b based on technical information obtained from Orme et al. (1998)

c air flow component [n] (Orme et al., 1998)

d auxiliary node for ductwork mechanical exhaust divided according to Figure App.D.3

e auxiliary node for ductwork mechanical supply variant divided according to Figure App.D.4

f air flow rate controlled in TRNSYS studio according to the variants of ventilation supply (Table App.D.17)

TABLE APP.D.14 Thermal zone connections and air link properties of the traffic zone of the second floor

## Initial values

INITIAL VALUES		
operation		
ventilation [1/h]	1.25	(0.9 l/sm <sup>2</sup> )
schedule living room		heating setpoint
0:00 – 6:00	15 °C	cooling setpoint 30 °C
6:00 – 23:00	20.5 °C	25 °C
23:00 – 0:00	15 °C	30 °C
schedule bedroom		heating setpoint
0:00 – 7:00	18 °C	cooling setpoint 25 °C
7:00 – 23:00	15 °C	30 °C
23:00 – 0:00	18 °C	25 °C
internal gains		equipment
absence (occupancy schedule)	1 W/m <sup>2</sup>	people -
presence (occupancy schedule)	10 W/m <sup>2</sup>	75W *(amount of people present)

TABLE APP.D.15 Initial values for the calculated cases

## Reference situations

CASES					
thermal mass of adjacent walls		capacitance [J/kgK]		density [kg/m <sup>3</sup> ]	
low		840		525	
high		840		2500	
occupancy profiles (for full profile appendix A)	code	no. of people in household	occupancy rate	av. no. of peo- ple present	av. activity level
1 student	1_st	1	10%	1.26	2.5
couple both with job	2_w	2	18%	1.32	2.1
couple with 2 small children	4_sm	4	46%	1.70	2.4

TABLE APP.D.16 Cases for thermal mass level and occupancy profile

## Calculated variants

	HEATING & COOLING		VENTILATION				SHADING		
variants	code	(s) schedule (Table C.3) (p) presence	(hi/lo) setpoint and setback (ACA) Adaptive Comfort Algorithm (frame 2.1)	(+) cooling (-) no cooling	(a) adaptive (p) presence	ventilation rate registers [l/h]	(0) vents closed (1) vents open	(a) adaptive (p) presence	(0) no shading (1) full shading
reference	1_ref	s	hi/lo	+	-	1.25	0	-	0
adaptive heating	1a_ref	p	ACA	+	-	1.25	0	-	0
minimised ventilation	1b_ref	p	ACA	+	-	min-pres	0	-	0
minimised ventilation without cooling	1c_ref	p	ACA	-	-	min-pres	0	-	0
adaptive ventilation	2b_ventdyn	p	ACA	+	a	min-pres	0-1	-	0
adaptive ventilation without cooling	2c_ventdyn	p	ACA	-	a	min-pres	0-1	-	0
presence ventilation	2e_ventdyn	p	ACA	+	p	min-pres	0-1	-	0
presence ventilation without cooling	2f_ventdyn	p	ACA	-	p	min-pres	0-1	-	0
adaptive shading	3b_soldyn	p	ACA	+	-	min-pres	0	a	0-1
adaptive shading without cooling	3c_soldyn	p	ACA	-	-	min-pres	0	a	0-1
presence shading	3e_soldyn	p	ACA	+	-	min-pres	0	p	0-1
presence shading without cooling	3f_soldyn	p	ACA	-	-	min-pres	0	p	0-1
adaptive all	4b_dyn	p	ACA	+	a	min-pres	0-1	a	0-1
adaptive all without cooling	4c_dyn	p	ACA	-	a	min-pres	0-1	a	0-1
presence all	4e_dyn	p	ACA	+	p	min-pres	0-1	p	0-1
presence all without cooling	4f_dyn	p	ACA	-	p	min-pres	0-1	p	0-1

TABLE APP.D.17 Variants of control for heating and cooling, ventilation and solar gain

## Control mechanism for ventilation and solar shading

The control of the solar shading and the opening of the vents above the windows for extra ventilation is controlled by a thermostatic controller (type2b) per room with ON and OFF function controlled by a setpoint for the operative room temperature. The states are controlled as follows: The definition of type 2b is given by TRNSYS as follows (Solar-Energy-Laboratory, 2010);

*'...The on/off differential controller generates a control function which can have a value of 1 or 0. The value of the control signal is chosen as a function of the difference between upper and lower temperatures  $T_h$  and  $T_l$ , compared with two dead band temperature differences  $DT_l$  and  $DT_l$ . The new value of the control function depends on the value of the input control function at the previous timestep. The controller is normally used with the input control signal connected to the output control signal, providing a hysteresis effect. However, control signals from different components may be used as the input control signal for this component if a more detailed form of hysteresis is desired. For safety considerations, a high limit cut-out is included with this controller. Regardless of the dead band conditions, the control function will be set to zero if the high limit condition is exceeded. This controller is not restricted to sensing temperatures, even though temperature notation is used. This controller instance avoids reference to unit descriptions (degC, kg/hr, etc.) so that it can be used as a generic differential controller. This instance of the Type2 controller is intended for use with the standard TRNSYS SOLVER O (Successive Substitution)...'*

THERMOSTATIC CONTROL OF THE SOLAR SHADING AND VENT OPENING				
parameter	ON	OFF	Setpoint	Monitored
Shading factor ( $F_c$ )	$F_c = 1$	$F_c = 0$	$T_{\text{conf}} + 0.5$	$T_{\text{op}}$
Vent opening (open/closed)	open	closed	$T_{\text{conf}} + 1.5$	$T_{\text{op}}$

TABLE APP.D.18 Control values for thermostatic control of  $F_c$  and ventilation opening in TRNSYS



# Curriculum vitae



Noortje Alders was born February 26th, 1977 in Haarlem, The Netherlands. She graduated from the Faculty of Architecture of the Delft University of Technology with an MSc degree in building technology and architecture in 2003 and became a certified architect. For her graduation project she visited the city of La Habana, Cuba to research the sociology, climate and building practice.

From 2004 until 2007 she worked for various firms in the building industry as an architect and a building physicist.

In 2008 she started her PhD as a researcher at the Faculty of Architecture in Delft with the title "Adaptive Thermal Comfort Opportunities for Dwellings". Throughout her PhD research she was actively involved in the educational program of the Faculty of Architecture in Delft and building physics advice in practice.



# List of publications related to the PhD research

## 2011

**Alders, EE & Kurvers, SR.** Adaptive Principles for Thermal Comfort in Dwellings - From Comfort Temperatures to Avoiding Discomfort, Proceedings of PLEA 2011; Architecture and Sustainable Development, p.p. 601-606.

## 2010

**Kurvers, SR & Alders, EE.** Veranderende inzichten op thermisch comfort maken nieuwe modellen voor woningen en kantoren noodzakelijk. ISSO thematech, pp. 12-17.

**Alders, EE & Kurvers, SR.** Making the difference - Individual thermal comfort demand profiles for dwellings. In s.n. (Ed.), Proceedings of conference: Adapting to change: New thinking on comfort (pp. 1-12). London: NCEUB.

## 2009

**Alders, EE, Kurvers, SR & Cauberg, JJM.** Comfort delivery on demand: an adaptive approach to comfort systems in dwellings. In C Demers & A Potvin (Eds.), PLEA 2009; Architecture, energy and the occupant's perspective (pp. 1-6). Quebec, Canada: Universite Laval, Quebec, Canada.

**Alders, EE, Cauberg, JJM & Sinval, M.** Analyzing comfort system energy balances in time, place and level in adaptive dwellings in preparation for an energy organizer. In AAJF van den Dobbelen, A van Timmeren & M van Dorst (Eds.), SASBE2009; Building Smartly in a Changing Climate (pp. 1-8). Delft: Technische Universiteit Delft, faculteit Bouwkunde. (TUD)



