

## Maintenance Scheduling in Power Electronic Converters Considering Wear-out Failures

Peyghami, Saeed; Blaabjerg, Frede; Rueda Torres, José; Palensky, Peter

**DOI**

[10.23919/EPE20ECCEurope43536.2020.9215657](https://doi.org/10.23919/EPE20ECCEurope43536.2020.9215657)

**Publication date**

2020

**Document Version**

Final published version

**Published in**

2020 22nd European Conference on Power Electronics and Applications (EPE'20 ECCE Europe)

**Citation (APA)**

Peyghami, S., Blaabjerg, F., Rueda Torres, J., & Palensky, P. (2020). Maintenance Scheduling in Power Electronic Converters Considering Wear-out Failures. In *2020 22nd European Conference on Power Electronics and Applications (EPE'20 ECCE Europe)* (pp. P.1-P.10). IEEE. <https://doi.org/10.23919/EPE20ECCEurope43536.2020.9215657>

**Important note**

To cite this publication, please use the final published version (if applicable). Please check the document version above.

**Copyright**

Other than for strictly personal use, it is not permitted to download, forward or distribute the text or part of it, without the consent of the author(s) and/or copyright holder(s), unless the work is under an open content license such as Creative Commons.

**Takedown policy**

Please contact us and provide details if you believe this document breaches copyrights. We will remove access to the work immediately and investigate your claim.

***Green Open Access added to TU Delft Institutional Repository***

***'You share, we take care!' - Taverne project***

**<https://www.openaccess.nl/en/you-share-we-take-care>**

Otherwise as indicated in the copyright section: the publisher is the copyright holder of this work and the author uses the Dutch legislation to make this work public.

# Maintenance Scheduling in Power Electronic Converters Considering Wear-out Failures

Saeed Peyghami, Frede Blaabjerg  
Aalborg University  
Aalborg East 9220, Denmark  
Tel: +45 93562431/+45 21292454  
Email: sap@et.aau.dk  
fbl@et.aau.dk  
URL: <https://www.aau.dk/>

Jose Rueda Torres, Peter Palensky  
Delft University of Technology  
2628 CD Delft, The Netherlands  
Tel: +31 152786239 /+31 152788341  
Email: J.L.RuedaTorres@tudelft.nl  
P.Palensky@tudelft.nl  
URL: <https://www.tudelft.nl/>

## Acknowledgements:

This work was supported by VILLUM FONDEN under the VILLUM Investigators Grant called REliable Power Electronic-based Power Systems (REPEPS).

## Keywords:

«Reliability», «Power electronics», «Maintenance», «Mission profile», «Modeling», «PV System».

## Abstract:

Power electronic converters are one of failure sources in energy systems, and hence drivers of downtime costs in power systems. Different approaches can be employed for converter reliability enhancement including design/control for reliability methods, condition monitoring and fault diagnosis, and maintenance strategies. This paper proposes optimal preventive maintenance strategies based on wear-out failure model of converter components. The proposed approaches employ two different performance measures at converter-level and system-level. The converter-level measures take into account planned and unplanned maintenance times or costs in a single unit or small-scale system. Moreover, the system-level measure considers not only maintenance times, but also energy losses and additional maintenance costs induced by aging of the converter components. The outcome is optimal replacement time of converter and its components, which depends on the employed performance measure. Optimal replacement scheduling is of importance for risk management and decision-making during planning of modern power electronic based power systems. The applicability of the proposed approaches is illustrated by numerical analysis in a photovoltaic system.

## Introduction

Power electronic converters are increasingly used in power systems in a wide range of applications. They are underpinning components of new technologies such as renewable energies, e-mobility, and electronic transmission systems, which are facilitating grid modernization and economization. However, they are one of the frequent source of failure and driver of downtime costs in most of the applications [1]–[10]. This will even be more severe with the global moving trend towards 100% renewable energy systems. According to field data, power converters have almost 20% contribution on unplanned downtime in wind turbine systems [10], and unplanned downtime costs introduced by power converters in Photovoltaic (PV) systems [7] is almost 60% as it is shown in Fig. 1. Thus, reliability of power electronic converters is of paramount importance for economic planning and operation of power electronic based power systems [11].

Power electronic reliability engineering is mainly dedicated to two major concepts including reliability modeling and reliability enhancement. The converter reliability modeling has conventionally been performed based on handbooks mainly originated from MIL-HDBK-217 [12]. However, recent achievements in power electronics engineering indicate that the handbook data cannot properly model the converter reliability since they do not consider physics of failures. Therefore, stress-strength analysis is employed to model the wear-out failure of converter fragile components under given operating conditions considering physics of failures [9], [13].

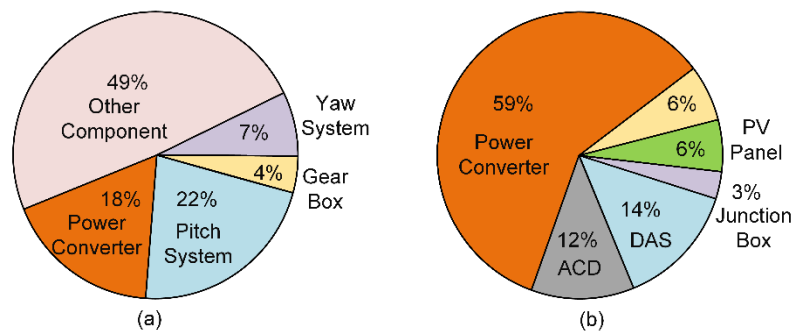

Fig. 1. Reliability field data of renewable energy systems: (a) Contribution of sub-systems and assemblies to the overall downtime of wind turbines [14]. (b) Unscheduled maintenance costs by sub-system in PV systems [6] - ACD: AC Disconnects, DAS: Data Acquisition Systems.

Furthermore, the converter reliability enhancement can be carried out in three hierarchical levels: device, converter and system [15]. At the device-level, lifetime modeling of failure prone components considering the physics of potential failure mechanisms are explored in order to produce high reliable devices. The converter-level analysis is associated with design for reliability approaches and mission profile analysis in order to design high reliable converters by selecting appropriate components. Moreover, active thermal management approaches at converter-level, such as adaptive switching frequency and reactive power control, can improve the converter reliability. Furthermore, the system-level efforts can be performed at the planning phase by a suitable converter sizing, and in the operation phase by appropriate control strategies [15]. These reliability enhancement techniques aim to extend the lifetime of converter fragile components, consequently decreasing converter failure rate.

However, converters are operated in a power system being responsible for supplying customers for a long time. The long time performance of a power electronic based power system can be measured by system-level reliability indices such as time-based or production based unavailability, Loss Of Load Expectation (LOLE), Expected Energy Not Supplied (EENS), Expected Energy Not Produced (EENP), and so on [16]–[18]. According to reliability modeling in power systems, the system-level reliability depends on the converter availability [16], which is associated with both failure probability and maintenance actions. Therefore, the converter availability can be retained at an acceptable level by decreasing its failure rate and/or proper maintenance strategies. Thus, beyond the techniques to decrease the failure probability, appropriately maintaining the converter will improve its availability.

This paper proposes a model-based preventive maintenance scheduling for converters considering aging failure of their components operating under a given mission profile. The proposed strategies rely on the planned and unplanned maintenance times and costs, energy losses and saving of the interest of the capital investment due to delaying replacement. The maintenance strategies can rely on converter-level performance measures, which can optimize the planned and unplanned maintenance time or cost. Moreover, it can rely on the system-level performance measure, which is associated with the energy losses induced by aging of converter components. These two approaches are explored in this paper. The outcome is an optimal replacement time for the converter and its components based on their aging reliability model and the performance measure. The optimal replacement time can be used for economical decision-making in power system during design and planning.

The remainder of this paper is structured as follows. First, the basic concept of maintenance in power systems is presented. Next, the proposed maintenance strategies are presented. Moreover, the numerical analysis using a PV system is provided. Finally, the outcomes are summarized in the last section.

## Basic Concepts of Maintenance

Generally, the maintenance policies of systems can be classified into two major categories including corrective and preventive maintenance approaches as shown in Fig. 2. The corrective maintenance is applied for an item once a failure occurs. Therefore, after failure detection, the item will be repaired or replaced by another one, or its deficiency is compensated by a stand-by unit. Since the item outage will affect its availability and increase the system risk, in practice, the failure occurrence is prevented by a suitable preventive maintenance strategy.

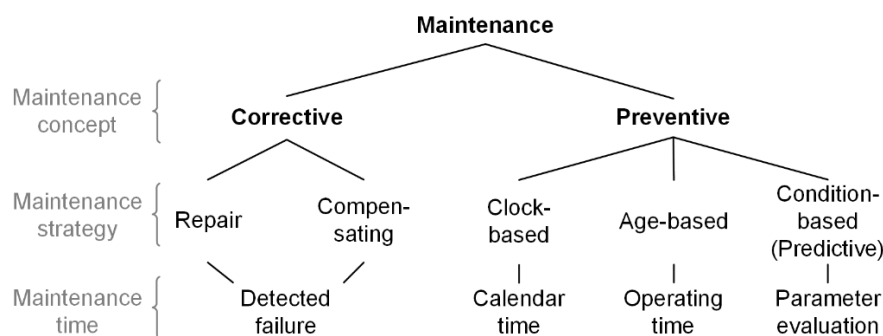

Fig. 2. Different maintenance strategies in power systems [19].

The preventive maintenance strategies can be performed periodically at predefined clock-based times, at age-based times or at condition-based times. The clock-based maintenance is carried out at specified calendar times; hence, it can easily be scheduled especially for large scale systems. The age-based maintenance policies are performed at specified age of the item such as a number of cycles to failure for a power module. The condition-based maintenance is performed based on measurements of item deterioration variables such as on-state voltage of a power module, or capacitance of an electrolytic capacitor. The maintenance will be carried out once the measured variable approaches or passes a certain threshold value. If the condition variable is associated with the consumed lifetime of the item, the term predictive maintenance is usually employed instead of condition-based maintenance.

In the clock-based maintenance, the item will be replaced at prespecified time intervals regardless of its aging. This strategy can easily be performed especially for a large-scale system. However, in most cases, new items must be replaced at the scheduled times. Consequently, this approach is not a cost-effective maintenance strategy. On the other hand, the condition-based strategy requires measuring a deterioration variable, which in large scale systems may introduce higher monitoring costs. This strategy is, hence, applicable for the systems with higher downtime costs, production loss or personal damage.

Power electronic converters are widely used in different applications in power system. They may induce higher downtime and maintenance costs, production loss and personal injury at system-level such as in on-shore wind turbines and more electric aircrafts if not properly designed. Therefore, condition-based maintenance is applicable for these applications. Furthermore, in some applications such as PV parks, the condition-based maintenance may be an expensive approach, while other preventive maintenances can be performed to improve the system reliability. In this paper as presented in the next section, the age-based maintenance is employed for converter maintenance scheduling. The converters most fragile components including power modules and capacitors are usually replaced once a failure occurs. Therefore, an optimal replacement time must be predicted in order to improve the converter and system long-term performance. The replacement time can be found by minimizing the replacement costs, system unavailability, and energy losses.

## The Proposed Maintenance Planning Process

The proposed maintenance planning process relies on a mission profile-based reliability prediction approach using stress-strength analysis of the converters [12]. The flow chart of the proposed maintenance approach is shown in Fig. 3. Following this approach, the converter wear-out failure probability can be predicted by a stress-strength analysis considering the physics of failures for the most fragile components. Therefore, the mission profiles such as ambient temperature, humidity, solar irradiance, and wind speed should be transformed to the electro-thermal stress of the converter devices. Afterwards, the wear-out failure probability will be estimated according to the lifetime model of devices. The wear-out failure probability function is used to do maintenance planning in converters based on a desired maintenance strategy. Depending on the application and functionality of the unit, converter-level or system-level performance measure will be selected. Then, the optimal maintenance time can be predicted.

According to this approach, using the reliability model based on mission profile analysis will introduce more accurate estimation of replacement time of converter components. Therefore, the proposed approach can effectively be used for maintenance planning and economic decision-makings in power electronic based power systems. In the following, the wear-out failure probability prediction is presented in sub-section (A). Moreover, the maintenance planning policies are explained considering converter- and system-level measures in sub-sections (B) and (C).

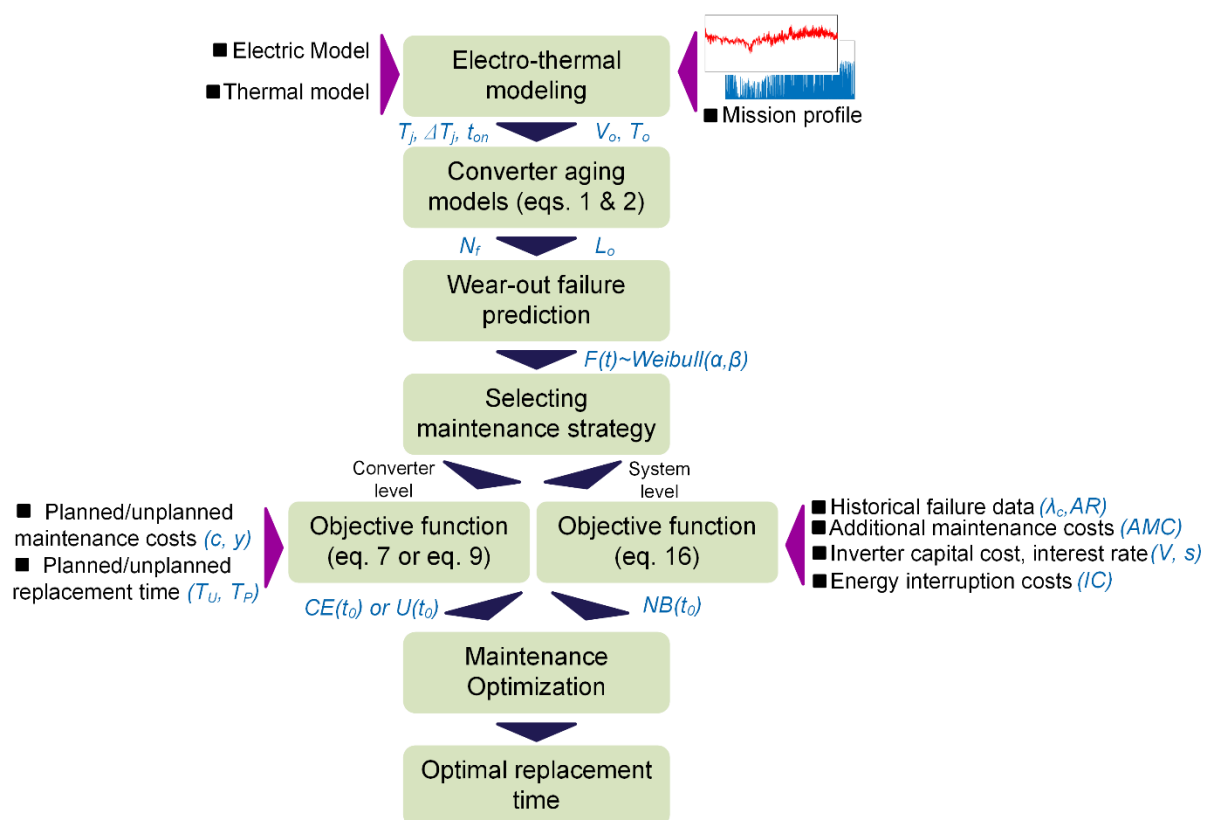

Fig. 3. Proposed maintenance scheduling process in power electronic converters operated in power systems.

### A. Prediction of power converter aging reliability

A power converter reliability can be predicted by its vulnerable components reliability. Following field data and industrial experiences, the power modules and capacitors are the most fragile components of converters [20]. They are prone to wear-out failures consequently limiting converters lifetime [12]. The lifetime model of electrolytic capacitors can be modeled by [21]:

$$L_o = L_r \cdot 2^{-n_1} \left( \frac{V_o}{V_r} \right)^{-n_2} \quad (1)$$

where,  $L_r$  is the rated lifetime under the rated voltage  $V_r$  and rated temperature  $T_r$ , and  $L_o$  is the capacitor lifetime under operating voltage  $V_o$  and operating temperature  $T_o$ . The exponents of  $n_1$  and  $n_2$  are provided in [21]. Furthermore, the number of cycles to failure,  $N_f$  in power modules are obtained by using [22]:

$$N_f = A \cdot \Delta T_j^\alpha \cdot \exp\left(\frac{\beta}{T_{jm} + 273}\right) \cdot \left(\frac{t_{on}}{1.5}\right)^{-0.3} \quad (2)$$

where,  $\Delta T$  and  $T$  are the junction temperature swing and its mean value in the power module, and  $t_{on}$  is the rise time of temperature cycle. The constants of  $A$ ,  $\alpha$ , and  $\beta$  can be obtained from aging tests.

The lifetime models in (1) and (2) depend on the temperature and voltage of devices. Since the temperature and voltage at different operating conditions are not identical, the total lifetime of a device should be estimated considering the applied mission profile. Then, the mission profile should be translated into voltage and temperature over the devices. The obtained voltage and temperature profiles can thus be transformed to the device lifetime. This lifetime is based on the mean values of the device electro-thermal parameters and lifetime model variables. In practice, the device electro-thermal parameters and lifetime models variables are facing uncertainties. Thus, the device lifetime distribution can be obtained by Monte Carlo simulations taking into account the manufacturing and model uncertainties. Therefore, the reliability of power modules and capacitors can be predicted under given mission profile employing the Monte Carlo simulations. This procedure has been presented in [13], [15]. Since, the predicted lifetime is based on stress-strength analysis corresponding to the potential failure mechanisms of the device, the obtained reliability function represents the wear-out failure probability [12]. The wear-out failure probability can be presented by the Weibull distribution as:

$$F(t) = 1 - e^{-\left(\frac{t}{\alpha}\right)^\beta} \sim (\alpha, \beta) \quad (3)$$

where,  $F(t)$  is the failure Cumulative Distribution Function (CDF), and  $(\alpha, \beta)$  denote the scale and shape factors of the Weibull distribution function.

### B. Maintenance planning using converter-level measures

This sub-section presents two converter-level performance measures for optimal scheduling of converter maintenance based on an age-replacement preventive maintenance strategy. The first measure is associated with the planned and unplanned maintenance costs, where a cost-efficiency measure is employed to find the optimal maintenance time. Furthermore, the second measure takes into account the planned/unplanned maintenance times in order to optimize the converter availability. Both measures are discussed in the following.

According to the age-replacement policy, the item will be replaced upon failure or at a pre-specified age  $t_0$ , whichever comes first. Therefore, the mean time between replacements,  $T_R(t_0)$  can be obtained by using (4), where  $f(t)$  denotes the aging failure Probability Density Function (PDF).

$$T_R(t_0) = \int_0^{t_0} t f(t) dt + t_0 \cdot \Pr(T \geq t_0) = \int_0^{t_0} (1 - F(t)) dt \quad (4)$$

If a failure does not happen within the replacement interval  $t_0$ , the planned replacement cost will be  $c$ . Moreover, an unplanned failure occurrence before  $t_0$  will induce extra maintenance/production loss costs of  $y$ . Therefore, the total mean replacement Costs per Time unit  $CT(t_0)$  can be obtained by using (5).

$$CT(t_0) = \frac{c + y \cdot F(t_0)}{T_R(t_0)} \quad (5)$$

In the case of very large replacement intervals, the mean replacement costs will be:

$$CT(\infty) = \frac{c + y}{MTTF} \quad (6)$$

where,  $MTTF$  denotes the Mean Time To Failure of failure CDF, which is equal to  $MTTF = T_R(\infty)$ . A Cost Efficiency measure  $CE(t_0)$  can thus be defined as [19]:

$$CE(t_0) = \frac{CE(t_0)}{CE(\infty)} = \frac{1 + r \cdot F(t_0)}{1 + r} \frac{MTTF}{\int_0^{t_0} (1 - F(t)) dt} \quad (7)$$

where  $r = y/c$ . A low value of  $CE(t_0)$  implies a high cost efficiency.

In the case, the converter availability is more important than the maintenance costs, such as in traction applications, the unavailability-based age replacement policy can be carried out. The mean downtime of an item  $T_D(t_0)$  with an age replacement policy at an age of  $t_0$  can be obtained as:

$$T_D(t_0) = T_U \cdot F(t_0) + T_P \cdot (1 - F(t_0)) = T_P \cdot (1 + (k - 1)F(t_0)) \quad (8)$$

where,  $T_P$  is a mean planned downtime,  $T_U$  is a mean unplanned downtime due to a failure occurrence within  $t_0$ , and  $k = T_U/T_P$ . Therefore, the unavailability of the system  $U(t_0)$  with an age replacement policy is defined as [19]:

$$U(t_0) = \frac{T_D(t_0)}{T_R(t_0) + T_D(t_0)} = \frac{T_P \cdot (1 + (k - 1)F(t_0))}{T_R(t_0) + T_P \cdot (1 + (k - 1)F(t_0))} \quad (9)$$

A low value of unavailability indicates a high performance of the item. The minimum of  $U(t_0)$  can be obtained by solving (10), where  $\partial$  denotes the derivative operator. According to (10), the optimal replacement time depends on the failure probability function and  $k$  factor, while it is independent of the mean planned downtime  $T_P$ .

$$\frac{\partial U(t_0)}{\partial t_0} = \frac{T_P}{(T_R(t_0) + T_D(t_0))^2} \left( T_R(t_0)(k - 1) \frac{\partial F(t_0)}{\partial t_0} - (1 + (k - 1)F(t_0)) \frac{\partial T_R(t_0)}{\partial t_0} \right) = 0 \quad (10)$$

In order to have optimal operation of converters in power systems, the optimal replacement time of converter components can thus be predicted based on the applied mission profile and cost-efficiency or unavailability criterion.

### C. Maintenance planning using system-level measures

The converter impact on the power system performance is measured by its unavailability during its operation period [18]. A converter is prone to different failures including random chance and aging failures [18]. Thus, it may be unavailable due to either random chance failures or aging failures. The converter unavailability due to the random chance failures can be obtained by (11) using Markov process [16].

$$U_c \approx \lambda_c \cdot ART \quad (11)$$

where,  $\lambda_c$  is the constant failure rate due to random chance failures [18],  $ART$  is the average maintenance time, and  $U_c$  is the unavailability due to random chance failures. On the other hand, the converter wear-out unavailability cannot be obtained by (11) due to the fact that the Markov process is solely applicable for systems with a constant failure rate. Hence, other approaches such as method of device of stages, semi-Markov technique, and a piece-wise approach can be employed [23], [24]. In this paper, the piece-wise approach is used where the failure rate function

is discretized into short time slots, and the failure rate is assumed to be constant in each time slot. Thus, the unavailability can be predicted using Markov process for each time slot as given in (12).

$$U_w(t_0) \approx \lambda_w(t_0) \cdot ART \quad (12)$$

where,  $\lambda_w(t_0)$  and  $U_w(t_0)$  are the wear-out failure rate and unavailability due to wear-out failures at year of  $t_0$ . Therefore, the total converter unavailability can be obtained by (13) [18].

$$U_t(t_0) = U_c + U_w(t_0) - U_c \cdot U_w(t_0) \quad (13)$$

In order to obtain the impact of converter wear-out on the overall system performance, the energy loss can be obtained by using appropriate system-level reliability indices. The energy loss can be calculated by LOL, EENS, EENP, time-based or production based unavailability and so on [16]–[18]. Obviously by delaying the planned maintenance, the aging failure rate, and consequently, the unit unavailability will be increased. Therefore, the energy loss will be increased as well. The Accumulated Damage Cost (*ADC*) due to the delaying of the planned maintenance by  $t_0$  years can be obtained by (14).

$$ADC(t_0) = \sum_{i=1}^{t_0} (Loss(U_t(t_0)) - Loss(U_c)) \cdot IC \quad (14)$$

where,  $Loss(\cdot)$  presents the overall energy loss and  $IC$  denotes the interruption costs per unit energy loss. Thus, delaying the planned replacement by  $t_0$  years, the *ADC* will be increased. In order to obtain the energy loss, the reliability modeling techniques [16], [17] can be adopted. The LOL and EENS can be used for load point loss prediction, and EENP, time-based or production-based availability can be used for renewable generation loss prediction. Therefore, the impact of aging on the system level performance can properly be modeled.

However, delaying the maintenance may introduce two other outcomes. The first one is the saving induced by the interest of the capital investment required by converter replacement. The second one is the additional maintenance costs of an aged converter. Thus, the benefit of delaying of replacement can be obtained by (15) [17].

$$B(t_0) = \sum_{i=1}^{t_0} (1+s)^{i-1} \cdot s \cdot V - t_0 \cdot AMC \quad (15)$$

where,  $V$  is the capital investment for converter replacement,  $s$  is the interest rate,  $AMC$  is the additional maintenance costs. considering the benefits and damage costs of delaying converter planned maintenance, the Net Benefit (*NB*) will be:

$$NB(t_0) = B(t_0) - ADC(t_0) \quad (16)$$

Thus, the optimum time of converter replacement will be the arguments of the maxima of  $NB(t_0)$ . In the next section, the proposed maintenance planning approaches are applied to a PV inverter, and the optimal maintenance time is predicted considering the converter-level and system-level measures.

## Analysis Using a PV Inverter in a Power System

In this section, the proposed preventive maintenance strategies are applied for a PV system. The structure of the grid-connected PV system is shown in Fig. 4. The PV system includes a 100-kW central inverter and its parameters are summarized in Table I. In the following, the aging failure probability of PV inverter is predicted. Then, the proper maintenance scheduling based on the converter-level and system-level measures are explored.

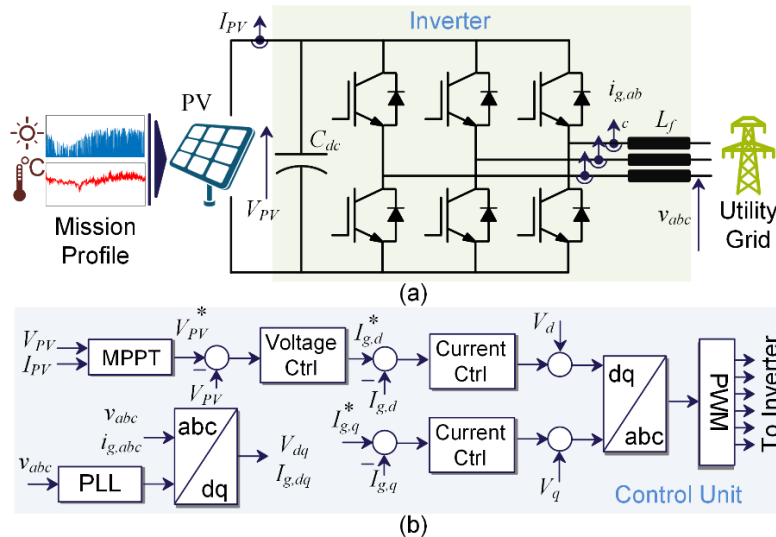

Fig. 4. Structure of the 100-kW central PV inverter; (a) inverter topology, and (b) inverter control unit.



TABLE I. Specifications of the 100-kW central PV Inverter.

Parameter	Symbol	Value	Parameter	Symbol	Value
Rated Power of Inverter	$P$ (kW)	100	Current Control	$k_p + k_i/S$	$2 + 5/S$
Switching Frequency	$f_{sw2}$ (kHz)	5	PV Panel Rated Power	$P_r$ (W)	280
DC Bus Voltage	$V_{PV}$ (V)	400-950	Open Circuit Voltage	$V_{oc}$ (V)	47.2
AC Grid Voltage	$V_{abc}$ (V <sub>rms</sub> )	480	Short Circuit Current	$I_{sc}$ (A)	8.21
AC Grid Frequency	$f_g$ (Hz)	50	MPPT Voltage	$V_m$ (V)	38.5
Inverter filter	$L_f$ (mH)	4.5	MPPT Current	$I_m$ (A)	7.53
Power module	FF225R12ME4_B11		Voltage temp. Coefficient	$\alpha$ (V/K)	-0.1230
DC Bus Capacitor (EPCOS)	$C_{dc}$ $2 \times (6 \times 390) \mu F, 500 V, 5.23 A$		Current temp. Coefficient	$\beta$ (A/K)	0.0032
MPPT Algorithm	Perturb & Observation		Number of Series panels	$N_s$	22
Voltage Control	$k_p + k_i/S$	$1.2 + 25/S$	Number of Parallel panels	$N_p$	16

### A. Reliability of PV inverter

The PV inverter reliability is predicted based on the stress-strength analysis presented in previous section. For this purpose, the measured solar irradiance ( $I_{rr}$ ) and ambient temperature profiles are employed, which are shown in Fig. 5 (a) and (b) respectively. After applying the stress-strength analysis to the inverter fragile components, i.e., power module and capacitor bank given in Table I, their wear-out failure probability is predicted.

The wear-out CDF for the power module and capacitor bank is shown in Fig. 6. They are represented by the Weibull distribution function. Notably, under the given mission profile in Fig. 5, the power module is exposed to wear-out much faster than the capacitor bank. Therefore, the overall inverter reliability due to the aging of its fragile components is dominated by the power module failure probability as shown in Fig. 6. Notably, this is an illustrative case study to show the impact of mission profile analysis on the maintenance planning of converters. In practice, the wear-out of power modules may happen after 10 to 20 years based on design characteristics. This fact is associated with the design for reliability in a converter to obtain a desired reliability. Since the purpose of this paper is to improve the reliability by proper maintenance actions, the design criteria are not taken into account. Thus, the designed inverter is not an optimal system. The obtained failure probability of converter components under operating conditions is used for maintenance planning in the following.

### B. Maintenance planning: converter-level measure

In this sub-section, the converter-level measures are used for optimal replacement planning of the power module and the capacitor bank. To do so, the cost efficiency and unavailability functions are plotted in terms of replacement time of  $t_0$ . The optimal replacement time based on the unavailability of the capacitor bank and power module is shown in Fig. 7 for different values of  $k = T_U/T_p$ . Following Fig. 7, for  $k = 1$ , which denotes the same planned and unplanned downtime, the optimal replacement policy is corrective maintenance. However, for the unplanned downtime higher than the planned downtime, preventive replacement is required to minimize the converter unavailability. For instance, if  $k = 3$ , the optimal preventive maintenance time is every 9.1 years for capacitor bank and 5.2 years for power module as shown in Fig. 7 (a) and (b) respectively.

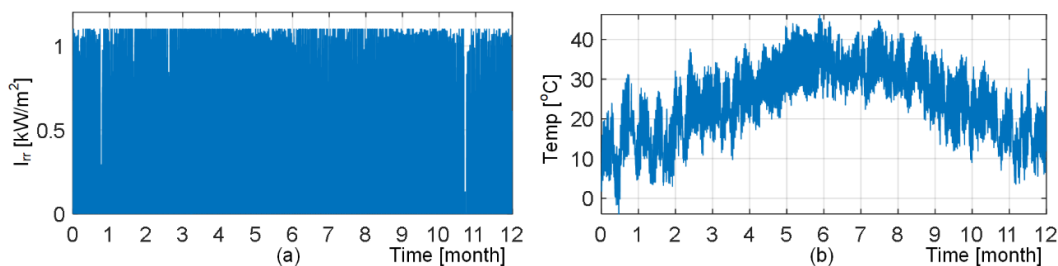

Fig. 5. Climate conditions for PV system: (a) solar irradiance ( $I_{rr}$ ) and (b) ambient temperature (Temp).

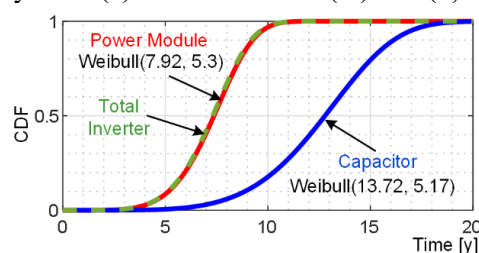

Fig. 6. Wear-out failure Cumulative Distribution Function (CDF) of power modules and capacitor bank.

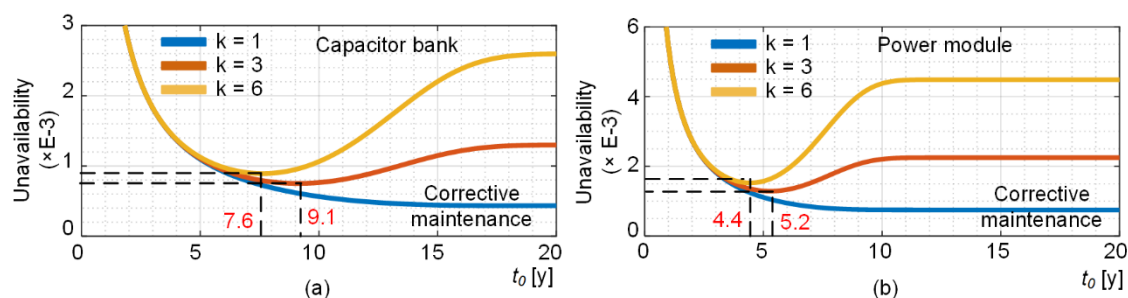

Fig. 7. Converter unavailability due to the delaying planned replacement time ( $t_0$ ) of (a) capacitor bank, and (b) power module.

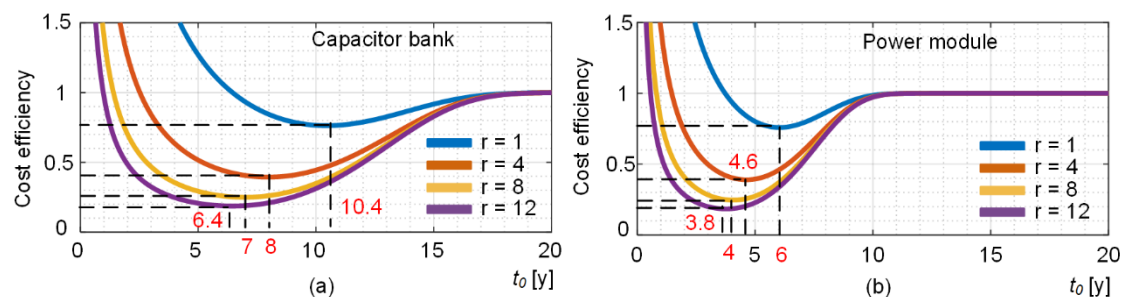

Fig. 8. Cost efficiency of the converter due to the delaying planned replacement time ( $t_0$ ) of (a) capacitor bank, and (b) power module.

Furthermore, Fig. 8(a) shows the cost efficiency of capacitor bank replacement for different  $r = y/c$  values. It is obvious that the optimal replacement time depends on the  $r$  value, where by increasing the  $r$  value, the optimal replacement time will be decreased. For instance, if  $r = 4$ , the optimal preventive replacement time for capacitor bank under given mission profile is every 8 years as shown in Fig. 8(a). Moreover, the cost efficiency of the power module is shown in Fig. 8(b). Like capacitor bank, the optimal replacement time depends on the maintenance policy and  $r$  or  $k$  ratios. For instance, the optimal replacement time according to the cost efficiency measure is every 4.6 years for  $r = 4$  as shown in Fig. 8(b).

The obtained results in Fig. 7 and Fig. 8 show that the preventive replacement time at the converter-level depends on the performance measure such as cost efficiency measure and unavailability. Furthermore, the ratio of planned and unplanned replacement costs as well as the ratio of planned and unplanned down time will affect the preventive maintenance scheduling. Moreover, the replacement time of devices depends on the failure probability function under given mission profile. For instance, the cost efficiency-based replacement time considering  $r = 1$ , for capacitor bank is 10.4 years following Fig. 8 (a) and for power module is 6 years according to Fig. 8(b). As a result, proper maintenance scheduling in power converters requires mission profile analysis in order to predict the wear-out failure probability of devices, and consequently, scheduling for the optimal preventive replacement.

### C. Maintenance planning: system-level measure

The optimal maintenance time based on converter-level measures is suitable for single unit systems and small-scale cases. However, the converters are increasingly used in grid applications such as renewable power plants. Therefore, system-level measures are of paramount importance for maintenance planning in such cases. In the following case study, it is assumed that the studied PV inverter is one unit out of a large-scale PV power plant. The PV array data are summarized in Table I. For cost analysis, the inverter capital cost is considered \$6000, and the interest rate is 5%. The converter constant failure rate due to the random chance failures is 0.1 failure per year, and its aging failure probability is shown in Fig. 6. In order to obtain the system-level impact of converter aging, the EENP by the PV system is considered as the energy loss in (14). It is assumed that each 100-kW PV units generates 500 kWh energy per day in average according to the given mission profile in Fig. 5. In the following, the net benefit function in (16) is plotted in terms of delayed planned maintenance time  $t_0$  and the results are reported in Fig. 9 – Fig. 11. Fig. 9 shows the net benefit due to the delaying the planned maintenance time for two different interruption costs of  $IC = 0.2$  \$/kWh and  $IC = 0.5$  \$/kWh. If the interruption cost is 0.2 \$/kWh, then the optimal replacement should be planned for the 8<sup>th</sup> year as shown in Fig. 9. However, by increasing the interruption cost to 0.5 \$/kWh, the planned maintenance time will be at the 6<sup>th</sup> year of operation. Therefore, by increasing the interruption costs, the replacement should be carried out faster.

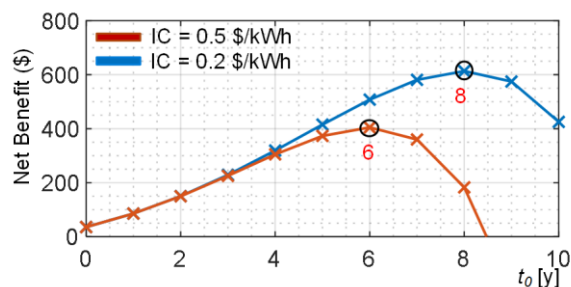

Fig. 9. Interruption Cost ( $IC$ ) impact on the net benefit due to delaying the converter replacement of the by  $t_0 - AMC = 250$  \$/kWh,  $ART = 2$  days.

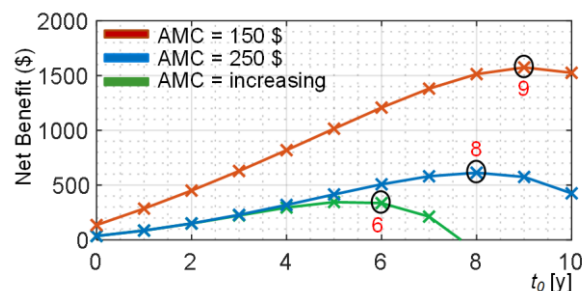

Fig. 10. Additional Maintenance Cost ( $AMC$ ) impact on the net benefit due to delaying the converter replacement by  $t_0 - IC = 0.2$  \$/kWh,  $ART = 2$  days.

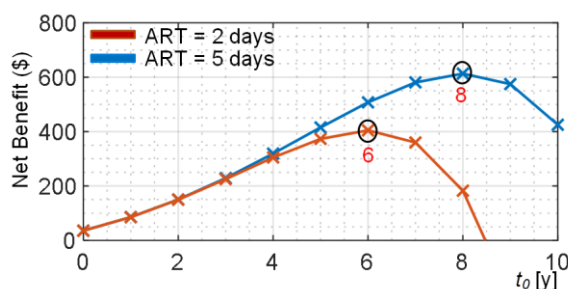

Fig. 11. Average Repair Time ( $ART$ ) impact on the net benefit due to the delaying the converter replacement by  $t_0 - IC = 0.2$  \$/kWh,  $AMC = 250$  \$.

The impact of additional maintenance cost ( $AMC$ ) on the net benefit is shown in Fig. 10. The optimal maintenance time with the additional maintenance cost of  $AMC = 150$  \$ is 9 years, while for the  $AMC = 250$  \$ it is 8 years. Moreover, in practice the additional maintenance cost can increase by increasing the failure rate. Considering  $AMC(t_0) = 250 + 500 \times [\lambda(t_0) - \lambda(0)]$ , the net benefit is shown with green graph in Fig. 10. The optimal maintenance time is 6 years for the case that the  $AMC$  is increasing. It is shown in Fig. 10 that the additional maintenance cost will have a remarkable impact on the planned maintenance time of converter.

Moreover, the impact of average repair time for two cases of  $ART = 2$  and 5 days is shown in Fig. 11. It is shown that by increasing the repair time, the replacement should be performed 2 years sooner than for  $ART = 2$  days. This is due to fact that increasing the repair time will increase the converter unavailability based on eqs. (11) and (12).

## Discussion, Conclusion and Future Works

This paper has proposed a preventive maintenance scheduling process for converters employing a mission profile-based wear-out failure prediction approach. According to the proposed approach, optimal replacement of converters can be carried out based on wear-out reliability model of their components. As a result, maintenance time can be precisely predicted for the given operating conditions. This will facilitate economic decision-making in planning of power electronic based power systems and improve the overall system performance. The proposed maintenance strategy takes into account different aspects of maintenance including planned and unplanned maintenance times and costs, energy loss, saving of the interest due to the capital investments of replacement and so on. Two measures at the converter-level and system-level are introduced. The converter-level measure optimizes the planned/unplanned maintenance times or costs. Furthermore, the system-level measure is associated with the energy induced by converter aging. The first measure is more applicable for a single unit system or small-scale power system. Moreover, the system-level measure is more suitable for the maintenance planning in large-scale power electronic based power systems.

The proposed approach is applied for a PV system using a 100-kW grid-connected inverter. The optimal replacement times of the inverter and its fragile components have been obtained using the converter and system-level measures. The obtained results show that the replacement time depends on the device lifetime, where the replace time of the capacitor bank is longer than the power module. Moreover, the replacement strategy, ratio of unplanned to planned replacement costs ( $r$ ), and ratio of unplanned to planned downtime ( $k$ ), additional maintenance costs ( $AMC$ ), and interruption costs ( $IC$ ) remarkably affect the optimal replacement time. For instance, employing the cost-efficiency measure, the optimal replacement time of the converter is 6 years for the case of  $r = 1$  and 4 years for the case of  $r = 8$ . On the other hand, using the system-level measure, the optimal replacement time is 8 years for

the case of  $IC = 0.2$  \$/kWh,  $AMC = 250$  \$ and average maintenance time of 2 days. Therefore, depending on the converter application and its functionality in the system, appropriate maintenance measures can be employed, and then, the optimal maintenance time can be obtained. For future works, optimal maintenance planning of multi-converter systems considering different applications and mission profiles will be explored.

## References

- [1] S. Yang, A. Bryant, P. Mawby, D. Xiang, L. Ran, and P. Tavner, "An Industry-Based Survey of Reliability in Power Electronic Converters," *IEEE Trans. Ind. Appl.*, vol. 47, no. 3, pp. 1441–1451, May 2011.
- [2] J. Ribrant and L. M. Bertling, "Survey of Failures in Wind Power Systems With Focus on Swedish Wind Power Plants During 1997–2005," *IEEE Trans. Energy Convers.*, vol. 22, no. 1, pp. 167–173, Mar. 2007.
- [3] K. Fischer, K. Pelka, A. Bartschat, B. Tegtmeier, D. Coronado, C. Broer, and J. Wenske, "Reliability of Power Converters in Wind Turbines: Exploratory Analysis of Failure and Operating Data from a Worldwide Turbine Fleet," *IEEE Trans. Power Electron.*, vol. 34, no. 7, pp. 6332–6344, 2018.
- [4] X. Liu and S. Islam, "Reliability Issues of Offshore Wind Farm Topology," *Int. Conf. Probabilistic Methods Appl. To Power Syst.*, pp. 523–527, 2008.
- [5] G. J. W. Van Bussel and M. B. Zaaijer, "DOWEC Concepts Study, Reliability, Availability and Maintenance Aspects," *Eur. Wind Energy Conf.*, no. July, pp. 557–560, 2001.
- [6] L. M. Moore and H. N. Post, "Five Years of Operating Experience at a Large, Utility-Scale Photovoltaic Generating Plant," *Prog. Photovoltaics Res. Appl.*, vol. 16, no. 3, pp. 249–259, 2008.
- [7] G. Zini, C. Mangeant, and J. Merten, "Reliability of Large-Scale Grid-Connected Photovoltaic Systems," *Renew. Energy*, vol. 36, no. 9, pp. 2334–2340, 2011.
- [8] A. Golnas, "PV System Reliability: An Operator's Perspective," *IEEE J. Photovoltaics*, vol. 3, no. 1, pp. 416–421, 2013.
- [9] H. S. Chung, H. Wang, F. Blaabjerg, and M. Pecht, "Reliability of Power Electronic Converter Systems," First Edi. London: IET, 2016.
- [10] K. Fischer, F. Besnard, and L. Bertling, "Reliability-Centered Maintenance for Wind Turbines Based on Statistical Analysis and Practical Experience," *IEEE Trans. Energy Convers.*, vol. 27, no. 1, pp. 184–195, Mar. 2012.
- [11] S. Peyghami, P. Palensky, and F. Blaabjerg, "An Overview on the Reliability of Modern Power Electronic Based Power Systems," *IEEE Open J. Power Electron.*, vol. 1, pp. 34–50, Feb. 2020.
- [12] S. Peyghami, Z. Wang, and F. Blaabjerg, "Reliability Modeling of Power Electronic Converters: A General Approach," in *Proc. IEEE COMPEL*, 2019, pp. 1–7.
- [13] S. Peyghami, Z. Wang, and F. Blaabjerg, "A Guideline for Reliability Prediction in Power Electronic Converters," *IEEE Trans. Power Electron.*, no. 10.1109/TPEL.2020.2981933, pp. 1–9, 2020.
- [14] M. Wilkinson and B. Hendriks, "Report on Wind Turbine Reliability Profiles," *Reliawind*, 2011.
- [15] S. Peyghami, P. Davari, and F. Blaabjerg, "System-Level Reliability-Oriented Power Sharing Strategy for DC Power Systems," *IEEE Trans. Ind. Appl.*, vol. 55, no. 5, pp. 4865–4875, 2019.
- [16] R. Billinton and R. N. Allan, "Reliability Evaluation of Power Systems," First. New York: Plenum Press, 1984.
- [17] W. Li, "Risk Assessment of Power Systems: Models, Methods, and Applications," Second Edi. New Jersey: John Wiley & Sons, 2014.
- [18] S. Peyghami, F. Blaabjerg, and P. Palensky, "Incorporating Power Electronic Converters Reliability into Modern Power System Reliability Analysis," *IEEE J. Emerg. Sel. Top. Power Electron.*, no. DOI 10.1109/JESTPE.2020.2967216, 2020.
- [19] M. Rausand and A. Høyland, "System Reliability Theory," Second Edi. Hoboken, New Jersey: John Wiley & Sons, Inc., 2004.
- [20] Y. Song and B. Wang, "Survey on Reliability of Power Electronic Systems," *IEEE Trans. Power Electron.*, vol. 28, no. 1, pp. 591–604, Jan. 2013.
- [21] A. Albertsen, "Electrolytic Capacitor Lifetime Estimation," *JIANGHAI Eur. GmbH*, pp. 1–13, 2010.
- [22] R. Bayerer, T. Herrmann, T. Licht, J. Lutz, and M. Feller, "Model for Power Cycling Lifetime of IGBT Modules - Various Factors Influencing Lifetime," in *Proc. IEEE CIPS*, 2008, pp. 1–6.
- [23] S. Peyghami, M. Fotuhi-Firuzabad, and F. Blaabjerg, "Reliability Evaluation in Microgrids with Non-Exponential Failure Rates of Power Units," *IEEE Systems Journal*, vol. 14, no. 2, pp. 2861–2872, 2018.
- [24] A. Abiri-Jahromi, M. Fotuhi-Firuzabad, and E. Abbasi, "An Efficient Mixed-Integer Linear Formulation for Long-Term Overhead Lines Maintenance Scheduling in Power Distribution Systems," *IEEE Trans. Power Deliv.*, vol. 24, no. 4, pp. 2043–2053, 2009.