

A probabilistic model to evaluate the resilience of unattended machinery plants in autonomous ships

Abaei, Mohammad Mahdi; Hekkenberg, Robert; BahooToroody, Ahmad; Banda, Osiris Valdez; van Gelder, Pieter

DOI

[10.1016/j.res.2021.108176](https://doi.org/10.1016/j.res.2021.108176)

Publication date

2022

Document Version

Final published version

Published in

Reliability Engineering and System Safety

Citation (APA)

Abaei, M. M., Hekkenberg, R., BahooToroody, A., Banda, O. V., & van Gelder, P. (2022). A probabilistic model to evaluate the resilience of unattended machinery plants in autonomous ships. *Reliability Engineering and System Safety*, 219, Article 108176. <https://doi.org/10.1016/j.res.2021.108176>

Important note

To cite this publication, please use the final published version (if applicable).
Please check the document version above.

Copyright

Other than for strictly personal use, it is not permitted to download, forward or distribute the text or part of it, without the consent of the author(s) and/or copyright holder(s), unless the work is under an open content license such as Creative Commons.

Takedown policy

Please contact us and provide details if you believe this document breaches copyrights.
We will remove access to the work immediately and investigate your claim.

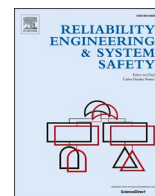

A probabilistic model to evaluate the resilience of unattended machinery plants in autonomous ships

Mohammad Mahdi Abaei^a, Robert Hekkenberg^a, Ahmad Bahootoroody^{b,*},
Osiris Valdez Banda^b, Pieter van Gelder^c

^a Department of Maritime and Transport Technology, Delft University of Technology, Delft 2628 CD, the Netherlands

^b Marine and Arctic Technology Group, Department of Mechanical Engineering, Aalto University, Espoo 11000, Finland

^c Department of Values, Technology and Innovation, Delft University of Technology, Delft 2628 CD, the Netherlands

ARTICLE INFO

Keywords:

Reliability estimation
Autonomous shipping
Unattended machinery plant
Redundancy

ABSTRACT

Over the next few years, digitalization and automation are expected to be key drivers for maritime transport innovation to be key drivers for maritime transportation innovation. This revolutionary shift in the shipping industry will heavily impact the reliability of the machinery which is intended to be operated remotely with minimum support from humans. Despite a large amount of research into autonomous navigation and control systems in maritime transportation, the evaluation of unattended engine rooms has received very little attention. For autonomous vessels to be effective during their unmanned mission, it is essential for the engine room understand its health condition and self-manage performance. The unattended machinery plant (UMP) should be resilient enough to have the ability to survive and recover from unexpected perturbations, disruptions, and operational degradations. Otherwise, the system may require unplanned maintenance or the operation will stop. Therefore, the UMP must continue its operation without human intervention and safely return the ship to port. This paper aims to develop a machine learning-based model to predict an UMP's performance and estimate how long the engine room can operate without human assistance. A Random Process Tree is used to model failures in the unattended components, while a Hierarchical Bayesian Inference is adopted to facilitate the prediction of unknown parameters in the process. A probabilistic Bayesian Network developed and evaluated the dependent relationship between active and standby components to assess the effect of redundant units in the performance of unattended machinery. The present framework will provide helpful additional information to evaluate the associate uncertainties and predict the untoward events that put the engine room at risk. The results highlight the model's ability to predict the UMP's trusted operation period and evaluate an unattended engine room's resilience. A real case study of a merchant vessel used for short sea shipping in European waters is considered to demonstrate the model's application.

1. Introduction

The safety of unattended machinery plants in Maritime Autonomous Surface Ships (MASS) is expected to significantly impact maritime trade. The concept of autonomous shipping has peaked considerable interest in recent years due to the potential of reducing operational cost (up to 36% of total operational cost [1]), removing the difficulties to hire onboard personnel [2], and reducing the number of human error-induced incidents in marine transportation [3]. According to the safety and shipping review presented by insurance company Allianz, between 75% and 96% of marine accidents are influenced by the human factor [3]. By the

absence of onboard experts, the operation will be susceptible to emerging risks, which will greatly impact the unattended machinery's performance [4]. These unanticipated events could have a very significant negative impact on the assets' acceptability, thus hindering the widespread deployment of intelligent operations in future maritime trade.

The existing market and regulatory arrangements are mainly focused on advanced control systems [5–7], navigation, and communication [8–10] in autonomous ships. Examples of relevant projects include the Maritime Unmanned Navigation through Intelligence in Networks (MUNIN) project [11], The Advanced Autonomous Waterborne Applications Initiative (AAWA) project [2], and more recently, the Autoship

* Corresponding author.

E-mail address: ahmad.bahootoroody@aalto.fi (A. Bahootoroody).

<https://doi.org/10.1016/j.ress.2021.108176>

Received 16 April 2021; Received in revised form 21 October 2021; Accepted 4 November 2021

Available online 25 November 2021

0951-8320/© 2021 The Author(s). Published by Elsevier Ltd. This is an open access article under the CC BY license (<http://creativecommons.org/licenses/by/4.0/>).

Nomenclature			
MASS	Maritime autonomous surface ships	e	Evidence in Bayes' Theorem
UMP	Unattended machinery plant	n_v	Number of redundant-able components
RPT	Random process tree	n_u	Number of non-redundant components
BN	Bayesian network	C_j	j^{th} Category in RPT
pdf	Probability density function	B_j	Branch in RPT (start from relevant Path ends to j^{th} category)
HBM	Hierarchical Bayesian model	θ	Unknown parameter in RPT
DAG	Directed Acyclic Graph	φ_{sk}	Positive number in the function of $P(B_j \theta)$
CPT	Conditional probability tables	α_{js}	Non-negative integers in the function of $P(B_j \theta)$
<i>iid</i>	independent and identically distributed	b_{js}	Non-negative integers in the function of $P(B_j \theta)$
k	represents the k th category of the event in observation process	γ	Observation matrix for data
n	Number of components in UMP	L	ratio of redundancy
δ_{ij}	Availability of standby components $\delta_{ij} \in \{1, 0\}$	Λ_R	Standby coefficient factor
u_1, \dots, u_j	Non-redundant components	n^R	Number of standby components
v_1, \dots, v_i	Redundant-able components	$f_l^{(x)}(t)$	The probability density function for the x^{th} critical failure arrival
v_i^l	Standby items for each component	$R_l(t)$	Reliability at time instance t for the system without redundancy
l	The enumeration for the number of a particular component in the single series-parallel system $l = 1, \dots, n^R$	$R(t)$	Reliability at time instance t for the system with redundancy
S^R	The system in new condition		
CFL	Critical Failure Limits		

project [12] that strives to convert a short sea-going vessel into an autonomous vessel. Currently, the apparent lack of coherent strategies assessing reliability of unattended machinery has been identified as a neglected part of autonomous ships that will directly affect the safety of maritime transportation [9,13,14,41]. Unmanned systems need to remain safe while being 'resilient' to unpredictable changes and functional failures. The AAWA project states that onboard systems of an autonomous ship "need to be resilient to failure and extend maintenance intervals" [2]. Thus, to create a smart maritime technology, a robust probabilistic approach is needed to provide sufficient information about the availability of an unmanned engine room and reliably perform independent missions for 500 h without human intervention [6,15].

As stated by [12], the major challenge is that the experience with autonomous ships is very limited to evaluate reliability of unattended machinery plants (UMP) the same as a manned system. A system-theoretic process analysis (STPA) was recently proposed [16,17] to identify the unmanned system's safety structure and investigate its functionality. Although the STPA approach is a useful method for hazard identification of UMP in maritime transportation [18–20], it is mainly a qualitative-based approach focusing on safety aspects of maritime transportation. The research conducted by [11,13–14, 21] included analyzing safety concerns for a particular type of unmanned vessel in different degrees of autonomy. A few studies [1,11,22–24] focused on reducing the human task in unmanned vessel and its impact on remotely monitoring system performance; however, there was limited quantification solutions for reliability assessment of UMPs.

The broader idea of resilience in unmanned operation can come from all levels of the system, including recovery of failed units in the condition of encountering critical failure [25,12], mitigating emerging risk [26,27], and reducing system failures by eliminating human errors [4, 28]. In resilience engineering, failure is regarded as the inability to perform necessary adaptations to the uncertain environment rather than a breakdown or malfunction [29]. This projection requires an understanding of how a system can proactively ensure that things stay under control. Arguing that the failure probability is acceptably low is simply not enough for achieving a trusted unmanned operation. The system needs to be able to recover from unexpected disruptions and degradations of the operational environment [29].

Among all quantitative and semi-quantitative approaches for resilience assessment, having redundant units for sensitive parts of

unattended machinery is considered an effective resilience solution [25]. Allocating an appropriate level of redundancy to a system can make an operation able to sustain or restore its lost capacity following untoward changes [26]. Different approaches have recently been investigated for allocating redundancy based on predicting time to failures, such as assuming exponential distribution and Erlang distributions [30,31]. The latter assumption can model the time-varying hazard rate; however, it cannot consider the process's uncertainty, especially if the variability of data is concerned. It seems that the UMP is likely to follow an increasing hazard rate function due to the large uncertainty in the occurrences of disturbances. It is essential to define a more robust model for predicting critical failures that stop the components from.

This paper aims to develop a probabilistic approach for modeling redundancy of the UMP as an approach to estimate the system's resilience to untoward changes. To this end, firstly a stochastic model is proposed to overcome the hurdles in predicting time-to-failures for assessing the performance of UMPs. A Random Process Tree (RPT) is developed to address the operation's uncertainty and categorize the system's non-nominal conditions into critical and non-critical failures. A Hierarchical Bayesian Model (HBM) is adopted to quantify the uncertainty associated with the tree due to its powerful reasoning capacity to predict events based on complete or incomplete information. This stage will enable the system to predict untoward events that disrupt the system. The system's daily detected probability of failures will be estimated at this stage and imported to set up the redundancy model. A probabilistic Bayesian Network (BN) is proposed to assess the redundancy of UMPs and evaluate the dependent relationship between active and standby components. The outcome will enable the system to predict the improvement in the reliability of unattended machinery. To demonstrate the application of the proposed model for unmanned maritime shipping, two different engine room design scenarios considered as the case study. The system with redundant high-risk units as the new system and non-redundant high-risk components as the current system monitored to indicate the behavior of the hazard rate in two cases. The comparison will allow the system designer to predict an UMP's performance and estimate the potential increase of trusted operation time without human interventions. The remainder of this paper is organized as follows. Section 2 describes the problem definition and methodology. Section 3 discusses the case study to analyze an unmanned engine

room’s performance based on the proposed model, and Section 4 summarizes the conclusion and future works.

2. The methodology: predicting the functional capacity of UMPs

As the main limitation for removing human from the engine room, the availability of unattended machinery systems must extend for an independent mission of at least 500 h, the mission length specified by MUNIN [11]. The studies conducted by [4,20,32] have identified that the event-data will help predicting failures in the system, especially if there is not much informative historical data for autonomous ships. Mostly, the available event-based information about the machinery is the prior observation for requesting repair or maintenance. However, such information must incorporate a robust predictive approach to evaluate UMP’s performance of system in a longer period. In this study, a random process tree (RPT) is introduced by considering the uncertainty of discrete event system in such a way that the frequency of the occurrence for different events will be assessed (Step 1). The RPT is a non-deterministic approach for which the state and output of sequences

are controlled with a probability that can be perceived from prior observation. For a left unattended system, it is expected that some events are observed very often, whereas others occur rarely. A Hierarchical Bayesian Model (HBM) is developed in (Step 2) to quantify the uncertainty in the RPT. In (Step 3) the framework is formalized with a redundancy model by developing a Bayesian Network (BN) for evaluating the system interdependencies according to the detection of critical and non-critical failures (Step 4). Finally, the simulation will be updated in (Step 5) to analyze the reliability of the system and predict the system’s functional capacity of UMPs compared to the non-redundant design condition. The framework will predict whether the system’s reliability satisfies the safety requirements for the operation of UMP; i.e., obtaining the minimum trusted operation time without human interventions. In general, the framework can re-evaluate the system from (Step 3) to reconfigure the sub-components’ redundancy model. The framework is also flexible when new observations become available; i.e., the model can be re-started from step 1 and update the critical events by feeding new data to the developed HBM (Step 2). The sequence of the current framework is shown in Fig. 1.

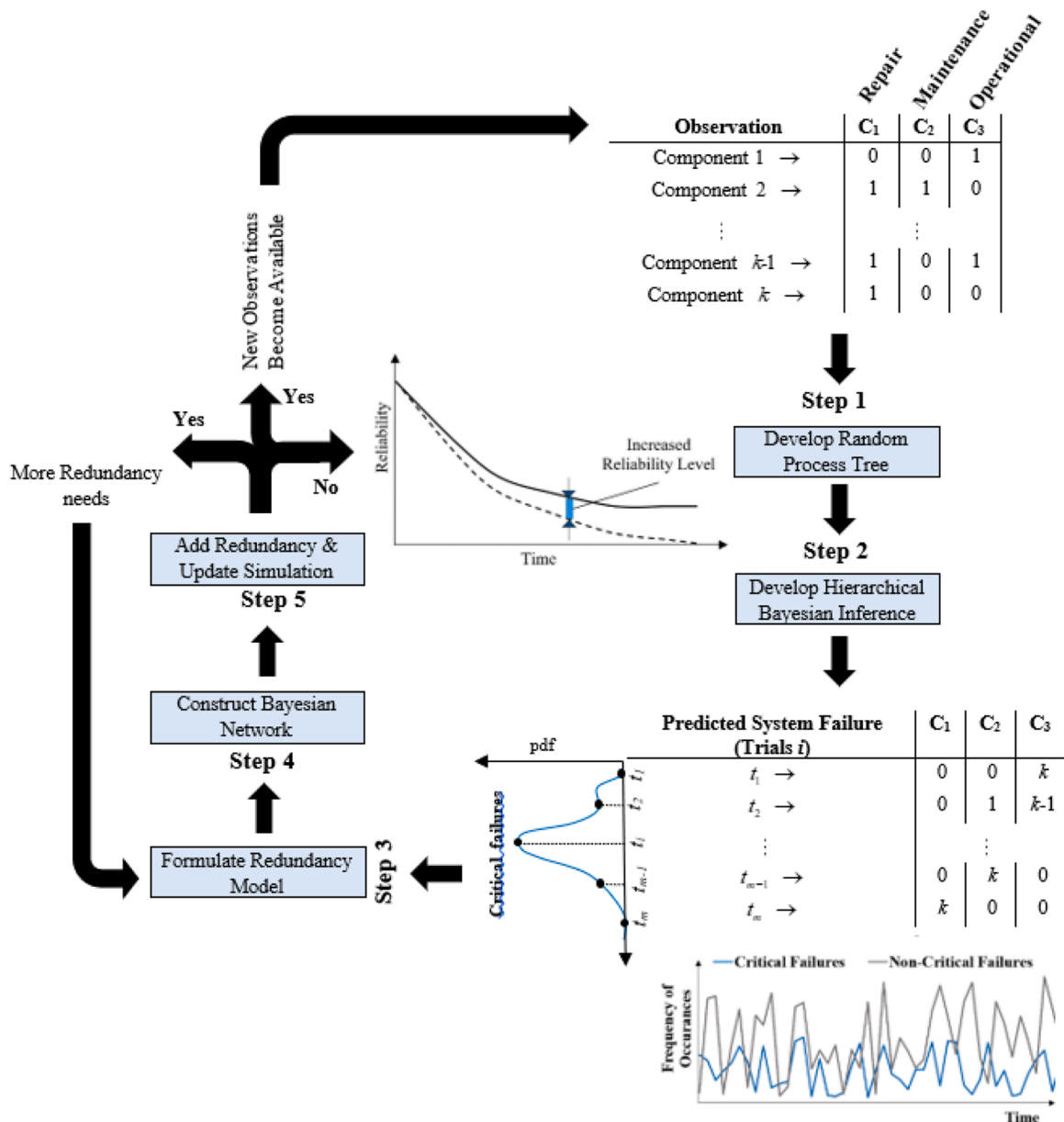

Fig. 1.. The sequence of the developed model to evaluate the reliability of UMPs subject to the adverse conditions.

2.1. Solution procedure for uncertainty modelling of the process (Step 1 & 2)

As suggested by [35], considering a categorical distribution is a convenient approach for describing the system behavior and propagating the associate uncertainty in a complex process. The RPT models are substantively motivated statistical models that can be applied to categorical data and represent the performance of an operation globally [34]. This characteristic makes the RPT a suitable choice for modeling the categorical failures in a UMP. The RPT models simulate the categorical data based on the assumption that the sample frequencies observed for the event data follow a multinomial distribution [35]. Importantly, RPT does not only assess the probabilities underlying these sample frequencies but aims to explain key parameters in terms of latent processes that determine the behavior of the entire process [35]. The other advantage of RPT architecture is that category probabilities are generally expressed as nonlinear functions of the underlying failure parameters. Thus, even though RPT models parameterize latent processing events, the represented category probabilities are usually nonlinear polynomial functions of the processing event parameters [35]. An RPT model is built out of a set of $J > 1$ mutually exclusive and exhaustive observable categories, $C = \{C_1, C_2, \dots, C_J\}$ and a set θ of unknown parameters arrayed in a vector $\theta = \{\theta_1, \theta_2, \dots, \theta_s\}$ in the relevant tree's path. Each parameter θ_s represents the probability of the occurrence and $(1 - \theta_s)$ the non-occurrence of latent events. The processing tree consists of a single path and a collection of processing branches, each terminating in a particular observable category. The observable category C_j is an indication of recovery actions for the system, i.e., doing

maintenance, repair, or continuing the operation. The state probability, θ , denotes healthy state in the RPT. In general, an RPT model can have different order of paths (denoted by $B_j, j = 1, 2, \dots, J$) leading to category C_j . Each branch has a probability of occurrence that proceeds to a new condition for the system, and these probabilities are required to satisfy a specific functional form underlying parameters. The combination of paths that end at a particular leaf node C_j and consists of Branch orders B_{ij} . Therefore, each branch has a probability of occurrence $C_j \sim P(B_j; \theta)$; the symbol \sim means an RPT may have different branches that end to a similar C_j . In particular, the relevant probability for each branch order B_{ij} defines as:

$$P(B_j; \theta) = c_j \prod_{s=1}^S \theta_s^{a_{js}} (1 - \theta_s)^{b_{js}} \tag{1}$$

where c_j is always a positive number a_{js} and b_{js} are non-negative integers [36,39]. Consequently, the categorical function $P(C_j|\theta) = \sum_{j=1}^J P(B_j|\theta)$ over all possible paths will predict a system's required recovery action. The necessary conditions for the final categorical probabilistic structure of the model need to satisfy $\sum_j P(C_j|\theta) = 1$, for all

processing branches, allowing each C_j parameter to vary independently between [0,1]. A simple example of constructing RPT for a hypothetical component A is shown in Fig. 2. The component states are assumed as Healthy (H) for nominal condition; Minor (M) for small indication of errors in the system that need to be checked; Moderate (M) for abnormality in the components that will need maintenance at a proper time; and Severe (S) for the non-nominal condition that the system will stop

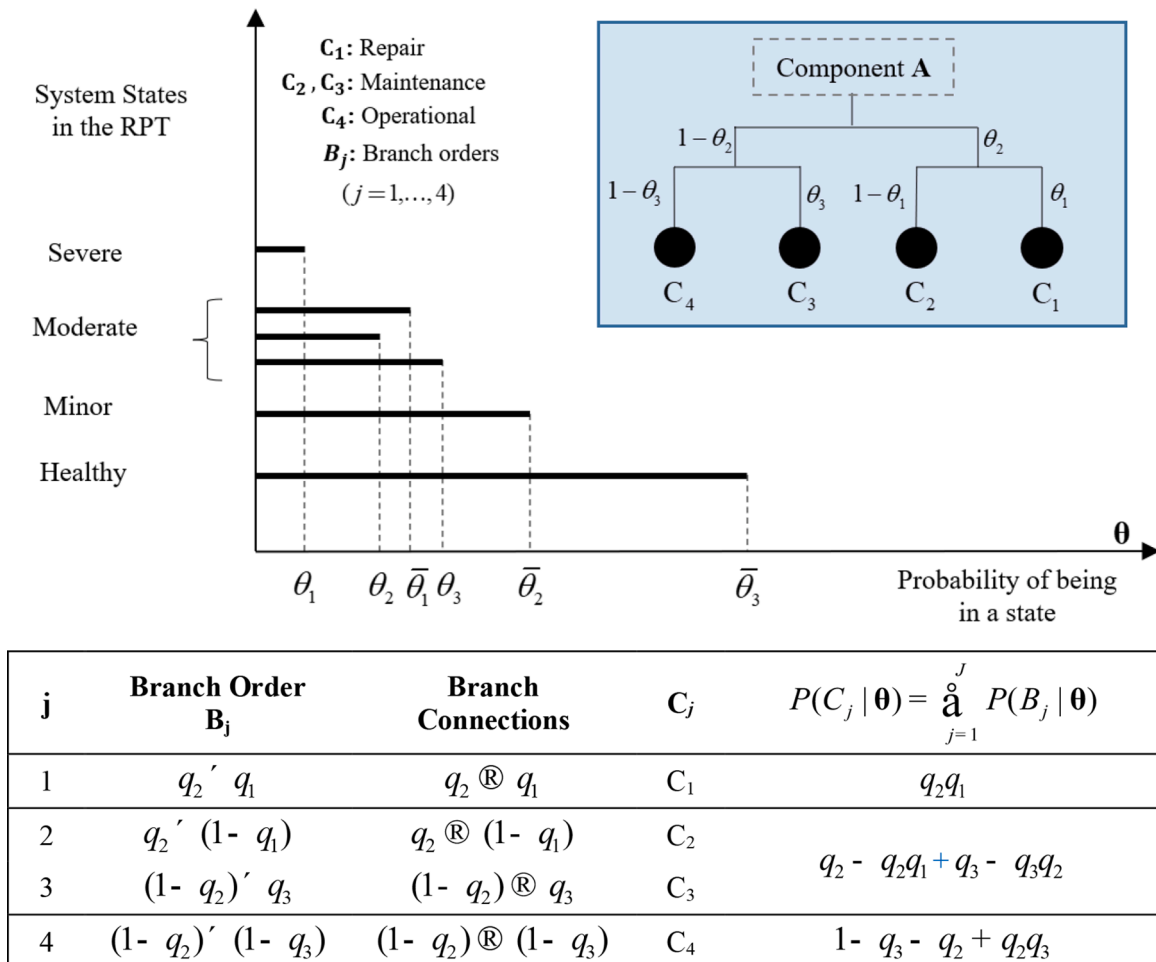

Fig. 2.. A conceptual illustration to construct RPT for predicting the behavior of UMP.

immediately and the broken item will need for immediate repair. Each of these states can be represented in six different branches. Each branch has a probability of occurrence as $\theta_s = \{\theta_1, 1 - \theta_1, \theta_2, 1 - \theta_2, \theta_3, 1 - \theta_3\}$, probabilities for the degradation of operational condition from its nominal state, respectively. The combination of relevant branches in a particular path will end in a categorical action. For this particular example, the only critical path is I_1 , which consisting of branches numbers (1) and (2) that construct the branch order B_{12} , and leads to repair action, C_1 . Also, Component **A** can observe maintenance action from two different paths I_2 and I_3 that ends to similar category of C_3 . For instance, the final categorical probability function for maintenance is formulated as $P(C_2, C_3|\theta_1, \theta_2, \theta_3) = P(B_2|\theta_1, \theta_2) + P(B_3|\theta_2, \theta_3)$ which is a nonlinear polynomial function followed by $\theta_2(1 - \theta_1) + (1 - \theta_2)\theta_3$. This function proves that the component has the chance to observe non-critical events, even if it is in the Minor state, though its branch probability $P(B_{45}|\theta_2, \theta_3) = (1 - \theta_2)\theta_3$ is expecting to be very low. In this way, the process will easily categorize the critical and non-critical failures by predicting the system priorities for repair or maintenance.

Many uncertainties are within the final categories in the RPT, which can be quantified by predicting all possible combinations of the failure events in N trials. In DES, N trials will represent the order of time instants (relevant to the RPT circumstances), which are alternatively denoted as operation time t per day for each component [33]. The multinomial distribution is the most general and neutral statistical distribution for this purpose, which is a generalization of the binomial distribution to multiple categories. In the multinomial distribution, observations are independent and identically distributed (*iid*) over the categories C . Each category has an unknown parameter (i.e., parameter θ) representing the probability that a random observation falls into it (i.e., failure function $P(C, \theta)$). Therefore, the RPT will express the probability parameters as the functions of system behavior for different circumstances and re-parametrize the multinomial distribution in return.

In this study, Bayesian Inference is adopted to develop a probability model for predicting uncertain parameters in the RPT. Bayesian inference is the process of fitting a probability model to a set of data and summarizing the result by a probability distribution on the parameters of the model and unobserved quantities such as predictions for new observations. This advantage will help quantify uncertainty of the system behavior by defining the appropriate failure model derived from the RPT. Apart from predictive reasoning, it also allows for diagnostic reasoning for specifying the most likely cause of a failure event. Due to the complexity of systems in autonomous ships, the prediction model needs to react as a function of a desired goal state and feedback regarding the experimental conditions of a system. Recent research on evaluating the reliability of marine operations and predicting the availability of systems highlights key attributes of the Bayesian method, namely the ability to incorporate qualitative information (i.e., evidence obtained from events) into the parameters [36–38]. Hierarchical Bayesian inference is a probabilistic approach that provides the organization of inference based on real observations [12,28,36–38]. The advent of Markov chain Monte Carlo (MCMC) sampling has proliferated Bayesian inference by setting up a Bayesian network to quantify the uncertainty. This opportunity has brought them to a wider audience to conduct probabilistic risk and reliability assessment due to its capability to predict model parameters. In this study, Bayes' theorem is considered for carrying out an inference [27] given by

$$P(\theta|y) = \frac{L(y|\theta)P(\theta)}{\int_{\theta} L(y|\theta)P(\theta)d\theta} \tag{2}$$

In the equation θ is the unknown parameter of interest, $L(y|\theta)$ is the likelihood function, $P(\theta)$ and $P(\theta|y)$ are prior and posterior distribution, respectively. To this end, the likelihood function for the unknown parameter, θ , along with the observation of categorical events, y and the target component j^{th} out of total n components, is defined by the multinomial distributions [35],

$$L(y|\theta) = \binom{n}{y_{r1}, \dots, y_{rk}} \prod_{k=1}^K \left(\underbrace{\sum_{j=1}^J P(B_j|\theta)}_{P_r(C_k, \theta)} \right)^{y_{rk}} \tag{3}$$

It should be noted that function C depends on θ as discussed above. The parameter k^{th} represents category of the event in observation y , and the capital K represents the total number of elements for the observations of categories. The likelihood function in Eq. (3) is not exchangeable for all observable parameters of y (i.e., Eq. (3) is applicable for any new observations in the same order). Therefore, the full observation matrix Y for all n components, where $\{y_{r1}, \dots, y_{rk}\}$ is the r^{th} row of the observation in the set Y and $r = 1, \dots, n$ represents the target components. The likelihood function in Eq. (3) will play an essential role in predicting the unknown parameter θ to integrate with the Bayesian inferences. To develop the hierarchical Bayesian model, the unknown parameters θ , observation matrix Y , and hyper-parameters α and β defines in nodes $\xi \in \{\theta, y, \alpha, \beta\}$ in a probability graph. The posterior $P(\theta|y) \propto \prod_{\xi} p(\xi|pa[\xi])$ of distributions of all nodes ξ defines from the conditional on its parents $pa[\xi]$. The structure of designing HBM as the directed acyclic graph (DAG) to support the uncertainty of RPT is shown in Fig. 3.

There is no informative prior knowledge for branch probabilities θ in the RPT model in the present study, i.e., the model is not supported with either physical, engineering information, expert judgments, and historical data under the same or similar circumstances for the system state. The only available practical knowledge is the frequency of categorical actions in the terminal nodes, C related to the final categories for critical or non-critical failures. This information will be a help to update the parameter of the interest in the probability network since the function C is the condition of θ in the formulation.

In addition, the topology of the RPT for the current problem always have paths with an equal length similar to Fig. 2 in which the non-informative prior can be a good choice for populating the tree. This forces the posterior function to completely depend on observation data [12,28,35–37]. Therefore, the predicted posterior distribution will consider the uncertainty in available observation data and accurately reflect their true nature [37]. In this study, the non-informative prior for the hyper-parameters (α, β) are assigned to populate the tree without bias. Setting a non-informative uniform prior, the probability of each unknown parameter θ is equally distributed in the tree [9]. The uniform distribution, Jeffrey's prior, diffuse gamma, and diffuse, normal distribution are the typical choice of non-informative distribution for hyper-parameters suggested by previous studies [35–37]. According to the suggestion made by [38], the $Beta(\alpha, \beta)$ prior distribution is used with $\alpha = 1$ and $\beta = 1$ adopted, which represents uniform distribution. The uniform distribution is more suitable in inference solutions regarding employing external evidence through a multinomial distribution. In this study, the open-source MCMC WinBugs software Package [38] is employed to predict marginal posterior distributions.

By predicting the parameter θ , the categorical function for all possible failures can be estimated as $P(C_j|\theta) \propto P(B_j; \theta)$. This will result in estimating the critical failure events in the system for each trial. Finally, the Monte Carlo simulation will be employed to obtain the daily probability of critical failures defined as $f(\text{daily} \sim \text{trials})$ based on the predicted posterior function $P(C_j|\theta)$ and marginalize the multinomial distribution over each category count in the RPT. The probability vector for the multinomial distribution must satisfy the non-negativity and sum-to-one properties as discussed in section 3.1 (i.e., $\sum_j P(C_j|\theta) = 1$).

Therefore, an appropriate distribution to model the marginalized probability uses the Dirichlet distribution alternatively [36]. The Dirichlet distribution is a conjugate for the parameters of the multinomially distributed responses. Therefore, the conditional posterior distribution of the category response rates is a Dirichlet distribution.

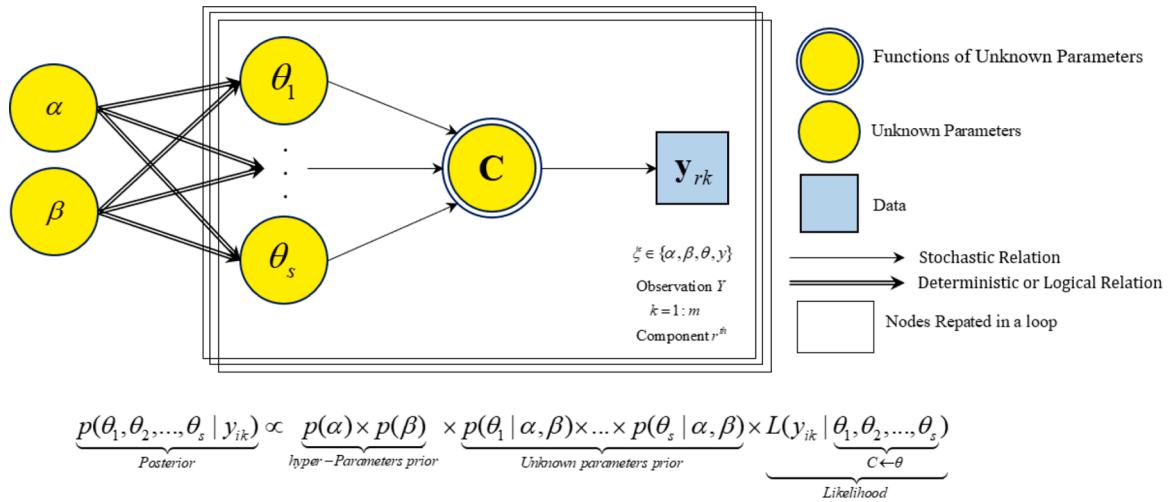

Fig. 3.. The proposed hierarchical Bayesian probability network for modeling random variables in RPT.

This helps randomize the category counts in the RPT, which is distributed according to a multinomial distribution, and estimating the marginal distribution by integrating on the distribution for relevant category (i.e., $P(C_j | \theta)$) that can be learned as a random vector following a Dirichlet distribution. The daily probability function is essential for developing the redundancy model and predicting the performance while switching from a breakdown unit to a standby component.

2.2. Solution procedure for developing the redundancy model (Step 3, 4 & 5)

Since the unmanned vessel needs to operate without any disruption of operations for a specific time, it is not feasible to repair the broken components onboard. Therefore, the weak components (i.e., highly dependent on human intervention) in the system should be considered non-repairable. The weak components need to be supported by a redundant unit to substitute the broken parts in observing critical failures. There are two main approaches for redundancy modeling, active and cold-standby, described in detail by [25]. The cold-standby redundancy has always been recommended as an effective system design strategy [25, 46]. In the cold standby strategy, the components are protected from internal and external disruptions as they are not active during the operation. The cold-standby redundant components are also referred to as inactive components since they are not involved in the operation until the disruption occurred. Compared to other approaches discussed by [25,30,31], the cold-standby redundancy generally leads to higher system reliability, since the redundant unit will not be used until the observation of failure in the active component. However, the main hurdle for implementing cold standby is detecting failure events and activating the redundant component, while this is not necessarily required for active redundancy.

It is preferred to allocate redundancy in the system for the highly failure-sensitive components. Therefore, the system reliability $R(t)$ depends on the number of identified high-risk components n , ratio of redundancy L , and the total number of n^R components performing a given function during time t in the system. The reliability of a single parallel system with cold standby redundancy and perfect switching is given by [25]

$$R(t) = r_1(t) + \sum_{x=1}^{n^R-1} \int_0^t r_1(t-u) f_1^{(x)}(u) du \tag{4}$$

Where $r_1(t)$ is the reliability at time t for the system without redundancy, and $f_1^{(x)}(t)$ is the daily probability density function for the x^{th} critical failure occurrences in the operation derived from step 1 & 2.

The second term in Eq. (4) represents increasing reliability after including redundant components in the system. The subsequent $n^R - 1$ additive terms (in the summation of Eq. (4)) represent the mutually exclusive probabilities between 1 and $n^R - 1$ failures while a redundant component is still operating at time t . In general, each unit in a system may have considered redundancy allocation with one or more parallel components. If the system uses more than one component ($n^R > 1$), it means that the system has a redundant unit in parallel. Then there will be one initially operating component and $n^R - 1$ components in cold standby waiting to be activated as required. Since the occurrence of the first critical failure in the system is random, it is necessary to integrate all possible failure times from zero to t . Eq. (4) will be used as the redundancy formulation to estimate the increasing reliability level of the UMPs. If there is more than one system, then the final reliability will be derived as an independent and identically distributed (*iid*) variable that defined by $\bar{R}(t) = \prod_{s=1}^S R_i(t)$ where S is the number of the operating system, while the Eq. (4) should derive for each system separately.

To evaluate performance of new system, the RPT's categorical probabilities must update given the condition that redundant parts are allocated to the old system. In general, not all components are potentially redundant due to logical reasons, such as limitation in space, cost, and weight. Therefore, the UMP operates as a complex series-parallel system. The components will be divided into two main categories; the components u_j that cannot be redundant and the components v_i that can be redundant. Each potentially redundant component can have $n^R - 1$ standby components, sine in the engine room it is assumed that only one unit is operating before the occurrence of each failure event. This will result in a series-parallel subsystem, while the non-redundant components will only be in a series configuration. It means that if any components in the set u_j fail, then the whole operation will be disrupted. By this definition, the total number of failure sensitive components, n in the systems is the summation of $n_v + n_u$, where the n_v is and n_u are the number of redundant-able and non-redundant components, respectively. The ratio of redundancy and standby coefficient for the system is considered as a simple parameter to define the proportion redundancy of all high-risk components in an UMP group as $L = n_v / (n_v + n_u) \sqrt{b^2 - 4ac}$ and $\Lambda_R = \sum_{v=1}^{n_v} \sum_{u=1}^{n_u} \delta_{vu} / (n_v + \sum_{v=1}^{n_v} \sum_{u=1}^{n_u} \delta_{vu})$ respectively. The coefficient Λ_R shows the proportion of redundancy for potentially redundant components in the system, and the binary value of $\delta_{vu} \in \{1, 0\}$ represents the availability of redundant components; where, $\delta_{vu} = 1$ for activated standby component and $\delta_{vu} = 0$ not activated standby component, In the hypothetical case of having an infinite number of standby components, the coefficient Λ_R approaches one;

however, in reality, it will always lower than one. The hyperparameters are only used to describe the redundancy condition of the system. The redundant components need to be added to the system depending on the failure frequency of that component but not on the hyperparameters. The block diagram for the whole system of a UMP is shown in Fig. 4. The series part of the graph represents non-redundant components (white blocks), u_1, \dots, u_{n_u} ; and the first row in the series-parallel part of the diagram represents potentially redundant components (Blue blocks) v_1, \dots, v_{n_v} . The rest of the blocks parallel to the first rows represent the standby items for each component $v_{n_v}^{(l)}$. The notation l denotes the system condition in the redundant mode $l = 1, \dots, (n^R - 1)$ for the system in new condition S^R given that the system in current condition may fail due to breakdown of a component in set v .

To propagate the uncertainty of the block diagram and predict the reliability of the system subject to any new failure events, the relevant BN is proposed to map the system behavior in the probability network. To this end, discrete BNs will be employed to model the series-parallel redundant system. Discrete BNs are based on DAGs in which nodes represent the random variables while their statistical dependencies are formulated by directed arcs connecting the nodes. The developed BN for modeling reliability of UMPs considering the redundancy in the system is shown in Fig. 5. The graph shows multiple layers of a system with more than one redundant component for each unit. In general, the system should always recall itself for the next level of redundant units to observe failure events in the system (e.g., Level 1 to Level 2 in the figure). In BNs, the conditional probability tables (CPTs) are used as data structures for storing conditional dependencies between uncertain variables. Therefore, the joint distribution of all random variables will be formulated as the product of the conditional distributions given the parent nodes. If there are no parents for a node, its marginal distribution is used instead. In the model, the system condition $P(S)$ in observing critical failures denoted as the parent node for all current switched-on components (i.e., the first row in Fig. 4). The marginal probabilities for the current condition $P(S)$ (i.e., observing critical and non-critical failures) and conditional probabilities to the current system for observing failure events for all components (u and v) will be derived from steps 1 & 2 and fed to the network.

The conditional probability nodes to the new system are defined according to the observation of critical failures, non-critical failures, and safe conditions by encoding binary classification representing 0 ~ non-occurrence and 1 ~ occurrence for each state. The joint distribution of the random variables for the present study will be estimated as the production of all conditional probabilities in the developed network; i.e.,

the CPT of the components will be estimated as: $\prod_{i=1}^{n_v} p(v_i | pa[v_i])$ for the

first row of the series-parallel part, $\prod_{i=1}^{n_v} p(v_i^R | pa[v_i^R])$ for allocating

redundant components to the upper row, $\prod_{j=1}^{n_u} p(u_j | pa[u_j])$ the non-redundant components, and $P(S^R | S)$ for new system condition.

The developed BN is then able to analyze the complexity of the system when updating the probabilistic model in light of observing critical failures. Whenever the failure is detected, then the Bayes' Theorem will be employed to update the joint distribution in the network using $p(\xi | e) = p(\xi, e) / \sum_{\xi} p(\xi, e)$, where e denotes new evidence and $\xi = \{u, v, S, S^R\}$ is the network nodes. By this advantage, upon new observation become available as the evidence of failure in on one or more components, the information propagates throughout the network and updates other random variables' distributions in the categorical multinomial process. Finally, the updated probabilities will be adopted for estimating the reliability of the entire system in the new system by estimating the hazard rate function and evaluating the increasing functional capacity of the system. In section 4, a real case study of an engine room will be discussed to demonstrate the method.

3. Set up of the case study: performance analysis of UMPs in engine rooms

A system breakdown of an engine room for a typical short sea merchant considered to implement the application of the framework. The system breakdown is based on a four-stroke diesel engine, and the components of each subsystem are grouped into failure-sensitive components as Group 1 and Group 2 that have high and medium impact on the continuing of the operation, respectively. The components in Group 1 represent weakest units in the engine room, whose failure will cause an immediate stop of the operation (e.g., the cooling water pump for the main engine). In contrast, the Group 2 components represent the units in the engine room whose failures will not stop the operation but will reduce the functional capacity of the system (e.g., starting air system which only used to start the engine and will not be needed anymore during the sea operation). The selected list of components in each subsystem is presented in Table 1 and labelled with its relevant group's type. This specification is adopted from the survey analysis conducted by [4] and will be used in present case study to demonstrate the advantage of the framework for evaluating the performance of UMPs, while there is no bias for the selection process.

The selection of group components classified according to the Frequency Index (FI) which is created by BV [4 and 40] for reliability assessment of autonomous ships. The index is defined in frequency of occurrence of an event per year per ship. The highest values of FI=5, 4 and 3 represent a frequency of 'multiple times per day', 'once a day to once a week' and 'once a week to once a month' respectively. While the lowest values of FI=2 and 1 represent 'once every 3 months to once a year' and 'once every 5 to 10 years' respectively. In addition, to

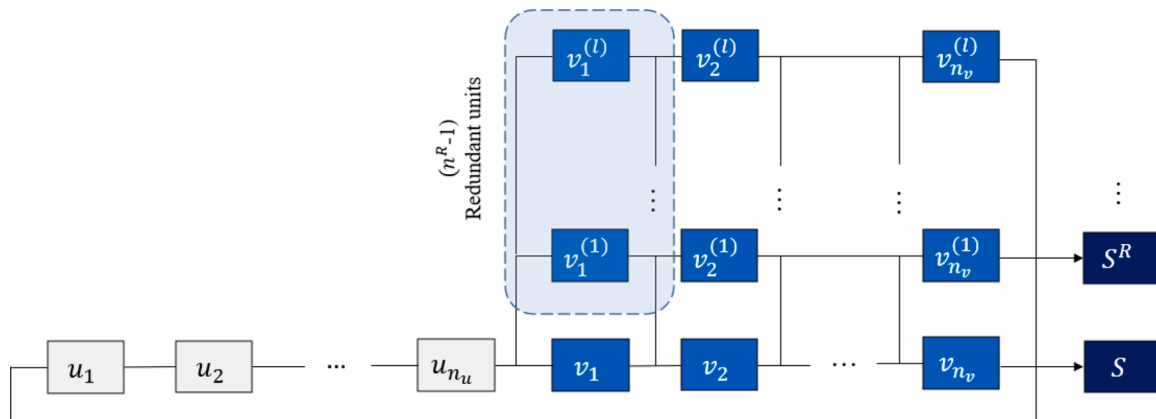

Fig. 4.. Block diagram for modeling reliability of UMPs considering redundant and non-redundant components in the system.

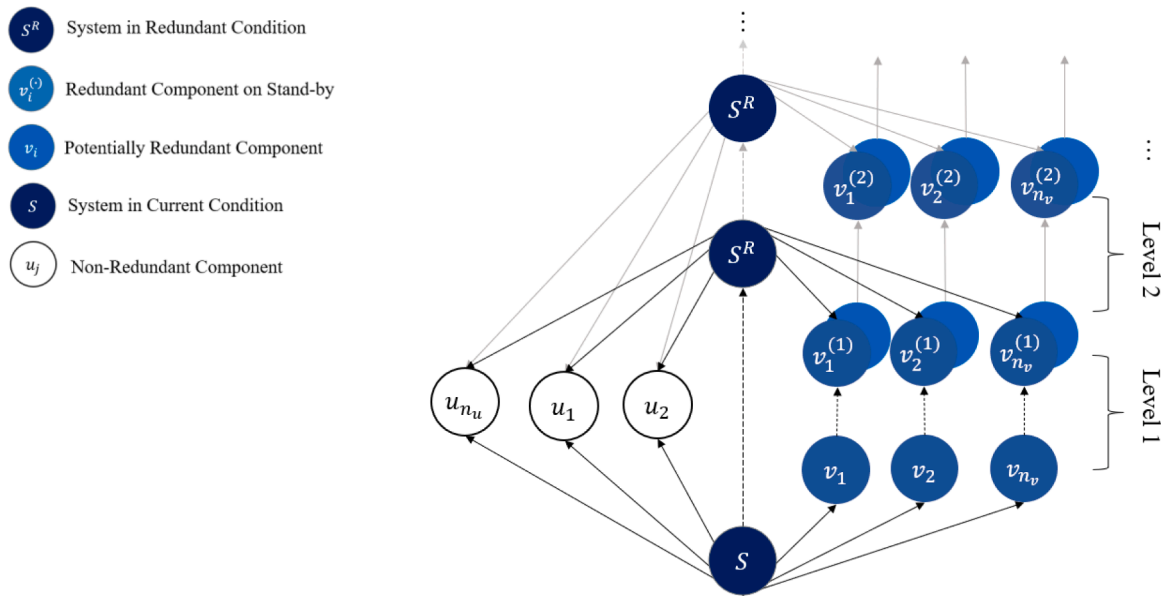

Fig. 5.. The developed BN for modeling reliability of UMPs considering redundancy in the system.

Table 1. Selected weak components in UMP of an unmanned engine room with the minimum level of redundancy (Indices are according to the survey conducted by [4]).

Subsystem	Sensitive Components in the Engine Room	Frequency Index	
		Maintenance	Repair
Group 1			
Main Engine	Gear Box	2	2
	Cylinder Cover	2	1
	Stern Tube Seal Cover	3	3
Cooling Water System	Sea Water Cooling pumps	2	2
	Jacket Water Cooling Pumps	2	1
	Central cooling water pumps	2	2
Exhaust Gas System	Exhaust Turbo Charger	4	1
Group 2			
Main Engine			
	Piston/Cylinder Liner	2	1
	Driving Gear	2	1
	Attached Pump	3	1
	maneuvering system	2	1
	Clutch	2	2
Cooling Water System	Expansion tank Freshwater treatment	1	1
		4	2
Exhaust Gas System	Economizer	4	2
Fuel oil system	Settling Tank	1	1
	Fuel Oil Centrifuge		
	Fuel Oil Filter		
Lubrication Oil System	Lubricating Oil Full Flow Filter	3	1
	Cylinder Lubricators	2	1
	Lubricating Oil Service Tank	1	1
	LO Centrifuge	2	1
Starting air system	Starting air compressors	3	2
Electrical system	Main switchboard Breakers	3	2

elaborate the importance of redundancy of high impact units in performance of unmanned engine room, the new engine room will be considered only for the possible redundant units in Group 1. The reason is that the Group 1 has a high impact on continuing the operation remotely due to its short-term availability in the emergence of failure

events. The simulation will help understand how long a UMP can be left unattended considering the short-term failures in the most critical units listed in Group 1.

3.1. Application example for constructing RPT

The present framework will be employed to do a comprehensive quantitative assessment of the performance of UMPs according to a component's need for repair and maintenance activities.

As an example, the constructed RPT for Group 1 is shown in Fig. 6, which represents evaluating the propagation of critical disturbances in high-impact components. The tree is constructed according to the criterion that none of the components should be disrupted when left unattended. It means that all sensitive components must be reliable enough to operate in an adequate functional capacity while working remotely. In this particular example, the categorical failure functions are selected $C = \{C_1, \dots, C_8\}$ according to the components listed in Table 1 for Group 1. The arrays C_1, \dots, C_6 account for the critical failure function of each component in the Group 1, which is categorized as repair action, C_7 represents maintenance, while C_8 is the safe condition. The branches' probability of intermediate lines is defined as $\theta_s \rightarrow \theta_{s+6}$ where $s = 1, \dots, 6$; and the branches for staying in non-critical condition are defined as $\theta_s \rightarrow (1 - \theta_{s+6})$ and the final branch for the safe condition is defined as $1 - \sum_{s=1}^6 \theta_s$. According to the discussion in section 3.1 (Step 1), the categorical failure functions for components RPT model are given by:

$$\begin{aligned}
 P(C_s | \theta_s, \theta_{s+6}) &= \theta_s \times \theta_{s+6} && \text{Critical Failure} && \text{where } s = 1, \dots, 6 \\
 P(C_7 | \theta_1, \dots, \theta_{12}) &= \sum_{s=1}^6 \theta_s (1 - \theta_{s+6}) && \text{non - Critical Failure} && \\
 P(C_8 | \theta_1, \dots, \theta_6) &= 1 - \sum_{i=1}^6 \theta_s && \text{safe Condition} &&
 \end{aligned}
 \tag{3}$$

These unknown categorial failure probabilities will be employed to construct the likelihood function, Eq. (2), and model the process for all Y observations. The same process will be performed for other subsystems and groups to estimate the functional capacity of an unmanned system. As the RPT is constructed, the prior observations are fed into the HBM to sample from likelihood functions in each observation and estimate the posterior distribution of random variables θ . Since the integration of the posterior probability is unknown due to the non-linearity of the

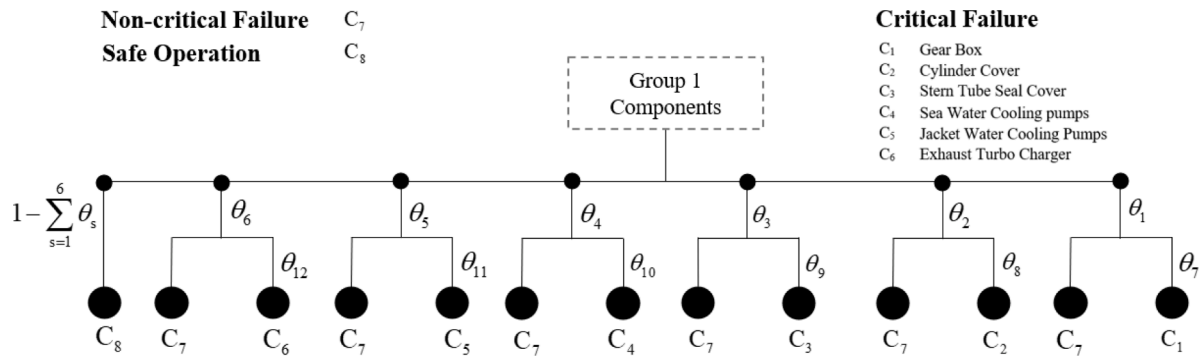

Fig. 6.. The designed RPT for components in Group 1 of the proposed unmanned engine room.

likelihood function and non-conjugate prior information, the integral is estimated by adopting the MCMC sampling approach. Two chains were considered in the MCMC simulation using WinBUGS for calculating the probabilities of processing branches θ . Each simulation is performed with a total of $200 E + 03$ iterations to predict the posterior distributions. The results will then transfer to the proposed redundancy model to

evaluate the system behavior in redundant and non-redundant conditions. The analysis will help the designer understand the automation level for an unmanned system and allocating required redundant components to achieve a trusted operation time without human intervention.

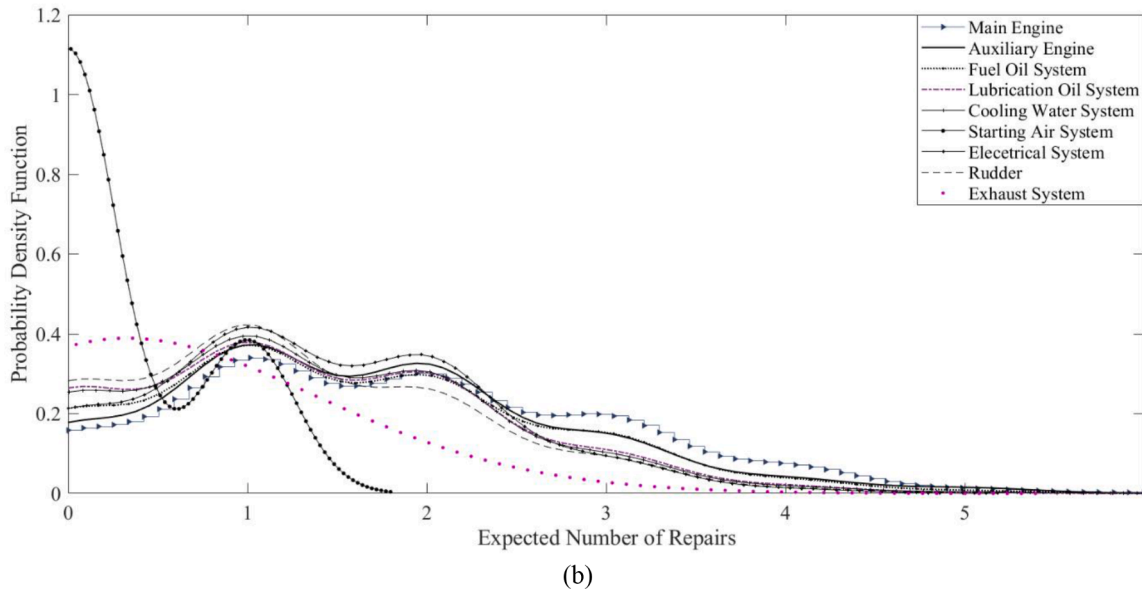
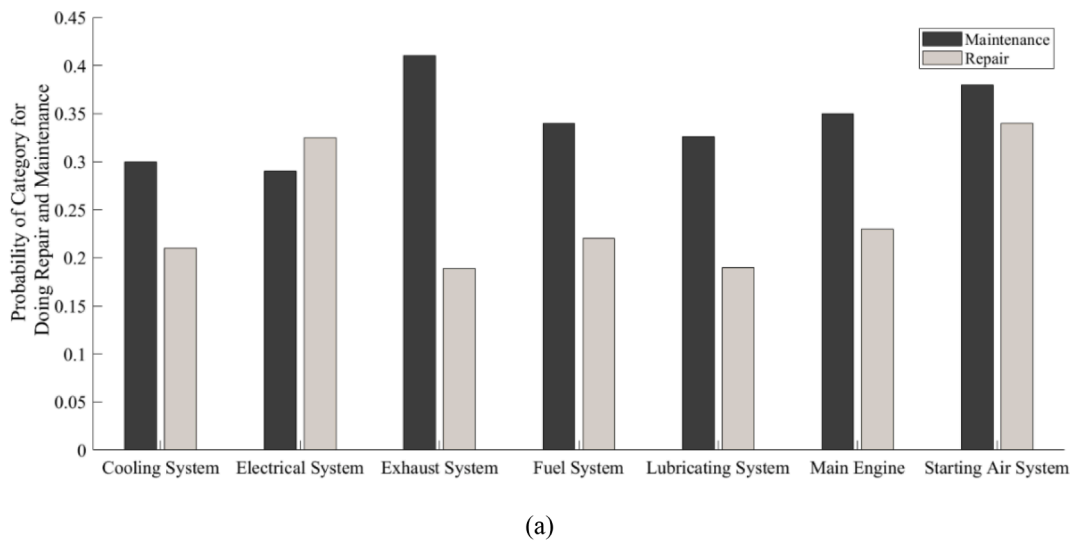

Fig. 7.. Categorical Probability occurrence of major disruptions (repair and maintenance needs) for all individual subsystems in the engine room (a), marginalized probability density function for observing critical failures in subsystems (b).

3.2. Results and discussion: performance analysis of UMPs

In the first step, it is essential to evaluate the performance of each subsystem individually and predict the outcome of failure events in a projected operation time. The estimated probabilities are categorized according to the needs for repair and maintenance (i.e., critical and non-critical failures) without considering the combination and the event dependencies with other subsystems. Therefore, this result will represent the functional capacity of each subsystem individually. The simulation is set up for the first 1000 operation days, and the predicted categorical actions that lead to repair and maintenance are plotted in Fig. 7a. The marginalized probability density functions for observing the need for repair actions in each subsystem are predicted and plotted in Fig. 7b. The plot represents the number of repairs which denotes the breakdown of relevant components in the subsystem. The graphs demonstrate that the unmanned system will behave stochastically, making the prediction of the UMP's health condition complicated. The reason is that each subsystem has a different failure rate in its lifetime, and this will result in a great deal of uncertainty that comes from the source-to-source variability of components.

The results shown in Fig. 7 cannot yet be regarded as a complete evaluation of UMP performance, since it cannot represent a reliable estimation of total engine room failure. It is desired to predict the performance of all equipment in the engine room while all critical units are operating safely together. The functioning of an individual subsystem will not give a guarantee for a trustworthy autonomous system. Therefore, all subsystems should be analyzed simultaneously. The present methodology is applied for evaluating the functional capacity of components in Groups 1 and 2 simultaneously. To this end, the hazard rate functions for both Groups are predicted and illustrated in Fig. 8 and Fig. 9. Four different Critical Failure Limits (CFL) are considered to observe the time of disruptive events from the simulations, which are defined as CFL = [2/100, 5/1000, 3/1000, 1/1000]. Each limit represents an allowable threshold; e.g., 5/1000 means that the machinery is safe if it has less than five critical failures over 1000 days. If the system exceeds the CFLs, the probability that the operation will encounter major disruptions is unacceptably high. These safety thresholds are selected to show the effectiveness of the framework to estimate time-dependent failure rates, and they can be regarded as a real case according to the autonomous shipping standards [40]. The plots describe the critical failure rates per day in the system for all desired time intervals. The results demonstrate that the medium impact components can operate safely without observing critical failures between starting the

operation to days 355. That is, Group 2 components can be left unattended freely for more than a month with an acceptable risk of critical failures, although the operation should be monitored for planned maintenance to prevent further degradation of the system. Compared to this, the high-impact components (Group 1) are expected to start degradation just 15 days after starting the operation. It means that the current system may put itself at a high risk of being entirely stopped due to observing major disruptions since the engine room is intended to operate unattended for at least 500 h.

3.3. Application example for redundancy model

To avoid unexpected stops in the operation of UMP from any unwanted disruptions and extend the trusted operation time of the engine room, it is essential to increase the resilience of sensitive components by adding appropriate redundant components in the system. It is desired to design an engine room without adding full redundancy for all components, to reduce associated cost and weight while minimizing the space requirements at the same time. Therefore, following the framework proposed in section 3.2 and the discussion provided in Table 1, the redundant unit set u is selected as stern tube seal cover, sea-water, and jacket-water cooling pumps, and central cooling water pumps, while the non-redundant unit set v is selected as the gearbox, cylinder cover and exhaust turbocharger. The BN for modeling one-level redundancy of the high-impact components in Group 1 is constructed in Fig. 10. The new engine room is designed only with one redundant unit for each active part, i.e., the seals and all cooling pumps. Therefore, the level of redundancy is $L = 0.5$ and the standby coefficient for redundant components is also $\Lambda_R = 0.5$.

3.4. Results and discussion: performance analysis of redundant condition

The estimated probabilities from the BN are transferred to the RPT model for populating the tree and evaluating the new system condition. The simulation was performed for 1000 operation days, and results were compared with the non-redundant engine room, as shown in Fig. 11. The chance of observing reliable operation for the entire engine room during 1000 days in the new redundant system increased from total operation days of 156 days to 478 days (first bar and dotted line in Fig. 11-a). Although the number of observing one repair item during the operation is the same for both systems (almost 361 days in the second bar and dotted line, Fig. 11-a), it is demonstrated that the total amount of observing more than one repair in the high-impact units is drastically

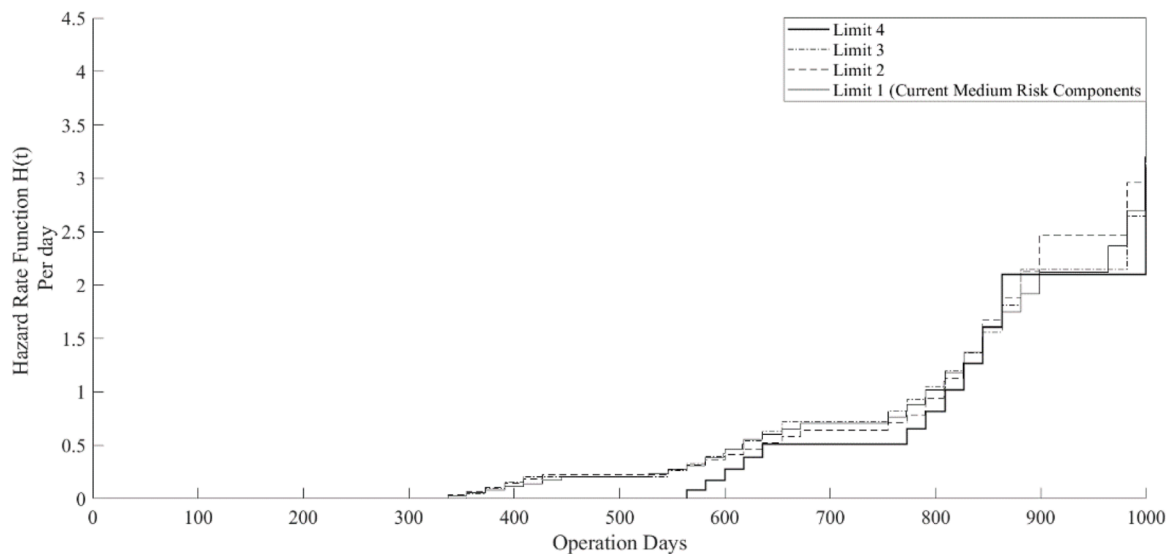

Fig. 8.. Hazard rate function H(t) for the degradation process of Group 2 components.

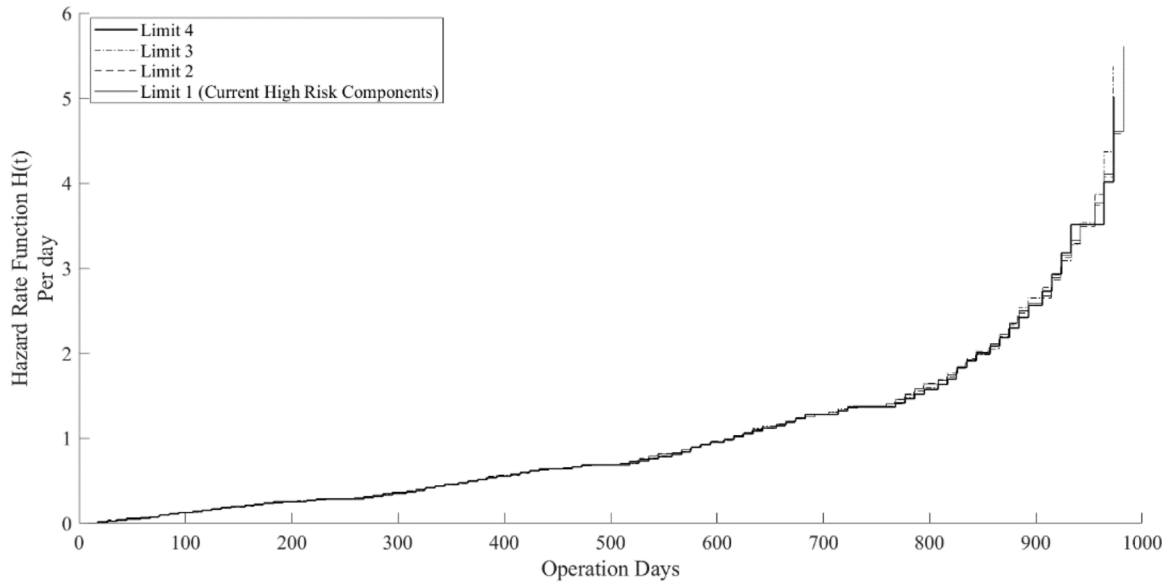

Fig. 9.. Hazard rate function $H(t)$ for the degradation process of components in Group 1.

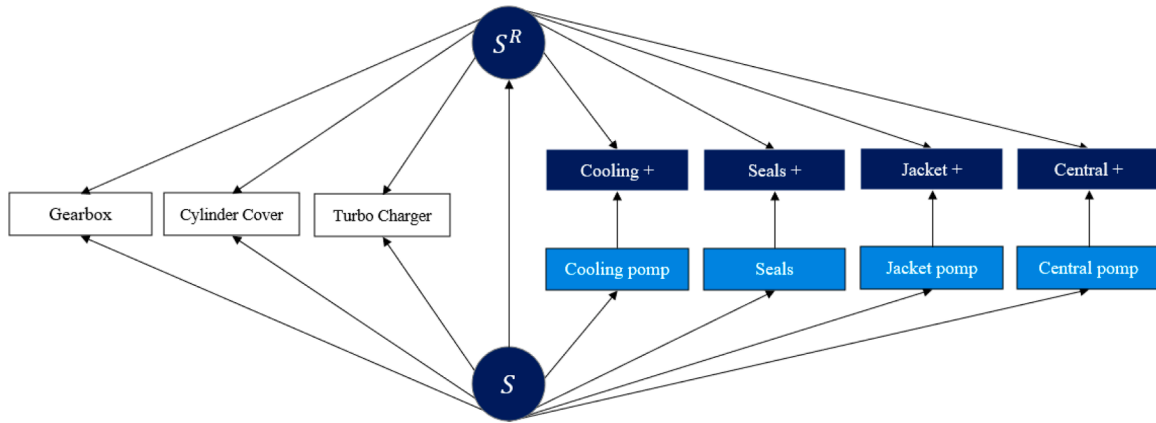

Fig. 10.. The proposed BN model for redundancy assessment of components in Group 1.

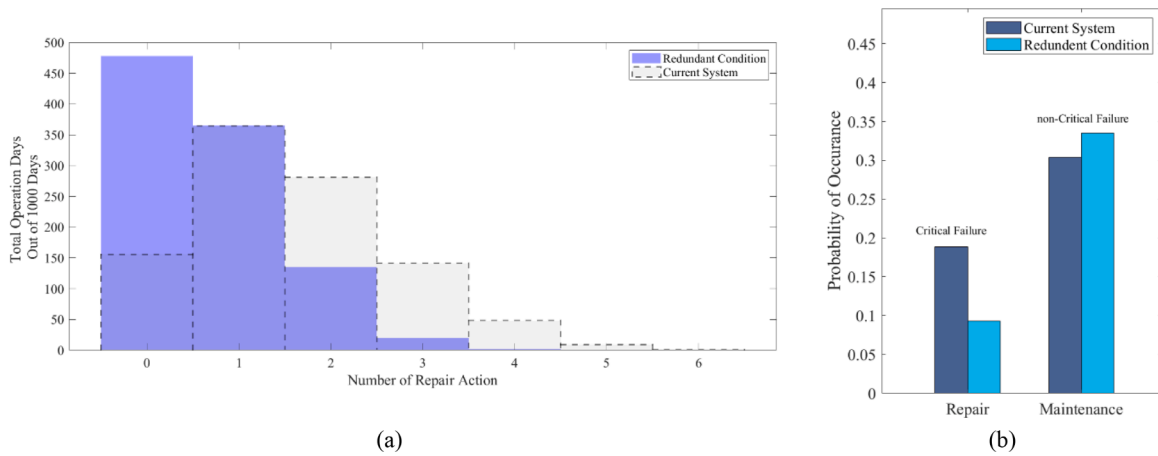

Fig. 11.. The comparison of repair requirements between the redundant and non-redundant engine room.

decreased in the redundant system. For instance, as shown in Fig. 12-a, the expected number of repairs of two and three components are decreased to 145 and 20 days respectively in the new system compare to the current engine room, which are 281 and 141 days. To predicted the

worst-case scenarios in both systems for observing critical failures (i.e., an excessive number of repair requests), extreme value analysis is performed over the samples. As shown in Fig. 11-b, it is predicted that the new system has the expected chance of observing $P(C_{repair}|S_R) = 0.09$

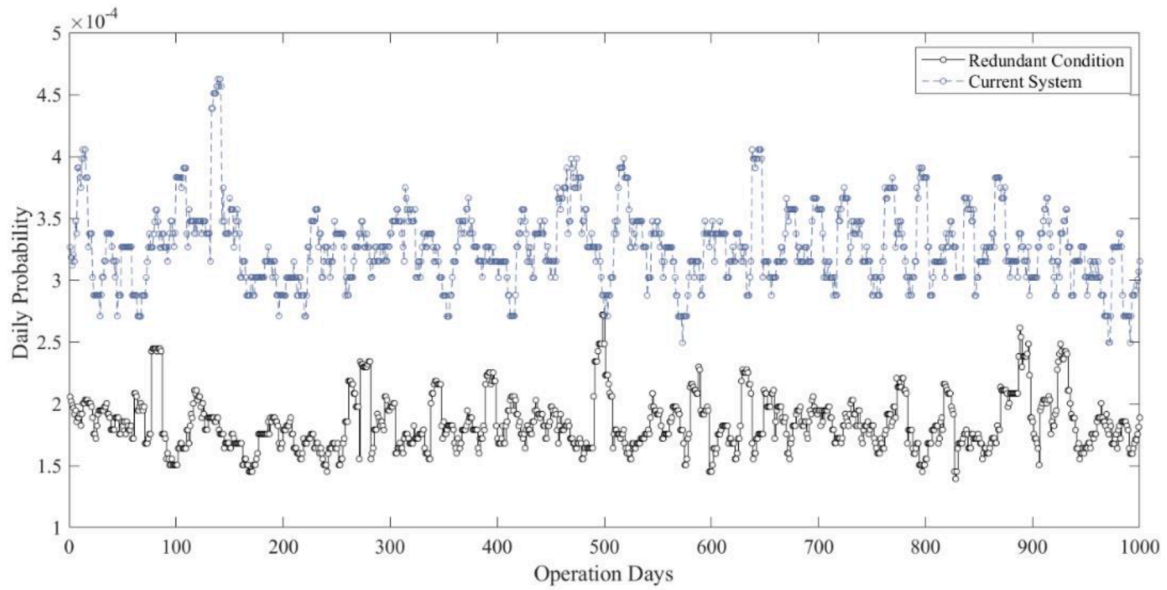

Fig. 12.. Daily probability of occurrence of critical failures during the operation.

requesting repair actions in 1000 days, while the current engine is expecting to request major repair almost twice the new engine room, which is predicted as $P(C_{repair}|S_R) = 0.18$. It means that the observing critical failures in the new system decreased almost half of the current system (Fig. 11-b), it is expected that new systems will need more planned maintenance.

Logically, the additional maintenance workload is proportional to the number of components that are made redundant. The more redundant components, the more needs for requesting planned maintenance of failed units. Otherwise, if only a few of many components are made redundant, the impact on maintenance will be small. In this study, only four sensitive components are selected for redundancy among all units in the engine room, which leads to a small amount of increases maintenance activity. The engine room components will be monitored according to the manual for regular maintenance schedules to prevent further degradation in the system, which is no different if the system is supported with redundant components. Besides, the risk of non-redundant parts (i.e., gearbox, turbocharger, and cylinder cover) for the new engine rooms remains the same as the current engine, since

these units' failure immediately leads to stop the operation.

A comparison study conducted to evaluate the degradation process between redundant and non-redundant engine room. To this end, the daily chance for observing critical events that can lead to failure of components in the engine room are plotted in Fig. 12. The quantities in the plots represents the probability of observing at least one critical component (high impact units) in the engine room per operation day. The comparison shows a considerable reduction in the chance of observing critical disruptions in the new engine room. The expected daily probability of component failure is estimated as $3.45e-04$ per day, while the new engine room stands for $1.72e-04$ accordingly. The new engine room is only supported with four redundant units (i.e., sea water cooling pumps, jacket water cooling pumps, central cooling water pumps and stern tube seal cover), while there are three other components (i.e., cylinder cover, gearbox and turbocharger) remained without redundant.

The time and number of detected component failures in both systems are shown in Fig. 13. The values in the Fig. 13 derived based on the limit of observing at least four component failures per day to show one of the

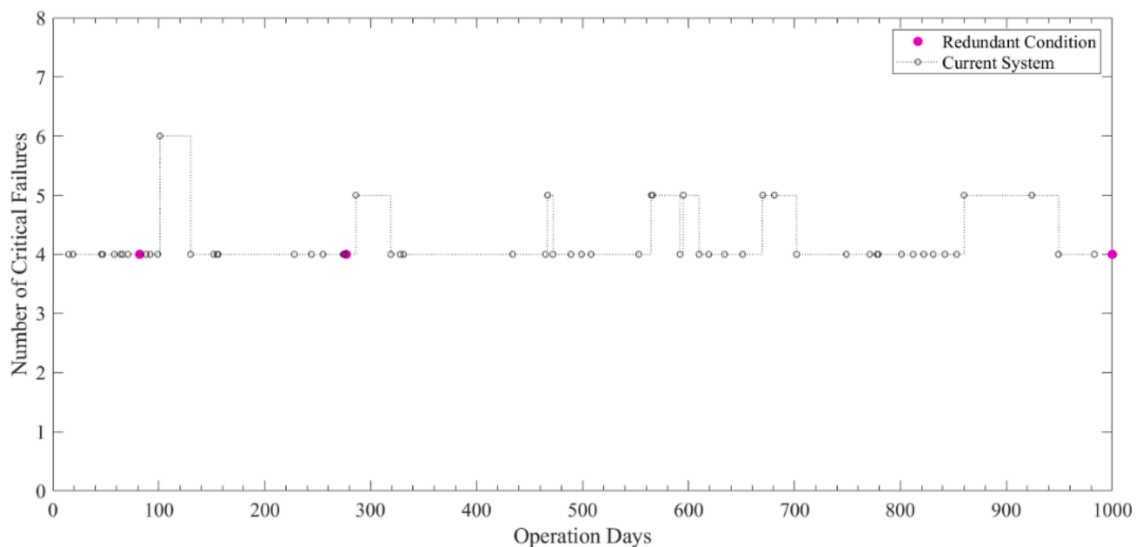

Fig. 13.. Number of detected critical failures during the operation for redundant and non-redundant engine room for 1000 simulations.

most critical condition in the degradation of UMPs in the redundant system and non-redundant system. The limit of observing four component failures is defined as an example to show the effectiveness of the present framework regarding including the redundant units in the UMPs and increasing the trusted operation time. As shown in the graph, the redundant engine room improved remarkably by observing considerably fewer disruptions in the high-impact components during the operation. However, the current engine room is expected to observe many critical failures of their units, far away from being considered a suitable case for converting a conventional ship to unmanned conditions. The observation's randomness is due to the variability of different units in the engine room and their various time to failure events. For more evaluation of the UMPs, the failure detection graphs similar to Fig. 13 can be derived based on different limitation set for observing faults. In general, assigning the limit can be defined according to the design process requirement for estimating the system's resilience in the emergence of failure events.

For further comparison, the reliability of the new system is compared with the current system, and the results are represented in Fig. 14. In the beginning of the operation, there is no significant improvement in reliability of the UMPs (less than 0.75 percent increasing in the reliability by day 20); since all components are in their new condition. Therefore, by adding relevant redundant units to the relevant components, the resilience of the new engine room is increased considerably by continuing the operation, although the reliability of the active components decreases gradually. This outcome will directly lead to increasing UMP's trusted operation period specifically for high impact components, thus considering the new engine room reliable enough to be left unattended at least for 500 h. It should be noted that the results of the current case study derived from a particular available data and cannot be inferred as a general deduction for all UMPs in the application of the autonomous ships. Due to the limited available data related to the unmanned ships and relevant failure events in the UMPs make it difficult for to infer a generic hazard rate function for all autonomous ships. Providing more information regarding the operation of autonomous shipping will highlight further to show the effectiveness of the present model, thus can integrate into more details for the evaluation of the reliability of UMPs.

4. Conclusion and future work

This study proposed a probability model for evaluating the performance of UMP in autonomous shipping and developing a predictive tool for estimating the trusted operation time of the system without human interventions. The model consists of five different steps to predict the

randomness of the process and develop a redundancy strategy to increase the resilience of the engine room under the influence of disruptions. The implementation of the model was assessed by a case study, and the results seem to be proficient for predicting the performance of UMPs. However, due to the limited operational data related to unmanned vessels, yet further investigation is needed to predict more accurate confidence intervals of trusted operation times of UMPs. For this particular case study, the redundancy approach highlights a significant change in mitigating failures of high-risk components. By comparing the case study results, the new engine room can surpass almost 67 days more than the current engine to leave all high impact components unattended safely. The model predicted the starting degradation days shifted from 15 to 82 days for the system, adding one redundancy level, which shows considerably satisfying the MUNIN goal (500 h for unmanned operation).

This study's outcomes show that adding redundancy has a considerable advantage on reducing the costly unscheduled downtime for unattended systems. This will support the industry in reducing warranty costs by preventing failures and minimizing the unplanned maintenance and repair visits of the UMPs. The model used the advent of Bayesian Inference to predict the unknown probability of parameters in the random process due to the limitation of real operation data of unmanned ships.

The presented framework, which is one of the first attempts to evaluate an UMP's performance, may bring new insights into understanding the trustworthiness of unattended engine rooms under different operational scenarios and considering the impact of redundancy for improving the resilience of the system. The method may be used to support decision-making concerning the design of engine rooms for autonomous shipping purposes and performing asset integrity assessment to meet future goals for increasing the operation time of unmanned systems. In the future, a potentially further developed version of the model could be used for more holistic analyses and considering the recovery of high-impact components in the observation of critical failures. The recovery process is an essential step to create smart maintenance for the machinery in unmanned vessels. Furthermore, it is well worth studying the impact of adopting new technologies from the organizational level, elaborate the integration of humans with new levels of automation and explore the effects of machine learning approaches (beyond Bayesian Networks) in predicting critical events onboard in the absence of crews. Additional elements need to be included in the presented predictive model, such as failure modes identification of each high impact component in operation, detecting incipient faults in the system, and determining the asset criticality

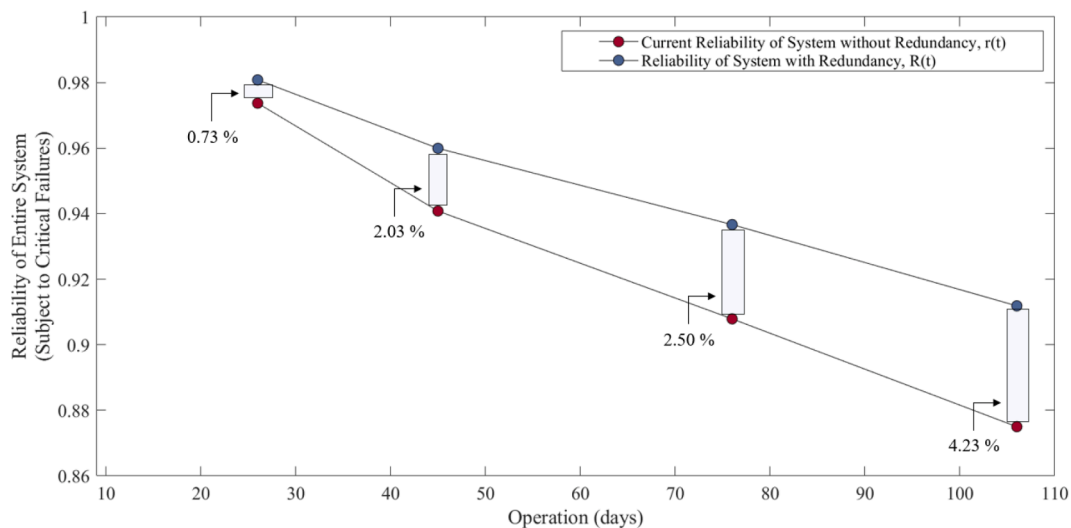

Fig. 14.. The comparison of survival conditions between the redundant and non-redundant UMPs in the engine room for the current case study.

importance before encountering unexpected maintenance requests. Besides, maritime organizations need to consider how to implement predictive models into their daily operations and validate the recently developed machine learning approaches to improve the speed and accuracy in their maintenance decision making.

Declaration of Competing Interest

None.

Acknowledgement

The research leading to these results has been conducted within the NOVIMAR project (NOVel Iwt and MARitime transport concepts) and received funding from the European Union Horizon 2020 Program under grant agreement n° 723009.

References

- [1] Rødseth ØJ, Burmeister HC. Developments toward the unmanned ship. In: *Proceedings of International Symposium Information on Ships-ISIS*; 2012.
- [2] Royce R. *Autonomous ships: The next step*. Mar Ship Intell 2017.
- [3] Corporate, A.G., Specialty (AGCS), 2014. *Safety and shipping review 2014, An annual review of trends and developments in shipping losses and safety*.
- [4] Colon J. *Identifying and eliminating weak points in ship's machinery plants: a step towards continuously unmanned engine rooms*. Delft University of Technology; 2018. Master Thesis Published at.
- [5] Man Y, Lundh M, Porathe T, MacKinnon S. From desk to field—Human factor issues in remote monitoring and controlling of autonomous unmanned vessels. *Procedia Manuf* 2015;3:2674–81.
- [6] Porathe T. *A navigating navigator onboard or a monitoring operator ashore? Towards safe, effective, and sustainable maritime transportation: findings from five recent EU projects*. *Transp Res Proced* 2016;14(2352):233–42.
- [7] Wahlström M, Hakulinen J, Karvonen H, Lindborg I. Human factors challenges in unmanned ship operations—insights from other domains. *Procedia Manufacturing* 2015;3:1038–45.
- [8] Porathe T, Prison J, Man Y. Situation awareness in remote control centres for unmanned ships. In: *Proceedings of Human Factors in Ship Design & Operation*; 2014.
- [9] Johansen TA, Perez T. Unmanned aerial surveillance system for hazard collision avoidance in autonomous shipping. In: *2016 International Conference on Unmanned Aircraft Systems (ICUAS)*. IEEE; 2016.
- [10] Theunissen E. *Navigation of unmanned vessels—history, enables, challenges and potential solutions*. *Proceeding INEC* 2014.
- [11] Burmeister HC, Bruhn W, Rødseth ØJ, Porathe T. Autonomous unmanned merchant vessel and its contribution towards the e-Navigation implementation: The MUNIN perspective. *Int J e-Navigat Maritime Econ* 2014;1:1–13.
- [12] Abaei Mohammad Mahdi, Hekkenberg Robert, BahooToroody Ahmad. *A multinomial process tree for reliability assessment of machinery in autonomous ships*. *Reliab Eng Syst Saf* 2021;210:107484.
- [13] Wróbel K, Montewka J, Kujala P. System-theoretic approach to safety of remotely-controlled merchant vessel. *Ocean Eng* 2018;152:334–45.
- [14] Wróbel K, Montewka J, Kujala P. Towards the assessment of potential impact of unmanned vessels on maritime transportation safety. *Reliab Eng Syst Saf* 2017;165: 155–69.
- [15] Geertsma RD, Negenborn RR, Visser K, Hopman JJ. Design and control of hybrid power and propulsion systems for smart ships: A review of developments. *Appl Energy* 2017;194:30–54.
- [16] Utne Ingrid Bouwer, Rokseth Børge, Sørensen Asgeir J, Vinnem Jan Erik. Towards supervisory risk control of autonomous ships. *Reliab Eng Syst Saf* 2020;196: 106757.
- [17] de Vos Jiri, Hekkenberg Robert G, Banda Osiris AValdez. The impact of autonomous ships on safety at sea—a statistical analysis. *Reliab Eng Syst Saf* 2021; 210:107558.
- [18] Dghaym D, Hoang TS, Turnock SR, Butler M, Downes J, Pritchard B. An STPA-based formal composition framework for trustworthy autonomous maritime systems. *Saf Sci* 2021;136:105139.
- [19] Aps R, Fetissov M, Goerlandt F, Helferich J, Kopti M, Kujala P. Towards STAMP based dynamic safety management of eco-socio-technical maritime transport system. *Proced Eng* 2015;128:64–73.
- [20] Chaal Meriam, Banda Osiris AValdez, Glomsrud Jon Arne, Basnet Sunil, Hirdaris Spyros, Kujala Pentti. A framework to model the STPA hierarchical control structure of an autonomous ship. *Saf Sci* 2020;132:104939.
- [21] Gil Mateusz. A concept of critical safety area applicable for an obstacle-avoidance process for manned and autonomous ships. *Reliab Eng Syst Saf* 2021:107806.
- [22] Rødseth ØJ, Burmeister H-C. Risk assessment for an unmanned merchant ship. *TransNav, Int J Mar Navigat Safe Od Sea Transp* 2015;9(3).
- [23] Ramos MA, Utne IB, Mosleh A. Collision avoidance on maritime autonomous surface ships: Operators' tasks and human failure events. *Saf Sci* 2019;116:33–44.
- [24] Ramos MA, Thieme CA, Utne IB, Mosleh A. Human-system concurrent task analysis for maritime autonomous surface ship operation and safety. *Reliab Eng Syst Saf* 2020;195:106697.
- [25] Coit DW. Cold-standby redundancy optimization for nonrepairable systems. *IIE Trans* 2001;33(6):471–8.
- [26] Aven T, Zio E. Globalization and global risk: How risk analysis needs to be enhanced to be effective in confronting current threats. *Reliab Eng Syst Saf* 2020: 107270.
- [27] Aven, T., *Rare event risk assessments*. 2020.
- [28] Abaei MM, Hekkenberg RG. A Method to Assess the Reliability of the Machinery on Autonomous Ships. In: *19th Conference on Computer Applications and Information Technology in the Maritime Industries*; 2020. Pontignano, Italy [Refereed Conference Paper].
- [29] Madni AM, Jackson S. Towards a conceptual framework for resilience engineering. *IEEE Syst J* 2009;3(2):181–91.
- [30] Ardakan MA, Rezvan MT. Multi-objective optimization of reliability–redundancy allocation problem with cold-standby strategy using NSGA-II. *Reliab Eng Syst Saf* 2018;172:225–38.
- [31] Ardakan MA, Hamadani AZ. Reliability–redundancy allocation problem with cold-standby redundancy strategy. *Simul Modell Pract Theory* 2014;42:107–18.
- [32] Ellefsen AL, Æsøy V, Ushakov S, Zhang H. A comprehensive survey of prognostics and health management based on deep learning for autonomous ships. *IEEE Trans Reliab* 2019;68(2):720–40.
- [33] Bergström M, Kujala P. *Simulation-Based Assessment of the Operational Performance of the Finnish–Swedish Winter Navigation System*. *Appl Sci* 2020;10 (19):6747.
- [34] Čepin M, Mavko B. A dynamic fault tree. *Reliab Eng Syst Saf* 2002;75(1):83–91.
- [35] Heck RH, Thomas S, Tabata L. *Multilevel modeling of categorical outcomes using IBM SPSS*. Routledge Academic; 2013.
- [36] BahooToroody A, De Carlo F, Paltrinieri N, Tucci M, Van Gelder PHAJM. Bayesian Regression Based Condition Monitoring Approach for Effective Reliability Prediction of Random Processes in Autonomous Energy Supply Operation. *Reliab Eng Syst Saf* 2020:106966.
- [37] BahooToroody A, Abaei MM, BahooToroody F, De Carlo F, Abbassi R, Khalaj S. A condition monitoring based signal filtering approach for dynamic time dependent safety assessment of natural gas distribution process. *Process Saf Environ Prot* 2019;123:335–43.
- [38] BahooToroody A, Abaei MM, Arzaghi E, Song G, De Carlo F, Paltrinieri N, et al. On reliability challenges of repairable systems using hierarchical bayesian inference and maximum likelihood estimation. *Process Saf Environ Prot* 2020;135:157–65.
- [39] Lee MD, Wagenmakers E-J. *Bayesian cognitive modeling: a practical course*. Cambridge university press; 2014.
- [40] Bureau Veritas, *Guidelines for autonomous shipping*. Guidance Note NI, 2017. 641.
- [41] Jimenez VJ, Bouhmala N, Gausdal AH. Developing a predictive maintenance model for vessel machinery. *J Ocean Eng Syst* 2020.