

**W H I T E
E L E P H A N T**

MSC 4 METHODS & ANALYSIS STUDIO
ÇAKIR / ARLANDIS / HERNÁNDEZ / JENNEN / HAVIK

I would like to express my deepest appreciation to my tutors who guided me throughout the research. This would not be possible without the support of my family and my friends. I am also grateful to Florian Reisacher, Hayley Bouza, Metin alı and Cemre Önertürk for being there for me.

Msc 4 Methods & Analysis Studio "Positions in Practice"
Master Thesis Project Research Booklet

by CEVDET EGE ÇAKIR

ALBERTO ALTÉS ARLANDIS // JORGE MEJÍA HERNÁNDEZ //
PIERRE JENNEN // KLASKE HAVIK

"Where there is power, there is resistance."
- Michel Foucault

CONTENTS

- . First Impressions
- . Workshop " Thinking Through Objects"
- . Framework
- . Homosacer
- . Research & Reference Projects
- . Analysis
- . Exclusion of Individuals: Transcripts
- . Steps
- . Wall
- . Underpass
- . Park
- . Outcomes
- . Site Analysis
- . Deconstruction of the Plaza
- . Historical Analysis





I M P R E S S I O N S

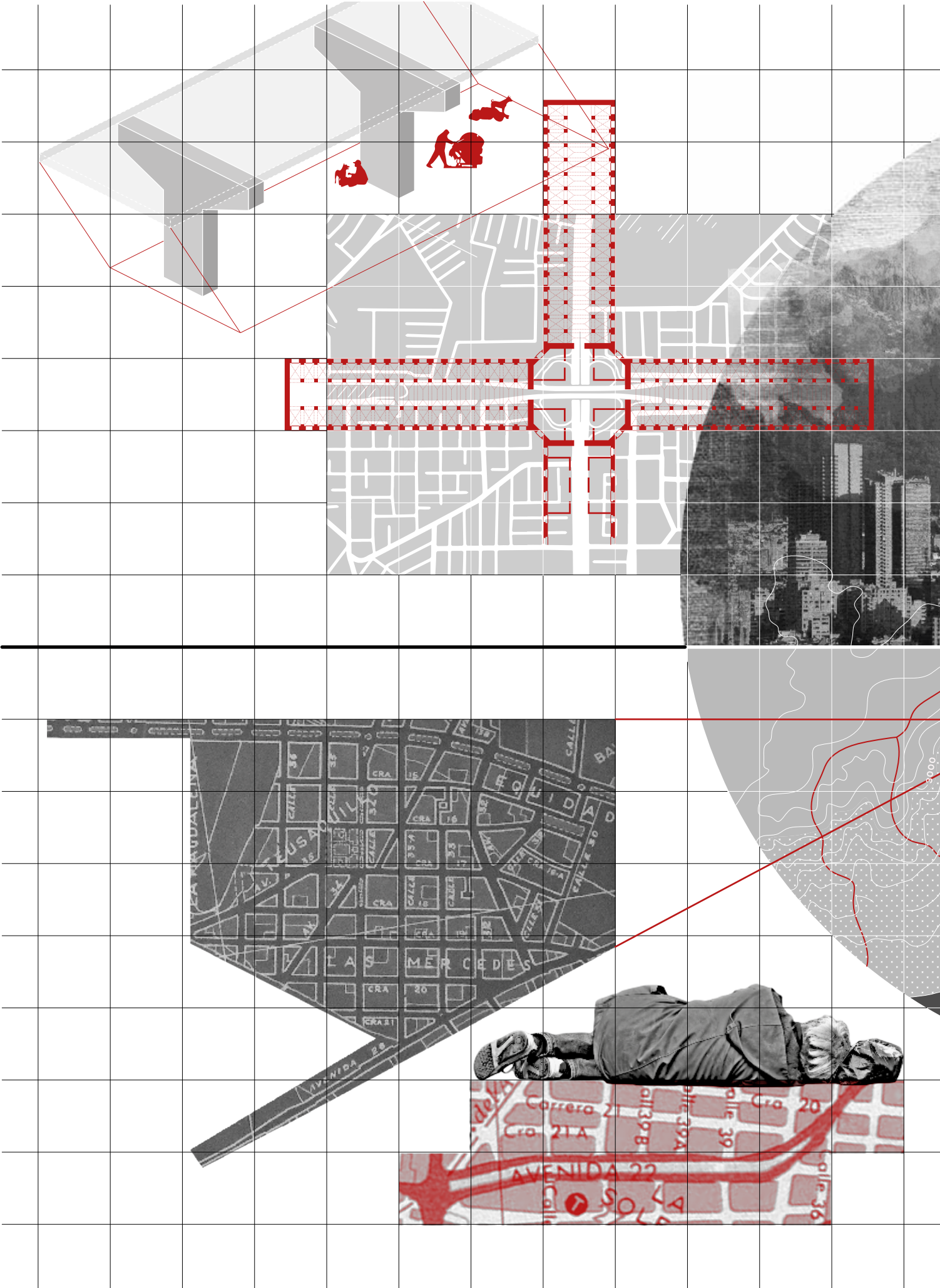

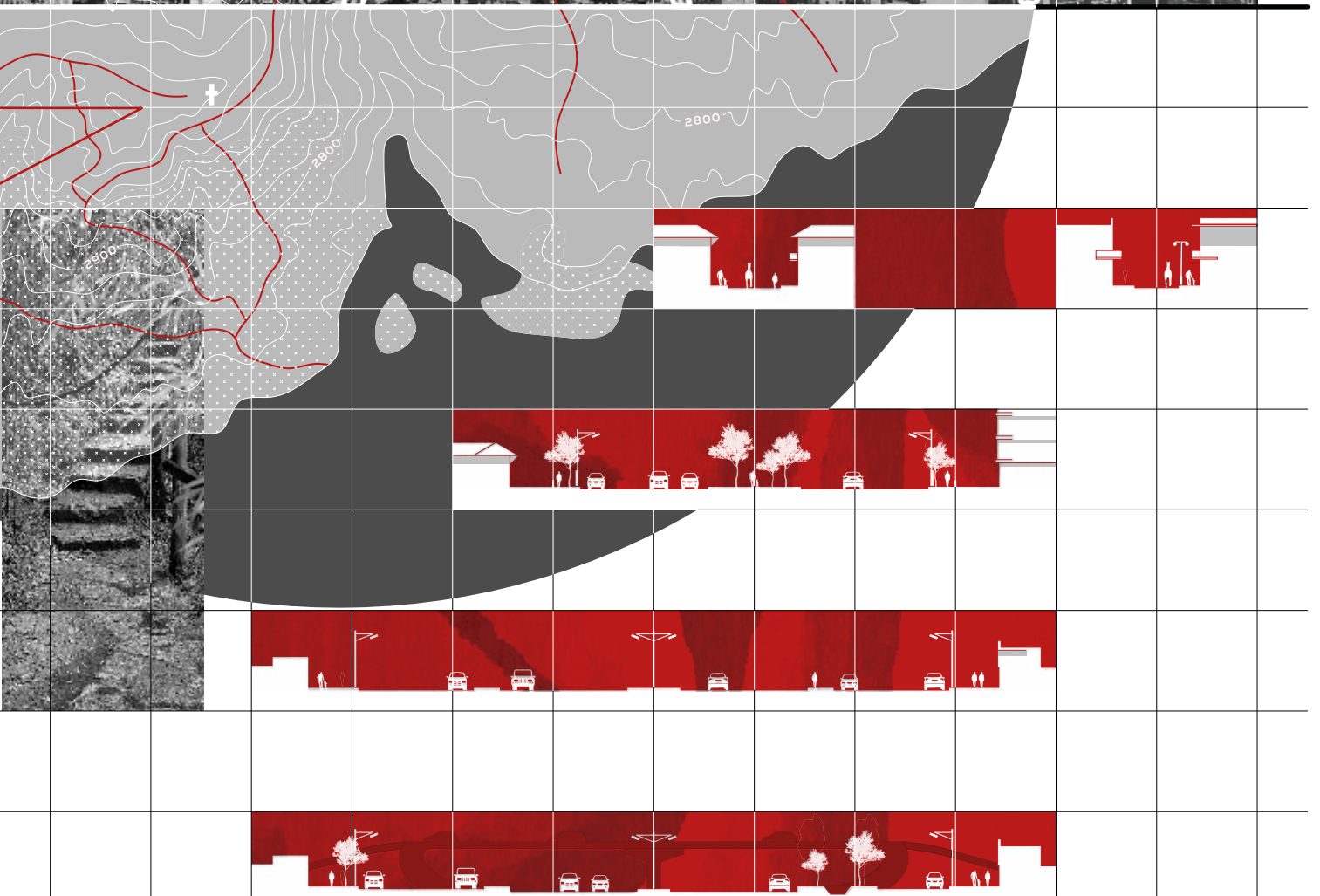
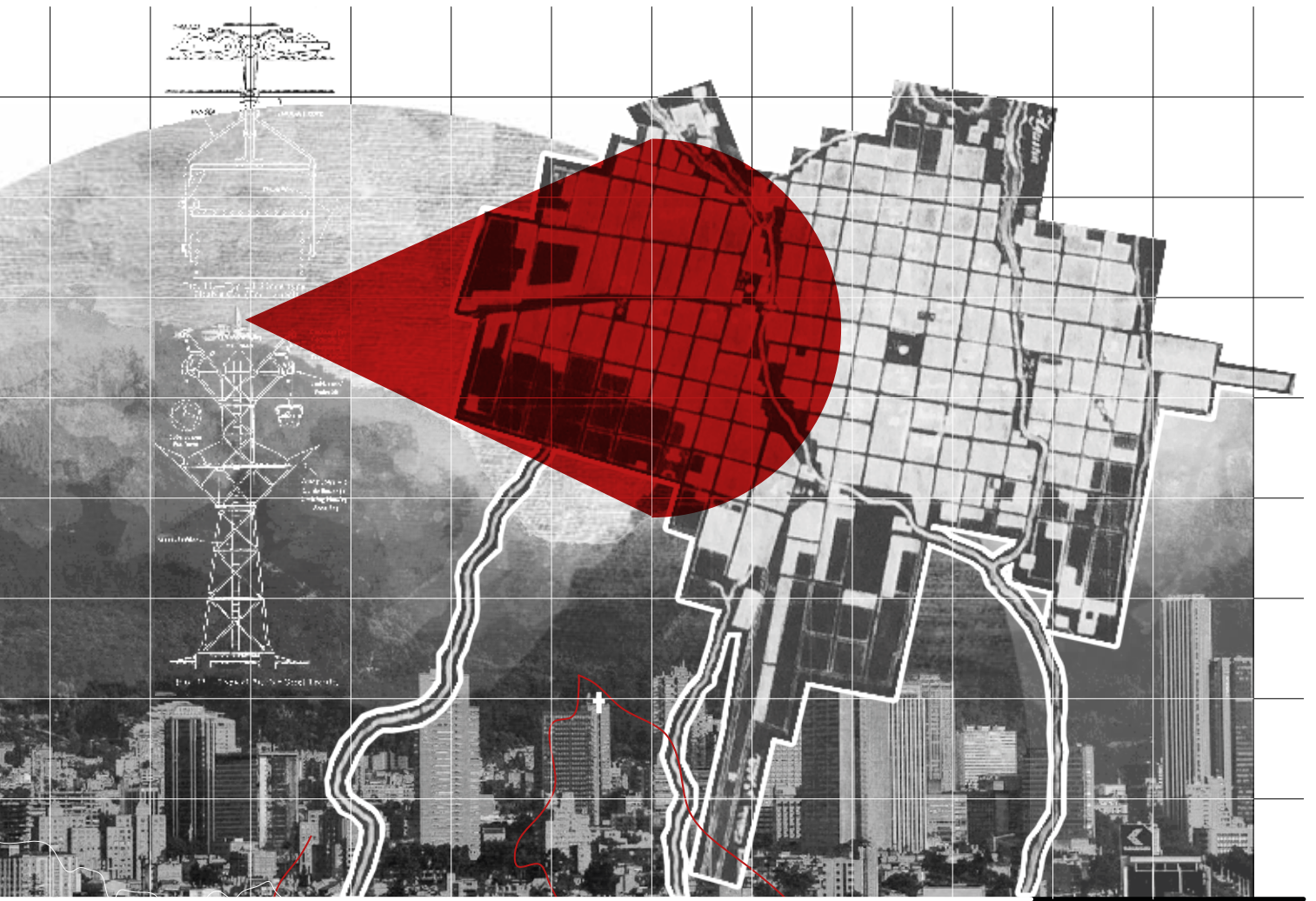



W O R K S H O P

Methods & Analysis Graduation Studio "Positions in Practice" is focused on the investigation of human actions in relation to the built environment in terms of meaningfulness, appropriation and integration in the context of the city of Bogota. This investigation initiated by the tutors during site visit by a workshop spread into three days. During the workshop, we selected a domestic object to analyze and interact with our surroundings or in other words, we tried thinking about the city through domestic objects. As I selected "pillow" as my domestic object, it guided me towards searching for privacy in the public space. As I searched intimacy and comfort in public sphere, I ended up finding the dark, inconspicuous and forgotten (abandoned) parts of the city which is occupied by the excluded individuals of the society. This seek for privacy in public may seem nonsensical or implausible yet, it directs the focus on what "real" public space is. This situation forged my initial analysis of the city and established framework and theme for my research.



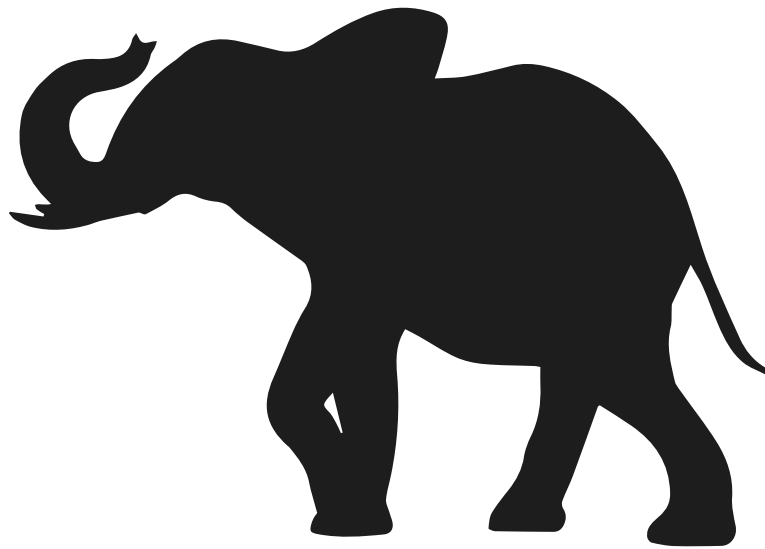

FRAMEWORK

The central point of my research is inclusion & exclusion in Public space in various forms. As I studied intimacy, comfort and privacy in the workshop, It lead me to question the relation between individuals and the public sphere. Especially excluded individuals like homeless, drug addicts, criminals and sex workers often ignored in daily life of the city as well as in the decision making. Because they are outside of what we considered as "public sphere" they are not under control of societal rules and norms. Being inside the public space, yet excluded from the public realm could lead to unique ways to interact with surrounding built environment and society. That is why, I wanted to investigate this relationship and design a public project that reflects the findings of my research and start a provocative discourse in the architectural understanding of what "public space" is.



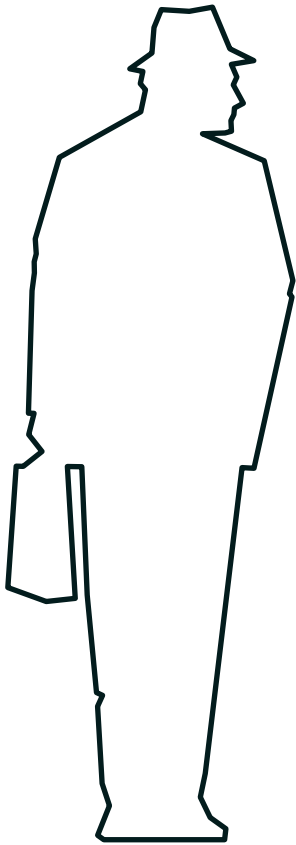

LIFE OF INDIVIDUAL

Agamben states that there are two different concepts for life according to Ancient Romans¹.

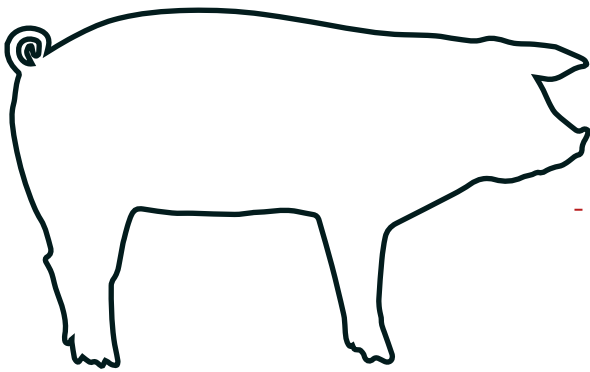



BIOS > POLITICAL LIFE

Bios/Political life is given by the society and describes the life of individuals inside the Polis. He borrows the term from Ancient Roman Law where bios is given to individuals by the sovereign power.



ZOE > BARE LIFE

According to Ancient Roman Law, Zoe is the life that every living being have. Thus, Citizens of polis inherits both bios and zoe. However, Zoe is given by the God therefore it is sacred and cannot be taken away from individual.

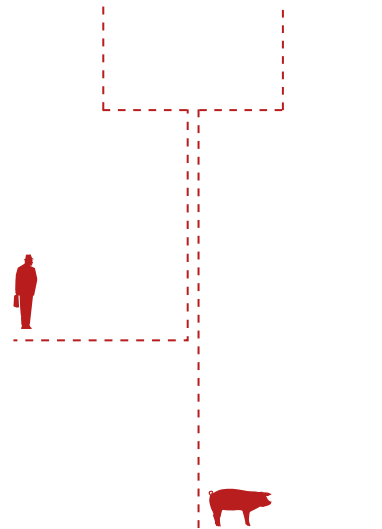

HOMO-SACER

As an individual inside the community, man has "bios" and as a living being, man also has "bare life". However, since it is assigned by the society, -bios can be taken away from the individual by the power holders. In this case, when an individual's right to live in the community is taken away, S/he is reduced only to "bare-life" by the total exclusion from the society. These individuals called *Homo-Sacers*. In contemporary society, The State approach of citizens as subjects, as individuals, conflicts with the legal frame that sees them as objects, as bare-life. Thus, creating Homo-Sacers.



OCCUPATION OF POLIS

Unlike the ancient romans, In contemporary society, Homo-Sacers still occupy the city although they are excluded from the social realm. They are a part of built environment, yet their relationship with society is limited. As they are excluded from the political life, they are less bounded to social norms & rules. Therefore, their actions differs from the ones considered as "normal". Their movement and actions are not dictated, they disobey every rule and norm of the society.



VIA EVENTS

Homo-Sacers, the ones that are excluded, occupies the city through independent and spontaneous events that are not directly dictated with the surrounding built environment. These acts are unexpected & uncontrolled.



VIA MOVEMENT

Excluded, the abnormal, also occupy the space of normal via their irregular movement through the space. Their existence in the city is deeply bounded to their movement through the city where they collect, recycle and shelter to survive.

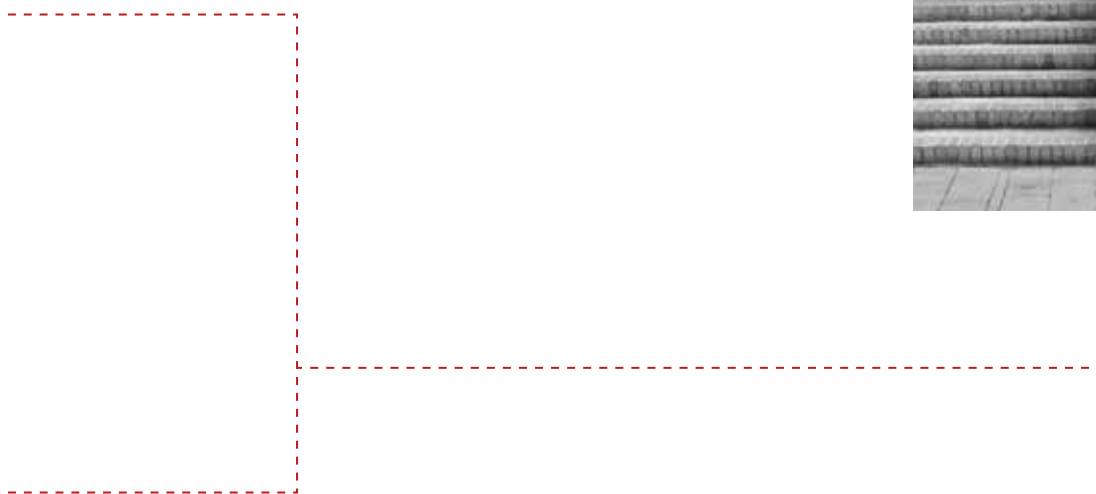

RELATIONSHIP WITH POLIS

As they occupy the polis via movement and via spontaneous events, they form an unofficial relationship with city.

However, this is different than what a "normal" individual experiences with the city. It is not bounded to what city or built environment dictates. They occupy the city by their transgressive acts and re-appropriation of the built infrastructure of the city. Thus, city "reacts" accordingly, sometimes with indifference or reciprocally, sometimes with conflicts.



INDIFFERENCE

The act of making no difference. When spaces and events are functionally independent of one another. one observes a strategy of indifference in which no architectural considerations depend on utilitarian ones, in which space has one logic.



RECIPROCY

The condition of being reciprocal: a relationship in which there is mutual action, influence, giving and taking, correspondence etc. between two parties or things.



CONFLICT

Most relations, of course, are more complex. You can also sleep in your kitchen. And fight and love. Such shifts are not without meaning.





. Grosz, Elisabeth A., and Peter Eisenman. Architecture from the Outside: Essays on Virtual and Real Space. Cambridge, Ma: MIT Press, 2006. // Research for the paper about the methods I am using and point of view of my architectural approach.

. Agamben, Giorgio, and Daniel Heller-Roazen. Homo Sacer: Sovereign Power and Bare Life. Stanford: Stanford University Press, 2016. // Framework of the research & analysis, bringing some related terms from acknowledged studies

. Tschumi, Bernard. Manhattan Transcripts. London: Academy Editions, 1995. // Depiction & Design of the diagrams

. Foucault, Michel. The History of Sexuality. Vancouver: Crane Library at the University of British Columbia, 2009. // Framework of the research & analysis, bringing some related terms from acknowledged studies

. Foucault, Michel. Discipline and Punish: The Birth of the Prison. New York: Vintage Books, 1995. // Framework of the research & analysis, bringing some related terms from acknowledged studies

. Deleuze, Gilles, and Seán Hand. Foucault. Minneapolis: University of Minnesota Press, 2016. // Framework of the research & analysis, bringing some related terms from acknowledged studies

. Spencer, Douglas. "Architectural Deleuzism: Neoliberal Space, Control and the 'univer-city'." Radical Philosophy 168. July/August 2011. Accessed December 5, 2018. www.radicalphilosophy.com. // Understanding the inclusion and control of the public space

. Diken, Bülent, From Refugee Camps To Gated Communities: Biopolitics And The End Of The City, Citizenship Studies, 8:1, 83-106, 2004. // A study borrowed similar terms and analyzed the situation of gated communities

. Harman, Graham. Object-oriented Ontology: A New Theory of Everything. London: Pelican Books, 2018. // Changing the position of the architect & architecture by a relatively new approach to ontology

. Gage, Mark Foster. "Killing Simplicity: Object-Oriented Philosophy In Architecture." Log, no. 33 (2015): 95-106. <http://www.jstor.org/stable/43630853>. // Understanding the new all-inclusive philosophy of OOO and apply it to the design.

. Wim Cuyvers, Public Space. (n.d.). Retrieved from <https://www.readingdesign.org/public-space>. // Understanding transgressive "real" public spaces and try to include them into the public realm

. Fabrizi, M. (2018, February 10). A Growing, Incremental Place – Incremental Time: "Victims", a... Retrieved from <http://socks-studio.com/2015/11/01/a-growing-incremental-place-incremental-time-victims-a-project-by-john-hejduk-1984/> // Designing of the characters & spaces of the project and understand how to create relations between them

. Venturi, R., & Scully, V. J. (1966). Complexity and contradiction in architecture. New York: Museum of Modern Art. // Understanding my own approach from the Post-Modern point of view.

. Armbrorst, T., DOca, D., Theodore, G., & Gold, R. (2017). The arsenal of exclusion & inclusion. New York: Actar. // Understanding how cities include & exclude certain social groups in various contexts.

. Latour, B., & Porter, C. (1993). We have never been modern. Cambridge, MA: Harvard University Press. // Understanding the relation between objects & their interaction in larger context

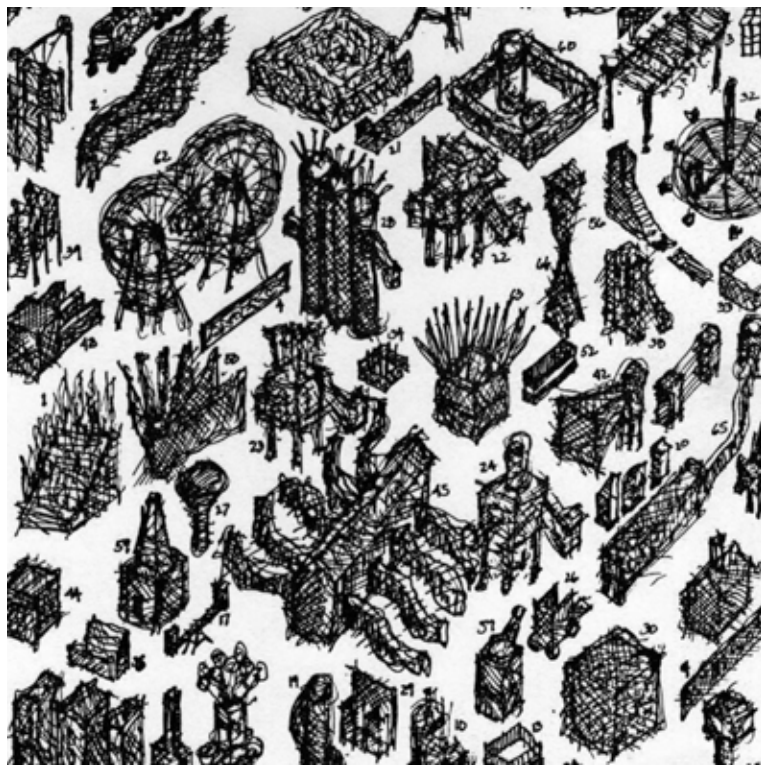

"Victims" By John Hejduk

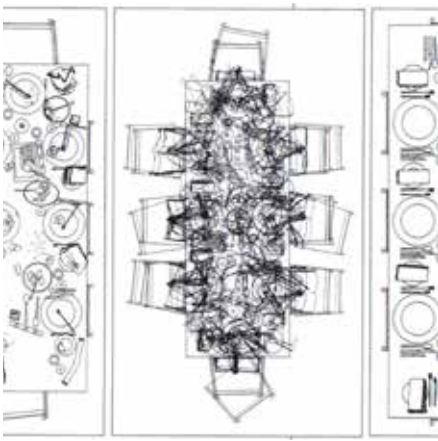
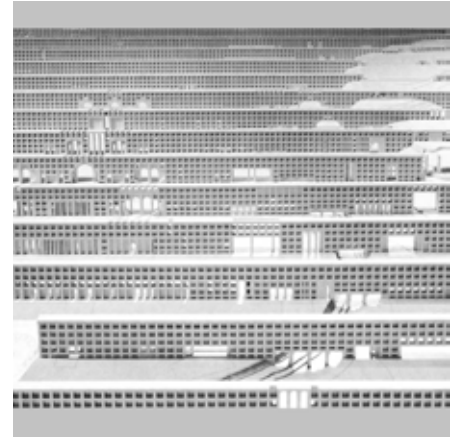

Images from reference projects, archives, installations, acts and case studies

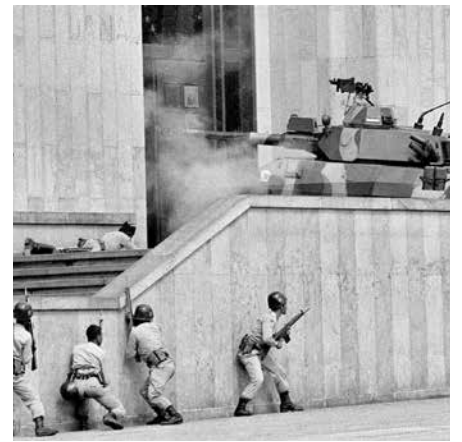
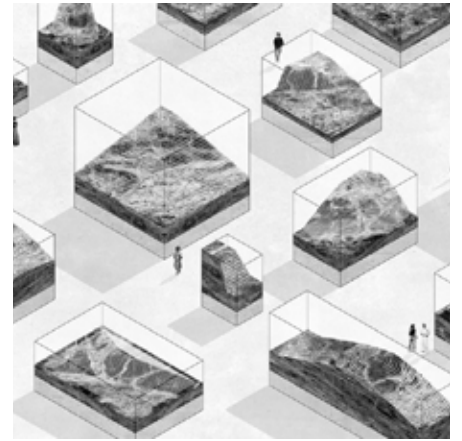

El futuro es de todos Secretaría de Transparencia

Inicio La Secretaría El Secretario Estrategia

Estado Elefantes Blancos

Ver informe de Elefantes Blancos

« Regresar

Nombre de la obra	Vista previa	Departamento	Municipio	Entidad resp
Obras de Construcción del Colegio "Angelino Garrón"		Valle del Cauca	La Unión	Administración de la Unión Valle del Cauca y el Departamento
Construcción del alcantarillado de aguas lluvias en la urbanización Siglo XXI		Valle del Cauca	Jamundí	Fondo para la Prosperidad Se Fondo de Inve la Paz



Images from reference projects, archives, installations, acts and case studies





PUBLIC SPACE EXCLUSION



EXCLUDED INDIVIDUALS



OBJECTS OF EXCLUSION



EXCLUDED INDIVIDUALS

STEPS
WALL / FENCE
OVERPASS
PARK

RIVERBED
PARKING LOT
UNDERPASS
BENCH
DEAD ENDS

DARK CORNERS
FENCES
TRAM TRACKS
COURTYARDS
POLES / POSTS
TREES & GREENERY
SIDEWALKS
TRAFFIC ISLAND

S T E P S

As it allows access to the ground floor, the steps of the buildings in Parkway defines the border between privately owned space and public sphere. By creating a height difference, ground floor is separated from the busy street, excluding the street from inside both physically and visually. Passerby is kept out in every way by an object of accessibility, the stairs. As you climb up step by step, you slowly enter the exclusive space of the residents which is monitored by cameras and sometimes patrolled by a security guard. For residents, these measures create a sense of safety while projecting hostility towards the outsiders. That is why, the steps are perceived as an object of exclusion although they serve to create access.

However, this instrument of exclusion is reframed by the passerby; the steps become an urban furniture to sit on, it becomes a place to pause, to meet and socialize. It even can be seen as privately owned public space (POPS). A stranger sitting on the steps of the building is occupying the space in between public and private sphere which is only meant to be transitory. The occupation perceived with indifference and does not create any conflict until the residents need to pass through. In this case, force of exclusion directs the passerby to different uses and meanings of the space.

The occupation of the stairs reaches to its extreme in the case of Homo-sacers, the ones excluded from the public space. The utmost exclusion forces them to seek other possibilities to occupy the space. In the eyes of Homo-sacer, the steps are not exclusive or transitory in the same sense; they are places to shelter and dwell for a limited period of time until they are exiled. They occupy the space and use it in every way possible.

In this case, the force of exclusion decides the use of the space: included sees it as a mean of accessibility, passerby reframes it as a place to pause and the excluded occupies and dwells it. That is why, one can say that the act and impact of the act in public space is directly proportional to the forces of exclusion: the utmost forces induce the extreme usage of the space.

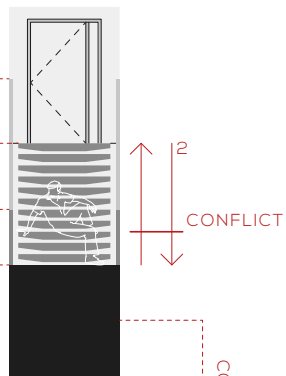
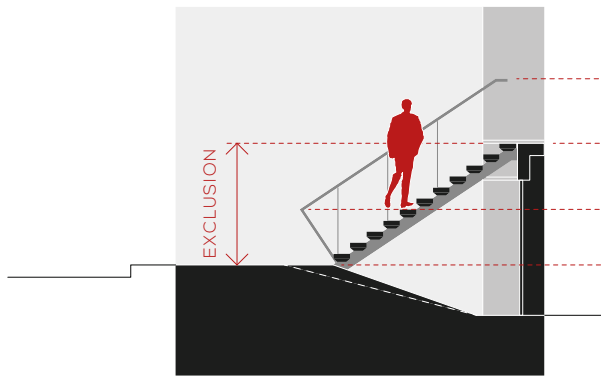
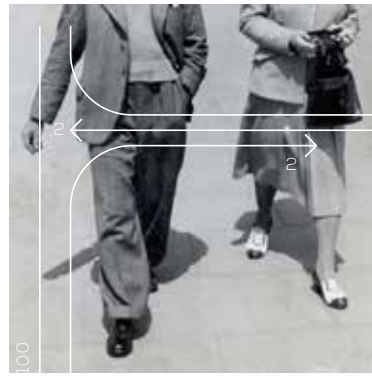
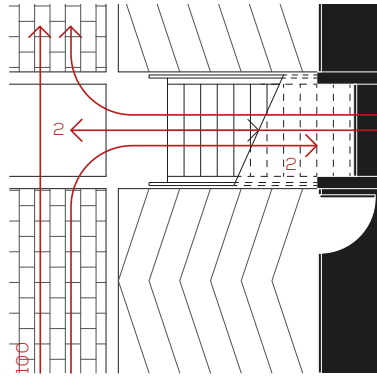

CONSENSUS

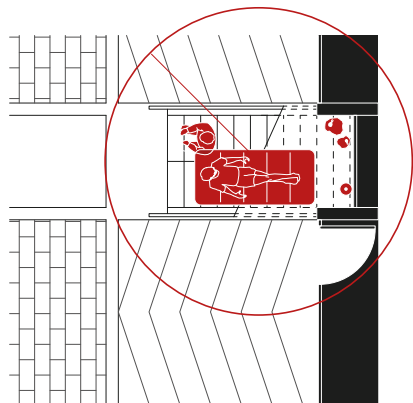

INDIFFERENCE
 CONFLICT
 CONSENSUS
 RECIPROCITY



■ Parkway

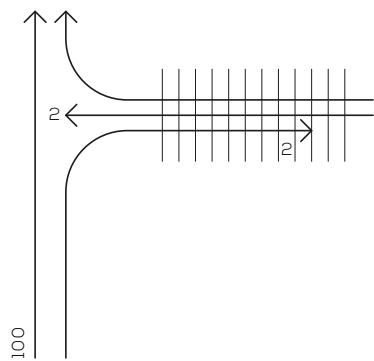

■

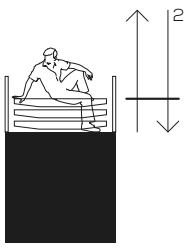

■ Calle 63

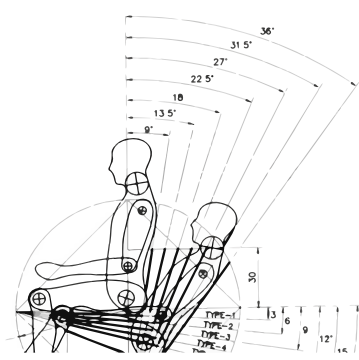

■ Carrera 24

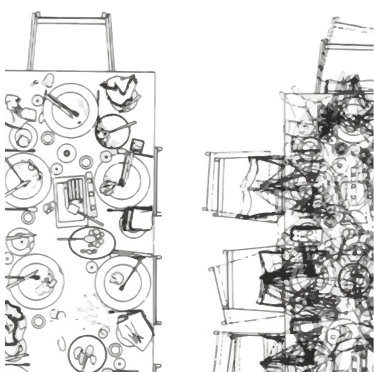

W A L L

The wall outlines the border between public sphere and private property in the streets of Teusaquillo. The streets and the streetscape is defined by these walls, half walls and fences that lies between the sidewalks and gardens of the buildings. They prevent the possible intrusions and sometimes block visual & physical contact from outside. Even though they are not fully enclosing the property, they guide the human movement towards the favorable routes and excludes possible unwanted movement like cutting through grass.

On the other hand, similar to the stairs, the passerby reframes the object that defines the border. The search for comfort and rest directs the passerby to the wall: S/he leans, sits and lies on it to rest. Even though s/he cannot do these things in a fenced wall, s/he still interacts with it by touching, hitting and making sounds with the bars of the fence. Thus, the passerby uses the wall in totally different perspective than the included inhabitant who sees it as a mean of security.

In the extreme case, in the ultimate exclusion, Homosacer are using it as a shield from the public sphere for visual privacy. They hide behind the half walls to sleep as well as conduct illegal activities. It is not a place to dwell but to have a pause in their continuous movement inside the city. It is a stop in their never ending journey that keeps them alive and for them, it is an instrument for excluding themselves further to escape from the public sphere.

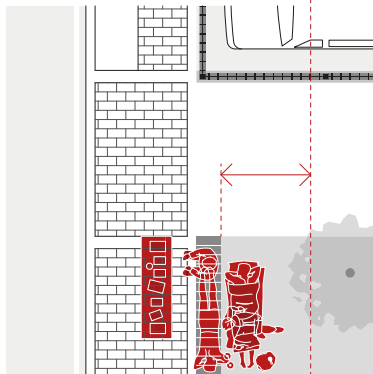
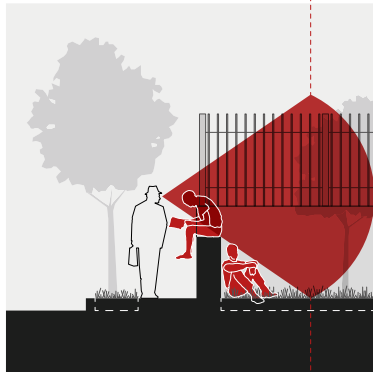
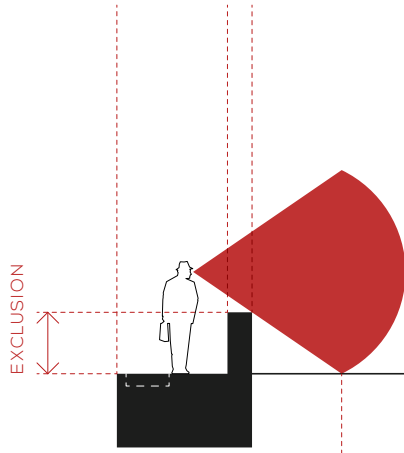
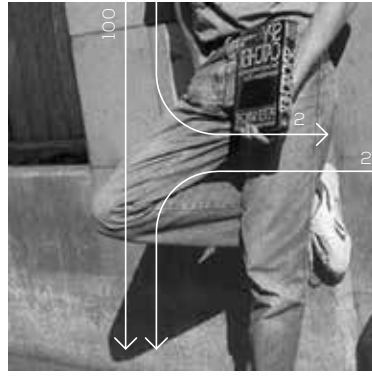
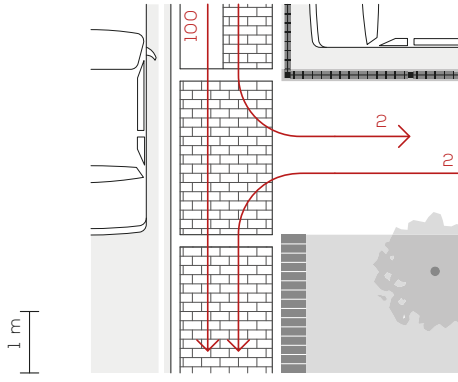

■ Carrera 24

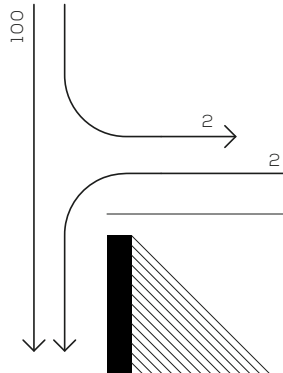

■ by Richard McColl

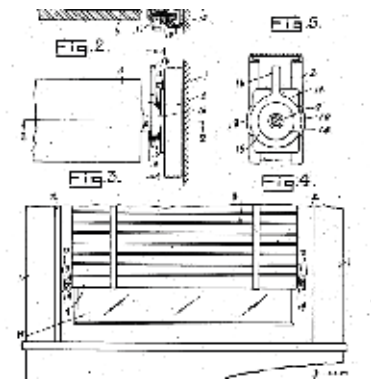
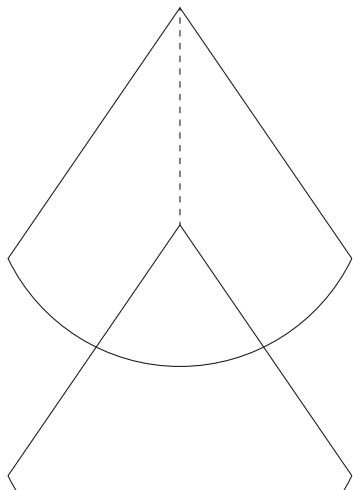

■ Calle 42

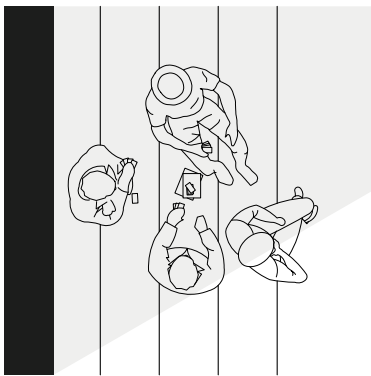

U N D E R P A S S

The bridge whether it is pedestrian or vehicular, is meant to separate different types of flows in different directions and speeds to reduce the conflict between them. It isolates pedestrians from dangerous traffic by creating underpass and overpass. It serves as a restrictive element that excludes the vehicular traffic from the public space.

However, it is more than just a division of the flows for excluded inhabitants of the city. They inhabit the dark corners of the underpass together and create a communal place to dwell. They use the bridge as a megastructure roof to protect themselves from bad weather conditions and they collect objects and place it around them to create some privacy. The uninhabitable space below the bridge becomes a place to dwell with the occupation of homo-sacres: they live, socialize and conduct economical activities under the bridge which is not meant to be occupied at all. In the end, underpass, a place of unfamiliarity and discomfort for a regular citizen, becomes the city of excluded inhabitants.

The two brothers living under the vehicular bridge on calle 100 illustrate this idea clearly. Chapinero police in 2016, while chasing a criminal, found the DIY dwelling of the two brothers next to the western support of the bridge. They had mattresses, a tv, fridge and living room furniture that create the comfort of an house. They made living by collecting & recycling and they were living with some other street dwellers from time to time. In this way, they didn't create a dwelling for themselves only but for anyone who needs a shelter. Because of the fact that it is an uninhabitable and "useless" space, until this event, the city perceived them with indifference and they were living in consensus with the city. During the time, they interiorized the bridge as their home. Their existence is bounded to their exclusion from the society under the bridge, that is why, they refused the offer to be relocated although the municipality offered them a place to stay.

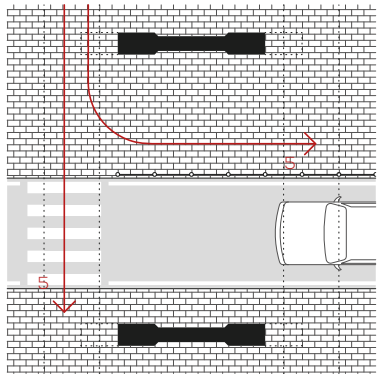
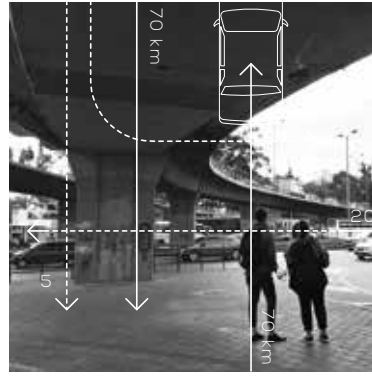
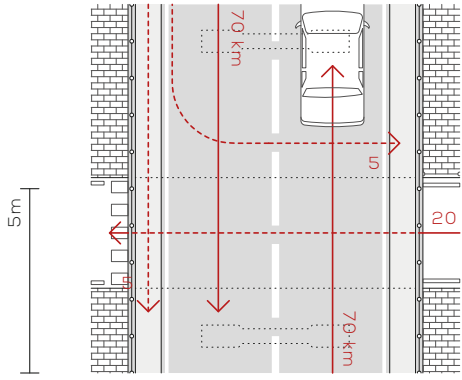

RECIPROCITY

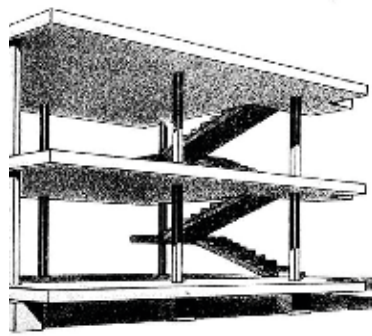
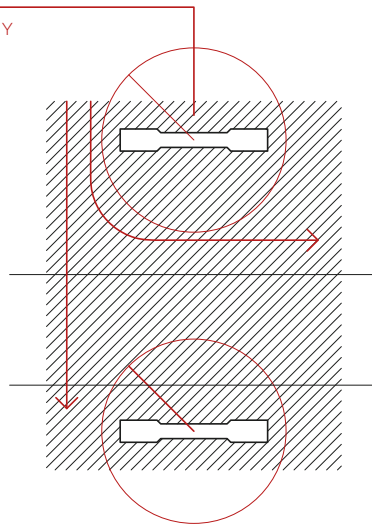
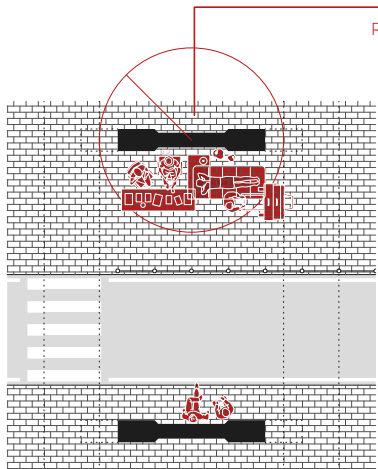

by Camilo Monzón Navas

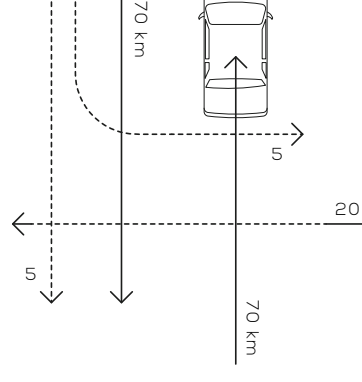

Avenida NOS

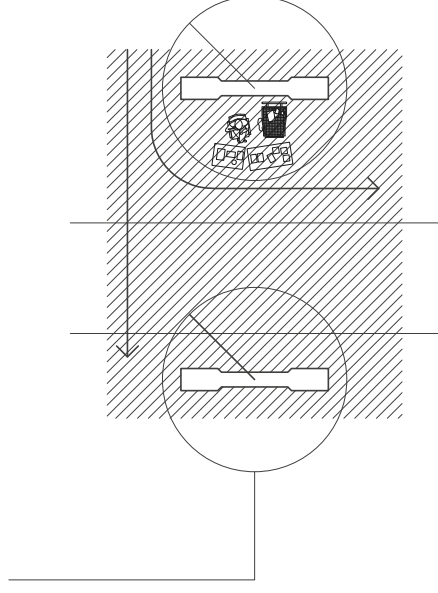

Calle 45



Calle 100 x Carrera 15*

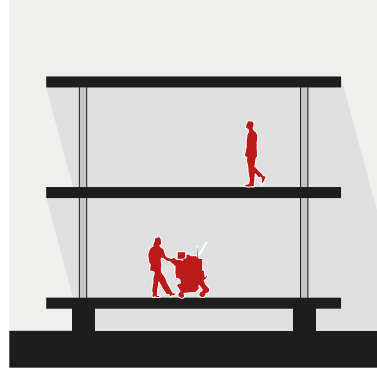

P A R K

Apart from other examples, park is one of the inclusive entities of built environment. The park, especially Parkway, creates space for leisure and recreational activities. It provides shade, comfort and relaxation for all the inhabitants for the city. Because of the fact that it is not confined with any means of exclusion like fences or gates, it allows anyone to use it in any way imaginable unlike its counterparts in US. That is why it is possible to witness a homeless person sleeping next to people doing yoga or next to children playing. It is also quite likely to see people from surrounding neighborhoods using the park for recreational purposes. That is why street vendors also see the park as an opportunity to sell their products to broader community. Conclusively, park is an ultimate object of inclusion in the city.

In the case of the excluded inhabitants, Homo-Sacers, the condition is almost the same: they are free to occupy it to a certain extent. Unlike the other examples, they are not confined in a small space between the physical and non-physical boundaries. The park does not have any boundaries, it consists of attraction points like benches, trees and playgrounds so Homo-Sacers' movement and occupation is not limited by the objects of exclusion yet by the attraction points. Thus, their usage of the Park differs from the rest. They spread more into the park, occupying various parts with different aspects, the bench to beg, the tree to lean on and grass to rest.

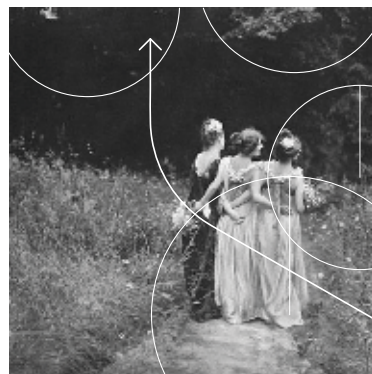
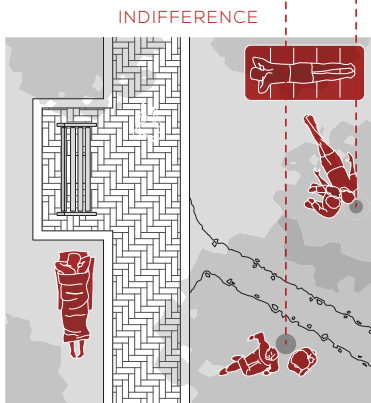
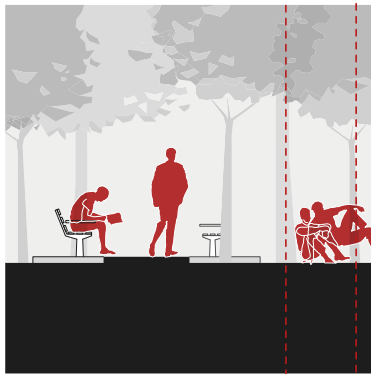
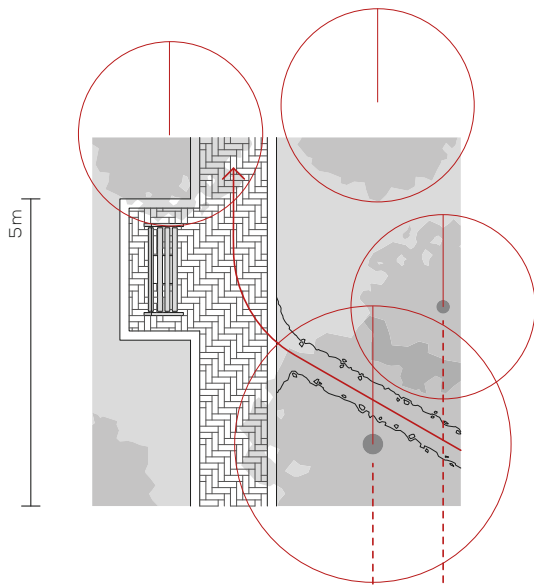

■ Parkway

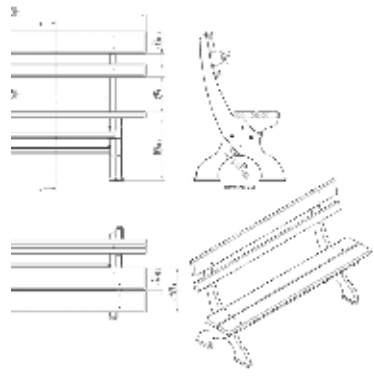

■ Diagonal 42A



■ By Richard McCoil

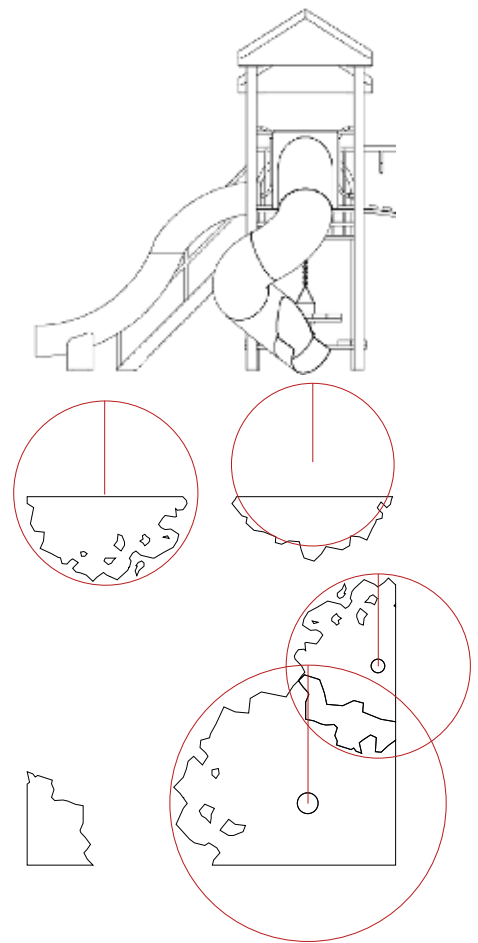

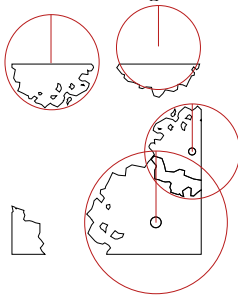
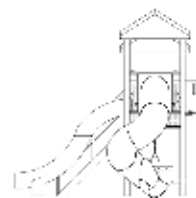
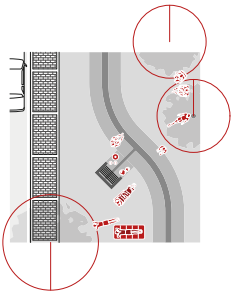
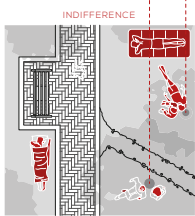
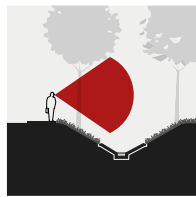
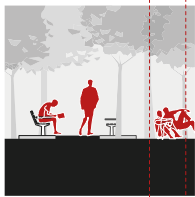
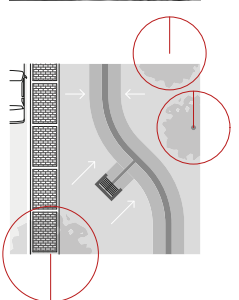
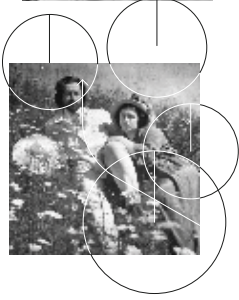
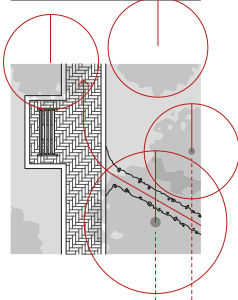
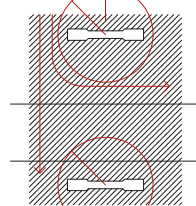
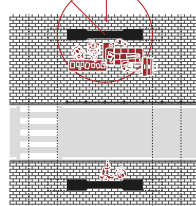
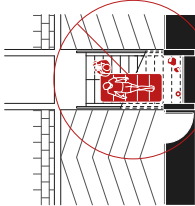
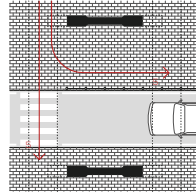
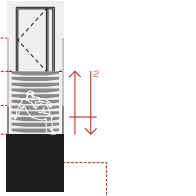
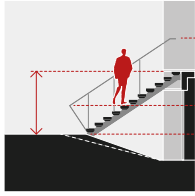
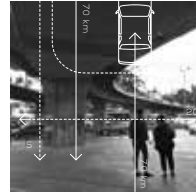
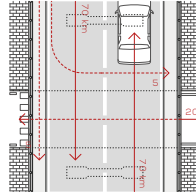
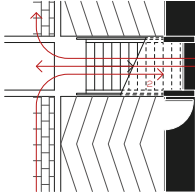

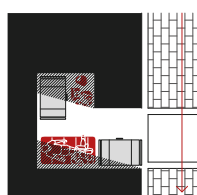
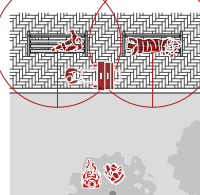
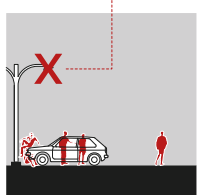
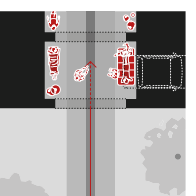
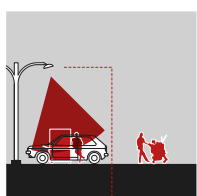
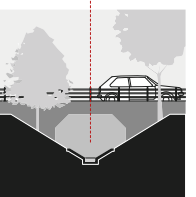
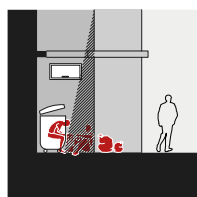
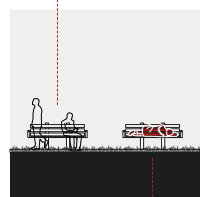
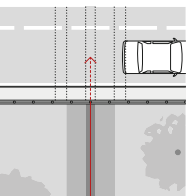
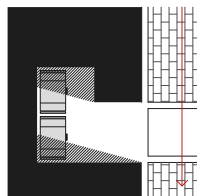
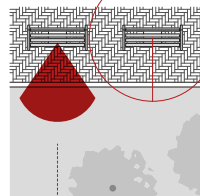
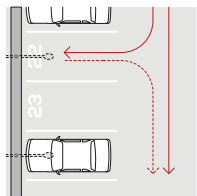
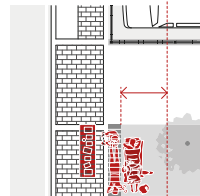
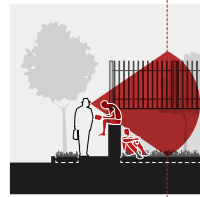
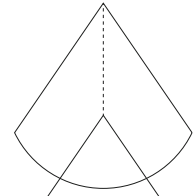
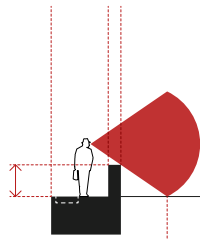
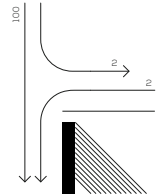
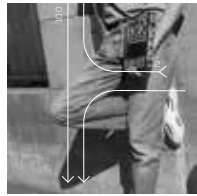
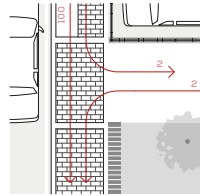



. Exclusion derived from various sources affects every individual in varied levels which is heavily bounded to the specific place and time.

. Not only individuals but also objects and spaces can be affected by exclusion which prohibits the use and hinders the existence of it.

. Excluded individuals/objects/spaces inhabit the public space and yet they are outside the public realm and they are not bounded to societal rules and norms. That is why, their actions cannot be controlled by neither built environment or social influences.

. Architect/ure can't dictate the function of the space, the amount of exclusion determines the use; when the forces reaches to its maximum, individuals seek to find new functions to add the space.

. Integration, in conventional manner, is not a solution because their (excluded individuals/objects/spaces) existence is heavily bounded to their exclusion from the public sphere.

. Instead, "inclusion" is the expansion of the attention towards exclusion rather than the integration. The aim is not to "normalize" the "abnormal" but allowing it to exist. In other words, integration is about restoring the situations of exclusion to presence by understanding the elements of inclusion & exclusion in public space.



SITE ANALYSIS: PLAZA DE BOLIVAR



IS IT INCLUSIVE?

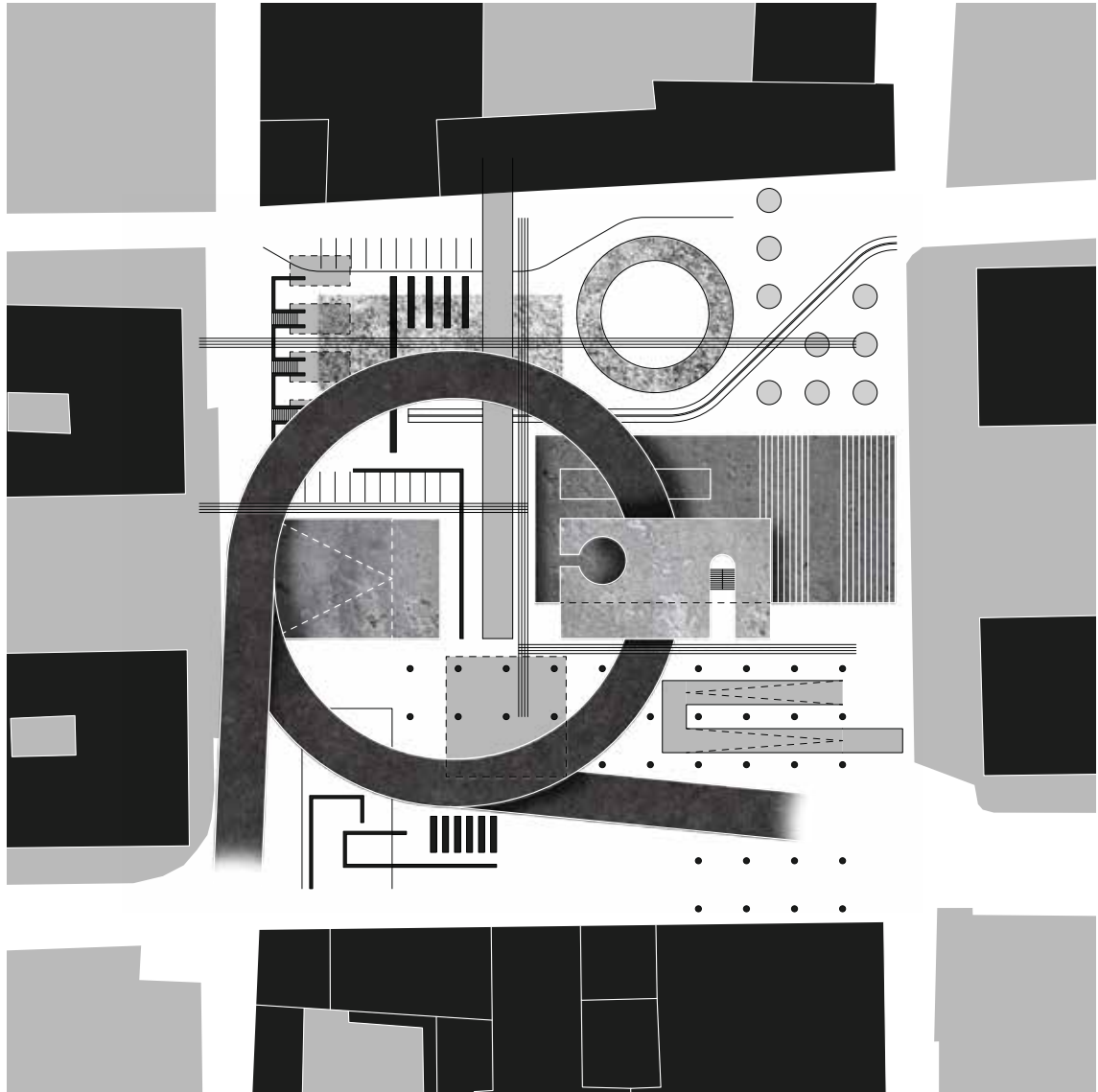

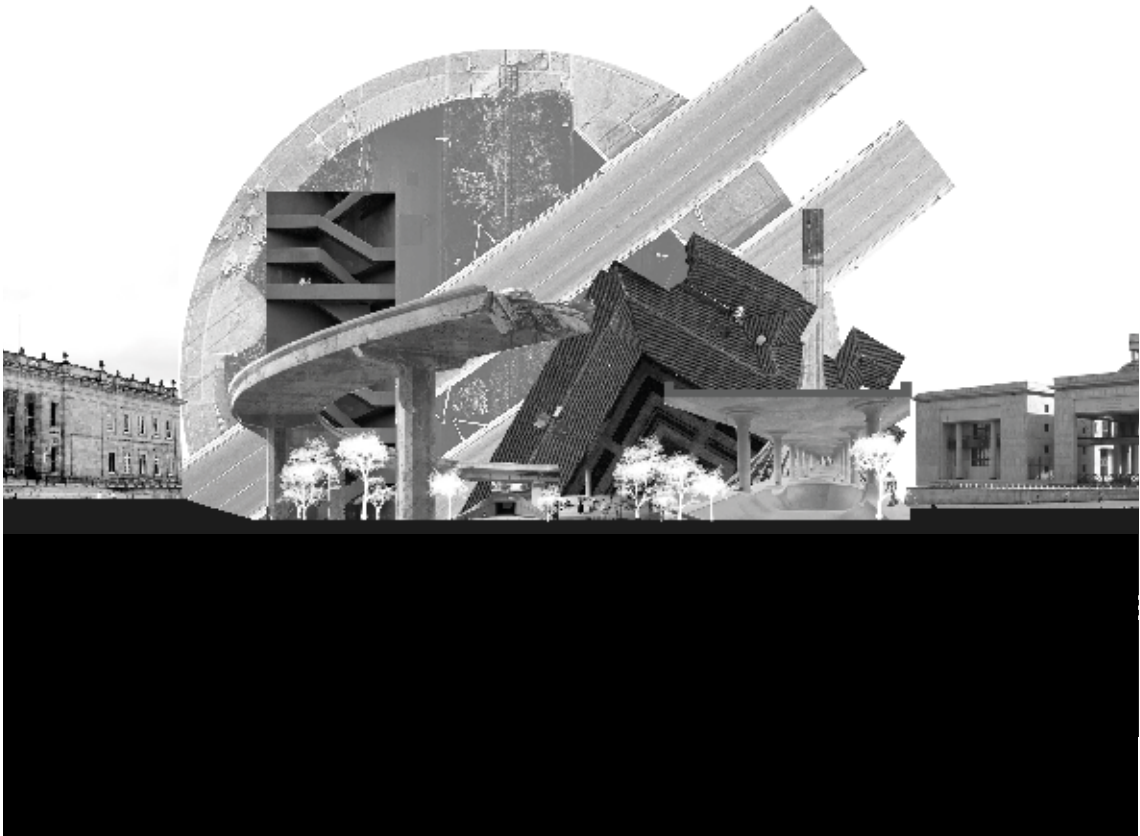

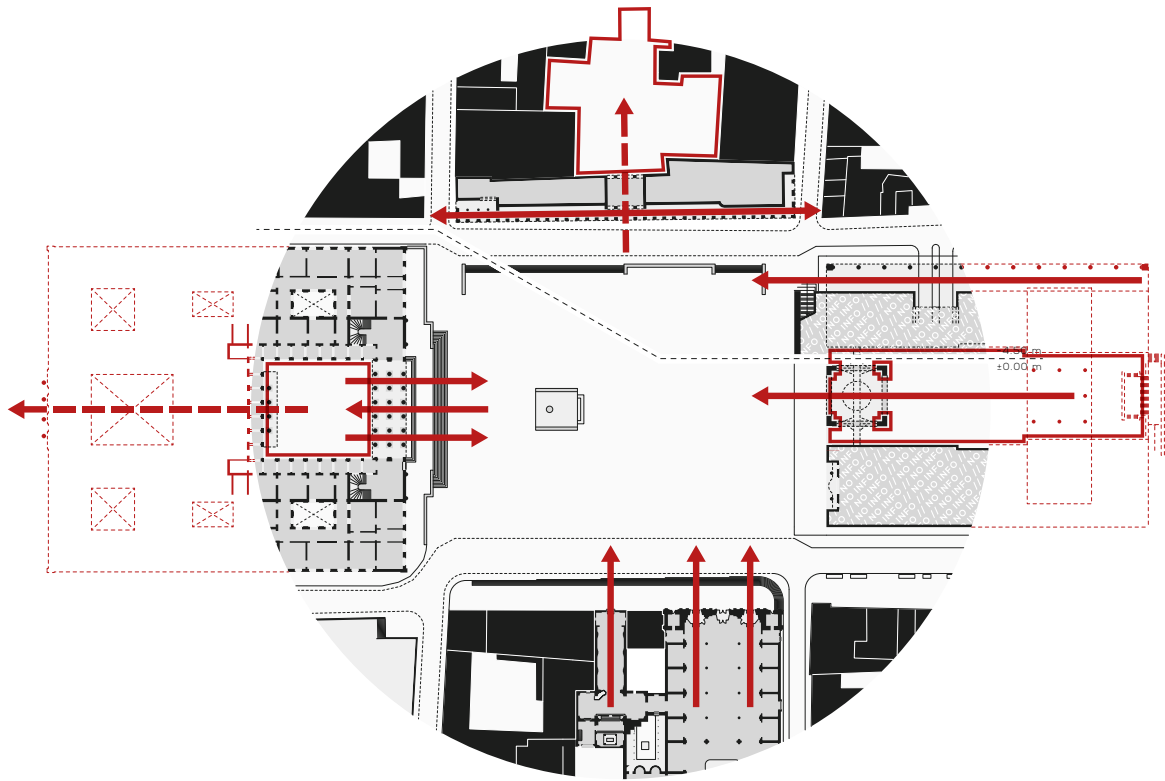

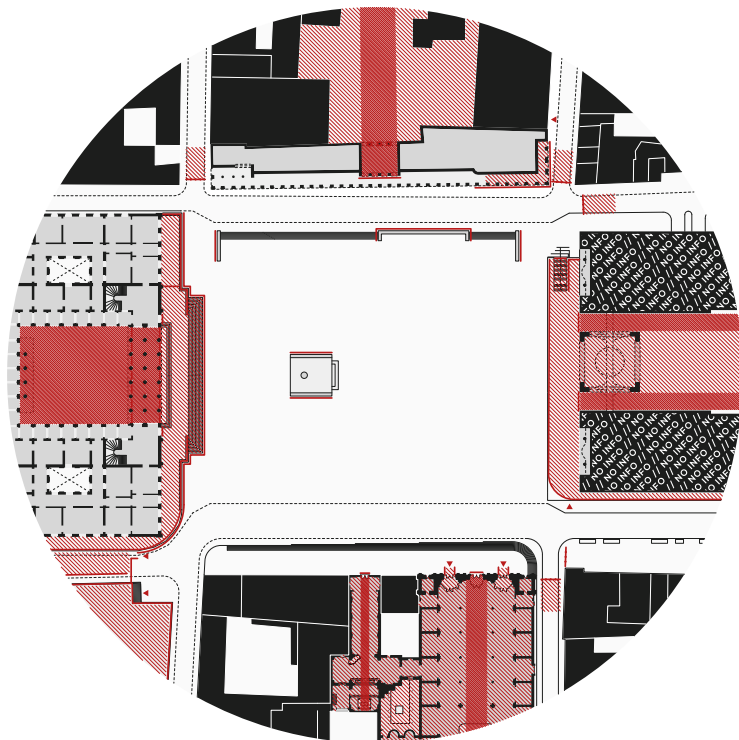
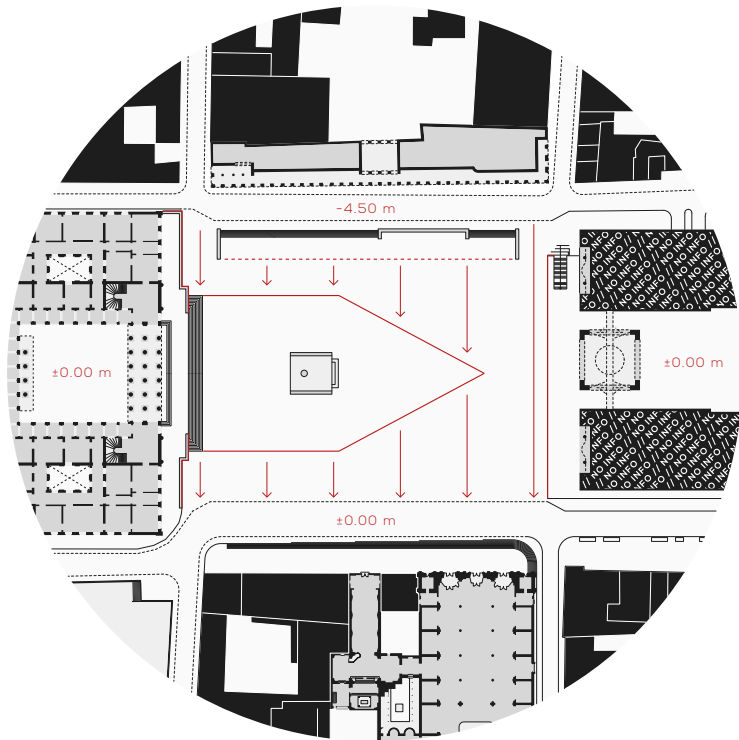

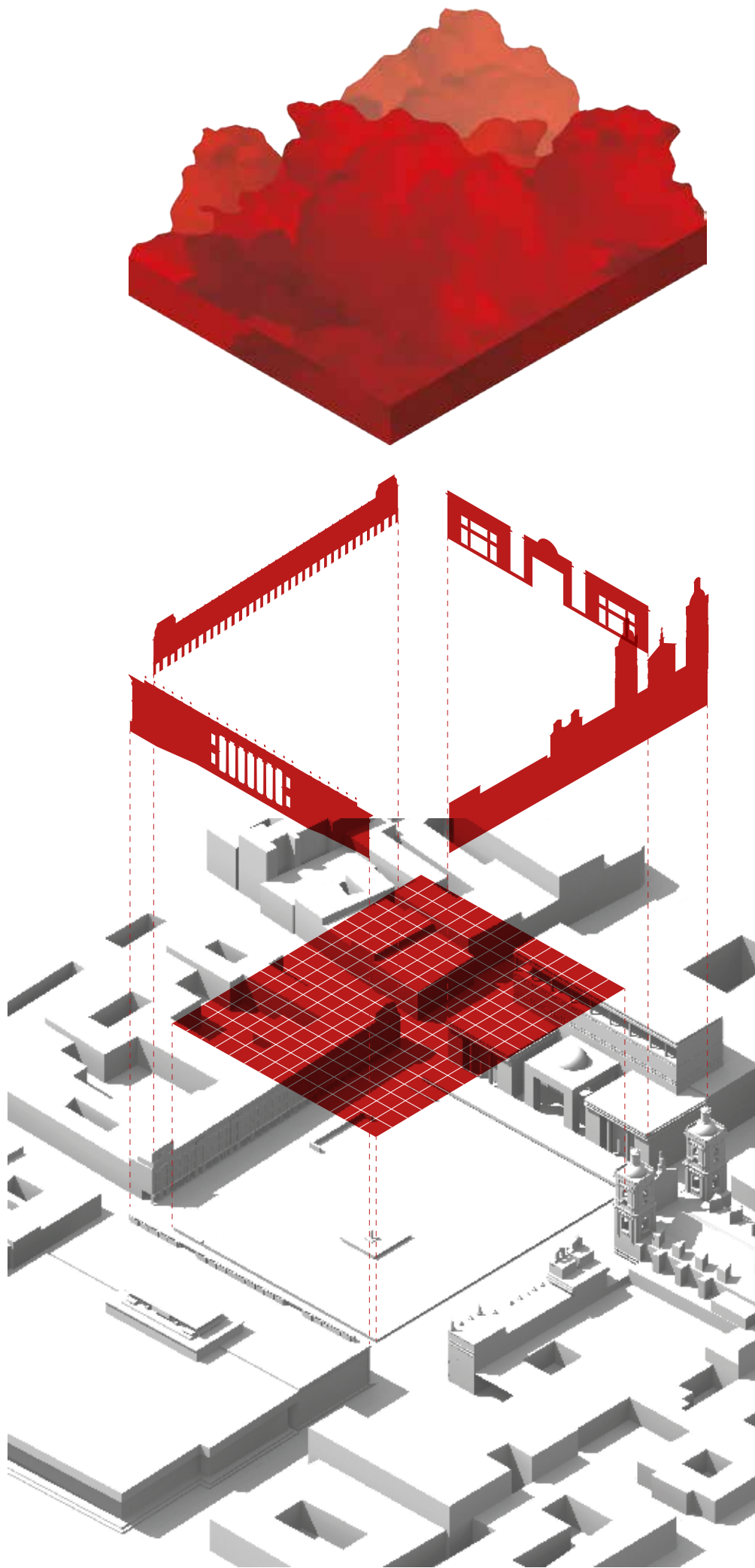

VERTICAL SURFACES

Facades of Power Holding Institutions: Palace of Justice, Primary Cathedral of Colombia, House of Congress & Lievano Palace.

Depiction of Power, Protected, Monitored, Maintained, Inaccessible, Physically exist but out of reach



HORIZONTAL SURFACE

Surface of People, Surface of Protest, The only surface accesible by the public.

Surface of the Powerless, Monitored, Cleaned, Accessible, Flexible, Physically exist & used extensively



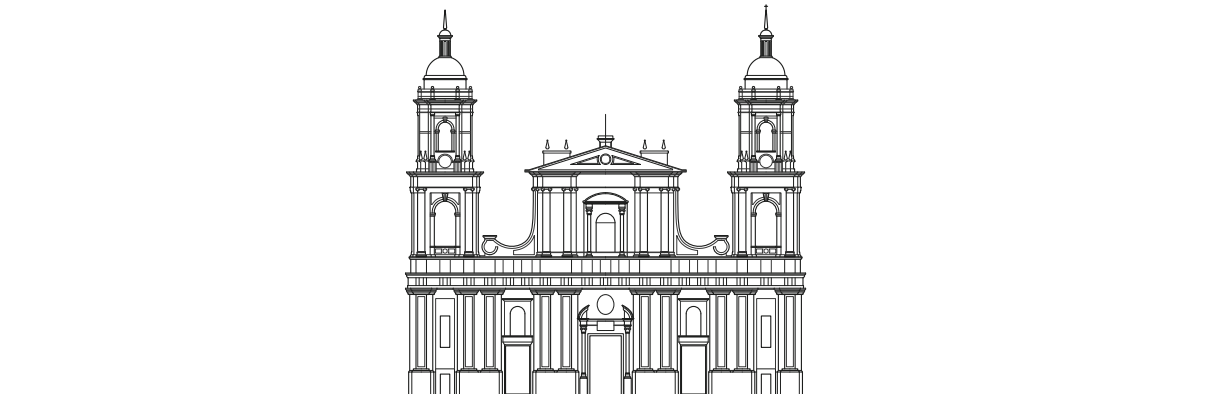
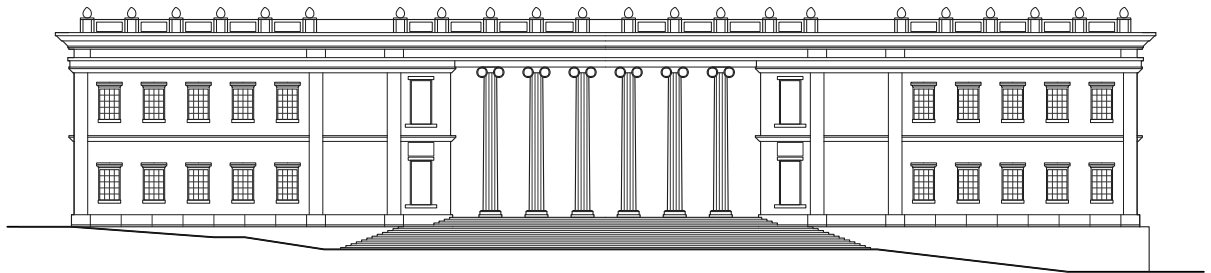
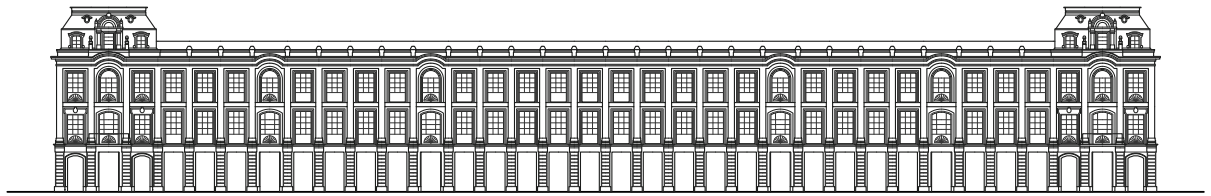
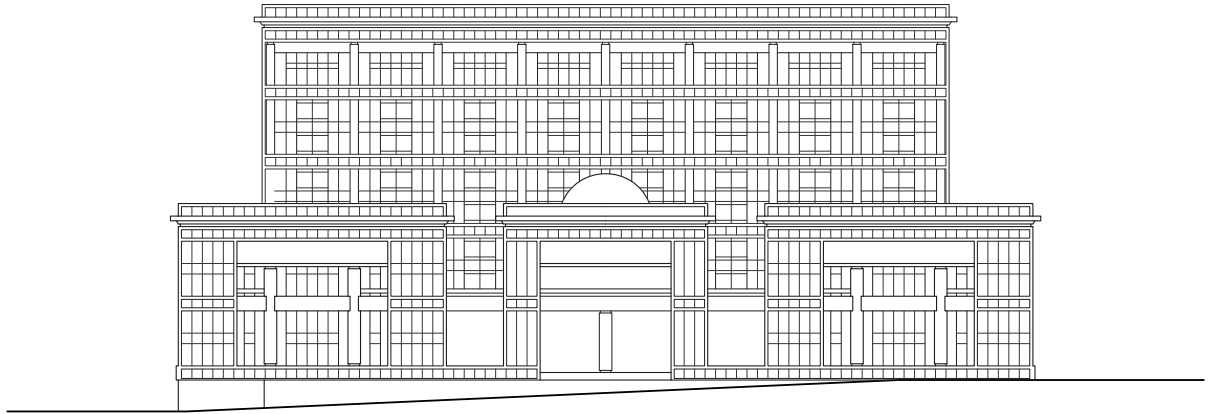



TRANSFORMATION OF FACADES



FORTIFICATION & GENTRIFICATION

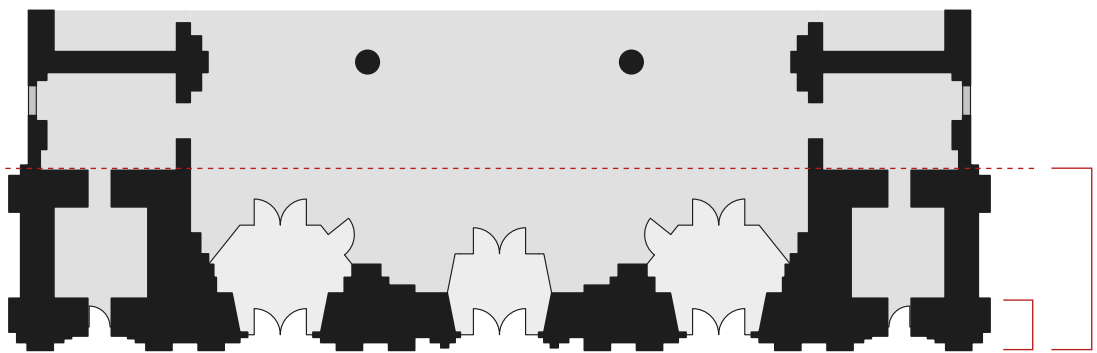

THICKNESS

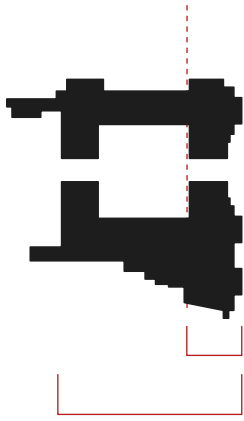
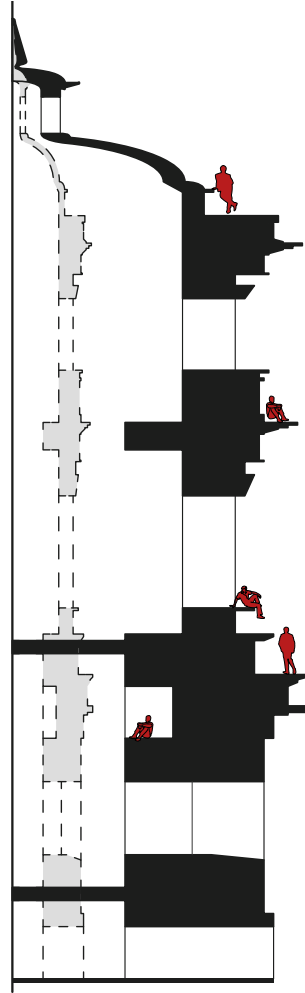
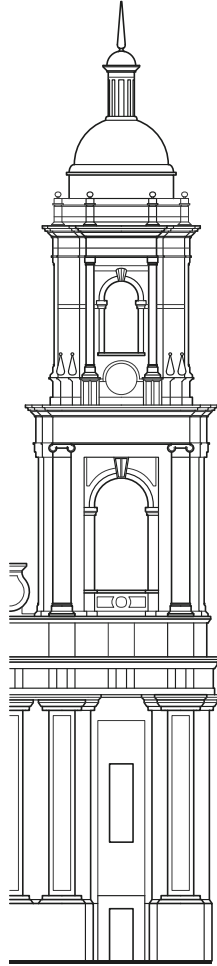
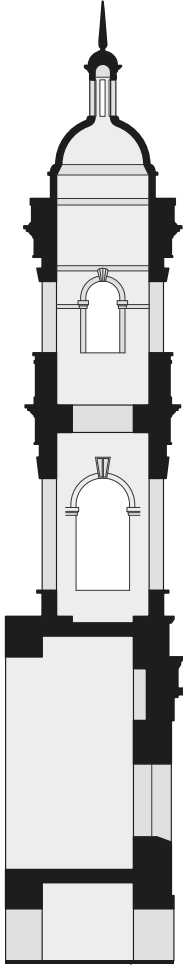

THICKNESS



EXTEND

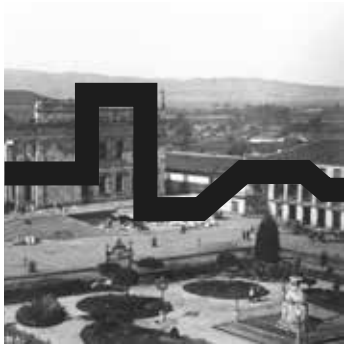

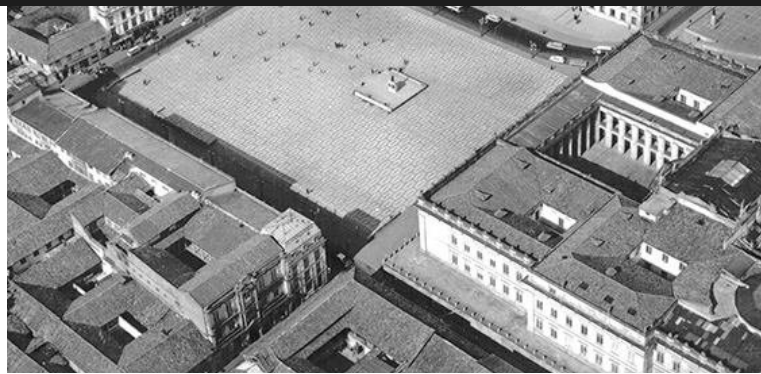

EROSION OF THE HORIZONTAL

