

Analysis of green water events on a typical FPSO design

S.R.A. van Wijnbergen



Analysis of green water events on a typical FPSO design

by

S.R.A. van Wijnbergen

to obtain the degree of Master of Science
at the Delft University of Technology,
to be defended publicly on Tuesday April 5, 2016 at 10:00 AM.

Student number:	1551698	
Project duration:	May 1, 2015 – April 5, 2016	
Supervisor:	Prof. dr. ir. R.H.M. Huijsmans,	TU Delft
Thesis committee:	Dr. ir. R. van 't Veer,	SBM Offshore
	Dr. ir. G.D. Gkikas,	SBM Offshore
	Ir. P. Naaijen,	TU Delft
	Dr. ir. S.A. Miedema,	TU Delft

An electronic version of this thesis is available at <http://repository.tudelft.nl/>.

Preface

This dissertation is original, unpublished work by the author supervised and sponsored by SBM Offshore in Schiedam. This Masters thesis contains contents of published works in Chapter 1 & 2 as part of a literature review. The proposed methodology is original. The experimental data is obtained from a SBM model test campaign at MARIN. The thesis originated from initial expectations of dr.ir. R. van 't Veer who has done significant work on the subject of green water. His initial idea and suggestions throughout the project done by dr. ir. G.D. Gkikas, prof. dr. ir. R.H.M. Huijsmans and ir. P. Naaijen contributed significantly to this research and the methodology that is used.

Syward van Wijnbergen
Schiedam, 22 April 2016

Contents

List of Figures	vii
List of Tables	xi
Abstract	xiii
Executive summary	xv
1 Introduction	1
1.1 Introduction to the green water problem	1
1.1.1 Green water hazards	1
1.1.2 Green water hazards on an FPSO.	1
1.1.3 Current and future green water hazards	2
1.2 Research history on green water	3
1.2.1 Green water flow prediction methods	3
1.2.2 Types of model tests performed	3
1.3 Problem definition and research question	4
1.4 Approach	4
1.5 Thesis outline	5
2 Physics of Green Water events	7
2.1 Freeboard exceedance	7
2.1.1 Non-linearities in the incident wave	7
2.1.2 Relative motion	9
2.2 Water flowing on deck.	13
2.2.1 Ritters Dam Break theory	13
2.2.2 Dam Break additions.	15
2.2.3 Dam Break alternatives	16
2.3 Flow pattern and impact on deck	18
2.3.1 Flow pattern on deck.	18
2.3.2 Impact on deck	18
3 Experimental set-up: Model test	19
3.1 Model and basin specifics.	19
3.2 Sensor specifics	20
3.2.1 Vessel fixed sensors	20
3.2.2 Vessel motions	22
3.2.3 Video representation.	22
3.3 Wave spectrum input parameters	22
3.4 Possible measurement flaws	23
4 Experimental set-up: Observation, wave and vessel parameters	25
4.1 Measurement input and data synchronisation	25
4.1.1 Wave input selection	25
4.1.2 Video and data synchronisation	26
4.1.3 Green water event distinction and classification	27
4.2 Wave and vessel motion parameters	27
4.2.1 Vessel motions and characteristics.	27
4.2.2 Wave characteristics	29
4.2.3 Water flow on deck.	31
4.3 Parameter and data pairing summary.	33

5	Results: Green water event quantification and comparison	35
5.1	Dam Break validation	35
5.2	Green water classifications	37
5.2.1	Dam Break	37
5.2.2	Plunging Dam Break	41
5.2.3	Hammer Fist	45
5.2.4	Discussion of classification of events.	49
5.3	Comparison of all green water events	50
5.3.1	General comparison & trend analysis	50
5.3.2	High impact event comparison	54
5.3.3	Extreme events.	56
5.3.4	Discussion of comparison of all green water events	58
5.4	Comparison to the existing theory	59
5.4.1	Classical Dam Break theory	59
5.4.2	Classification approach	60
5.4.3	Discussion of comparison to the existing theory	63
5.5	Overall discussion of results.	63
6	Conclusions and Recommendations	65
	Bibliography	69
A	Appendix A	71
B	Appendix B	75
B.1	Dam Break event	75
B.2	Plunging Dam Break event	80
B.3	Hammer Fist event	87
C	Appendix C	91
C.1	Sea state description	91
C.2	Numerical models used.	92
C.3	Model test based research.	92
C.3.1	SBM model test [2015]	92
C.3.2	Veer and Zuidscherwoude [2012]	92
C.3.3	Stansberg and Berget [2009]	93
C.3.4	Ryu et al. [2007] & Ariyaratne et al. [2009]	93
C.3.5	Ryu and Chang [2008]	94
C.3.6	Buchner [2002].	94
C.3.7	Schoenberg and Rainey [2002]	94
C.4	Distributions	95
C.4.1	Jahns and Wheeler	95
C.4.2	Prevosto Model	95
C.4.3	Kriebel and Dawson	95
C.4.4	Forristal	96

List of Figures

2	Velocity on deck flowing wave vs bulwark and freeboard exceedance	xvi
3	Freeboard exceedance vs the resulting exceedance at the bulwark, bulwark exceedance and the resulting water height on deck measured at the RWP5odeck probe 4.8m from the bow (center-line probes).	xvi
4	Freeboard exceedance vs velocity on deck.	xvii
5	Wave group leading to events.	xvii
6	Vessel motions caused by the wave group leading to green water event.	xvii
1.1	Two vessels subjected to severe sea states. The first vessel experiences a full green water wave flowing on deck; the latter shows a wave hitting the bow with related spray, but no actual green water on deck.	1
1.2	SBM Cidade de anchieta FPSO, transformed tanker with an internal turret	2
1.3	Approach of the research	5
2.1	Probability distributions of measured and calculated wave height done by Guedes Soares and Pascoal [2002]	7
2.2	Empirical crest distributions with associated Rayleigh and Forristal crest distributions (Veer and Vlasveld [2014])	8
2.3	Ursell number determination of Stokes or Airy waves theory on wave description	9
2.4	Stokes waves	9
2.5	Freeboard exceedance at the bow of a vessel (from Buchner [2002])	10
2.6	Vessel motions can be described by linear theory even if the measured waves do not follow the Rayleigh in the crest distribution (Veer and Zuidscherwoude [2012])	11
2.7	Vessel motions, wave height and relative motion measured and calculated using a Rayleigh distribution done by Guedes Soares and Pascoal [2002]	11
2.8	A wave passing through the vessel with the different wave components listed	12
2.9	Water flowing on deck (Ryu et al. [2007])	13
2.10	Water flowing on deck (Kleefsman et al. [2005])	13
2.11	Graphic representation of a dam break after some time. With h' as initial water height and y as distance on deck.	14
2.12	Traveling distance (s), from starting moment (t_k) to t with $H_e(t)$ varying over time	15
2.13	The two different types of events as described by Stansberg and Berget [2009]	16
2.14	The five different types of events as described by Greco et al. [2007]	17
2.15	Water flowing on deck (Buchner [2002])	18
3.1	Bow shape and sizing in full scale	20
3.2	Marin Offshore basin	20
3.3	Location of the sensors on the bow, photo of actual model	21
3.4	Sensor and bow specifications	21
3.5	Location of the model and sensors in the basin	22
4.1	Comparison of wave height at the bow, measured with and without model	26
4.2	Sensor names and locations	26
4.3	Set-up of measurement and observational data for classification study.	27
4.4	Six degrees of freedom vessel motions	28
4.5	Wave and crest period definition as done in Soares et al. [2004]	29
4.6	Upcrossing wave period point of measurement	30

4.7	Wave probes used to determine the steepness of the wave slope when flowing onto the deck. The distance between RWP5Adeck and RWP4BWARDK (relative wave probe and bulwark probe) is 3m, the distance between RPW4BWARDK and RWPO5Odeck (bulwark and on deck probe) is 4.8m	32
4.8	Image of a grid calculation for a moment in time and the probe locations as used in the grid as input data.	32
4.9	Frame by frame footage of a green water wave flowing on deck, with a frame-rate of 25 frames per second	33
5.1	Freeboard exceedance vs bulwark exceedance comparison with the classical Dam Break theory values	36
5.2	Velocity on deck flowing wave vs bulwark and freeboard exceedance	36
5.3	Illustration of the three different types of observed green water waves.	37
5.4	After the wave flows on deck. Dam Break event frames from basin fixed probe. The time indications are given in full scale. As the frame-rate of the video is 25/sec, the time between frames is 0.3098 seconds.	38
5.5	Wave and vessel mechanism leading to a DB event	39
5.6	Frames from model test; Dam break event flow on deck	39
5.7	Frames from grid calculations; Dam break event flow on deck. The color indicates the water height on deck, ranging from blue to red representing low to high values.	40
5.8	Time trace water flowing on deck of the center line sensors in full scale.	41
5.9	Impact of Dam Break event on vertical structure	41
5.10	Plunging Dam Break event frames from basin fixed probe.	42
5.11	Wave and vessel mechanism leading to a PDB event	43
5.12	Frames from bow fixed camera as a PDB green water event occurs	43
5.13	Visualisation of a PDB event flowing over the deck	44
5.14	Time trace water flowing on deck through the centre-line of the bow	45
5.15	Impact of Plunging Dam Break event on vertical structure	45
5.16	Hammer Fist event seen from the basin fixed probes	46
5.17	Bow motion and wave height during a Hammer Fist event	47
5.18	Frames from the bow fixed camera during a HF event	47
5.19	48
5.20	Visualisation of a HF event flowing over the deck	48
5.21	Time trace water flowing on deck through the centre-line of the bow	49
5.22	Impact of Hammer Fist event on vertical structure	49
5.23	Bow motion, relative wave exceeding the deck and resulting bulwark exceedance of all events.	50
5.24	Crest steepness vs impact on deck, crest height vs impact on deck.	51
5.25	Wave slope of the on deck flowing wave and its cause.	51
5.26	Water flowing on deck viewed from the bow.	52
5.27	Frames from model test videos during (just before flow on deck) a green water event, full view.	52
5.28	Influence of wave length and vessel mechanisms leading to different GW events. The wave length, normalised with the vessels length, during the green water event and the wave before that are shown. The events are divided by the intermittent line, representing the vessels length.	53
5.29	Freeboard exceedance vs the resulting exceedance at the bulwark, bulwark exceedance and the resulting water height on deck measured at the RWP5odeck probe 4.8m from the bow (center-line probes).	53
5.30	Influence of the amount of water on deck and the exceedance of the bulwark leading to this amount.	54
5.31	Influence of the on deck velocity on impact on deck and the bulwark exceedance on the velocity on deck.	54
5.32	Crest height and steepness and the resulting impact on deck. A high and somewhat lower impact on deck comparison.	55
5.33	Bow elevation and wave slope of the GW wave flowing on deck. Wave length of the GW wave and the wave before the event wave.	55
5.34	Bulwark exceedance and maximum water on deck during an event and the resulting impact on deck.	56

5.35 Influence of the on deck velocity on impact on deck and the bulwark exceedance on the velocity on deck.	56
5.36 Frames during impact of three extreme events.	57
5.37 Crest steepness vs impact on deck. Crest height vs impact on deck.	57
5.38 Wave length of the green water wave and wave length of mechanism instigating wave (wave before GW wave) vs impact on deck.	58
5.39 Water on deck vs velocity on deck. Freeboard exceedance vs velocity on deck with Ritter and an adjusted Ritter line.	58
5.40 Freeboard exceedance vs the resulting exceedance at the bulwark, bulwark exceedance and the resulting water height on deck measured at the RWP5odeck probe 4.8m from the bow (center-line probes).	60
5.41 Dam Break event as illustrated by Greco et al. [2007].	61
5.42 Comparison of an observed Dam Break event and the proposed Dam Break event illustrated by Greco et al. [2007]	61
5.43 Plunging Dam Break event illustration	62
5.44 Comparison of an observed Plunging Dam Break event and the proposed Plunging Dam Break event illustrated by Greco et al. [2007]	62
5.45 Hammer Fist event illustration	62
5.46 Comparison of an observed Hammer Fist event and the proposed Hammer Fist event illustrated by Greco et al. [2007]	63
A.1 Names of sensors on deck	72
A.2 Locations of sensors on deck	73
B.1 Dam Break event S1 seed 1	75
B.2 Dam Break event S1 seed 1	76
B.3 Dam Break event S2 seed 1	76
B.4 Dam Break event S2 seed 1	77
B.5 Dam Break event S2 seed 1	77
B.6 Dam Break event S3 seed 1	78
B.7 Dam Break event S3 seed 1	78
B.8 Dam Break event S3 seed 1	79
B.9 Dam Break event S3 seed 1	79
B.10 Dam Break event S3 seed 1	80
B.11 Plunging Dam Break event S1 seed 1	80
B.12 Plunging Dam Break event S1 seed 1	81
B.13 Plunging Dam Break event S1 seed 2	81
B.14 Plunging Dam Break event S1 seed 2	82
B.15 Plunging Dam Break event S1 seed 3	82
B.16 Plunging Dam Break event S1 seed 3	83
B.17 Plunging Dam Break event S1 seed 3	83
B.18 Plunging Dam Break event S2 seed 1	84
B.19 Plunging Dam Break event S2 seed 1	84
B.20 Plunging Dam Break event S3 seed 1	85
B.21 Plunging Dam Break event S3 seed 2	85
B.22 Plunging Dam Break event S4 seed 1	86
B.23 Plunging Dam Break event S4 seed 2	86
B.24 Hammer Fist event S1 seed 1	87
B.25 Hammer Fist event S1 seed 1	87
B.26 Hammer Fist event S1 seed 2	88
B.27 Hammer Fist event S2 seed 1	88
B.28 Hammer Fist event S4 seed 1	89
B.29 Hammer Fist event S4 seed 1	89
C.1 JONSWAP and Pierson-Moskowitz spectrum as defined in Journée and Massie [2001]	91
C.2 Spread moored model test with water on deck sensors (Veer and Zuidsherwoude [2012])	92
C.3 Model test with multiple relative wave height sensors done by Stansberg and Berget [2009]	93

C.4	Model tests done by Ariyaratne et al. [2009]	94
C.5	Horizontal and vertical impinging (Ryu and Chang [2008])	94
C.6	Moving shelf model test (Schoenberg and Rainey [2002])	95
C.7	Empirical crest distributions with associated Rayleigh and Forristal crest distributions (Veer and Vlasveld [2014])	96

List of Tables

1	Type of green water determining parameters	xviii
2	On deck wave parameters during the different events.	xviii
3.1	Vessel specifications in full scale	19
3.2	Key parameters of the sea state spectra targets and the calibrated values	23
3.3	Key parameters and abbreviations of sea state spectra used in this research	23
4.1	Summary of wave and on deck parameters used during the analysis	34
5.1	Incident wave parameters causing the different events.	35
5.2	Percentages of number of events per sea state	50
5.3	Sea state and highlighted event description of the highest and slightly less high event of each classification.	54
5.4	Incident wave parameters causing the different events.	64
5.5	Type of green water determining parameters. The length of the wave is normalised with the vessels length (264 meter in full scale)	64
5.6	On deck wave parameters during the different events.	64

Abstract

This study dealt with the problems caused by green water waves, waves that reach so high that significant overflow onto the deck occurs. The most important hazard caused by green water is the direct impact load on deck, threatening equipment, hull structure and personnel. The goal of current green water research is to be able to (better) predict the risks of green water occurrences and the possible damage such an event might cause. Specifically our research has focused on the adequacy of the prevailing method of predicting green water flows, a method that draws on the analogy of the water flows released after a dam breaks (the so called *Dam Break theory*). Although this model is validated and widely used, we are not able to accurately predict the amount of water on deck, given a certain exceedance of the freeboard. To be able to do predictions for engineering purposes, physical model tests are the only accurate tool to predict green water susceptibility of an FPSO, as the software is limited. Since model tests are expensive, a better understanding of the green water problem is clearly needed.

The hypothesis is that Ritter's Dam Break theory does not predict the water on deck accurately because different physical phenomena lead to different types of green water waves, not only the Dam Break type of flow.

Instead of modifying the initial Dam Break theory to get to an accurate prediction method, an alternative approach to a better description of water height on deck is chosen, in which some, but very limited research is done. The assumption is that one theory does not cover the physical characterisations of all green water events. By comparing results from earlier tests conducted by SBM in the MARIN basin, we found significant differences between the Dam Break theory predictions and the empirical test results. By comparing information extracted from video footage with sensor measurements made simultaneously, we explored various explanations for these different trends.

Executive summary

Introduction

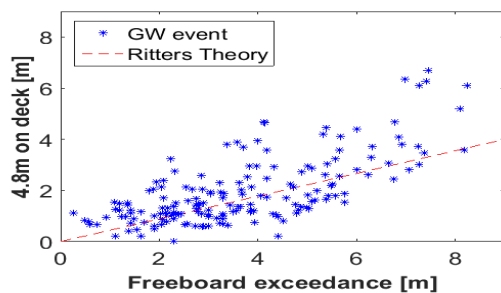
The most important hazard caused by green water is the direct impact load on deck, threatening equipment, hull structure and personnel. The goal of current green water research is to be able to (better) predict the risks of green water occurrences and the possible damage such an event might cause. Currently the flow of a green water wave onto the deck is described using a method that draws on the analogy of the water flow after a dam breaks (the so called *Dam Break theory* as described by Ritter). Although this model is validated and widely used, we are not able to accurately predict the amount of water on deck, given a certain exceedance of the freeboard. Because of this, physical model tests are the only accurate tool to predict green water susceptibility of an FPSO, as the software is limited. Since model tests are expensive, a better understanding of the green water problem is clearly needed. This leads to the following problem definition:

Ritter's Dam Break theory does not predict the water on deck accurately because different physical phenomena lead to different types of green water waves, not only the Dam Break type of flow.

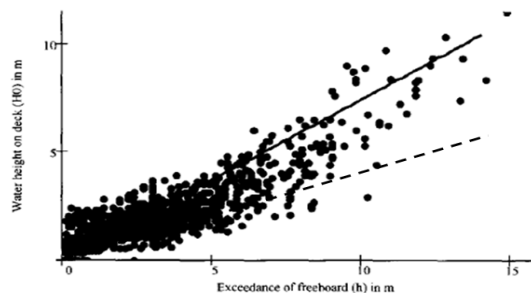
Research

The first hypothesis tested was that the unexpected measurements were misinterpreted values caused by spray or the fact that the relative wave sensor is slightly outside of the bow, instead of regular green water waves. However, by carefully pairing the (unexpected) measurements with frames from the video footage related in time with the measurements, it is concluded that in the majority of these cases, the measurements were not misinterpreted.

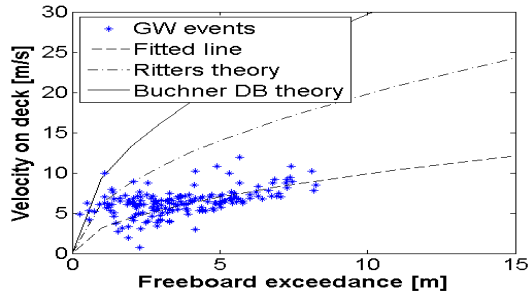
The second question was whether the Dam Break theory is an accurate way of describing the wave height and velocity on deck. We concluded, after comparing the measured data to Ritter's Dam Break model and results from earlier studies, that the Dam Break theory is not accurate when regarding a vessel with this type of bow and bulwark. The Dam Break formulas predict an initial water height on deck, based on the exceedance of the freeboard, that is significantly lower than the measured values. The velocity on deck, that is predicted and measured, deviates from the theory as well, but these values are lower than the theory predicts. In Figures 1a & 1b the water height on deck is compared. In Figures 2a & 2b the initial velocity on deck is compared to theoretical values.



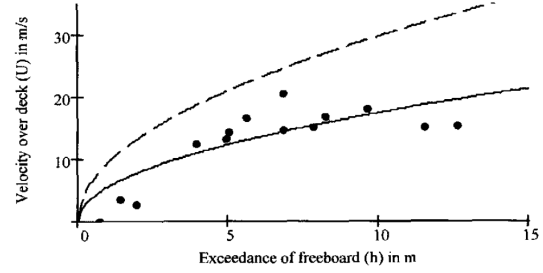
(a) Freeboard exceedance vs probe 4.8m from the bow.



(b) Comparison done by Buchner [2002], freeboard vs probe 6m from the bow



(a) Comparison data this research



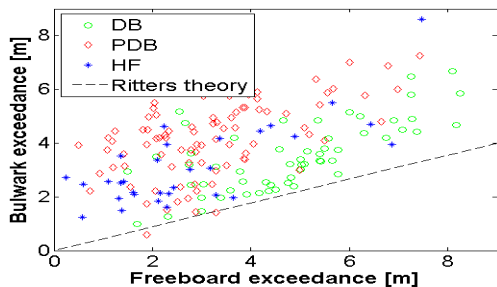
(b) Comparison done by Buchner [2002]

Figure 2: Velocity on deck flowing wave vs bulwark and freeboard exceedance

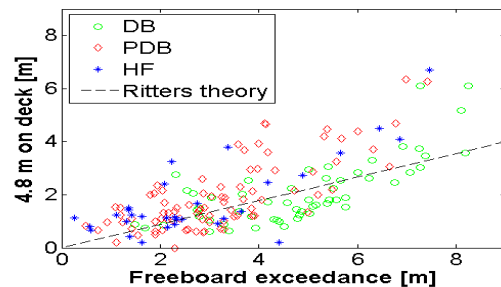
Because of the significant deviations of the measured data from the Dam Break theory, it is concluded that modifying the Dam Break model is not a promising way to gain accuracy in prediction. To get to an accurate prediction method, an alternative approach to a better description of water height on deck is chosen, in which some, but very limited research is done. The assumption is that one theory does not cover the physical characterisations of all green water events. By combining frames extracted from the video footage with the actual measurements made simultaneously, it is concluded that three different green water waves should be distinguished to adequately describe all significant green water events.

- Dam Break
- Plunging Dam Break
- Hammer Fist

In Figures 3a & 3b the initial water height on deck based on the freeboard exceedance, shows that the three events show distinctive differences. The DB has a high freeboard and lower bulwark exceedance because of swell up of the wave caused by a downward pitching motion. During the PDB the wave runs up along the bow flowing on deck with an initial upward angle. During the HF event the flow on deck is scattered as a lot of spray is measured caused by the slamming of the wave. The velocity on deck is dependent on the freeboard exceedance when considering the DB event, as can be seen in Figure 4. The HF two events do not show this correlation.



(a) Freeboard vs BWK exceedance.



(b) BWK exceedance vs water height on deck at RWP5Odeck

Figure 3: Freeboard exceedance vs the resulting exceedance at the bulwark, bulwark exceedance and the resulting water height on deck measured at the RWP5odeck probe 4.8m from the bow (center-line probes).

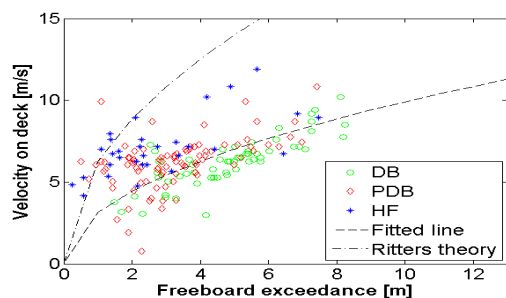
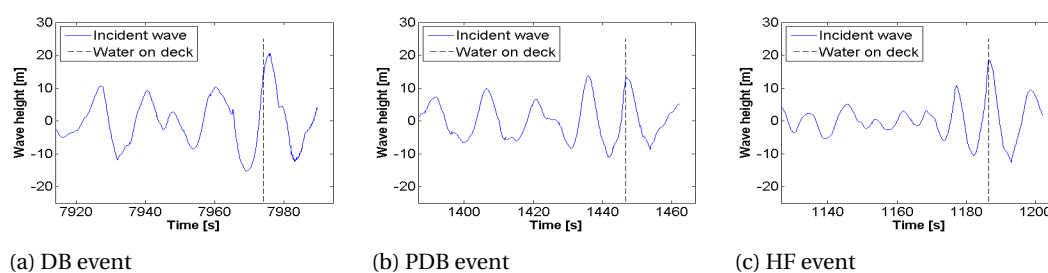


Figure 4: Freeboard exceedance vs velocity on deck.

The DB and PDB events are dependent on the vessels motions and the phase angle with the incoming wave group (as can be seen in Figures 5a, 5b, 6a & 6b). During the DB event the vessel dives into the wave causing high freeboard exceedances and a significant amount of water on deck, instigated by a group of waves longer than the vessel. The PDB event is caused by a group of waves similar to the DB event cause, but the phase of the vessels motions and the waves is different during the PDB event. Somewhat less vessel motions are observed than during the DB event, although again most of the mechanism is determined by phase. The HF events are not dependent on the vessel motions as these are caused by a single, steep, high crested wave which is relatively short, slamming against the vessel (see Figure 5c & 6c).

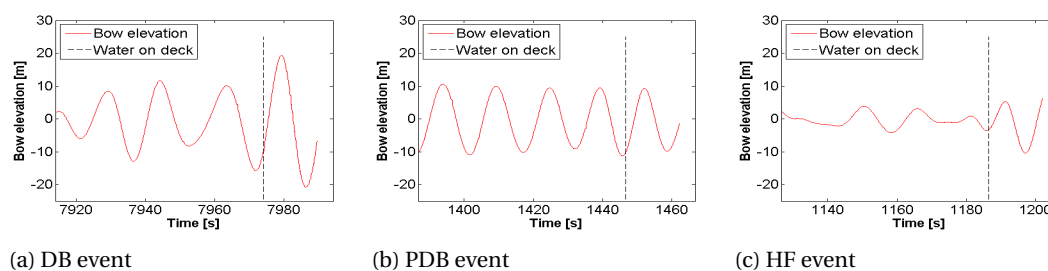


(a) DB event

(b) PDB event

(c) HF event

Figure 5: Wave group leading to events.



(a) DB event

(b) PDB event

(c) HF event

Figure 6: Vessel motions caused by the wave group leading to green water event.

As mentioned, the assumptions on which the Dam Break model is based can explain the deviations of the data measured from the theory. Different types of waves are distinguished that can not be described with the physical description which these Dam Break assumptions dictate. The Dam Break assumptions determining the initial water height and velocity are listed below:

- a **The water behind a dam is calm, a solid mass of water.** Both the PDB and HF events are waves that are highly aerated because of run-up and breaking effects, and therefore do not resemble still water behind a dam. During the DB event the vessel dives into the wave causing high freeboard exceedance without run-up. The wave exceeding the freeboard during this event is therefore comparable to water behind a dam.

- b **The wave following from a breaking dam has zero initial momentum.** Due to the velocity of the wave and the motion of the vessel, the wave will always have momentum when it flows on deck. The DB event shows the least initial momentum as the wave is scooped up by a pitching motion of the vessel. Especially the HF event has significant momentum when flowing on deck.
- c **The direction of the initial velocity of a dam breaking is down-wards (towards the bow).** This assumption is true when considering the DB events, the freeboard exceedance is significantly higher than the water height on deck. The PDB and HF events, however, have an initial upward direction when flowing on deck.

As the observed green water events are mostly phase dependent, the wave groups causing the vessel and wave mechanism are analysed. A couple of determining wave and vessel parameters are distinguished, as shown in Table 1 below. The DB event is caused by a wave group containing long waves, causing high vessel motions. The PDB event is similar, but the phase is different and the vessels motions are less severe. The HF event is not caused by a group of wave, but by a single high crest. Because of the length of the waves, the steepness of the crests during DB and PDB events is less than during a HF event.

	Wave length [-]	Crest height [m]	Crest steepness [-]	Bow motion [m]
DB	>1	-	0.05-0.35	-16 >z >-5
PDB	>= 1	-	0.2-0.45	-10 >z >3.5
HF	1<	-	0.3-0.6	-3 >z >5

Table 1: Type of green water determining parameters

The impact on deck resulting from the different events and the frequency of occurrence (as observed in all wave seeds combined) is shown in Table 2 below. The impact during the DB event is most dependent on the amount of water that flows on deck, while the HF event is dependent on the velocity of the wave on deck. The PDB event is the least severe but most frequent event, because this event is less dependent on the phase with the incoming waves. The HF event is the least frequent event, but a high average impact and two extreme impact events were observed.

	Mean impact [kN]	Max impact [kN]	Water on deck [m^3]	Velocity on deck [m/s]	Frequency of occurrence [%]
DB	91.27	600.83	398.97	6.25	30.63
PDB	66.62	555.65	303.61	6.18	51.60
HF	150.43	1094.0	301.25	7.06	16.90

Table 2: On deck wave parameters during the different events.

Conclusion & Recommendation

Our analysis shows that the Dam Break theory is not an accurate way to describe the flow on deck for all green water events measured during the model tests performed with this type of vessel. The reason is that the assumptions on which this theory are based do not represent the way all green water waves flow on deck. Different types of green water waves are observed (PDB and HF), which need a different prediction model than a model based on a breaking dam. The events classified as DB events do follow the Dam Break theory because the assumptions show a correspondence to these types of events (but not completely accurate). The DB events do show deviation from the Dam Break theory, possibly caused by the presence of the bulwark and partly inaccurate assumptions. Different wave mechanisms were observed to cause the different events, leading to a different type of flow, amount and velocity on deck during a green water event. As the phase of the waves and the vessels motion have determine in a large way the type and severity of the green water event, a correlation between the sea state characteristics and the type of events that will occur is yet to be found. The initial research done by [Greco et al. \[2007\]](#), who first described different types of green water events, shows some comparison to the events as described in this research. Because those observations were done based on a fixed and non ship shaped model, the physics described are significantly different, caused mainly by vessel motions.

The HF events occur least often but exert most impact on deck. It should be investigated if this is a trend or caused by the model test set-up (different wave parameters). To be able to apply the different wave types when designing an FPSO for a specific region (with a specific sea state) the frequency and severity the possible

green water waves on deck based on a certain sea state should be clear, so further research into this relation should be done.

Introduction

1.1. Introduction to the green water problem

1.1.1. Green water hazards

When a vessel finds itself in heavy weather conditions, waves can reach such heights that the deck height is exceeded (freeboard exceedance). When this happens a wave can flow onto the deck from the bow, side or stern, this is called a 'green water wave'. This water overtopping is called green water to make a distinction between breaking waves spraying the deck (see Figure 1.1b) and solid waves flowing over the deck (see Figure 1.1a). Also, seawater is observed to be green in stead of blue when flowing over the deck.



(a) Wave on deck causing green water

(b) Spray on deck

Figure 1.1: Two vessels subjected to severe sea states. The first vessel experiences a full green water wave flowing on deck; the latter shows a wave hitting the bow with related spray, but no actual green water on deck.

The green water problem was first experienced with vessels that were sailing in heavy weather. Fishing vessels, container vessels and high speed vessels have been subject of research in this field as there have been reports of serious hazardous situations in which high waves over-top on deck. An extreme example of green water impact loads is the sinking of the M.V Derbyshire (investigated in [Heffernan and Tawn \[2003\]](#)). In this case the amount of water on deck, caused by the impact force of the waves on the bow and the over-topping 'green water' waves, caused the ship to sink. These kind of accidents don't occur on regular basis but the green water problems can cause serious hazards and inconveniences in less severe ways.

1.1.2. Green water hazards on an FPSO

When extracting, and subsequently processing, hydrocarbons from a remote deep water field, a structure founded on the seabed is often not possible (max. 500 meters depth). Different floating structures are possible, but most an FPSO is used, as they can process (due to a large deck-space) and store the hydrocarbons. These platforms are often built by transforming a used oil-tanker to a floating platform by adding gas and/or oil processing equipment and a way to anchor the vessel to the seabed. Anchoring the FPSO to the seabed is

done in three main ways: spread moored, moored with an internal turret and moored with an external turret. An example of an FPSO with an internal turret can be found in Figure 1.2. Green water on an FPSO type offshore platform differs from green water waves on i.e. fishing vessels as an FPSO lies still in the water (when operative), disregarding current. Also, an FPSO stays in one place, so when waves are high, the vessel does not simply sail away (except in extreme situations).



Figure 1.2: SBM Cidade de Anchieta FPSO, transformed tanker with an internal turret

Because of the weather-vaning (heading in the direction of the current) of the mentioned FPSO's, most of the waves will be hitting (and overtopping) the bow of the vessel. Therefore this area will be the part of the vessel where the main focus will lie. When such a green water wave over-tops, it does not necessarily impact the vessel's stability, but due to the velocity and height on deck of the water flow, damage can be caused to on-deck equipment (like the fluid swivel, piping, turret structure and chemical stores) and lead to hazardous situations for personnel. Because of this risk of loss or damaging equipment or accommodations can create a dangerous environment and may limit the workability and productivity of the vessel ([Forristall, 2000]). Besides the high impact waves slamming on deck causing damage to the ship, the lower impact higher frequency waves overtopping the deck can be very damaging in terms of fatigue. Also the vessel motions are influenced by the force of the water as they act on the bow, far away from the center of gravity of the vessel.

1.1.3. Current and future green water hazards

Green water has been troublesome for a long time, but in the search of oil and gas deeper and more remote areas are targeted, increasing the potential severity of green water incidents. A large part of these areas are (more) cyclone prone than the current working areas of the FPSO's. Also the metocean conditions in the new locations are more severe than the current fleet of FPSO's is designed for. As described in [Morris and Buchner 2000], where 17 green water incidents (i.e. minor damage to equipment) were reported between 1995 and 2000. In a research on Norwegian and UK North sea floating production vessels it was seen that green water incidents occurred even in sea states that were significantly lower than the design conditions ([Ersdal and Kvitrud 2000] & [Morris and Buchner 2000]). This indicates the complexity and inability to predict the green water events in frequency and severity. Precautions have been taken in the design of an FPSO. Vessels have been fitted with a bulwark (extra elevation of the bow), an inclined forecastle deck and structures to protect equipment by breaking green water waves. In [Buchner et al. 1995] it is stated that in FPSO design, the accommodation location is chosen in front of the turret, thus making green water protection even more important. To sum it up: The most important hazard caused by green water is the direct impact load on deck, threatening equipment, the hull structure and personnel. The goal of current green water research is to be

able to (better) predict the risks of green water occurring and the possible damage and amount of water on deck for certain conditions and type of green water wave. The aim of this project is to make a contribution to this goal.

1.2. Research history on green water

From the first real investigation into green water in 1959 by [Newton \[1960\]](#), the green water problem has been studied extensively throughout the history. A brief summary of literature dedicated to green water and relevant to this research is given below.

1.2.1. Green water flow prediction methods

In [Buchner \[2002\]](#) the flow of a green water wave onto the deck is described using Ritters Dam Break theory. Using this theory a green water wave is modelled as a wave flow directly after a dam breaks. The green water wave flow is seen as a shallow water wave, which means that the velocity at one point is constant, distributed over the height of the wave. In research done by [Stansberg and Berget \[2009\]](#) adjustments to the Dam Break theory are made by taking into account initial velocity and non-infinite amount of water from the wave. Other promising results are shown in [Hu et al. \[2015\]](#), where an adjusted Dam Break theory is compared to numeric values and model test results. In [Zhou et al. \[1999\]](#) the dynamic effect of the vessel on the green water flow is investigated by numerically modelling a 3D shallow water flow and validating these values with Dam Break theory and experimental data. Another approach towards a better description of the water flow on deck is to distinguish different types of waves, instead of solely the Dam Break theory. [Greco et al. \[2007\]](#) classified five different types of events as will be described in Section 2.2.3. [Stansberg and Berget \[2009\]](#), on the other hand, classified two different types of events, one with a high wave and small negative pitch, which is shipped on to deck and one with a steeper crest with a higher orbital velocity.

1.2.2. Types of model tests performed

In [Buchner \[2002\]](#), [Veer and Zuidschewoude \[2012\]](#), [Fonseca and Soares \[2005\]](#) and [Stansberg and Berget \[2009\]](#) floating vessel shaped models are used to investigate green water waves. In these model tests the vessels motions, relative wave heights and resulting green water are examined. In an effort to determine different classifications of green water waves [Stansberg and Berget \[2009\]](#) based his findings on model tests with a ship shaped-model whilst [Greco et al. \[2007\]](#) based the classifications on a non ship-shaped model. Using a non-ship shaped "vessel" has a significant effect on how waves over top onto the deck because of dynamic and shape effects. [Schoenberg and Rainey \[2002\]](#) tried to eliminate inaccuracy in the Dam Break theory by using a moving shelf, as this ensures a limited amount of water modeled for a wave (thus modeling vessel motions), but, again, the hull shape impacts the use of these results. Also, the limited amount of water is not the only assumption that causes the inaccuracies of the Dam Break theory. In model tests done by [Buchner \[1998a\]](#) it is found that the pitch motions of the ship are influenced by the wave length and a wave period close to the vessels forcing period, although the motions are reduced by added damping and mass. Whether the vessel is fixed or floating thus has a significant effect on the way a wave flows on deck and frequency of green water occurrences. Besides the fact whether a model is fixed or floating, the above-water hull shape influences the way waves run-up along the hull as well. In early research done by [Lloyd \[1984\]](#), the effect of a moderate flare angle was negligible, while in [Watanabe et al. \[1989\]](#), the deck wetness, relative motion and impact pressure are decreased with increasing flare. In research done by [Buchner \[2002\]](#), several bow flare angles are investigated using a scale sized model in a basin. He concludes that the bow flare angle has a significant decreasing influence on water flow and subsequent impact loads on deck. Before one can use the findings of these model tests described, the limitations have to be carefully examined. A more detailed description of the different performed model tests is given in Appendix C, in Section C.3.

1.3. Problem definition and research question

As described in 1.1.3 & 1.2, the existing knowledge about the frequency and severity of green water waves is insufficient, although the consequences from an over-topping wave can be severe. From the literature research it is clear that several attempts have been done on modifying the Dam Break theory and its ability to describe the height and velocity of a wave on deck. Because of unexpected values resulting from measurements done during model tests done at Marin by SBM offshore, the hypothesis is stated that the Dam Break theory is not an accurate way to describe green water waves. Some unexpected values can be explained by spray hitting the sensors higher than the actual wave causing the sensors to output misleading data. A significant deviation from past research is the bulwark in the model tests. Because the Dam Break is based on a vessel without bulwark, this will require a modification as the water falls down in stead of flowing on deck. Currently only model tests are accurate as a tool to predict green water susceptibility of an FPSO as the software is limited, this is unsatisfactory for SBM as model testing is expensive, so a better understanding of the building blocks of green water is needed. The main problem on which this research is based is listed below. To be able to contribute to this problem, it is divided in three sub-questions, as listed below:

- **We are not able to accurately predict the amount of water on deck, given a certain exceedance of the freeboard, caused by green water waves.**
 - **Is the mismatch between measurement data and theory due to misinterpretation instead of actual measurements?**
 - **Does the Dam Break theory describe the height and velocity of a flow of water on deck accurately?**
 - **Are there different physical phenomena amounting to different types of green water waves?**

The main focus in this research will be the way water flows on deck based on a given freeboard exceedance. As described the green water problem is very relevant because of predictability issues and huge possible impact loads and operational hazards.

1.4. Approach

To be able to validate the Dam Break theory using the model test data, the measurements are validated. To be able to explain certain outliers from the model tests the video footage is used. As a limited amount of probes is placed, some values can be misleading as, for instance, spray is measured as a wave. To better understand these outliers with respect to the Dam Break, the sensor measurements are matched with the corresponding frames of the events.

The initial hypothesis is that Ritters Dam Break theory does not predict the water on deck accurately. Therefore the video footage is used to distinguish different types of green water waves as the assumption is that different types of observed waves are caused by different physical characteristics. The model test is observed with a complete view from a distance and from a deck view point made by a vessel fixed camera.

Making use of the different wave probes, the wave flow on deck and in the basin is measured. Using this data the different wave and on deck characteristics can be determined. Together with the frames from the model test videos this will lead to a better insight into how the green water events occur.

To highlight the necessity of dividing the green water events in different classifications, it has to be shown that the classical Dam Break theory and all related modifications do not accurately predict all green water characteristics on an FPSO with a bow flare and bulwark.

The focus will be on the high impact events, as these are the most important. The approach of the research is illustrated in Figure 1.3.

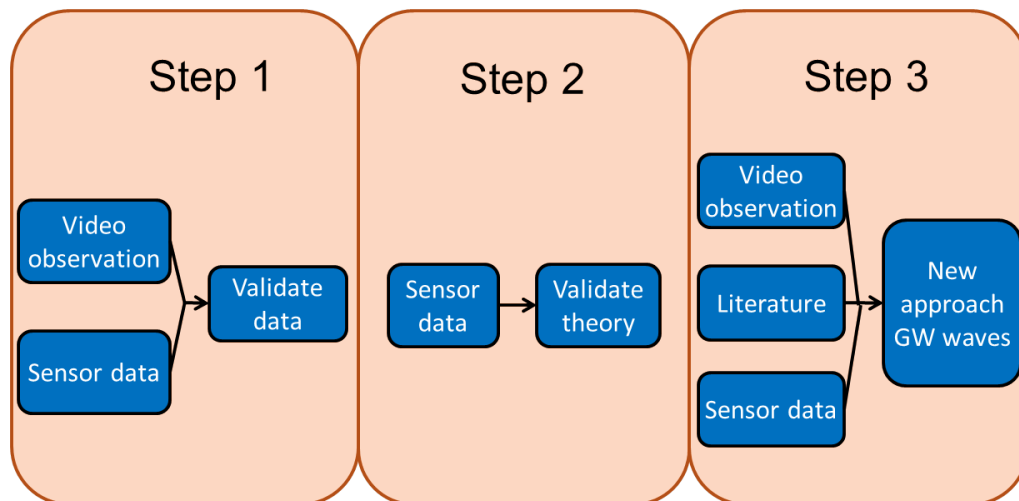


Figure 1.3: Approach of the research

1.5. Thesis outline

The physical phenomena leading to green water events are described in Chapter 2. In Chapter 3, the model test done by SBM in the Marin basin is discussed, which include vessel specifics, sea state spectra used during the tests and in what way and which values were measured. The values from this model test are used for calculations, which are described in Chapter 4 and analyzed in Chapter 5. Finally, the conclusions and recommendations drawn from the research done are discussed in Chapter 6.

2

Physics of Green Water events

To be able to describe the physics of a green water event, the green water phenomenon is broken down into two components; the exceedance of freeboard and the resulting flow of water on deck.

2.1. Freeboard exceedance

The exceedance of freeboard (as illustrated in Figure 2.5) is defined as the water that rises above the bow. This exceedance is determined both by the vessels motions and by the wave height. We are able to predict the height of the wave above the bow reasonably well, but the accuracy reduces in severe sea states. This is due to non-linearities in the components causing the exceedance. The main causes of these non-linearities, as described by Buchner [1998a], are the non-linear aspects in the ocean waves, the influence of the above water hull shape (bow flare) and the effect of water that is already on deck that influences the ships motions. These aspects are discussed in the following sections.

2.1.1. Non-linearities in the incident wave

Wave height in severe sea states

When predicting water on deck, the input is the amount of water that exceeds the freeboard. This freeboard exceedance is predicted using the probability distributions of the significant wave height (based on the sea state) in which the vessel finds itself. The severe sea states are mainly used as these are most important and most complex to predict.

As can be seen in Figure 2.1, in research done by Guedes Soares and Pascoal [2002], the Rayleigh distribution can accurately predict the exceedance of a certain wave height, except for low probability high waves.

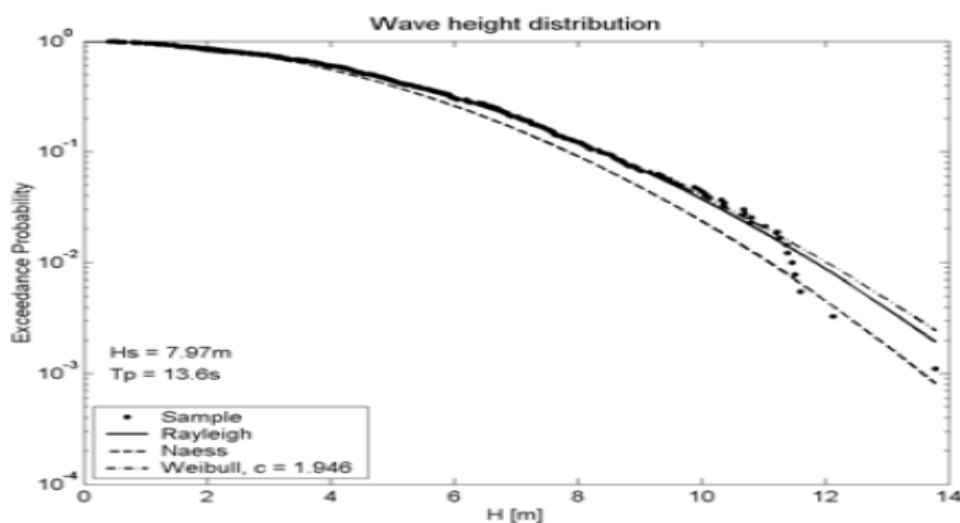


Figure 2.1: Probability distributions of measured and calculated wave height done by Guedes Soares and Pascoal [2002]

Unfortunately, these hard to predict high waves are a very important part of the green water problem as these could cause the most damage. Instead of the distributions proposed above, an adjusted distribution is adopted for the higher sea states by most. Forristall [1978] proposes a distribution based on the two parameter Weibul distribution (distributions discussed in Appendix C.4). This way the non-linearity of the crests and troughs, are predicted better, which are higher and sharper and the troughs are shallower and flatter than linear models predict. In Veer and Vlasveld [2014] a model test is described where this distribution is investigated. It is found that the crests are about 1,5 – 3m higher than linear prediction and the proposed Forristall [1978] distribution holds, until the the 10 percent probability waves (regarding the 100 and 10.000 years sea states), lower probability waves are under-predicted significantly (see fig. 2.2).

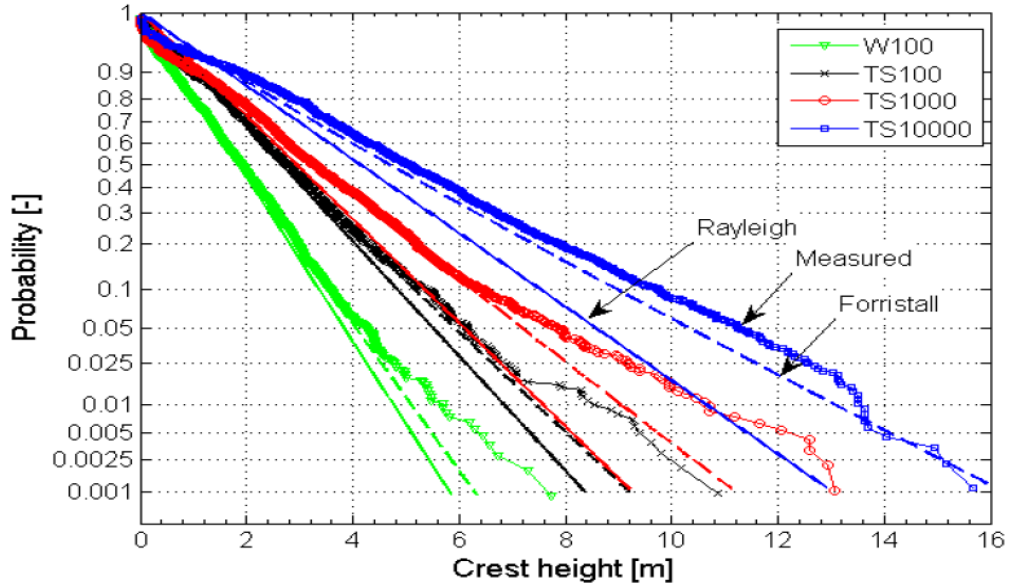


Figure 2.2: Empirical crest distributions with associated Rayleigh and Forristal crest distributions (Veer and Vlasveld [2014])

As mentioned above, accurately predicting waves in severe sea states remains a difficult task. A part of the unexpected green water phenomena could very well originate from this.

Second order wave theory

Another possible cause of non-linearities within the green water problem lies in the definition of the waves form and height. In linear wave theory (Airy) of surface gravity waves, the elevation of the surface of the sea is modelled as a group of harmonic and independent components, and can therefore be seen as linear harmonic waves. This theory holds, until the waves in a sea state become too steep. Dependent on the Ursell number, as can be seen in equation 2.1, it is determined whether the linear wave theory is applicable.

$$N_{Ursell} = \frac{gHT^2}{d^2} \quad (2.1)$$

When the Ursell number is lower than 10, Stokes waves are applied when describing the crest and trough amplitudes Holthuijsen [2008], see Figure 2.3. With a maximum basin depth of 600 meters (full scale), significant wave periods between 13.56-15.65 seconds and significant wave heights between 12.12-15.12, the Ursell number of the wave seeds used is in the region as indicated by the red intermittent line in the figure.

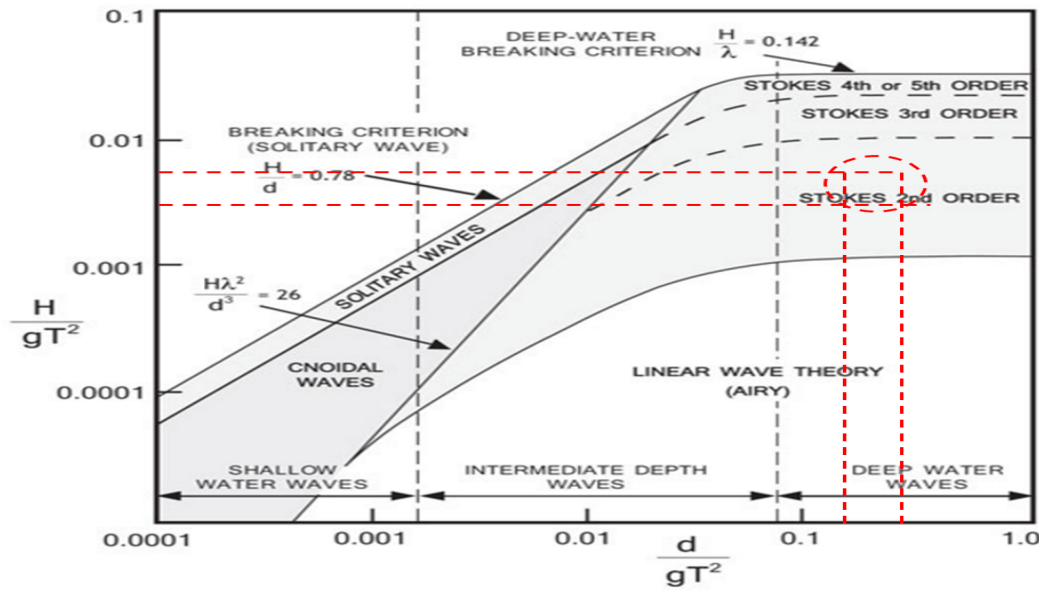


Figure 2.3: Ursell number determination of Stokes or Airy waves theory on wave description

In Stokes theory an addition is made to the harmonic wave components. The correction Stokes proposes is an extra harmonic wave, with the wave steepness raised to the second power, which results in a second-order stokes wave.

$$\eta(x, t) = \epsilon\eta_1(x, t) + \epsilon^2\eta_2(x, t) \tag{2.2}$$

where $\epsilon^2\eta_2(x, t)$ represents the mentioned extra harmonic wave component. Extra Stokes correction can be added as well, by raising this component to a higher value than the preceding component. These components ensure a steeper and slightly higher wave crests and shallower wave troughs, as can be seen in Figure 2.4. Stokes' wave theory is of direct practical use for waves on intermediate and deep water (Holthuijsen [2008]).

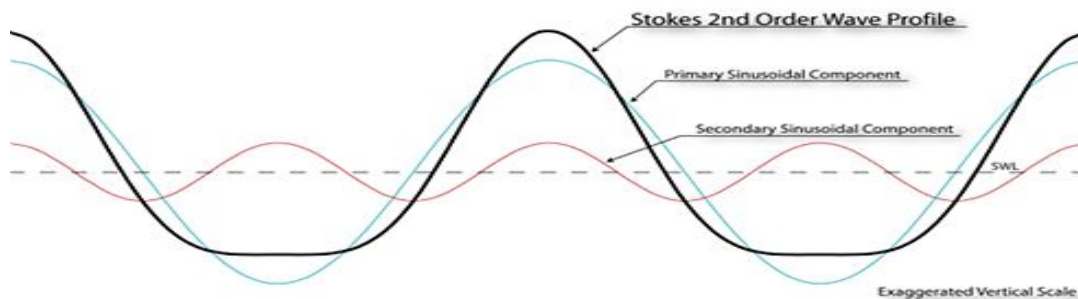


Figure 2.4: Stokes waves

As can be seen in Figure 2.4 and equation 2.2, the waves that propagate towards the vessel are non-linear, which cause higher and steeper crests than would be expected in linear theory. The observation of shorter waves being more problematic and non-linear was also done by Stansberg and Berget [2009], where wave generation was done with 2nd order wave theory. Waves over topping the deck occurred more often than predicted by the Rayleigh distribution, as can be seen in work done by Buchner [2002]), caused by the non-linearity of the waves, not of the ship motions.

2.1.2. Relative motion

When researching water on deck, wave height itself is not the most defining element. The relative motion between the vessel and the incoming waves, as defined by Buchner [2002], takes into account the difference between vessel motions (z_{deck}) and the water level relative to the mean. As can be seen in Buchner [2002] the pitch motion of the vessel has a significant influence on the relative wave height, so when the wave height is the only variable studied, misleading results will follow. To determine the relative motion of the waves and

vessel, this relative motion is divided in two components; vessel motions and the incident wave (Journée and Massie [2001]). The non-linear effects of waves are of minor importance on the ship motions. They do cause higher wave heights than expected using linear wave theory as described above (Guedes Soares and Pascoal [2002]). Because of the non-linearity in these components, it will come as no surprise that the relative motions are highly non-linear as well. According to Buchner and Garcia L-C [2003] the largest relative motions occur when the wavelength is equal to the vessel. This relative motion is also largely influenced by the bow shape.

Vessel motions

The vertical motion of the vessel is determined by the three degrees of freedom that cause vertical displacement; heave (z_h), pitch ($x_b\theta$) and roll ($y_b\phi$) motions Journée and Massie [2001]. This relative motion is of importance for shipping water on deck and slamming of the vessel. The vertical relative motion z_{rel} at $P(x_b; y_b)$ is defined by:

$$z_{rel} = \zeta_p - h = \zeta_p - z + x_b\theta - y_b\phi \quad (2.3)$$

with ζ_p as the local wave elevation:

$$\zeta_p = \zeta_a \cos(\omega_e t) - kx_b \cos(\mu) - ky_b \sin(\mu) \quad (2.4)$$

where $-kx_b \cos(\mu) - ky_b \sin(\mu)$ is the phase shift of the local wave elevation relative to the wave elevation in the center of gravity.

The third relative wave component is the wave diffraction and radiation effect of the vessel. These components are determined by linear diffraction analysis. The amount of water exceeding the freeboard (see Figure 2.5) is one of the key parameters that can be measured from these relative motion descriptions, which is determined by subtracting the height of the wave elevation from still water level (r) from the distance of the top of the bow to the still water level (fb):

$$h = r - fb \quad (2.5)$$

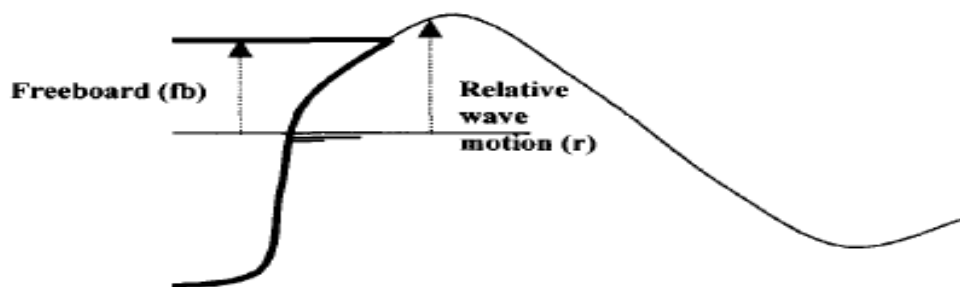


Figure 2.5: Freeboard exceedance at the bow of a vessel (from Buchner [2002])

The vessel motions are pre-dominantly Rayleigh distributed (as they follow the wave pattern), and linear diffraction theory can therefore be a proper way to do the green water predictions. Although assuming that a ships motions are linear when in high waves appears to be a simplification, compared to real ship motions, when compared to model tests with steep irregular waves it was found that the discrepancy was small for pitch motion (Stansberg and Nielsen [2001]) and in Veer and Zuidschewoude [2012] it was found that all vessel motions followed linear theory (see Figure 2.6).

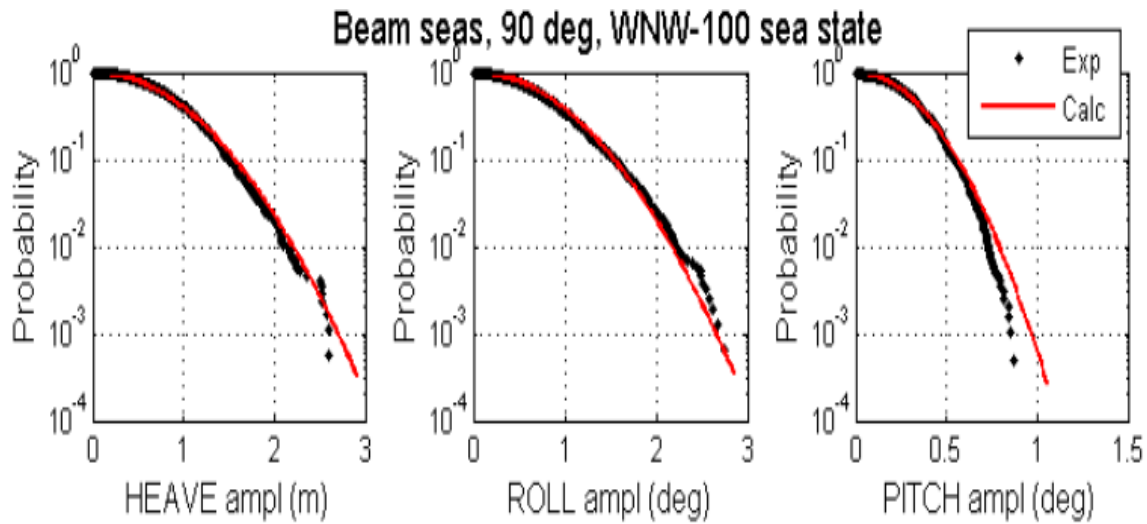


Figure 2.6: Vessel motions can be described by linear theory even if the measured waves do not follow the Rayleigh in the crest distribution (Veer and Zuidschewoude [2012])

Currently the non-linearity of waves and linear ship motions are used to model green water events. As can be seen in Buchner [2002] the motions of a ship and relative wave motions are highly non-linear when considering short waves, but in long waves these movements are closer to the initial Rayleigh distribution. For high waves the opposite holds, high survival condition waves are highly non-linear whereas normal, lower waves more or less follow the Rayleigh distribution.

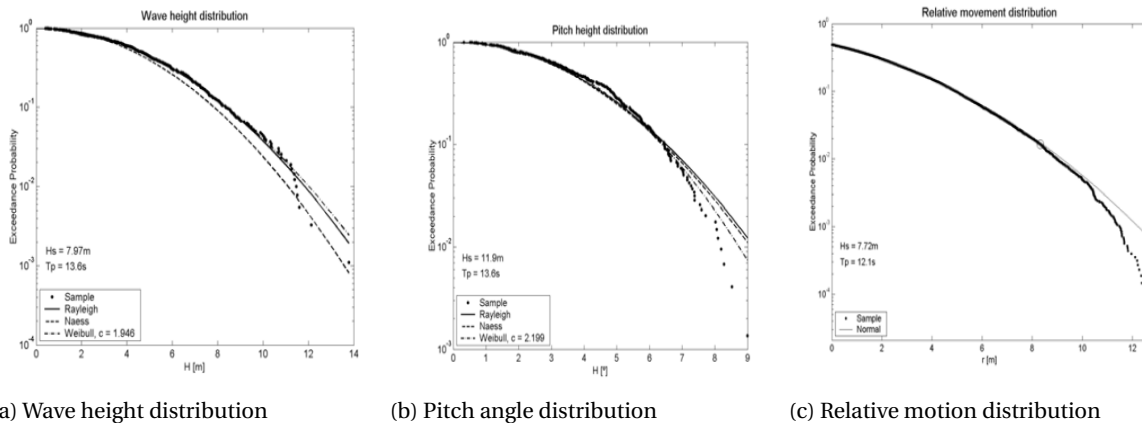


Figure 2.7: Vessel motions, wave height and relative motion measured and calculated using a Rayleigh distribution done by Guedes Soares and Pascoal [2002]

By defining the heave, pitch and roll response spectra, predictions can be done of the exceedance of freeboard.

$$S_r(\omega) = |H_z \zeta(\omega)|^2 S_{JS}(\omega) \quad (2.6)$$

With the transfer function of the relative motion given by:

$$|H_z \zeta(\omega)| = \frac{z_0}{\zeta_0}(\omega) \quad (2.7)$$

These linear prediction methods are widely accepted in prediction of freeboard exceedance. As mentioned before the extreme values, which cause the most severe impact loads, the prediction is poor.

Relative wave height

As mentioned in Section 2.1.2, the vessel motions are mostly linear and well predictable, except for severe low probability events. The wave heights exceeding freeboard are higher than expected when only wave crests

and vessel motions are taken into account. A possible explanation is that the wave is influenced by diffraction and radiation, which are largely affected by the shape of the hull. The linear diffraction theory applies to a rigid body (of a vessel) in the surface of a fluid, with a wave propagating towards this vessel. The wave is divided into an incident wave, a reflected wave and transmitted waves (see Figure 2.8). The transmitted wave is not of interest for the current research and will therefore not be discussed.

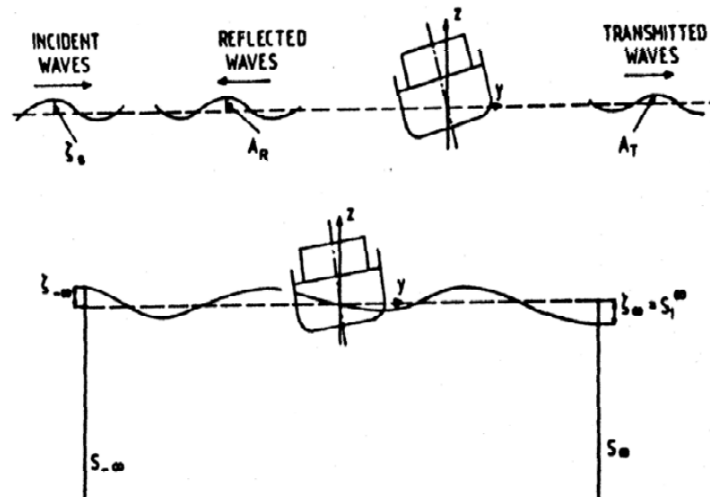


Figure 2.8: A wave passing through the vessel with the different wave components listed

The incident wave and reflected wave determine the relative wave together with the vessel's motions. The components of the linear fluid velocity potential built up when a wave hits a vessel is shown in equation 2.8, the diffraction, radiation and incident wave potential. The total fluid velocity potential describes these components. The three main components are:

$$\Phi(x, y, z; t) = \Phi_r + \Phi_w + \Phi_d \quad (2.8)$$

With Φ_r as the radiation potential component, caused by the oscillatory motion of the vessel in still water, Φ_w as the incident undisturbed wave component and Φ_d as the component that accounts for the diffraction of the waves against the vessel. In Buchner [2002] the effect of these components on relative wave height for different frequencies and different bow types is investigated, concluding that these components are largely dependent on the hull form.

Forcing frequencies and wave mechanisms

Another component causing non-linear motions and resulting water on deck is excitation of the vessel when an (or more) incident wave has the same length as the vessel or the same frequency as the natural frequency of the vessel. Due to longer wave lengths, closer to the pitch forcing frequency of the vessel, the pitch motions increase. This effect also has an effect on added mass and damping of the vessel, what results in more vessel motions (Buchner [1998b]). Another explanation could be that the highest waves don't appear that often and therefore not frequently following after each other. It's a couple of waves inducing a pitch/heave motion, followed by another wave, what causes the most and highest velocity water on deck (Morris and Buchner [2000]). To get water on deck, the ship has to move (slightly) out of phase with the waves. The vessel has to be in the phase that the bow of the ship has not returned to the upward, wave following, motion (downward pitch angle) so that an incoming wave can flow on deck. In that motion, an incoming wave does not break as much as in an upward pitch motion, what has a significant influence in the energy dissipation of a wave flowing on deck (and consequently the on deck velocity and eventual impact on deck). An implication of what Morris and Buchner [2000] describe, is that green water events could occur more often than predictions done based on the highest sea state.

2.2. Water flowing on deck

2.2.1. Ritters Dam Break theory

The incident wave is reflected and pushed up when nearing the vessels bow. The wave crest reaches its top after hitting and running up along the hull. Once this wave exceeds the freeboard, the part that exceeds the freeboard breaks and collapses onto the deck. The most used way of describing water flowing on deck of a vessel is described in the Dam-Break theory, initially defined by Ritter in 1892 (Stoker [2011] & Ryu et al. [2007]). At first the water crawling up alongside the hull forms a "wall" above the freeboard (see Figure 2.9 (a)), then the water starts to flow on deck because of remaining horizontal momentum (see Figure 2.9 (b)).

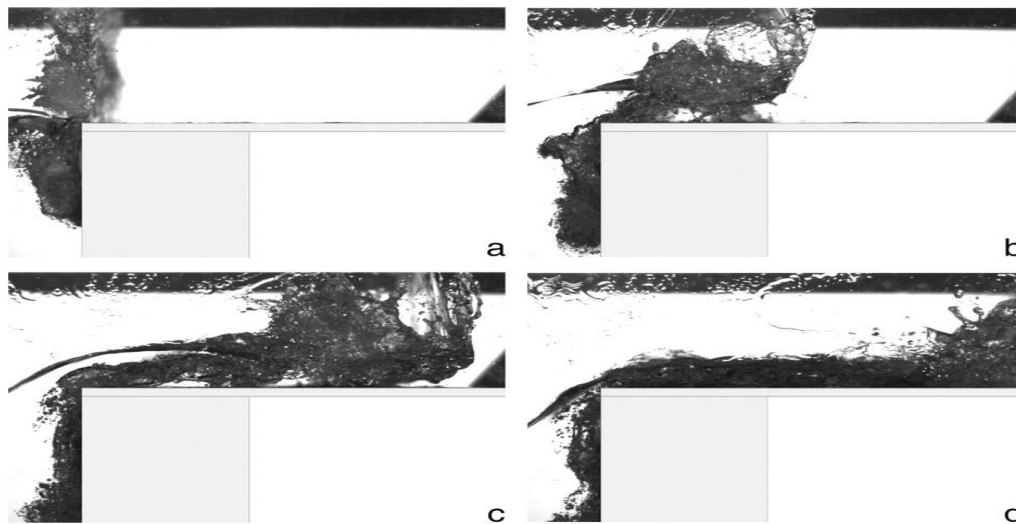


Figure 2.9: Water flowing on deck (Ryu et al. [2007])

After the wave flows on deck, the water from the sides and midst of the bow join in a water jet aft wards, as can be seen in Figure 2.10.

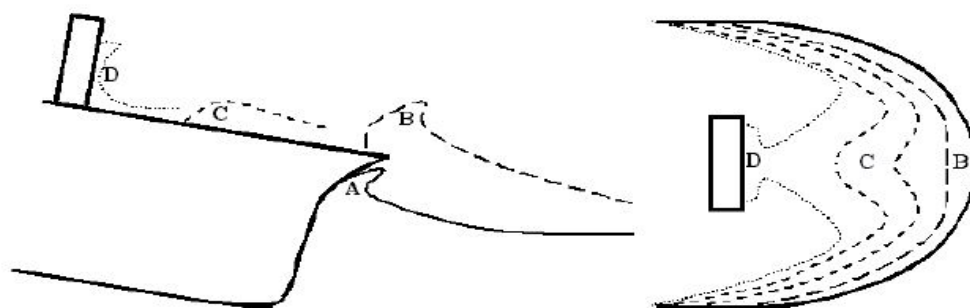


Figure 2.10: Water flowing on deck (Kleefsman et al. [2005])

The phenomenon used to describe this green water occurrence is the breaking of a dam. When a vertical wall holding back a certain amount of water above deck is removed, the water 'collapses' and flows on deck (see Figure 2.11).

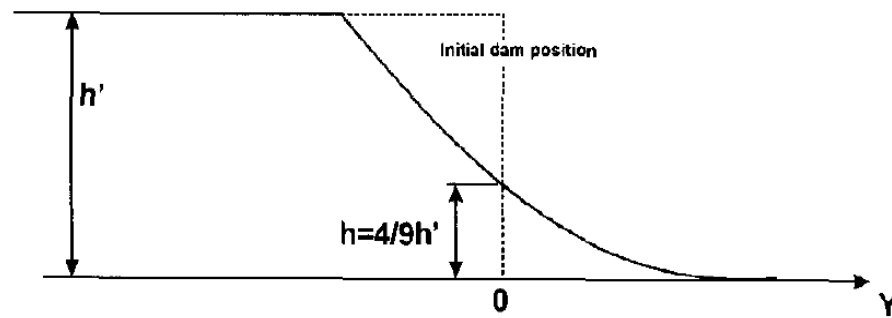


Figure 2.11: Graphic representation of a dam break after some time. With h' as initial water height and y as distance on deck.

As can be seen in Figure 2.11, if exceedance of freeboard is h' , the water coming on deck will not exceed $\frac{4}{9}h'$, according to the Dam Break theory. It is stated that a linear relation exists between the exceedance of freeboard and the water height on deck Buchner and Garcia L-C [2003]. When the wave flows on deck, the theoretical water height is given in equation 2.9.

$$H(x, t) = \frac{4}{9}h' \quad (2.9)$$

The height of the water as it propagates further on deck is given in equation 2.10.

$$H(x, t) = \left(-\frac{x}{3\sqrt{gt}} + \frac{2}{3}\sqrt{h'} \right)^2 \quad (2.10)$$

With x as the distance from the bow and h' is the freeboard exceedance (Buchner [2002]). It is assumed that the resulting flow of water on deck is a shallow water wave, therefore the velocity is constant distributed over the height at one point in the wave. The initial velocity of the wave as it flows on deck can be found in equation 2.11.

$$U_f = 2\sqrt{gh'} \quad (2.11)$$

With h' as initial water depth behind the dam (see Figure 2.11). When the wave propagates across the deck, the velocity of the wave front can be determined as described in equation 2.12

$$U(x, t) = \frac{2}{3}(\sqrt{gh'} + \frac{x}{t}) \quad (2.12)$$

Because of the water breaking on the hull and than traveling vertical, the assumption is made that the horizontal velocity of the wave is zero when it rises above freeboard. Combined with the fact that the vessels in question are moored to the sea bottom, which implies the vessel movement to be zero as well, the way the water comes on deck can be described by using the dam breaking theory (Buchner [2002], Ryu et al. [2007], Veer and Vlasveld [2014]).

Dam break limitations and assumptions

As one can imagine, the flow of a dam breaking is not exactly the same as green water hitting the deck of a vessel. Because of multiple elements in the problem (vessel motions, horizontal water flow, bow shape), the way water flows is effected. The reason the Dam-Break theory is used to describe water flow on deck anyway, is because the two phenomena do have many similarities. When the wave exceeds freeboard, a wall of water is seen above the deck, which resembles a dam with water behind it. Also, because of the wave run-up, the wave has very low horizontal velocity compared to it's vertical velocity. Besides these similarities, the resemblance of a dam breaking and water flowing on deck is limited.

- **Breaking waves have a multi-phase and turbulent nature.** If a wave breaking event takes place near a structure, aeration and turbulence make the situation even more complex Ryu and Chang [2008] while water behind a dam is calm.

- **The water has no initial momentum.** The wave crest exceeding freeboard has horizontal momentum while the water during a breaking dam has none (Buchner [2002]).
- **The wave flows downwards into the empty region after a dam breaks.** The wave flowing on deck has an initial upward velocity while water after a dam break has an initial downwards velocity (Buchner [2002]).

The inaccuracy of the Dam Break problem can be explained by several more reasons, as done by Schoenberg and Rainey [2002];

- **The green water occurrence is not a two-dimensional phenomenon.** Especially when the ships hull has curved edges, the water flows on deck from different angles. These different water flows influence each other which makes the two-dimensional model inaccurate.
- **In Dam-Break theory, it is assumed that an infinite stream of water flows in the empty space.** Due to motions of the ship (pitch and heave) which increase the freeboard and finite amount of water in a wave, the water flow is cut-off at some point.
- **The boundaries of a breaking dam are static.** Because the deck of a vessel is moving, the velocity of the green water wave is accelerated or decelerated, compared to a static dam breaking event.
- **The freeboard exceedance is assumed constant.** Because of the bow moving, the initial freeboard exceedance on which the Dam-Break theory is based varies in time.

Because of the differences between a dam breaking and green water as listed above, the input values for the DB theory are complex to retrieve. As the wave hits the bow when it runs up along the hull, the freeboard exceeding wave is highly aerated. Determining an initial Dam Break height from that value is a difficult task as a wall of water resembling the water behind a dam is assumed. Because of this aeration when the wave exceeds the freeboard and the aeration of the flow when the water hits the deck, the velocity profile of the wave is difficult to determine as well (Ariyaratne and Chang [2011]).

2.2.2. Dam Break additions

In more recent study done, an adjustment to Ritter's Dam Break theory has been proposed, in which the initial wave height is a variable which changes in time Hu et al. [2015]. The assumptions of a classical Dam Break have quite some drawbacks. The initial freeboard height remaining constant causes non-accuracy in the predictions (see equation 2.9). The water flow is derived from the initial water height which remains constant although the initial water height only influences the water on deck for a very limited time, right after it flows on deck. After the initial propagation the water height upstream has limited influence. To account for a varying freeboard exceedance, the constant h' is substituted for a time varying $h'(t)$

$$H(t) = \frac{4}{9} h'(t) \quad (2.13)$$

By applying this the resulting equation (Modified Dam-Breaking model (MDB)) leads to an on deck water height, as can be seen in equation 2.14.

$$H(x, t) = \left(\frac{2}{3} \sqrt{h'(t_k)} - \frac{x}{3\sqrt{g}t} \right)^2 \quad (2.14)$$

with t_k as starting moment of the "Dam Break" event. As can be seen in Figure 2.12, the "initial value h' " changes in time.

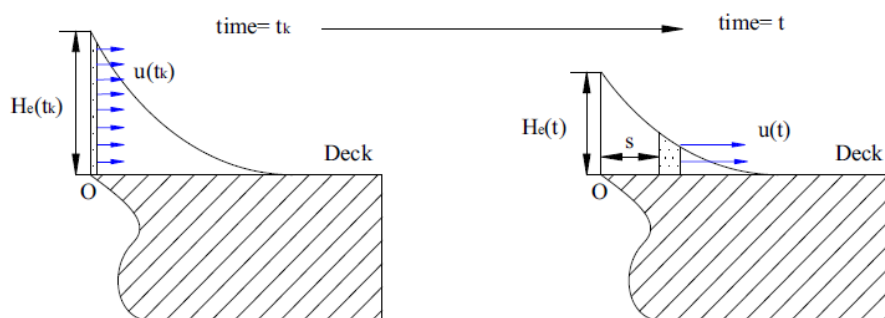


Figure 2.12: Traveling distance (s), from starting moment (t_k) to t with $H_e(t)$ varying over time

The velocity profile is given by equation 2.15.

$$U(x, t) = \frac{2}{3}(\sqrt{gh'(t_k)} + \frac{x}{t}) \quad (2.15)$$

and x given as:

$$x = 2\sqrt{gh'(t_k)} * t^{\frac{2}{3}}(t^{\frac{1}{3}} - t_k^{\frac{1}{3}})$$

Although this theory is modified, the initial assumption is still that $\frac{4}{9}$ of the freeboard exceeding wave will flow on deck, as is the basis of the Dam Break theory by Ritter. Because of limitations of these prediction methods, alternatives to the Dam Break theory are proposed.

2.2.3. Dam Break alternatives

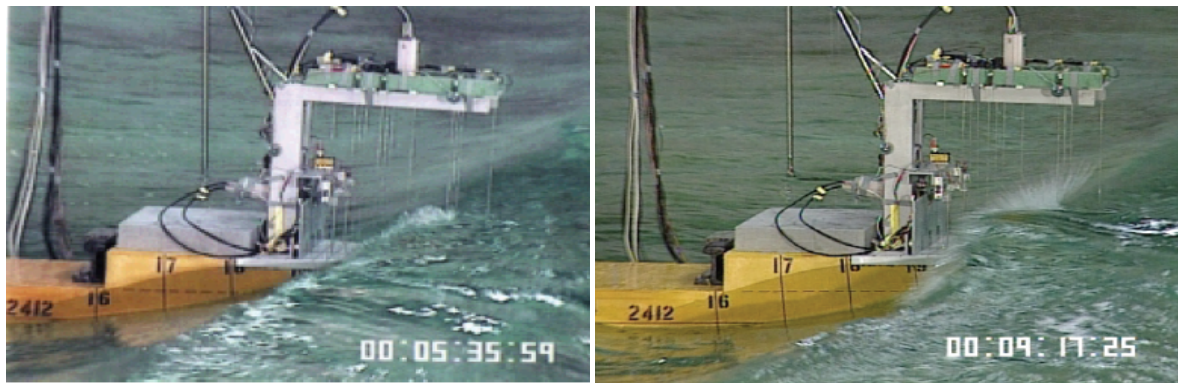
In stead of modifying the initial Dam Break theory to get to an accurate prediction method, an alternative route to a better description of water height on deck is chosen by Greco et al. [2007] and somewhat by Stansberg and Berget [2009]. The assumption here is that one theory does not cover the physics of a wave flowing on deck. To understand how much and with what force and velocity water flows on deck, distinctions in how water comes on deck have been made. As the Dam Break type flow of water on deck not always predicts the right amount of water on deck based on the exceedance of freeboard, other types are distinguished.

Stansberg and Berget [2009] alternative

In Stansberg and Berget [2009] the green water and bow slamming problem is investigated. When analysing the green water waves, Stansberg and Berget [2009] observed two different types of events.

- A high wave and small negative pitch 2.13a
- Steeper crest with a higher orbital velocity 2.13b

Stansberg and Berget [2009] also applied the Dam Break theory, but with an adjustment, taking into account that the wave had an initial velocity before flowing onto the deck. Also they accounted for a non-infinite amount of water from the wave. The first event is characterised by a high “wall” of water flowing on deck, caused by a high wave crest and a small negative pitch angle. The second event is described as a high crest which is steeper than described in the first event and with a higher orbital, this leads to higher impact loads on deck and on the bulwark.



(a) High wall of water, pitch angle

(b) Steep crest, high orbital velocity

Figure 2.13: The two different types of events as described by Stansberg and Berget [2009]

Greco et al. [2007] alternative

In research done by Greco et al. [2007], the main focus lies with distinguishing different types of green water events. In observations of model tests done, they observed five different types of green water events. It must be noted that these model tests were conducted with a fixed, 2D, non vessel-shaped model;

- The Dam-Break (DB) 2.14a
- The Plunging Dam-Break (PDB) 2.14b
- The Plunging Wave (PW) 2.14d

- The Hammer Fist (HF) 2.14c
- The Spray or crash type 2.14e

All the above mentioned green water waves have significantly different patterns when flowing on the deck, as can be seen in Figure 2.14. The Dam Break event starts with a high freeboard exceedance building up in front of the bow, with low initial horizontal velocity, after which the water flows on deck (see 2.14a). The Plunging Dam Break event (2.14b) runs up along the bow and has a round air cavity because of the height above freeboard caused by steepness of the wave. After this run-up along the bow, a Dam Break type flow is observed. The Hammer Fist type (2.14c) is a wave breaking against the bow and flowing on deck in a more horizontal manner than the other events. The incident wave in this case crashes against the bow instead of running up along the bow like the first two events. During the Plunging Wave event a wave breaks before it reaches the bow and is therefore less affected by the bow and "plunges" on deck (2.14d). The Spray event is characterised by a wave hitting the bow and breaking vertically resulting in a highly aerated "wave" or spray, of which a part reaches the deck.

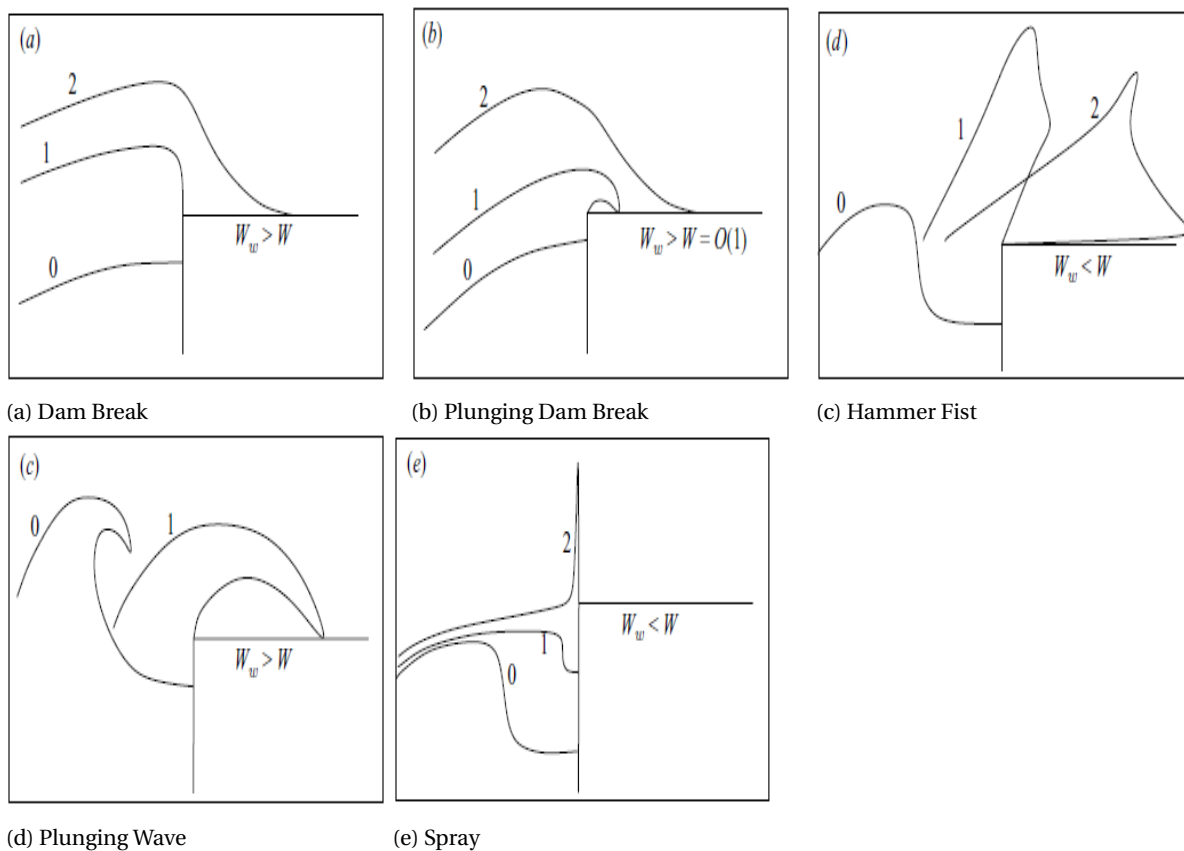


Figure 2.14: The five different types of events as described by Greco et al. [2007]

As is mentioned, the model test on which Greco et al. [2007] base the proposed different green water waves is fixed and 2D. This model test set up has a significant influence on the ability of applying these results when considering a freely floating vessel. The main difference between this model and a freely floating model are as follows:

- **Three dimensional flow on deck.** Waves combining from different sides of the bow, causing an increase in water on deck and different flow patterns. The 'jet' forming will increase, causing higher loads.
- **Dynamic interaction vessel and incident wave.** Due to the interaction between the incident wave and the vessel, pitch and heave motions are induced. These motions of the vessel are not incorporated when using a fixed barge. The pitch and heave motions have a more than significant influence on green water events. The phase angle of the incident wave (and wave groups) together with these motions are not accounted for either.

- **Bow flare and shape influences.** Diffraction of the incident wave against the hull causes higher and steeper crests, the shape of the bow has a significant influence on the measure of induced extra height and steepness. Also, a fixed barge will produce no radiated waves, which influence the height and steepness as well.
- **Presence of a bulwark of 2m.** Due to the presence of a bulwark in the model test under consideration (and in most vessels operating currently), the pattern of the wave flow on deck differs from a model without bulwark.

As mentioned in the suggestions for further research, an investigation into these different types of events occurring while testing a floating vessel is needed, as suggest by [Greco et al. \[2007\]](#).

2.3. Flow pattern and impact on deck

2.3.1. Flow pattern on deck

As can be seen in Figure 2.10, a (typical) green water wave over tops from all sides of the ships bow. Because of the shape of the bow and the water hitting (almost) from a 180 direction, after passing the bulwark, the wave centres on the bow as if it were a water jet. When modeling the water flow, simplifications are made by neglecting the surface friction and the fact that water will flow away from the midst of the ship. Because of these simplifications the calculations done are not completely correct. In measurements done by [Ariyaratne et al. \[2011\]](#) using bubble image velocimetry (using bubbles caused by breaking of the wave to determine the velocity profile), it was observed that the green water flows join from all sides of the bow and impact like a jet, as mentioned before.

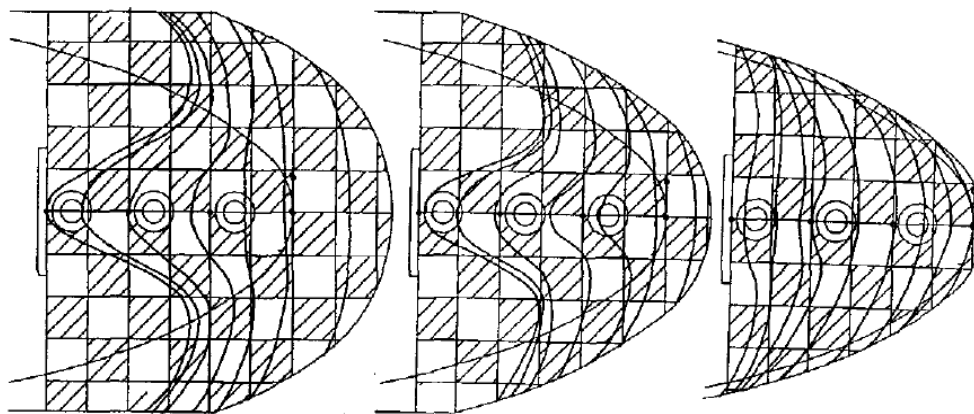


Figure 2.15: Water flowing on deck ([Buchner \[2002\]](#))

2.3.2. Impact on deck

The pressure resulting from green water can be divided in three components; a water jet impinging on a vertical plane, the water building up after collision and that water falling back on the deck ([Buchner \[2002\]](#)). The first component is the most obvious, this is the initial water flowing over the front deck with a high velocity. By multiplying the velocity with the mass of the water, the impact force can be determined. The water meets more than only a vertical wall when propagating over deck. The second component is more similar to static water loading. When the flow finds an obstacle, it piles up in front of it before falling back onto the deck. This piled up water causes a force on deck rather than on equipment. This force is divided in three parts; the static force of (almost) still water, the vertical accelerations of the vessel exerting an extra force and the rate of change of the water level. The third component is the piled up wave falling back on the deck of the vessel which will cause a force because of the amount of water on deck. The energy of the first impact component can be seen as a water jet aimed at the bow. Besides from the horizontal impact on the equipment, the different pressure components of a green water wave are not measured during the model test under consideration and will therefore not be taken into account during this research.

3

Experimental set-up: Model test

The basis of this research is the model test done by SBM Offshore with a Suezmax FPSO in the MARINTEK offshore basin in January 2015. Because of the complexities of the physics related to water and vessel motions, model tests are still necessary to be able to do predictions on wave loading on vessels in certain sea states, in order to design the vessel and test its capabilities.

3.1. Model and basin specifics

The model used in the tests done in the Marin test basin was scaled 1:60. The main vessel specifications can be found in Table 3.1. The drawings and full description of the vessel can be found in figures A.1 & A.2, in appendix A.

Vessel specification	Unit	Value
Mass	MT	185,754.6
Displacement	m^3	185,754.6
Length	m	264.0
Breadth	m	50.0
Depth at side	m	26.5
Draft	m	16.5
Longitudinal CoG wrt Stern	m	144.51
Transverse CoG wrt centreline	m	0
Roll period	s	17.20
Pitch period	s	11.35

Table 3.1: Vessel specifications in full scale

The shape and angle of the bow of the vessel is of significant influence on green water events, as was mentioned in Section 2.1.2. The deck at the bow side (forecastle) of the vessel is elevated compared to the deck more aftwards. The forecastle ends at the turret, which is protected by a barrier. As can be seen in Figure 3.1, where a drawing of the bow of the model is shown, the bow of the model used has a flare, a bulwark (+2m) and an inclined forecastle in some cases. The angle of the bow flare makes with the perpendicular bow is 33 degrees. As mentioned the bow is shown with and without additional deck (inclined forecastle) of 4.2 m above the deck. This is added to test its effect on the green water wave impact on the vertical structure. Also, the bow is bulbous, which decreases drag caused by waves, but (probably) does not have significant effect on the way green water flows on deck as the bulb is located under the water level.

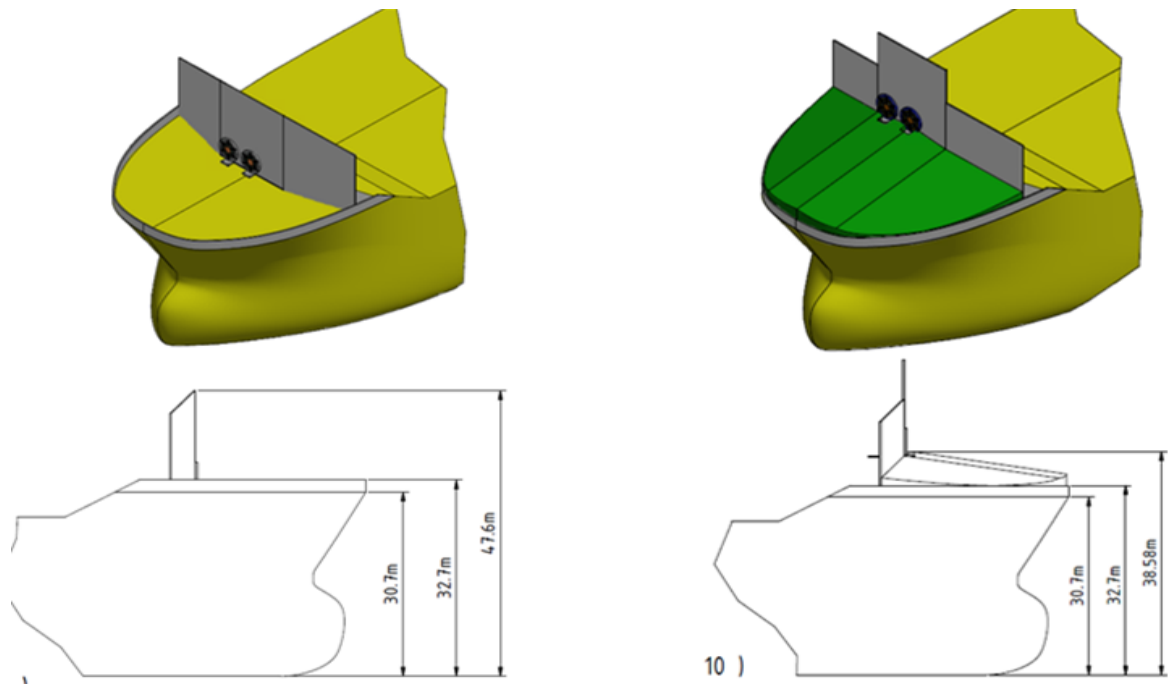


Figure 3.1: Bow shape and sizing in full scale

The MARIN Offshore Basin (schematisation can be seen in Figure 3.2) simulates a realistic representation of a sea in which an FPSO could operate. Through wave generators on both sides of the basin, waves are generated in the desired spectra. The basin can be adjusted (movable floor) to measure up to 600m of depth (1:60 scale). The wave generators, as they are hinged flaps of 40 cm wide, can create regular, short crested and long crested waves. Also, the basin contains wave absorbers to account for wave reflection from the model.

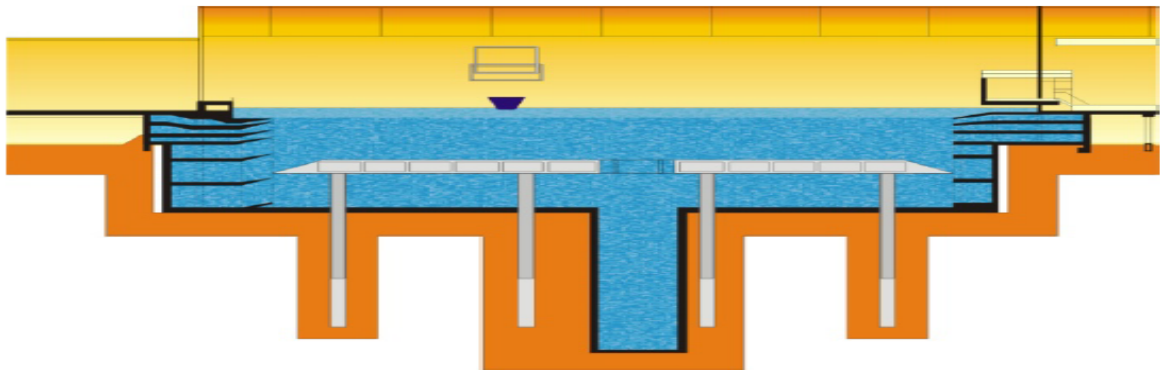


Figure 3.2: Marin Offshore basin

3.2. Sensor specifics

3.2.1. Vessel fixed sensors

To be able to measure the water height on deck, the relative wave height from all sides of the half of the bow and impact pressures induced by green water waves, sensors were placed on the locations as indicated in Figure 3.4. In Figure 3.3 a photo of the actual model is shown in which the sensor placement can be seen.



Figure 3.3: Location of the sensors on the bow, photo of actual model

In Figure 3.4 the blue sensors indicated are the relative wave probes (attached to the bow), the yellow sensors are probes that measure water height on deck and the pink sensors measure the impact force. The wave height sensors are wires that run up to approximately 1m above the bow and the impact sensors are round pressure panels of approximately 30cm in diameter (see Figure 3.3).

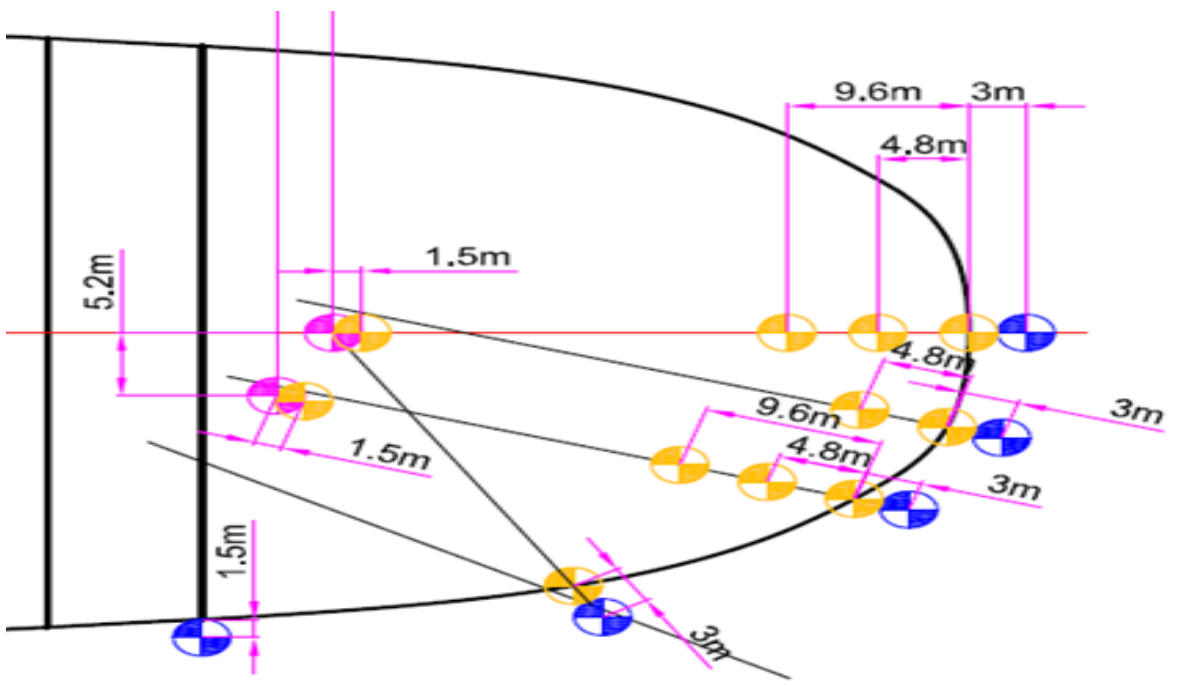


Figure 3.4: Sensor and bow specifications

Besides the sensors on and attached to the deck, several sensors were present in the basin to measure the wave characteristics and do the model test calibrations. As can be seen in Figure 3.5, the model is placed somewhat in the middle of the basin, with the waves coming from the left side of the figure. The waves encounter sensor WAVE 270 first, after which the sensor at the vessel's bow location (used without the vessel in the basin) is reached (WAVE BOW). Two other sensors are located at or near the centre of gravity of the vessel (WAVE CL & WAVE 180). When the vessel is placed in the basin, only sensors WAVE 270 and WAVE 180 are used, and sensors WAVE BOW and WAVE CL are removed.

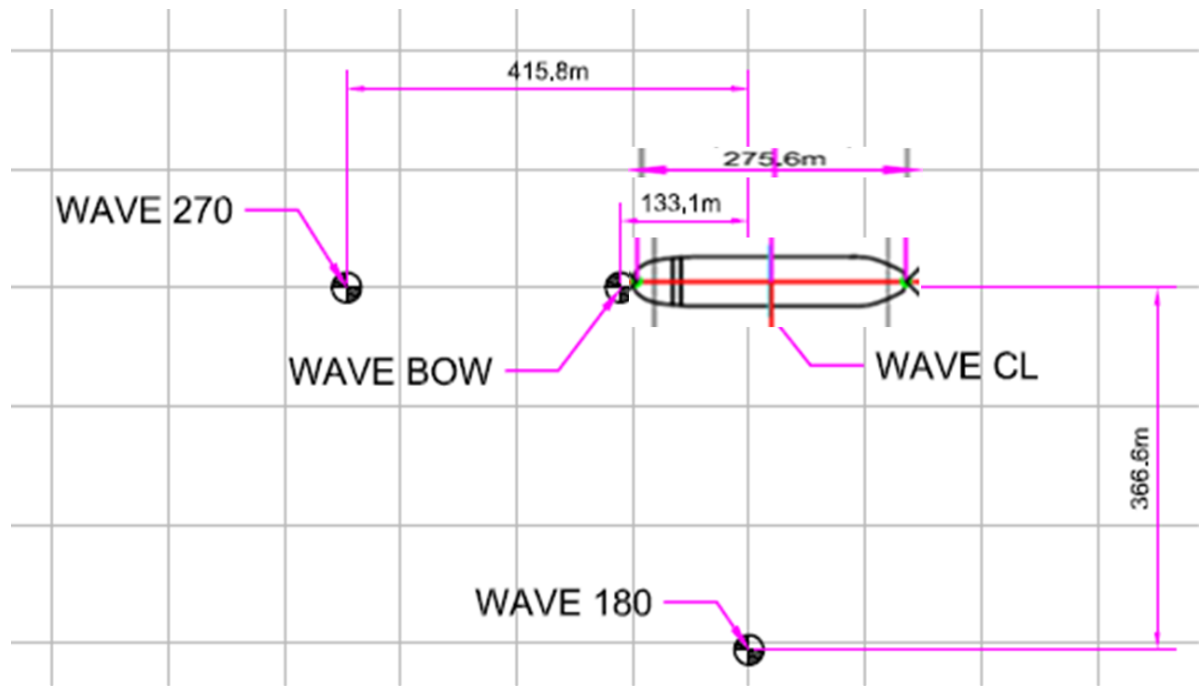


Figure 3.5: Location of the model and sensors in the basin

3.2.2. Vessel motions

Motions were measured with an optical tracking system. The data files contain both the motions at the location of the Krypton tracking system as well as the motion at the centre of gravity. Z

3.2.3. Video representation

During the tests, the model interacting with the waves was caught on camera from different angles; one fixed on the vessel filming the bow from the "equipment" point of view, and one fixed outside the basin filming the complete vessel and parts of the basin. This kind of footage has never been captured (especially the camera fixed on the vessel). This footage is used to classify different events as (especially the vessel fixed camera) they show how the water flows on deck when played frame by frame. Also, unexpected results from the measurements can be verified, such as high relative waves without high impact pressures and negative freeboard exceedances with on deck at the bulwark. From video images it can be seen, for instance, that these values characterize an event that behaves like a sheet of water that runs up but falls back in the sea, which has no impact on deck.

3.3. Wave spectrum input parameters

The different spectra the model was subjected to are listed below. The boundary conditions on which the spectra and different sea state are based are listed here:

- The sea state conditions used are representative for the Falkland island area (Sea Lion project).
- Three different periods with 100 year and one 10,000 year return period wave height are modelled as long-crested JONSWAP wave spectra (see Appendix C, Section C.1).
- No current or wind influences are modelled.

Target and tested wave conditions are shown in Table 3.2. To investigate the influence of the sea spectrum on the frequency and type of green water events, a series of different wave seeds are used during the model tests. The spectra, different wave seeds and calibrated values as used in this research are listed in Table 3.2. As can be seen, only long crested head waves without additional deck are used in this research as time limited the investigation.

Wave	Marin No.	Hs [m]		Tp [s]		gamma [-]		Type [-]	Steepness [-] Tp based
		Target	Test	Target	Test	Target	Test		
W100TP1	03	12.12	11.84	13.56	13.57	1.83	2.1	Long crested	0.041
	04		11.88		13.57		2.0		0.041
	05		12.13		13.49		2.0		0.043
W100TP3	06	12.3	12.24	14.18	14.09	3	3.3	Long crested	0.039
W100TP3	07	12.3	12.11	15.65	15.86	2	2.0	Long crested	0.031
	08		11.93		15.95		2.0		0.030
W10kTP1	09	15.12	15.05	15.34	15.28	2.6	2.7	Long crested	0.041

Table 3.2: Key parameters of the sea state spectra targets and the calibrated values

The main values from the different sea state spectra and the abbreviation used when referenced in the continuation of this report are listed in Table 3.3.

Sea state	Hs (m)	Tp (s)	γ (-)	Steepness (-)
S1	12.12	13.56	2.0	0.041
S2	12.3	14.18	3.0	0.039
S3	12.3	15.65	2.0	0.030
S4	15.12	15.34	2.6	0.041

Table 3.3: Key parameters and abbreviations of sea state spectra used in this research

3.4. Possible measurement flaws

From measurement data and verified by video observation it was seen that some values measured do not represent exactly what they should show because of some model test characterisations. Some measurement flaws can not be prevented, what increases the value of the video footage made of the tests. A couple of identified characterisations that should be noted are listed below:

- Water on deck can not flow away easily, what causes measurements of water on deck not related to a green water wave.
- Due to the distance between the relative wave sensor and the bulwark, a very steep wave could flow behind this sensor. The freeboard exceedance measurement could therefore show a lower value than it should.
- The pressure panels are located close to the deck and are +- 30cm in diameter. Because of this a chance exists a wave hits the turret protection and (partly) misses the pressure sensor.
- The amplitudes in the measured sway, roll and yaw in head seas suggest that the heading of the vessel was not perfectly nor constant 180 degrees. This can be expected in model tests.

4

Experimental set-up: Observation, wave and vessel parameters

As described in Section 3, the video of model test performed are used as base for this research. To quantify and physically explain the observed green water phenomena, the model test measurements are used to calculate sea state, incident wave and vessel related characteristics.

4.1. Measurement input and data synchronisation

4.1.1. Wave input selection

As described in Section 3.2, different wave data is available, measured by a number of sensors fixed to the vessel and floating in the basin. To determine the flow on deck, the center-line and the different sensors divided just outside and inside the bow are used (which can be found in Figure 4.2).

To determine the wave characteristics, multiple measurements are available. The wave probe fixed to the vessel measuring the relative wave and the wave probe at the bow location without the vessel present can be used to determine the wave hitting the vessel. A comparison between the two wave measurements is shown in Figure 4.1, with the red line as the undisturbed incident wave and the blue line as the relative wave corrected with vessel motions (disturbed wave). As can be seen in the figure, the disturbed crests are somewhat steeper and higher than the undisturbed wave. This is caused by wave run-up and diffraction caused by the bow of the vessel.

Using the undisturbed wave shows the impact of a certain type of wave instead of the wave influenced by the vessel (and therefore typical vessel specifics), but this wave is not the actual wave causing green water it is significantly influenced. On the other hand, using the disturbed wave limits the ability of drawing conclusions from this research based on a certain sea state.

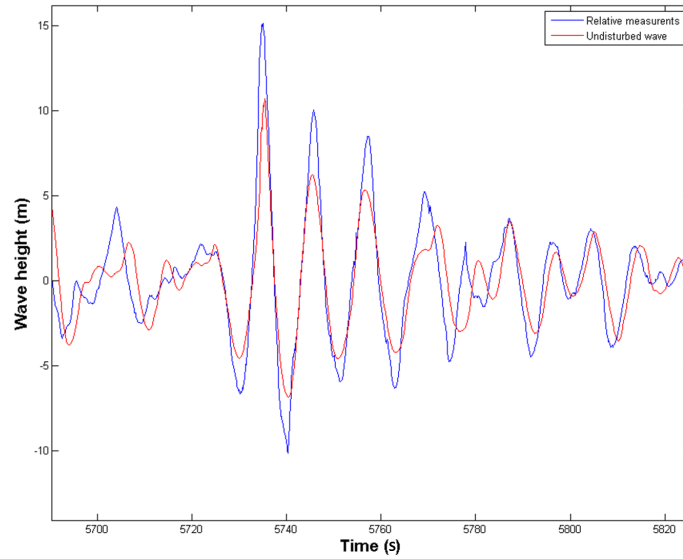


Figure 4.1: Comparison of wave height at the bow, measured with and without model

The different probes installed on the deck of the model are shown in Figure 4.2. The measurements of the bow of the model and the distances between the probes are shown in Figure 3.3. The probes outside of the bow are used to determine the parameters of the incident wave. The probes on the bulwark and further on deck are used to measure the height, velocity and the pattern of the flow of the wave on deck.

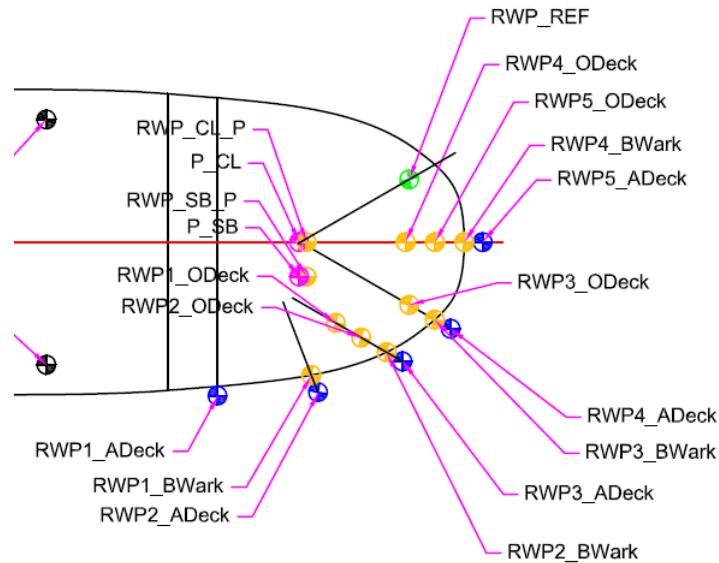


Figure 4.2: Sensor names and locations

4.1.2. Video and data synchronisation

To determine values related to the green water events, the times of occurrences of the events are determined. The videos of the model tests are, of course, also in model scale. So to synchronise the measurement data with the video footage, the measurement data time is scaled down by $\sqrt{60}$ to match the videos. Also, the measurement and the videos did not start at the same moment, and this had to be corrected precisely to be able to observe the vessels motions at the exact right moment.

4.1.3. Green water event distinction and classification

A green water event is defined as a 'bulwark breach', a certain wave height measured by the sensor fixed on the bulwark. To remove insignificant green water events (very low impact values) and water on deck remaining from an earlier event that has not flown away (as mentioned in Section 3.4), an event classified as green water event is chosen to have a minimum of 0.5 meter water height (full scale) above the bulwark. To get a clear view of water on deck caused directly by a green water event, all measurements lower than 0.5 m are set to zero as well.

As the lower values are set to zero, the values that exceed this zero value can be defined as a green water wave. To distinguish different types of green water waves, the green water events were observed using the set-up as shown in Figure 4.3. The main parameters are the vessels motions (mainly the height of the bow) and incoming wave height. The wave pattern on deck was studied simultaneously using the bow fixed camera. The remaining events are classified, initially, by observation of the model test video, and later on verified (iterative process) with the measurement data.

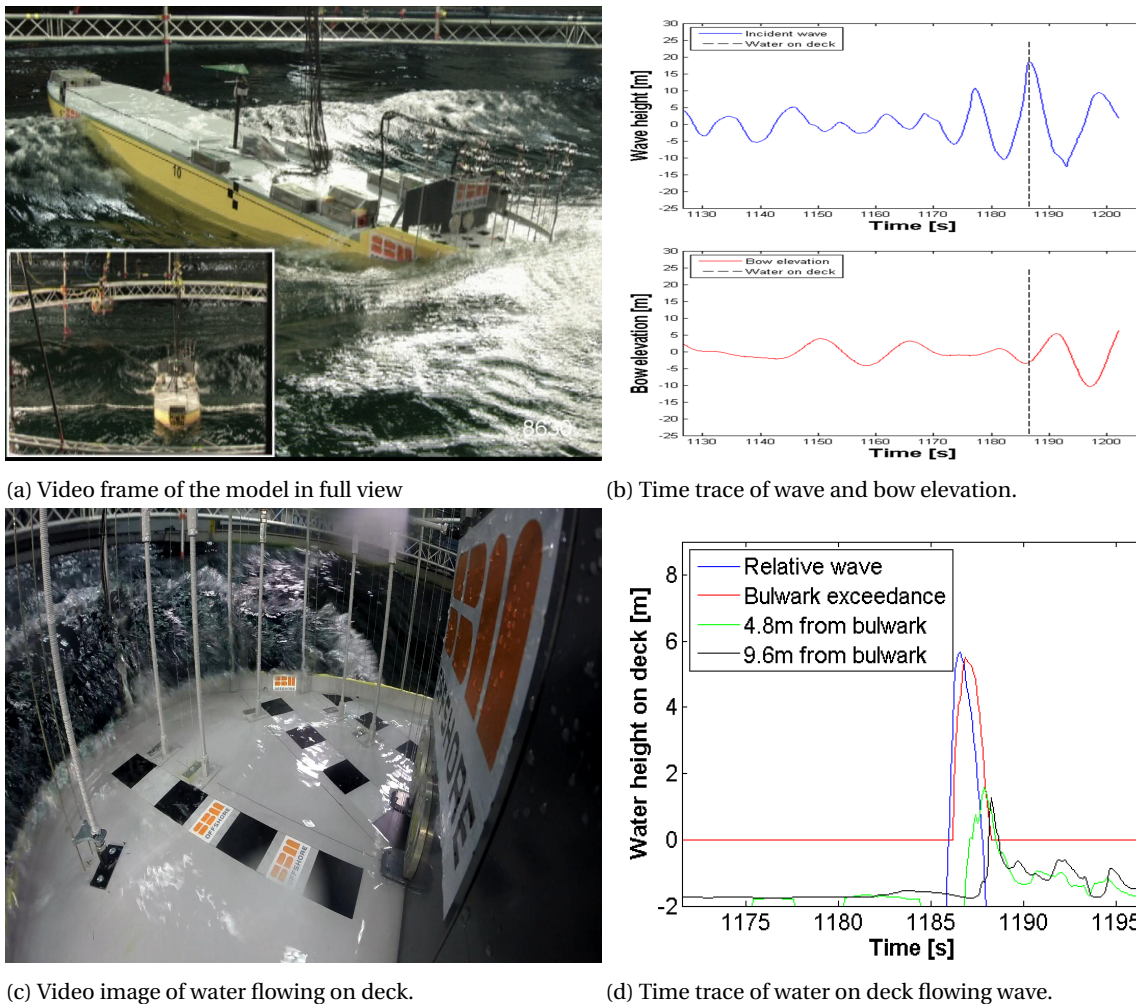


Figure 4.3: Set-up of measurement and observational data for classification study.

4.2. Wave and vessel motion parameters

4.2.1. Vessel motions and characteristics

Degrees of freedom motions (DOF)

Because of the vessels motions, the height of the wave above the bow is referred to as the relative wave height. The vertical motion of the bow of the vessel is determined by the three degrees of freedom that cause vertical displacement; heave (z_h), pitch ($x_b\theta$) and roll ($y_b\phi$) motions (Journée and Massie [2001]). The six degrees of freedom of a vessel are shown in Figure 4.4. This relative motion is an important factor when investigating the

shipping of water on deck and slamming of the vessel. The vertical relative motion z_{rel} at the bow ($P(x_b; y_b)$) is defined in equation 4.1. The distances used for $x_b = 143.3$ and $y_b = 0$, vertical motion of the center of the bow is determined.

$$z_{rel} = \zeta_p - h = \zeta_p - z + x_b\theta - y_b\phi \quad (4.1)$$

with:

ζ_p = Local wave elevation

h = bow motion

z = heave displacement

x_b = distance from COG x-axis

y_b = distance from COG y-axis

θ = pitch angle

ϕ = roll angle

The six ways a vessel can move are depicted in Figure 4.4. As can be seen, the motion contributing to vertical bow elevation are the three degrees of freedom previously mentioned; pitch, heave and roll. The axis system in the figure is the same as the axis system in the calculations done. A positive pitch angle means that the bow of the vessel is moving downwards, a positive heave value however means that the vessel is moving upwards.

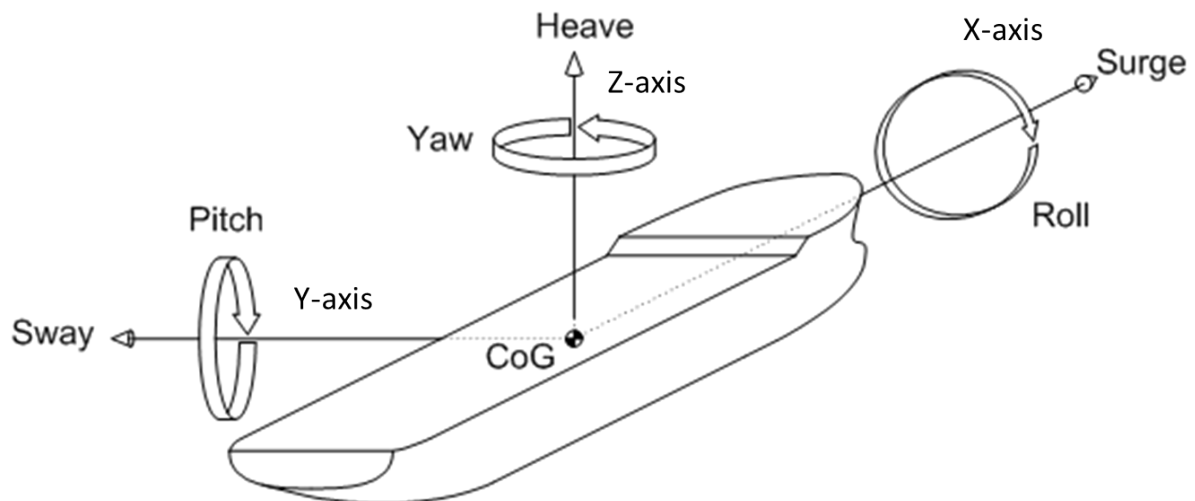


Figure 4.4: Six degrees of freedom vessel motions

To determine the vessels motions, during the model test, the angle and displacements the vessel makes at the centre of gravity of the model are measured. As the angles are a ratio between values, the scaling doesn't influence the values. The axis-system used in the calculations can be seen in Figure 4.4. The acceleration in every degree of freedom can be calculated from these values by dividing the displacement by the time it takes (0.0775 s per measurement step). The moment the vessels motions are measured is right before the wave flows on deck, when the relative wave probe is reached.

Response Amplitude Operators (RAO's)

The motions measured are influenced by certain wave frequencies, the natural frequency being the most influential. The resonance a vessel has to a certain wave height depending on the waves frequency can be determined with the Response Amplitude Operator (RAO) of the vessel. As the wave direction of the waves is 180 degrees (head waves), the heave and pitch RAO's are leading. The definition of these RAO's are given in equations 4.2 & 4.3.

$$\text{Heave RAO} = \frac{z_a}{\zeta_a} \quad (4.2)$$

$$Pitch\ RAO = \frac{\theta_a}{k * \zeta_a} \quad (4.3)$$

with

$$\begin{aligned} z_a &= \text{heave amplitude} \\ \zeta_a &= \text{wave amplitude} \\ k &= \text{wave slope} \end{aligned}$$

The RAO's define the response of a vessel to a waves amplitude. These RAO's can also be denounced as transfer functions, as they describe the transfer from a wave amplitude in vessel motions. The transfer functions are calculated by making use of the wave and vessel spectra. When these spectra are known, the vessels motions (theoretical motions) can be calculated with following equations:

$$\left| \frac{r_a}{\zeta_a}(\omega_e) \right| = \sqrt{\frac{S_r(\omega_e)}{S_\zeta(\omega_e)}} \quad (4.4)$$

with

$$\begin{aligned} S_r &= \text{motion response spectrum} \\ S_\zeta &= \text{incoming wave spectrum} \\ \left| \frac{r_a}{\zeta_a} \right| &= \text{response RAO} \end{aligned}$$

The spectral density of the incoming wave signal during model tests is calculated and divided by the input spectrum to obtain the RAO.

4.2.2. Wave characteristics

In the following the wave parameters used in the analysis are described. It will be discussed how these characteristics are determined by using the model test data input described in Section 4.1. The sea state values are given in Section 3.3. The definitions of wave parameters as used in [Group et al. \[2000\]](#) & [Soares et al. \[2004\]](#) are used for the definition of the wave parameters here.

Wave period and frequency

The wave period of the incident wave can be defined in two different ways; the wave up-crossing and the wave down-crossing period. As illustrated in Figure 4.5, the wave up-crossing period (T_u) is determined by adding T_3 , T_4 , T_1' & T_2' , as between these points the wave crosses the still water line in the upward direction. The wave down-crossing period (T_d) is determined by adding T_1 to T_4 , as these are the points the wave crosses the still water line in a downwards direction.

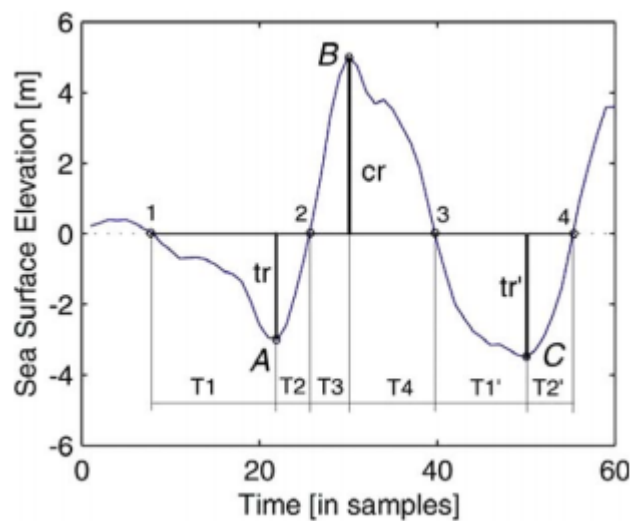


Figure 4.5: Wave and crest period definition as done in [Soares et al. \[2004\]](#)

As can be seen in Figure 4.5, the time passing between A to B and B to C differs significantly. Therefore, the crest and trough period can be determined as individual periods as well. This can be divided in a crest front period and a crest back period. The crest period is determined by adding the crest front period, T_3 , to the crest back period, T_4 . The actual wave data is shown as shown in Figure 4.6. The still water crossings of the incoming wave data is determined. As can be seen, the time between T_3 and T_2' is determined for every wave passing by the sensor, which is the up-crossing wave period.

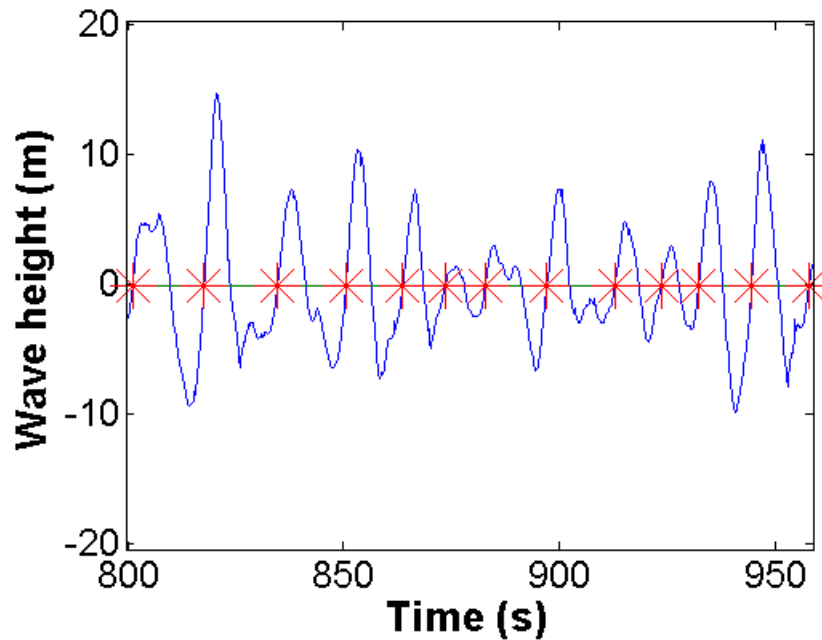


Figure 4.6: Upcrossing wave period point of measurement

As the wave period is determined, the incident green water wave frequencies can be calculated. This is done by using the frequency dispersion relation, as given in equation 4.5.

$$\omega^2 = k \cdot g \cdot \tanh(kh) \quad (4.5)$$

$$\omega = \frac{2\pi}{T} \quad (4.6)$$

with

$$\omega \left(\frac{\text{rad}}{\text{s}} \right) = \text{angular wave frequency}$$

$$T(\text{s}) = \text{wave period}$$

Wave length

The incident wave length is determined by making use of the dispersion relationship, formula 4.5. When regarding deep water \tanh approaches 1. From this, the equation for wave length follows as stated in equation 4.7.

$$\lambda = \frac{g}{2\pi} * T^2 \quad (4.7)$$

with

$$\lambda = \text{wave length}$$

$$g = \text{gravity}$$

$$T = \text{wave period}$$

Wave height

The wave height of the incident wave is defined as the difference between the crest height and trough depth. The up crossing wave period is used to determine the wave heights, as indicated in Figure 4.5, adding the measured crest and trough heights, as is shown in equation 4.8.

$$H_{wave} = H_{cr} + H_{tr'} \quad (4.8)$$

Wave steepness

The steepness of a wave is defined as the ratio between the wave height and length.

$$S = \frac{H}{L} \quad (4.9)$$

As the exact wave length is difficult to measure because of irregularities in the incident wave, the wave length is based on the before mentioned dispersion relation. By replacing the wave length by equation 4.2.2, the local wave steepness of the incident wave is found. This relation is found in equation 4.10.

$$S = \frac{2\pi * H}{T^2 / g} \quad (4.10)$$

Because of this irregularities and the use of the dispersion equation, the steepness of the single incident waves are called coefficients of steepness, in stead of the actual wave steepness.

Crest steepness

Because of the asymmetry of the incident waves, as stated by Soares et al. [2004] (see Figure 4.5) and in the measurements (see Figure 4.6), characterizing a wave completely with one steepness indicator is misleading. For this reason the steepness of crests are determined. When defining the crest steepness, both the crest front (cf) and crest back (cb) steepness can be determined (In 4.5, cf= T3, cb= T4). To determine the coefficient of crest front steepness of the incident wave, equation 4.11 is used.

$$S_{cf} = \frac{2\pi * cr}{T_{cf}^2 * g} \quad (4.11)$$

with T_{cf} as the crest front period and cr as the height of the crest. The front crest period is defined by the time between the crest maximum and the moment of up-crossing. This is visualised in Figure 4.6.

Phase velocity

To determine the phase velocity of the incident waves related to the green water occurrences, the dispersion relationship for deep water waves is used, as can be found in equation 4.12.

$$c_p = \frac{g}{2\pi} * T_u \quad (4.12)$$

with c_p as the phase velocity, g as gravity acceleration and T_u as the up-crossing wave period.

4.2.3. Water flow on deck

Steepness on and before the deck

As a wave flows on deck, different green water waves have a different flow pattern. The slope of the wave flowing on deck is a complex value to determine, as the wave propagates and its height above the deck and bulwark therefore vary in time. The value calculated and used in this research is therefore better specified as a steepness indicator of the wave slope as it flows on deck.

It is assumed that the highest point of a green water wave at the bulwark corresponds to the highest point of this wave further on the deck. The steepness indicator of the wave before deck is the difference in height between the maximum value measured by probe RWP5Adeck and RWP4bwark divided by the distance between these probes (see Figure 4.7). The steepness indicator of the wave on deck is similar, but using the bulwark probe and probe RWP5Odeck, and dividing these values by 4.8m.

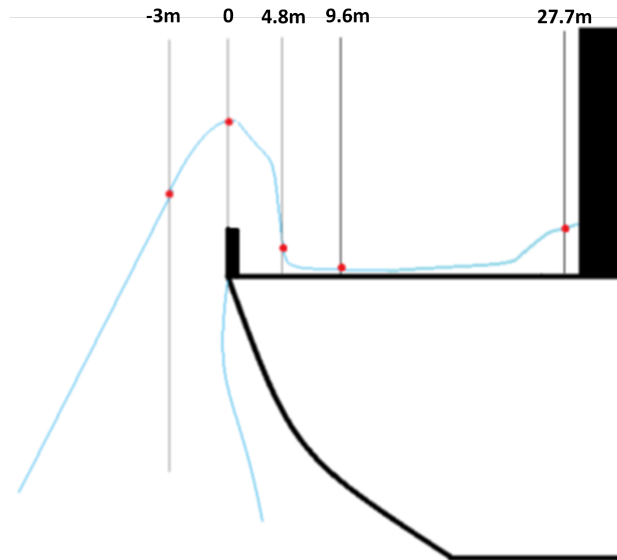


Figure 4.7: Wave probes used to determine the steepness of the wave slope when flowing onto the deck. The distance between RWP5Adeck and RWP4BWARD (relative wave probe and bulwark probe) is 3m, the distance between RPW4BWARD and RWPO5Odeck (bulwark and on deck probe) is 4.8m

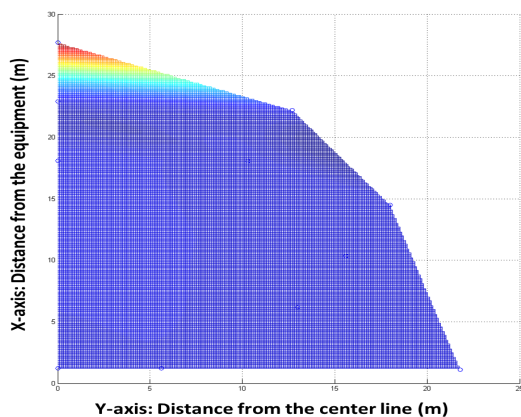
Creating a visual representation of the measurement data

As the sensors give discrete values, and the amount of sensors was, off course, limited, the measurements don't give a good visual representation of the wave flow on deck. Therefore a grid is created using the measurements as input points and by interpolating between the different sensors the wave pattern can be visualised. Using the grid, it is also possible to determine the average water height on deck.

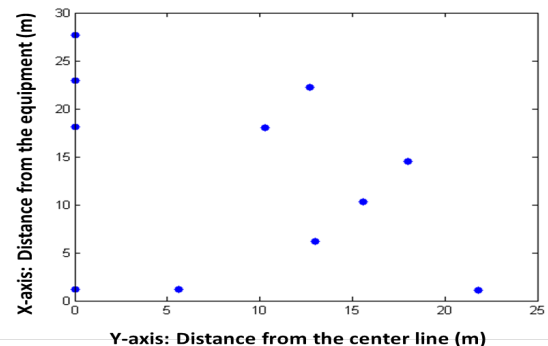
In Figure 4.8b the grid input data is shown, where a top view of the bow is used (y-axis as the center-line of the bow). The distances between the grid points are based on the distances between the sensors, which can be found in Figure 3.4.

The interpolation is done by a cubic spline interpolation between the different sensors. The integration distance dx and dy were chosen 0.1m. Because the sensors were not located on the left side of the bow, a solution could have been to copy the data to this side of the bow to get a full view of the water flow as head waves were used. It is chosen not to use this because tests have shown that the incoming wave and vessel angle is not completely head on (roll motions etc.).

Bow of the vessel



(a) Grid of right half of the bow of the model in full scale



(b) Location of the sensors used as input for the grid.

Figure 4.8: Image of a grid calculation for a moment in time and the probe locations as used in the grid as input data.

Water height on deck

The sensors 4.8m on deck, the sensor 9.6m on deck, and the sensor at the equipment (see Figure 3.4), on the center-line of the bow, and from the sides of the bow are used to determine water height. The maximum values during each green water event are used as the water height on deck as it is assumed that these values correspond to the wave flowing over the deck.

As mentioned before, the values lower than 0.5 meter are discarded as these are not of interest for this research and could be measurements from water with no relation to the green water event.

It is assumed that a wave height maximum when it flows on deck corresponds to a maximum measured further on deck. The total amount of water on deck is determined by interpolating between the probe measurements using the grid, as described in Section 4.2.3.

Velocity on deck

To be able to track the wave as it propagates over the deck, it is assumed that the highest point of a wave front at the bulwark corresponds to the highest point of this wave front further on the deck, as was done to determine the steepness indicator of the on deck flowing wave. The measurements of the center-line probes were used to track the propagating wave.

The velocities are calculated by dividing these values by the distance that is covered (4.8, 9.6 and 27.7m respectively), in meters per second. To verify the velocities, the video footage are used. By playing the model test videos frame by frame, an estimate of the velocities can be made. The video frame-rate is 25 frames per second (0.04 sec), what corresponds to 0.3098 on full scale ($0.04 \cdot \sqrt{60}$). In figures 4.9a, 4.9b & 4.9c a wave is shown as it flows on deck. As can be seen, the wave flows 4.8m in 0.62 seconds, what results in a velocity of $7.74 \frac{m}{s}$.



Figure 4.9: Frame by frame footage of a green water wave flowing on deck, with a frame-rate of 25 frames per second

4.3. Parameter and data pairing summary

By observing the model videos (full view and bow fixed), an initial attempt was done on classifying different events. Through an iterative process of observation, data comparison and visualisation of the data, different types of green water events were distinguished. Threshold values for vessel motions and wave height were used when it was unclear from the video observation what type of event occurred.

A summary of the incident wave, vessel motion and on deck parameters as used in the analysis is given in Table 4.1. A brief definition as well as the moment the values are determined are shown.

	Symbol	Unit	Definition	Moment measured
Wave characteristics				
Period	T_u	[s]	Period between two up-crossings of the still water level	During and 1 instance before event
Orbital Frequency	ω	[rad/s]	Inverse of the wave period times 2π	During and 1 instance before event
Length	λ	[m]	Length of the wave, wave period based.	During and 1 instance before event
Height	H	[m]	Difference between the trough depth and crest height of the upcrossing period	During the event
Steepness	S	[-]	Steepness of the wave based on the height and period of the wave	During the event
Crest steepness	S_c	[-]	Steepness of the crest based on the height and period of the crest	During the event
Phase velocity	V	[m/s]	Velocity of the wave based on the period (dispersion relation)	During the event
Water on deck				
Steepness on/ before deck	S_d	[-]	Relation between measurement height and horizontal difference between probes	At maximum of specific probe measurement
Water height on deck	H_d	[m]	Values above 0.5m measured on deck	At maximum of specific probe measurement
Vessel motions				
Pitch angle	θ	[degr.]	The angle the vessel makes with the x-axis	Maximum FB exceedance
Heave	z	[m]	The vertical displacement the vessel is in with respect to the still water level	Maximum FB exceedance
Bow elevation	z	[m]	The vertical displacement of the bow, adding the contributions of the pitch angle and heave displacement.	Maximum FB exceedance

Table 4.1: Summary of wave and on deck parameters used during the analysis

5

Results: Green water event quantification and comparison

During the model test described several sea states were simulated. The analysed data from these sea state runs are shown here. In Table 5.1, the different wave seeds used, the amount of green water events measured during these wave seeds, the mean of the impact loads and the maximum impact loads are shown. It can be seen that the steepness of the sea state causes a higher amount of green water events and a higher average and maximum impact on deck.

	Hs [m]	Tp [s]	S [-]	λ [m]	event/ hour	Mean impact [kN]	Max impact [kN]
S1	12.12	13.56	0.041	287.08	9	37.29	386.86
S2	12.30	14.18	0.039	313.93	10	57.30	1094.0
S3	12.30	15.65	0.030	382.40	3	20.91	235.27
S4	15.12	15.34	0.041	362.63	14	83.57	1071.0

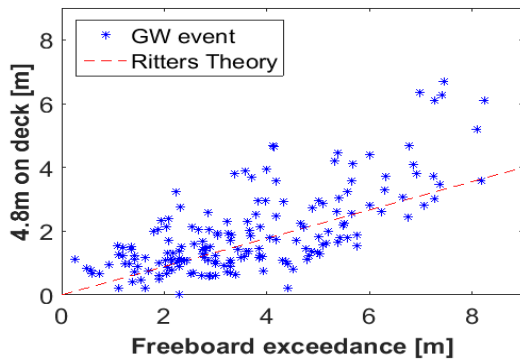
Table 5.1: Incident wave parameters causing the different events.

The analysis of the green water events will be discussed in the following chapters. First the Dam Break theory is evaluated based on its accuracy of predicting initial water height and velocity on deck, together with previous research done on the subject. New types of green water events as distinguished during model test observations and the wave and vessel parameters that cause them are investigated. Finally, the new classifications are compared with the current governing theories.

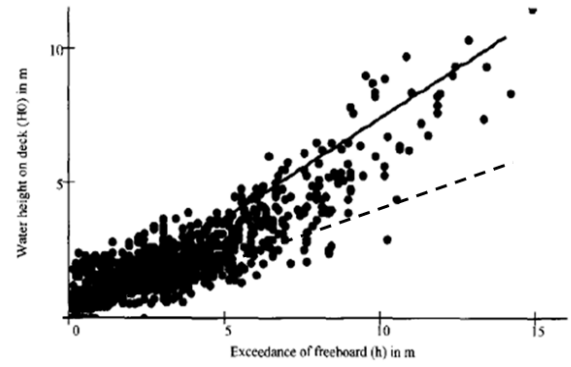
5.1. Dam Break validation

In Figure 5.1 the water height on deck predicted by the Dam Break theory and measured in model tests done by Buchner [2002] & Zhou et al. [1999] and this research are compared. In all figures the Dam Break theoretical line is shown as an intermittent line. During the model tests done by Buchner [2002] & Zhou et al. [1999] no measurements were done on the bulwark, as was done in the model tests of this research. To be able to compare the results, the measurement data of the probe 4.8 meter on deck and the relative wave probe are chosen, as a similar distance is used in the research of Buchner [2002] & Zhou et al. [1999].

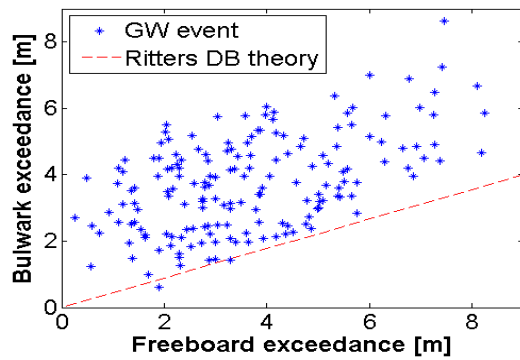
In figures 5.1a, 5.1b & 5.1d the relation between the exceedance of the freeboard and resulting water on deck (respectively 4.8m, 6m and 6m from the bulwark) are shown. As can be seen, the values are largely under-predicted by the classical Dam Break theory. In Figure 5.1c the relation between this freeboard exceedance and the height exceeding the bulwark is shown.



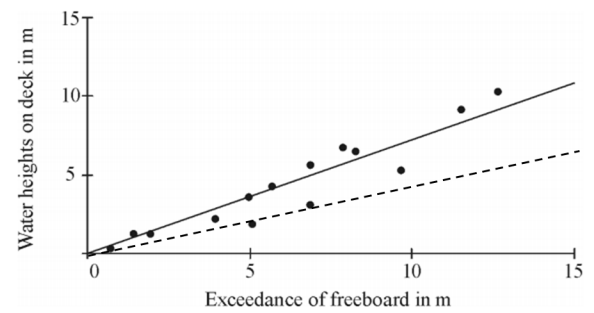
(a) Freeboard exceedance vs probe 4.8m on deck.



(b) Comparison done by Buchner [2002]



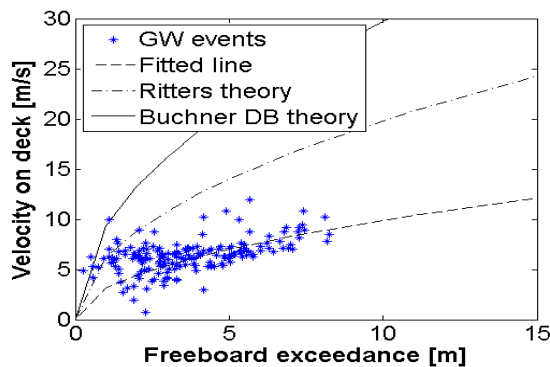
(c) Comparison data this research



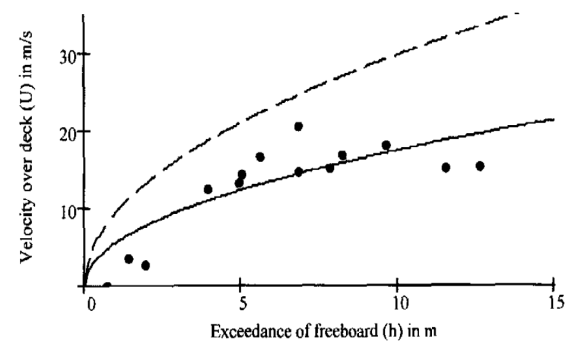
(d) Comparison done by Zhou et al. [1999].

Figure 5.1: Freeboard exceedance vs bulwark exceedance comparison with the classical Dam Break theory values

The second part of the Dam Break theory is the prediction of the velocity of the green water wave as it flows on deck (into the empty space). The velocity shown in Figure 5.2a is the time it takes for a wave to reach the equipment divided by the distance (as described in Section 4.2.3). The velocity used by Buchner [2002] is approximately at the same position on the deck, measured by a horizontal wave probe. As can be seen in the figures, the Dam Break theory description of the initial velocity of the wave on deck based on a certain freeboard exceedance does not describe the values measured in the model test of this research and as described by Buchner [2002] (in Figure 5.2b).



(a) Comparison data this research



(b) Comparison done by Buchner [2002]

Figure 5.2: Velocity on deck flowing wave vs bulwark and freeboard exceedance

It can be stated from the figures shown that the Dam Break theory is inaccurate for the types of vessels under consideration, as many deviations from the theory are measured and observed in the video data. The results from multiple investigations in this theory show that the Dam Break formulas predict an initial water height on deck that is significantly lower than the measured values. The velocity predictions of the Dam Break formula result in significant higher values than calculated from model test data.

5.2. Green water classifications

As described in Section 1.3, the hypothesis was that one theory does not describe the green water phenomenon completely, as is supported by the measurements and previous research described above. The different green water event classifications made are listed below. Illustrations of the different classifications are shown in Figure 5.3. As can be seen, these classifications are derived from Greco et al. [2007].

- **Dam Break (DB)**
- **Plunging Dam Break (PDB)**
- **Hammer Fist (HF)**

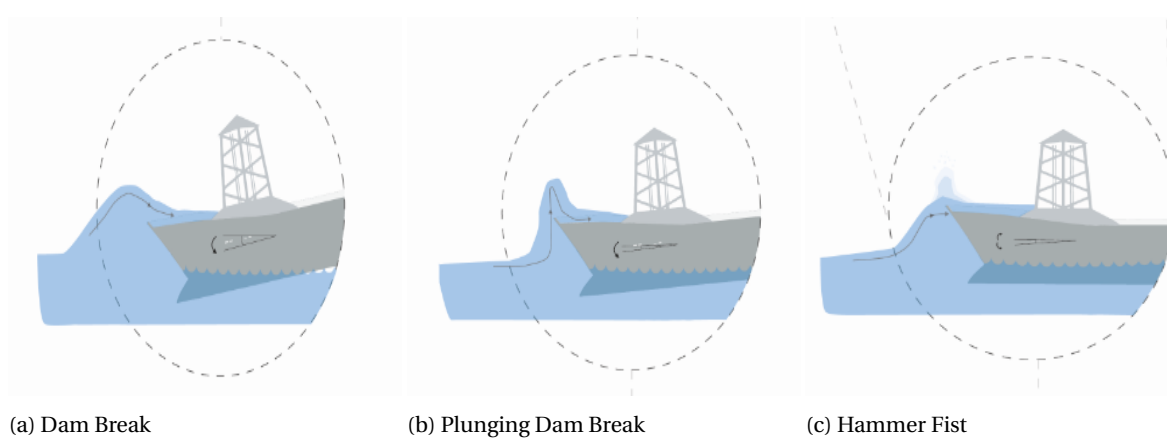


Figure 5.3: Illustration of the three different types of observed green water waves.

After the observation of the video data it was chosen to omit the Plunging Wave (PW) and Spray as separate green water events. The Plunging Wave was not observed as separate event, but could be classified with other events. The Spray event was observed, but not taken into account in this research as the events exerting the lowest impact on deck are deemed least important.

To apply the classifications to observations of green water events on a floating vessel, adjustments have to be done to how these classifications are defined and which classifications are actually observed (which are only observed when a non-ship type model is used). We will now look at the different wave types separately. All green water events observed are shown in Appendix B.

5.2.1. Dam Break

Vessel and incident wave mechanism

When a group of waves approach the vessel, the pitch and heave motions increase. The bow of the vessel starts moving down after its maximum upward position is reached, as can be seen in Figure 5.4a & 5.4b.

Dependent on the phase of the wave with the vessel and vessel motions, the vessel 'dives' into the wave at one point and allows a part of this wave to flow onto the deck (see figures 5.4c & 5.4d).

Due to the smoothness of the wave flowing on deck during this green water occurrence, the amount of spray is limited. The amount of water flowing on deck is large because a large part of the wave can flow on deck (see Figure 5.4e). Because of the vessels upward motion (negative pitch motion), the amount of water on deck is cut off, as the bow exceeds the relative wave at one point (see Figure 5.4f).

A large part of the wave still has to pass the vessel, as can be seen in Figure 5.4f, causing significant motion after the green water event has occurred. As can be seen in Figure 5.4a, green water event under consideration is preceded by another green water event. The wave group can cause a sequence of green water events influencing the vessels motions.

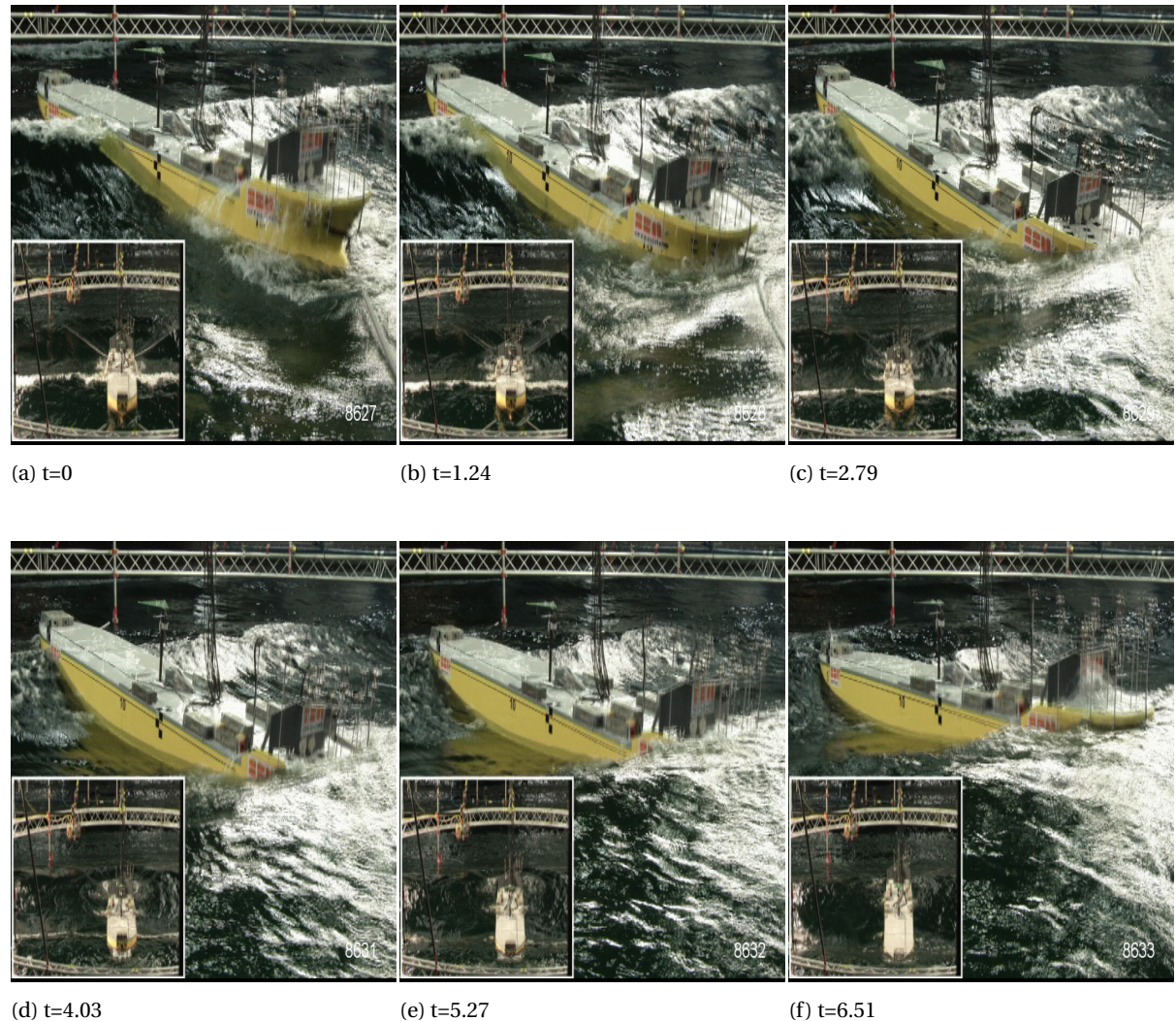
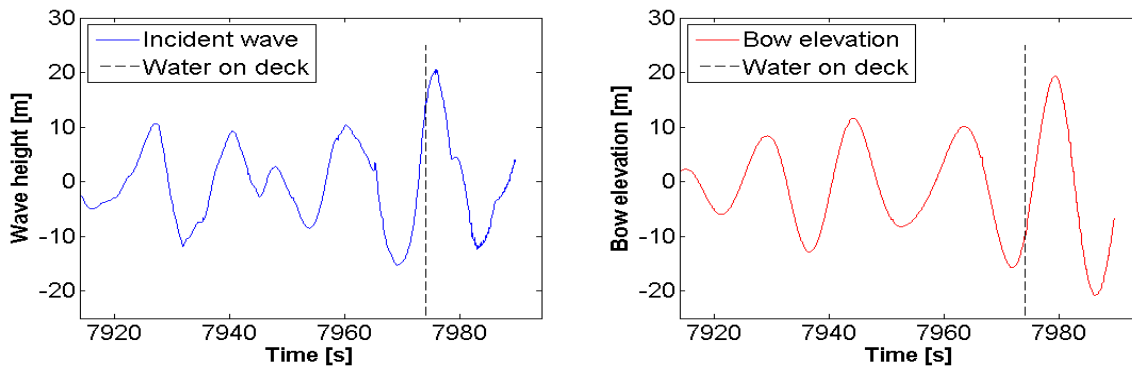


Figure 5.4: After the wave flows on deck. Dam Break event frames from basin fixed probe. The time indications are given in full scale. As the frame-rate of the video is 25/sec, the time between frames is 0.3098 seconds.

In Figure 5.5 the relative wave causing the vessel motions, bow motion and the resulting green water on deck are shown. The DB event is caused by a group of high waves as was observed in the video data (see Figure 5.5a). The vertical intermittent line indicates the moment the wave flows on deck, which is before the wave has reached its maximum height as was observed and shown in Figure 5.4. The resulting vessel motions, indicated as motion of the bow, are shown in Figure 5.5b. As can be seen, these motions are induced a couple waves before the green water event and increase until and after the green water events occurs. Therefore the pitch and heave motions are significantly high during the vent. The pitching motion is typically past the point of initial upward motion (see Figure 5.23a). The vessel dives into the wave, so the wave flows on deck before the highest point is reached, as if a vessel is pushed down when floating in still water. The wave has passed its highest point and is starting to break, so the vessel is moving up as well, as can be seen in Figure 5.23a.



(a) Wave height of waves before a DB event

(b) Bow motion during a Dam Break event

Figure 5.5: Wave and vessel mechanism leading to a DB event

Flow pattern

In Figure 5.6, frames from the video footage during a DB event are shown. It can be seen that the wave swells up in front of the bow (a wall of water as described in the DB theory), and flows onto the deck when the relative wave is high enough, caused by a downward pitching motion (figures 5.6a, 5.6b & 5.6c). Due to the bulwark, a small air pocket is seen between the deck and the wave in Figure 5.6c. The bow diving into the wave causes a high relative wave from all sides of the bow, what causes water to flow on deck from all sides (figure 5.6d). Because of the pitch angle causing the vessel to dive into the wave the amount of water flowing on deck is high.

After the bulwark is breached, the wave flows towards the centre of the bow (figure 5.6e and then slams into the vertical turret protection wall (5.6f). From the time-trace it can deduced that the on deck water velocity is approximately $10.22 \frac{m}{s}$.

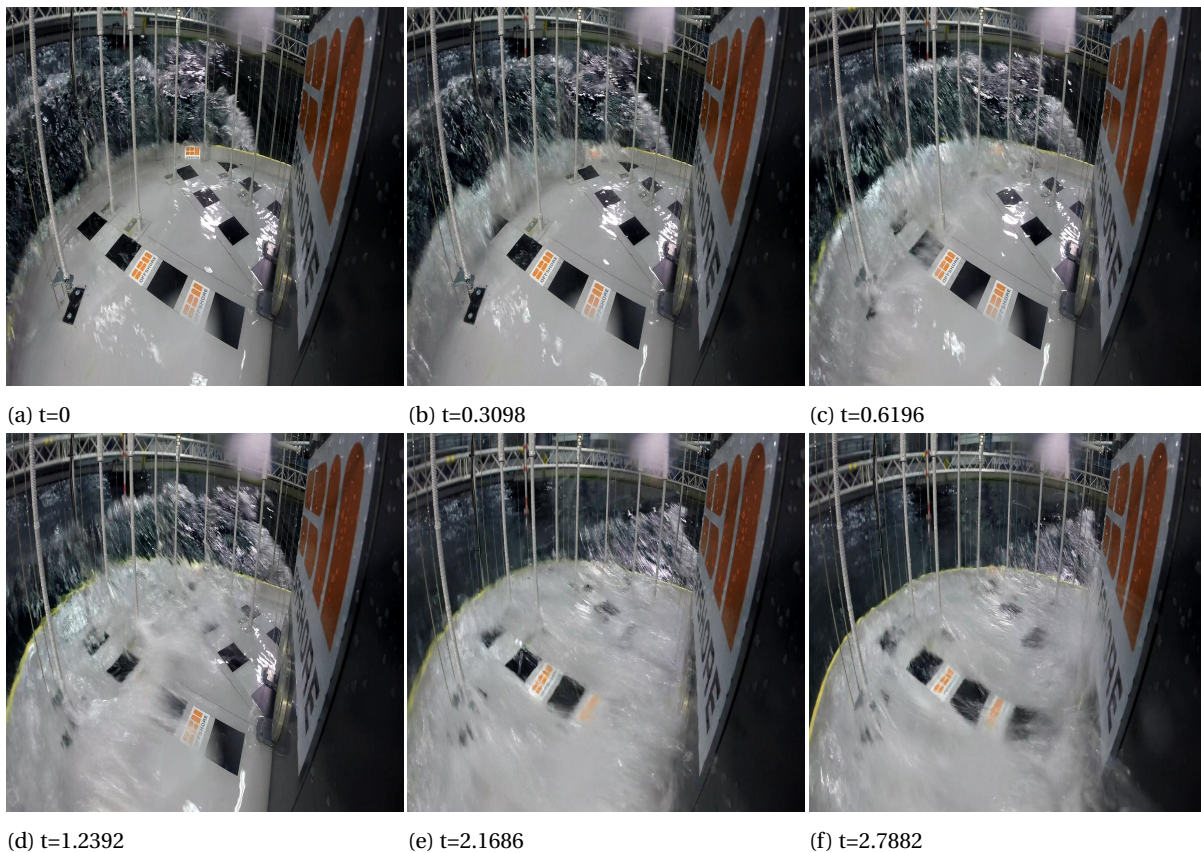


Figure 5.6: Frames from model test; Dam break event flow on deck

In Figure 5.7, grid images are shown of the green water wave as shown above. As was shown in the video frames, the wave flows onto the deck from all sides of the bow (assuming symmetry of the other side off the bow), as can be seen in Figure 5.6c.

After the bulwark is breached, the wave flows towards the centre of the bow (see Figure 5.7d and then slams into the vertical turret protection wall. As can be seen in the figure, the water builds up against the structure. An original 5.8m bulwark exceedance results in an 8.3 and 9.2m measurement at the turret, what gives an indication of the mass of water being shipped on deck.

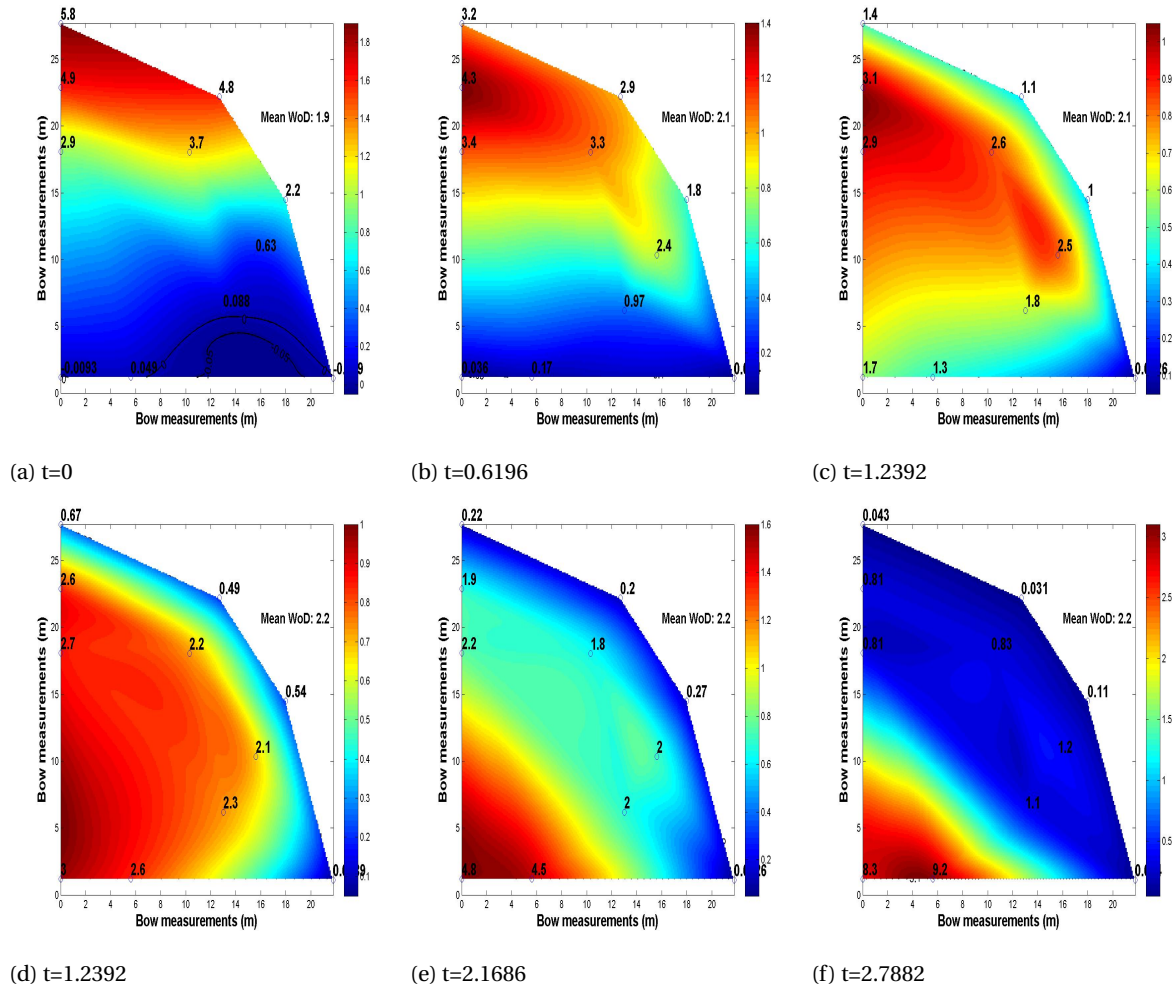


Figure 5.7: Frames from grid calculations; Dam break event flow on deck. The color indicates the water height on deck, ranging from blue to red representing low to high values.

In Figure 5.8 the time-trace of the sensor values (sensors on the center line of the bow) are shown. The vertical axis shows the water height on deck and the horizontal axis shows the moment in time starting from the first freeboard exceedance. The freeboard exceedance is significantly higher than the water height measured on the bulwark, as the water swells up in front of the bow and then flows on deck. The smoothness of the green water event can be seen as the water height gradually declines before impacting on the turret protection.

Because of the downwards angle of the wave flowing on deck, the decline of water height between the bulwark and 4.8 meters on deck is significant. The water from the other sides of the deck joins in the center line of the bow, so the decline of water height 9.6 meters from the bow is less. After this the 'water jet' hits the equipment, and builds up against it, and then flows back towards the bow.

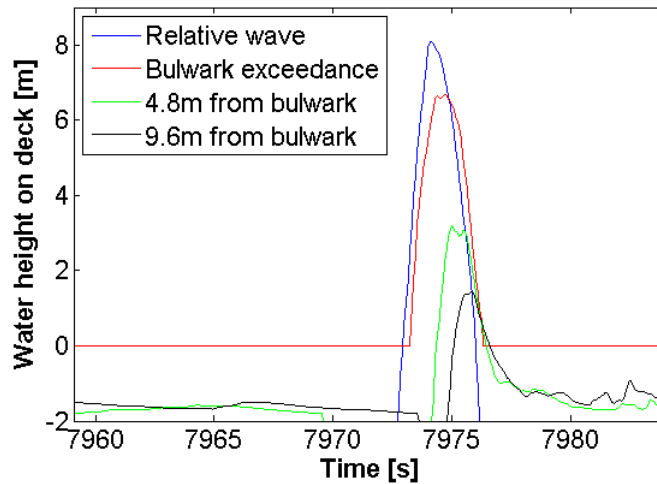


Figure 5.8: Time trace water flowing on deck of the center line sensors in full scale.

The impact on the vertical structure caused by the green water event is shown in Figure 5.9, with the red line as the centre sensor and the blue line as the side sensor measurements (see Section 3.2). As mentioned before, during the Dam break event water flows on deck from all sides of the bow. In the impact graph it can be seen that the side impact sensor shows a load that follows the main centre load sensor (600 kN peak vs 350 kN mean peak), implying that the wave impacts a wide area of the vertical structure.

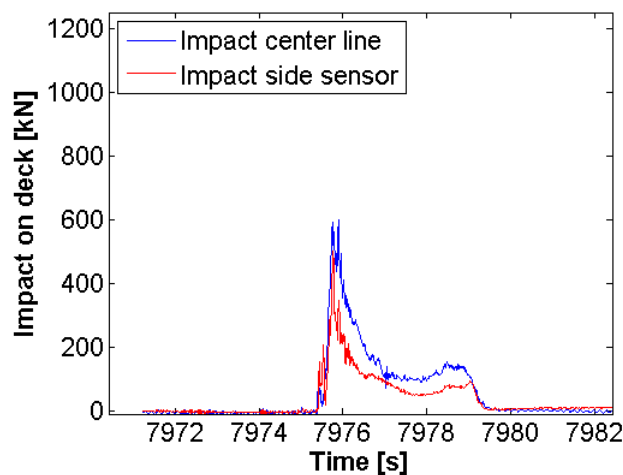


Figure 5.9: Impact of Dam Break event on vertical structure

5.2.2. Plunging Dam Break

Vessel and incident wave mechanism

Similar to a DB event the vessels pitch and heave motions increase due to a wave group. As can be seen in figures 5.10b & 5.10b, the vessel start pitching down into the wave.

Other than during a DB event however, the wave does not swell up in front of the bow, but due to a certain phase difference the wave runs up along the hull of the vessel until it exceeds the freeboard and starts breaking onto the deck (figure 5.10c). The wave and the vessel hit each other when the vessel is pitching down into the wave and the wave is close to its maximum height. This causes a slamming effect and run-up of water due to the downward motion of the vessel and the upward motion of the wave (figure 5.10d). Other than during the DB event, the vessel does not dive into the wave before it reaches its maximum height, and therefore the scooping of water is not observed.

After the wave flows on deck, the pitch motion of the vessel moves up, caused by the wave passing through (figure 5.10f). The wave has passed the bow after the green water event, while during the DB event a significant part of the wave still has to pass the vessel. Because of this, the vessels motions after and during the green water event are less than during the DB event.

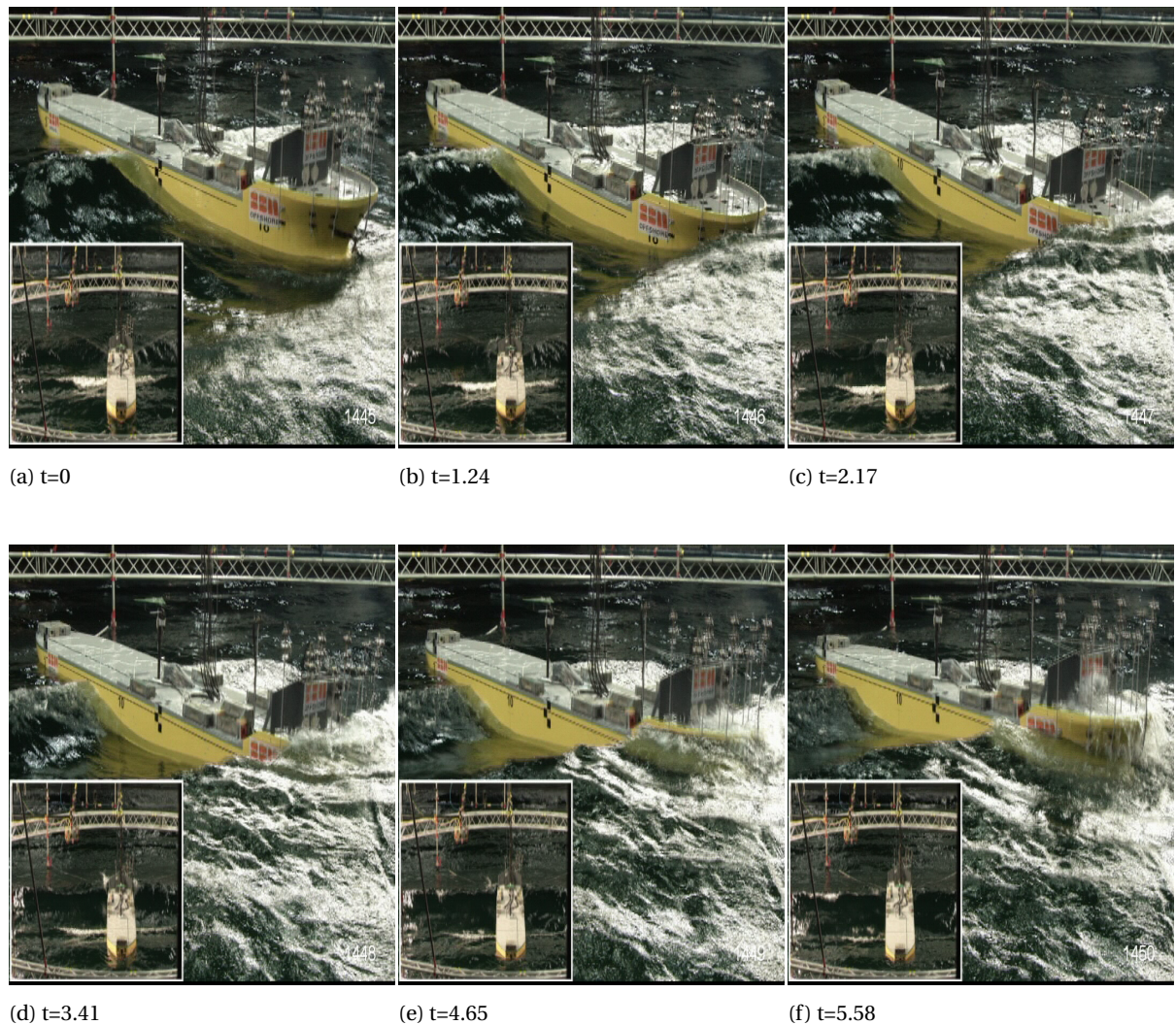


Figure 5.10: Plunging Dam Break event frames from basin fixed probe.

As was observed in the videos, the PDB event is dependent on the phase of the wave and the vessel, but in a different way than the DB dependency. This wave group is shown in Figure 5.11a, although the event is caused mainly by the two last waves. The moment the wave flows on deck is different than during the DB event, as the vessel does not dive into the wave before it has reached its maximum height, but during its maximum. This is indicated in Figure 5.11a by the intermittent line.

The bow is typically at its lowest point when the water flows on deck, as can be seen in Figure 5.11b, other than during the DB event. The bow motions are more stable than during a DB event, during which the bow motion increases constantly, but more heavily during the actual green water event. The values of pitch and heave are, during this PDB event, significantly lower than during this Dam Break event.

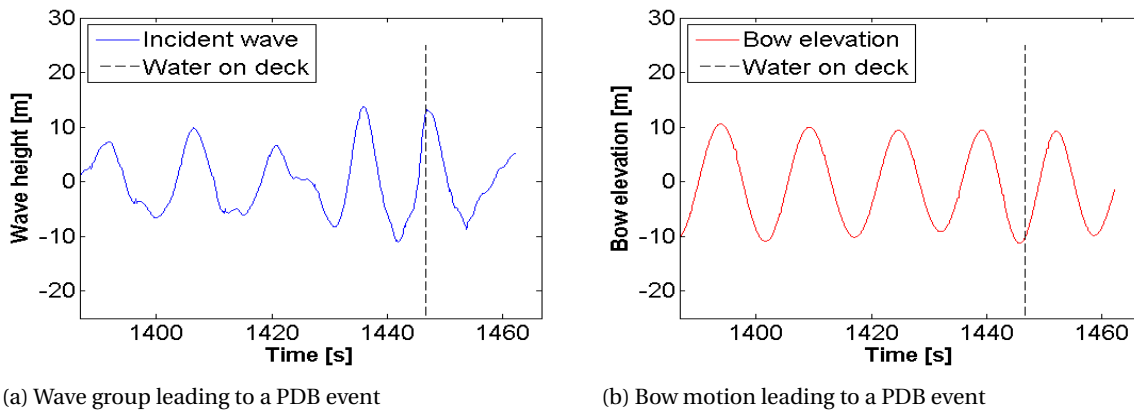


Figure 5.11: Wave and vessel mechanism leading to a PDB event

Flow pattern

As described before, the Plunging Dam Break event occurs when a wave runs up along the bow until a certain height above the bulwark and falls on deck after the maximum is reached. In Figure 5.12a it can be seen that a wall of water shoots up along the bow, and begins falling onto the deck in figures 5.12b & 5.12c. Because of the bow run-up occurring, water flows on deck mainly from the centre of the bow and not from all sides. When the wave hits the deck, a jet of water shoots towards the vertical structure and a small part to the sides of the deck (see Figure 5.12d). Due to the run-up, slamming against the bow and vertical impact on deck, the PDB event invokes significant spray and bubbles within the flow.

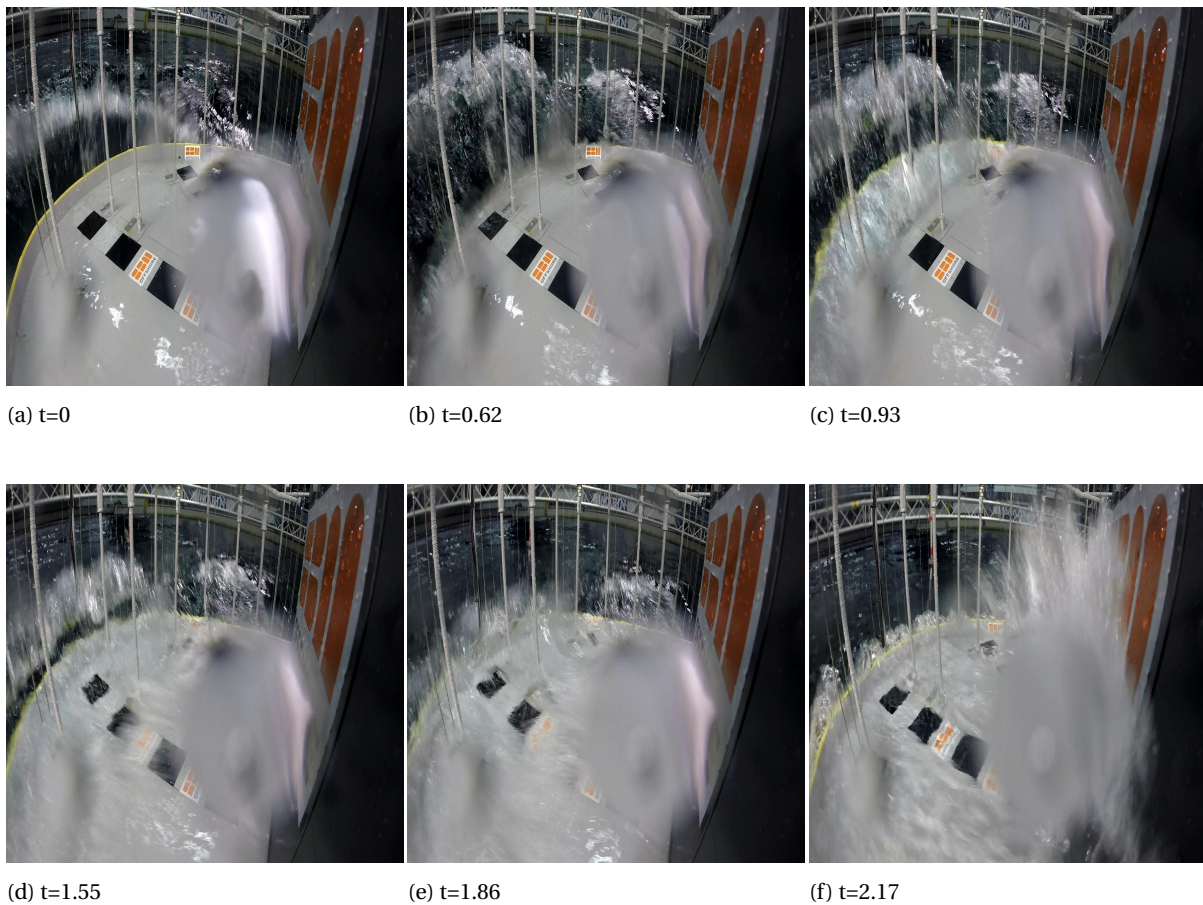


Figure 5.12: Frames from bow fixed camera as a PDB green water event occurs

In figures 5.13a & 5.13b, it can be seen that water does not flow on deck from all sides of the bow. Because of the run-up, the wave at the side of the bow does not flow on deck. After the wave hits the deck, it flows through the middle of the bow as a water jet across the bow, as can be seen in Figure 5.13c & 5.13d by the dark red color through the middle. After the wave hits the structure, the wave builds up against it, as shown in figures 5.13e & 5.13f.

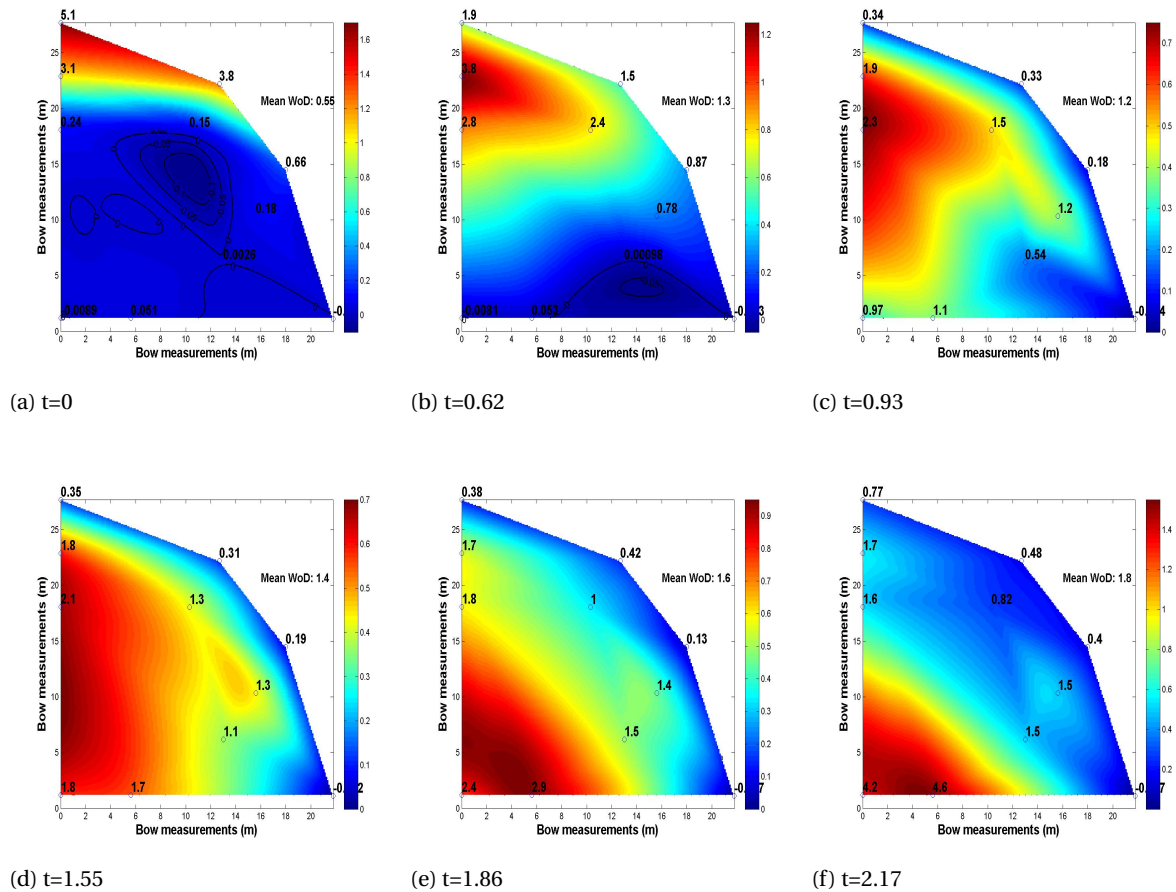


Figure 5.13: Visualisation of a PDB event flowing over the deck

In Figure 5.14 the time-trace of the sensor values are shown. The peak of the relative wave and of the bulwark maximum are close to each other because of the run-up along the bow, and resulting upwards facing wave. Because of this upward facing wave, the wave height 4.8 meters from the bow is still significant. This is different from the DB event where the water height had already declined more than half of the bulwark exceedance.

After the wave hits the deck, a water jet is formed, with a significant lower water height (black line). The water hits the equipment, and builds up against it, after flowing back towards the bow.

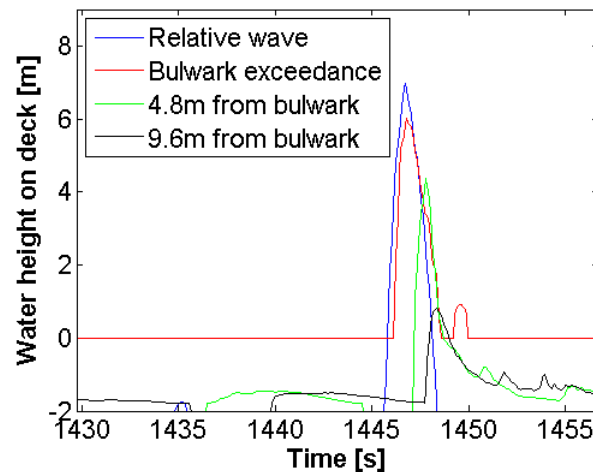


Figure 5.14: Time trace water flowing on deck through the centre-line of the bow

The impact on the vertical structure caused by the green water event is shown in Figure 5.15, with the red line as the centre sensor and the blue line as the side sensor measurements (see Section 3.2). As mentioned before, during the Plunging Dam break event water does not flow on deck from all sides of the bow. The wave flows on deck (mainly) through the center line of the bow. In Figure 5.15 this flow is apparent because the difference in impact height between the side impact sensor and the center line impact sensor (500kN vs 180kN). The two sensors do show the same impact pattern, implying that the wave impacts a wide area of the vertical structure.

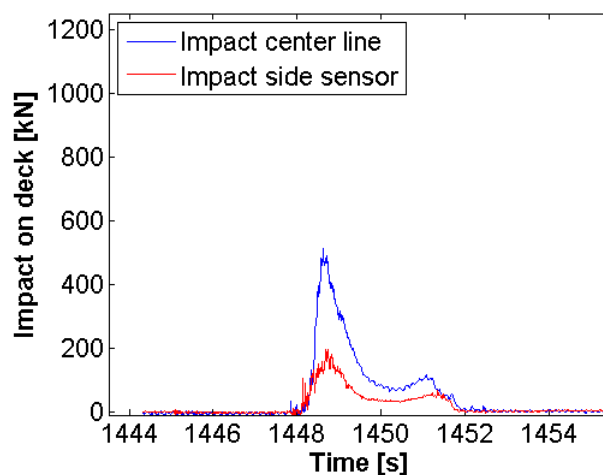


Figure 5.15: Impact of Plunging Dam Break event on vertical structure

5.2.3. Hammer Fist

Vessel and incident wave mechanism

As observed in the video footage, the Hammer Fist event is not caused by several waves inducing severe pitch motions, but by a single wave slamming against the bow and deck. The vessels motions are limited, as can be seen in figures 5.16a, 5.16b & 5.16c.

Due to the lack of vessel motions, the amount of spray during this event is significant as the wave slams against the bow, causing some distortion in the measurements. Also, a part of the wave runs up along the bow, what divides the green water event in multiple impact moments (see figures 5.16d & 5.16e).

Because the vessel is not in an (significant) upward or downward motion, the stream of water is not cut off by the vessels motions. The water height on deck is mainly dependent on the wave itself and a possible small pitch angle and heave motion. As was the case during the PDB event but not during the DB event, the wave has passed the bow when the green water event has occurred (see Figure 5.16f).

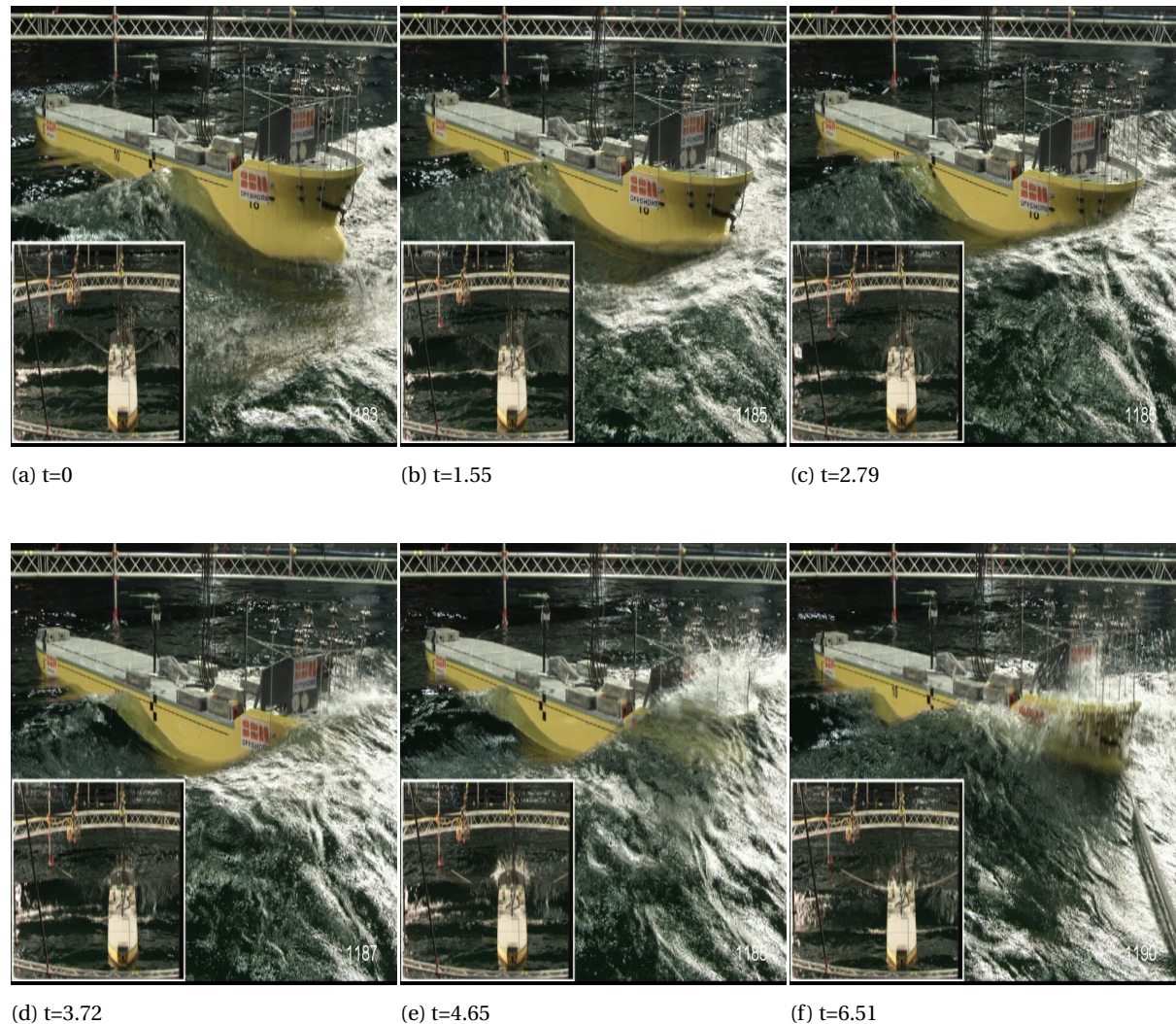


Figure 5.16: Hammer Fist event seen from the basin fixed probes

As can be seen in Figure 5.17a, the incident wave mechanism leading to a Hammer Fist event is significantly different from the other two highlighted events. The waves hitting the vessel before the event are relatively low. When the event occurs, in this case, a slightly larger wave followed by a high wave hit the vessel. The main cause of this green water event is this single 'rogue' wave hitting the vessel, not caused by phase or certain wave and vessel mechanisms.

In Figure 5.17b, the combined pitch and heave motion are shown. As the waves leading to the event are relatively low at the moments before the event, the bow motion is low as well. When the high wave hits the vessel the bow motion is somewhat higher. The main motion happens after the green water events has occurred (indicated by the intermittent line). Especially compared to the DB and PDB events, the bow motions are very low before the green water events occurs.

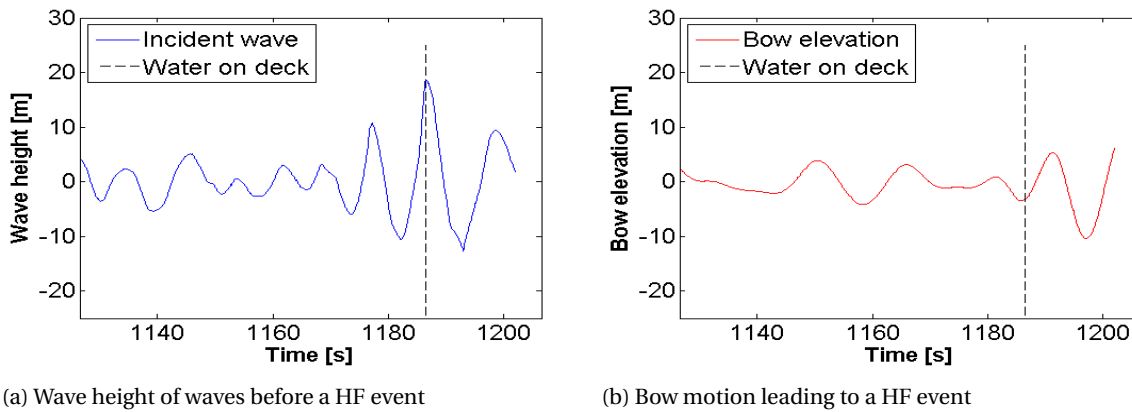


Figure 5.17: Bow motion and wave height during a Hammer Fist event

Flow pattern

As described in the sections above, the Hammer Fist event occurs when a high wave slams against the bow and over the deck. The HF wave consists of two parts, the wave running up along the bow and the wave directly over topping on deck. Because of the slamming against the bow, a lot of spray is generated, what makes it difficult to observe the second part of the wave. In figures 5.18a, 5.18b & 5.18c the wave slamming against and running up along the bow are seen. Because of the upwards motion and negative pitch angle (upwards) during this event, a part of the wave that runs up along the bow falls back into the sea. The part of the wave that hits the deck immediately has an upward or slightly horizontal angle when flowing on deck, causing the impact location to be far from the bow.

When the wave exceeds the bulwark, a jet of water shoots towards the vertical structure as well as a highly aerated wave falling on deck (see figures 5.18d, 5.18e and 5.18f).

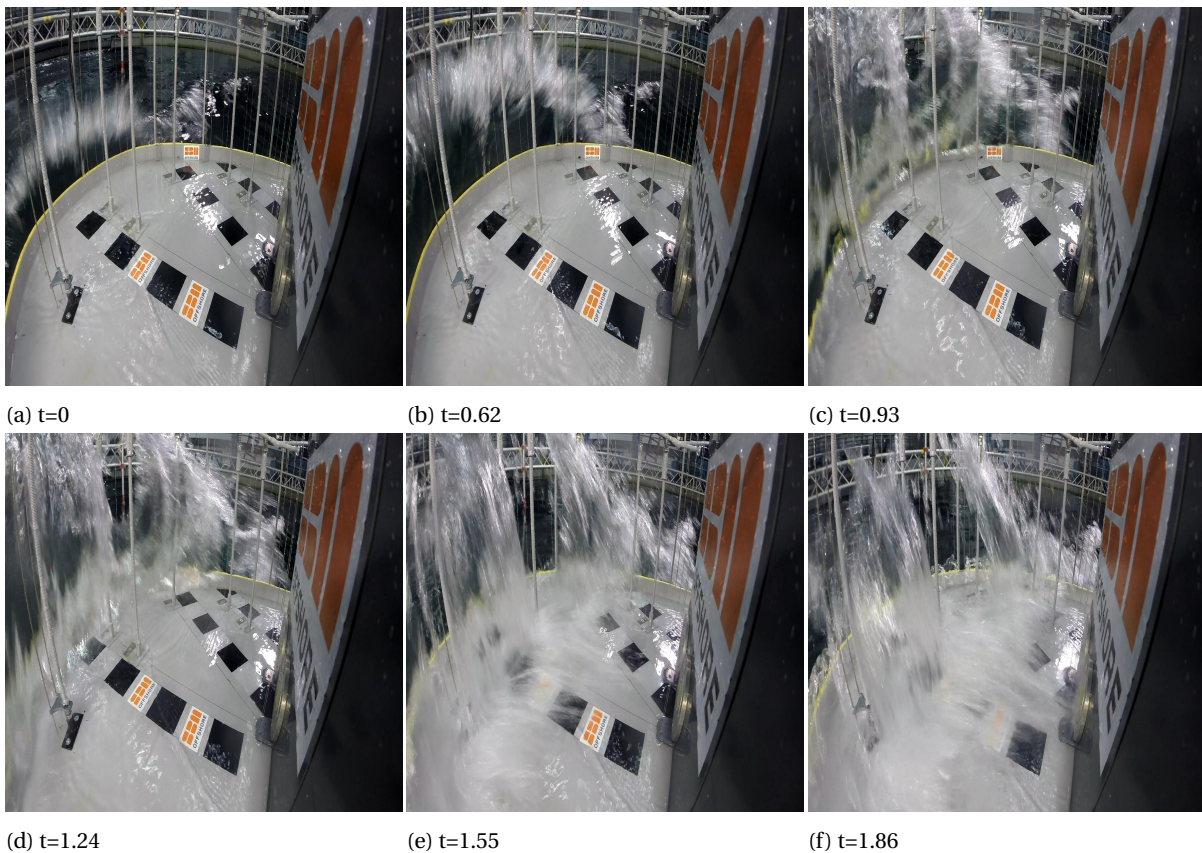


Figure 5.18: Frames from the bow fixed camera during a HF event

The measurements of the flow on deck are visualised using a grid, as mentioned before. The HF event can be seen in figures 5.20. As the wave slams against the vessel, there is not a lot of build-up of water in front of the bow, mainly because of a lack of vessel motions. Because of this, the green water wave behaves like a wave front instead of a flow on deck as was the case during the DB and PDB events. This wave front flow can be seen in figures 5.19a, 5.19b & 5.19c. As opposed to the DB and PDB events, the wave front shows a more or less constant bulwark exceedance from the different sides. Because of a single high wave over topping, with a run-up and direct part, the wave is less dependent of the bow form.

Because of the slamming against the vessel, the wave is scattered and aerated, as was seen in the frames from the video footage. The sensor images are not able to portray aeration of a wave or spray, as can be seen in figures 5.20a, 5.20b & 5.20c. However, when comparing those figures to Figure 5.19c, where a wave front is still observed, the conclusion that the wave is highly aerated can be drawn. After the wave (aerated and flow type part) hits the structure, the water builds up against it, as shown in figures 5.20b & 5.20c.

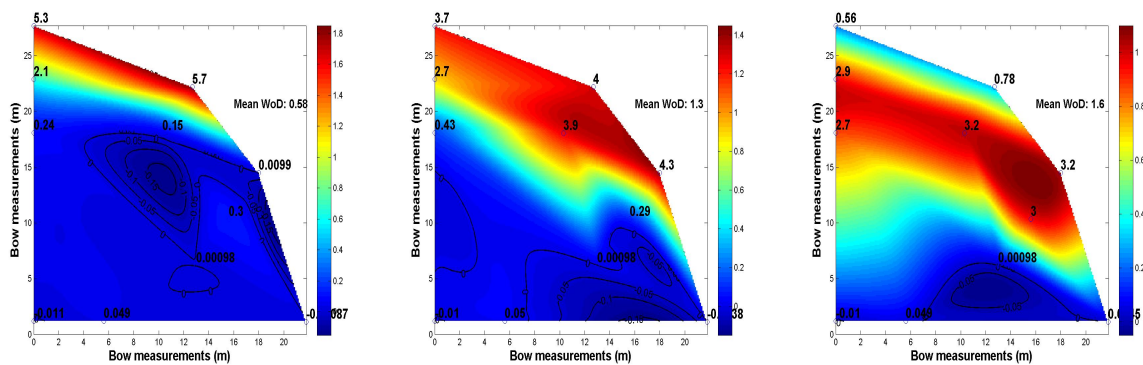
(a) $t=0$ (b) $t=0.31$ (c) $t=0.62$

Figure 5.19

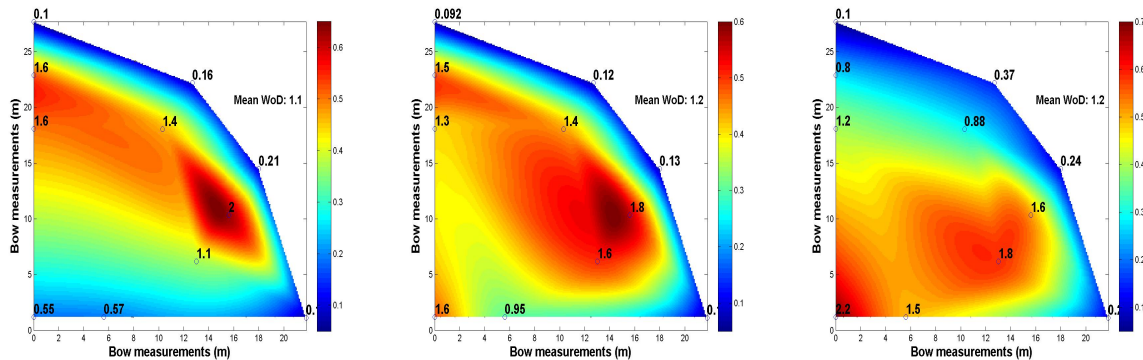
(a) $t=1.24$ (b) $t=1.55$ (c) $t=1.86$

Figure 5.20: Visualisation of a HF event flowing over the deck

In Figure 5.21 the time-trace of the sensor values is shown. As can be seen, the freeboard exceedance is approximately the same height as the bulwark exceedance, indicating either a wave running up along the bow or a high wave exceeding the bulwark and slamming against the vessel. During a HF event the latter occurs. The values measured further from the bow indicate the waves' upward and slight horizontal angle as it 'flows' on deck. Because of the slamming and spray, the HF flow is complex to describe through measurements (time trace or grid interpolation).

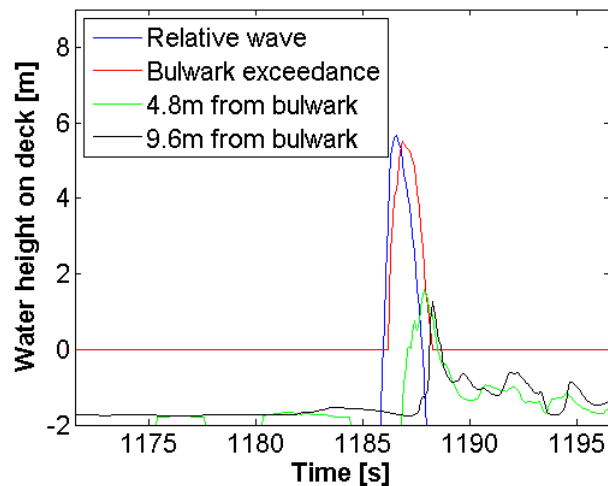


Figure 5.21: Time trace water flowing on deck through the centre-line of the bow

The impact height and pattern of a HF wave can be seen in Figure 5.22. In the grid images a wave front was observed, although a large part was seen to be spray in the video frames. From the impact pattern graph it can be seen that the side sensor is barely hit, at least compared to the center sensor (1000 kN peak vs 160 kN peak). The wave hits the sensor mainly through the centre line of the bow, although a wide wave impact was observed in the measurements. The value of the video footage is apparent when observing the HF event as the wave height sensor measurements show a different pattern.

The impact pattern shows a peak load consistent of two parts following each other rapidly. This shows the velocity and aeration of the wave front, compared to DB and PDB events, which show a flow type impact, as the surface of the DB and PDB impact line was spread over a significant longer period of time.

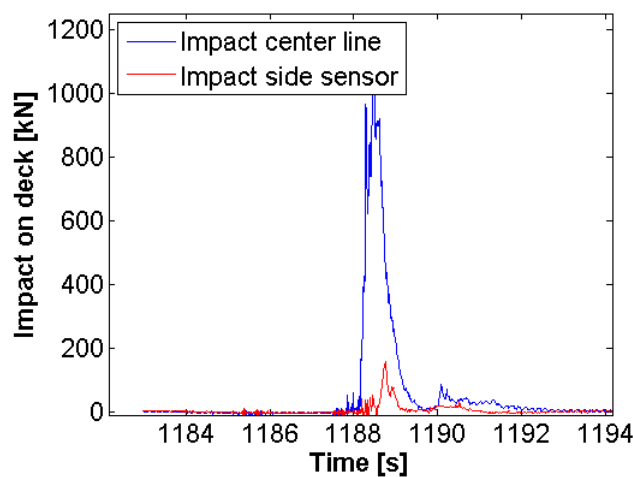


Figure 5.22: Impact of Hammer Fist event on vertical structure

5.2.4. Discussion of classification of events

The three types of green water events as described above are significant different physical occurrences, caused by waves with different characteristics (as is shown in Figure 5.23). The resulting flow pattern and impact on deck are therefore different as well. From the different classifications of the events, a clustering of certain wave and vessel characteristics are expected when comparing all green water events. However, as the different types of events are caused by multiple factors, a clustering of green water events will only be found when considering a combination of parameters. The DB event is dependent on significant bow motions, therefore a group of waves causing these motions are expected. The PDB event will have similar parameters, but the phase angle is different, so the wave groups causing the events will differ as well. The HF event is dependent

on a single high and steep wave hitting the vessel. A steep crest is therefore expected to be the cause of HF events.

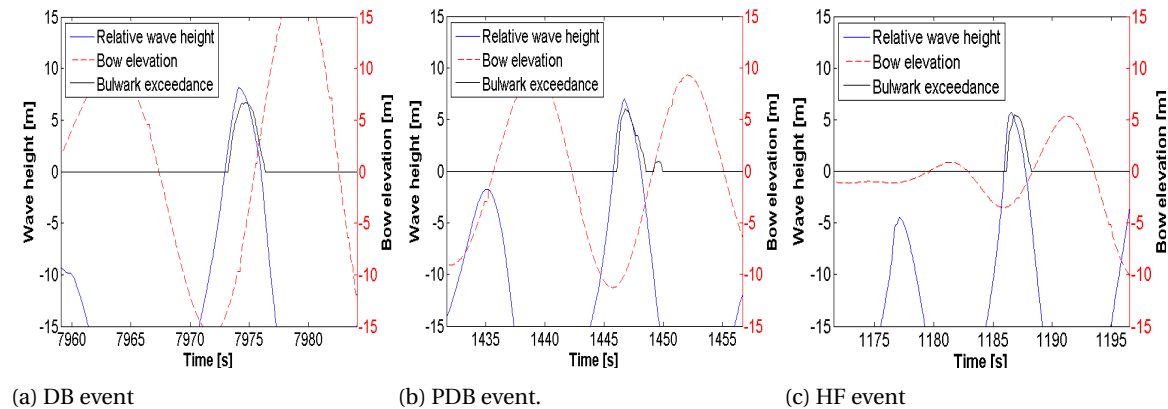


Figure 5.23: Bow motion, relative wave exceeding the deck and resulting bulwark exceedance of all events.

As a significant amount of wave and vessel characteristics determine the pattern and severity of the events, events that show characteristics of multiple classifications are observed. In some cases the distinction between the different events was therefore complex. The main threshold values were the bow motion and the relation between the freeboard and bulwark exceedance.

5.3. Comparison of all green water events

To understand what mechanism of wave and vessel motion determine the type of green water event a selection is made of defining wave characteristics and vessel motions. The analysis of the resulting flow and impact on deck will be shown as well.

An initial observation of the frequency of occurrence of the different events can be done based on Table 5.2. The PDB classification is the most frequently occurring event independent of the sea state. The HF events occur least frequent. The bow motions are more stable than during a DB event, during which the bow motion increases constantly, but more heavily during the actual green water event.

	S1.1	S1.2	S1.3	S2	S3	S3	S4
DB	21.21	39.13	40	36.67	22.22	18.18	35.71
PDB	51.52	52.17	40	43.33	66.67	63.64	50
HF	27.27	8.70	20	20	11.11	18.18	14.29
Total events	33	23	30	30	9	11	42

Table 5.2: Percentages of number of events per sea state

An analysis of the highest events is done, apart from the global event comparison, to discover what parameters cause high impact loads for the different types of events.

5.3.1. General comparison & trend analysis

The wave and vessel parameters chosen to compare are the observed defining parameters, as discussed in Section 5.2.4. The vessel motions and wave (group) parameters are compared first. The second part of the comparison is the wave pattern on deck.

Incident wave and vessel motions

In Figure 5.24a it can be seen that the impact on deck is not clearly dependent on the crest steepness, the average crest steepness of the different events can be distinguished however. The HF is caused by the steepest crests, followed by the PDB and the DB is caused by the least steep waves.

The crest height has a correlation with the impact on deck. The high impact loads of the different events are mostly caused by high crests. The HF events are caused by crests higher than the average of the other crest heights. A HF type event is typically caused by a combination of a steep and high crest. The DB and PDB

events have a much less clear correlation to the steepness as this is not a determining parameter, although the steepness does influence the 'plunging effect' of the wave on deck.

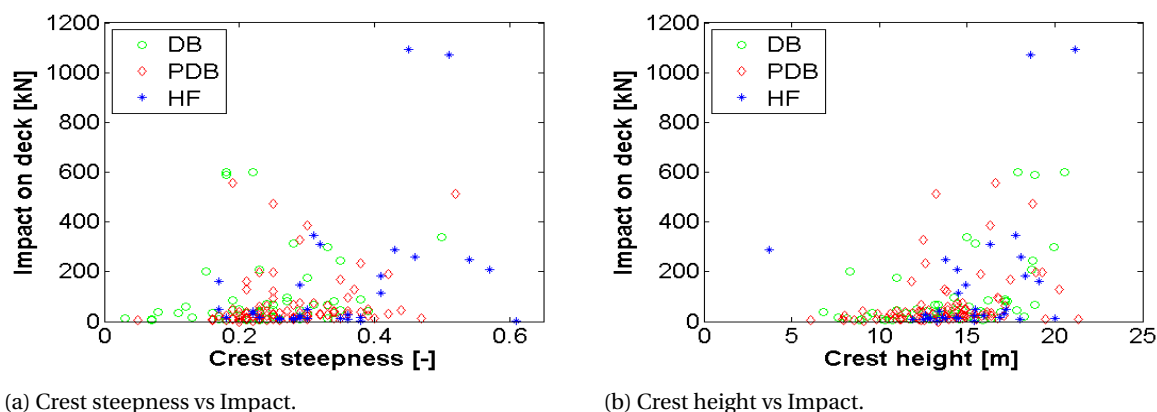


Figure 5.24: Crest steepness vs impact on deck, crest height vs impact on deck.

The DB and PDB events are typically caused by high vessel motions. In Figure 5.25 the bow elevation of the vessel and resulting wave slope (between the relative wave probe and the bulwark probe) of the wave flowing on deck is shown. A clear division between the PDB and DB events can be seen. The DB event has a positive slope angle as a wave builds up in front of the bow and flows on deck when freeboard is exceeded, while during a PDB event the wave runs up along the hull and plunges on deck. The HF does not have a clear slope angle when flowing on deck, this depends on the steepness and height of the crest and the vessels motions. This agrees with the observations done and the descriptions in sections 5.2.1, 5.2.2 & 5.2.3.

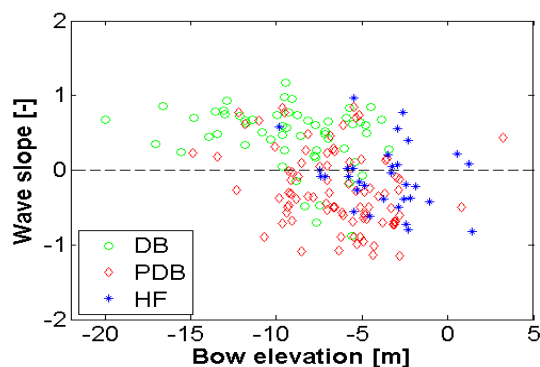
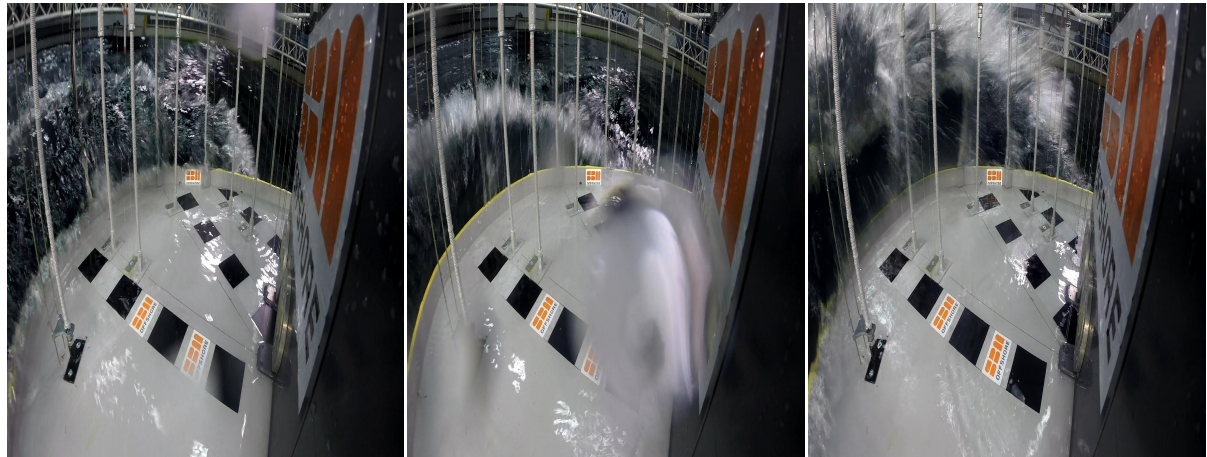


Figure 5.25: Wave slope of the on deck flowing wave and its cause.

Frames from the model test video of the corresponding events are shown in figures 5.26 & 5.27. As is seen in the measurements, the DB and PDB events occur in combination with a significant negative bow motion and a high enough wave with the right phase. It can be seen that the bow of the vessel is facing down during both the DB and PDB event (see figures 5.27a & 5.27b). During the HF event, Figure 5.27c, the vessels motions are limited, resulting in a bow elevation close to its initial horizontal position. Because of this limited motion, the incident wave slams against and over the bow.

The waves that flow on deck, caused by the situation described, are shown in figures 5.26a, 5.26b & 5.26c. The freeboard is exceeded higher than the bulwark, causing a positive wave slope (deck facing). During the PDB event (figure 5.26b) the wave plunges on deck after the maximum height above freeboard is reached. During the HF event, the wave slopes are mostly negative or zero, as a steep wave slams against the bow during this event.

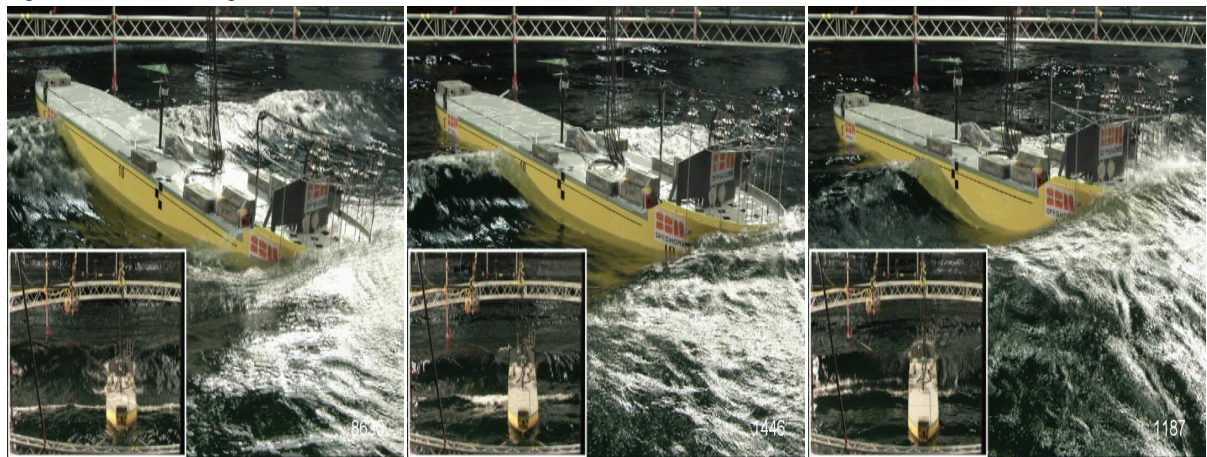


(a) DB bow

(b) PDB bow

(c) HF bow

Figure 5.26: Water flowing on deck viewed from the bow.



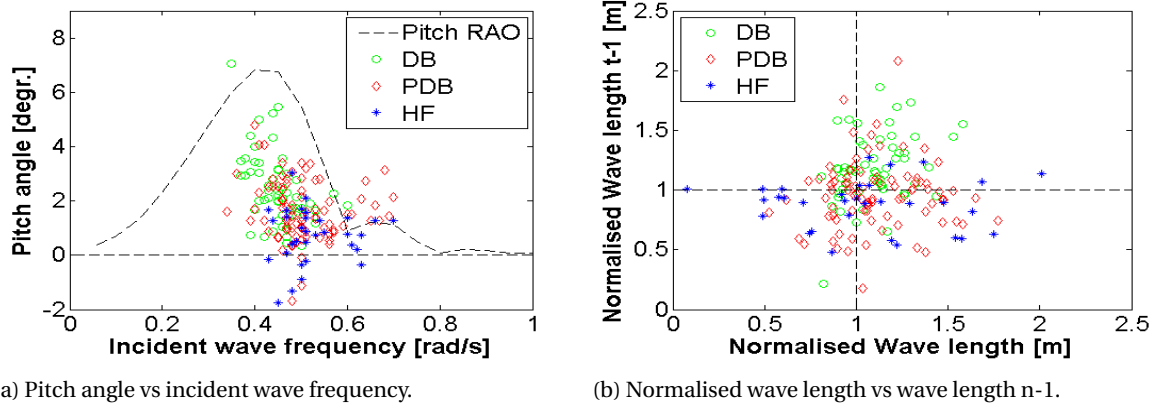
(a) DB full

(b) PDB full

(c) HF full

Figure 5.27: Frames from model test videos during (just before flow on deck) a green water event, full view.

The wave mechanism and vessel motion causing the DB, PDB and HF, differ significantly. As can be seen in Figure 5.28a, the DB events are all caused by waves with a frequency that lies within the vessels RAO, increasing the pitch angle when the RAO maximum value is approached. As the DB event is dependent on the bow elevation, it can be concluded that the incident wave frequency is of significant influence. The PDB events show a similar, but less significant dependency on the incident wave frequency. The PDB event is not as dependent on the incident wave frequency as this event occurs when the vessel is not in phase with the waves. As expected, the HF event is not influenced by the incident wave frequency. The wave length and the wave length of the wave before the green water wave as shown in Figure 5.28b, indicate the mechanism leading to the green water event. It can be seen that the wave during a DB event and before a DB event are (mostly) longer than or close to the vessels length. During a PDB event the wave length differs, as an anti-phase with the waves is established. During the HF events a clear wave mechanism is not clear and most events are caused by waves shorter than or close to the vessels length. This confirms the observations that a HF event is caused by a single wave, not significantly influenced by the vessels motions and the DB and PDB events are dependent on a certain phase and wave group.



(a) Pitch angle vs incident wave frequency.

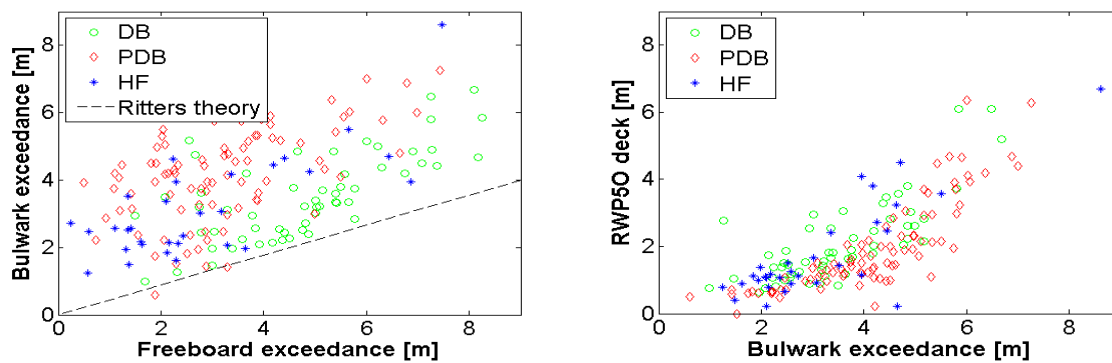
(b) Normalised wave length vs wave length n-1.

Figure 5.28: Influence of wave length and vessel mechanisms leading to different GW events. The wave length, normalised with the vessels length, during the green water event and the wave before that are shown. The events are divided by the intermittent line, representing the vessels length.

Green water pattern on deck

As seen in Figure 5.29a, the values classified as a DB event typically have high freeboard exceedance and a significant lower bulwark exceedance, as was observed in the model test videos. The values of a PDB typically measure equal freeboard and bulwark or lower freeboard heights than the bulwark. This illustrates the steepness of the PDB wave caused by the run-up of the PDB event. The HF event is not characterised by these values, and measures higher freeboard or lower freeboard depending on the height of the wave and amount of spray or run-up caused by the wave slamming against the hull of the vessel.

After the wave flows on deck, the probe 4.8m on deck is reached, this is shown in Figure 5.29b. The bulwark exceedance is plotted against the water height measured at the probe 4.8m on deck. As can be seen, the PDB values in Figure 5.29a exceed the Dam Break values, whereas between the bulwark and probe 4.8m from the deck this relation shifts (as can be seen in Figure 5.29b). The PDB values are now lower than the DB values, indicating a steepness in the PDB wave slope and the amount of water flowing from the sides of the bow. This confirms the observation that a PDB event runs up along the hull, reaching a high freeboard and bulwark exceedance, and then plunges on deck. The HF events did not shift significantly indicating its slamming against the bow as it 'shoots' over the deck after the bulwark is exceeded.

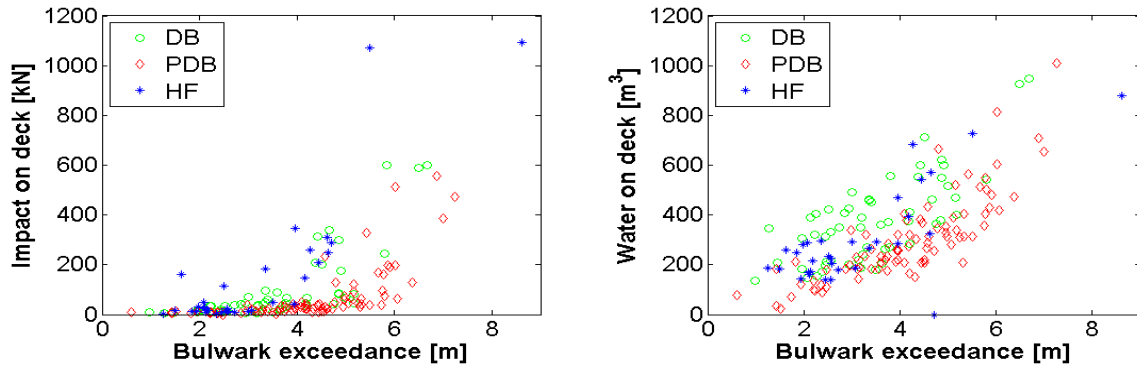


(a) Freeboard vs BWK exceedance.

(b) BWK exceedance vs water height on deck at RWP50deck

Figure 5.29: Freeboard exceedance vs the resulting exceedance at the bulwark, bulwark exceedance and the resulting water height on deck measured at the RWP5odeck probe 4.8m from the bow (center-line probes).

As can be seen in Figure 5.30a, the impact on the equipment is correlated with the exceedance of the bulwark, because this indicates the amount of water that flows on deck (as shown in Figure 5.30b). The amount of water flowing on deck during a DB event is less aerated than that of a PDB and the water flows on deck from all sides of the bow. This (partly) shows why during a DB event the impact on deck is higher, given the same exceedance of the bulwark, than the PDB event. The HF event, shows less average water on deck during an event, but a higher impact on deck given the same bulwark exceedance.

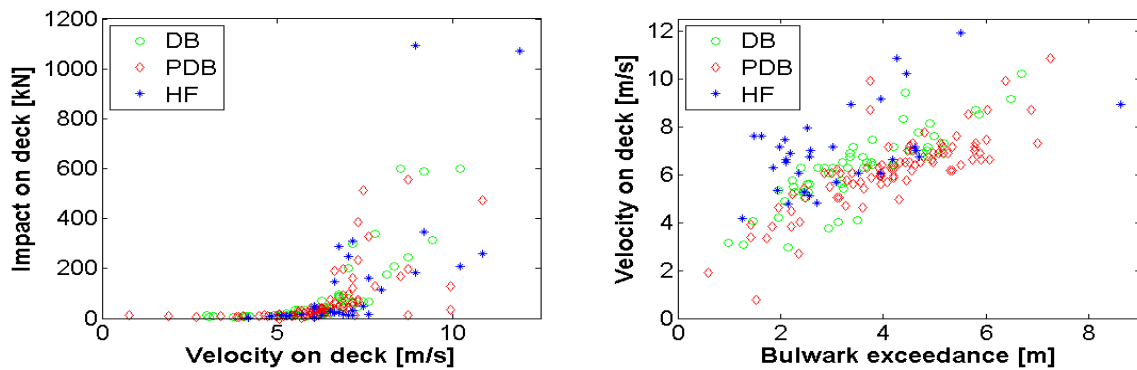


(a) BWK exceedance vs Force on equipment

(b) BWK exceedance vs max. WoD.

Figure 5.30: Influence of the amount of water on deck and the exceedance of the bulwark leading to this amount.

Together with the amount of water on deck, the velocity on deck determines the impact on deck for a large part. In Figure 5.31a velocity and impact on deck are shown. No real clustering (distinction between events) can be found in this figure. In Figure 5.31b it can be seen that the HF events show high values of velocity on deck, although not all significantly higher than the other two classifications. A clear trend can be seen between the bulwark exceedance and the velocity on deck, especially regarding the DB and PDB events. So two different phenomena can be observed in this figure, the DB and PDB events and the HF event, in which the DB and PDB events show a correlation with the water height and the HF is more scattered.



(a) Velocity on deck vs the impact force.

(b) Bulwark exceedance vs velocity on deck.

Figure 5.31: Influence of the on deck velocity on impact on deck and the bulwark exceedance on the velocity on deck.

5.3.2. High impact event comparison

To understand the parameters causing high loads on deck, two events are chosen per classification, the highest impact load and an event with a significant lower (but still high) impact on deck. The events chosen are listed in Table 5.3.

Event	Type	Sea state
1 & 2	DB	S4 & S4
3 & 4	PDB	S4 & S1
5 & 6	HF	S2 & S1

Table 5.3: Sea state and highlighted event description of the highest and slightly less high event of each classification.

Incident wave and vessel motions

As can be seen in Figure 5.32a, the difference in impact load between the events chosen is significant. Event 1 & 2, DB events, differ +/- 300kN, caused by a crest height height difference of +6m. As during event 1 a significant higher impact is measured, this is a logical result. During events 3 & 4, an impact load of 550kN

and 310kN are exerted, caused by a 17m a 19m crest height. As can be seen in the figure, the impact load is not directly determined from the crest height when regarding PDB events. When comparing the HF events 5 & 6, the discrepancy in impact loads is extremely high. Event 5 exerts a load of +- 1100kN, whereas event 6 exerts a load of +- 350kN. The crest heights during event 5 (in Figure 5.32b) is significantly higher than during event 6 (16.3m vs. 18.6m), partly explaining the impact difference.

Another cause for high impact on deck is the crest steepness of the wave (see Figure 5.32b), depending on the type of event. During event 2, a significant steeper hits the vessel than during event 1. Event 3 & 4 are caused by waves with a similar crest steepness. Neither the DB and PDB events seem to be significantly dependent on the crest steepness when determining the impact on deck as they are more dependent on the wave/vessel mechanism. The wave crest during event 5 is significantly steeper than the wave causing event 6, partly explaining the significant higher impact on deck, as the difference in crest height is not that high.

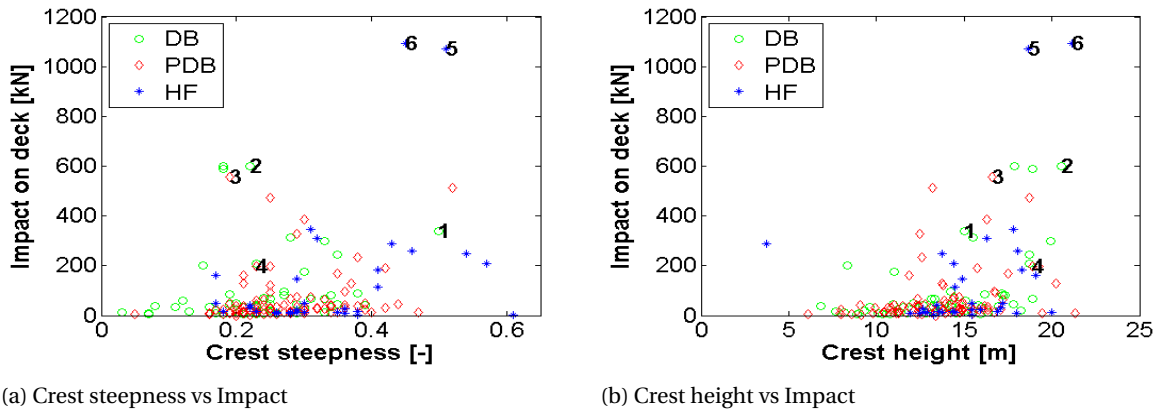


Figure 5.32: Crest height and steepness and the resulting impact on deck. A high and somewhat lower impact on deck comparison.

In Figure 5.33a it can be seen that the bow elevation during event 1 & 2 is similar, while the bulwark exceedance is significantly higher during event 1, caused by the higher wave crest during this event. The bow elevation during event 3 is 6m lower than during event 4, while the crest height during event 4 is significantly higher. The bow elevation during event 5 & 6 is similar, while the bulwark exceedance during event 5 is higher. This explained by the higher and steeper crest during event 6.

The waves causing the vessel motions and resulting water on deck during event 1 are significantly longer than during event 2 (see Figure 5.33b). Both events are caused by waves longer than the vessels length, causing significant vessel motions. As can be seen, during event 3 the waves are longer than the vessel, while the waves during event 4 are shorter, causing the difference in bow elevation. During event 5 both waves are shorter than the vessel while during event 6 the wave before the green water wave is longer than the vessel.

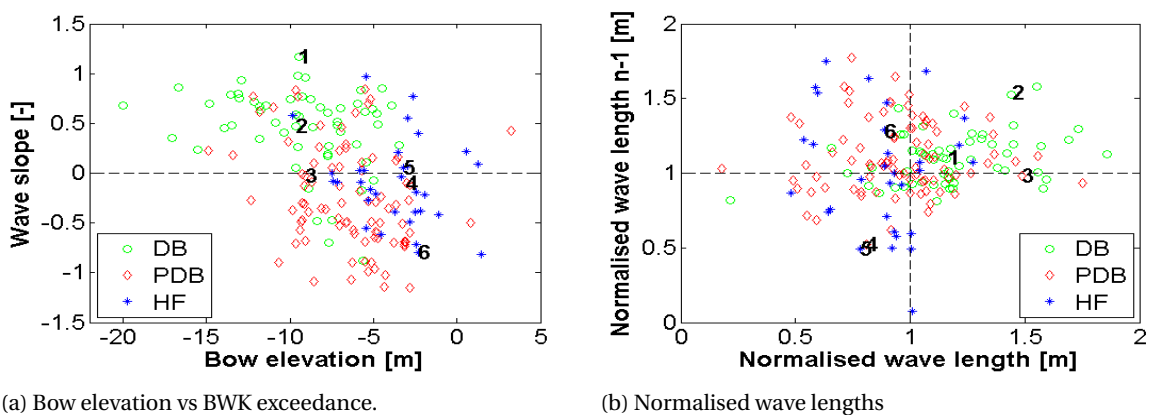


Figure 5.33: Bow elevation and wave slope of the GW wave flowing on deck. Wave length of the GW wave and the wave before the event wave.

Green water pattern on deck

The amount of water flowing on deck has a significant influence on the impact on deck. Comparing events 1 & 2, it is clear that the amount of water on deck is one of the main reasons of the significant higher impact on deck (900 m^3 vs 500 m^3 , see Figure 5.34a). During event 3 a higher amount of water flows on deck as well, explaining why the impact on deck during event 3 is higher than during event 4 (650 m^3 vs 400 m^3). When comparing event 5 & 6, the difference in amount of water on deck is $\pm 300 \text{ m}^3$, what is not a high enough difference to account for the enormous difference in impact on deck ($\pm 800 \text{ kN}$), and this will be sought in the velocity on deck.

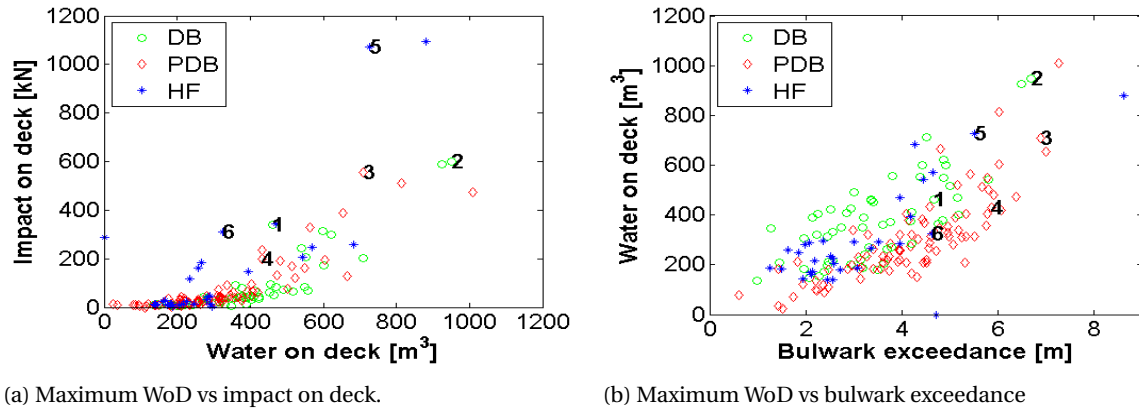


Figure 5.34: Bulwark exceedance and maximum water on deck during an event and the resulting impact on deck.

In Figure 5.35a it can be seen that the velocity on deck during is higher during event 1 than during event 2 ($11 \frac{\text{m}}{\text{s}}$ vs $8 \frac{\text{m}}{\text{s}}$), which, together with the amount of water on deck, causes the higher impact on deck. The same is true when comparing event 3 & 4 ($7 \frac{\text{m}}{\text{s}}$ vs $9 \frac{\text{m}}{\text{s}}$). The velocity on deck during event 5 is a lot higher than during event 6 ($13 \frac{\text{m}}{\text{s}}$ vs $6.5 \frac{\text{m}}{\text{s}}$), explaining the difference in impact on deck whereas the amount of water on deck did not. In Figure 5.35b it can be seen that the average velocity on deck during the HF events is, in most cases, significantly higher than during the other events.

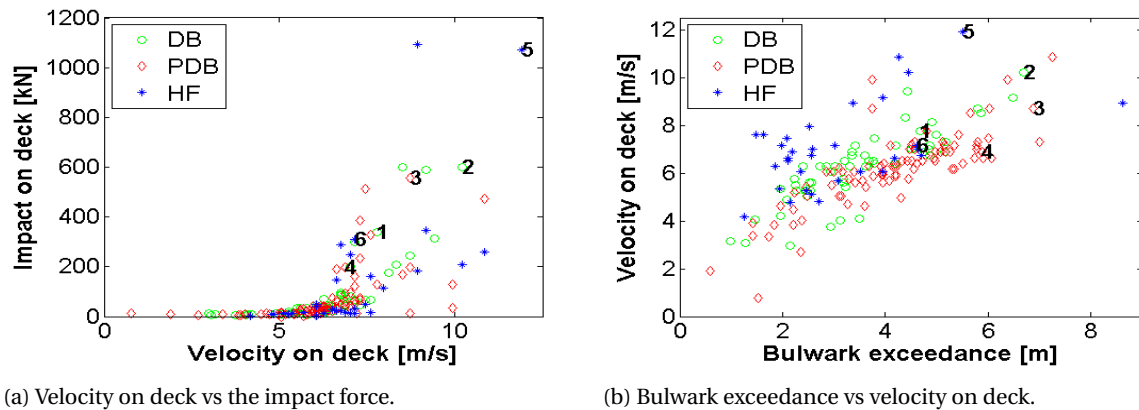


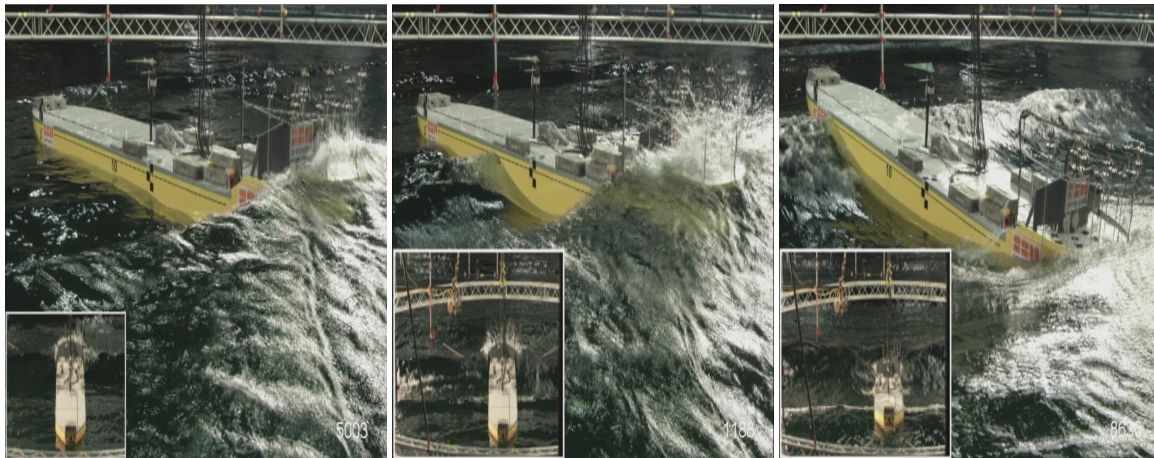
Figure 5.35: Influence of the on deck velocity on impact on deck and the bulwark exceedance on the velocity on deck.

5.3.3. Extreme events

Three events are of particular interest as two of them cause impact loads on deck that are almost twice as high (1100 vs 600) as the third highest event and the third event causes an extreme amount of water on deck (1400 m^3). Both events causing the extreme impact loads were observed to be Hammer Fist events and the third event was a DB event, as can be seen in Figure 5.37a.

In Figure 5.36a & 5.36b the moment the wave flows on deck during the two highest impact causing events is shown. During the second event, the amount of spray is significantly higher than during the first, causing the

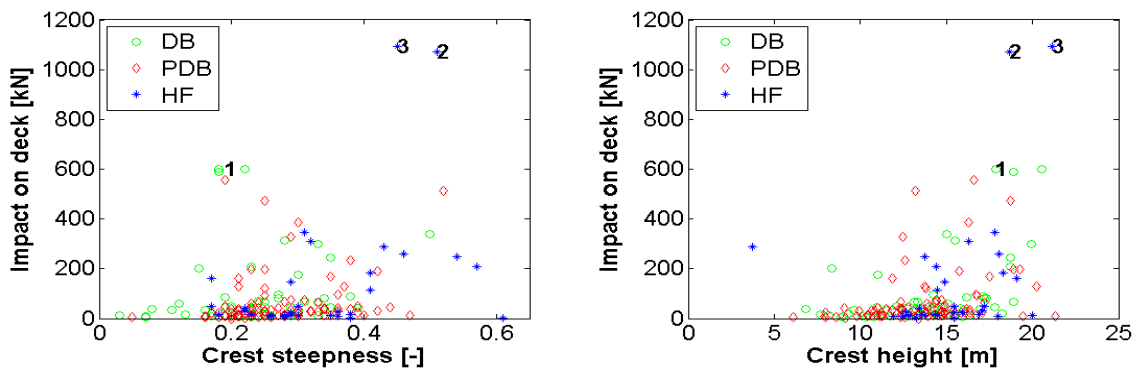
unexpected measurement as seen in Figure 5.24a & 5.24b. Because of the lack of downward vessel motion the wave slams against the bow before and during the flow on deck.



(a) Frame during impact event 1. (b) Frame during impact event 2. (c) Frame during impact event 3.

Figure 5.36: Frames during impact of three extreme events.

As was expected, the HF events (2 & 3) are both caused by extremely steep and high waves, described as a typical HF characterisation. Event 1 is caused by a high wave as well, but a lot less steep, what is expected from a DB event (as can be seen in Figure 5.37a & 5.37b). Another DB green water event has very similar characteristics as event 1. This is the event preceding event 1 caused by the same wave group.



(a) Crest steepness vs impact on deck.

(b) Crest height vs Impact on deck.

Figure 5.37: Crest steepness vs impact on deck. Crest height vs impact on deck.

In figures 5.38a & 5.38b the mechanism leading to the different green water events are shown. As can be seen, during event 1 the waves are longer than the vessel, causing high vessel motions resulting in the bow being 14 meters lower than its initial position. During event 2 & 3, the wave length of the mechanism causing wave is significantly shorter than the vessels length, so that the vessel is not excited significantly. The wave causing the actual water on deck is longer and comes close and matches the vessels length, causing a slight pitch and heave motion.

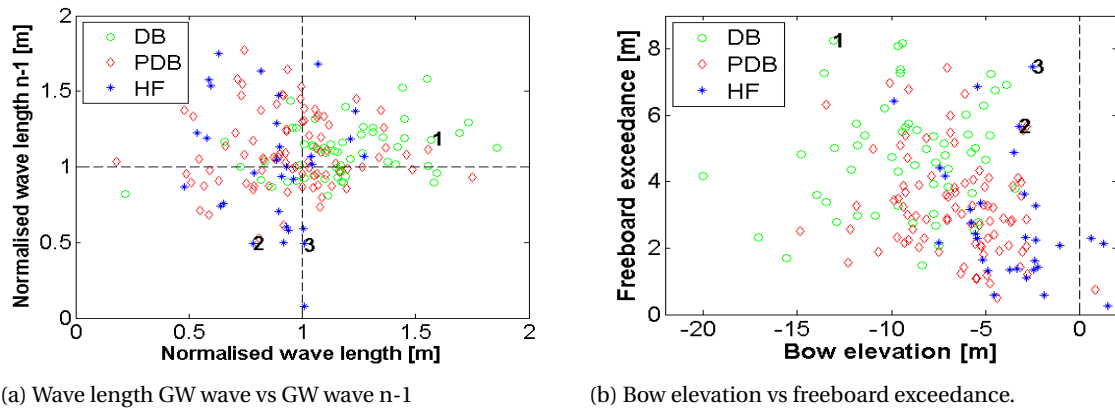


Figure 5.38: Wave length of the green water wave and wave length of mechanism instigating wave (wave before GW wave) vs impact on deck.

In Figure 5.39a it can be seen that the extreme events under consideration are caused by a high velocity and high amount of water on deck. As during event 1 the amount of water on deck is a lot higher than during the other events (while the velocity is high as well), a high impact on deck is to be expected. In the model test video, the reason of the extreme amount of water on deck during event 1 is seen to be caused by a similar event occurring short before event 1. Because of the lack of a way the water can flow off the deck and the short time between the events, the wave flows on deck on top of the remaining water. Therefore, only a part of the measured water on deck has momentum. This explains why during event 2 & 3 the combination of the amount of water on deck with the velocity on deck is not significantly higher than the other green water events.

Event 1, when comparing freeboard exceedance and velocity on deck, shows the same pattern as the other DB events. Event 2 & 3 are more scattered, making these events more complex to predict and understand.

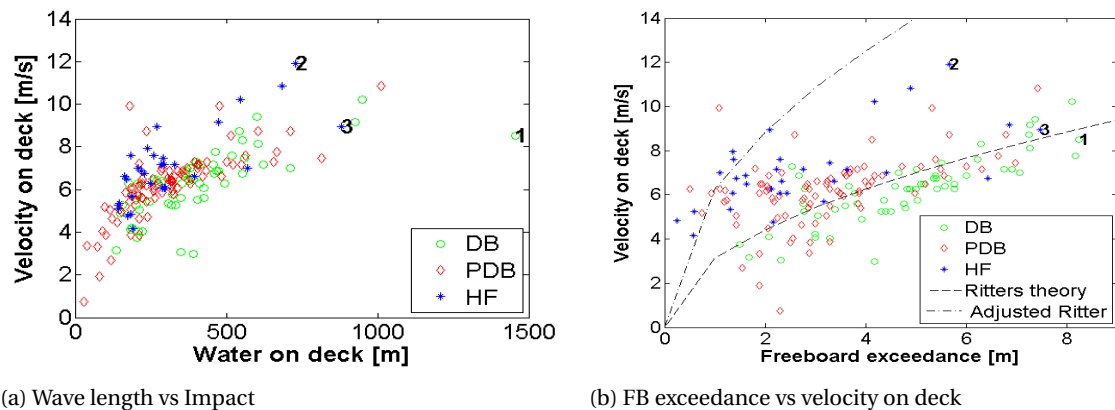


Figure 5.39: Water on deck vs velocity on deck. Freeboard exceedance vs velocity on deck with Ritter and an adjusted Ritter line.

5.3.4. Discussion of comparison of all green water events

Incident wave influence: event determination

A clear correlation between the incident wave parameters and the type of green water wave flowing on deck is not found, although some parameters show proof of having influence on the vessel motions and subsequent green water wave.

The DB and PDB events are not dependent on the crest steepness as they are caused by longer waves. The crest height of the wave is a defining parameter, logically, but the vessels motions and the phase angle determine the exceedance of the freeboard and the eventual water flowing on deck.

The HF event is dependent on the combination of a high and steep crest. The HF event is caused by a single "rogue" wave, unlike the wave group dependency of the DB and PDB events. It can be concluded that the causes of the highest events are strongly related to what type of wave is flowing on deck. From the wave parameter analysis it is clear that the difference in impact on deck for the different classifications are dependent on different characteristics.

Incident wave influence: impact determination

The impact on deck during DB events is mainly determined by the amount of water on deck. The height of the impact load caused by a DB event is therefore dependent on the exceedance of the freeboard. The combination of the pitch angle (caused by a group of long waves) and crest height are defining parameters when predicting the impact on deck caused by a DB event. During the PDB event, the parameters causing high impact are similar to the DB events. The crest height is less determining as the freeboard exceedance is determined by run-up along the bow. HF events are strongly dependent on the combination of the crest height and steepness, this determines the amount of water that flows on deck. As these events occur least often, no clear pattern on deck is found.

5.4. Comparison to the existing theory

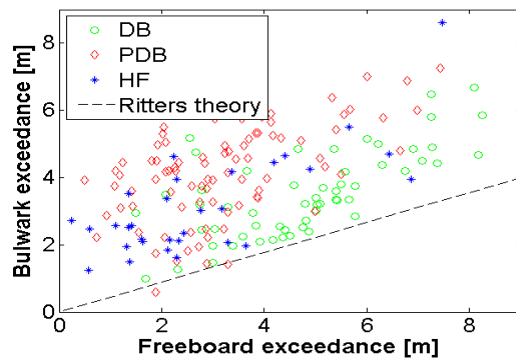
5.4.1. Classical Dam Break theory

To be able to compare the different events to Ritter's dam break theory, the different assumptions on which this theory is based are evaluated. The Dam Break assumptions that influence the initial water height and velocity on deck are evaluated. The different distinguished events deviate from the assumptions in different ways.

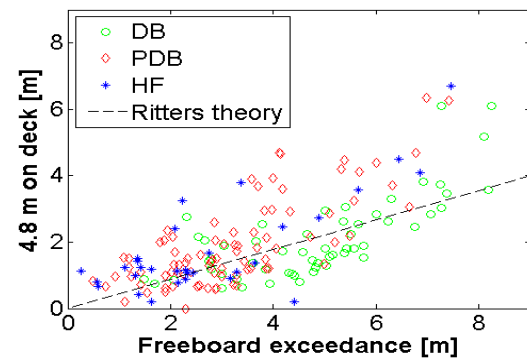
- a **The water behind a dam is calm, a solid mass of water.** Both the PDB and HF events are waves that are highly aerated because of run-up and breaking effects, and therefore do not resemble still water behind a dam. During the DB event the vessel dives into the wave causing high freeboard exceedance without run-up. The wave exceeding the freeboard during this event is therefore comparable to water behind a dam.
- b **The wave following from a breaking dam has zero initial momentum.** All green water events observed and measured have momentum when they flow on deck. Due to the velocity of the wave and the motion of the vessel, the wave will always have momentum when it flows on deck. The DB event shows the least initial momentum as the wave is scooped up by a pitching motion of the vessel. Especially the HF event has significant momentum when flowing on deck.
- c **The direction of the initial velocity of a dam breaking is down-wards (towards the bow).** This assumption is true when considering the DB events, the freeboard exceedance is significantly higher than the water height on deck. The PDB and HF events, however, have an initial upward direction when flowing on deck. The HF event initial direction is less predictable than just stated as it is dependent on the motion of the vessel, but in most cases an initial upward facing flow is observed.

As can be seen in Figure 5.40a the DB classified events are the events that relate to the initial Dam Break theory most, as was expected. Especially the events during which the freeboard is exceeded highest deviate significantly from the line representing Ritter's theory. The PDB and HF events do not relate to this theory. Especially the HF event shows significant scatter. When comparing the exceedance of the bulwark to the height on deck 4.8m further, the $\frac{4}{9}$ relation seems to be somewhat closer to the measurements, but significant deviations from this line are still noticeable, especially the high events.

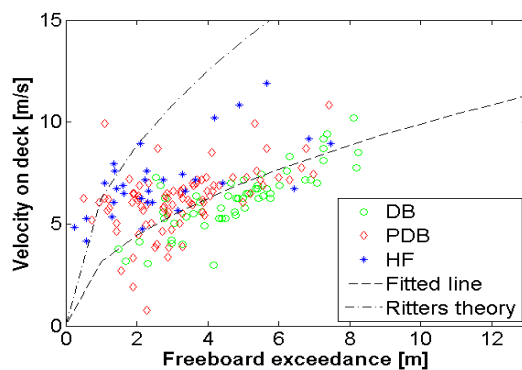
The velocity on deck based on the bulwark exceedance, as can be seen in Figure 5.40c, is over-predicted by the classical Dam Break theory. A second line ($y = \sqrt{g \cdot x}$) shows a better relation, but especially the HF events are not predicted well.



(a) Freeboard vs BWK exceedance.



(b) BWK exceedance vs water height on deck at RWP5Odeck



(c) Freeboard vs velocity on deck.

Figure 5.40: Freeboard exceedance vs the resulting exceedance at the bulwark, bulwark exceedance and the resulting water height on deck measured at the RWP5odeck probe 4.8m from the bow (center-line probes).

5.4.2. Classification approach

To be able to build upon this research, a connection has to be made between the events classified by Greco et al. [2007] and the modified classification made in this research. The most noticeable modification to the classifications made by Greco et al. [2007] is the Plunging Wave omission. Although a plunging effect is seen in multiple events during the green water observations, this effect is not seen as an independent classification.

Dam Break event

In Figure 5.42 the illustration of a Dam Break event flowing on a fixed model and frames from a Dam Break classified event of the model tests done. As can be seen, the smooth flow is observed, although an air gap in between the deck and the wave will always occur due to the presence of the bulwark. As described by Greco et al. [2007], a typical Dam Break event has a vertical incoming velocity that is higher than the velocity at the bow as this wave stagnates as it builds up in front of the bow. When the water flows on the deck it accelerates again, influenced by the vessel motions and horizontal momentum it still contains.

The DB events were indeed caused by a build-up in front of the bow, but mainly caused by the vessel being pushed down (as observed in videos from the model test). As the wave does not flow on deck, but is scooped on deck, the initial velocity is low. This concurs with the initial Dam Break theory as well.

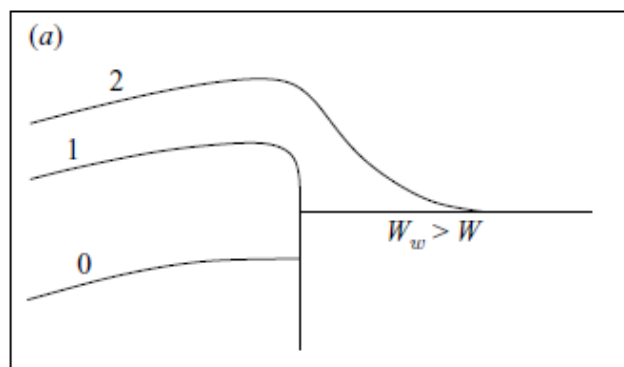


Figure 5.41: Dam Break event as illustrated by Greco et al. [2007].



(a) Dam Break event, $t=0$

(b) Dam Break event, $t=0.3098$

(c) Dam Break event, $t=0.6197$

Figure 5.42: Comparison of an observed Dam Break event and the proposed Dam Break event illustrated by Greco et al. [2007]

Plunging Dam Break event

In Figure 5.44 it can be seen that the PDB as defined in Greco et al. [2007] and in this research, shows reasonable resemblance. Due to the bulwark present on the model used in this research, the air gap is always larger than observed by Greco et al. [2007]. Also, the incoming wave is steeper as it runs up along the bow, because of the vessel and wave interactions and the ship shaped form of the model. The incoming wave hits the deck in a steeper angle, as is described earlier on. Greco et al. [2007] describe the PDB incoming vertical velocity to be equal (or almost equal) to the vertical velocity on the bow. When the water hits the deck it shoots toward the vertical structure on deck. The PDB events are associated with steep waves, flowing on deck because of a combination of the slamming of the vessel and the upward motion of the wave (causing the run-up).

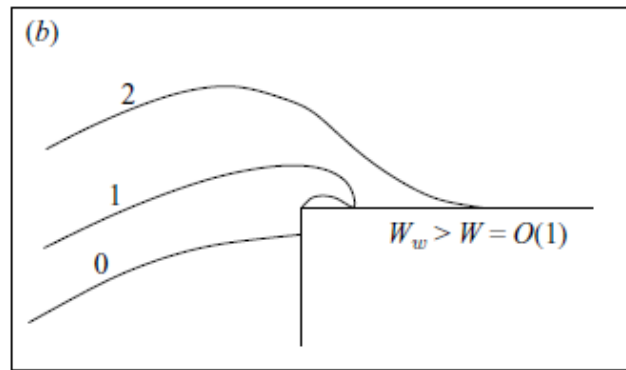


Figure 5.43: Plunging Dam Break event illustration

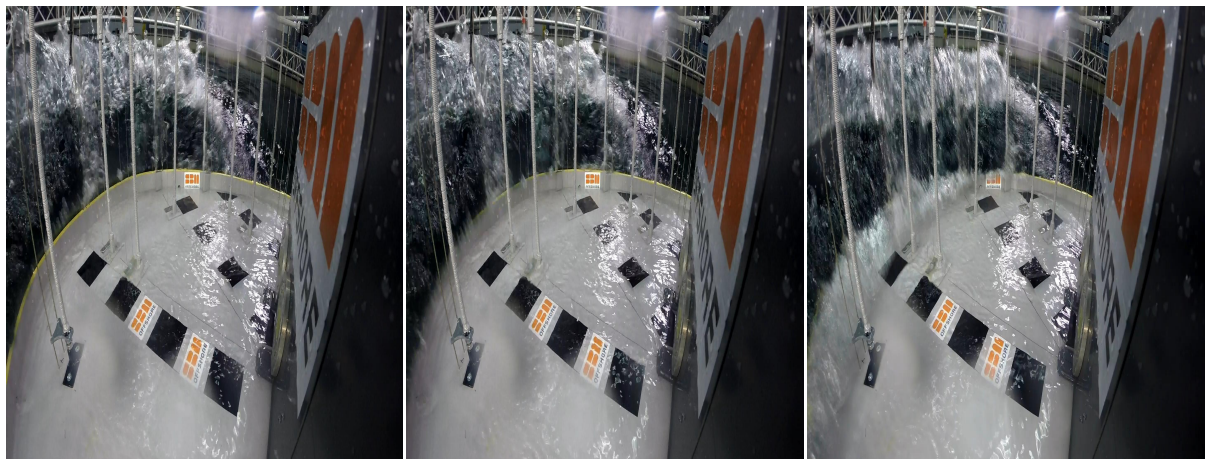
(a) Plunging Dam Break event, $t=0$ (b) Plunging Dam Break event, $t=0.3098$ (c) Plunging Dam Break event, $t=0.6197$

Figure 5.44: Comparison of an observed Plunging Dam Break event and the proposed Plunging Dam Break event illustrated by Greco et al. [2007]

Hammer Fist

As can be seen in Figure 5.46, the HF event as illustrated by Greco et al. [2007] resembles the HF as observed in the model test videos. Due to the motion of the vessel and the bulwark, the aeration of a HF wave on a floating vessel is significantly larger. Greco et al. [2007] describe the Hammer Fist event as gaining velocity as it flows on deck compared to the incoming velocity, as opposed to the DB event which loses velocity when approaching the bulwark. Because of limited vessel motions and the sudden surface decline, the waves relative velocity increases. Depending on the wave height and crest steepness, the water hits the deck or vertical structure immediately.

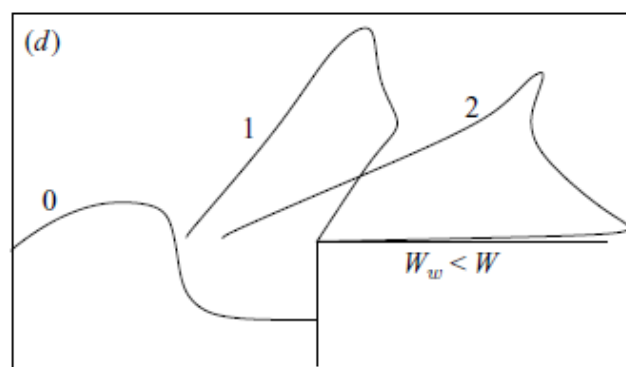


Figure 5.45: Hammer Fist event illustration

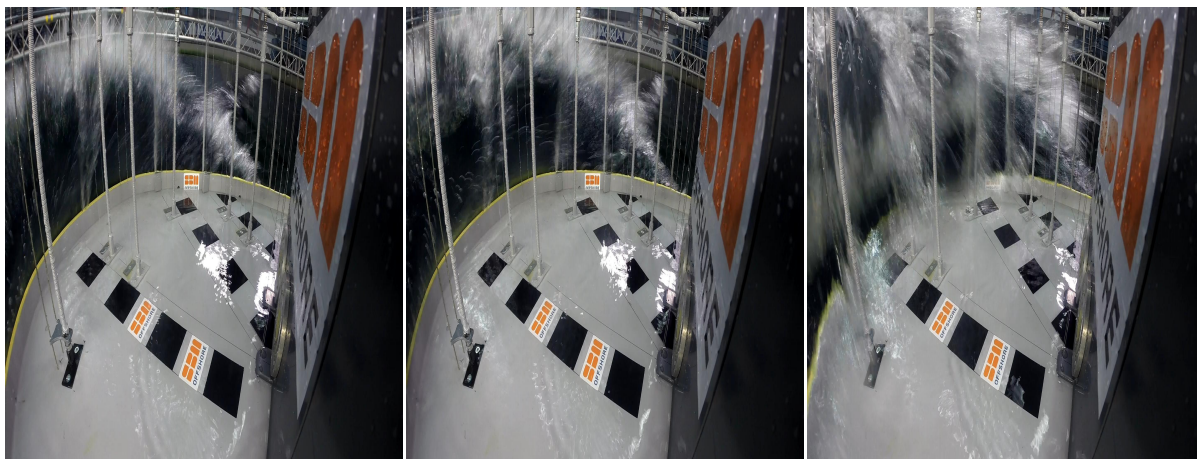
(a) Hammer Fist event, $t=0$ (b) Hammer Fist event, $t=0.3098$ (c) Hammer Fist event, $t=0.6197$

Figure 5.46: Comparison of an observed Hammer Fist event and the proposed Hammer Fist event illustrated by Greco et al. [2007]

5.4.3. Discussion of comparison to the existing theory

When comparing the distinguished events to the existing theory, it can be seen that the DB classified events show the closest resemblance to the original Dam Break theory. Because the assumptions on which this theory is based (and possibly the presence of a bulwark) these values still deviate from the classical Dam Break theory significantly.

The classifications done by Greco et al. [2007] resemble the observations done in this research reasonably well. The significant differences in the way the model tests are set up make the two complex to compare, mainly because the classifications done in this research are based strongly on the vessels motions and interaction with the incoming waves.

5.5. Overall discussion of results

In this chapter we have tried to find an answer to the the question why predictions of water height and velocity on deck using the Dam Break model are not accurate. To do the analysis, we make use of two different sets of data: one wave set without the model present in the basin and one with the model present. The vessels influence on the incident wave height and steepness was shown to be significant: the waves are influenced by diffraction and radiation effects, causing steeper and higher waves. As these influenced waves are the waves that cause green water, the data set with the model present in the basin is used in the analysis. The form of the vessel has a significant impact on the way and the amount of water running up the bow, so a disadvantage of this decision is that generalisation of the results is an issue, results may not generalise to vessels with a significantly different bow than the test model had.

From this data it is observed that the Dam Break theory is an inaccurate way of describing the height and velocity on deck for all green water occurrences measured. The reason of this inaccuracy is that the assumptions on which the Dam Break theory is based do not correspond well to the green water events observed and measured in practice. The presence of the bulwark, which is not taken into account in the standard theory, is another possible cause of deviations from the theory.

Three different types of green water events can be distinguished through observation of the model test videos. The difference between these events wasn't always clear however. Particularly the DB and PDB showed some similar characteristics in a couple of cases. Based on the vessels motions and the relation between the exceedance of freeboard and bulwark, the unclear events were classified.

The influence of the different sea states on the occurrence of the different types of events as observed in the experiments is shown below, in Table 5.4. A clear correlation between sea state characteristics and the types of green water events occurring is not yet clear. It can be observed however that the HF event occurs least frequent in every sea state, and the PDB most frequent.

	Hs [m]	Tp [s]	S [-]	λ [m]	events/hour	DB [%]	PDB [%]	HF [%]
S1	12.12	13.56	0.041	287.08	9	33.45	47.90	18.66
S2	12.30	14.18	0.039	313.93	10	36.67	43.33	20.0
S3	12.30	15.65	0.030	382.40	3	16.67	65.16	14.65
S4	15.12	15.34	0.041	362.63	14	35.71	50	14.29

Table 5.4: Incident wave parameters causing the different events.

Phase is an important factor determining how and if a wave flows on deck. The characteristics of a group of waves are therefore more determining than the sea state characteristics. As is shown in Table 5.5, the DB is caused by high vessel motions, triggered by a group of long waves. The PDB is caused by similar vessel and wave interactions, but the phase angle is different. The bow motions during the PDB event are high as well, caused by the wave group exciting the vessel. The HF event is significantly different from the other two events however, the vessel motions are of less influence during this event. A single wave hits the vessel, causing a small pitch.

	Wave length [-]	Crest height [m]	Crest steepness [-]	Bow motion [m]
DB	>1	-	0.05-0.35	-16 >z >-5
PDB	>= 1	-	0.2-0.45	-10 >z >3.5
HF	1<	-	0.3-0.6	-3 >z >5

Table 5.5: Type of green water determining parameters. The length of the wave is normalised with the vessels length (264 meter in full scale)

The impact of the different events on deck are listed in Table 5.6. The DB events cause significantly higher loads on deck than the PDB events. This must be because of the difference in the amount of water that is shipped on deck, since the velocities are similar. The flow pattern on deck of the DB and PDB events are similar, resulting in a similar impact pattern on deck as well. The HF events exert the highest loads on deck. A clear flow on deck is not seen as the wave slams into the bow and over the deck. In some cases a two stage flow is observed caused by minor vessel motions, a run-up along the bow and slamming against the vessel. The the two extreme events were HF events. Two 1000 kN impact events were caused by rogue waves without significant vessel motions.

	Mean impact [kN]	Max impact [kN]	Water on deck [m^3]	Velocity on deck [m/s]
DB	91.27	600.83	398.97	6.25
PDB	66.62	555.65	303.61	6.18
HF	150.43	1094.0	301.25	7.06

Table 5.6: On deck wave parameters during the different events.

When comparing the results from the research to the existing theory, we found that using the Dam Break theory model is an accurate way to predict the water height and velocity on deck for the events classified as DB events. The events classified as PDB and HF, however, can not be predicted to a significant degree of accuracy using this theory.

As mentioned before, these different types of green water waves are based on observations done by Greco et al. [2007]. The green water classifications as observed in this research are similar to the observations done by Greco et al. [2007]. Modifications had to be done as the green water events observed in this model test are mainly driven by vessel motions (except for the HF) whereas Greco et al. [2007] base the events solely on different types of waves on a fixed structure.

6

Conclusions and Recommendations

This study dealt with the problems caused by green water waves, waves that reach so high that significant overflow onto the deck occurs. In extreme cases ships have been reported to sink as a consequence, but substantial damage to deck superstructures can occur also in less extreme circumstances. Specifically our research has focused on the adequacy of the prevailing method of predicting green water flows, a method that draws on the analogy of the water flows released after a dam breaks (the so called *Dam Break theory*). By comparing results from earlier tests conducted by SBM in the MARIN laboratory, we found significant differences between the Dam Break theory predictions and the empirical test results. By comparing information extracted from video footage with sensor measurements made simultaneously, we explored various explanations for these different trends.

The first hypothesis tested was that the unexpected measurements were misinterpreted values caused by spray or the fact that the relative wave sensor is slightly outside of the bow, instead of regular green water waves. However, by carefully pairing the (unexpected) measurements with frames from the video footage synchronized in time with the measurements, we show conclusively that in the majority of these cases the measurements were not misinterpreted. Some cases were explained by spray, but these were easily detected as low impact pressure followed these "green water events".

The second question was whether the Dam Break theory is an accurate way of describing the wave height and velocity on deck. We concluded, after comparing the measured data to Ritter's Dam Break model and results from earlier studies, that the Dam Break theory is not accurate when regarding a vessel with this type of bow and bulwark. The Dam Break formulas predict an initial water height on deck, based on the exceedance of the freeboard, that is significantly lower than the measured values. The velocity on deck, that is predicted and measured, deviates from the theory as well, but these values are lower than the theory predicts. Several Dam Break modifications have been proposed on improving the Dam Break theory's performance. All these models are based on the underlying theory that $\frac{4}{9}$ th of the wave exceeding the deck actually flows on deck. This turned out to be an inaccurate prediction, therefore modifications based on this relation are not accurate either.

The final hypothesis was that the inaccuracy of the Dam Break model is due to the fact that different types of green water waves exist, instead of only the the Dam Break type. Our analysis shows that three different green water waves should be distinguished to adequately describe all significant green water events. The three types of green water events that should be distinguished are:

- Dam Break
- Plunging Dam Break
- Hammer Fist

The DB event is caused by a wave group exciting the vessel until the vessel motions are large enough that the vessel dives into the wave before the maximum wave height is reached, causing high freeboard exceedance. Typically, a wave group of long (longer than the vessels length) high crested waves cause large vessel motions, and the final wave causes the actual event. Because of the vessels motions and high crest, a high freeboard exceedance is measured, although this is very much dependent on the phase. The vessel dives into the wave, as if it is pushed under water, therefore the horizontal velocity of this freeboard exceeding wave is relatively

low. The initial velocity on deck is dependent on this exceedance of the freeboard. The amount of water on deck is high, because a wave is scooped up, instead of breaking against the bow.

The PDB event is caused by a wave group as well, but the phase of the vessel motions and the incoming waves is different compared to a DB event. During a DB event the vessel dives into the wave before the maximum height is reached, while during a PDB event, the vessel dives when the wave is at its maximum height, causing the wave to slam against and run up along the bow. The freeboard exceedance is typically equal or lower than the bulwark exceedance, caused by the steepness of the wave running up along the bow, resulting in a plunging wave on deck. The amount of water flowing on deck during a PDB event is significantly lower than during a DB event, caused by the run-up and slamming against the bow and the phase with the incoming wave.

The HF event is not caused by a group of waves inducing vessel motions, but by a single wave with a high and steep crest hitting the vessel. The HF event occurs when a group of mainly short waves (shorter than the vessel) propagate towards the vessel. Because of the short waves, the vessels motions are limited during the event. And because of the limited vessel motions, the freeboard and bulwark exceedance relation during the HF event is mainly dependent on the crest height and steepness. Due to the wave breaking against the bow, the amount of water on deck is typically lower than during a DB event, although extreme crest heights cause significant water on deck. Because of this wave slamming, a high amount of spray is observed and measured, making it difficult to distinguish a typical flow on deck.

These different green water event types are caused by (a combination of) different wave parameters and are largely dependent on the phase with the waves. Therefore, the prediction of different events based on an input sea state only is going to be difficult. Some observations can be done however. During the wave seeds with the longest waves, the least amount of HF events were observed. This was as expected, as HF events are caused by waves that are shorter than the vessel. The PDB events are, compared to the DB events, less dependent on the phase of the wave and the vessel so PDB events occur more often than the other two types of green water waves.

Although most green water events don't show a clear correlation with the steepness of the waves, the steeper sea states result in more green water events.

Only events that were characterised as Dam Break events show a good correlation with the Dam Break theory predictions. Measurements of the water height and velocity on deck correspond to the theoretical values reasonably well although modifications to the model were necessary to obtain that result for the velocity predictions. The other two types of green water do not fit the Dam Break theory, nor could the fit be improved significantly enough by modifying the DB theory. This is the main cause of the deviation of the measurements from the theory and shows that modifying the DB theory will not result in a better prediction of all green water events. The assumptions on which the Dam Break theory is based are reasonably valid when considering the DB classed events but do not correspond to the other two events, with the incorrect predictions as a result.

The initial research done by [Greco et al. \[2007\]](#), who first described different types of green water events, shows some comparison to the events as described in this research. The observations were done based on a fixed and non ship shaped model, so modifications had to be done as the green water events observed in this model test are mainly driven by vessel motions (except for the HF) whereas [Greco et al. \[2007\]](#) base the events solely on different types of waves.

Recommendations for future research

The first recommendation concerns the use of the Dam Break validation model. The Dam Break theory is used widely; to state that the theory is wrong altogether may be premature. The presence of a bulwark and different bow shapes cause results that are at variance with model tests done in the past. The theory may still be accurate enough for some vessels in some sea states, but more research is clearly called for particularly on extensions accommodating ship shape details.

A second recommendation concerns the classification path for wave types. More research is needed before we can accurately predict the type of green water events (especially the extreme values) based on a given vessel type and sea state spectrum, since we only evaluated a limited variety of sea states and only one bow form in this research project. Nevertheless, the significant difference between the three classifications prove that defining different physical events within the green water phenomenon is a promising way to go and should be further examined. A third conclusion concerns the benefits of using visual data. Analysing footage of model tests is a time consuming activity, but the benefits should be clear from this research project's results. We determined the different classifications using the video observations. As these classifications were

based on multiple wave and on deck parameters, additional video observations of the events were necessary. Also, variables such as spray, verification of velocity on deck and wave mechanisms could only be determined through observations of the video footage. When researching green water further, the further use of video footage will be necessary.

Finally a few miscellaneous other suggestions are done. In this research project, the waves that cause a relatively low impact on the equipment have been disregarded. On a slippery deck one is easily swept of his or her feet. As described in [Jorgensen \[1982\]](#), 22% of all injuries on deck were caused by slipping (in Norwegian waters). Also, when located in a sub-arctic or Arctic region, water on deck can cause different problems than only an impact force. A small film of water will freeze on deck and equipment and this will build up when more spray is over-topping on deck. As can be read in [Kulyakhtin and Tsarau \[2014\]](#), the build-up of ice, or icing, can cause rescue equipment and doors to get stuck and sealed, ice can close off the ventilation system from the outside, which can cause an accumulation of gas with increases explosion risks, and the ice build-up has a negative effect on the vessels motions (only in heavy ice build-up). The occurrence of spray and small amounts of water on deck should therefore be investigated further.

Recommendations for current engineering practice

This research project is a first attempt to predict water height and velocity on deck of a floating model in another way than using the Dam Break model, so strong recommendations for actual engineering practices should not yet be expected. Nevertheless, a couple of suggestions for performing future model tests follow from our results.

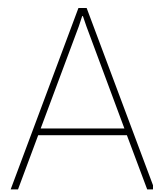
The event exerting the highest loads on deck is the HF wave type, a type that fits the Dam Break model particularly poorly, and is observed least often. It should be investigated if the low frequent occurrence of the HF event is a trend or resulting from the model test set-up. We saw that the percentage of HF events is higher when the wave lengths are shorter, since HF events only occur during short, steep waves.

The flow pattern on deck is different for the different events. The DB events flow from all sides. The PDB event flows mainly through the middle of the vessel. In both cases a water jet through the center line is observed, so an inclined forecastle limiting flow through the center will decrease the horizontal impact.

Bibliography

- K. Ariyaratne, K.-A. Chang, and R. Mercier. Measurement of green water on a 3d structure. In *ASME 2009 28th International Conference on Ocean, Offshore and Arctic Engineering*, pages 531–538. American Society of Mechanical Engineers, 2009.
- K. Ariyaratne, M. Mercier, and K-A Chang. Velocity, pressure, and dam-break similarity of green water flow on a 3d structure. Number 49053. OMAE, 2011.
- Mercier M. Ariyaratne, K. and K-A Chang. Velocity, pressure, and dam-break similarity of green water flow on a 3d structure. Number 49053. OMAE, 2011.
- B. Buchner. A new method for the prediction of non-linear relative wave motions. In *Proceedings of the 17th International Conference on Offshore Mechanics and Arctic Engineering*, pages 5–9, 1998a.
- B. Buchner. A new method for the prediction of non-linear relative wave motions. In *Proceedings of the 17th International Conference on Offshore Mechanics and Arctic Engineering*, pages 5–9, 1998b.
- B. Buchner. *Green water on ship-type offshore structures*. PhD thesis, TU Delft, 2002.
- B. Buchner and J. Garcia L-C. Design aspects of green water loading on fpso's. Number 37162. OMAE, 2003.
- B Buchner et al. The impact of green water on fpso design. In *Offshore technology conference*. Offshore Technology Conference, 1995.
- G. Ersdal and A. Kvitrud. Green water on norwegian production ships. International Offshore and Polar Engineering Conference, 2000.
- N. Fonseca and C. Guedes Soares. Experimental investigation of the shipping of water on the bow of a containership. *Journal of Offshore Mechanics and Arctic Engineering*, 127(4):322–330, 2005.
- G. Z. Forristall. On the statistical distribution of wave heights in a storm. *Journal of Geophysical Research Atmospheres*, (83):2353–2358, 1978.
- G.Z. Forristall. Wave crest distributions: Observations and second-order theory. *Journal of physical oceanography*, 30(8):1931–1943, 2000.
- M Greco, G Colicchio, and OM Faltinsen. Shipping of water on a two-dimensional structure. part 2. *Journal of Fluid Mechanics*, 581:371–399, 2007.
- WAF0 Group et al. A matlab toolbox for analysis of random waves and loads. *Lund University, Lund Institute of Technology, Centre for Mathematic Sciences, Mathematical Statistics*, 2000.
- C. Guedes Soares and R. Pascoal. Experimental study of the probability distributions of green water on the bow of floating production platforms. Number 28626. OMAE, 2002.
- Janet E Heffernan and Jonathan A Tawn. An extreme value analysis for the investigation into the sinking of the mv derbyshire. *Journal of the Royal Statistical Society: Series C (Applied Statistics)*, 52(3):337–354, 2003.
- L.H. Holthuijsen. *Waves in oceanic and coastal waters*. Cambridge University Press, 2008.
- Zhe Hu, Hongxiang Xue, Wenyong Tang, and Xiaoying Zhang. A combined wave-dam-breaking model for rogue wave overtopping. *Ocean Engineering*, 104:77–88, 2015.
- H.O. Jahns and J.D. Wheeler. Long-term wave probabilities based on hindcasting of severe storms. In *Offshore Technology Conference*. Offshore Technology Conference, 1972.
- Tore S Jorgensen. *Influence of ice accretion on activity in the northern part of the Norwegian Continental Shelf*. Otter Group, 1982.

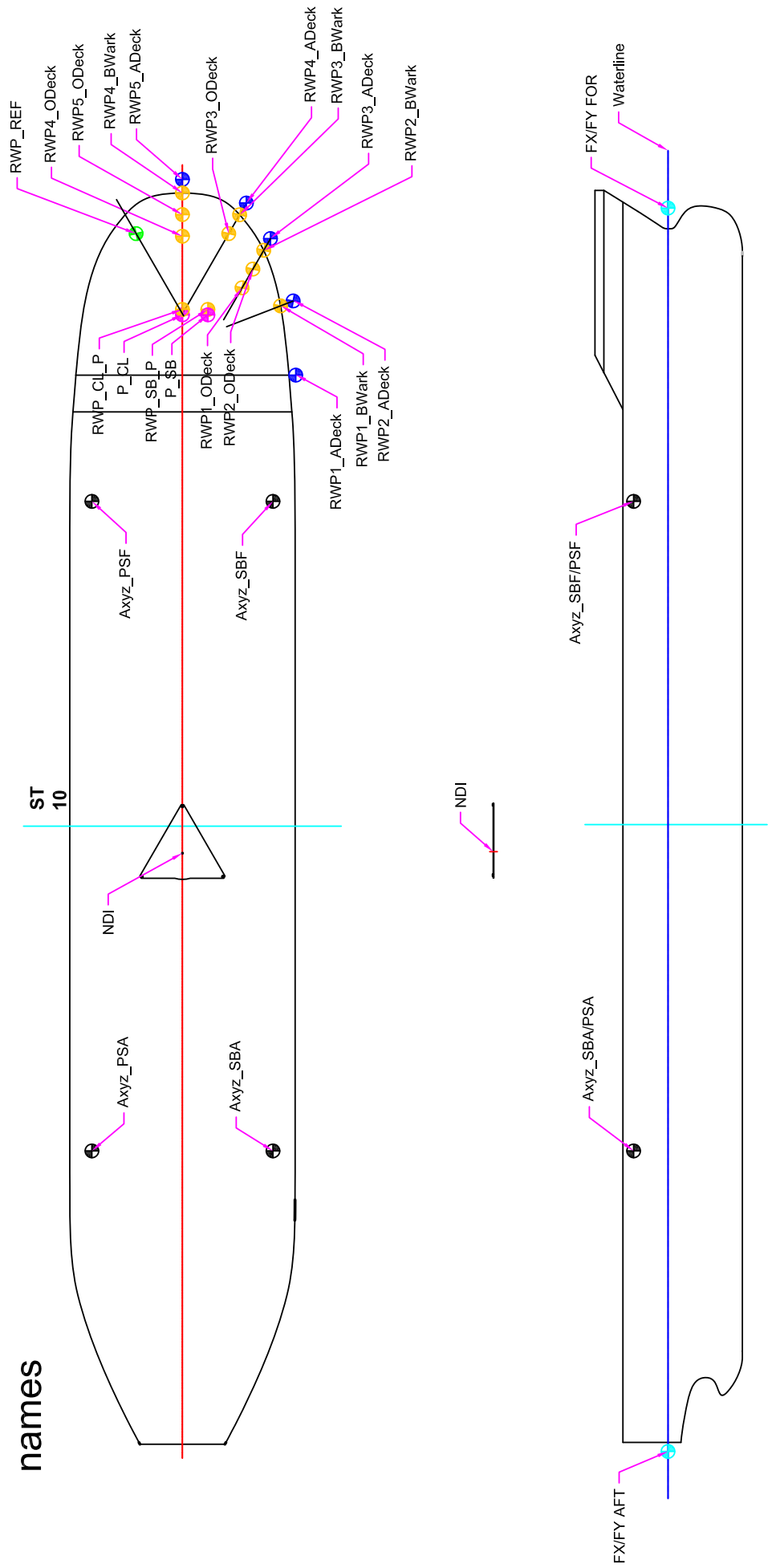
- J.M.J. Journée and W.W. Massie. *Offshore Hydromechanics*. Delft University of Technology, 2001.
- K.M.T. Kleefsman, G.E. Loots, A.E.P. Veldman, B. Buchner, T. Bunnik, and E. Falkenberg. The numerical simulation of green water loading including vessel motions and the incoming wave field. Number 67448. OMAE, 2005.
- D.L. Kriebel and T.H. Dawson. Nonlinear effects on wave groups in random seas. *Journal of Offshore Mechanics and Arctic Engineering*, 113(2):142–147, 1991.
- Anton Kulyakhtin and Andrei Tsarau. A time-dependent model of marine icing with application of computational fluid dynamics. *Cold regions science and technology*, 104:33–44, 2014.
- ARJM Lloyd. The effect of bow shape on deck wetness in head seas. Technical report, DTIC Document, 1984.
- Millar J. Morris, W.D.M. and B. Buchner. Green water susceptibility of north sea fpso/fsu's. IBC, 2000.
- RN Newton. Wetness related to freeboard and flare. *Transaction RINA*, 102:49–81, 1960.
- M. Prevosto. Statistics of wave crests from second order irregular wave 3d models. In *Rogue Waves 2000: Proceedings of a Workshop Organized by Ifremer and Held in Brest, France, 29-30 November 2000, Within de Brest SeaTechWeek 2000*, volume 32, page 59. Editions Quae, 2001.
- Y. Ryu and K-A Chang. Void fraction in green water. The International Society of Offshore and Polar Engineers, 2008.
- Y. Ryu, H-J. Lim, and K-A Chang. Use of bubble image velocimetry for measurement of plunging wave impinging on structure and associated greenwater. *Measurement Science and Technology*, 2005.
- Y. Ryu, K-A. Chang, and R. Mercier. Application of dam-break flow to green water prediction. *Applied Ocean Research*, pages 128–136, 2007.
- T. Schoenberg and R.C.T. Rainey. A hydrodynamic model of green water incidents. *Applied Ocean Research*, 2002.
- C Guedes Soares, Z Cherneva, and EM Antão. Steepness and asymmetry of the largest waves in storm sea states. *Ocean Engineering*, 31(8):1147–1167, 2004.
- C.T. Stansberg and K. Berget. Simple tool for prediction of green water and bow flare slamming on fpso. Number 79489. OMAE, 2009.
- C.T. Stansberg and F.G. Nielsen. Nonlinear wave-structure interaction on floating production systems. volume Proc. Vol . IV, the 11th, pages pp. 363–372. ISOPE Conference, 2001.
- J. J. Stoker. *Water waves: The mathematical theory with applications*, volume 36. John Wiley and Sons, 2011.
- R. Veer, van 't and E. Vlasveld. Green water phenomena on a twin-hull flng concept. Number 23915. OMAE, 2014.
- R. Veer, van 't and W. Zuidschewoude. Fpso green water on deck assessment. Number 6269. International Conference on Violent Flows, 2012.
- Iwao Watanabe, Michio Ueno, and Hiroshi Sawada. Effects of bow flare shape to the wave loads of a container ship. *Japan Shipbuilding Society Papers*, 1989(166):259–266, 1989.
- ZQ Zhou, JO De Kat, and B Buchner. A nonlinear 3-d approach to simulate green water dynamics on deck. In *Proc. 7th International Symposium on Numerical Ship Hydrodynamics, Report*, number 82000-NSH, page 7, 1999.



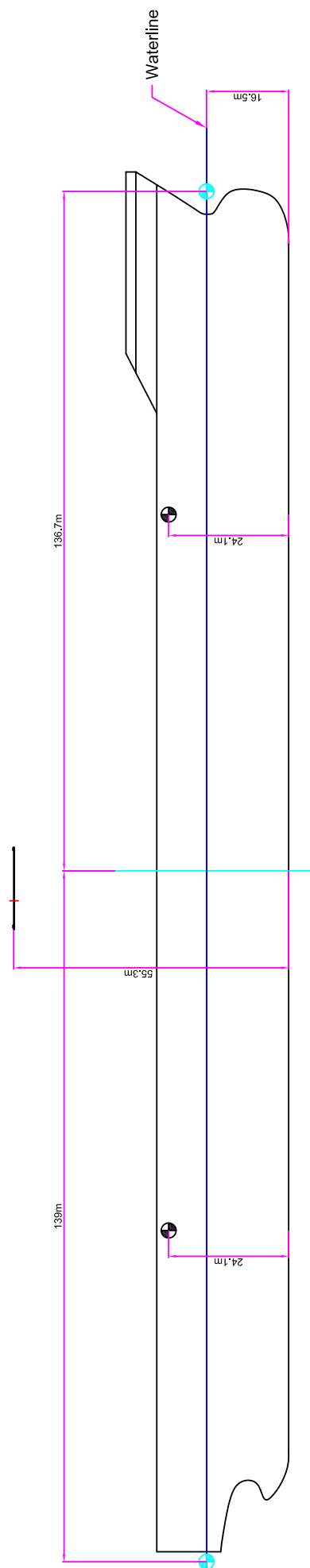
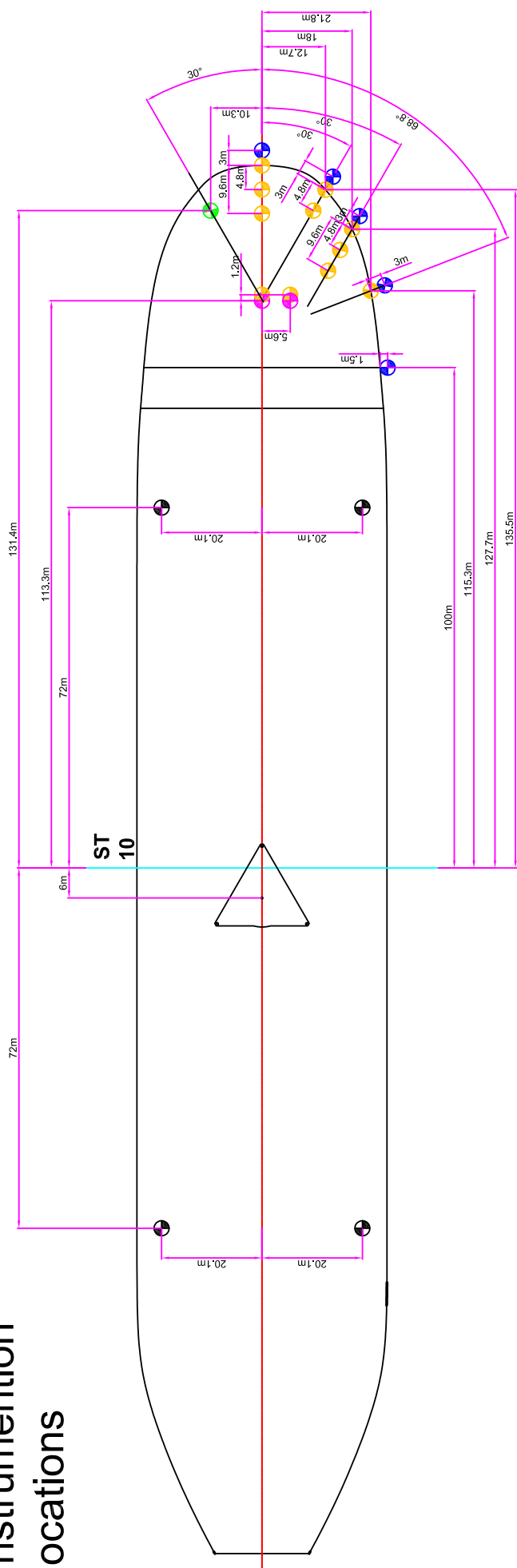
Appendix A

The names and locations of the sensors used to measure water on deck and relative wave heights are shown in figures [A.1](#) & [A.2](#), in full scale (1:60).

Instrumentation names



Instrumentation locations



B

Appendix B

In this appendix all different green water events observed are shown. The Dam Break, Plunging Dam Break and Hammer Fist events are shown in separate sections.

B.1. Dam Break event

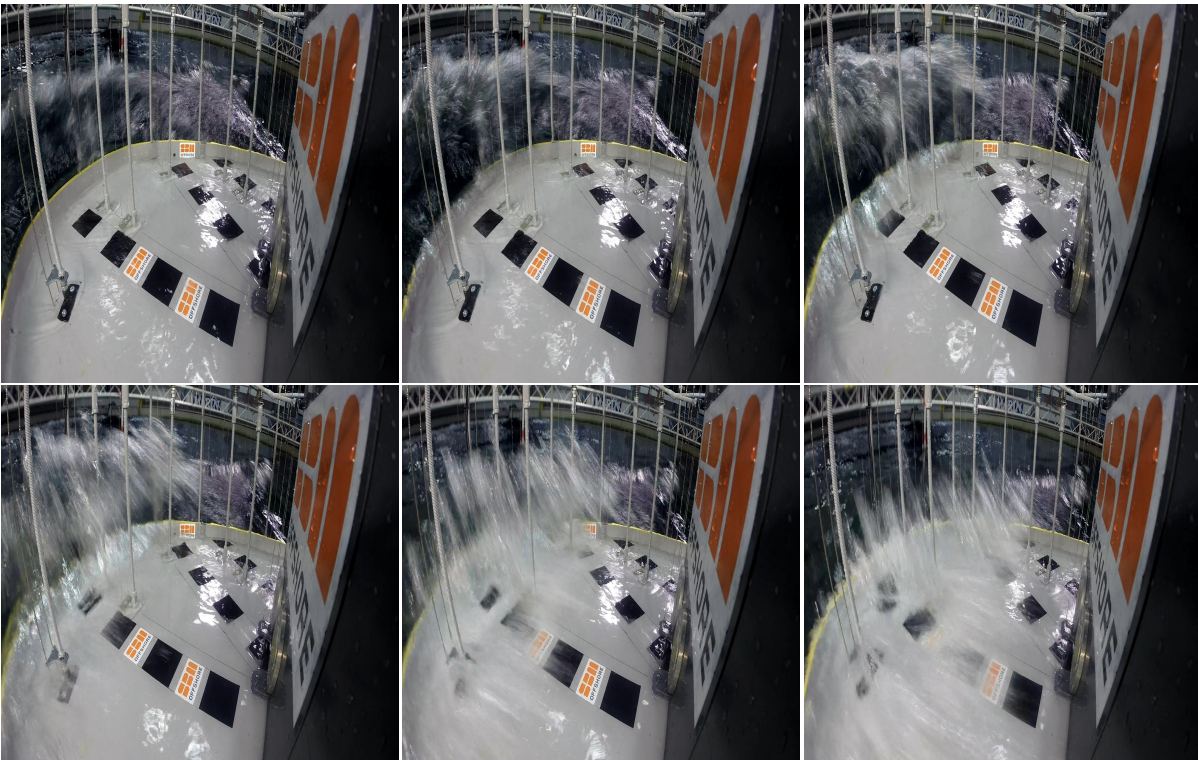


Figure B.1: Dam Break event S1 seed 1

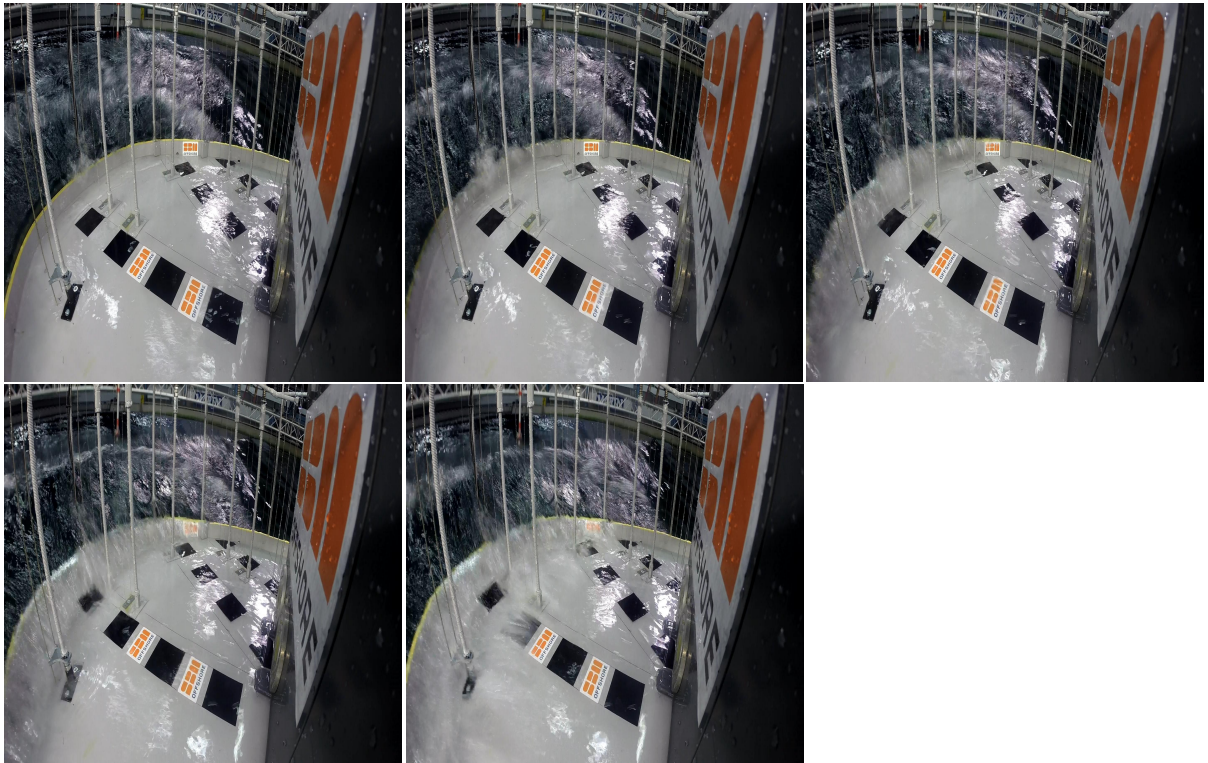


Figure B.2: Dam Break event S1 seed 1

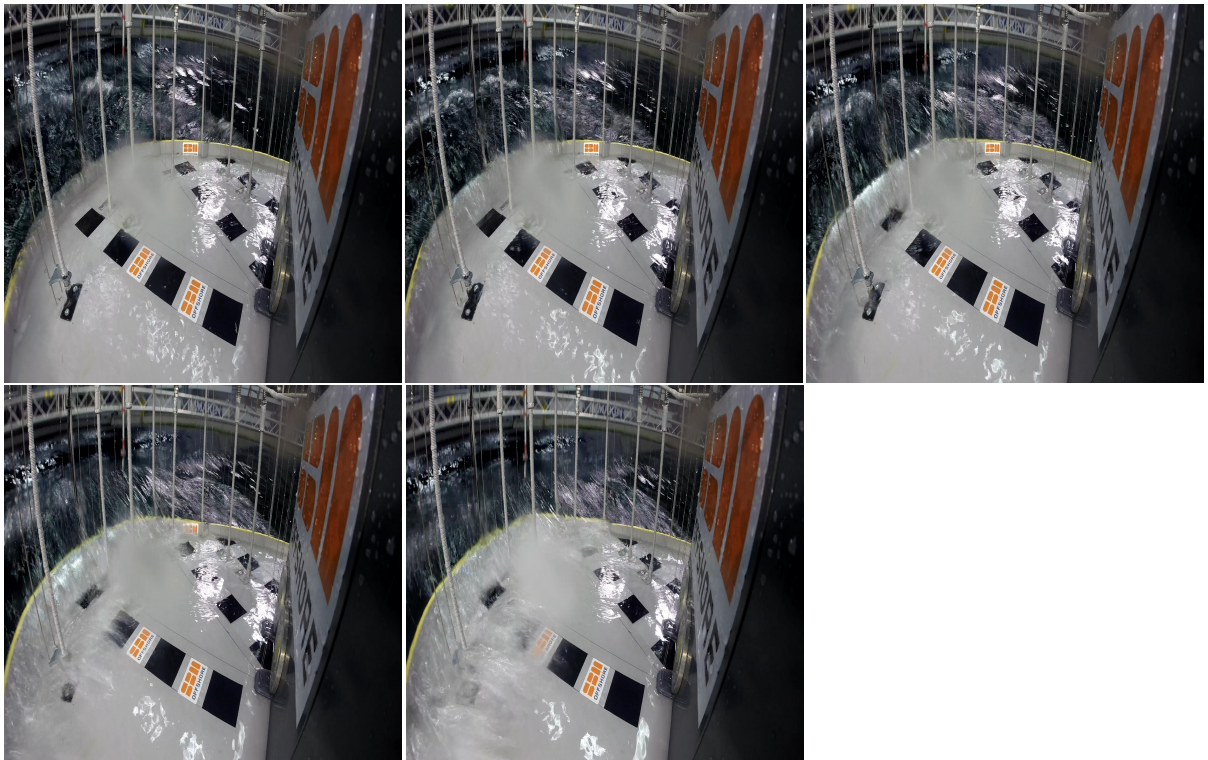


Figure B.3: Dam Break event S2 seed 1

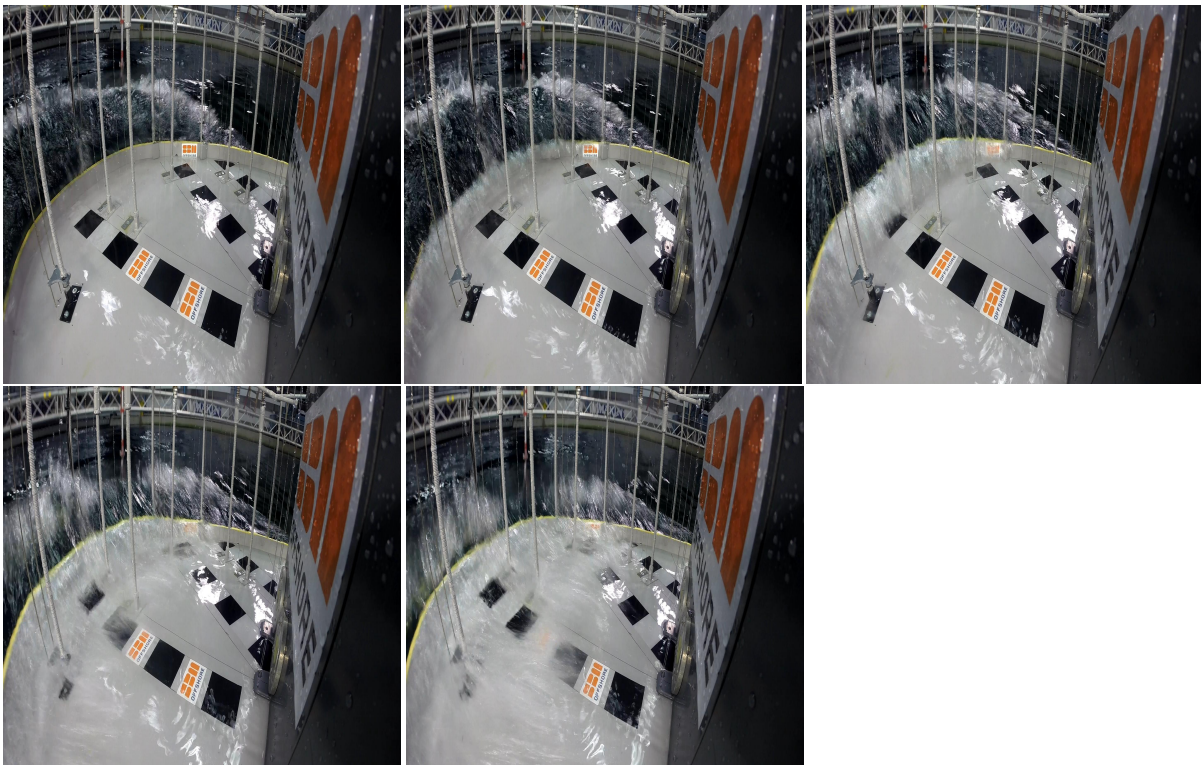


Figure B.4: Dam Break event S2 seed 1



Figure B.5: Dam Break event S2 seed 1

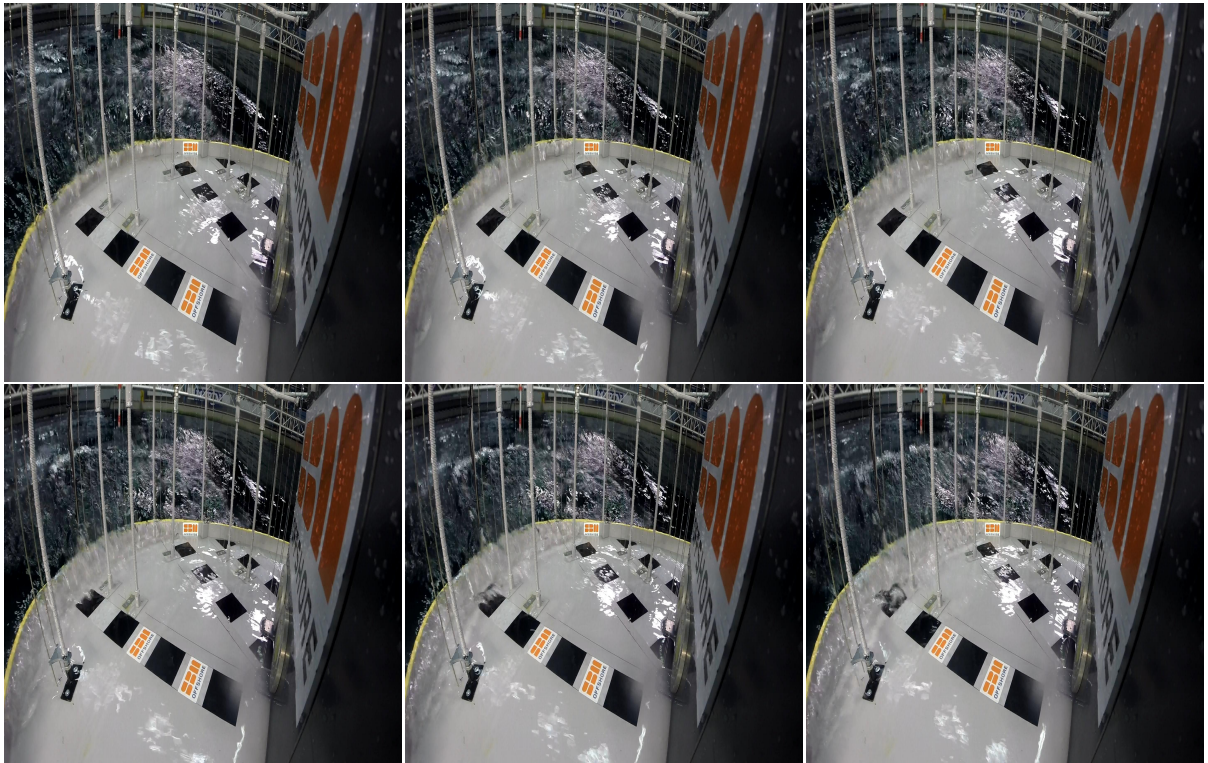


Figure B.6: Dam Break event S3 seed 1

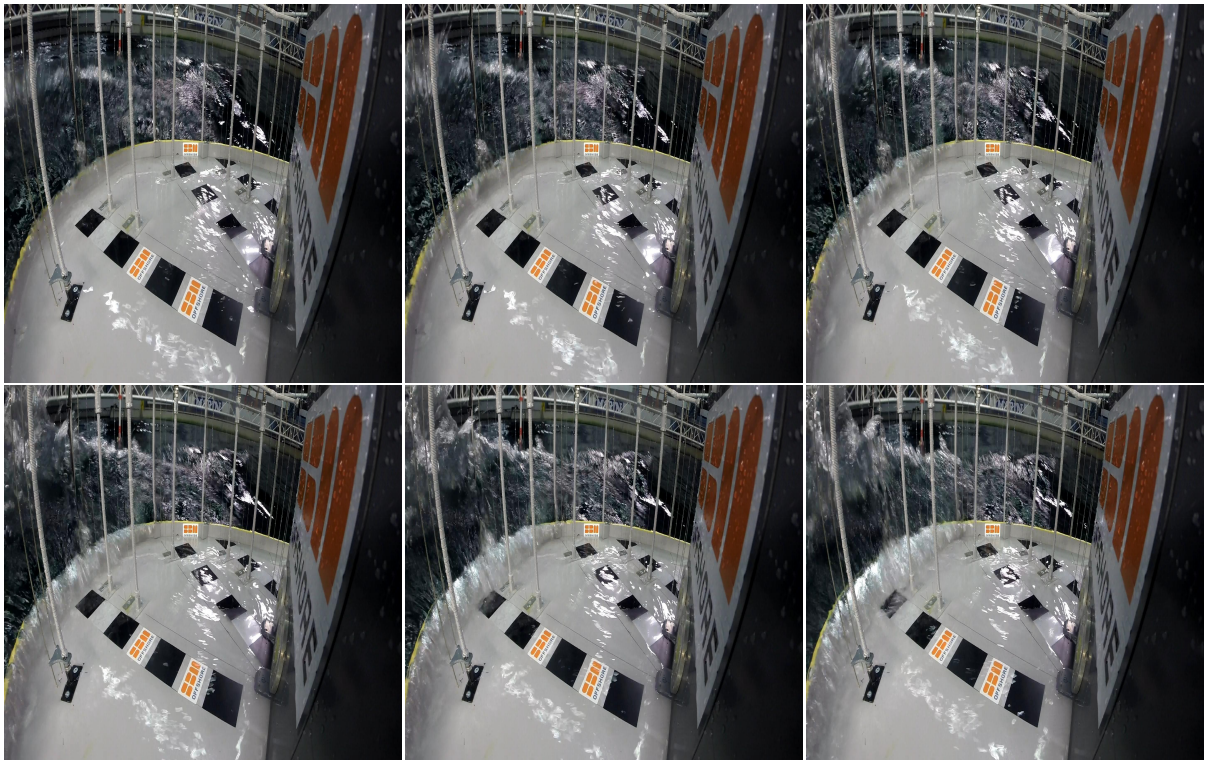


Figure B.7: Dam Break event S3 seed 1

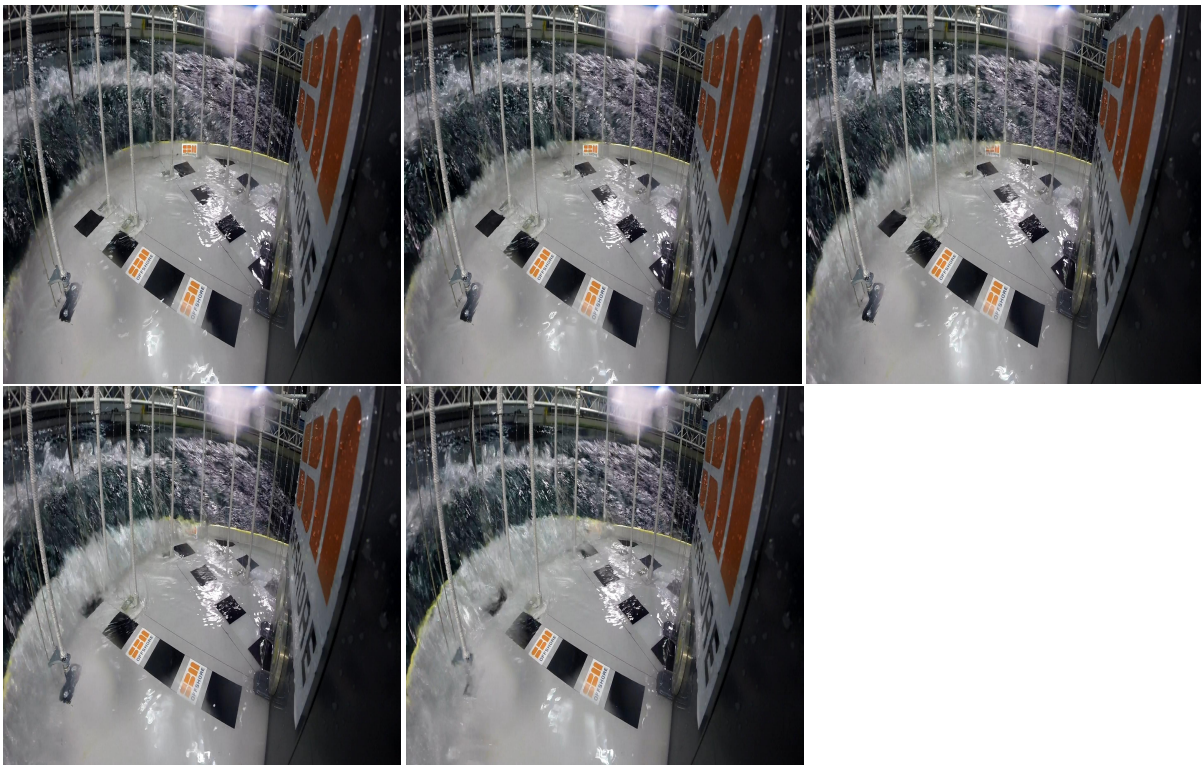


Figure B.8: Dam Break event S3 seed 1

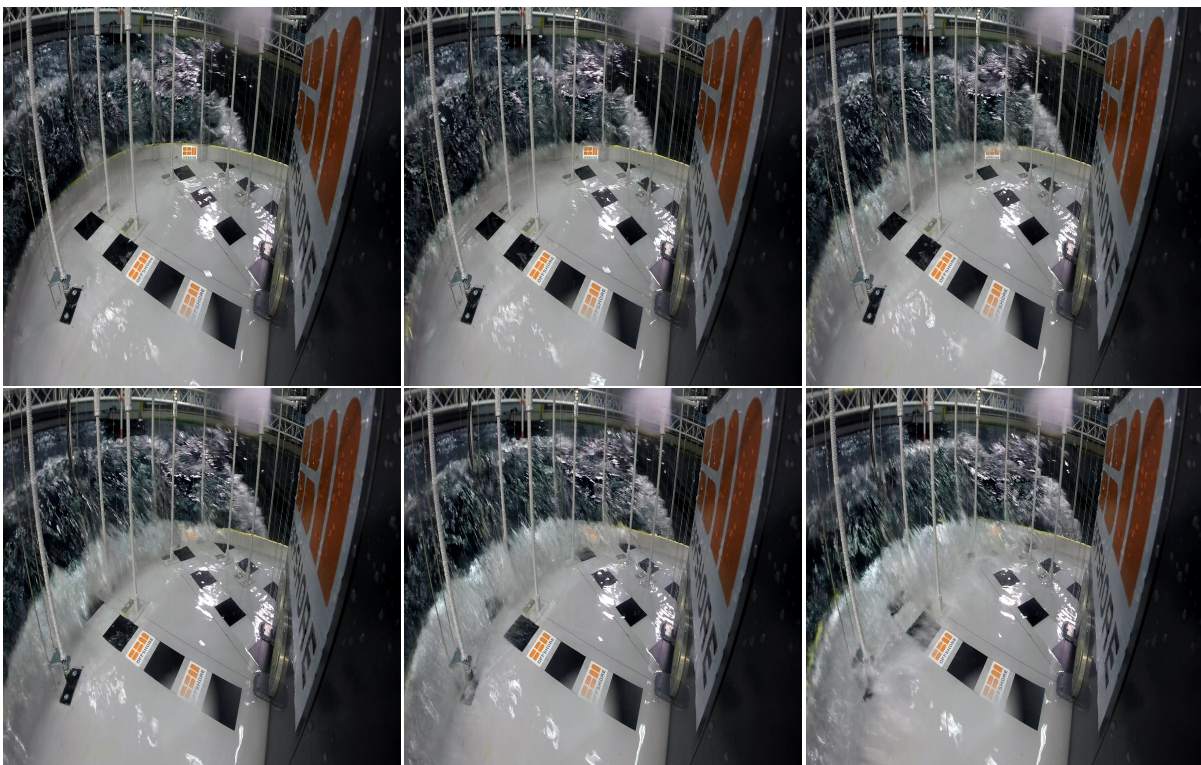


Figure B.9: Dam Break event S3 seed 1

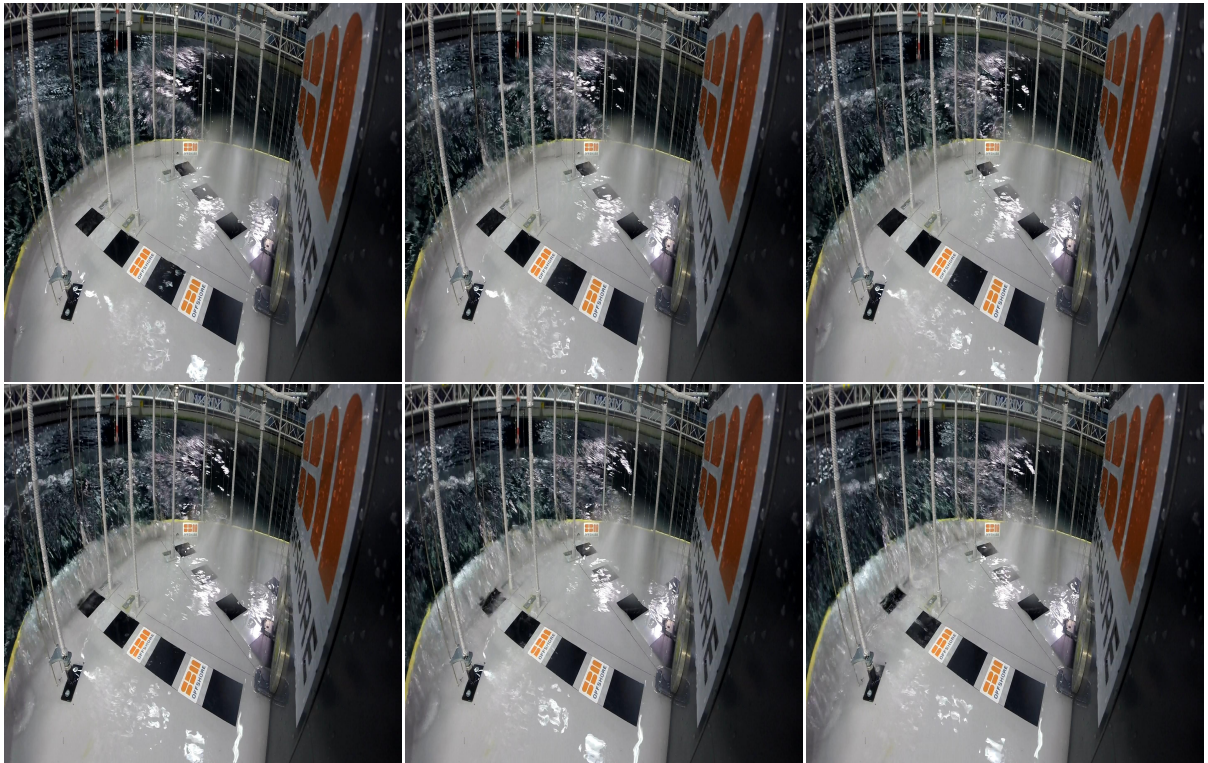


Figure B.10: Dam Break event S3 seed 1

B.2. Plunging Dam Break event

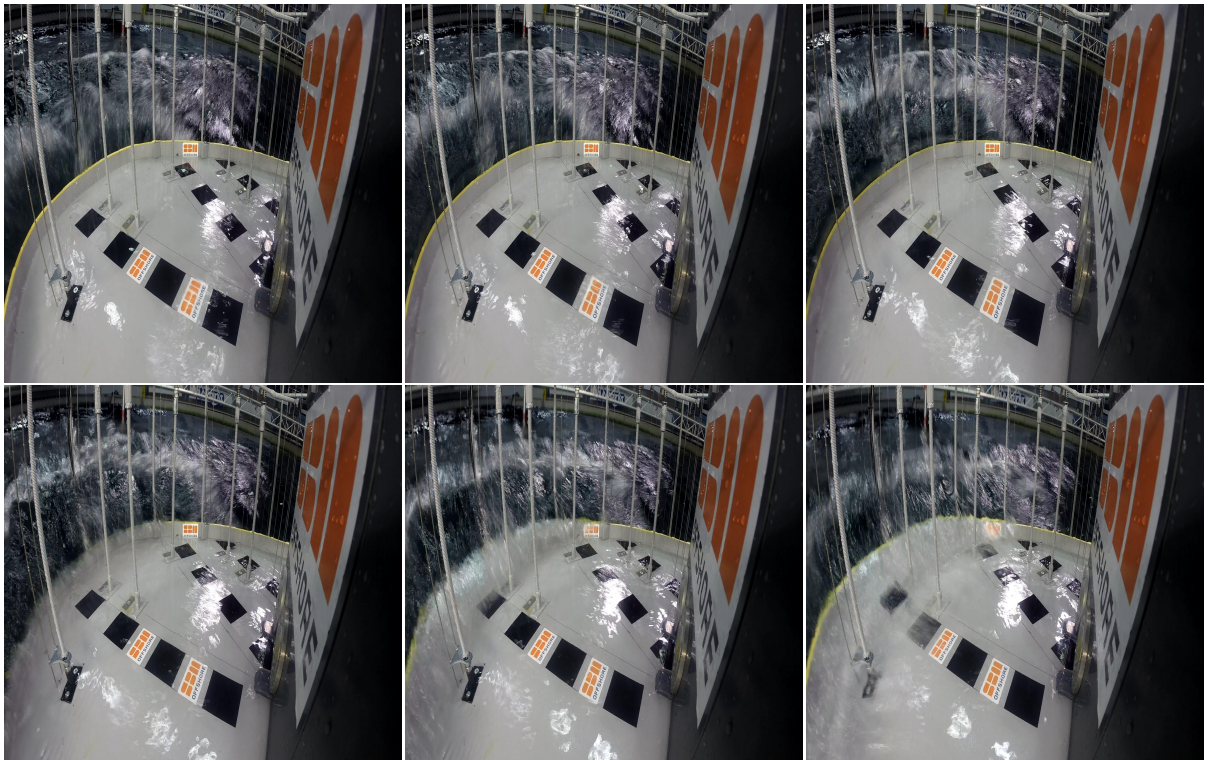


Figure B.11: Plunging Dam Break event S1 seed 1

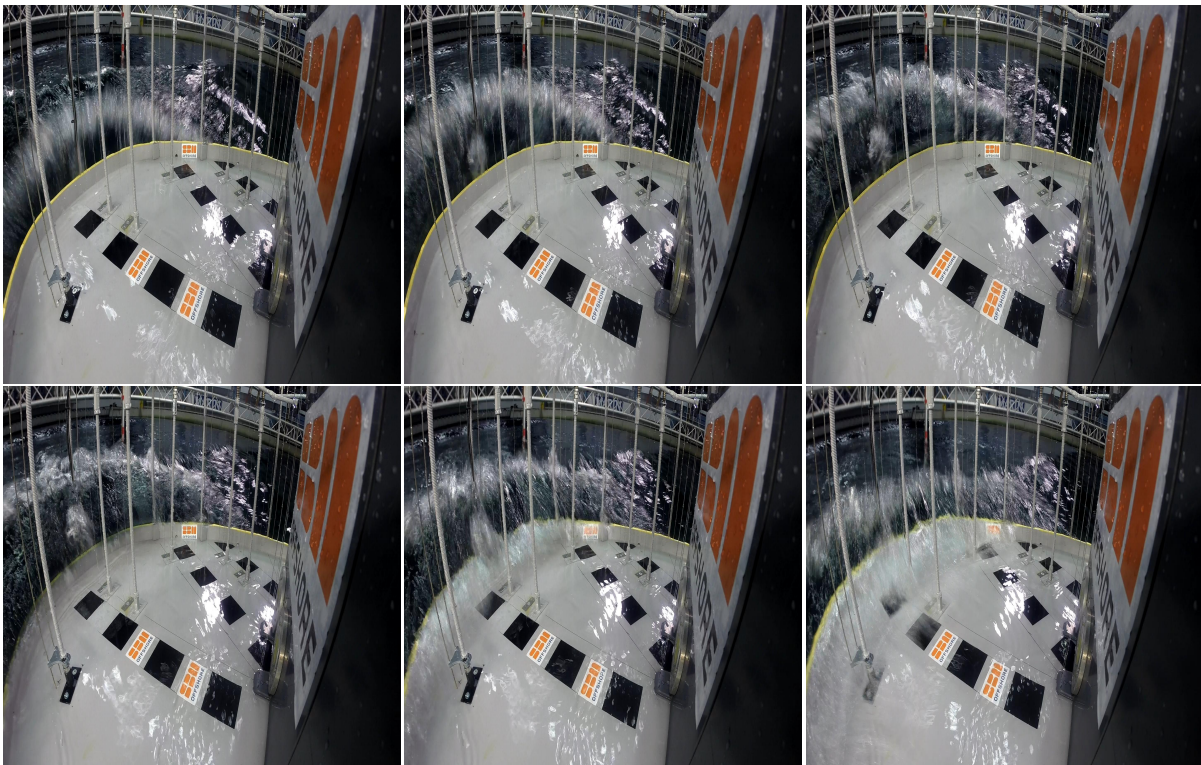


Figure B.12: Plunging Dam Break event S1 seed 1

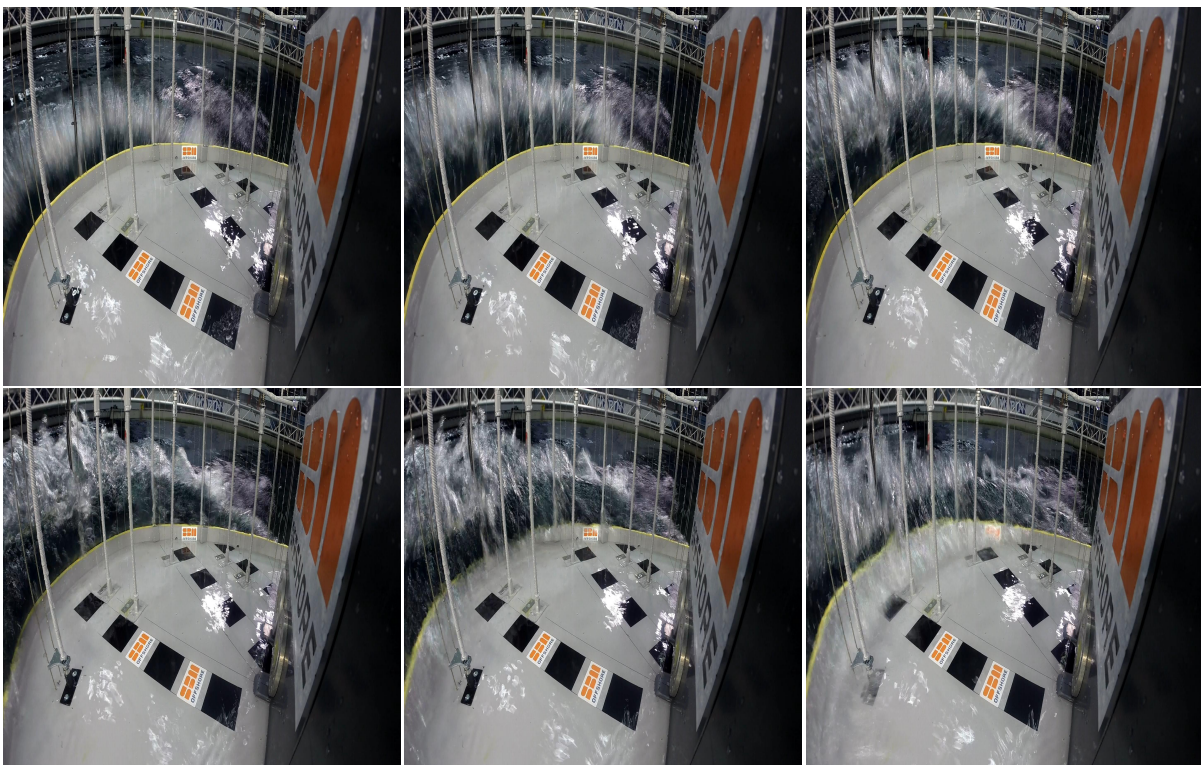


Figure B.13: Plunging Dam Break event S1 seed 2

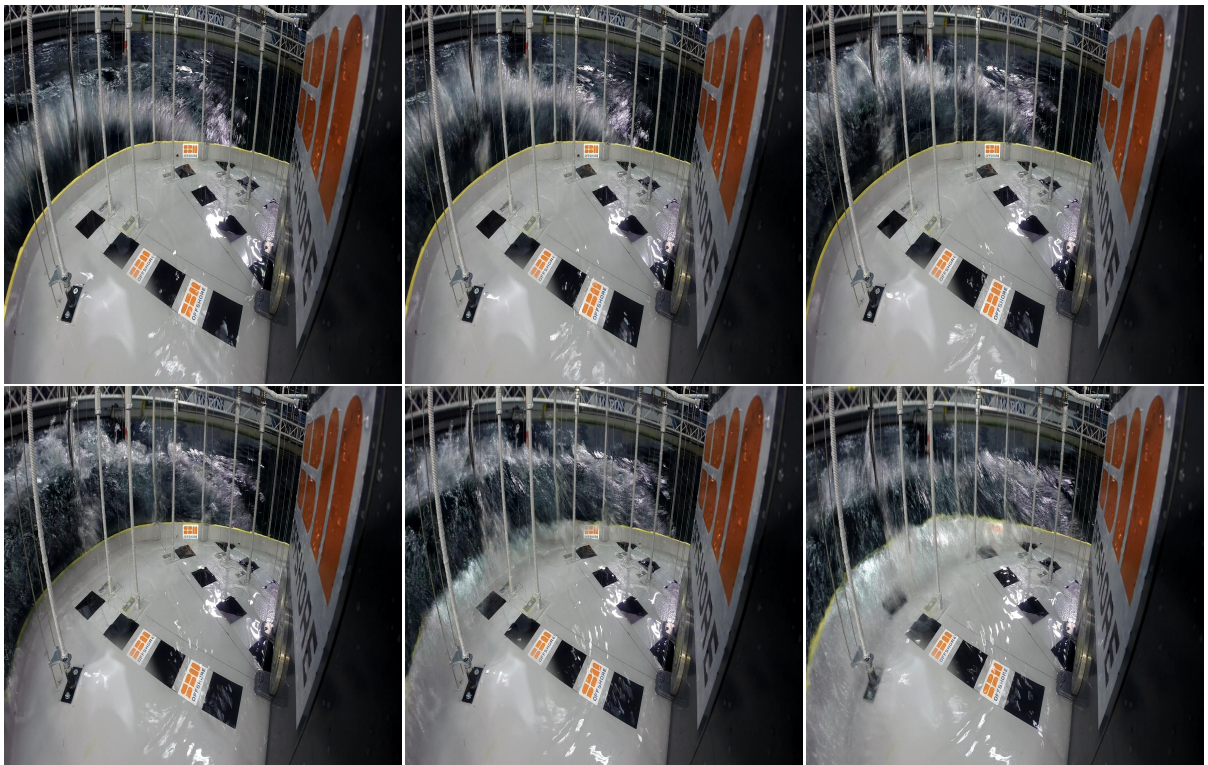


Figure B.14: Plunging Dam Break event S1 seed 2

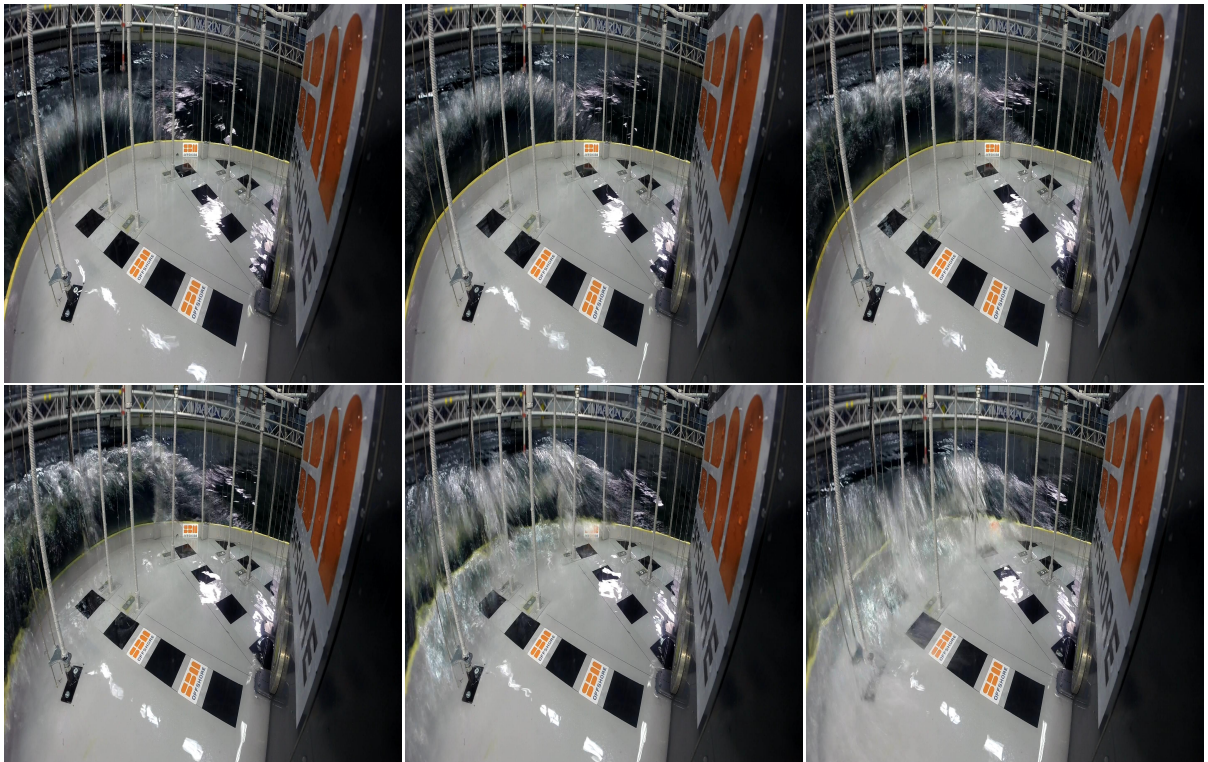


Figure B.15: Plunging Dam Break event S1 seed 3

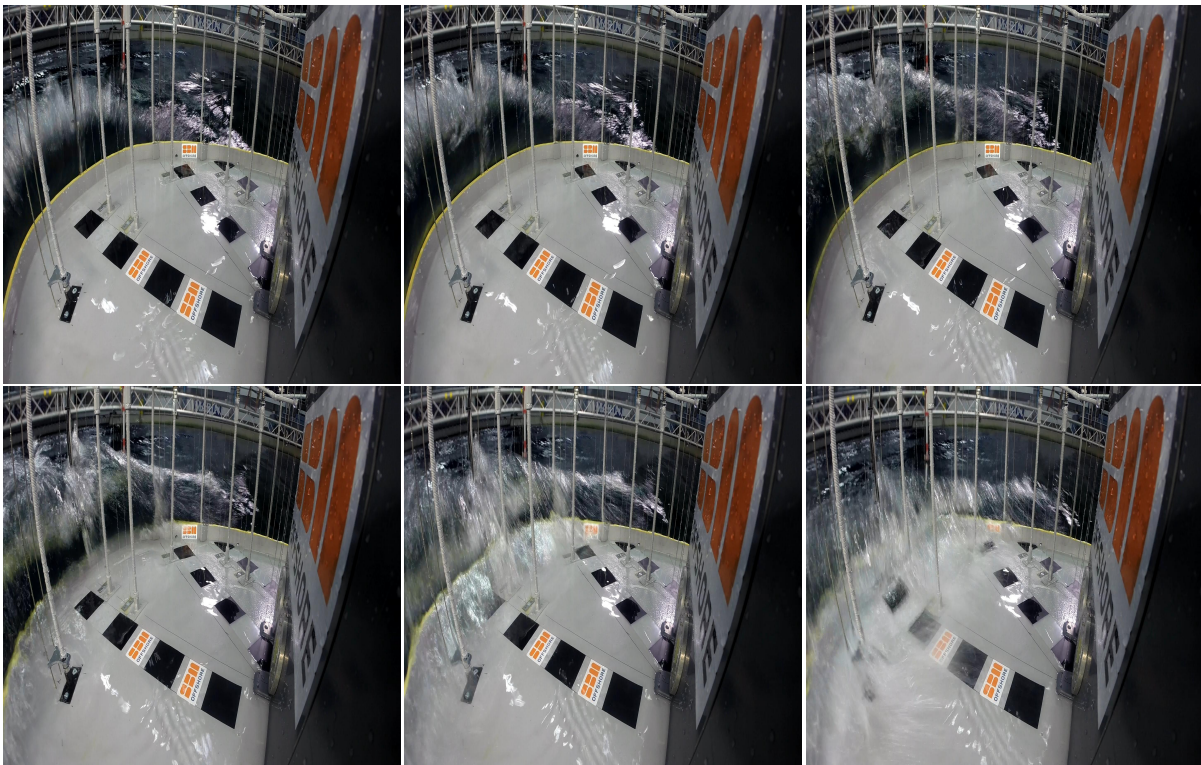


Figure B.16: Plunging Dam Break event S1 seed 3

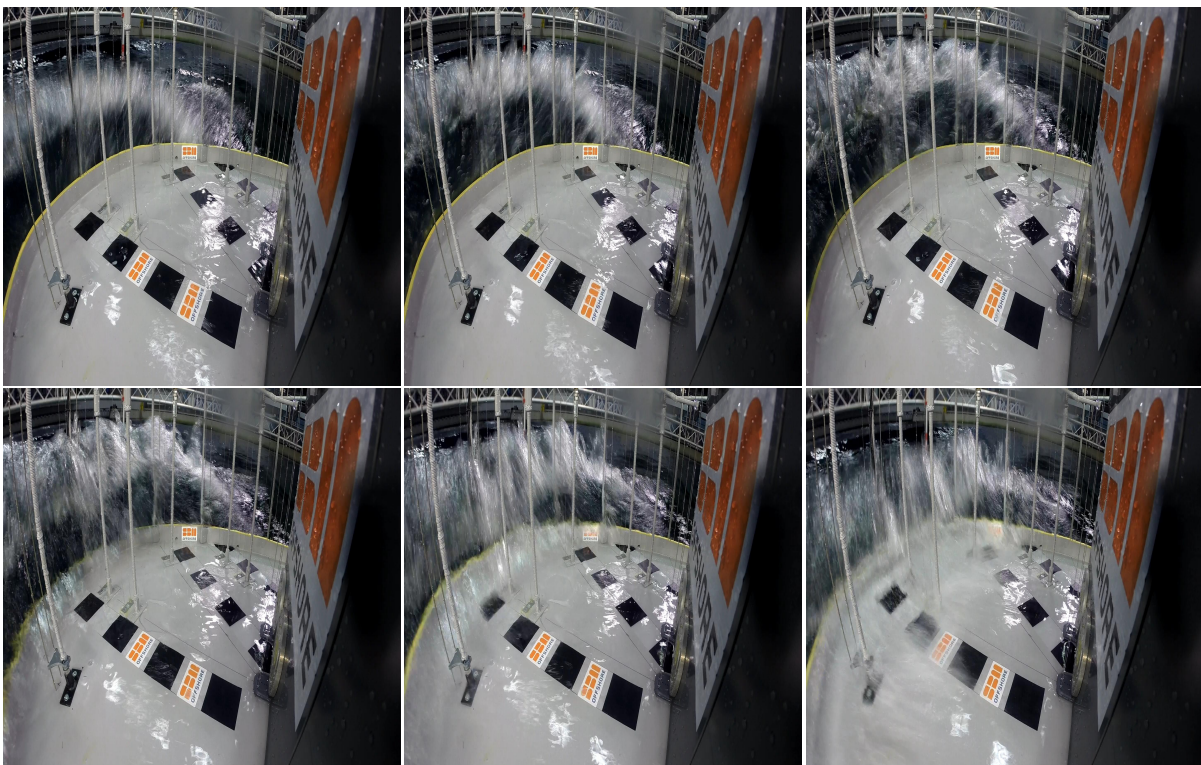


Figure B.17: Plunging Dam Break event S1 seed 3

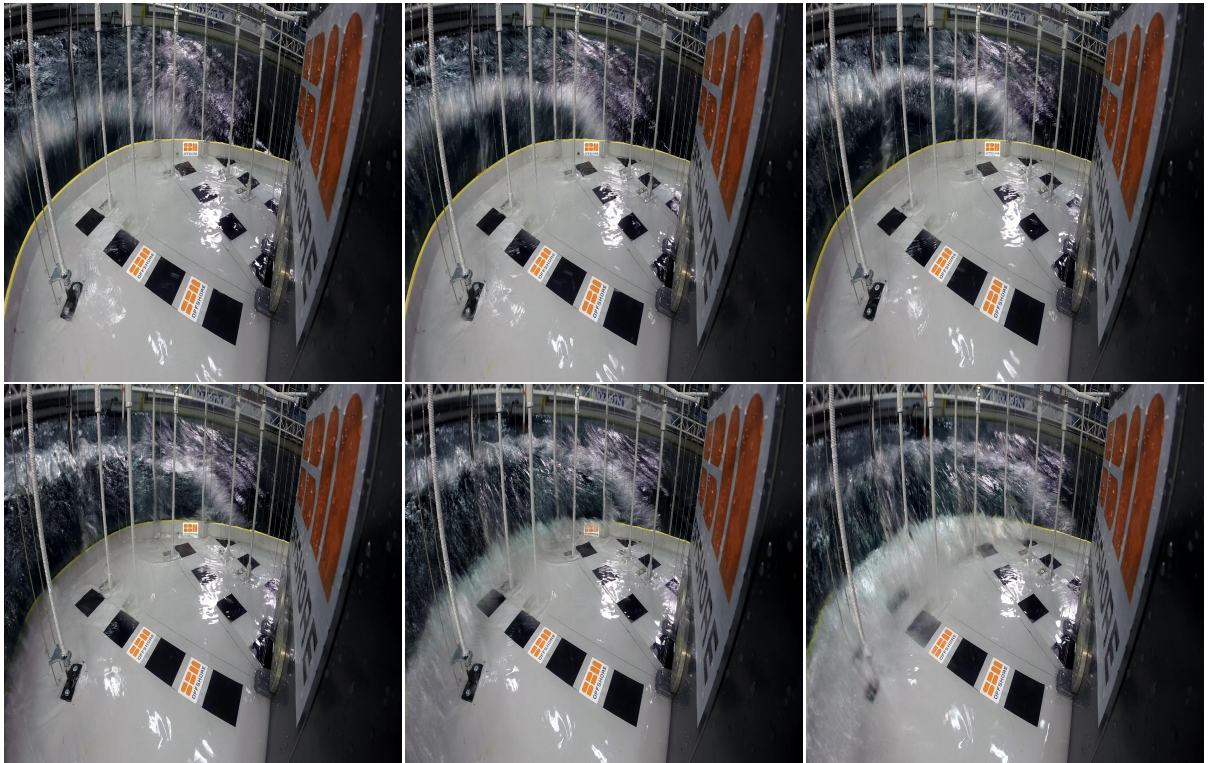


Figure B.18: Plunging Dam Break event S2 seed 1

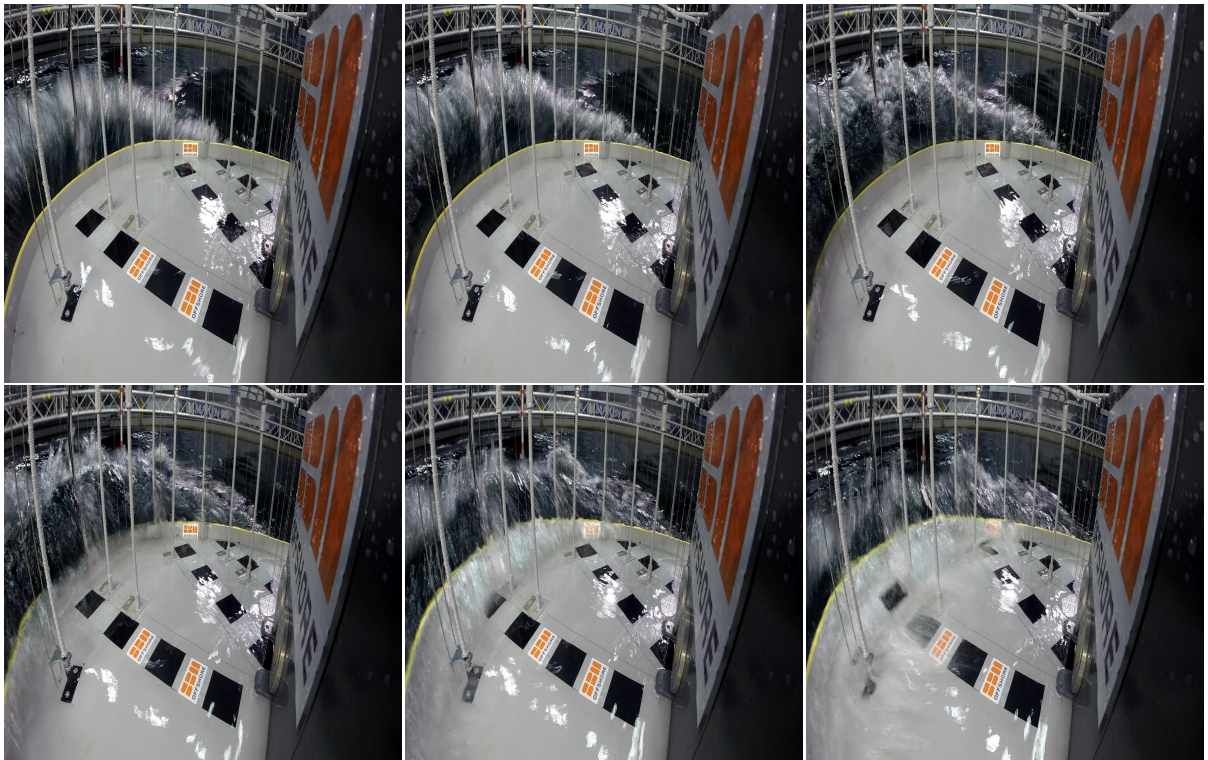


Figure B.19: Plunging Dam Break event S2 seed 1

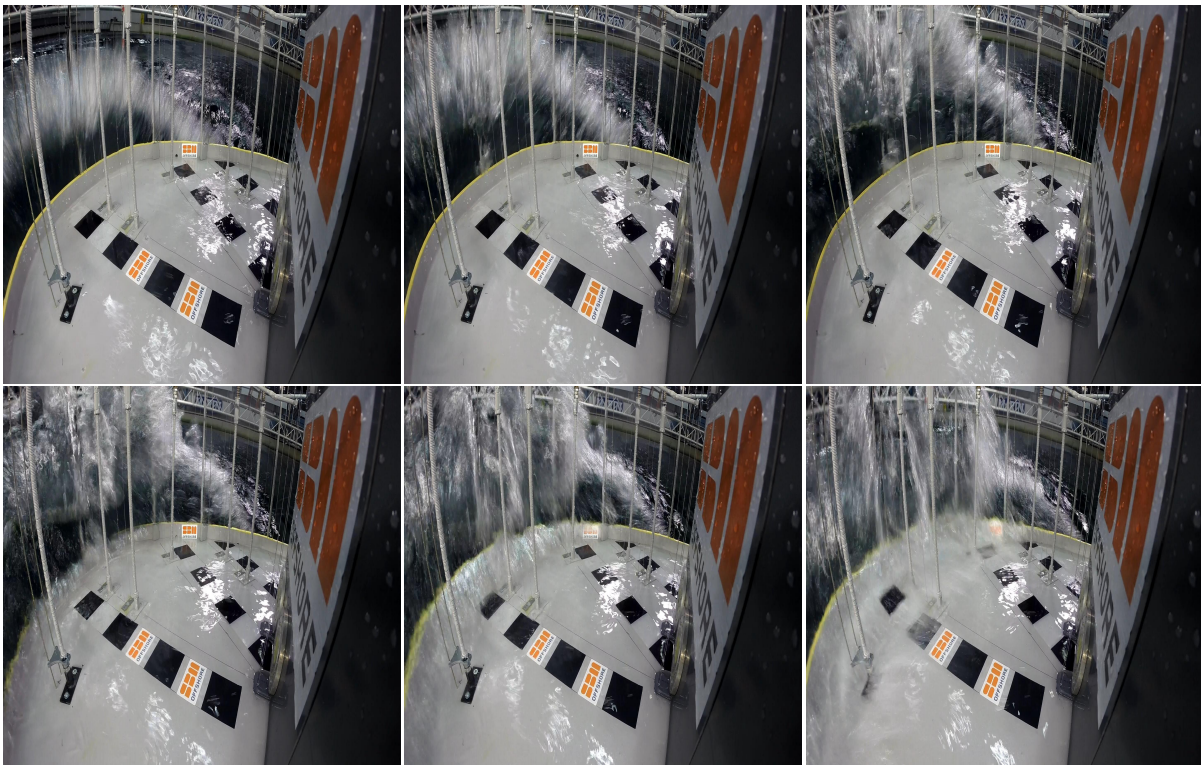


Figure B.20: Plunging Dam Break event S3 seed 1

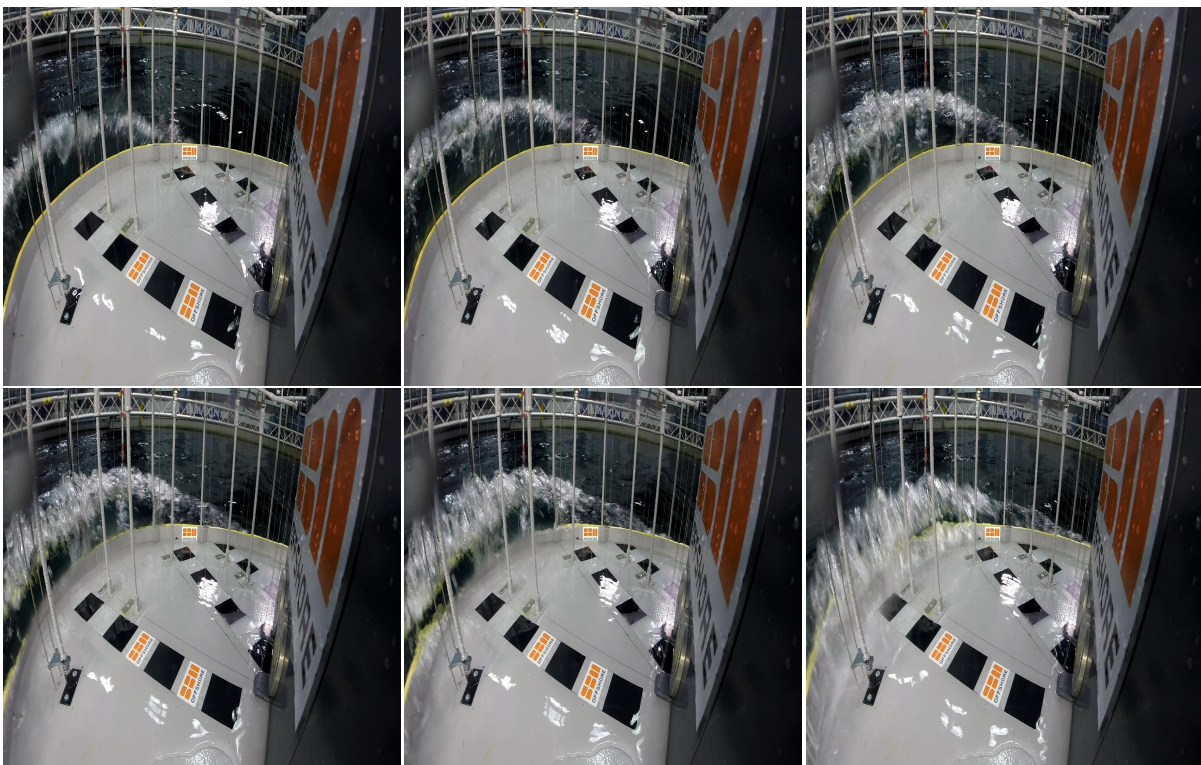


Figure B.21: Plunging Dam Break event S3 seed 2

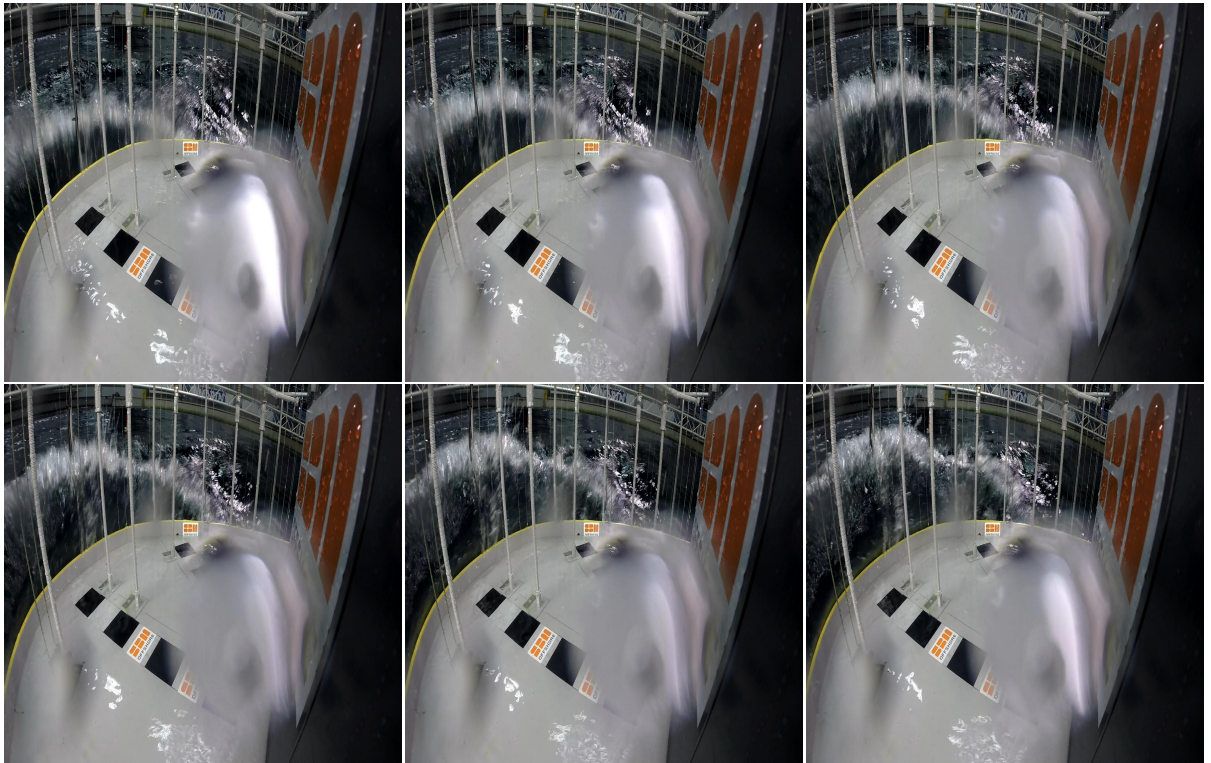


Figure B.22: Plunging Dam Break event S4 seed 1

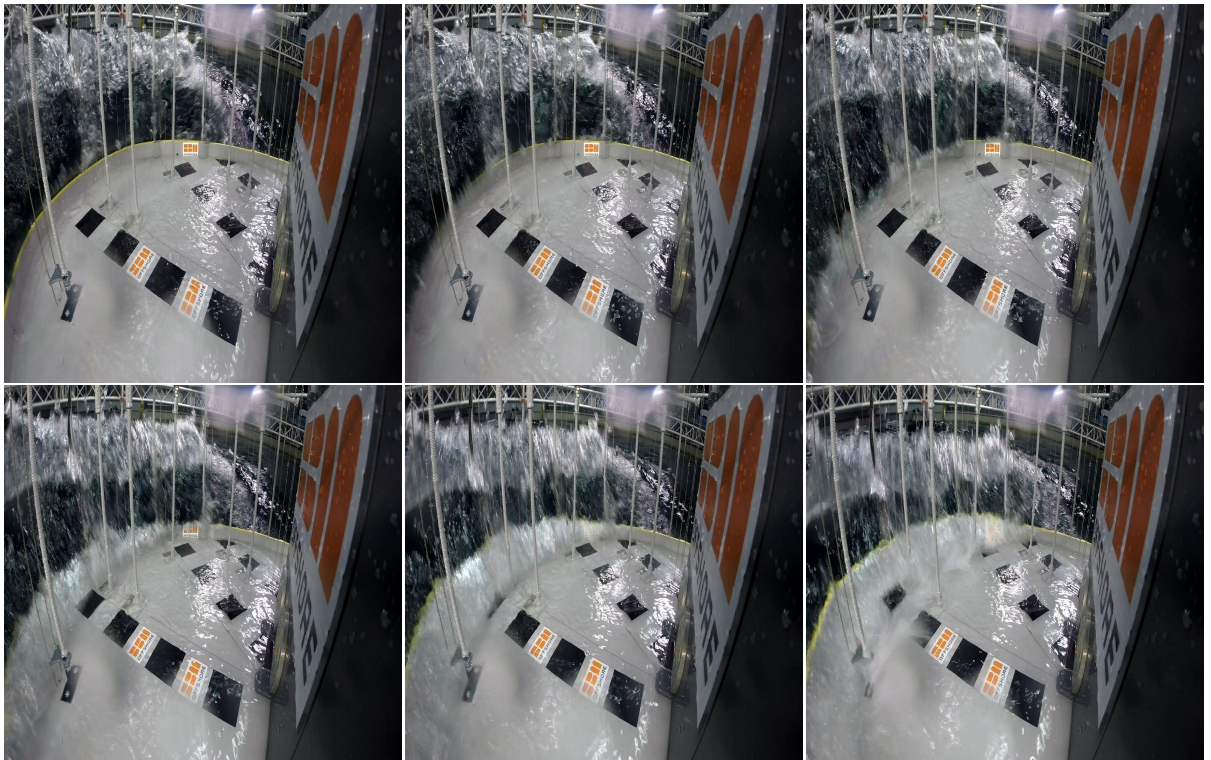


Figure B.23: Plunging Dam Break event S4 seed 2

B.3. Hammer Fist event

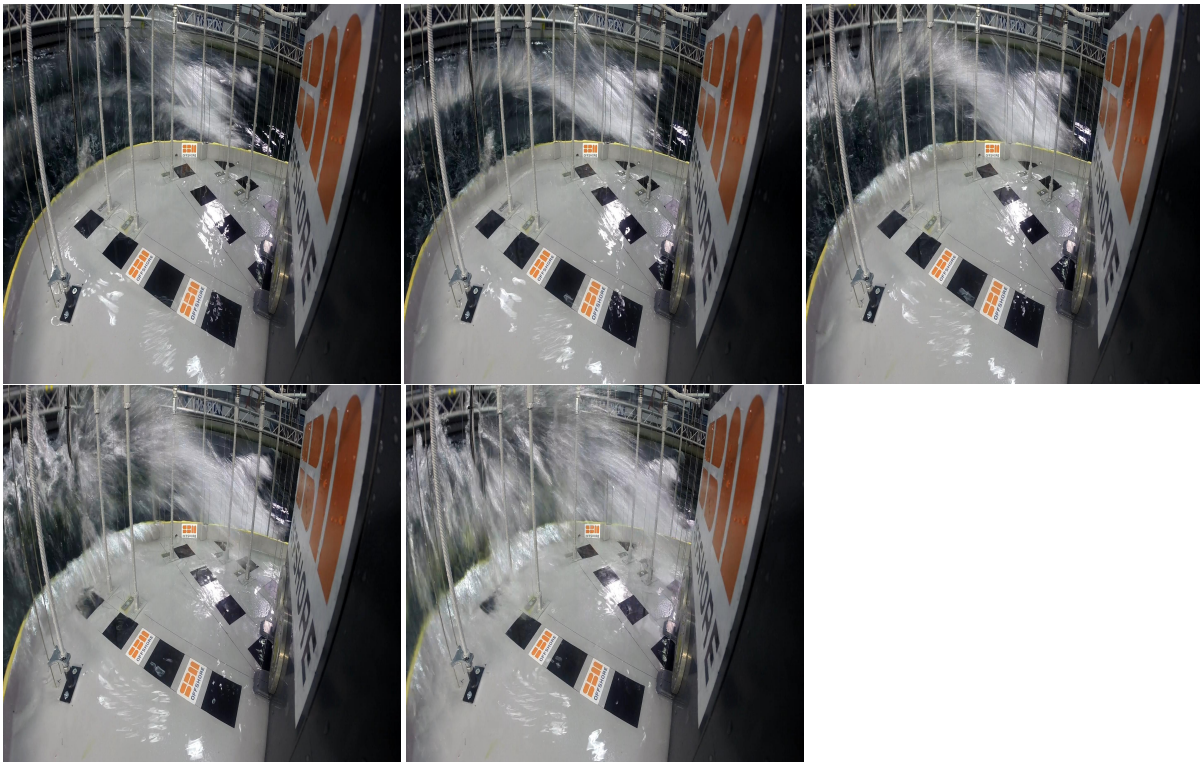


Figure B.24: Hammer Fist event S1 seed 1

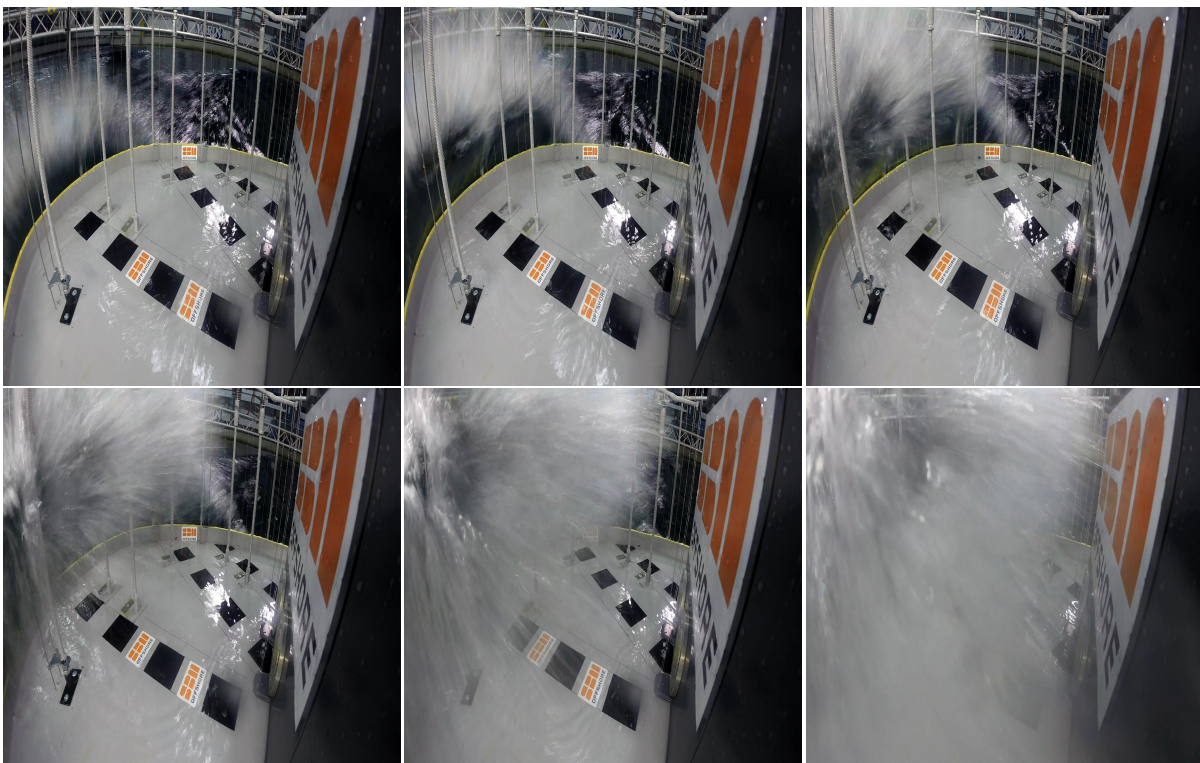


Figure B.25: Hammer Fist event S1 seed 1

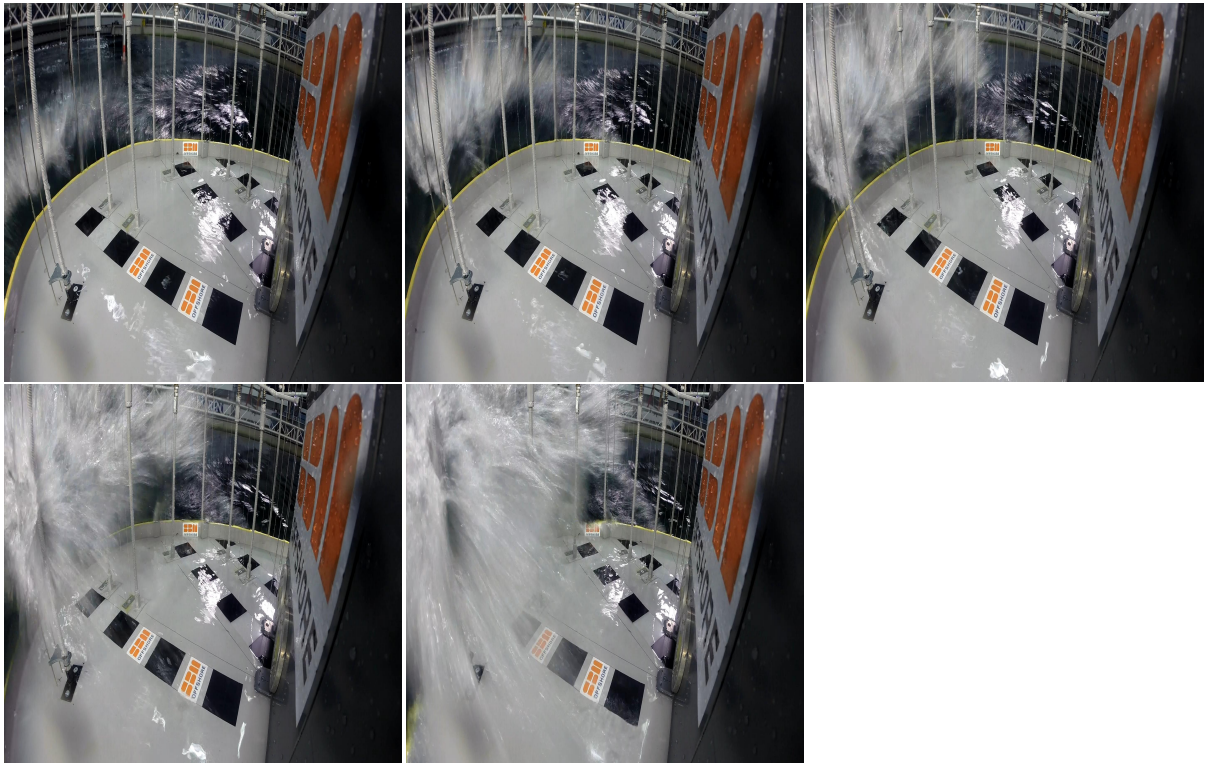


Figure B.26: Hammer Fist event S1 seed 2

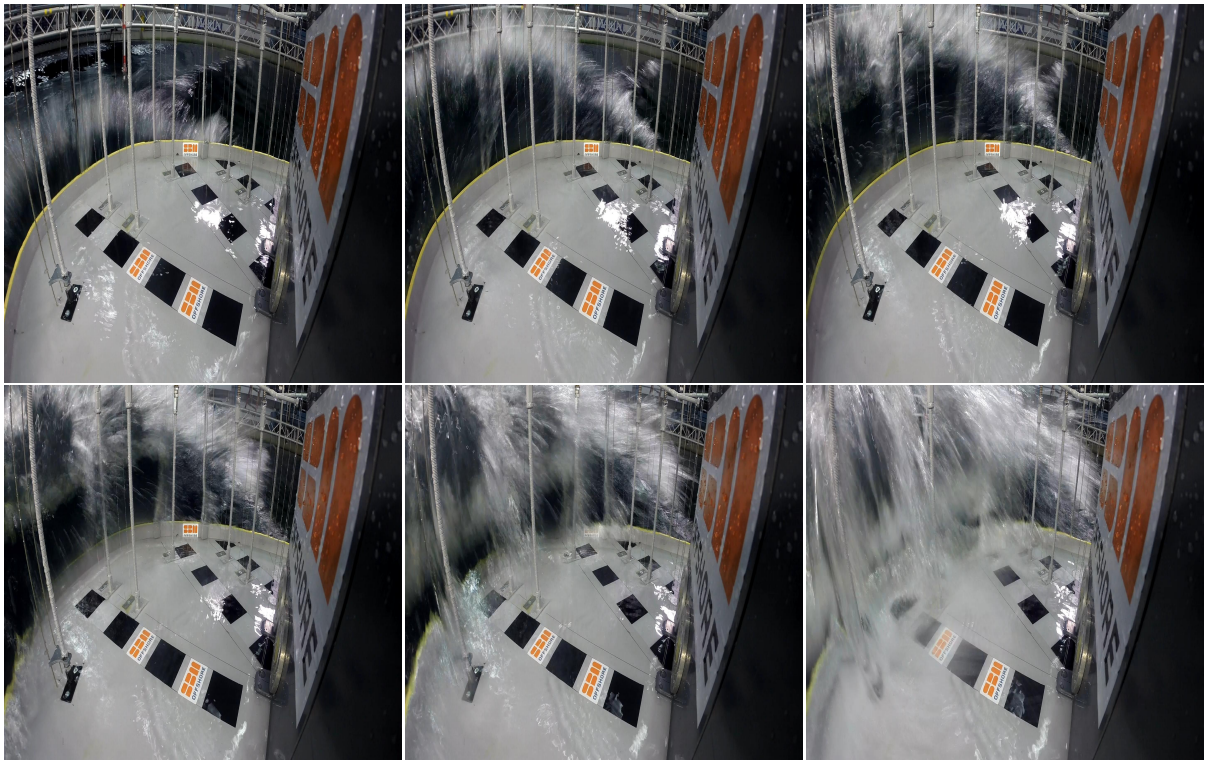


Figure B.27: Hammer Fist event S2 seed 1

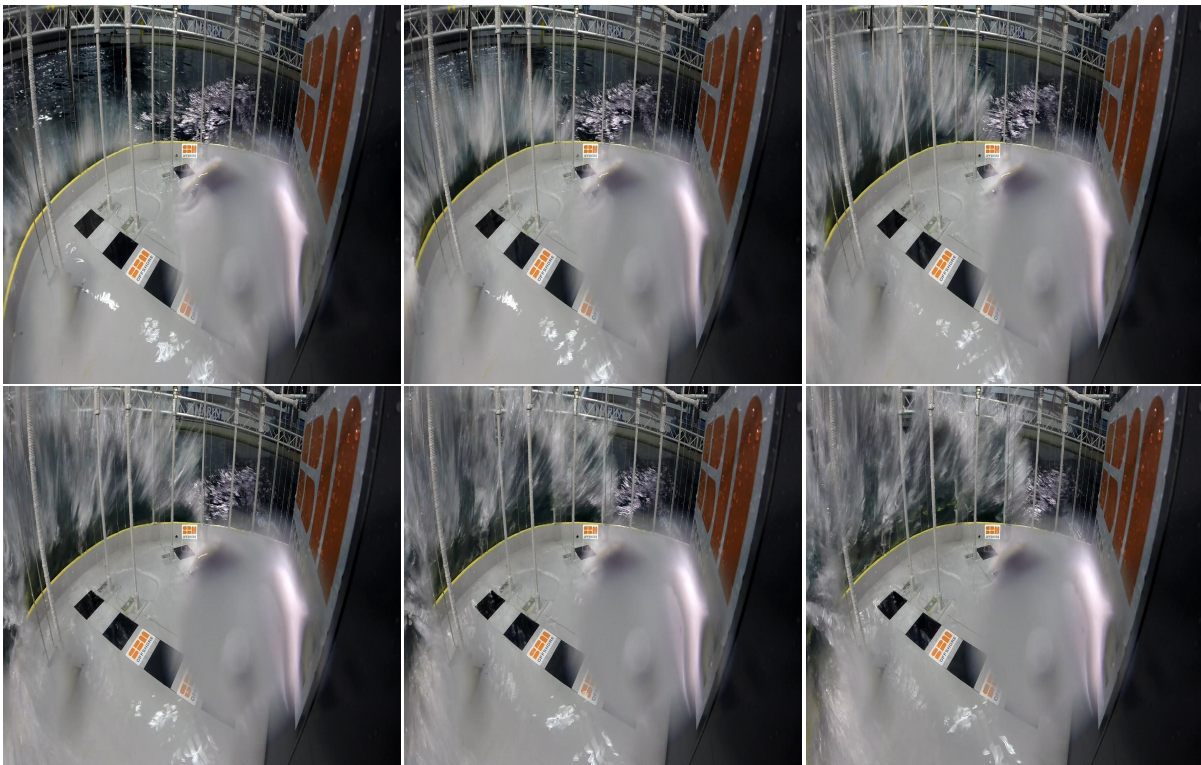


Figure B.28: Hammer Fist event S4 seed 1

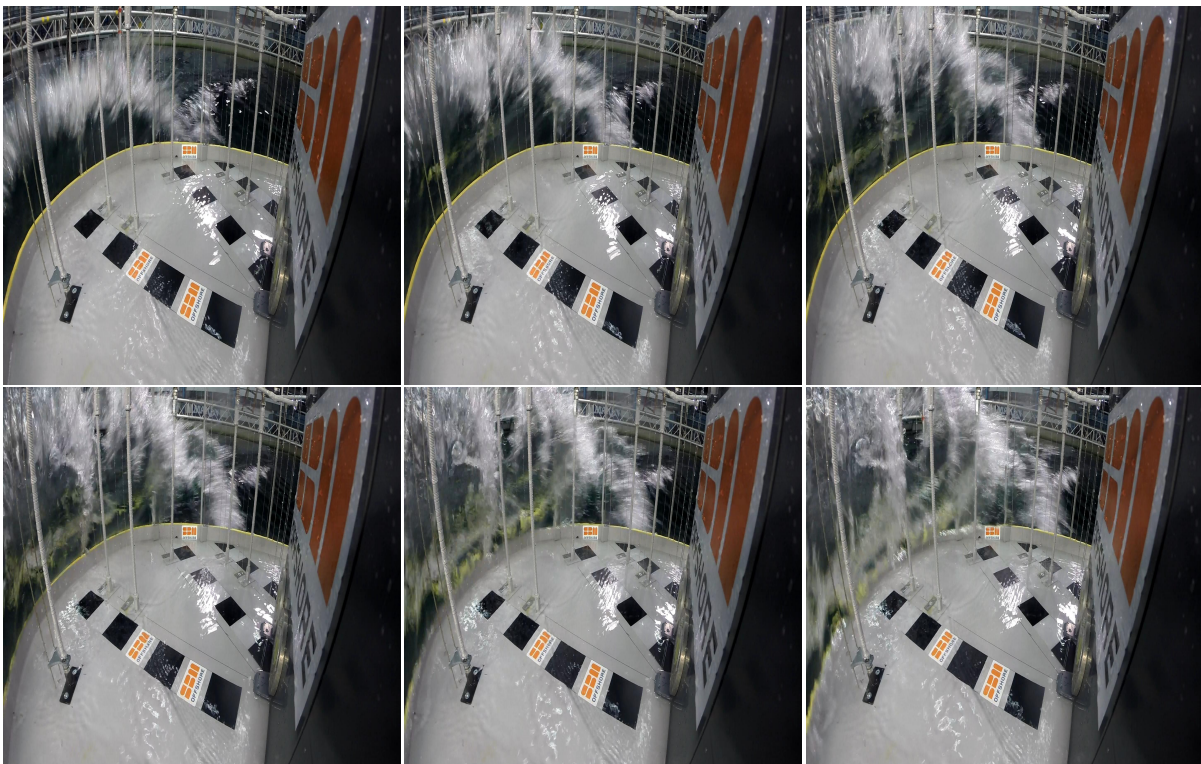


Figure B.29: Hammer Fist event S4 seed 1

C

Appendix C

C.1. Sea state description

To be able to determine design values for an FPSO and to create representative model test conditions, the characteristics of the sea the vessel will operate have to be known. The distribution of energy with the frequency of a certain sea (sea state spectrum) is described using a JONSWAP spectrum (see equation C.1 and figure C.1), which is a modification to the Pierson-Moskowitz spectrum [Holthuijsen \[2008\]](#).

$$E_{JONSWAP}(f) = \alpha \cdot g^2 (2\pi)^{-4} f^{-5} \cdot \exp\left[-\frac{5}{4} \cdot \left(\frac{f}{f_{peak}}\right)^{-4}\right] \cdot \gamma^r \quad (C.1)$$

with peak-enhancement factor γ^r :

$$r = \exp\left[-\frac{1}{2} \left(\frac{f/f_{peak} - 1}{\sigma}\right)^2\right]$$

In which α is the energy scale parameter, f_{peak} is the peak frequency and γ & σ are shape parameters, with σ representing a different value when $f > f_{peak}$ and when $f < f_{peak}$.

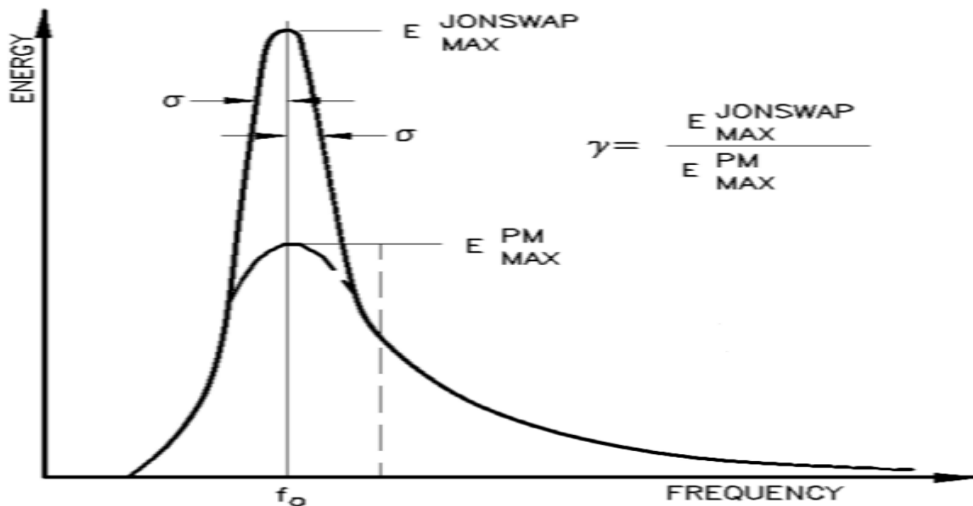


Figure C.1: JONSWAP and Pierson-Moskowitz spectrum as defined in [Journée and Massie \[2001\]](#)

Both spectra are dependent on waves generated by the wind (fetch length). While in the Pierson-Moskowitz spectrum it is assumed that sea states can fully develop and the wind reaches an equilibrium with the wave velocity, the JONSWAP spectrum measured a steeper distribution and stated that a sea state can never fully develop. The peak enhancement factor that was proposed is an important characterisation of a sea state,

which is also used to define model test conditions. The characterisation of a sea state spectrum can be defined by its significant wave height (H_s), wave period (T_p), the peak enhancement (γ) and significant wave steepness (S) based on the H_s and T_p . The chance that a certain wave height in such a sea state is reached or overtops is usually determined in once in 100, 1000 and 10.000 years, depending on the safety factor used.

C.2. Numerical models used

Quite some numerical software tools exist to predict and model the wave-vessel interaction. Trying to describe green water events numerically is quite a complex task due to the described non-linearity's of the interacting elements. Most applicable (and used in research) to the green water problem is the GreenLAB software. Due to the GreenLAB software calculations being based on Dam-break theory, it still needs some development to accurately predict the amount of water on deck and with what velocity it travels. For that reason the software could be used as a "validation" of the Dam-break classified events and possibly adjusted through results from this research. The governing equations GreenLAB is based on, are brought to question in this research. The Dam-break event proves to be an adequate prediction for most green water events, but certainly not for all.

C.3. Model test based research

C.3.1. SBM model test [2015]

The model test done on which this research will be based is a model in a wave tank anchored with loose springs as to model soft mooring. The angle of the vessel with the waves is directed head on (180) and 150 degrees with the incoming waves, so the focus of this test lies mainly with the bow of the ship. The bow flare angle is an important part of green water analysis as the amount of freeboard is significantly influenced by this. In this model the flare angle is 40 degrees. The environmental conditions are listed below:

- Three different wave periods with 100 year wave heights and one 10,000 year wave height.
- Long-crested JONSWAP wave spectra and one 100 year short crested condition.
- No current and/or wind is modelled.

C.3.2. Veer and Zuidscherwoude [2012]

In [Veer and Zuidscherwoude \[2012\]](#) a model test is described of a ship shaped model with the aim of investigating green water waves. With a 1:70 scale, the model is 4.48m long. The bow flare of the original tanker is not modified, 43 degrees at centreline. The main goal was to research the probability distributions of the incident wave crest, vessel motions and relative water motions. This is done to be able to predict the height of green water events on deck given a certain free board exceedance. SSW-100 is not a very steep sea state. The process of green water on deck is also described, in its components: the incident wave, the vessel motions, the distribution of relative motions, the amount of water on deck due to freeboard exceedance, and impact of the force the wave exerts on deck. Model tests, linear diffraction theory and CFD are used to study the different components. The classical Dam-break model is applied to estimate the velocity of the wave propagating over the deck. Relative wave height and freeboard exceedance vs WoD prediction is evaluated.



Figure C.2: Spread moored model test with water on deck sensors ([Veer and Zuidscherwoude \[2012\]](#))

C.3.3. Stansberg and Berget [2009]

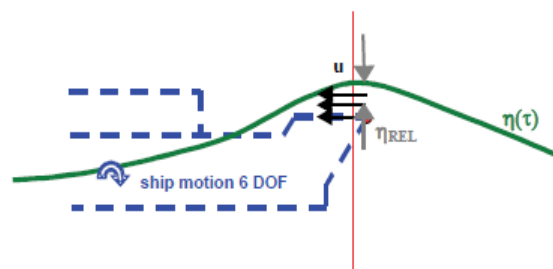
Stansberg and Berget [2009] describe a method to predict green water and its impact in steep irregular waves. The relative wave elevation and kinematics are found from combining ship motions, wave diffraction and nonlinear irregular waves. The resulting water height on deck caused by green water events are estimated by using the classical Dam-break theory. In this research the classical Dam-break theory is modified adjusting the way velocity and water height on deck are determined. The adjustments were made considering assumptions made in the classical Dam-break theory as listed in section 2.2.1. The assumptions in question don't represent the physical characteristics related to green water events but simplify the problem causing inaccuracy in the predictions. The following characteristics have been modified:

- Non-zero initial velocity of the incoming wave.
- Non-static and non-infinite "water reservoir".

As in the model test under consideration, a bulwark is also included, and so the effects of this addition on green water on deck. For illustration of the physical phenomenon under consideration, a time-trace of a wave hitting the bow or overtopping on deck is possible to retrieve from this, as can be seen in fig. C.3. Two different events are highlighted. The first one is a high wall of water is being shipped on to the deck, mainly caused by a high wave crest, but also partly due to a negative pitch angle at the same moment. The second one, a similar event, but the high crest is steeper and the orbital velocity is higher, leading to higher impact loads. The model test set-up includes multiple wave sensors which measure the incident wave in front of the bow. Stansberg and Berget [2009] compared the measured data with calculations done with the WaveLand software.



(a) Photo of a water on deck occurrence



(b) Illustration of a water on deck occurrence

Figure C.3: Model test with multiple relative wave height sensors done by Stansberg and Berget [2009]

C.3.4. Ryu et al. [2007] & Ariyaratne et al. [2009]

The measurement of velocity fields of a plunging wave impacting on a structure in a two-dimensional wave tank was investigated experimentally (Ryu et al. [2005]). A large aerated region was created in front of the structure and on top of the structure after overtopping. The green water on top of the structure is highly aerated containing a large number of bubbles. A modified PIV method, BIV, was introduced by directly using bubbles as the tracer and measuring the bubble velocity by correlating the 'texture' of the bubble images (see figure C.4a). From both the PIV and BIV measurements, it was found that the maximum fluid particle velocity as well as the bubble velocity in front of the structure during the impinging process is about 1.5 times the phase speed of the waves (Ryu et al. [2005]). Ariyaratne et al. [2009] investigated the velocity fields of plunging breaking waves on a three-dimensional ship shaped structure. Two plunging wave conditions were tested and compared: one with waves impinging on the vertical wall of the structure at the initial still water level; the other with waves impacting on the horizontal deck surface. With wave heights and wave periods very similar it was observed that the maximum horizontal velocity is higher for the case with waves compacting on the deck. The waves also passed the deck quicker than the other case. For both cases the profiles of the green water velocity shows a non-linear distribution.

The study investigates, through analysis of laboratory measurements, the practice of applying the classical Dam-break theory to the prediction of overtopping green water on an offshore structure.

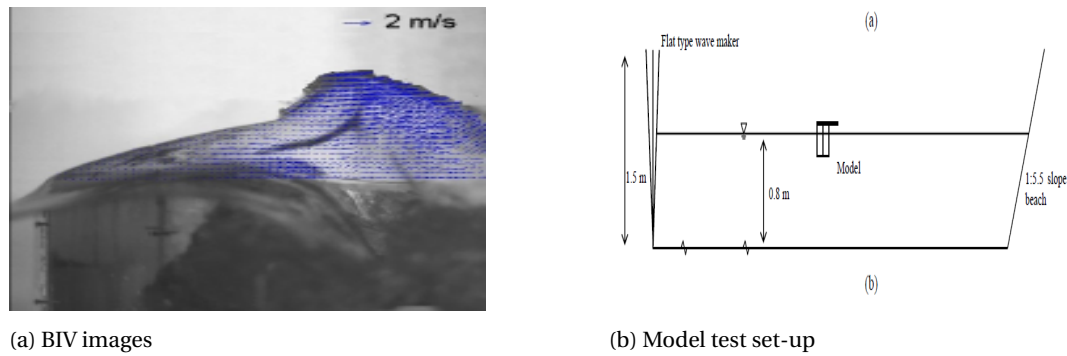


Figure C.4: Model tests done by Ariyaratne et al. [2009]

C.3.5. Ryu and Chang [2008]

In this model test the aim was to investigate the void fraction and velocity of a wave overtopping on deck. The model test set-up is done in a laboratory with a non-ship-shaped and non-floating structure. The flow measured was multi-phased and turbulent. The water flowing on the structure was also significantly aerated. The velocity and the aeration (void fraction) of the water flowing on deck is measured using BIV (see section C.3.4). Two different events of green water were examined; one with waves impinging on the vertical wall, the other one with waves impinging on the horizontal deck (see fig. C.5).

Measurements show that the variations in time and space of the void fraction reveal very high aeration near the front of green water and relatively low aeration in the region near the deck surface. A conclusions drawn from these findings was that the void fraction profile suggests that using only the velocity of the wave may be inaccurate because of the amount of aeration. The accuracy of the void fraction measurement was validated by comparing the directly measured water volume of the overtopping flow with the calculated water volume from the measured velocity and void fraction.

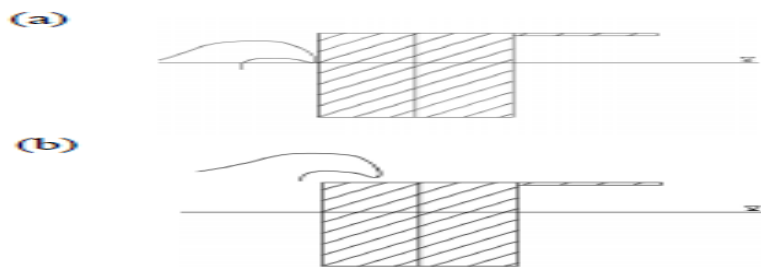


Figure C.5: Horizontal and vertical impinging (Ryu and Chang [2008])

C.3.6. Buchner [2002]

The aim of this research was to determine the different aspects of a green water event. By performing model tests with different hull specifics, Buchner [2002] was able to research the robustness (or lack of robustness) of certain assumptions and theories concerning the effects bow flare angles and hull shapes (narrow vs. broad) have on freeboard exceedance and water flowing on deck. The environmental conditions under consideration were in two categories; regular waves with 17,18m waves and different wave lengths (compared to the ship length) and irregular waves with a significant wave height of 13,5m and a peak period of 12,9 seconds. Compared to the different model studies under consideration in this review, the model tests done by Buchner [2002] are the most similar to the model test under consideration in this research. To be able to use or compare results from the model tests and analysis done, the test conditions should be nearly the same. When the water flow on deck was investigated, the main element was the comparison to the classical Dam-break theory.

C.3.7. Schoenberg and Rainey [2002]

The principle of this model is to examine a ship submerging into a wave or, a wave hitting the side of a ship. As mentioned in 2.2.1, one of the assumptions causing inaccuracy in the Dam-break predictions is the assump-

tion of an infinite wave overtopping on deck. In [Schoenberg and Rainey \[2002\]](#) a way to research this part of the Dam-breaking theory is proposed by modeling a moving 2-Dimensional vertical shelf in (nearly) still water in stead of a vessel with zero initial velocity. According to [Schoenberg and Rainey \[2002\]](#), the unlimited water assumption of the dam-break theory is the main contributor to the inaccuracy. By moving the shelf vertically, the water stream can be cut-off (non-infinite wave), just as happens in a real situation caused by a vessels heave and pitch motions (see fig. C.6). To model this movement realistically, the vertical movement of the shelf is periodical, as the relative motions of the vessel and waves.

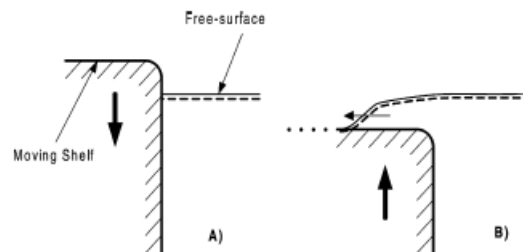


Figure C.6: Moving shelf model test ([Schoenberg and Rainey \[2002\]](#))

C.4. Distributions

The main result sought after researching green water occurrences, is the prediction of the frequency and severity of green water waves for different types of vessels and sea states. In the following chapter a summary of research done on this subject will be given. When researching the green water phenomena, the first step is describing in what types of sea states the vessel is located, which angle the waves hit the vessel and in what sequence waves propagate towards the vessel. So, in order to describe water coming on deck, the different sea-states described in the literature should be evaluated.

The profile of real ocean waves show a significant discrepancy from a Gaussian surface. Real waves have crests that are higher and sharper than waves predicted by a summation of sinusoid's with random phase, and the troughs are shallower and flatter [Forristall \[2000\]](#), this will be further discussed in 2.1.1. Over the years, a number of different distributions trying to model ocean waves have been proposed;

C.4.1. Jahns and Wheeler

This model is based on a non-linear transformation of a Rayleigh distribution. When a wave field doesn't contain a wide range of wave frequencies, i.e. a narrow-banded frequency spectrum, and the surface elevation of the sea is Gaussian distributed, then the wave amplitude statistics will follow the Rayleigh distribution ([Journée and Massie \[2001\]](#)).

$$f(x) = \frac{x}{\sigma^2} \exp\left(-\left(\frac{x}{\sigma\sqrt{2}}\right)^2\right) \quad (\text{C.2})$$

where σ is the standard deviation of the distribution. The transformation [Jahns and Wheeler \[1972\]](#) use, is dependent on the waves crest height normalized by water depth. This distribution has been adjusted after measurements were done. When applied to a situation with infinite water depth, the solution appears wrong, it comes close to the Rayleigh distribution in that case ([Jahns and Wheeler \[1972\]](#)).

C.4.2. Prevosto Model

The Prevosto model is based on a non-linear transformation of a Rayleigh distribution. In this case the transformation is based on the narrow-band Stokes expansion. The two parameters H_s and mean wavenumber are altered to take into account the spectral bandwidth, the directional spreading and the water depth ([Prevosto \[2001\]](#)).

C.4.3. Kriebel and Dawson

The Kriebel and Dawson model is, again, a nonlinear transformation of a Rayleigh distribution. This model is based on the second order regular Stokes wave model in infinite or finite depth. This inverse transformation was first approximated at second order and later, corrected, with a third order expansion. This causes problems in the crest distribution when the steepness is strong. Although the [Kriebel and Dawson \[1991\]](#) models are based on the narrow-band Stokes assumptions, the exact narrow-band Stokes expansion is not used. This

causes errors in the models, except for the infinite depth cases, where harmonic and narrow-band expansion are the same (Kriebel and Dawson [1991]).

C.4.4. Forristal

Instead of the distributions proposed above and the Rayleigh distribution, which is valid for lower sea states, an adjusted distribution is adopted for the higher sea states by most. Forristal [1978] proposes a distribution based on the Weibull distribution. Basically this is a distribution that interpolates between the exponential distribution ($k = 1$) and the Rayleigh distribution ($k = 2$ and $\lambda = \frac{\sqrt{2}}{k}$) (Journée and Massie [2001]). This way the non-linearity of the crests and troughs, are predicted better, which are higher and sharper and the troughs are shallower and flatter than linear models predict. In Veer and Vlasveld [2014] a model test is described where the crests are about 1,5 – 3m higher than linear prediction. In Veer and Vlasveld [2014] it is also found that this distribution holds, until the the 10 percent probability waves, lower probability waves are under-predicted significantly (see fig. C.7).

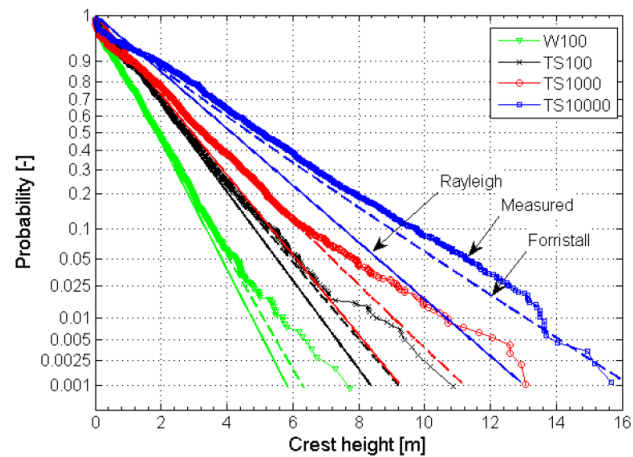


Figure C.7: Empirical crest distributions with associated Rayleigh and Forristal crest distributions (Veer and Vlasveld [2014])