

INFINITE MINING for STRUCTURAL COMPOSITES

P5, Msc Architectural Engineering & Technology
Delft University of Technology

01 / 07 / 2016

Stefanie Tseggai

Tutors:
Job Schroen
Maarten Meijs
Jan Jongert



INTRODUCTION

RESEARCH
material
system

DESIGN
site
building

REFLECTION

INTRODUCTION



Coal debris dump, Lu Guang, WorldPressPhoto, 2015



ENCI Factory, Maastricht, The Netherlands



Staatsmijn Oranje-Nassau, Heerlen, The Netherlands

"DE TOEKOMST VAN PARKSTAD IS GEOPEND"

IBA manifestatie en presentatie Open Oproep. Parkstad, 27 & 28 juni

Beste,

Parkstad werkt aan haar toekomst op een unieke manier: door het organiseren van een Internationale Bau Ausstellung. Met deze IBA wil Parkstad een impuls geven aan economie, ruimte én samenleving. Tot 2020 functioneert IBA Parkstad als laboratorium en is het een motor

How to propose an incentive for new industrial activity in the Parkstad region?

'In nature the **waste** of one process is always a **nutrient**, a material, or a source of energy for another.

Thus the solution not only to the environmental challenges of pollution,
but to the economic challenges of scarcity
may be found in the application of models we can observe in a **natural ecosystem.**'

The Blue Economy, Gunter Pauli, 2010, p. 6

OBJECTIVES

Eliminating the extraction of limited resources

Creating high-end construction material from low-valued wastes

Making a material-based design

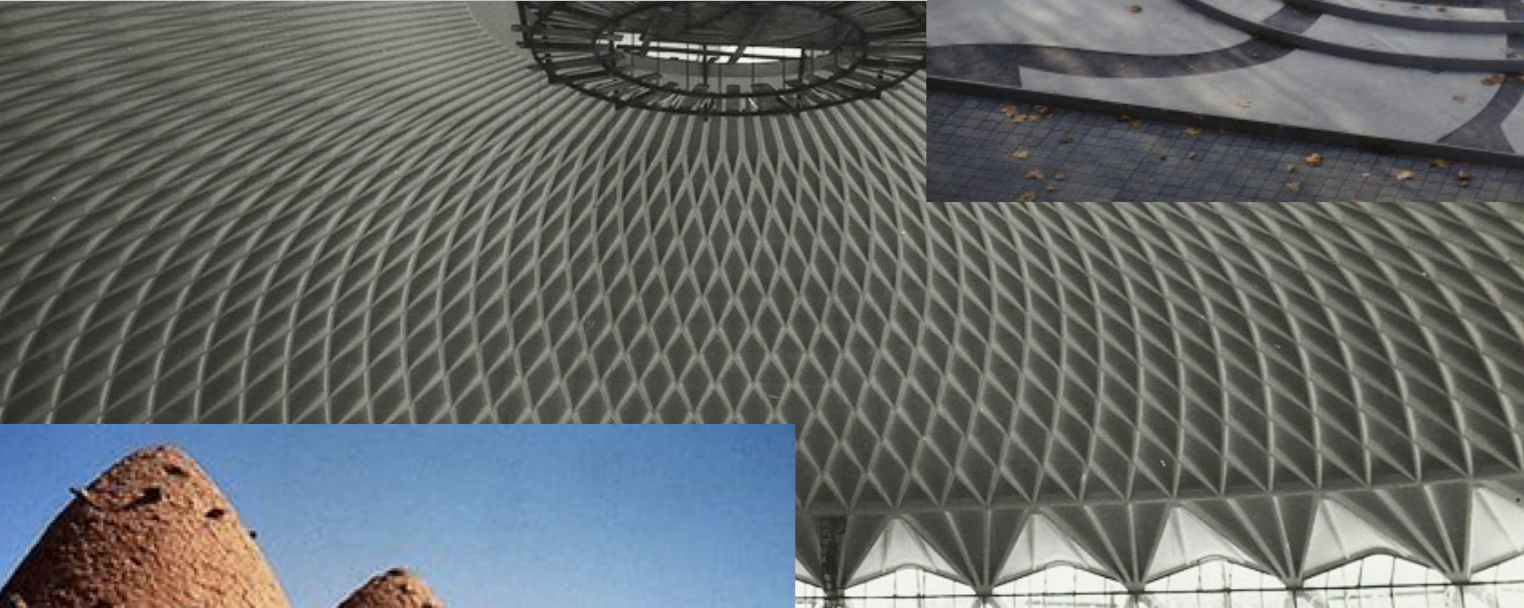
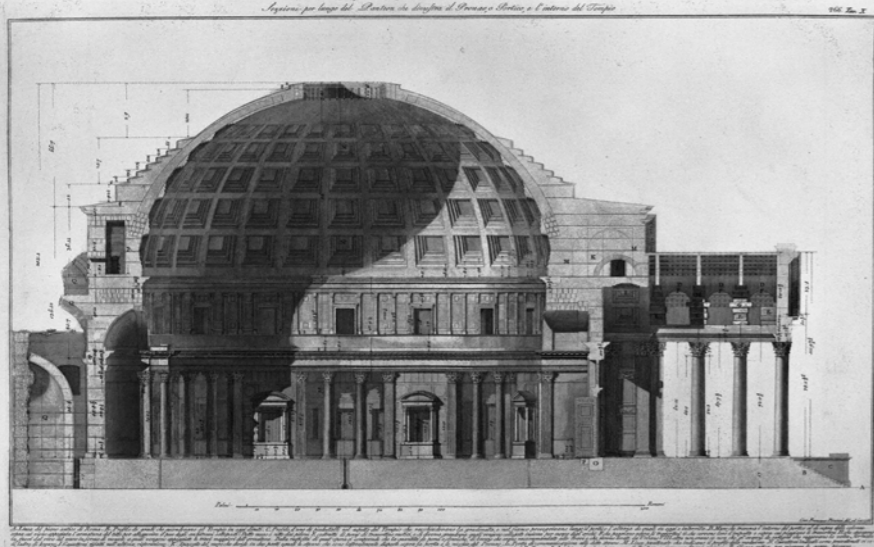

composite /'kompezit; in sense B.5 -zait / a. & n.
In *Archit.* orig. † **-ita**. LME. [Fr., or L *compositus*
pa. pple of *componere*: see COMPOUND v., -ITE.]
A *adj.* **1** *Math.* † **a** Of a number: composed of
more than one digit. **b** Of a number: being the
product of two or more factors greater than
unity; not prime. **2** *Archit.* Designating the fifth
classical order, a compound of Ionic and
Corinthian. **3** *gen.* Made up of various parts or
elements, compound; made of constituents that
remain recognizable. **4** *Biol.* Made up of a number
of separate simple parts or individual organisms;
spec. (Bot.) belonging to or designating the large
plant family Compositae **B** *n.* † **1** *Math.* A number
composed of more than one digit. **2** *Archit.* The
composite order. **3** *gen.* A compound, a composite
thing, a composite material. **4** A composite plant.

(Oxford English Dictionary; on Historical Principles, 1993)

composite /'kompezit; in sense B.5 -zait / a. & n.
In *Archit.* orig. † **-ita**. LME. [Fr., or L *compositus*
pa. pple of *componere*: see COMPOUND v., -ITE.]
A *adj.* **1** *Math.* † **a** Of a number: composed of
more than one digit. **b** Of a number: being the
product of two or more factors **greater than
unity**; not prime. **2** *Archit.* Designating the fifth
classical order, a compound of Ionic and
Corinthian. **3** *gen.* **Made up of various parts or
elements**, compound; made of constituents that
remain recognizable. **4** *Biol.* Made up of a number
of separate simple parts or individual organisms;
spec. (Bot.) belonging to or designating the large
plant family Compositae **B** *n.* † **1** *Math.* A number
composed of more than one digit. **2** *Archit.* The
composite order. **3** *gen.* A compound, a composite
thing, a composite material. **4** A composite plant.

(Oxford English Dictionary; on Historical Principles, 1993)

composite /'kompezit; in sense B.5 -zait / a. & n. In *Archit.* orig. † **-ita**. LME. [Fr., or L *compositus* pa. pple of *componere*: see COMPOUND v., -ITE.]
A *adj.* **1** *Math.* † **a** Of a number: composed of more than one digit. **b** Of a number: being the product of two or more factors **greater than unity**; not prime. **2** *Archit.* Designating the fifth classical order, a compound of Ionic and Corinthian. **3** *gen.* **Made up of various parts or elements**, compound; made of constituents that **remain recognizable**. **4** *Biol.* Made up of a number of separate simple parts or individual organisms; *spec. (Bot.)* belonging to or designating the large plant family Compositae **B** *n.* † **1** *Math.* A number composed of more than one digit. **2** *Archit.* The composite order. **3** *gen.* A compound, a composite thing, a composite material. **4** A composite plant.

(Oxford English Dictionary; on Historical Principles, 1993)

Modern structural composites are mixtures of two or more components: stiff long **fibres** and a **matrix**, which affixes the fibres (Chollakup, Nardin, Smitthipong, 2015, p. 1).

By layering the fibres and matrix in different directions it is possible to **customize** the directional strength and stiffness to the occurring loads (Ibid., p. 2).

Bio-based means derived from biomass.

Biomass consists non-fossilized and biodegradable organic material originating from plants, animals, and micro-organisms (Kabasci & Stevens, 2013, p. 2). It is considered a **renewable resource** as long as its exploitation rate does not exceed its replenishment by natural processes (Ibid.).

composite /'kompezit; in sense B.5 -zait / a. & n. In *Archit.* orig. † **-ita**. LME. [Fr., or L *compositus* pa. pple of *componere*: see COMPOUND v., -ITE.] **A** *adj.* **1** *Math.* † **a** Of a number: composed of more than one digit. **b** Of a number: being the product of two or more factors **greater than unity**; not prime. **2** *Archit.* Designating the fifth classical order, a compound of Ionic and Corinthian. **3** *gen.* **Made up of various parts or elements**, compound; made of constituents that **remain recognizable**. **4** *Biol.* Made up of a number of separate simple parts or individual organisms; *spec. (Bot.)* belonging to or designating the large plant family Compositae **B** *n.* † **1** *Math.* A number composed of more than one digit. **2** *Archit.* The composite order. **3** *gen.* A compound, a composite thing, a composite material. **4** A composite plant.

(Oxford English Dictionary; on Historical Principles, 1993)

Modern structural composites are mixtures of two or more components: stiff long **fibres** and a **matrix**, which affixes the fibres (Chollakup, Nardin, Smitthipong, 2015, p. 1).

By layering the fibres and matrix in different directions it is possible to **customize** the directional strength and stiffness to the occurring loads (Ibid., p. 2).

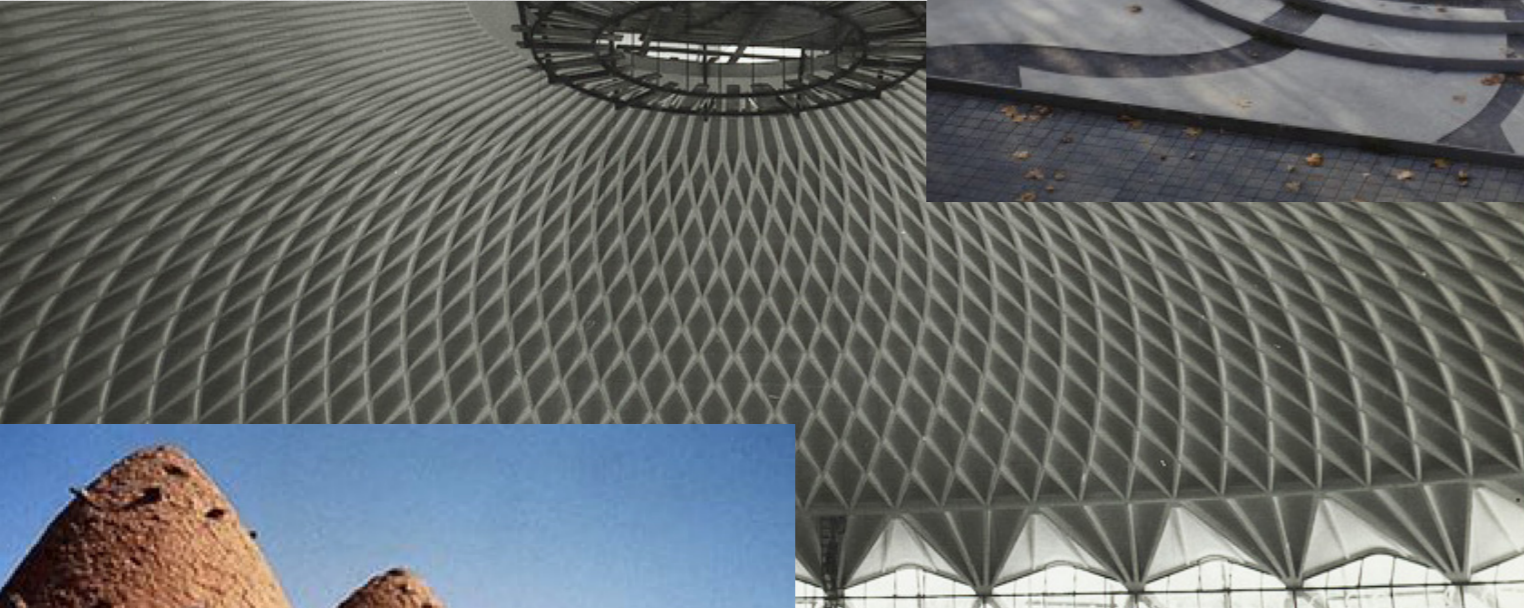
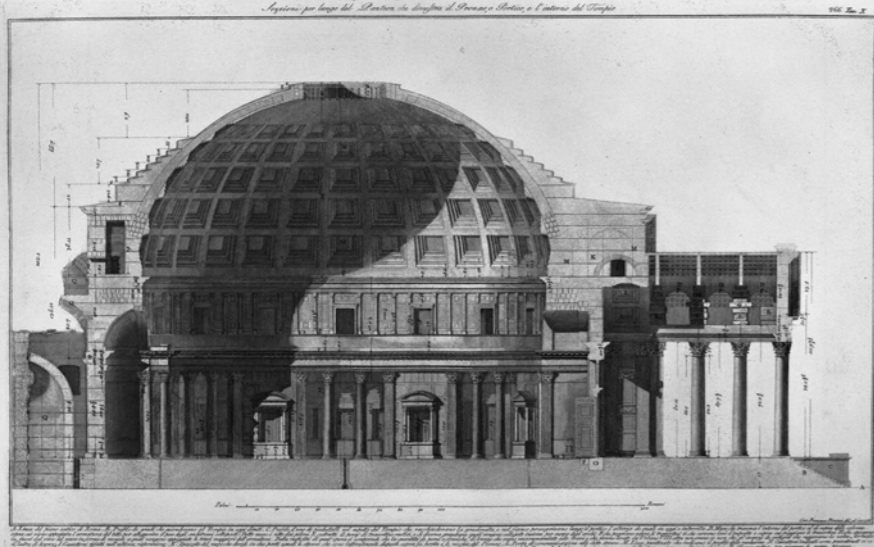

RESEARCH

DESIGN

GOAL

RESEARCH

To set up
the **production system**
of
a structural bio-based composite
from waste

GOAL

DESIGN

RESEARCH

To set up
the **production system**
of
a structural bio-based composite
from waste

Circular, Multipliable, Flexible

Uniform, Consistent, Abundant

GOAL

DESIGN

RESEARCH

To set up
the **production system**
of
a structural bio-based composite
from waste

Circular, Multipliable, Flexible

Uniform, Consistent, Abundant

GOAL

DESIGN

To design
an **'infinite mine'**
for
the composite
in Parkstad

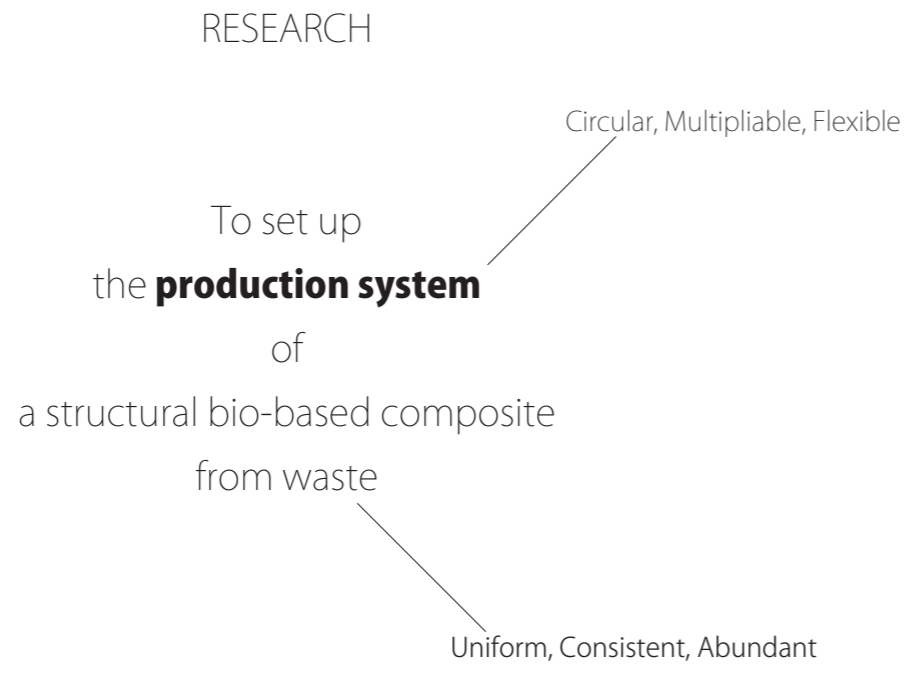

GOAL

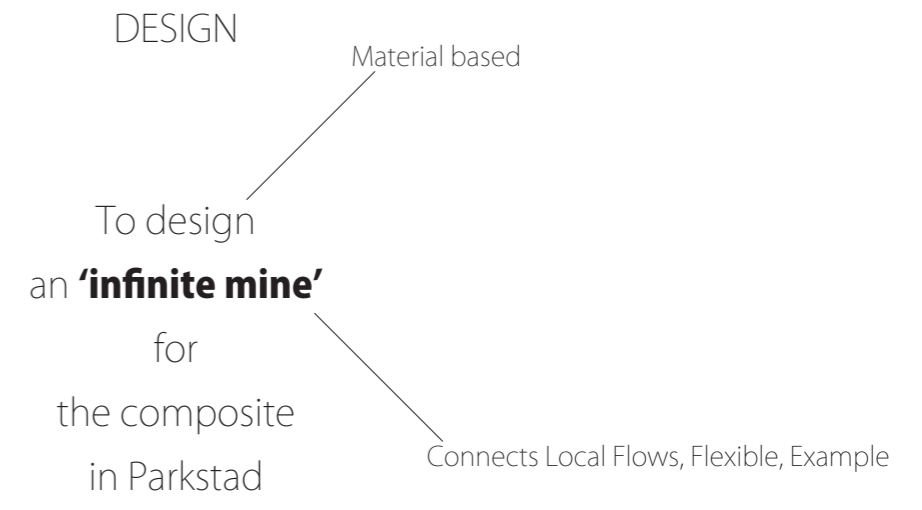

RESEARCH



Alginate Like Exopolysaccharide (ALE)
Nereda waste water treatment

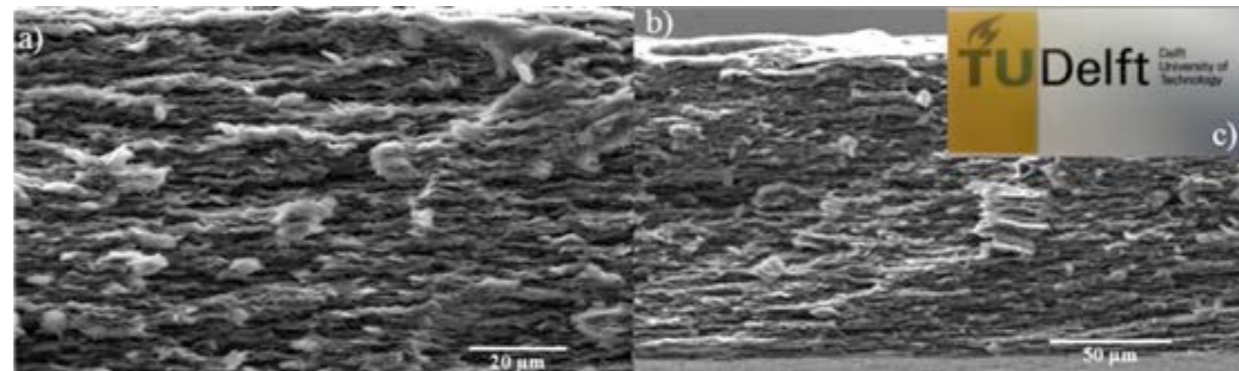
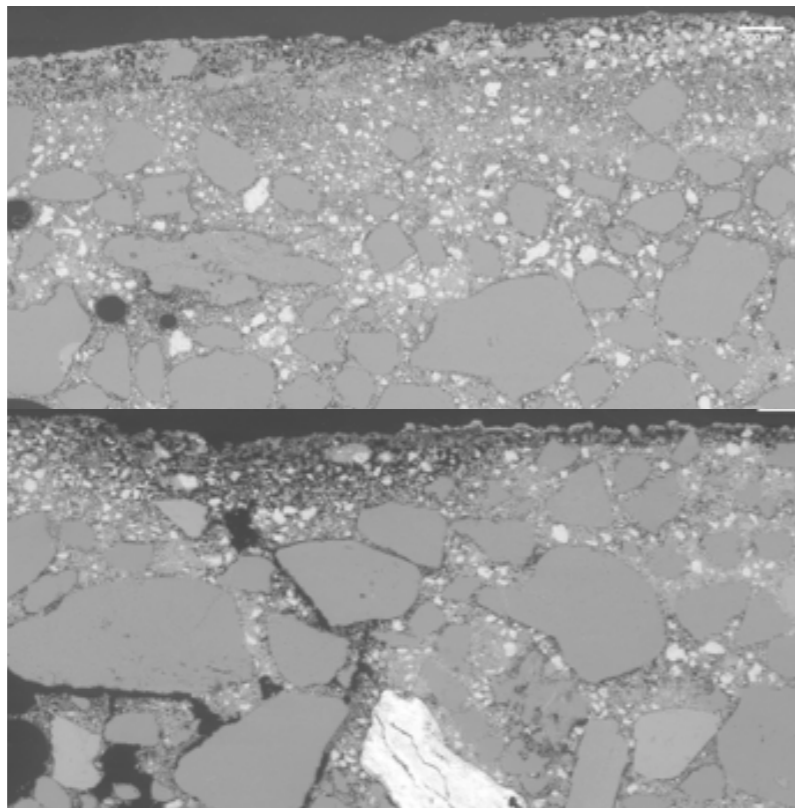
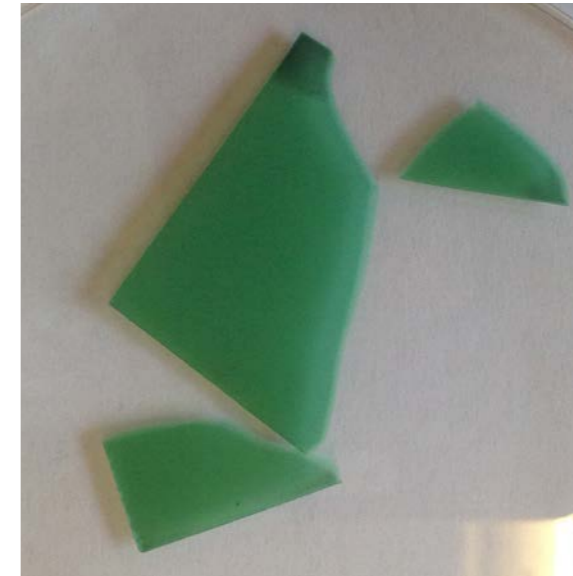
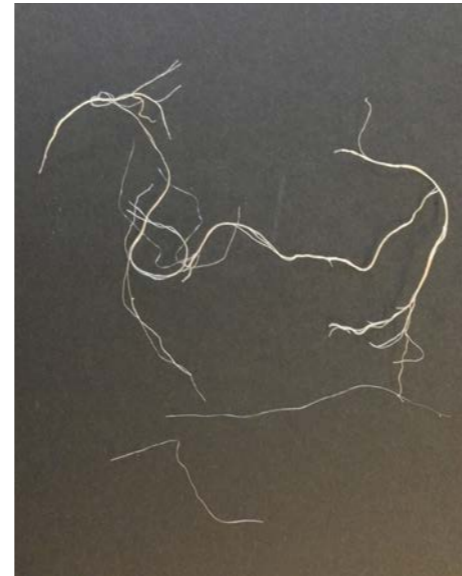

Applications of ALE

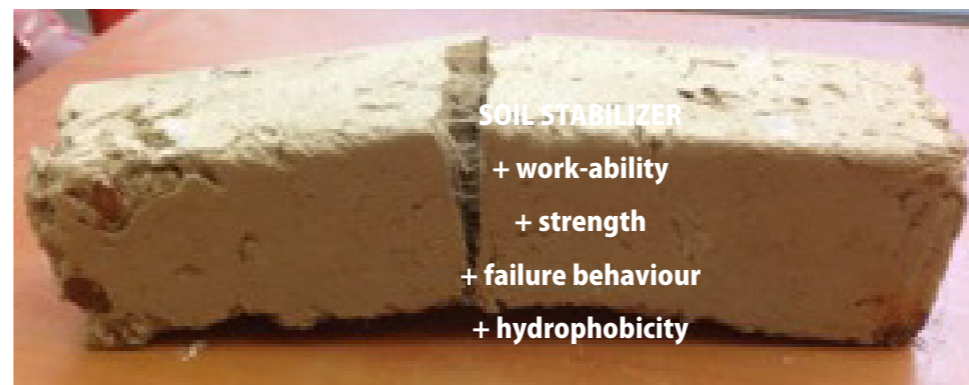
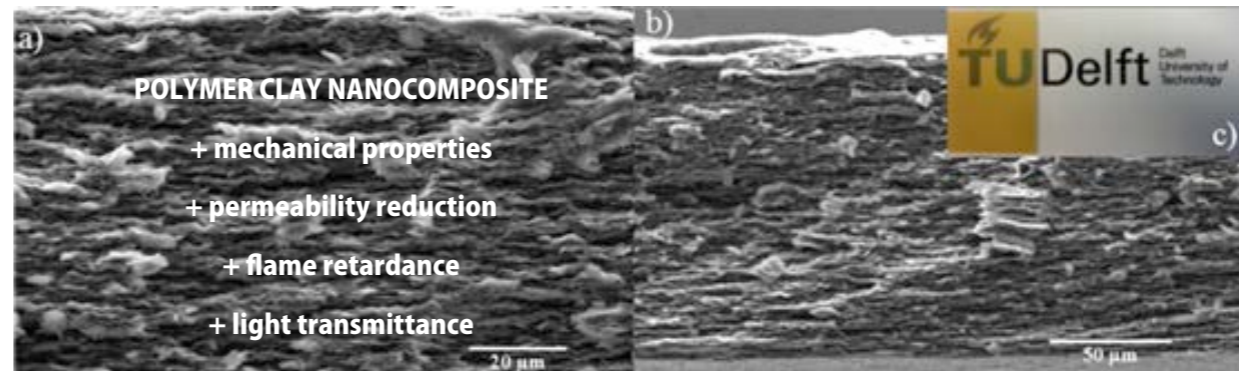
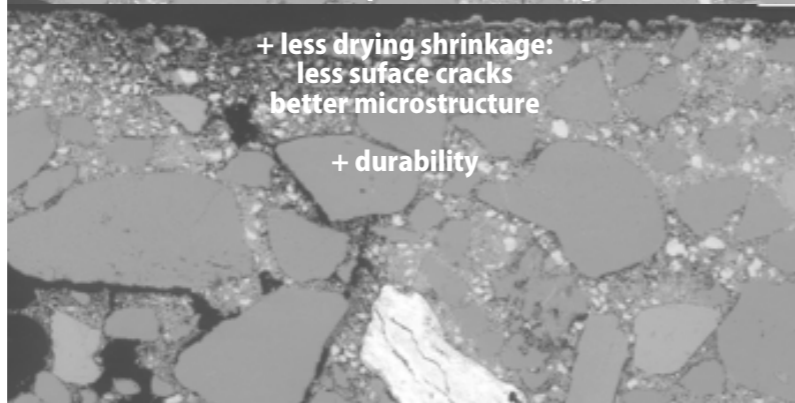
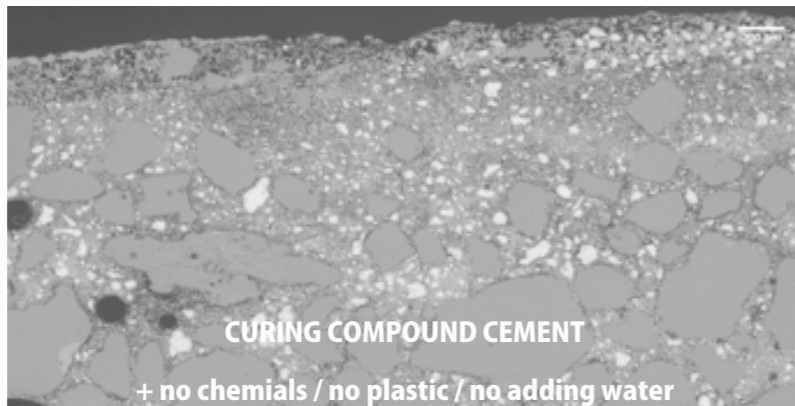
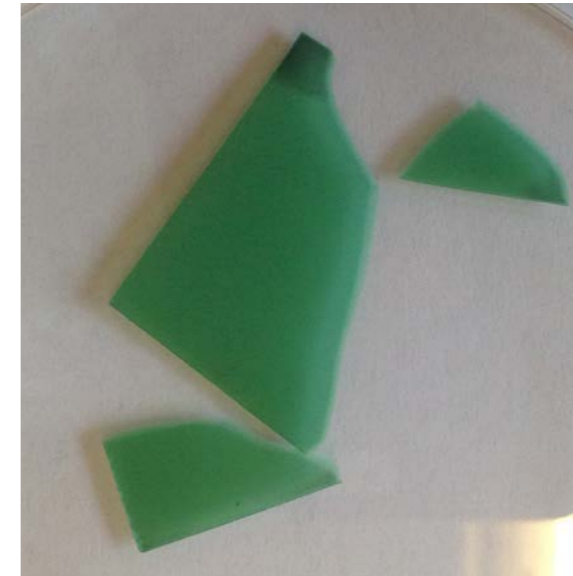
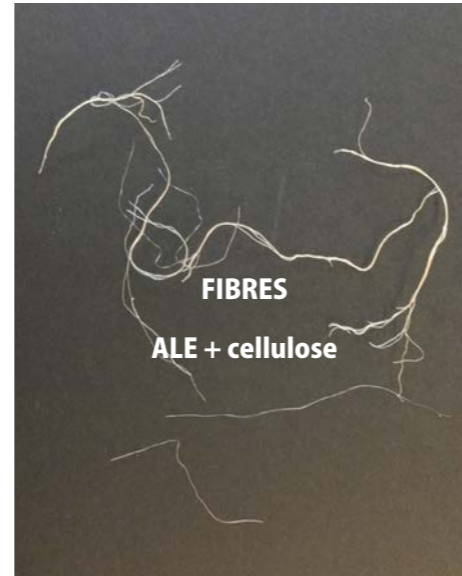



water 400 ml + abaca fibres 12 g + loam 2000 g + ALE 14 g
 sand 35% + silt 45% + clay 20%

→ mix & mould & dry (2days)

bricks

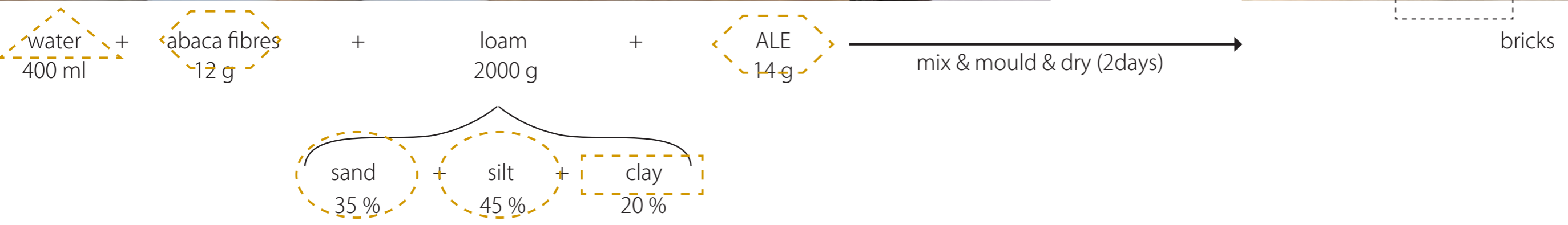

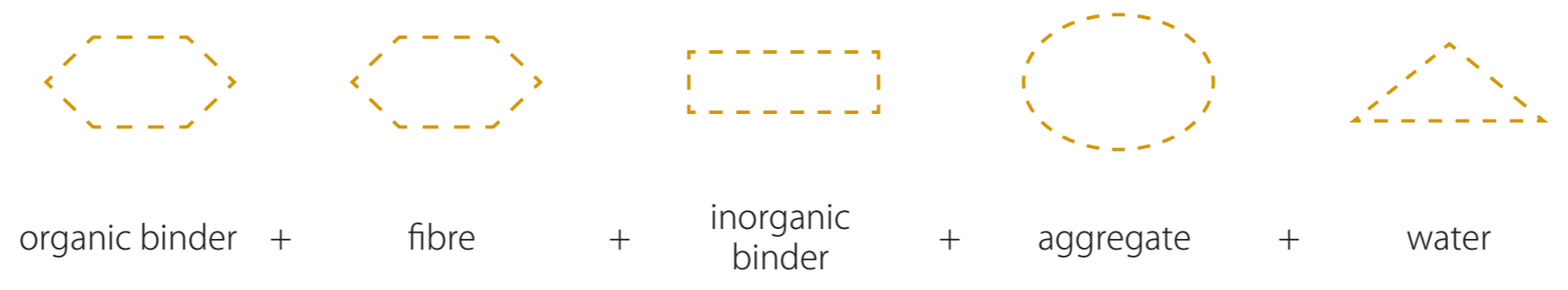

Components of new composite



ALE

+



fibre

+



inorganic
binder

+



aggregate

+



water

Components of new composite



ALE

+



ALE-cellulose

+



inorganic
binder

+



aggregate

+



water

Components of new composite



ALE

+



ALE-cellulose

+



Bio-Cement

+



aggregate

+



water

Components of new composite



ALE

+



ALE-cellulose

+



Bio-Cement

+



biomass ash

+



water

Components of new composite



ALE

+



ALE-cellulose

+



Bio-Cement

+



biomass ash

+



effluent

Components of new composite



ALE

+



ALE-cellulose

+



Bio-Cement

+



biomass ash

+



effluent

Components of new composite

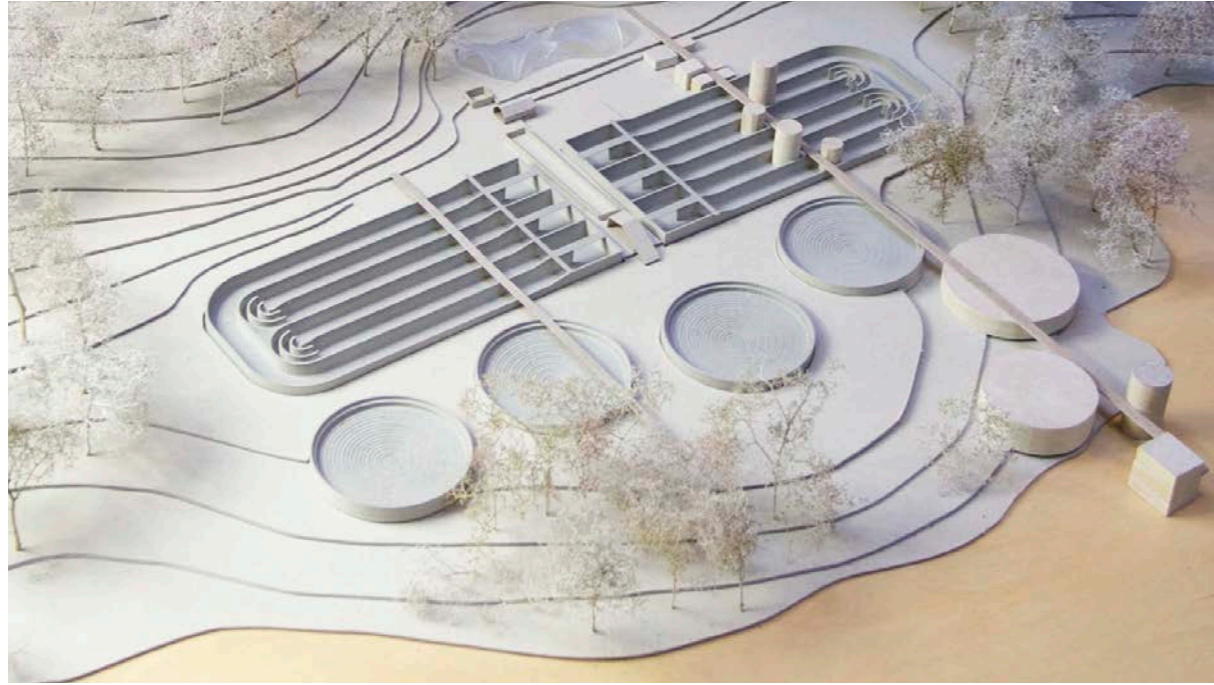

WWTP KERKRADE = INFINITE MINE

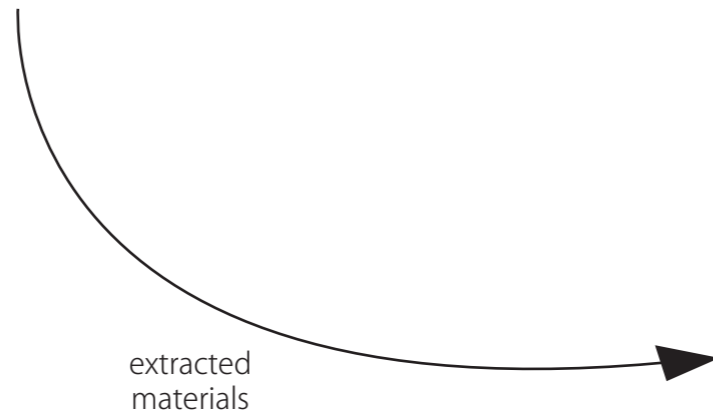
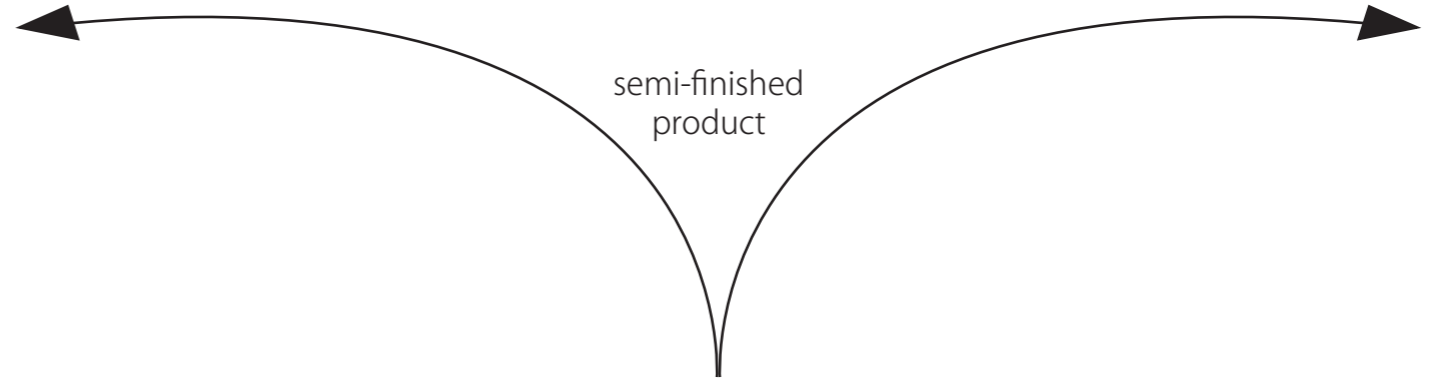

ENCI = COMPOSITE FACTORY

DESIGN

AMBITIONS

Material-based

Connect Local Flows

Room for exploration & change

Example

DESIGN
site



MONDE VERDE

CASTLE

MEGA LAND
(PINK POP)

CASTLE

SNOW WORLD

ESTATE

INDUSTRIAL
PARK

FARMSTEAD

FARMSTEAD

CASTLE

GAIA ZOO

Kerkrade

1000 m

Image © 2015 GeoContent

Google earth









FORM = FUNCTIONAL

COMPOSITION = PRAGMATIC

ANTI-ARCHITECTURE



LAKE CRANENWEYER

SEDIMENTATION TANKS

AERATION TANK

AERATION TANK

FILTERS

MAIN BUILDING



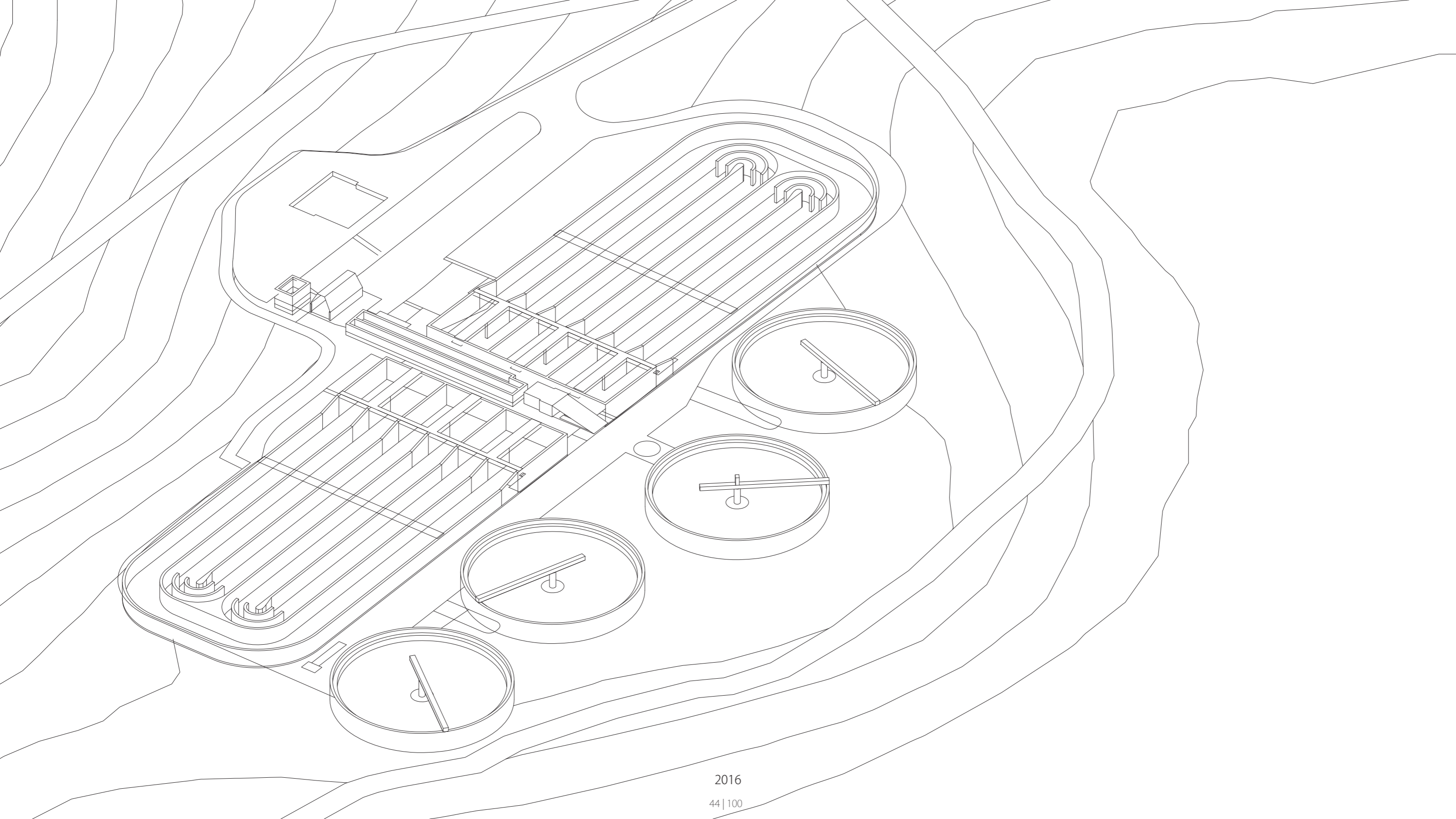

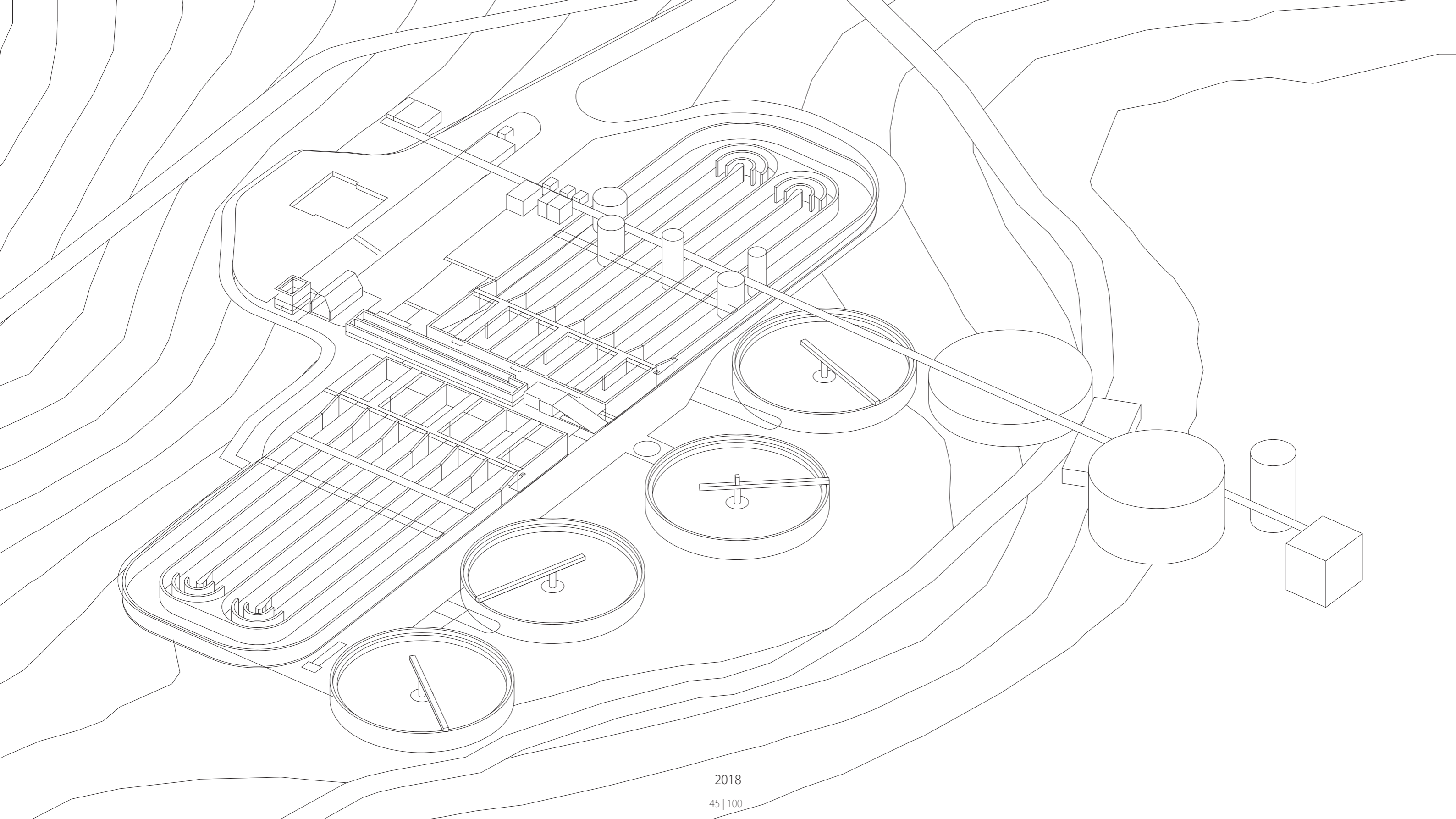

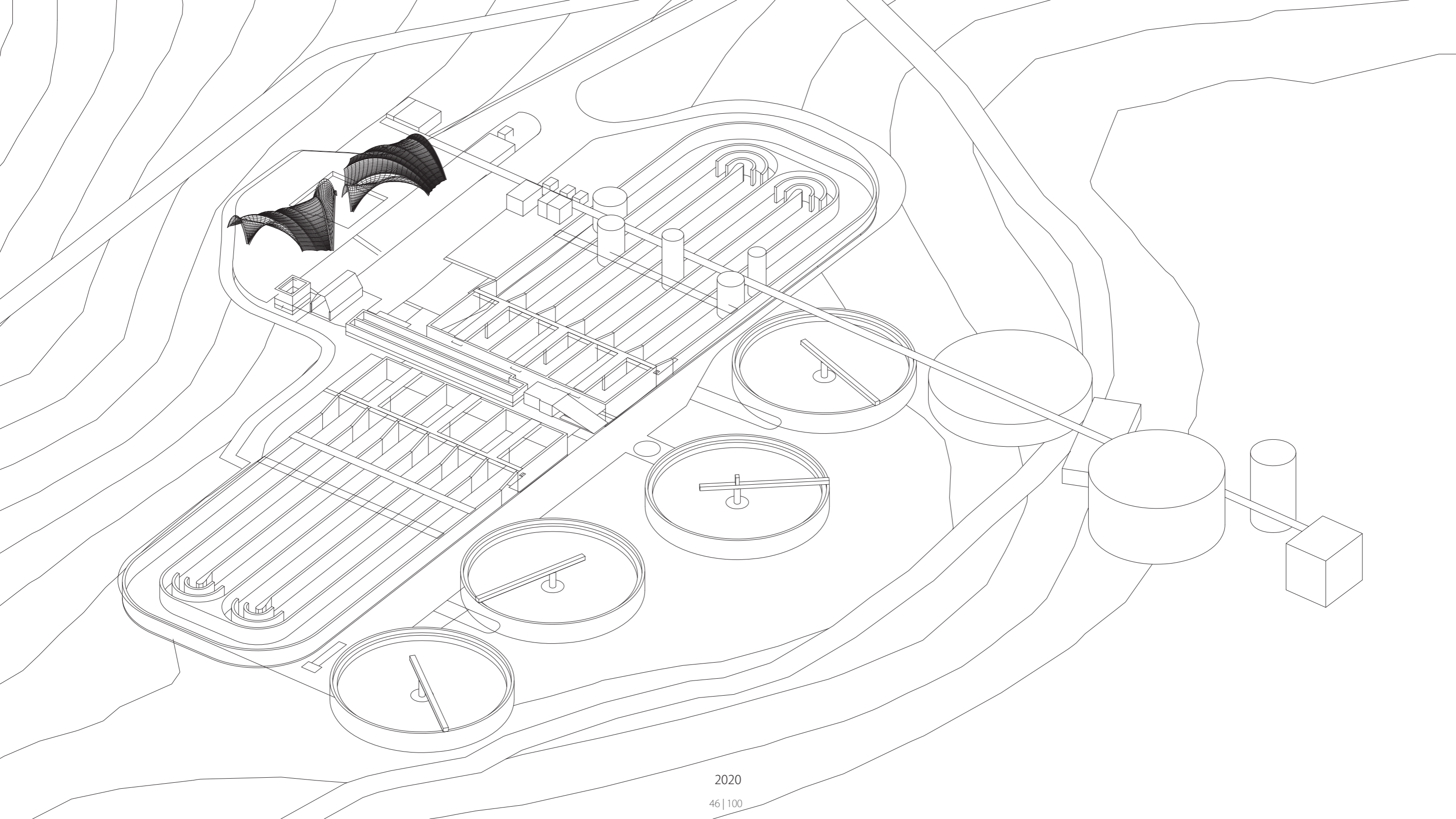

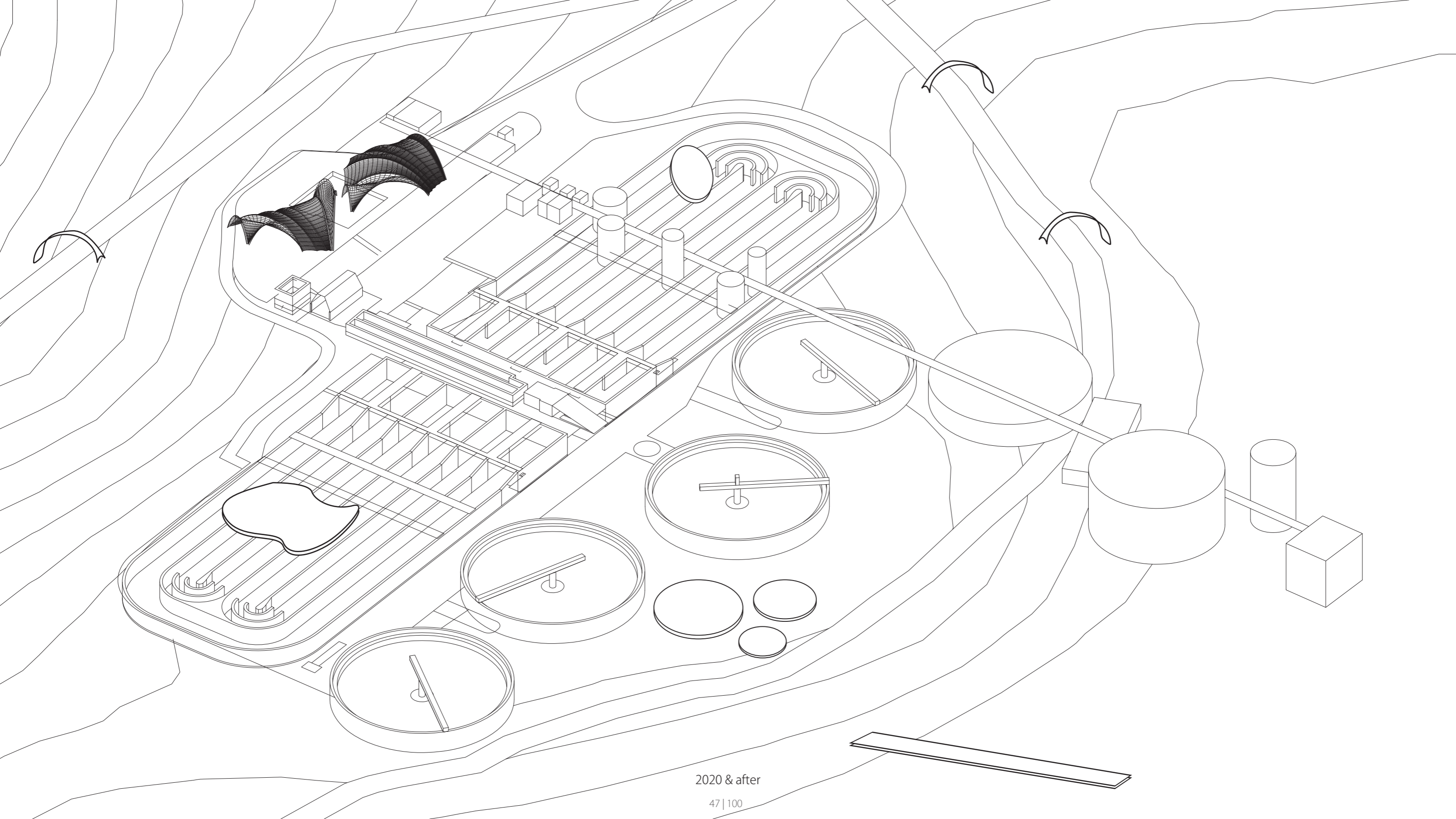

2020 & after

47 | 100

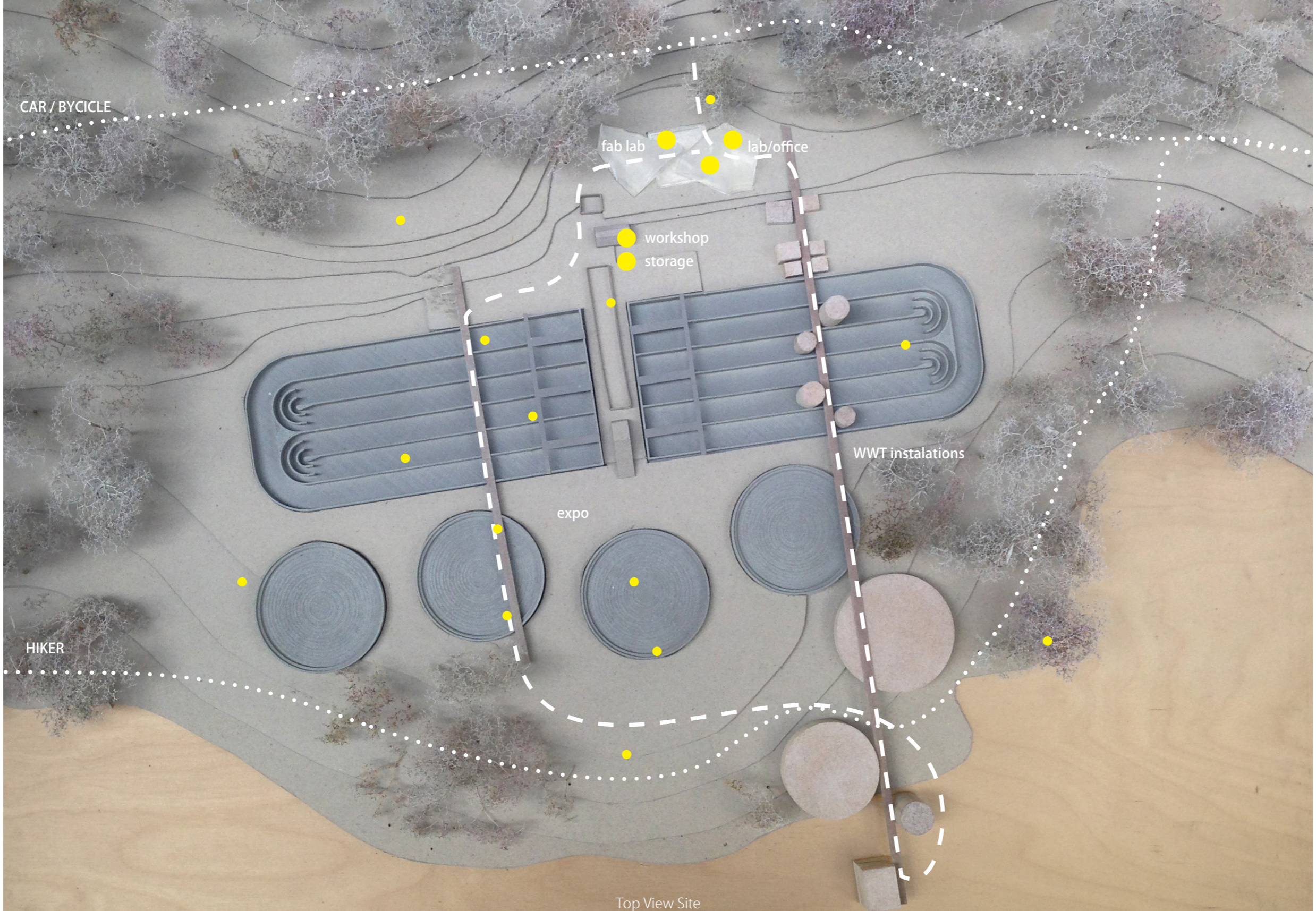

CAR / BYCICLE

fab lab

lab/office

workshop

storage

WWT instalations

expo

HIKER

Top View Site



Top View Site

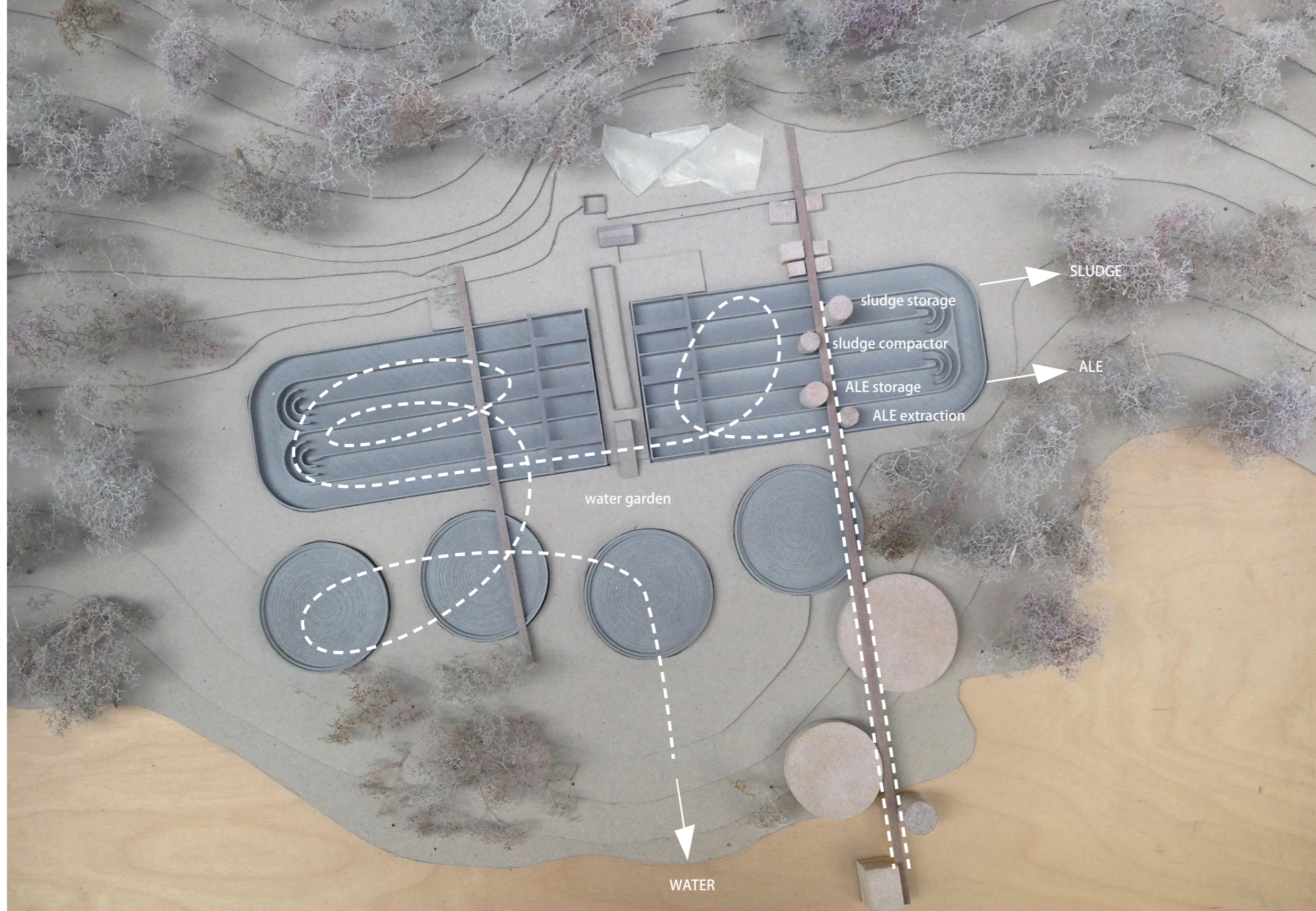

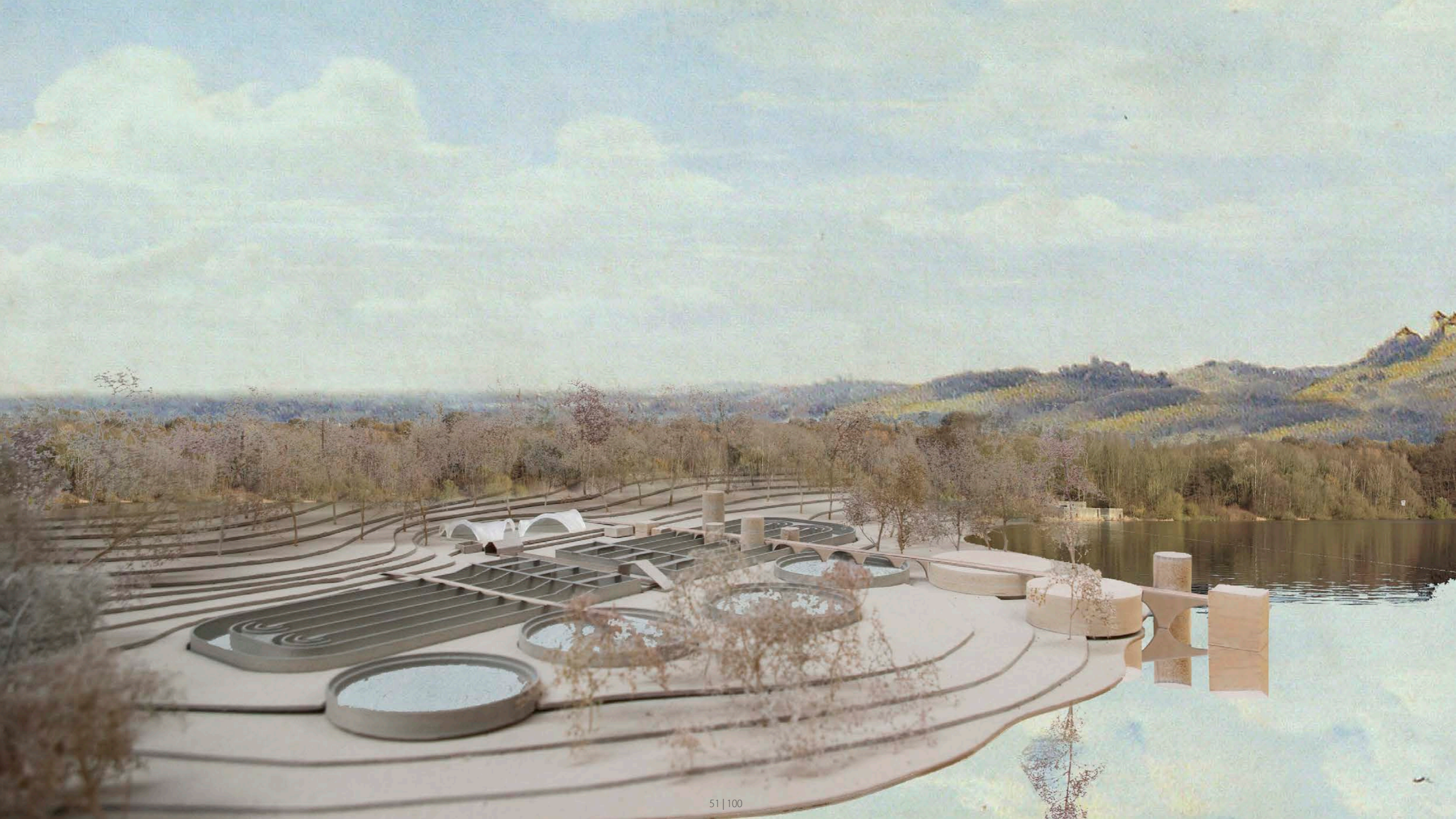

DESIGN
building



ASPECTS

Surroundings

Material properties

Program of Requirements

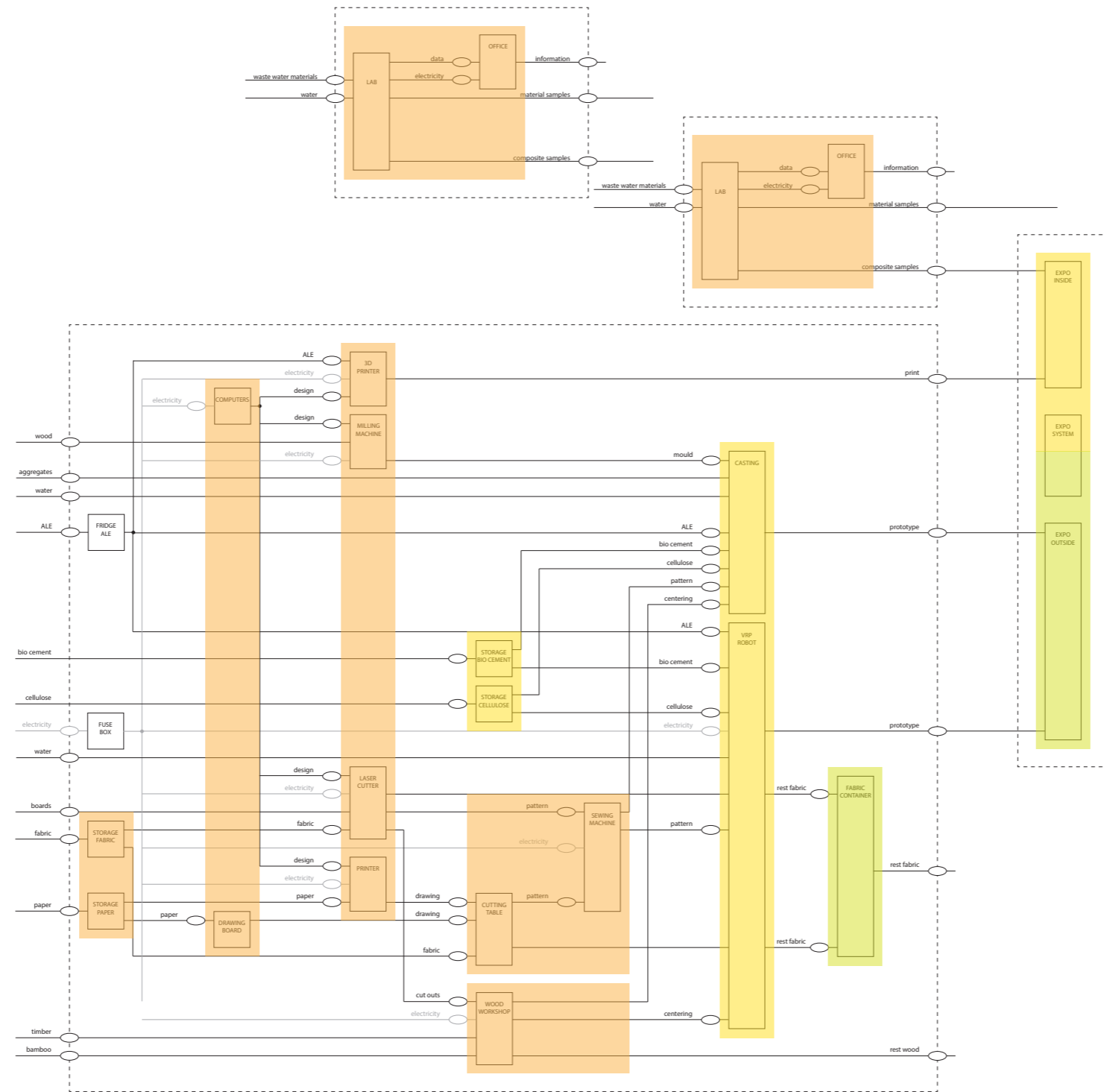

Material Flow Analysis (Program of Requirements)

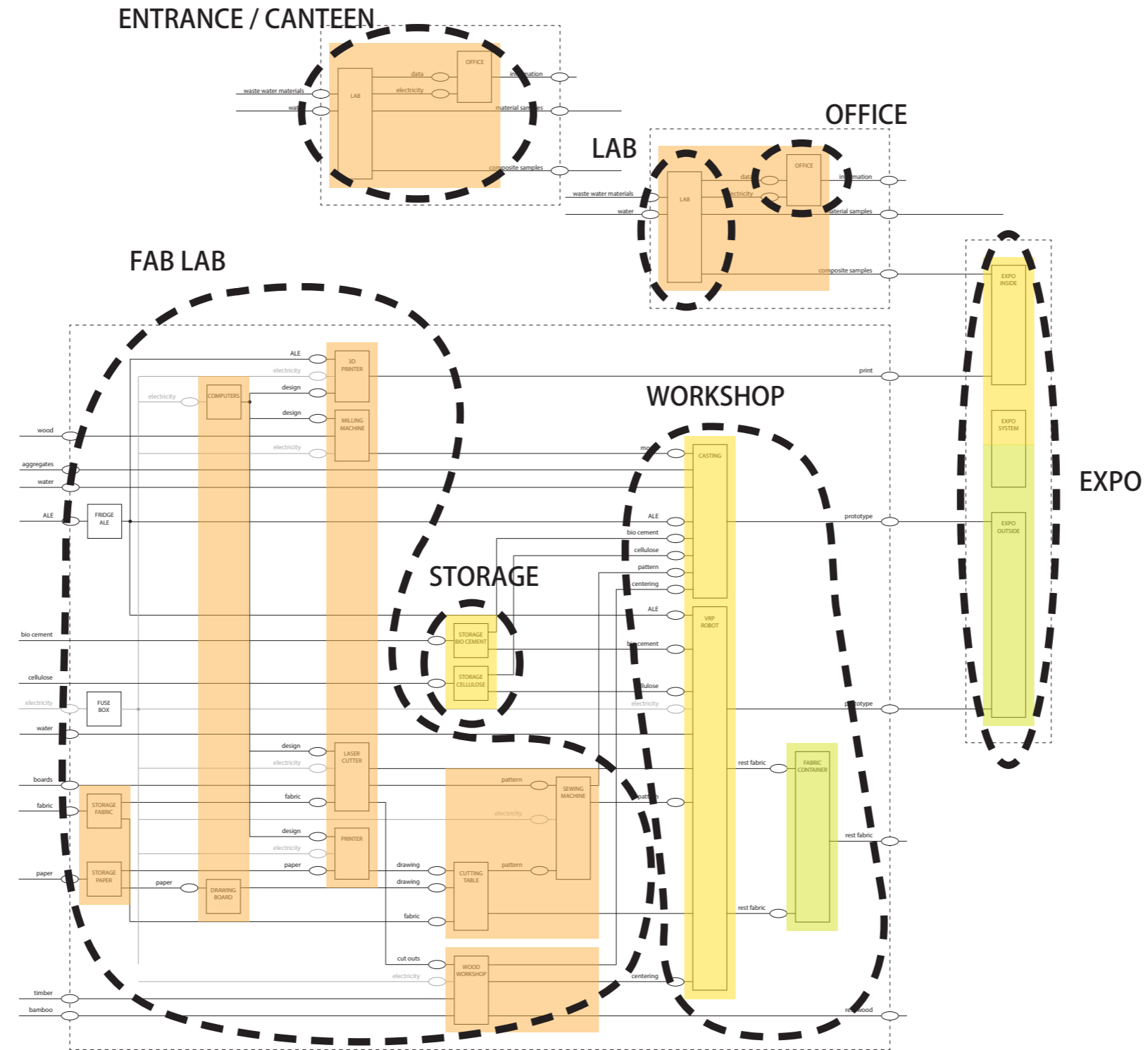

Material Flow Analysis (Program of Requirements)



Plan 1:50

workshop

entrance

lab

office

Plan

57 | 100





Plan 1:50

workshop

entrance

lab

office

Plan

59 | 100



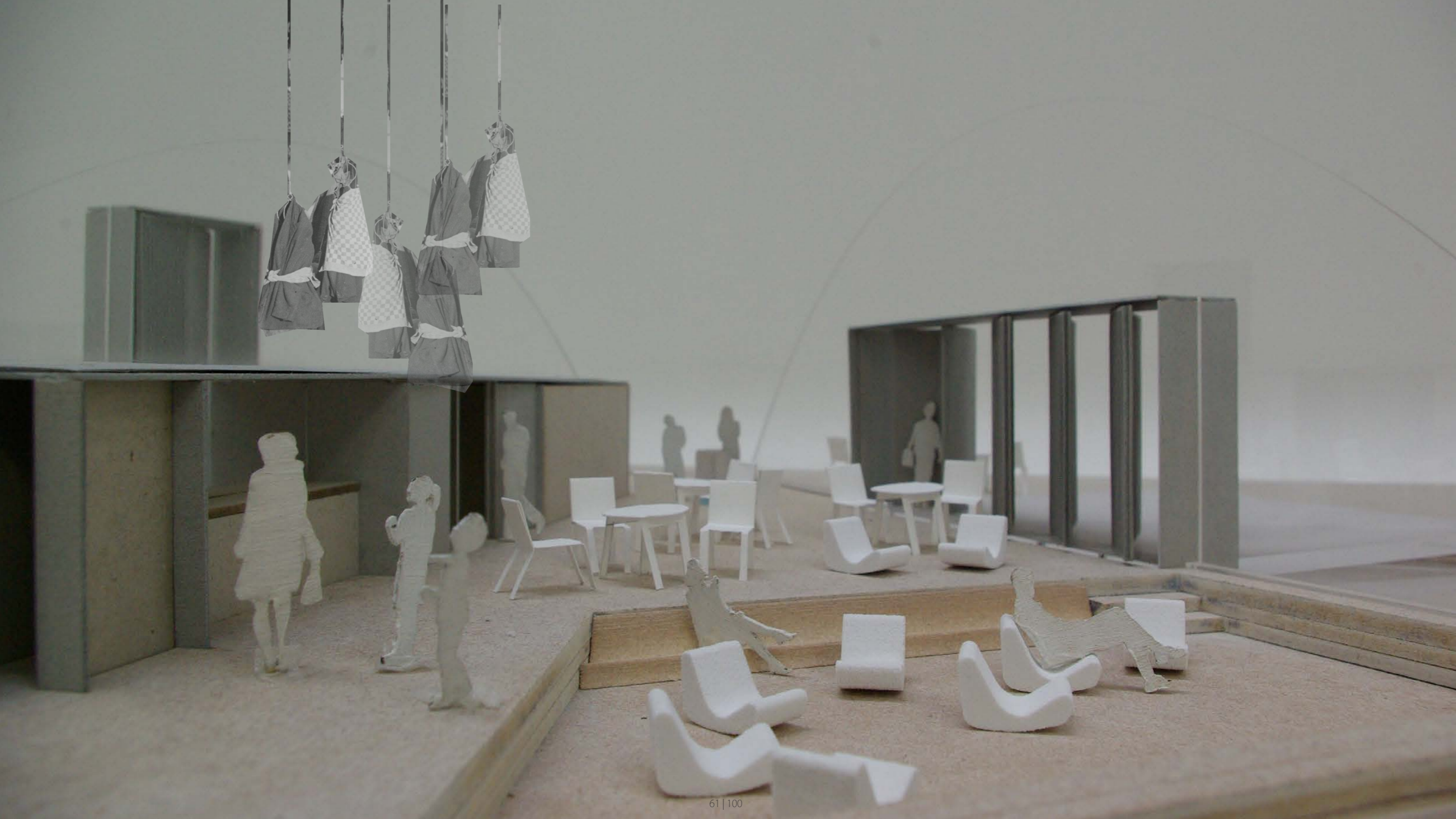



workshop

entrance

lab

office



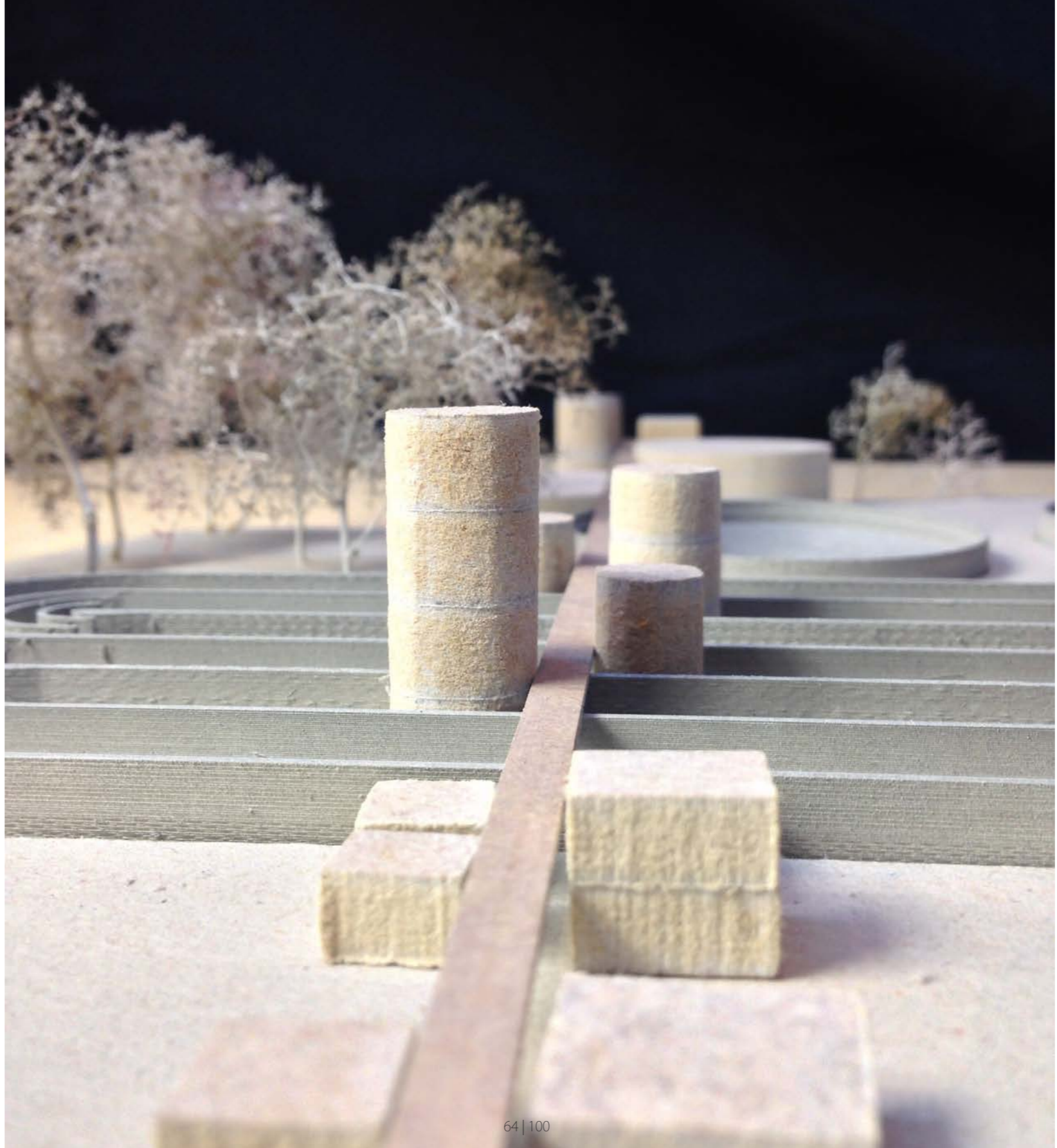



Plan 1:50

workshop

entrance

lab

office

Plan

65 | 100

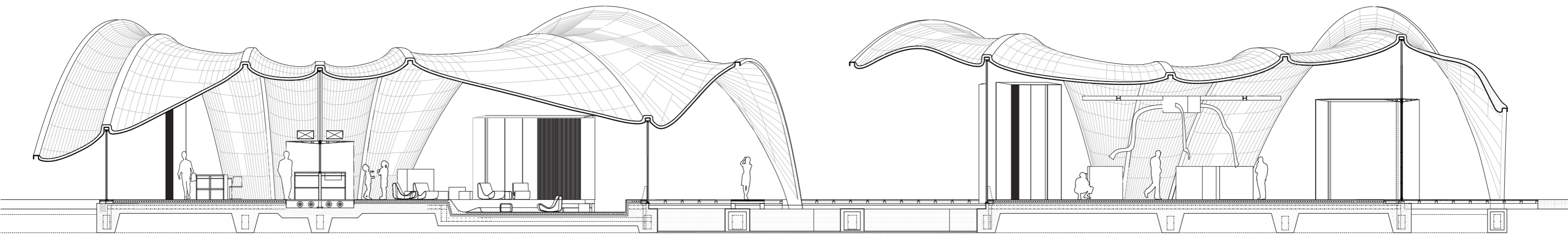

Longitudinal Section

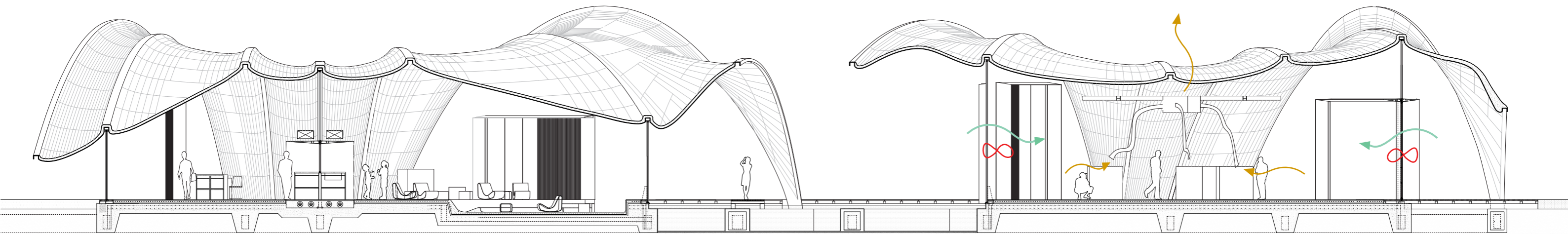

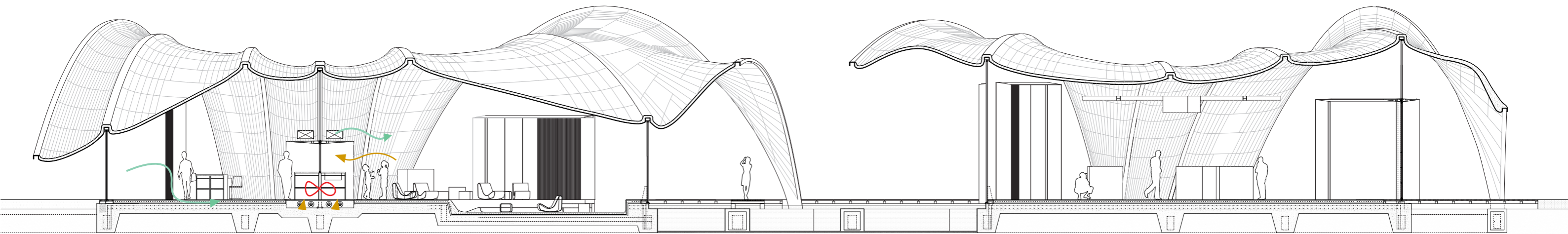

Ventilation of Entrance

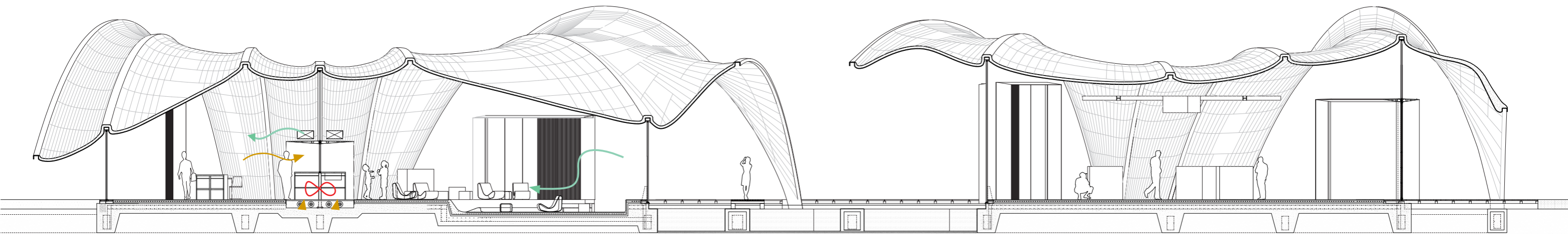





ALE

+



ALE-cellulose

+



Bio-Cement

+



biomass ash

+



effluent

Components of new composite

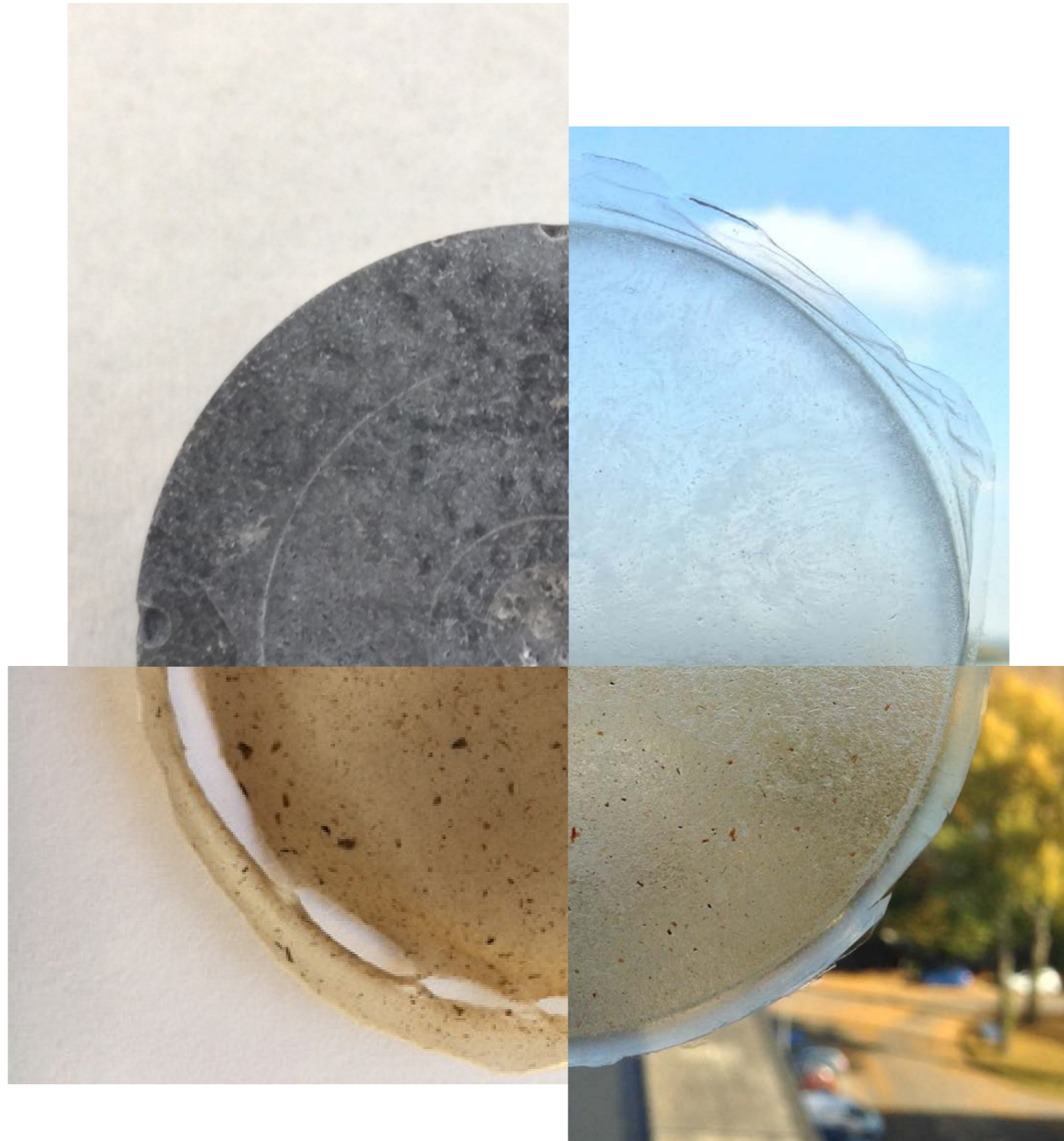



=
FIBRE
REINFORCED
CEMENT
(shelter)



≠
GLASS



=
PAPER
CRETE
(insulation)



DESIGN CONSEQUENCES

1

Construction

Composite material (\approx FRC / concrete) doesn't have form of its own.

|
It is in need of a **mould**.

2

Details

Composite material (translucent \neq insulating) can not answer to all 'building requirements'.

|
Distinction between **shell(ter)** & **services**.

construction

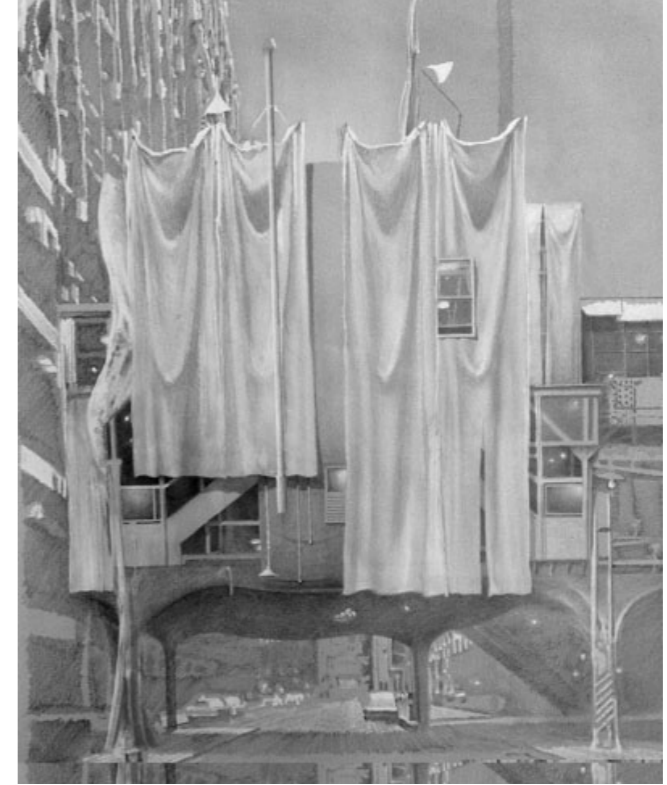
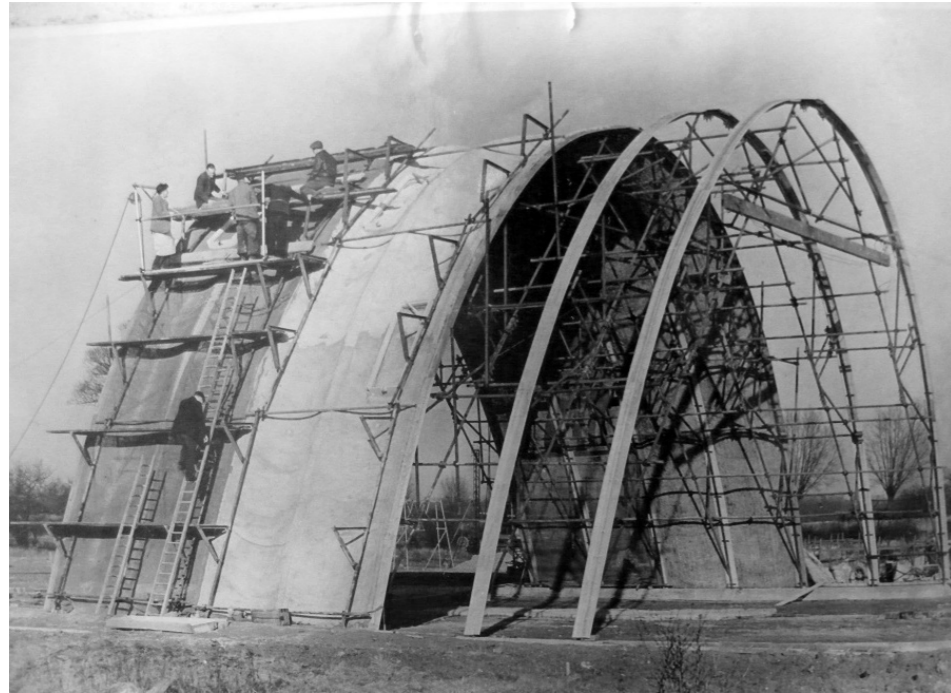

Fabric Reinforced Cement



sand mould

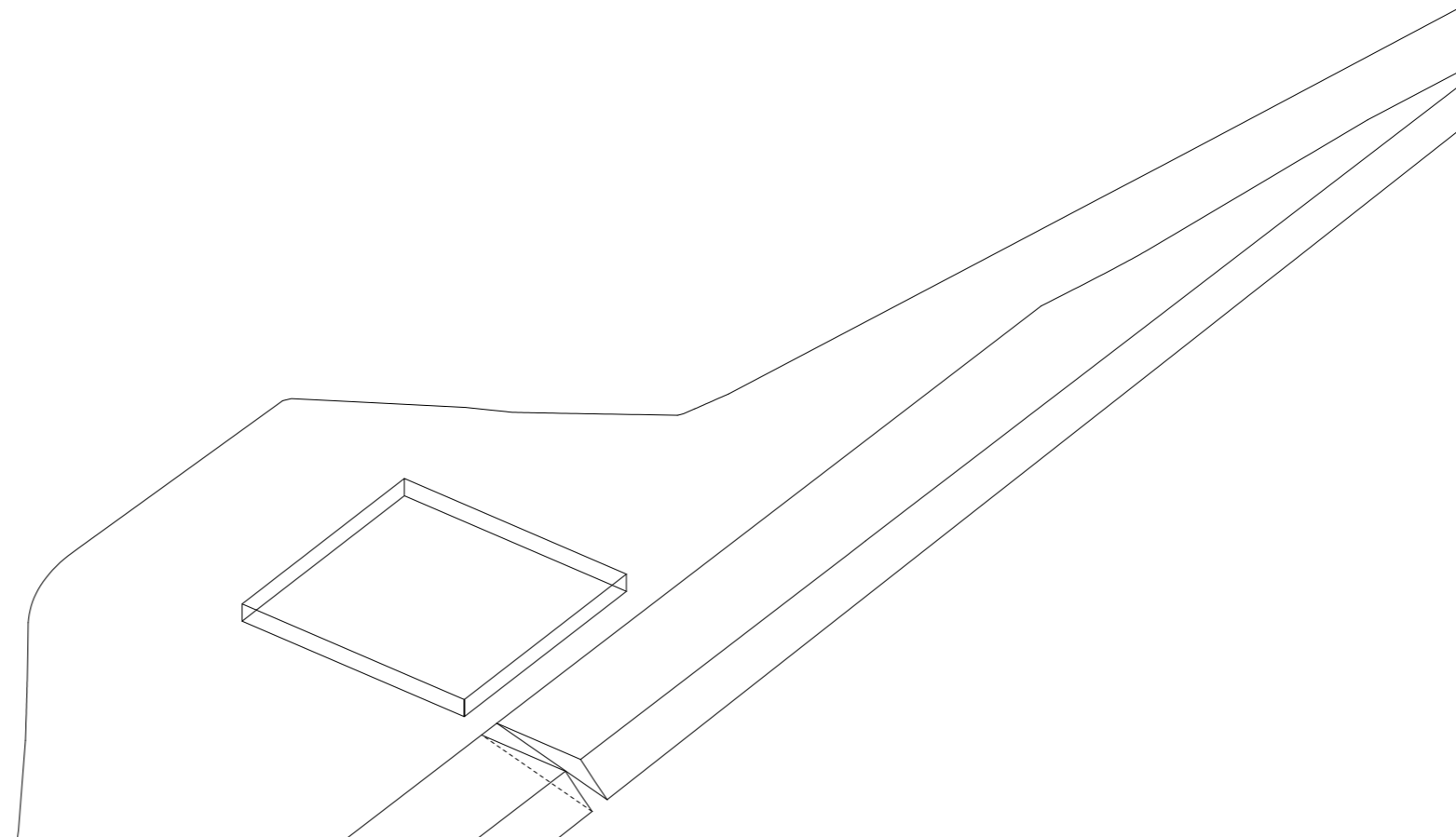

Construction Sequence

foundation

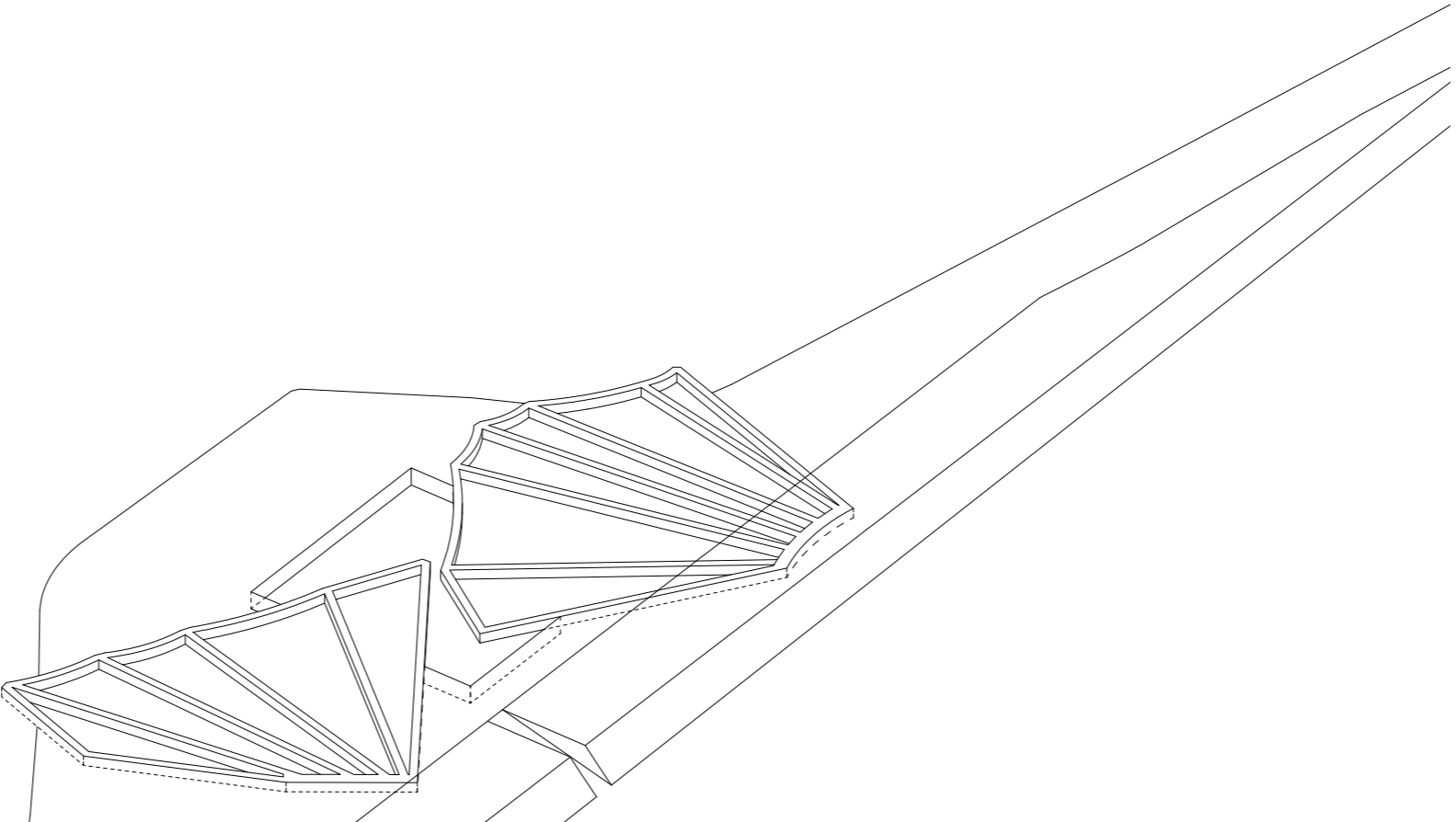

Construction Sequence

floor

foundation

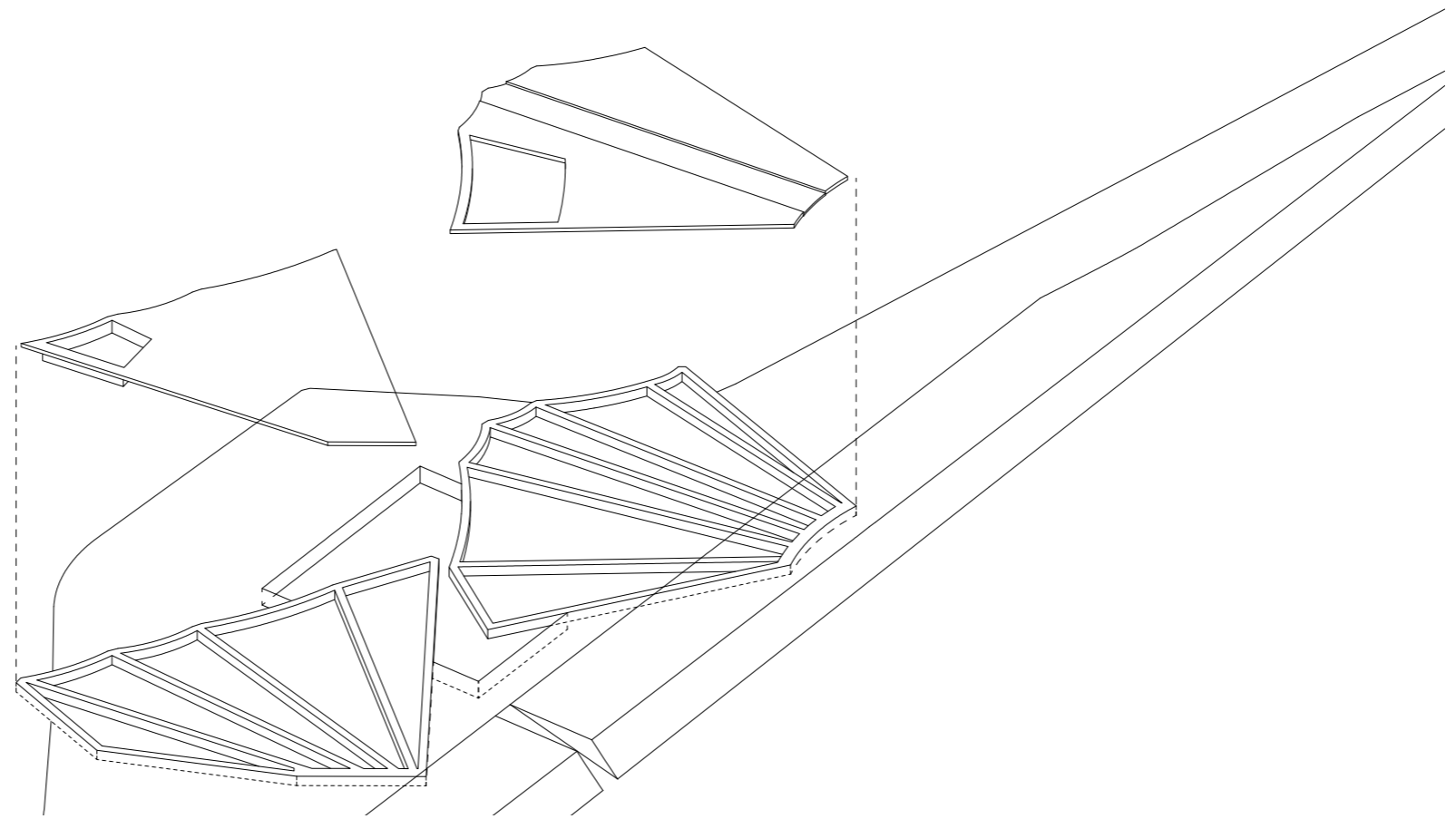

Construction Sequence

centering

floor

foundation

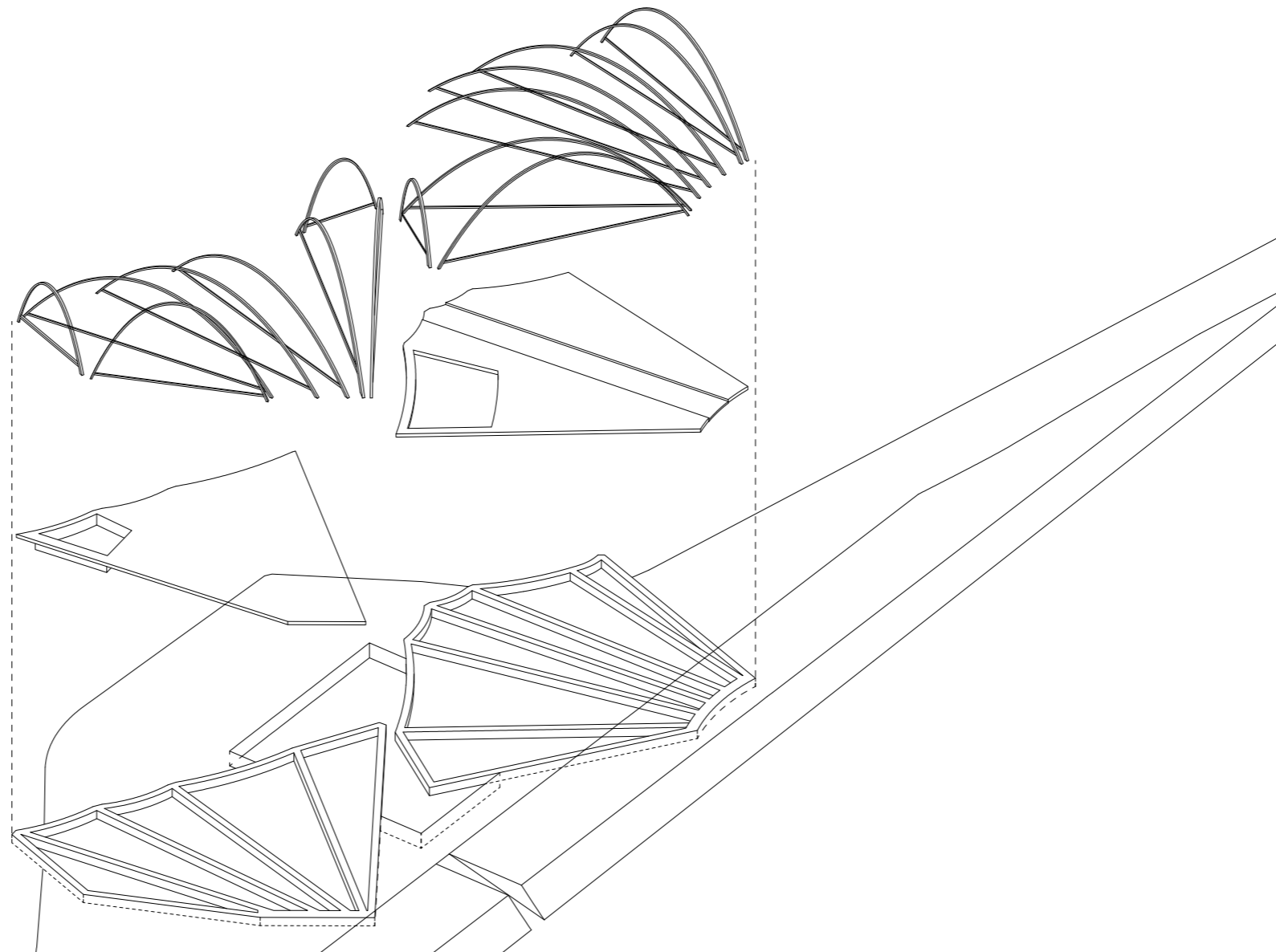

Construction Sequence

fabric

centering

floor

foundation

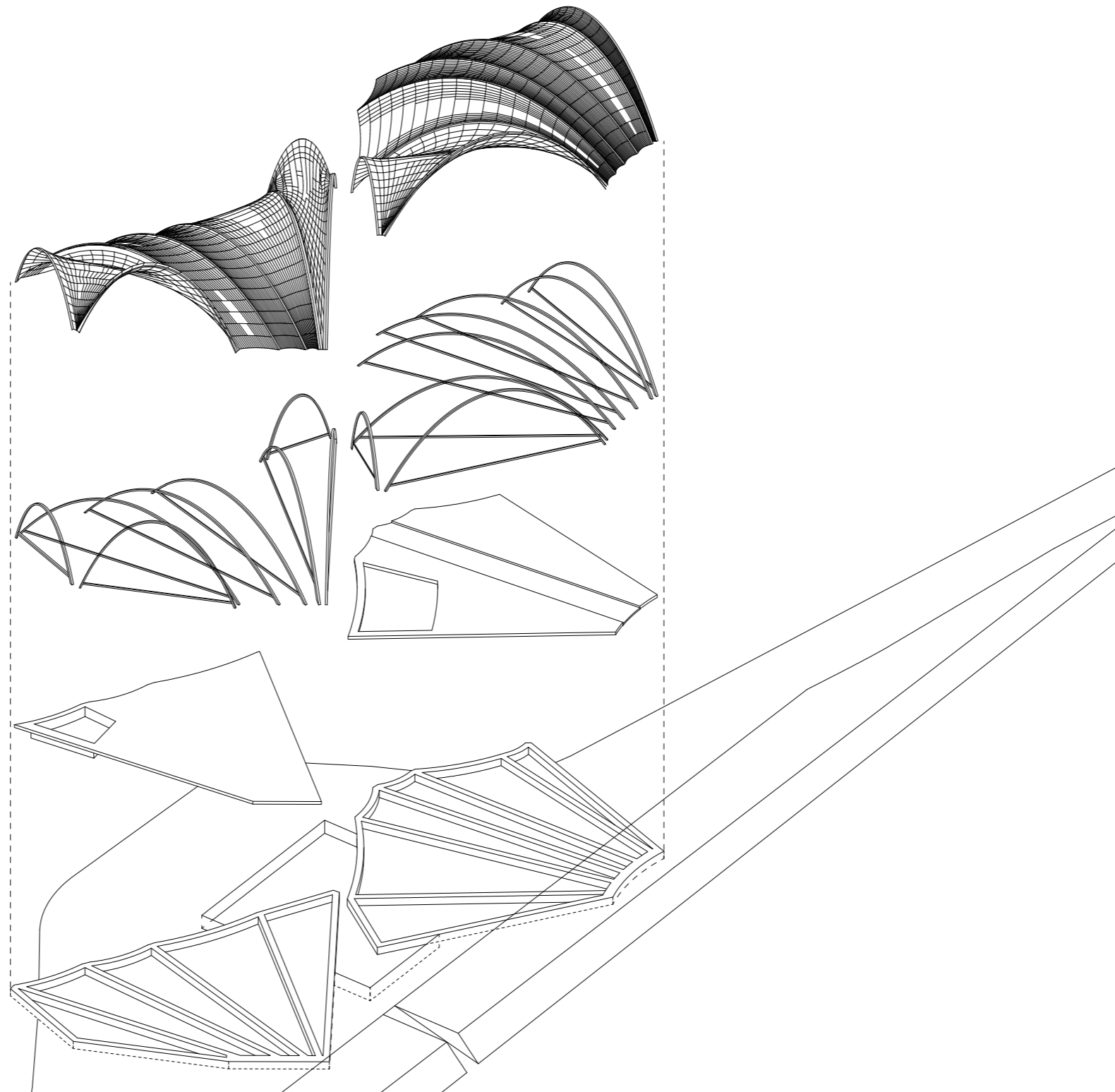

Construction Sequence

FINAL SHAPE

1
3-d boundary conditions

|
determined

2
balance

tension strength fibres
&
pressure forces own weight

|
undetermined

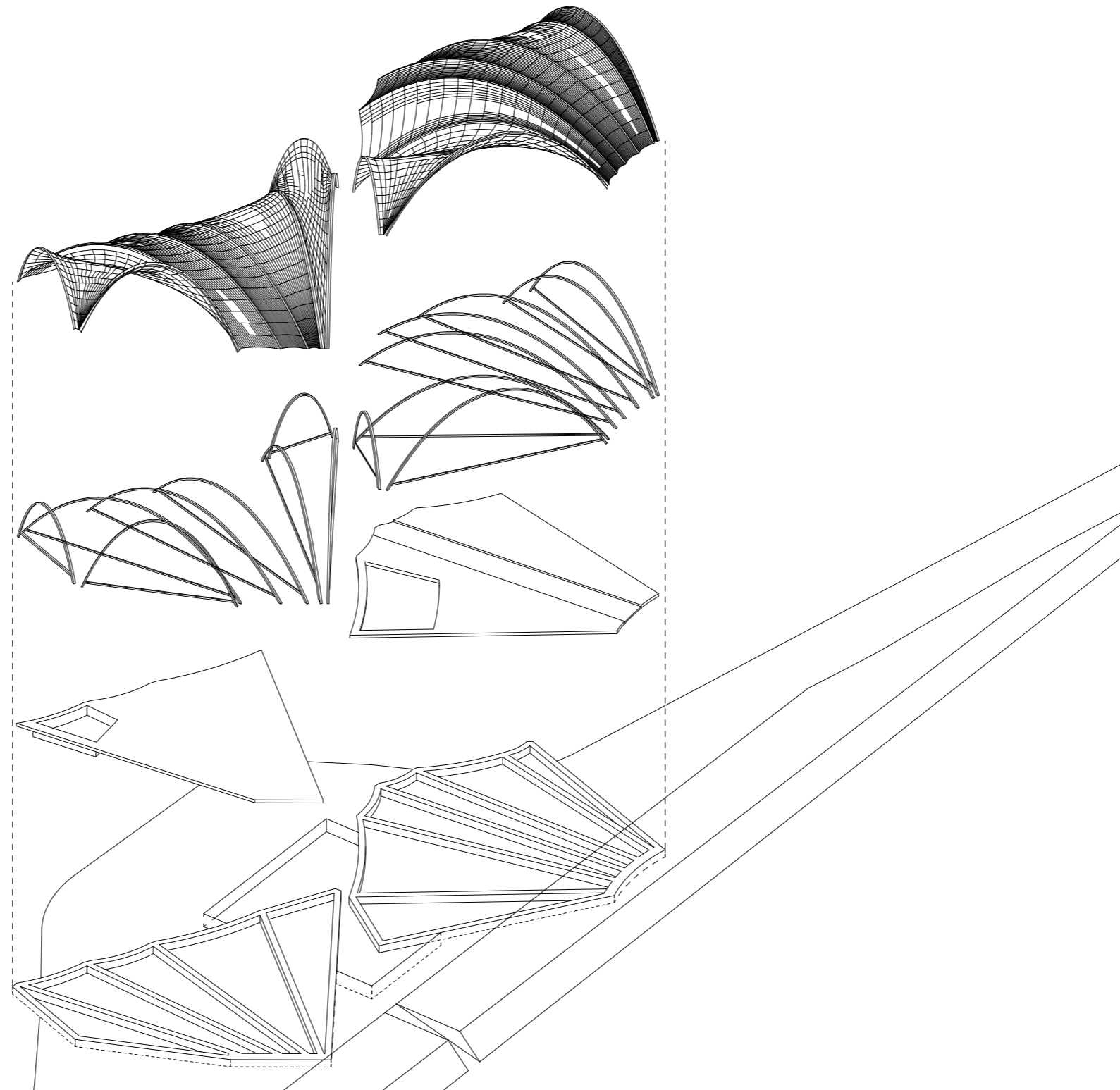

Construction Sequence

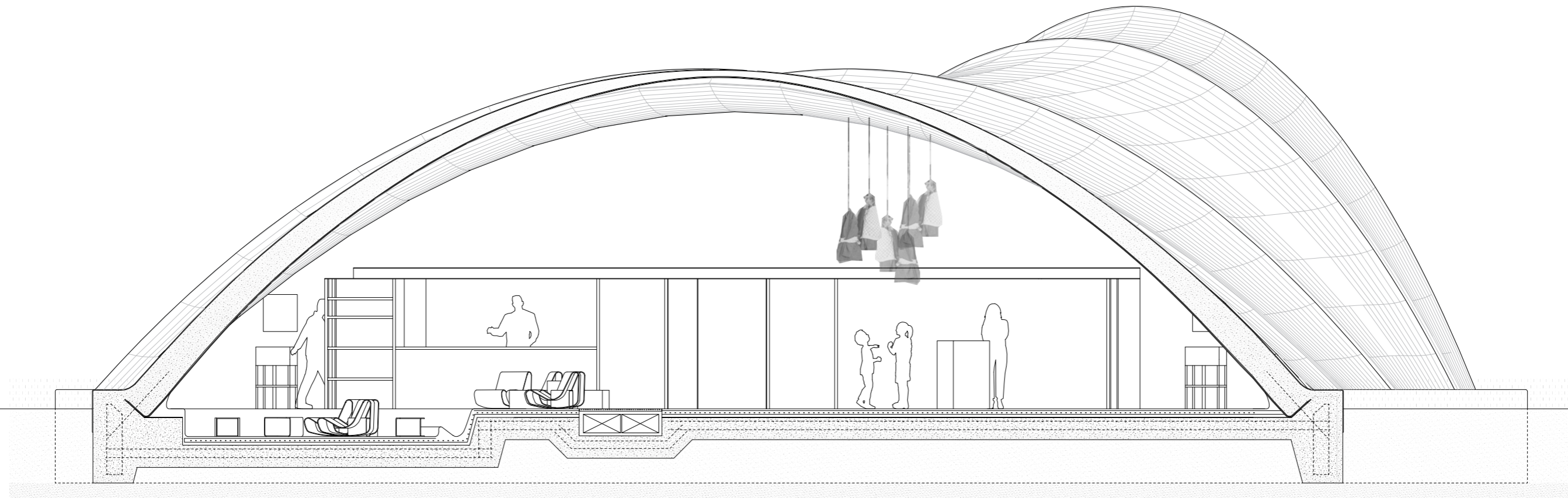

Cross Section

STRENGTH & STIFFNESS OF STRUCTURE

Catenary arch

Difference thickness & density

Double curved surface
3d boundary conditions
relaxing of surfaces

Structural ribs

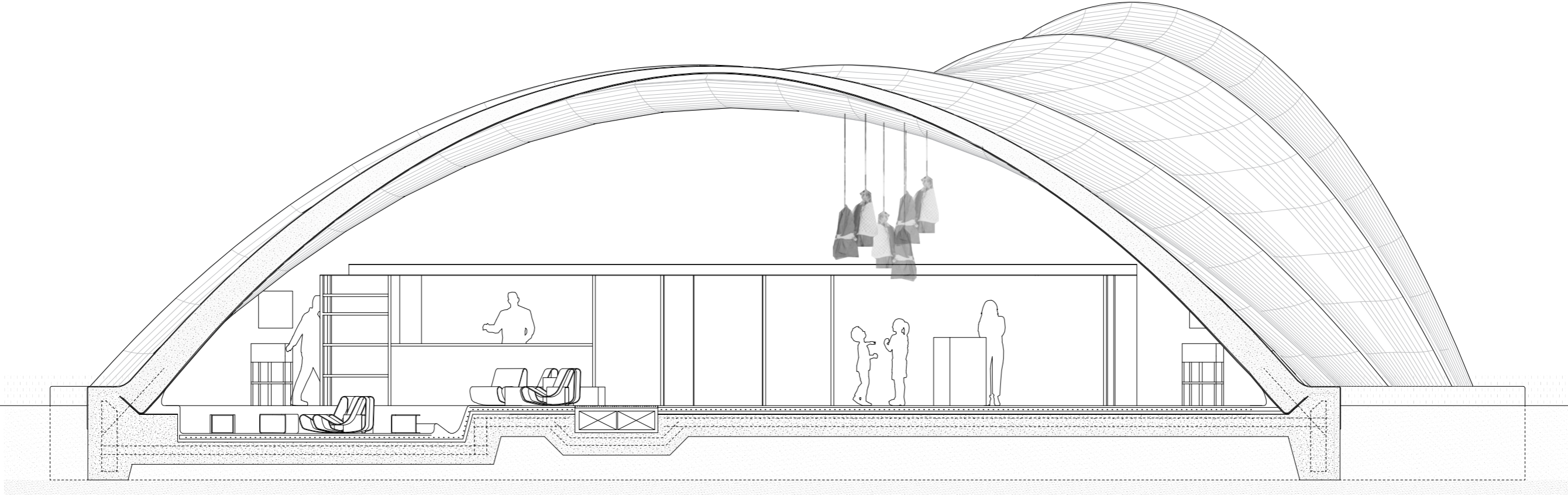

Cross Section

details

DISTINCTION

1

Composite

shell, floor, foundation

cast, continuous, heterogeneous

ruin

2

Steel

portals, furniture, machines

assembled, demountable, uniform

re-used

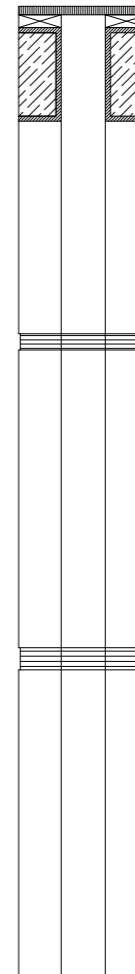

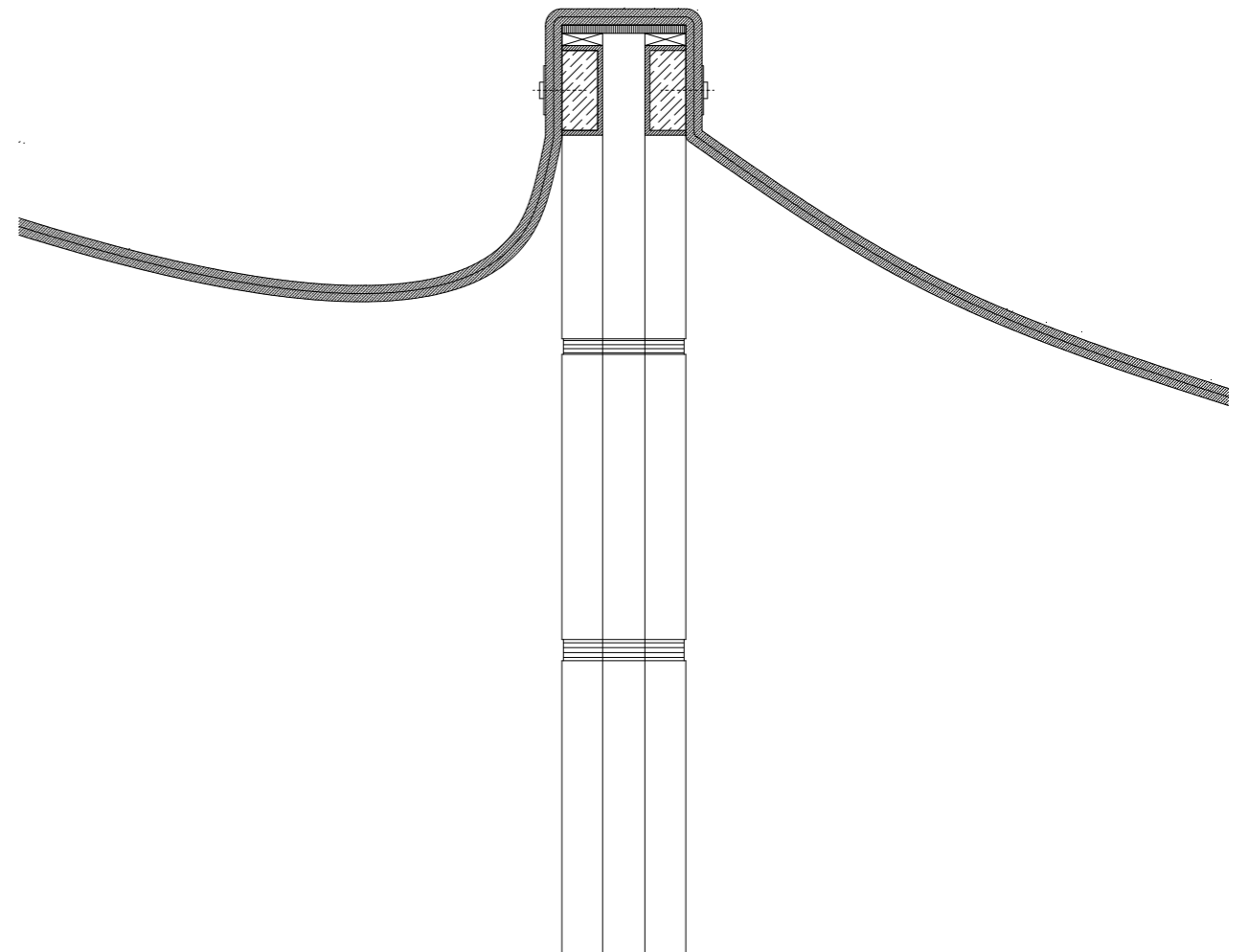

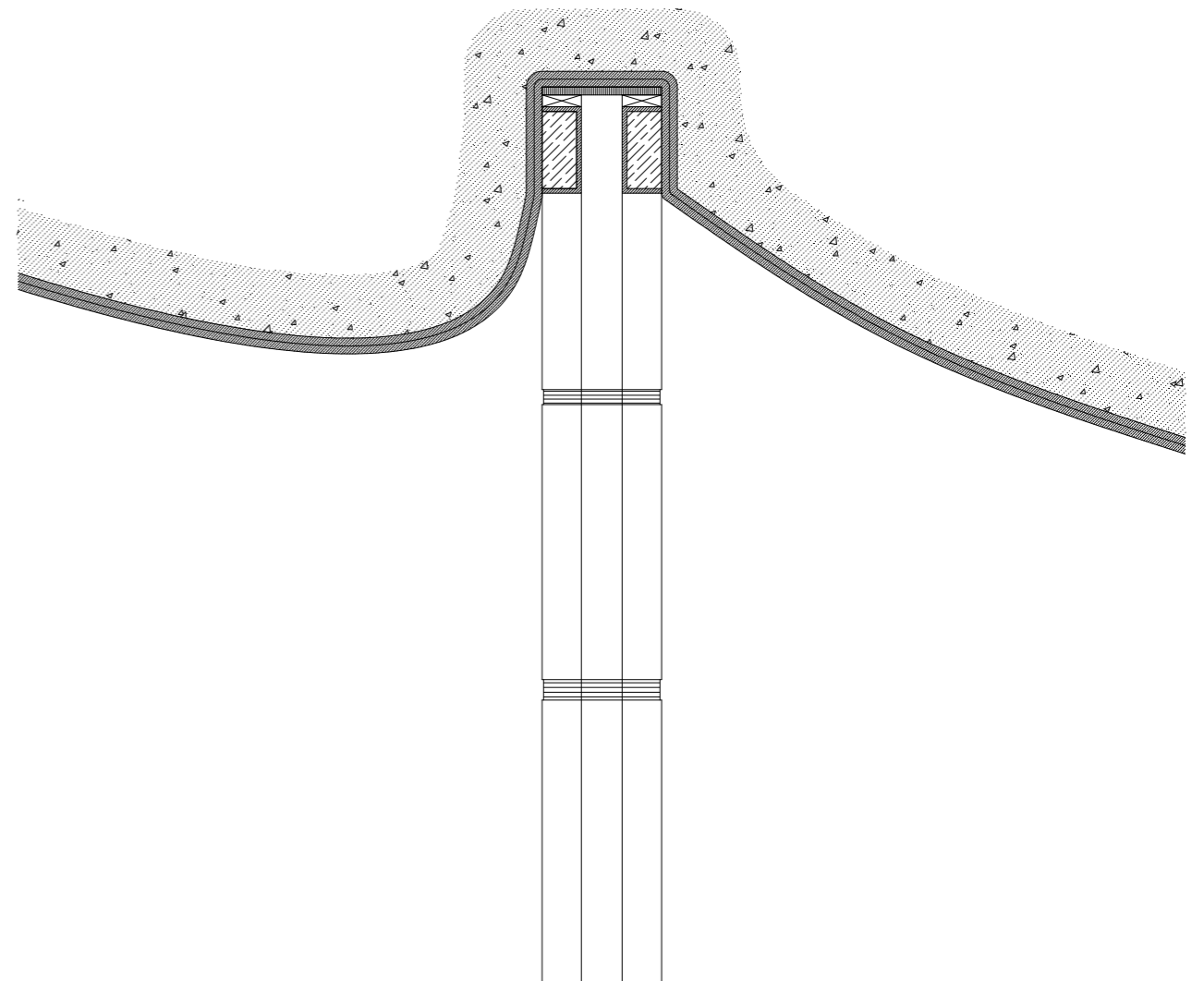

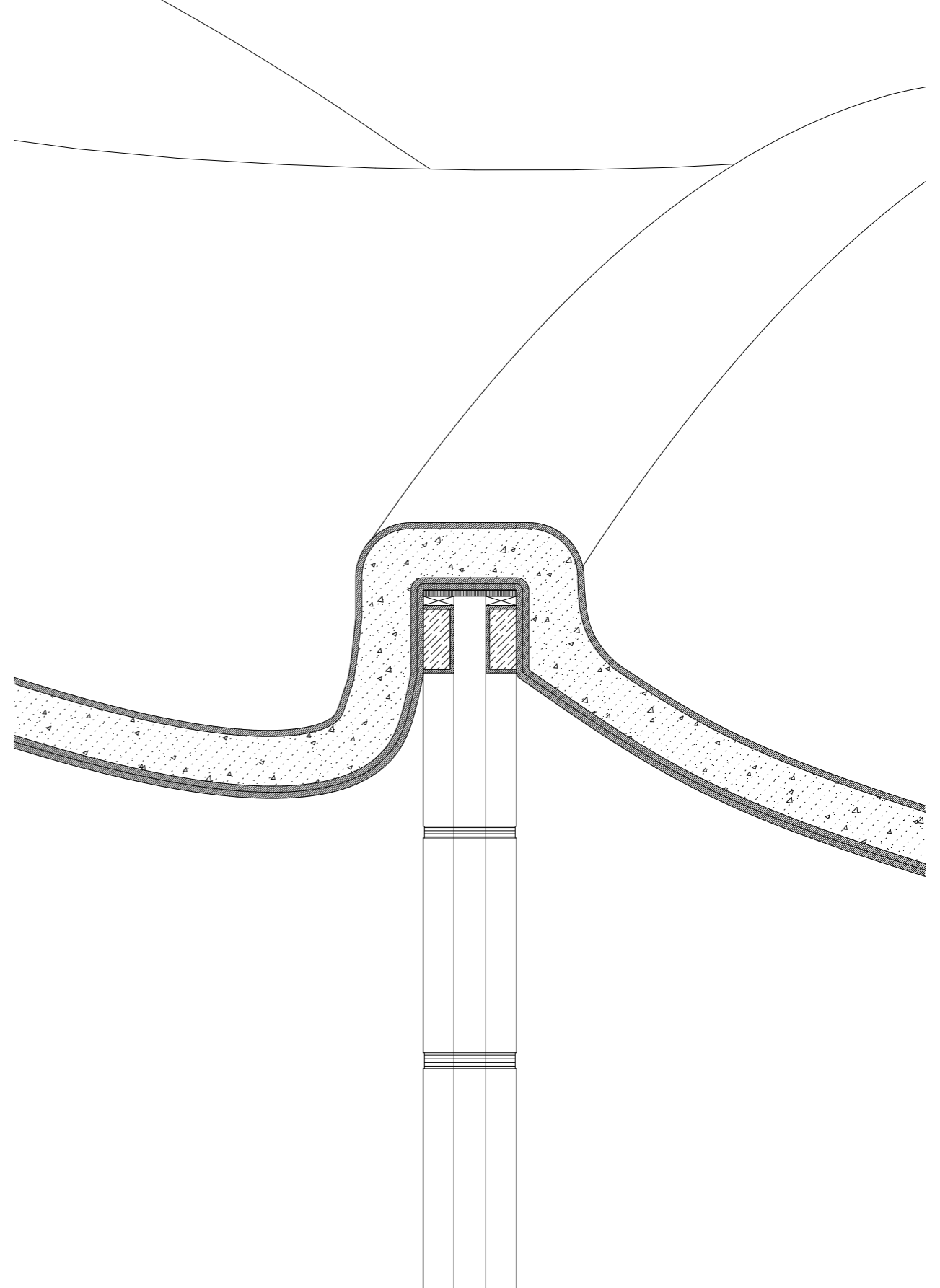

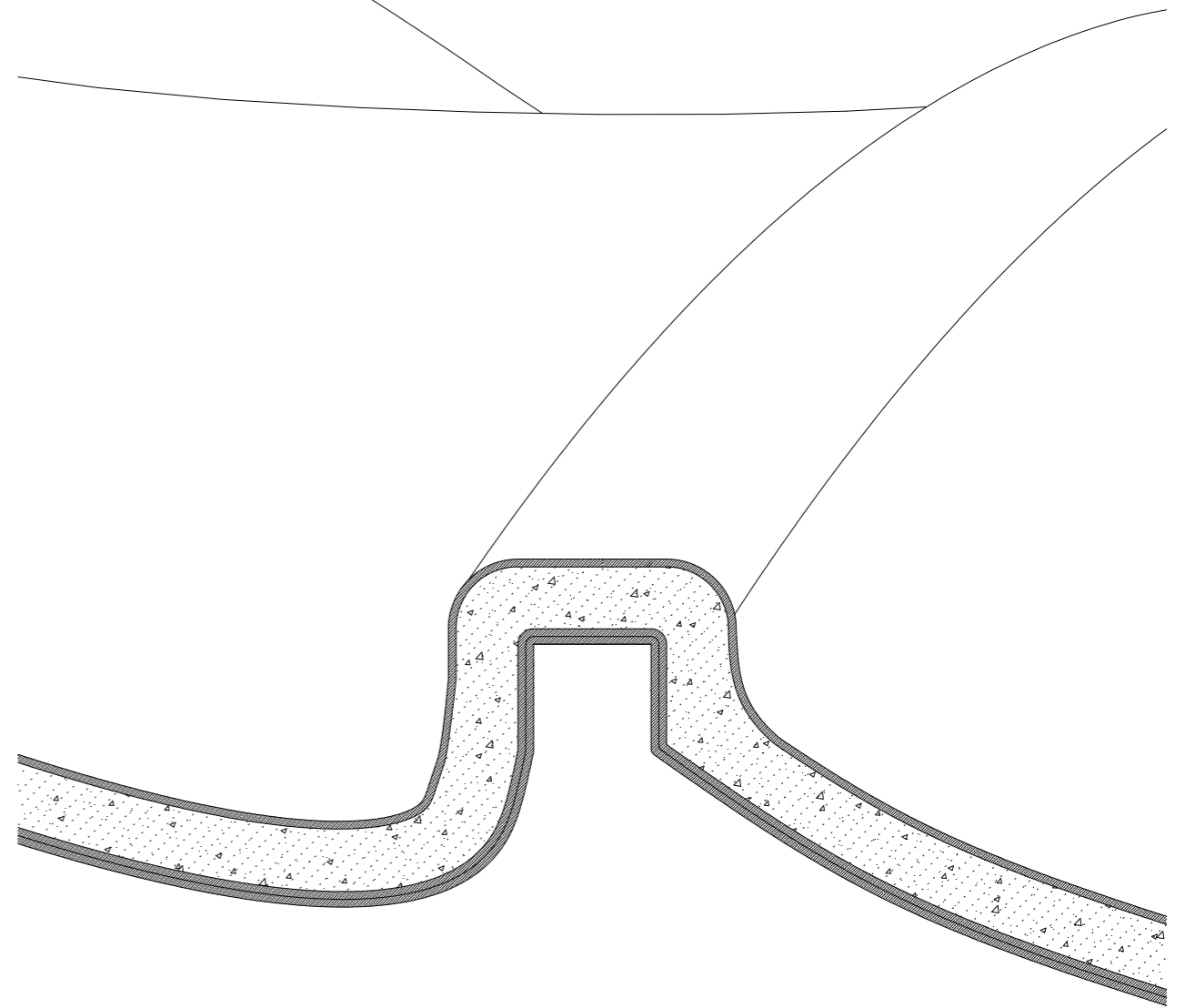

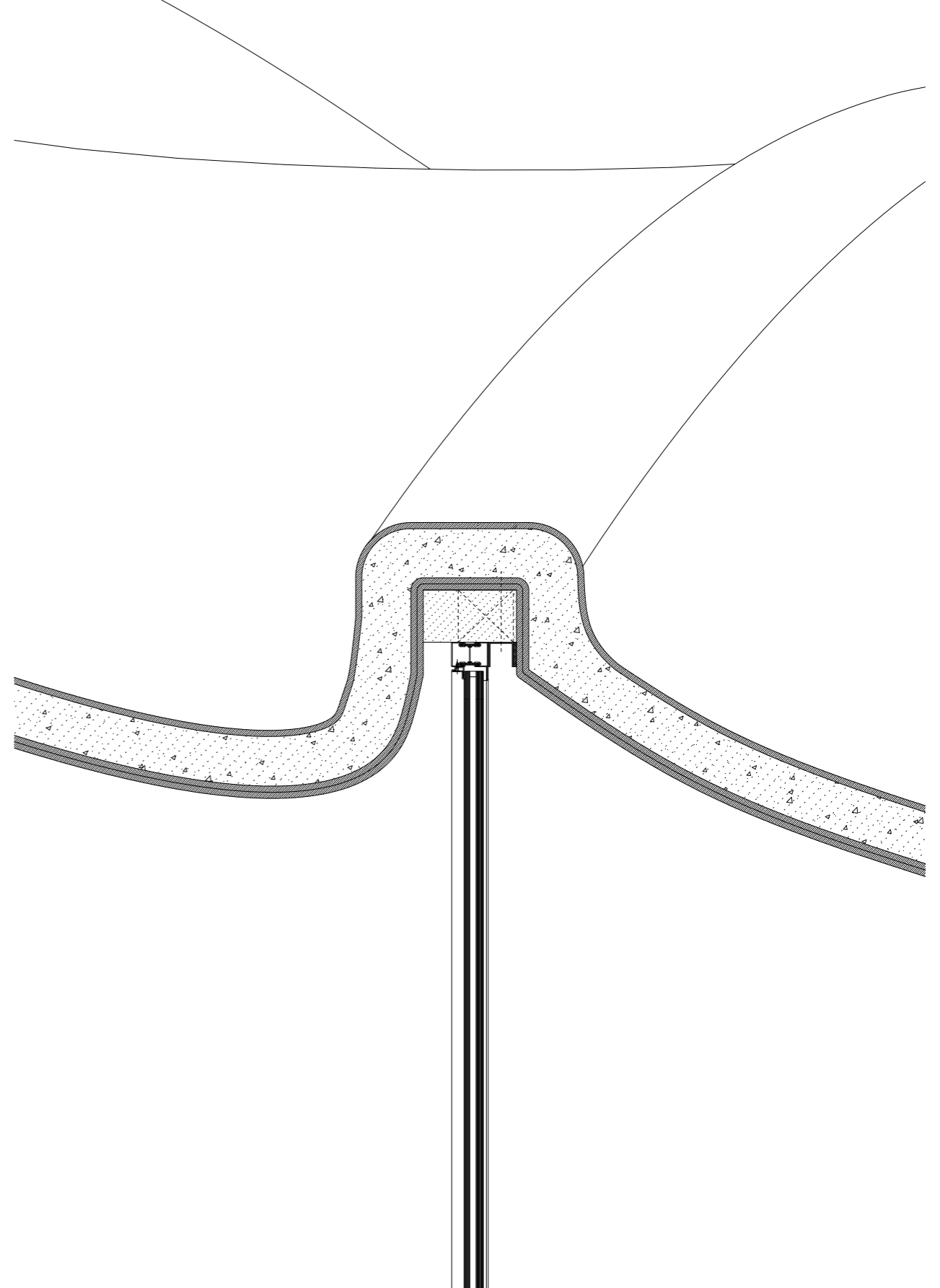

Vertical Detail hell - Glass

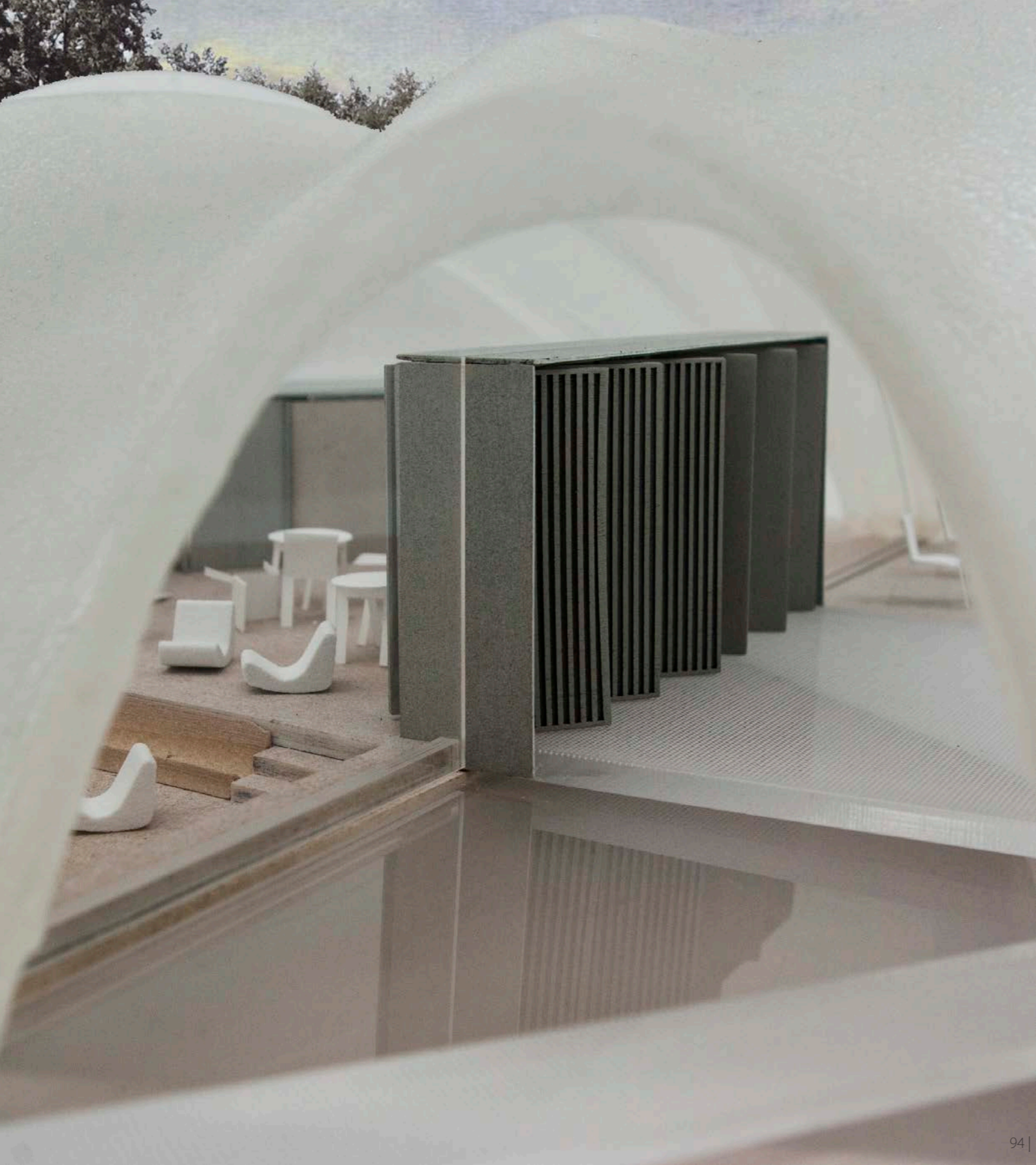

PORTALS

1

Technical

Installations, safety shower, wash boots, light

2

Architectonic

Transition / Differentiation between curved & straight

3

Experience

Gate (vestibule) between zones

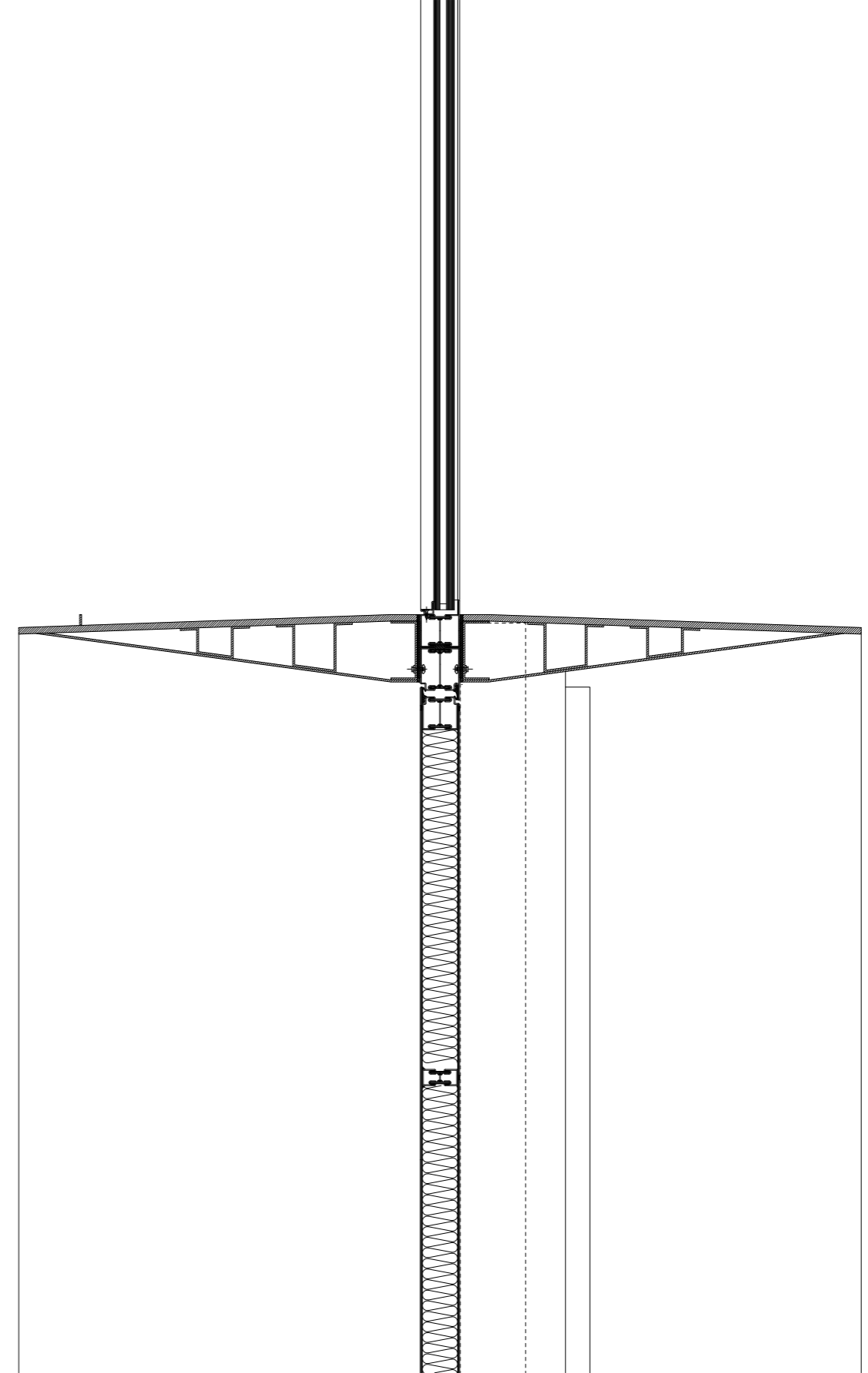
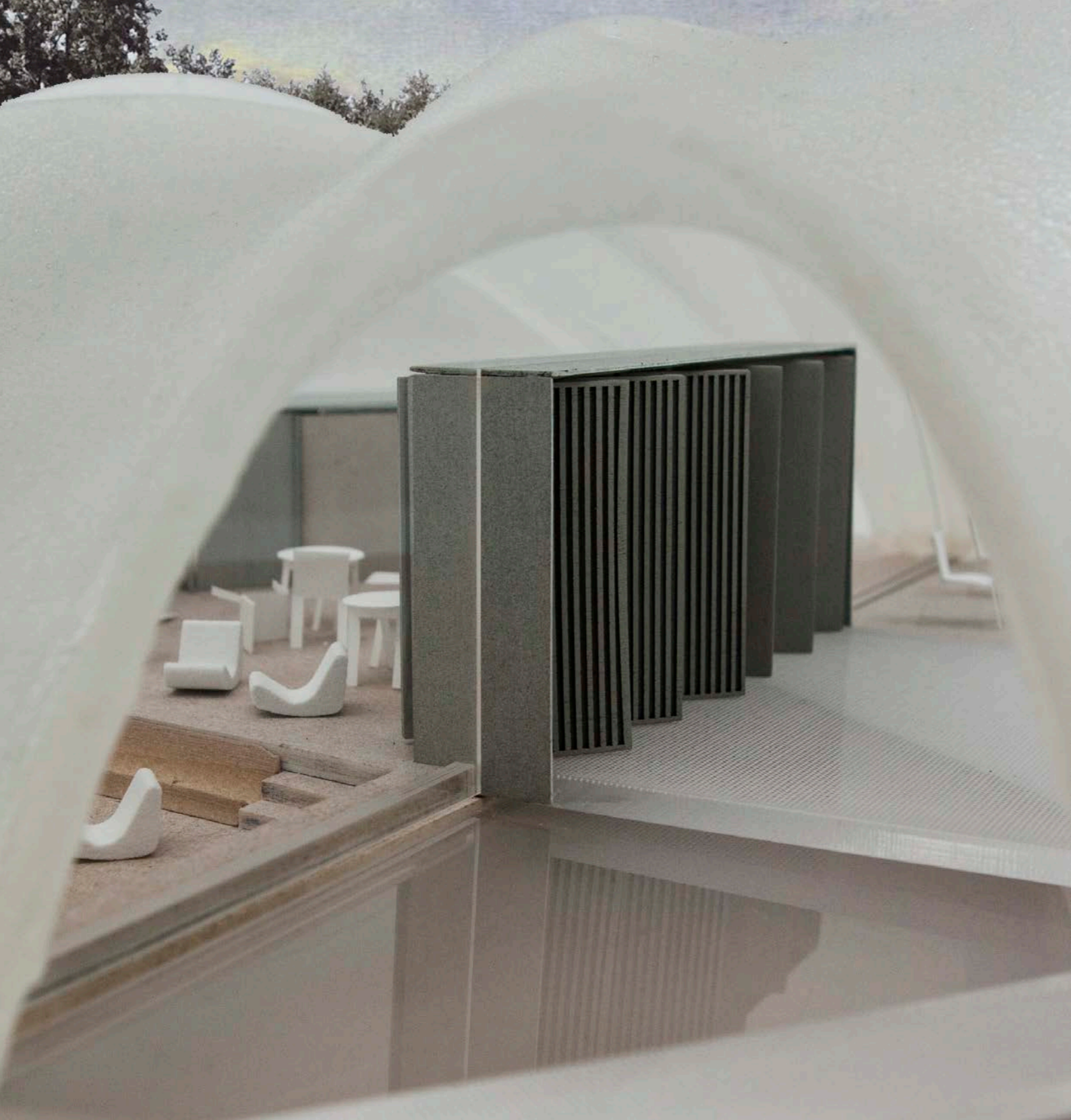

Vertical Detail Glass - Portal

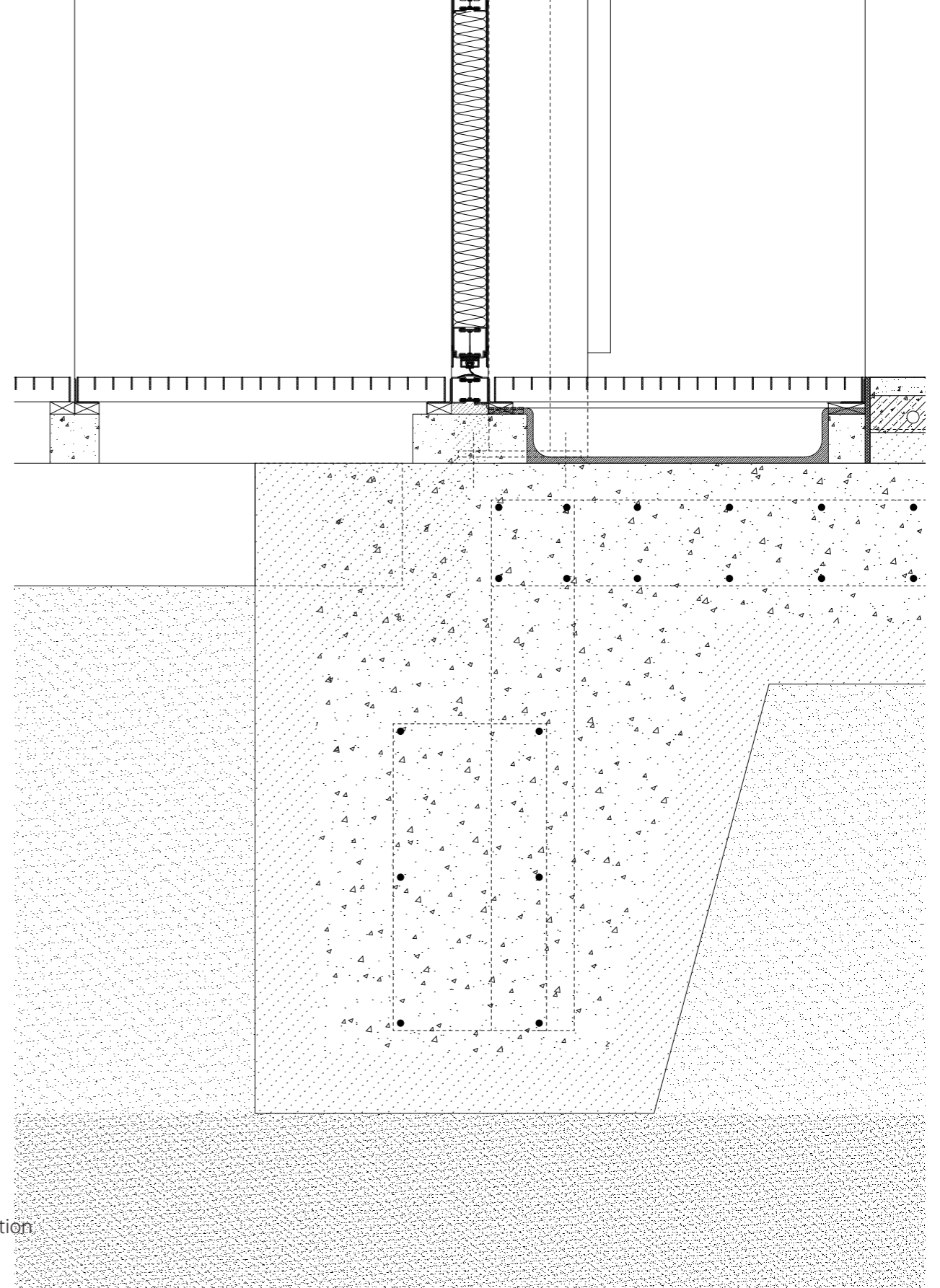
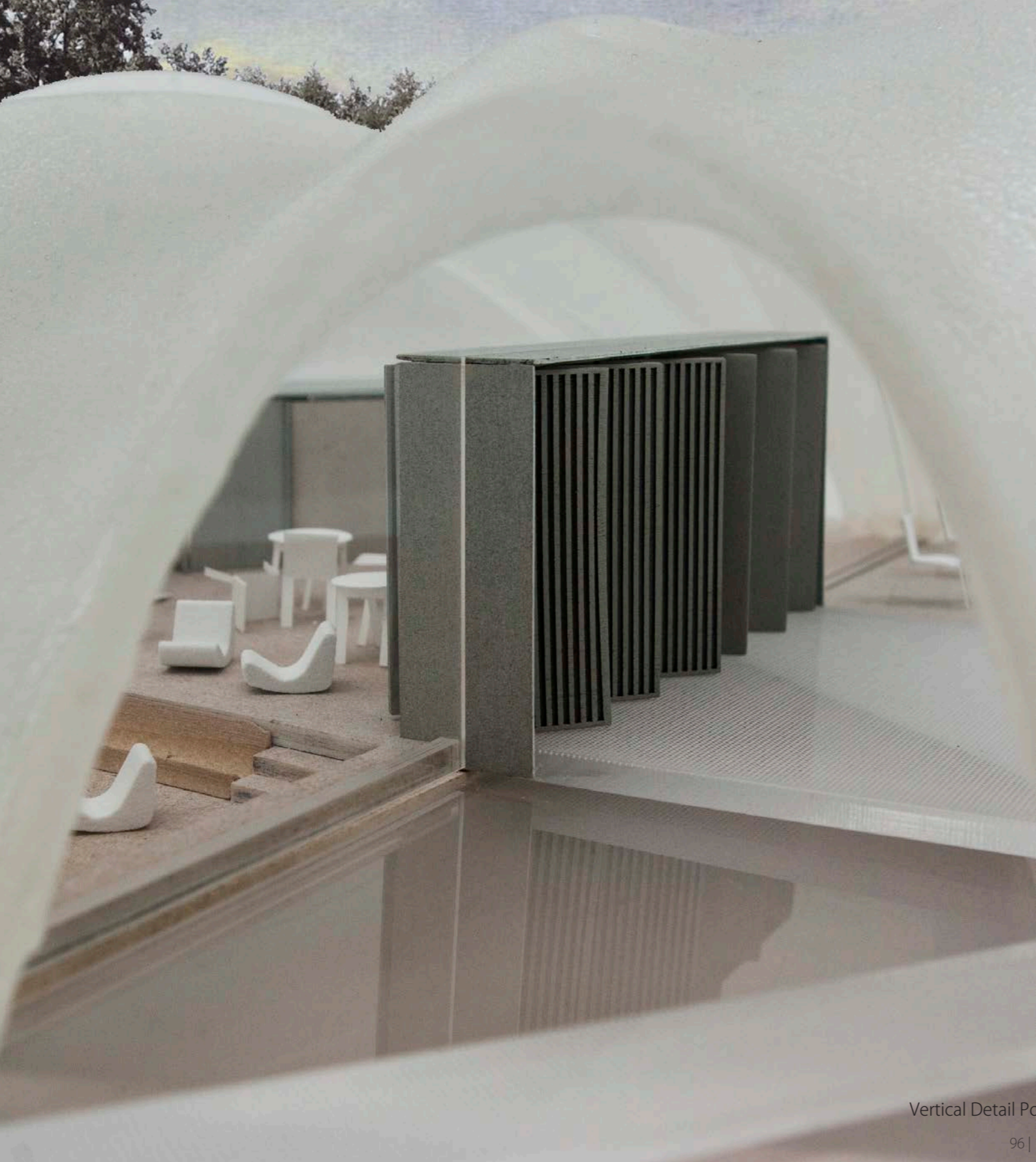

Vertical Detail Portal - Foundation

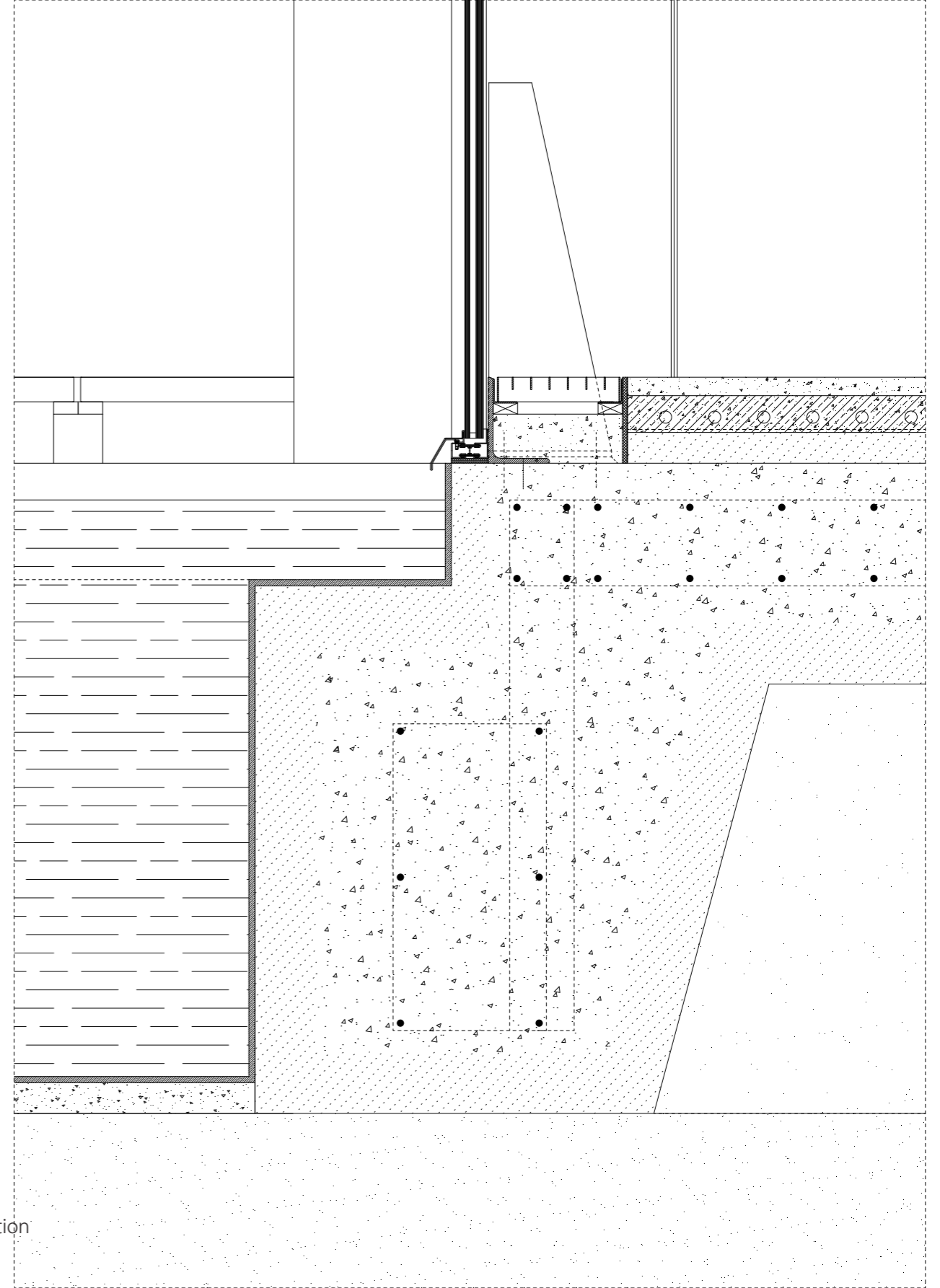

Vertical Detail Glass - Foundation

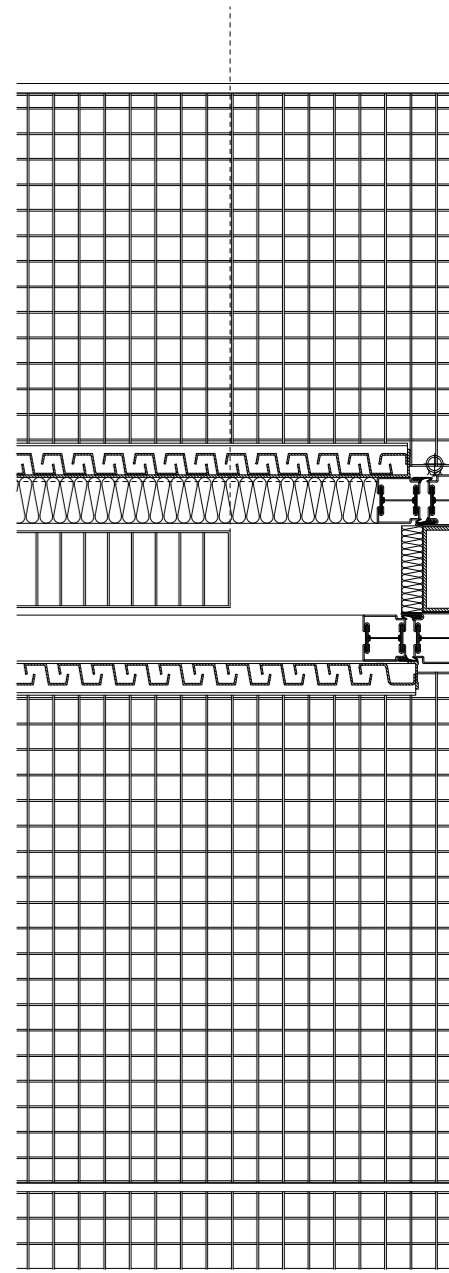
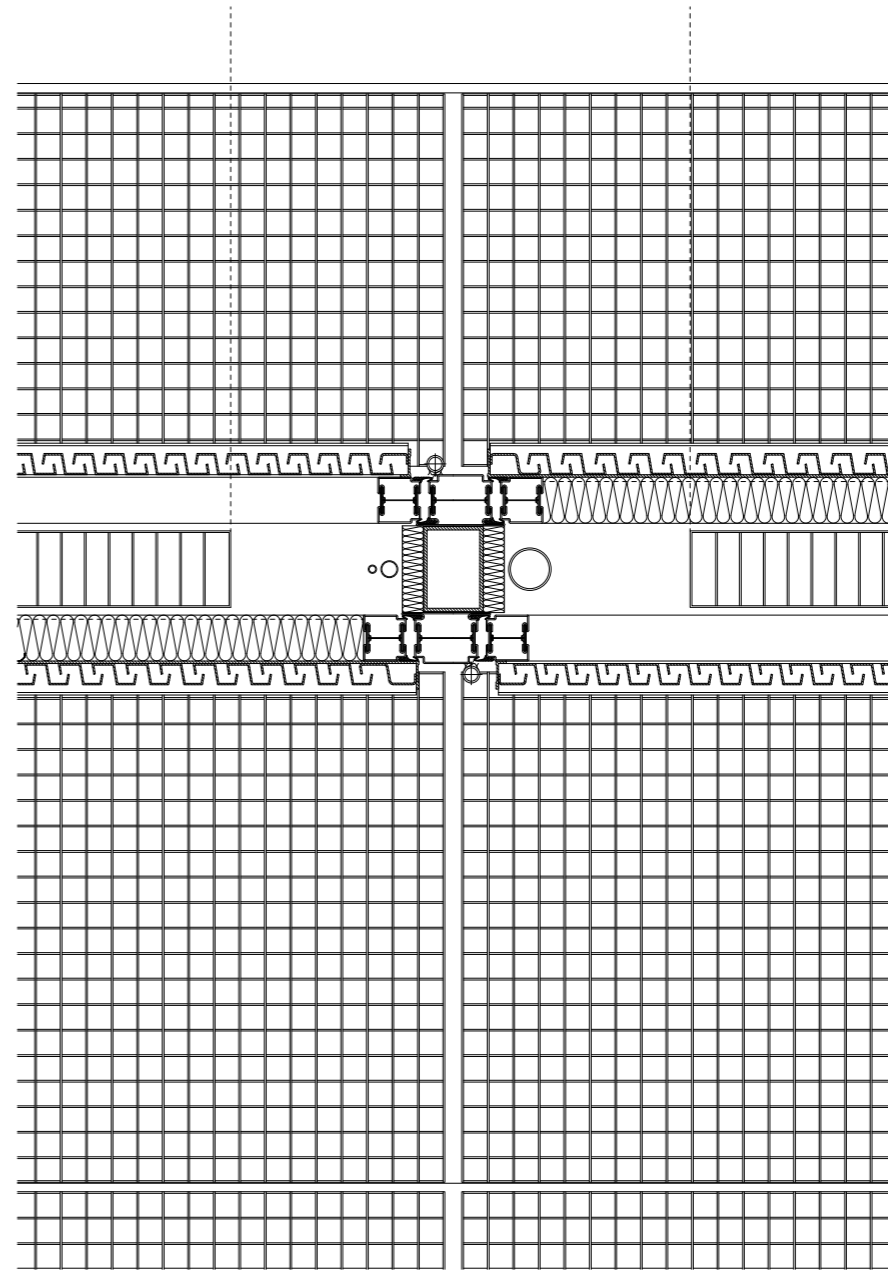
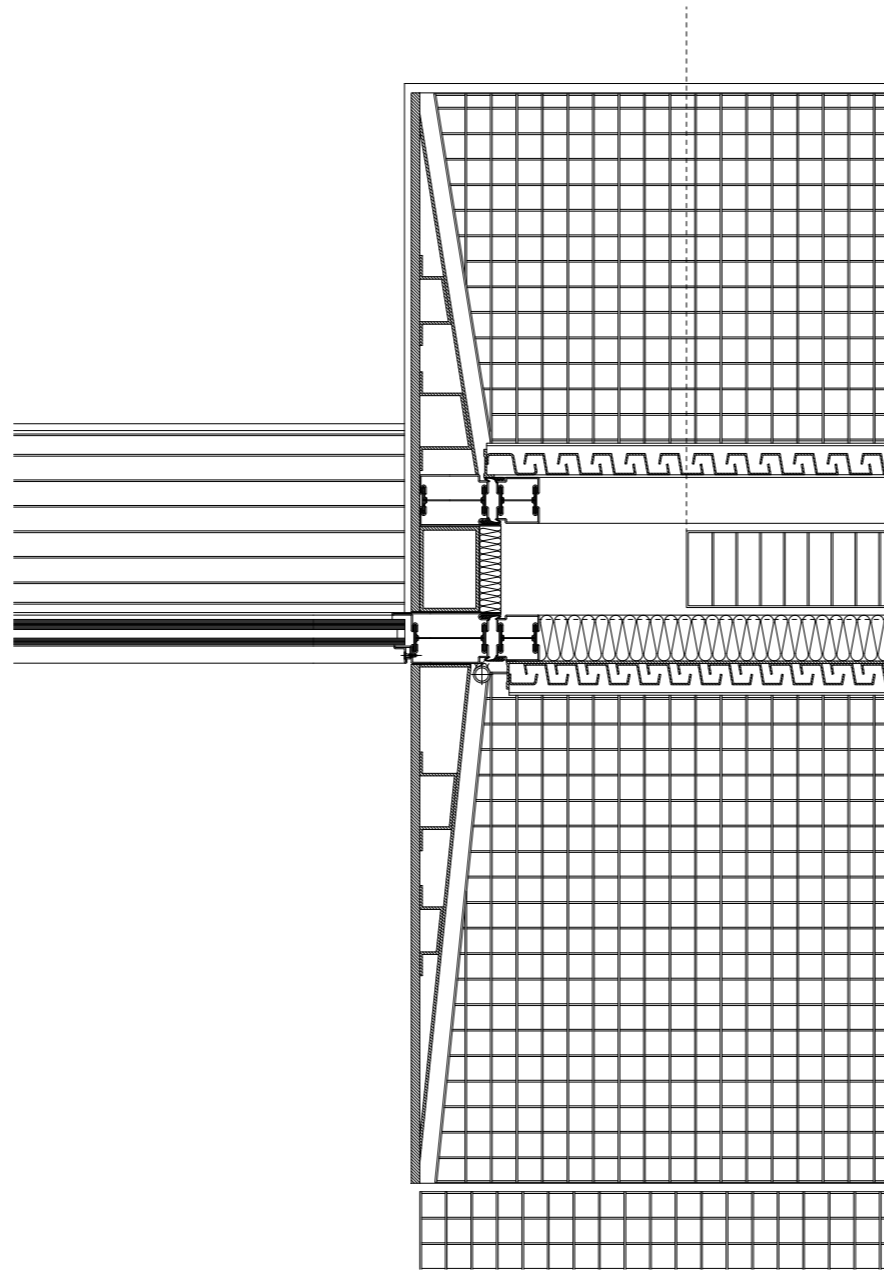
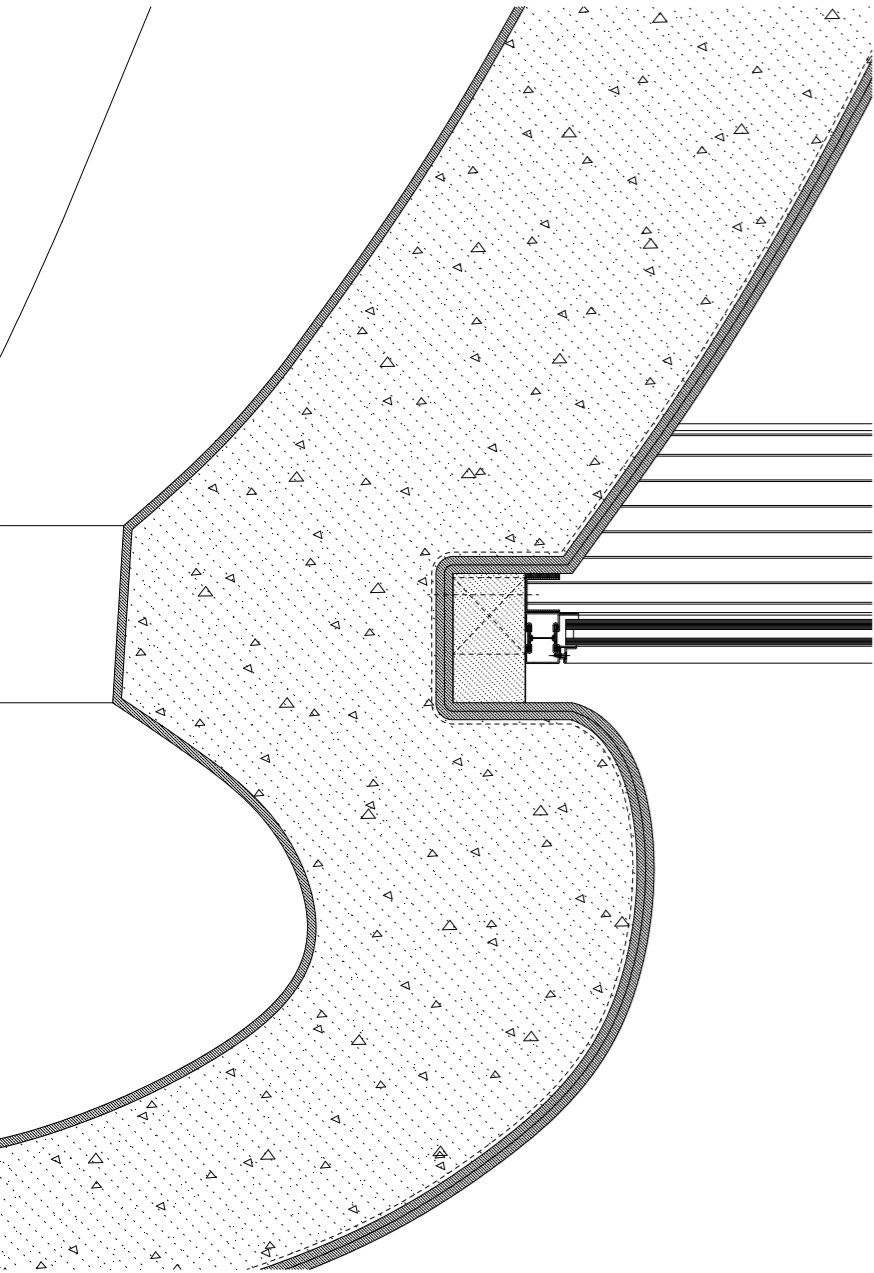

Horizontal Detail Shell - Glass - Portal

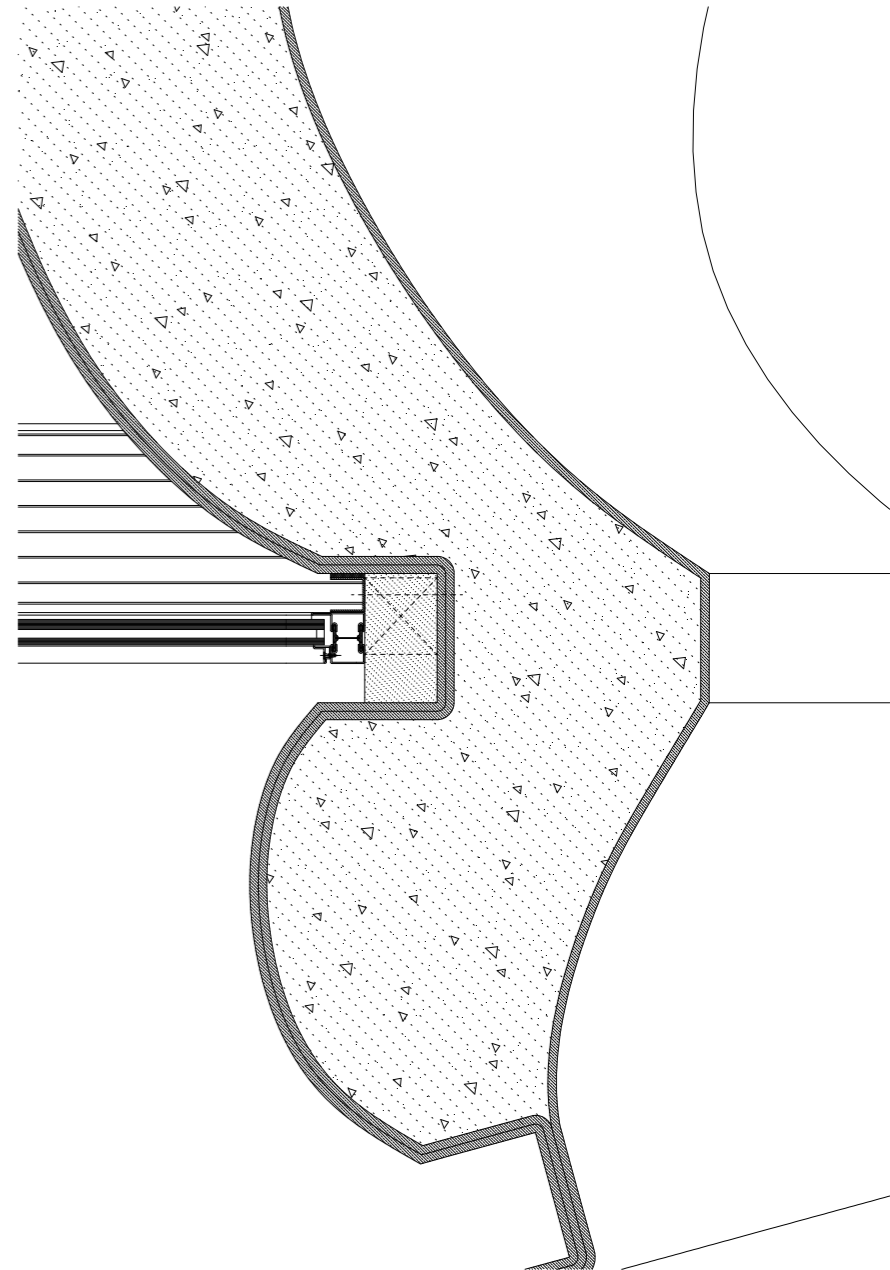
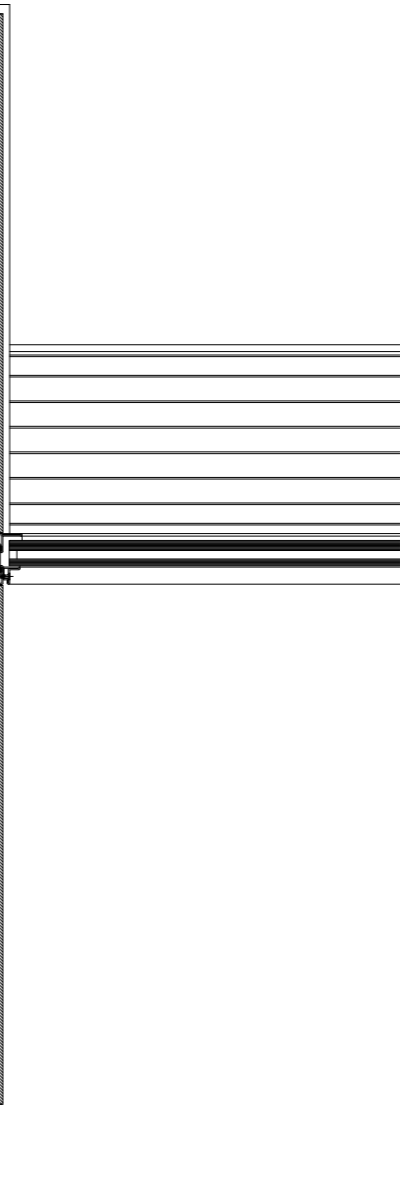
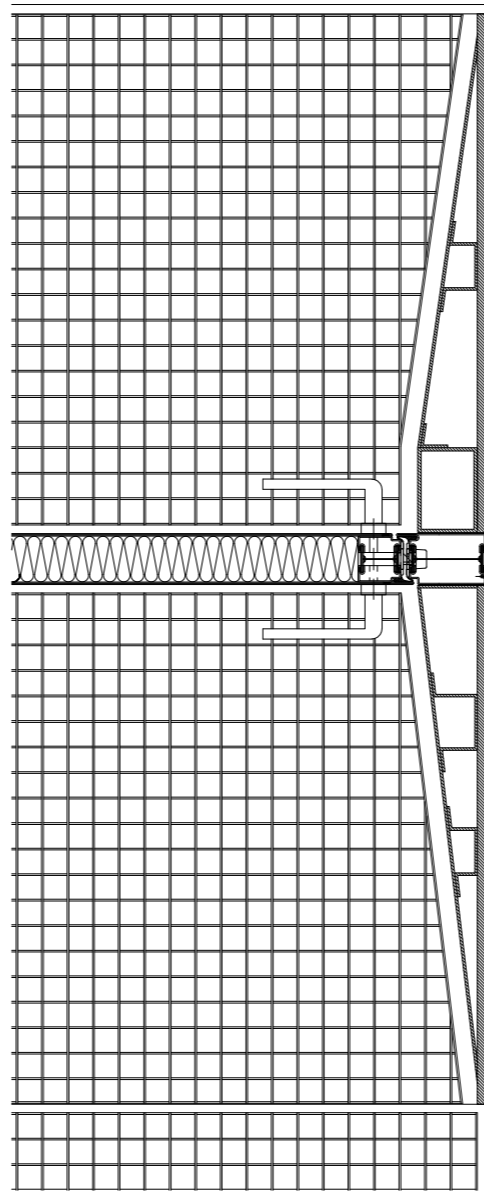
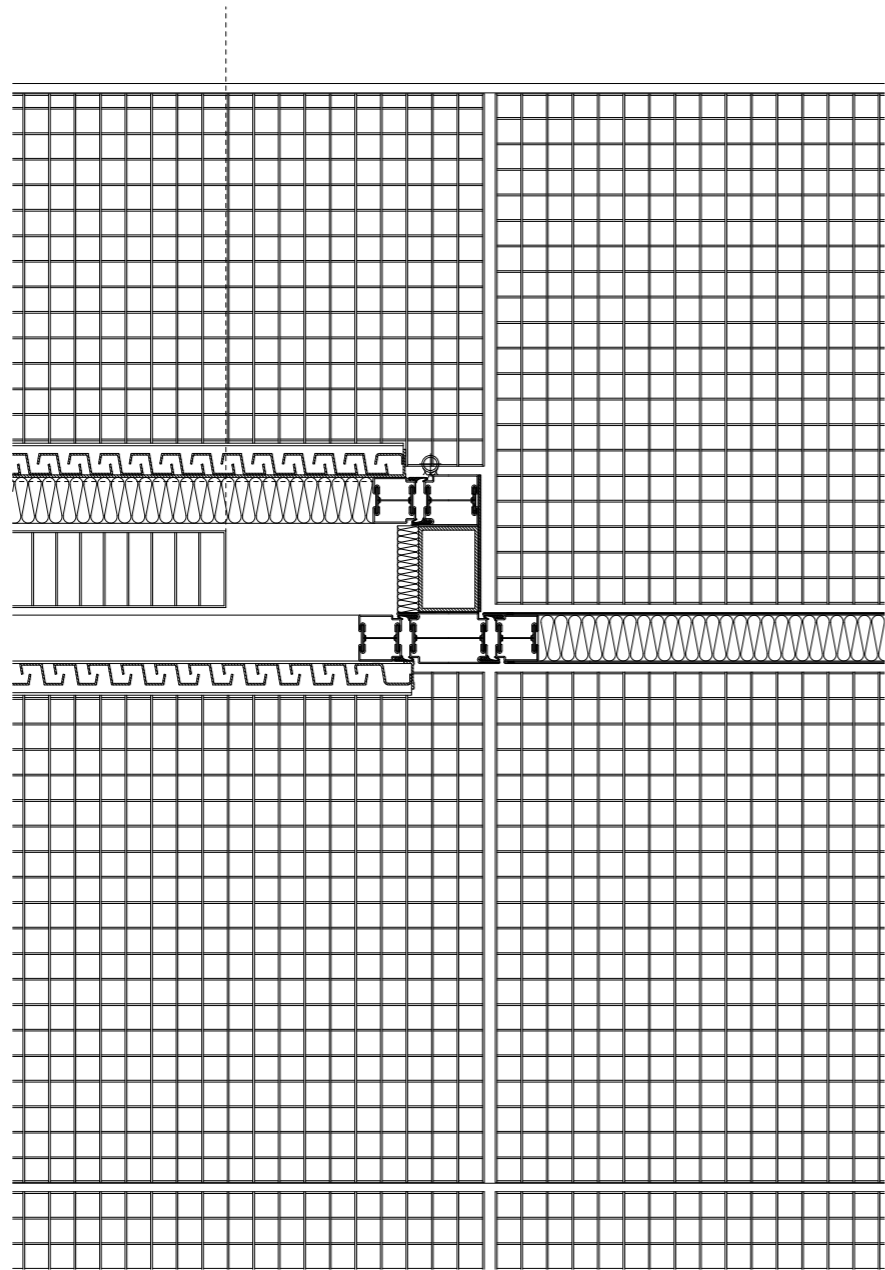
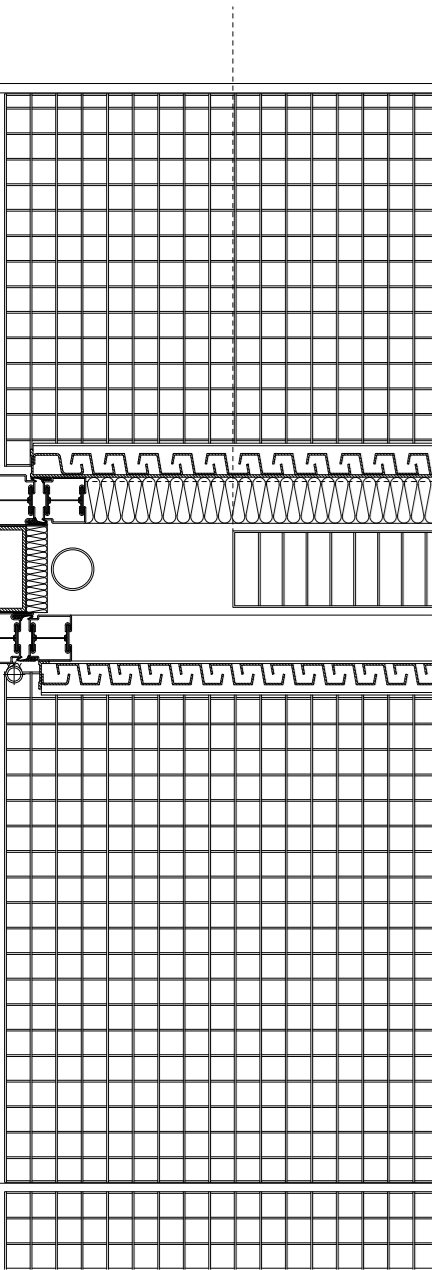

Horizontal Detail Shell - Glass - Portal

REFLECTION

OBJECTIVES

Eliminating the extraction of limited resources

Creating high-end construction material from low-valued wastes

Making a material-based design

Room for exploration & change

Example

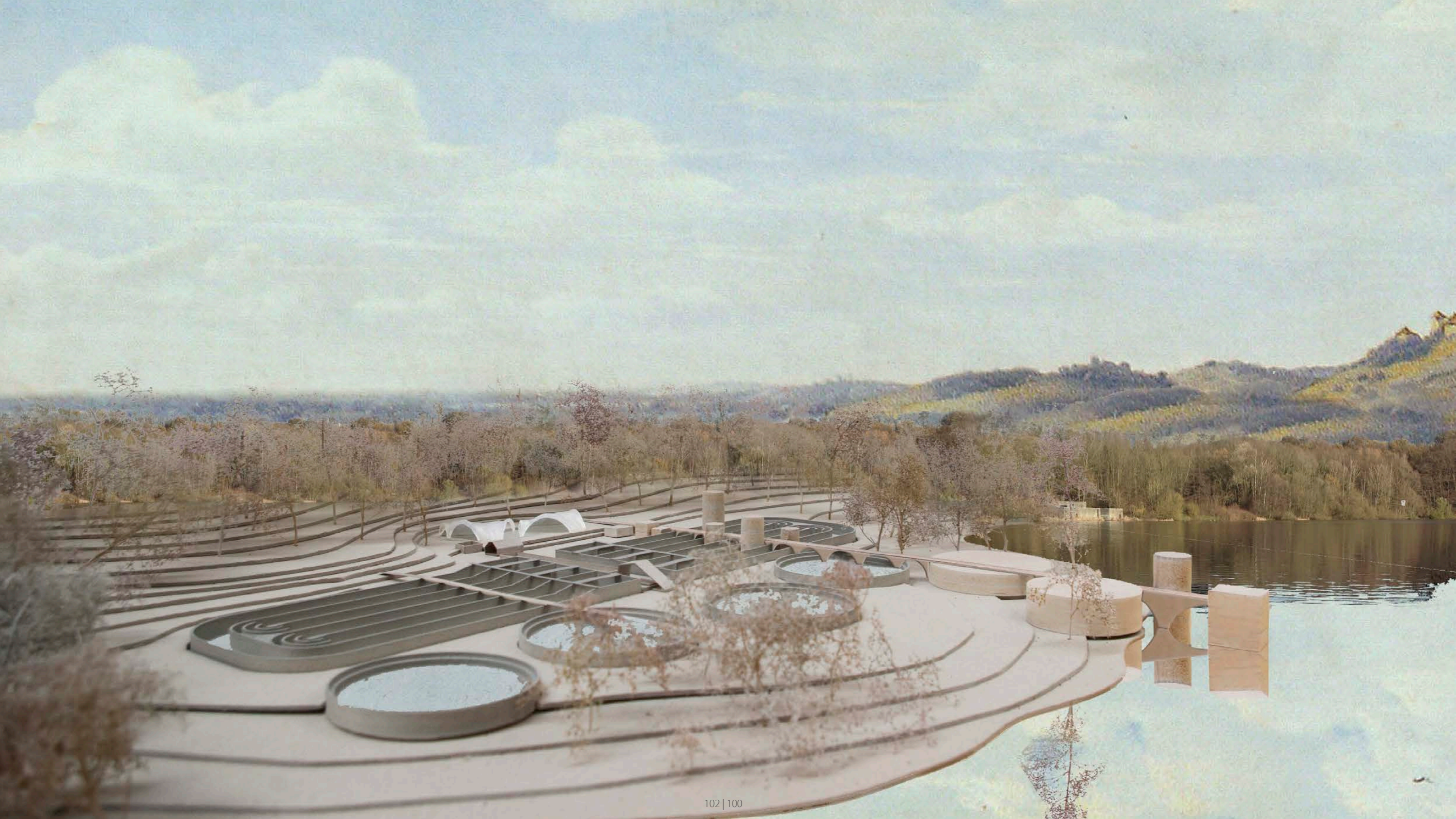



INFINITE MINING for STRUCTURAL COMPOSITES

P5, Msc Architectural Engineering & Technology
Delft University of Technology

01 / 07 / 2016

Stefanie Tseggai

Tutors:
Job Schroen
Maarten Meijs
Jan Jongert

