

Liquid-Liquid-Gas Triphasic Hydrogenation of Bicarbonate to Formate in a Continuous Flow Tubular Reactor

Afreen, Gul; Bansode, Atul; Wada, Kazuhito; Hirano, Makoto; Matsuda, Hirokazu; Urakawa, Atsushi

DOI

[10.1002/adsc.202301330](https://doi.org/10.1002/adsc.202301330)

Publication date

2024

Document Version

Final published version

Published in

Advanced Synthesis and Catalysis

Citation (APA)

Afreen, G., Bansode, A., Wada, K., Hirano, M., Matsuda, H., & Urakawa, A. (2024). Liquid-Liquid-Gas Triphasic Hydrogenation of Bicarbonate to Formate in a Continuous Flow Tubular Reactor. *Advanced Synthesis and Catalysis*, 366(4), 982-989. <https://doi.org/10.1002/adsc.202301330>

Important note

To cite this publication, please use the final published version (if applicable). Please check the document version above.

Copyright

Other than for strictly personal use, it is not permitted to download, forward or distribute the text or part of it, without the consent of the author(s) and/or copyright holder(s), unless the work is under an open content license such as Creative Commons.

Takedown policy

Please contact us and provide details if you believe this document breaches copyrights. We will remove access to the work immediately and investigate your claim.

Liquid-Liquid-Gas Triphasic Hydrogenation of Bicarbonate to Formate in a Continuous Flow Tubular Reactor

Gul Afreen,^a Atul Bansode,^a Kazuhito Wada,^b Makoto Hirano,^b
Hirokazu Matsuda,^b and Atsushi Urakawa^{a,*}

^a Catalysis Engineering, Department of Chemical Engineering, Delft University of Technology, Van der Maasweg 9, 2629 HZ Delft, The Netherlands

Phone number: +31(0)152789402

E-mail: A.Urakawa@tudelft.nl

^b Corporate Research and Development Division, Sustainable Technology Research Centre, Nitto Denko Corporation, 567-8680 Osaka, Japan

Manuscript received: November 15, 2023; Revised manuscript received: January 6, 2024;

Version of record online: ■■, ■■



Supporting information for this article is available on the WWW under <https://doi.org/10.1002/adsc.202301330>

This is an open access article under the terms of the Creative Commons Attribution License, which permits use, distribution and reproduction in any medium, provided the original work is properly cited.

Abstract: Multiphasic reaction of bicarbonate hydrogenation to form formate using homogeneous Ru PNP pincer catalyst in a continuous flow tubular reactor is reported. The reaction system consists of three phases. Catalyst is dissolved in toluene while potassium bicarbonate is dissolved in water. The significance of efficient mixing among the organic phase, aqueous phase and gaseous hydrogen to improve hydrogenation reaction by using different inert packing materials is studied by operando visualization and also quantitatively discussed. The bicarbonate conversion of up to 67% is achieved after optimization of important reaction and reactor parameters. The designed reactor setup comprised of effective recycling system that recycles the catalyst with >99% activity.

Keywords: CO₂ hydrogenation; Triphasic reaction; Packed-bed reactor; Homogeneous catalyst; Formic acid

Introduction

The ever-increasing atmospheric concentration of carbon dioxide (CO₂) resulting from high energy demand and industrialization is a major concern regarding global warming and climate change.^[1] Among various strategies to control CO₂ emission into the atmosphere and/or capture CO₂ from the atmosphere, CO₂ utilization to produce a variety of C1 chemicals like formaldehyde, formic acid, methanol, and methane through hydrogenation reaction is an effective approach.^[2] Among these, formic acid (HCOOH) or formate (HCOO⁻) is an industrially valuable commodity chemical with uses in preservatives, synthesis precursors, and most notably, as a hydrogen carrier.^[3–5] Its easy decomposition and reversible nature make it an exceptional liquid organic hydrogen carrier (LOHC), capable of storing hydrogen effectively.^[6] However, the process of formic acid

formation from CO₂ hydrogenation is an endergonic catalytic reaction making the reaction thermodynamically unfavourable (equation 1).^[7,8]

Many basic additives such as KOH and NaHCO₃ are used to promote the reaction and overcome the thermodynamic limitations (equation 2).^[9] Another interesting approach is direct reduction of bicarbonate to formate since CO₂ remains in equilibrium with bicarbonate in aqueous medium.^[6,10] Also, bicarbonates are easily formed from CO₂ and alkanol amines. Such hydrogenation reactions have been studied predominantly using homogeneous catalysts such as noble metal (e.g. Ru, Rh and Ir) complexes in batch reactors under high pressure conditions (~60–100 bar).^[2,7,11–15] A few other literature reports discuss the bicarbonate hydrogenation using non noble metal complexes containing Co, Fe or Ni.^[4,16] Among these catalysts, Ru complex is reported to be a prominent catalyst for the above homogeneous reaction.^[8,17] However, catalyst

recovery and recycle become difficult in batch reactor systems, which makes the overall process economically less attractive for industry.

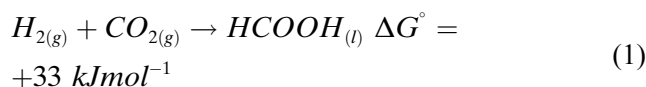

Herein, the hydrogenation of potassium bicarbonate to potassium formate using Ru complex as catalyst in a uniquely designed continuous flow tubular reactor is reported. The advantage of this continuous flow tubular reactor for this reaction compared to the batch reactors reported in literature is the continuous conversion of bicarbonates into formates, reduction of dead time (like charging and discharging of reactor), and continuous catalyst recovery and recycle, thus increasing the reaction performance. The catalyst is dissolved in the organic solvent, toluene; whereas, potassium bicarbonate is dissolved in deionized water. A phase transfer catalyst is added in the organic phase to enhance the interaction between components in organic phase and aqueous phase. The scheme for this triphasic reaction (organic phase-aqueous phase-gaseous hydrogen) is shown in Figure 1.^[6] Moreover, efficient mixing of phases in multiphase reaction systems to achieve significant conversion is an important aspect. In case of batch and CSTR (Continuously Stirred Tank Reactor) systems, stirring at certain rpm provides the required phase mixing; whereas, to obtain such phase mixing in tubular reactor systems is a challenge. Herein, different inert materials based on their shape and affinity to liquids are used to pack the reactor tube. These inert packing materials provide surfaces for collapse and coalescence of bubbles inside the reactor tube. Such phenomena results in higher interaction between the catalysts and reactants present in three different phases, thereby, improving the conversion. To the best of our knowledge, development and utilization of such reactor system for this reaction has not been reported yet.

Results and Discussion

The hydrogenation of potassium bicarbonate to potassium formate using the Ru PNP pincer catalyst under continuous flow conditions was performed. The reactor setup (Figure 2, described in Experimental section) was designed to conduct this reaction by mixing three phases of organic liquid (toluene) dissolving catalyst and PTC, aqueous liquid dissolving potassium bicarbonate and gaseous hydrogen.^[18] For efficient mixing of the phases, different inert packing materials inside

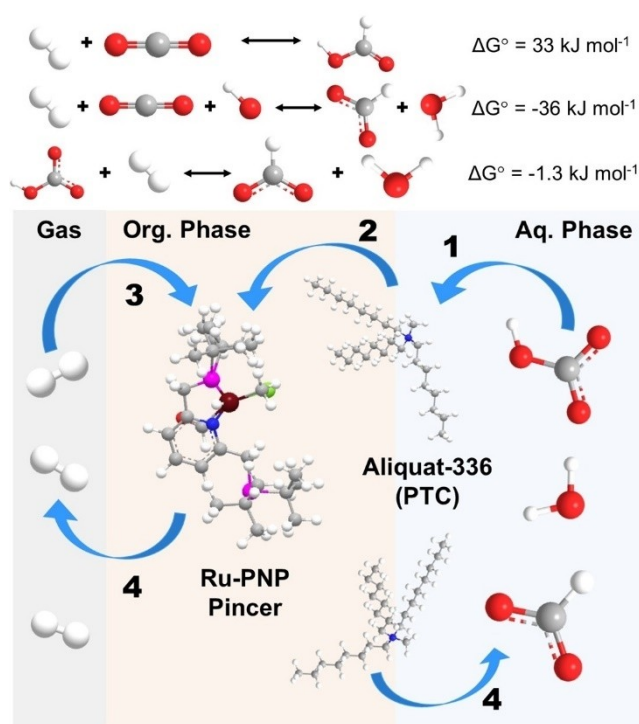

Figure 1. Reactor scheme of potassium bicarbonate hydrogenation using Ru-PNP pincer catalyst and Aliquat-336 as phase transfer catalyst (PTC). Ru-PNP pincer catalyst is present in organic phase while potassium bicarbonate and the product potassium formate are present in aqueous phase.

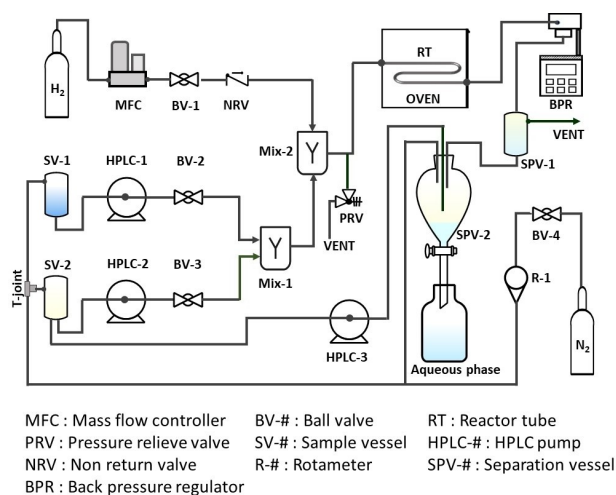

Figure 2. Process flow diagram of the continuous flow tubular reactor system.

the reactor tube were tested in the reaction and the results were compared with empty reactor tube where three phases are macroscopically separated (*vide infra*). The reaction parameters such as catalyst concentration, bicarbonate concentration and residence time were also

optimized while keeping the temperature at 90 °C and pressure at 40 bar for all the reactions.

Influence of Catalyst and Bicarbonate Concentrations

The 110 cm long reactor tube was packed with 2.0 mm SiC (irregular shape) and catalyst concentrations of 0.1, 0.2 and 0.4 mM were used to analyze their effect on the reaction performance as shown in Figure 3(a). When the catalyst concentration was increased from 0.1 to 0.2 mM, the bicarbonate conversion increased from 21% to 33% while TON decreased from 2950 to 2330, respectively. Further increase of the catalyst concentration to 0.4 mM affected negatively, resulting in decrease of conversion to 15% with TON of 530. The lower bicarbonate conversion and TON indicate that when homogeneous catalyst concentration is high, they can start interacting intermolecularly, possibly causing negative effects (e.g. formation of less active or non-active sites). This can be explained by the formation of inactive hydride-bridged metal dimers after the acid-induced or thermal dissociation of ligand from Ru center.^[19,20]

Figure 3(b) shows the effect of potassium bicarbonate concentration on reaction performance. The graph shows that the bicarbonate conversion was 67% for 0.5 M bicarbonate solution. However, when bicarbonate concentration increased to 1.25 M and 1.5 M, the conversion decreased to 33% and then to 31%,

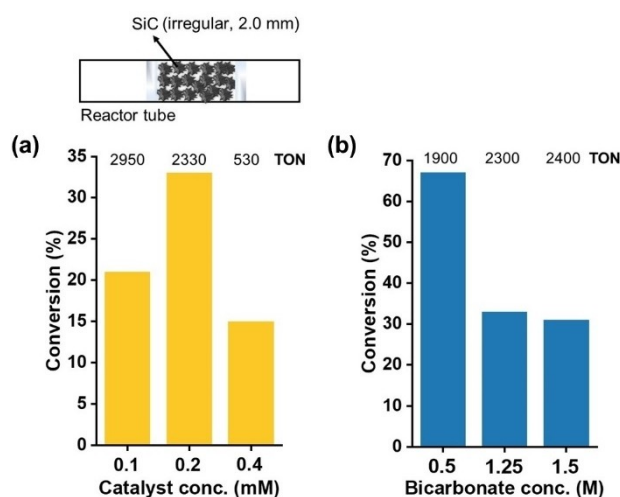

Figure 3. (a) Effect of catalyst concentration (KHCO₃: 1.25 M, PTC: 25 mM, τ : 270 min, F_{aq} , F_{or} : 0.025 ml min⁻¹, F_{H_2} : 6 ml_n min⁻¹, T: 90 °C, P: 40 bar) and (b) Effect of bicarbonate concentration (Catalyst: 0.2 mM, PTC: 25 mM, τ : 70 min, F_{aq} , F_{or} : 0.025 ml min⁻¹, F_{H_2} : 6 ml_n min⁻¹, T: 90 °C, P: 40 bar). τ is the residence time, F_{aq} is the flow rate of aqueous phase, F_{or} is the flow rate of organic phase, F_{H_2} is the flow rate of hydrogen at normal conditions, T is the reaction temperature, and P is the reaction pressure.

respectively. On the other hand, the TON values were increased from 1900 to 2300 and to 2400 with increase in bicarbonate concentration. The increase was relatively minor considering the magnitude of increase in the bicarbonate concentration. This implies that the bicarbonate conversion is mainly limited by the activity of the catalyst and not by the concentration of bicarbonate as one of the reactants.

To maintain the conversion and TON values to an optimum, catalyst concentration of 0.2 mM and bicarbonate concentration of 1.25 M were selected for further reactions.

Influence of Residence Time

The effect of residence time on the reaction performance was analyzed using four combinations of reactor tube length and liquid flow rates: (1) 110 cm long reactor tube and 0.1 ml min⁻¹ flow rate, (2) 110 cm long reactor tube and 0.025 ml min⁻¹ flow rate, (3) 330 cm long reactor tube and 0.1 ml min⁻¹ flow rate, and (4) 330 cm long reactor tube and 0.025 ml min⁻¹ flow rate. The bicarbonate conversion and TON as function of residence time for each reaction condition are summarized in Figure 4. The conversion increased

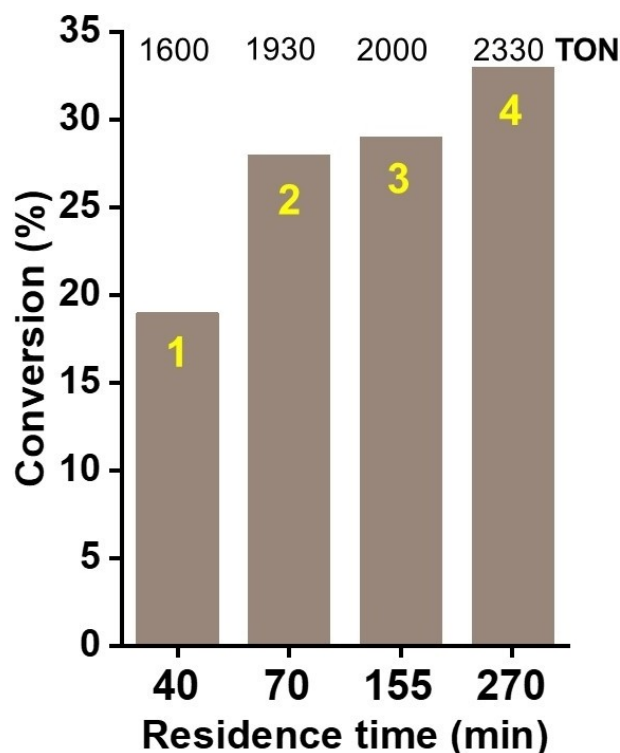

Figure 4. Effect of residence time (Catalyst: 0.2 mM, PTC: 25 mM, KHCO₃: 1.25 M, F_{aq} , F_{or} : 0.1 (1 & 3) and 0.025 (2 & 4) ml min⁻¹, RT length: 110 cm (1 & 2) and 330 cm (3 & 4), F_{H_2} : 6 ml_n min⁻¹, T: 90 °C, P: 40 bar) on bicarbonate conversion and TON.

from 19% to 28% and TON increased from 1600 to 1930 when residence time increased from 40 min to 70 min. Further increase in residence time to 155 min and 270 min, bicarbonate conversion only increased slightly to 29% and 33% and TON increased to 2000 and 2330, respectively. This indicates that more mass transfer limitations take place at longer residence time. This can be due to the coalescence of initially better-dispersed liquid/gas phases. Longer residence times improve the activity but not linearly.

Influence of Packing Material

Three different inert packing materials in 110 cm long reactor tube were tested to evaluate the effect of hydrophobic or hydrophilic properties on the gas-liquid-liquid mixing behaviour. The packing materials were similar in size, although their shapes were not uniform due to the availability. Glass beads (GB, spheres, 2.2 mm) are hydrophilic in nature and tend to wet with and hold the aqueous phase longer inside the reactor tube as compared to the organic phase. On the other hand, SiC (irregular shape, 2.0 mm) and PTFE (hollow cylinders, 2.0 mm) are hydrophobic in nature and do not show affinity towards the aqueous phase. Figure 5 shows the conversion and TON of potassium bicarbonate hydrogenation reaction at 40 bar, 90 °C and 40 min residence time. The reactor packed with the glass beads showed a bicarbonate conversion of only 6% and TON of 400. This poor performance is probably because the beads retained the aqueous phase inside the reactor tube longer than the organic phase, as observed by initial predominant presence of the organic phase in the effluent stream, resulting in non-ideal contact at the reactive liquid-liquid interface and

lesser contact between potassium bicarbonate and active catalyst. PTFE and SiC packed reactors gave conversions of 9% and 19% and TON of 575 and 1600, respectively. The higher conversion in case of SiC is probably due to its characteristic wetting behaviour with the aqueous and organic phases.^[21] Although the shape of the particles (irregular vs. hollow shape) may have some effects, the large difference in the reaction performance indicates that among the three materials, SiC offers the best environment for better mixing of the liquid-liquid-gas phases by its interaction strengths with the three phases.

Influence of Particle Size of Packing Material

Since SiC-packed reactor showed better reaction performance than those packed with PTFE or GB, different particle sizes of SiC (0.25, 0.7 and 2.0 mm) were studied to elucidate their effect on bicarbonate hydrogenation reaction. The results were compared with the blank reaction with the empty reactor tube of 110 cm long as shown in Figure 6. As evident from the graph, the blank run gave only 1% of conversion and 151 TON due to very poor mixing among the phases at 40 bar pressure indicating the importance of inert packing material for better reaction performance. The visualization results under the reaction condition (40 bar) using a quartz tube reactor (i.d.: 1.76 mm, length 14 cm) are presented in Figure 7, showing a clear segregation of the three phases. Such a clear phase segregation leads to poor hydrogen dissolution to the organic phase and small interfacial areas of the liquid-liquid phase to catalyze the reaction efficiently. With the SiC packing, bicarbonate conversion and TONs were enhanced, exhibiting the values of 13%, 16% and 19% and 925, 1370 and 1600 for 0.25, 0.7

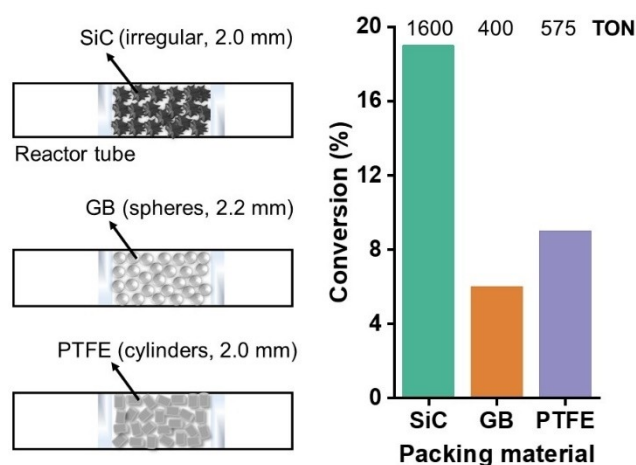

Figure 5. Effect of packing material (Catalyst: 0.2 mM, PTC: 25 mM, KHCO_3 : 1.25 M, τ : 40 min, F_{aq} , F_{or} : 0.1 ml min^{-1} , F_{H_2} : 6 $\text{ml}_n \text{min}^{-1}$, T: 90 °C, P: 40 bar) on bicarbonate conversion and TON.

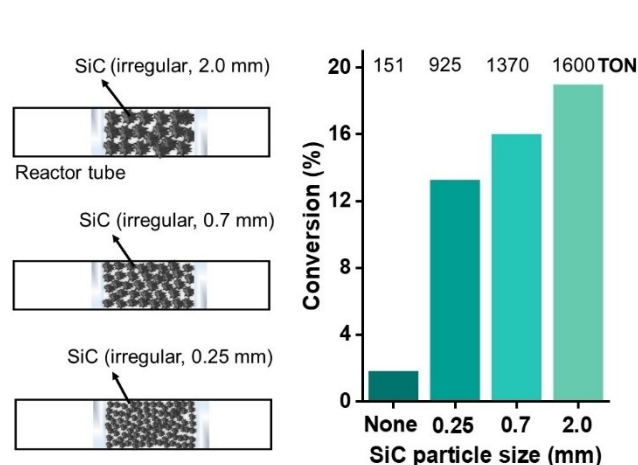

Figure 6. Effect of particle size of packing material (Catalyst: 0.2 mM, PTC: 25 mM, KHCO_3 : 1.25 M, τ : 40 min, F_{aq} , F_{or} : 0.1 ml min^{-1} , F_{H_2} : 6 $\text{ml}_n \text{min}^{-1}$, T: 90 °C, P: 40 bar) on bicarbonate conversion and TON.

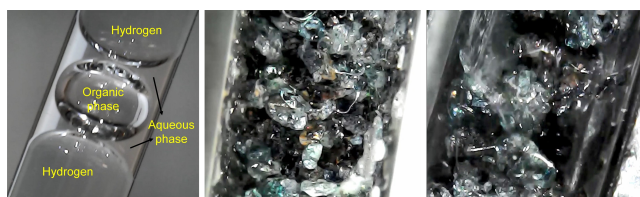

Figure 7. *Operando* phase-behaviour visualization study without (left) and with the SiC packing material (middle: 0.25 mm, right: 0.7 mm). The recordings are available in the Supporting Information.

and 2.0 mm SiC, respectively (Figure 6). However, the trend of the reactivity enhancement was opposite to our expectation, and we thought that with smaller SiC particles, a higher reaction performance would be possible due to better mixing. In practice, the larger SiC particles gave a better reaction performance.

Operando visualization of the SiC packed reactor by passing the triphasic mixture shows detailed insights into the phase behaviour. Figure 7 shows snapshots of the experiments and compares the phase and mixing behaviours under the reaction condition without and with the SiC packing materials (since the inner diameter of quartz tube was 1.7 mm, SiC of 2.0 mm could not be studied). Corresponding recordings can be found in the Supporting Information. In the presence of the packing materials, the fluid phases are better dispersed as expected. At quick glance, the bubbles and liquid phases stay relatively large when the larger packing material (0.7 mm) was used, compared to the case when the smaller packing material (0.25 mm) was packed. A closer look into the recordings, however, shows that the flow behaviour is significantly affected by the packing material size. When the smaller particles were packed, we observed that fluids, especially hydrogen gas, pass more dominantly near the reactor wall (i.e. via channelling and by-passing), likely due to the higher pressure drop through the packed-bed. This pressure drop is also likely more pronounced by the wetting by liquids. This by-passing and preferential wetting in the middle of the reactor is not a favourable condition for mixing and thus the reaction performance. When the packing material is larger, larger bubbles and droplets are observed; however, they move along the packed bed which induces a good level of three phase mixing. These observations are in line with the packing material size effect on the catalytic performance (Figure 6). Also, reaction pressure seems to positively affect the mixing behaviour by making the hydrogen bubbles smaller and decreasing the actual residence time of the gaseous phase through the reactor by compression. The recordings of the pressure effects (recorded at 1 bar) are also included in the Supporting Information to see the impacts of the reaction pressure on the wetting and

mixing behaviour. Furthermore, the mixing behaviour was quantitatively evaluated by counting the number of hydrogen bubbles which appeared in a specified area to examine the effects of SiC particle size and also reaction pressure (1 vs. 40 bar) on the number of hydrogen bubbles. The results are summarized in Figure S1 (Supporting Information), showing higher number of hydrogen bubbles at higher pressure with larger SiC particles. The results confirm the discussion above and higher pressure and larger SiC enhanced the mixing of the triphasic fluid to achieve better catalytic performance.

Another interesting observation is the wetting behaviour of the fluids with SiC. To study this behaviour, we used a dye (methyl orange, Merck) in an aqueous phase to observe more precisely different phases and their behaviour. The recordings made at 40 bar (Supporting Information) show that the fluids are not well in contact with the front of the SiC bed and the fluids starts wetting from the wall of the reactor. This wetting behaviour, affected by the hydrophilicity/hydrophobicity and viscosity among others, shows the beauty and challenges of optimizing multiphase reaction systems. More precise understanding and optimization of the mixing behaviour is currently under investigation.

Catalyst Recycling

The Ru PNP pincer catalyst is homogeneously dissolved in the organic solvent (toluene) and is very effective in bicarbonate hydrogenation reactions. However, it is extremely sensitive to oxygen and therefore, is prepared and contained under inert atmosphere. Also, it contains noble metal and the ligand precursors which are expensive. Therefore, recovery and recycle of this catalyst without loss in its activity is extremely important to scale up this process. Figure 8 shows the graph of bicarbonate conversion using fresh catalyst and the recycled catalyst with time on stream. After the reaction with fresh catalyst, the organic phase containing catalyst and PTC were pumped via a HPLC pump to the reactor inlet for recycling reaction. The recycled catalyst was observed to be almost completely active (>99%) as the fresh catalyst. This shows that the catalyst recovery and recycle are very efficient in this uniquely designed continuous flow tubular reactor setup.

Conclusion

Triphasic hydrogenation of potassium bicarbonate to form potassium formate using Ru PNP pincer catalyst in a uniquely designed continuous flow tubular reactor was performed. An optimum catalyst concentration of 0.2 mM and bicarbonate concentration of 1.25 M was found to produce significant amount of formate.

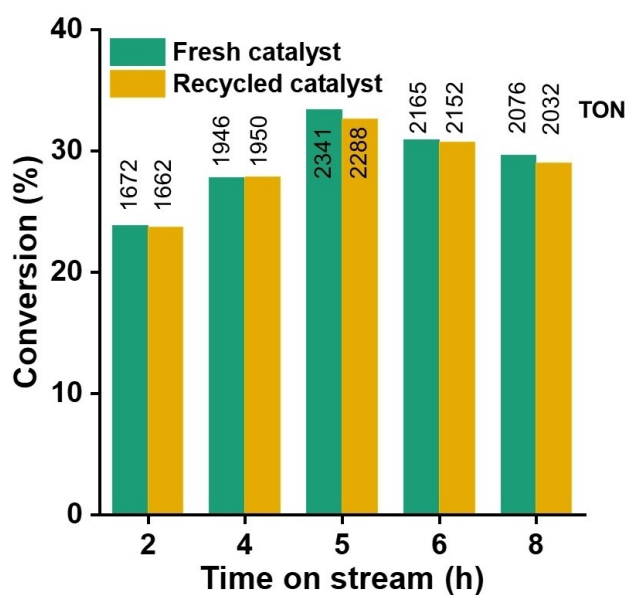

Figure 8. Catalyst recycling (Catalyst: 0.2 mM, PTC: 25 mM, KHCO_3 : 1.25 M, τ : 70 min, F_{aq} , F_{or} : 0.025 ml min^{-1} , F_{H_2} : 6 $\text{ml}_n \text{min}^{-1}$, T: 90 °C, P: 40 bar) on bicarbonate conversion and TON.

Longer residence time (270 min) improves the activity with bicarbonate conversion of 33% and TON of 2330, but the conversion does not linearly increase with the residence time, hinting the presence of mass transfer limitation. The significance of packing material on the phase behaviour and the reaction performance was illustrated quantitatively by *operando* visualization. The fluid phases are better dispersed in presence of SiC packing material as compared to the empty reactor. The size of packing material also significantly affects the flow behaviour. With smaller size of packing material (0.25 mm SiC), channelling and by-passing of the fluids and hydrogen gas are predominant due to the higher pressure drop through the packed-bed resulting in preferential wetting in the middle of the reactor, which is unfavourable for mixing and thus, the reaction performance. On the other hand, with larger packing materials (0.7 mm SiC), the liquid fluids and hydrogen gas move along the packed bed which induces a good level of three phase mixing. Moreover, the reaction pressure helps to create smaller but a higher number of hydrogen bubbles and decreases the actual residence time of the gaseous phase through the reactor by compression resulting in better mixing. The uniquely designed tubular reactor setup contained a recycling system that gave recycling efficiency of >99% even without adding antioxidant in the organic solvent. Such reactor system is advantageous in the continuous conversion of bicarbonate into formate, reduction of dead time (like charging and discharging of reactor), and continuous catalyst recovery and recycle, thereby,

increasing the reaction performance as compared to the predominantly reported batch reactor system.

Experimental Section

Materials

The potassium bicarbonate (99.7% purity), potassium formate (99% purity), dimethyl sulfoxide (>99.8% purity), and deuterium oxide (99.9 atom%) were procured from Merck, Sigma-Aldrich. Aliquat-336 and toluene (anhydrous, 99.8% purity) were procured from Thermo Scientific Chemicals. Anhydrous solvents were dried using 4 Å molecular sieves and degassed before use. Moisture and/or air sensitive materials were stored in a glovebox. All preparations were performed under inert atmosphere in a glovebox filled with argon or using Schlenk techniques.

The hydrogenation reaction of potassium bicarbonate to form potassium formate was catalyzed by de-aromatized 2,6-bis(di-*tert*-butylphosphinomethyl)pyridine (PNP) pincer-type Ru^{II} complex. This complex was prepared following the synthesis procedure from report by Gnanaprakasam et al.^[22] and Rebreyend et al.^[6]

Preparation of Organic and Aqueous Phases

For each reaction, organic phase was prepared inside the glove box by mixing different concentration of the Ru-PNP pincer catalyst and methyltrioctylammonium chloride (commercially known as Aliquat-336, a phase transfer catalyst) in 40 ml toluene (already degassed in the Schlenk line) in a round bottom flask and sealed with septum. The aqueous phase was prepared by mixing different concentrations of potassium bicarbonate (KHCO_3) in 40 ml degassed deionized-water in a round bottom flask using the Schlenk line. The aqueous solution was then sonicated for 30 seconds.

Reactor Setup

A continuous flow tubular reactor setup was designed and installed as shown in Figure 2. The organic and aqueous phase liquids were filled in separate 50 ml stainless steel sample vessels (SV-#) by syringe injections through septa under inert atmosphere. The other ends of the sample vessels were connected to the inlet tubes of the two separate HPLC pumps (Jasco PU-4185) used to pump organic and aqueous phases of liquids. These two phases were mixed in a Y-mixer (Mix-1) before entering the reactor tube. Hydrogen gas (99.999% purity) was supplied using hydrogen cylinder connected through high pressure gas line (up to 100 bar) and its flow rate was controlled using high pressure mass flow controller (MFC). The hydrogen gas was mixed with the liquid mixture in a second Y-mixer (Mix-2) and the final liquid-liquid-gas triphasic mixture was passed through the inlet of the reactor tube.

The reactor tube (RT) consisted of a coiled stainless steel tube (o.d.: 6.4 mm and i.d.: 4.6 mm, length: 110 cm and 330 cm) placed inside a heating oven and connected with the inlet and outlet lines with the help of Swagelok compression fittings. The reactor outlet was connected with a back pressure regulator

(BPR, TESCOM) that maintains the desired pressure upstream. The outlet of BPR went to a stainless steel separation vessel (SPV-1) which collected the liquid and vented the gas. The separation vessel was again connected to a glass separating flask (SPV-2) that separated the organic (top layer) and aqueous (bottom layer) phases under inert atmosphere. The aqueous phase containing the unreacted potassium bicarbonate and product potassium formate was collected after a time interval of 1 h from the bottom of the separating flask SPV-2. The organic phase that contained catalyst and PTC was recycled via a third HPLC pump (HPLC-3) under inert atmosphere for the next round of reaction during recycling test.

Packing of Reactor Tube

Stainless steel reactor tubes were packed with different inert materials. First, a 110 cm long RT was used for packing. This reactor was made from three smaller tubes (40 cm, 30 cm, 40 cm) joined with each other by Swagelok compression fittings. The first and third tubes of 40 cm each were empty while the middle tube of 30 cm was filled with a packing material. Second, a 330 cm long RT was made from three empty tubes of 90 cm each joined by Swagelok compression fittings to two smaller tubes of 30 cm each in alternate series pattern. Each reactor tube was fitted inside the oven using Swagelok compression fitting with the Mix-2 mixer at inlet and BPR at outlet.

The inert materials used for packing were: silicon carbide (2.0, 0.7, and 0.25 mm; Cats Import, Hoogvliet), glass beads (borosilicate; 2.2 mm; Merck), and PTFE (Polytetrafluoroethylene; 2.0 mm; prepared from cutting 1/8" tube procured from Jasco into smaller pieces of 2 mm in length). First, the glass wool was placed to block one end of the packing tube. Then packing materials were filled from the open end into the tube. When the required amount of packing material was filled, the open end was also blocked with glass wool.

Procedure for Catalytic Hydrogenation of Potassium Bicarbonate

The organic and aqueous liquids were transferred from round bottom flasks into the stainless steel sample vessels (SV-#) by injection through the septa which were purged with nitrogen (99.999% purity) to maintain an inert atmosphere. The reaction commenced by first pumping aqueous phase using an HPLC pump into the reactor to increase the pressure to 40 bar (reaction pressure) controlled by the BPR. Then, organic phase was pumped into the reactor using another HPLC pump at desired flowrates. Once the pressure reached 40 bar, hydrogen flow of 6 ml min⁻¹ was given and the oven temperature was increased to 90 °C. All the reactions were carried out using nitrogen as an inert gas. The aqueous layer was collected at time intervals of 1 h from the separating flask (SPV-2). The potassium formate produced during the reaction was present in aqueous layer and was quantified by using proton NMR whose sample was prepared by dissolving 100 µl DMSO and 100 µl aliquot of the aqueous layer in 500 µl D₂O for ¹H NMR analysis. NMR spectra were recorded on an Agilent 400-MR DD 400 MHz spectrometer equipped with a 5 mm ONE NMR probe. All

chemical shifts were referenced to residual solvent peaks [D₂O: 4.79 ppm (¹H)].

Formate yield was calculated using equation 3:

$$\text{Formate yield (\%)} = \frac{\text{Moles of formate formed}}{\text{Moles of bicarbonate used}} \times 100 \quad (3)$$

Turnover number (TON) was calculated using equation 4:

$$\text{TON} = \frac{\text{moles of formate formed}}{\text{moles of catalyst used}} \quad (4)$$

Acknowledgements

The authors gratefully acknowledge and thank Prof. E. Pidko, TU Delft, Netherlands for providing Ru PNP pincer catalyst and Nitto Denko corporation, Japan for providing financial support.

References

- [1] A. H. Valekar, K. R. Oh, S. K. Lee, Y. K. Hwang, *J. Ind. Eng. Chem.* **2021**, *101*, 66–77.
- [2] A. Álvarez, A. Bansode, A. Urakawa, A. V. Bavykina, T. A. Wezendonk, M. Makkee, J. Gascon, F. Kapteijn, *Chem. Rev.* **2017**, *117*, 9804–9838.
- [3] A. Bahuguna, Y. Sasson, *ChemSusChem* **2021**, *14*, 1258–1283.
- [4] D. Sivanesan, B. Seo, C. S. Lim, H. G. Kim, *J. Catal.* **2020**, *382*, 121–128.
- [5] A. Weillhard, S. P. Argent, V. Sans, *Nat. Commun.* **2021**, *12*, 1–7.
- [6] C. Rebreyend, E. A. Pidko, G. A. Filonenko, *Green Chem.* **2021**, *23*, 8848–8852.
- [7] R. Kanega, M. Z. Ertem, N. Onishi, D. J. Szalda, E. Fujita, Y. Himeda, *Organometallics* **2020**, *39*, 1519–1531.
- [8] Z. Treigerman, Y. Sasson, *ACS Omega* **2018**, *3*, 12797–12801.
- [9] S. Kattel, P. J. Ramirez, J. G. Chen, J. A. Rodriguez, P. Liu, *Science* **2017**, *355*, 1296–1299.
- [10] A. S. Tossaint, C. Rebreyend, V. Sinha, M. Weber, S. Canossa, E. A. Pidko, G. A. Filonenko, *Catal. Sci. Technol.* **2022**, *12*, 2972–2977.
- [11] T. Schaub, R. A. Paciello, *Angew. Chem. Int. Ed.* **2011**, *50*, 7278–7282.
- [12] T. J. Schmeier, G. E. Dobereiner, R. H. Crabtree, N. Hazari, *J. Am. Chem. Soc.* **2011**, *133*, 9274–9277.
- [13] D. Wei, R. Sang, P. Sponholz, H. Junge, M. Beller, *Nat. Energy* **2022**, *7*, 438–447.
- [14] M. Anafcheh, M. Zahedi, *Catal. Lett.* **2022**, *152*, 1224–1232.
- [15] R. Webber, M. I. Qadir, E. Sola, M. Martín, E. Suárez, J. Dupont, M. M. Martín, E. Suárezsuárez, J. Dupont, M. Martín, E. Suárez, J. Dupont, *Catal. Commun.* **2020**, *146*, 106125.

- [16] J. M. Heltzel, M. Finn, D. Ainembabazi, K. Wang, A. M. Voutchkova-Kostal, *Chem. Commun.* **2018**, *54*, 6184–6187.
- [17] S. Moret, P. J. Dyson, G. Laurency, *Nat. Commun.* **2014**, *5*, 1–7.
- [18] M. Schrimpf, P. A. Graefe, A. Holl, A. J. Vorholt, W. Leitner, *ACS Catal.* **2022**, *12*, 7850–7861.
- [19] W. Yang, G. A. Filonenko, E. A. Pidko, *Chem. Commun.* **2023**, *59*, 1757–1768.
- [20] P. W. N. M. Van Leeuwen, *Appl. Catal. A* **2001**, *212*, 61–81.
- [21] S. R. Kulkarni, V. K. Velisoju, F. Tavares, A. Dikhtiar-enko, J. Gascon, P. Castaño, *Catal. Rev. Sci. Eng.* **2023**, *65*, 174–237.
- [22] B. Gnanaprakasam, J. Zhang, D. Milstein, *Angew. Chem.* **2010**, *122*, 1510–1513.
-

RESEARCH ARTICLE

Liquid-Liquid-Gas Triphasic Hydrogenation of Bicarbonate to Formate in a Continuous Flow Tubular Reactor

Adv. Synth. Catal. **2024**, *366*, 1–9

 G. Afreen, A. Bansode, K. Wada, M. Hirano, H. Matsuda, A. Urakawa*

