

**Converting Waste Toilet Paper into Electricity  
A First-Stage Technoeconomic Feasibility Study**

van der Roest, Els; van der Spek, Mijndert; Ramirez, Andrea; van der Zwaan, Bob; Rothenberg, Gadi

**DOI**

[10.1002/ente.201700247](https://doi.org/10.1002/ente.201700247)

**Publication date**

2017

**Document Version**

Final published version

**Published in**

Energy Technology

**Citation (APA)**

van der Roest, E., van der Spek, M., Ramirez, A., van der Zwaan, B., & Rothenberg, G. (2017). Converting Waste Toilet Paper into Electricity: A First-Stage Technoeconomic Feasibility Study. *Energy Technology*, 5(12), 2189-2197. <https://doi.org/10.1002/ente.201700247>

**Important note**

To cite this publication, please use the final published version (if applicable).  
Please check the document version above.

**Copyright**

Other than for strictly personal use, it is not permitted to download, forward or distribute the text or part of it, without the consent of the author(s) and/or copyright holder(s), unless the work is under an open content license such as Creative Commons.

**Takedown policy**

Please contact us and provide details if you believe this document breaches copyrights.  
We will remove access to the work immediately and investigate your claim.

# Converting Waste Toilet Paper into Electricity: A First-Stage Technoeconomic Feasibility Study

Els van der Roest,<sup>[a, b]</sup> Mijndert van der Spek,<sup>\*,[a, c]</sup> Andrea Ramirez,<sup>[a, d]</sup> Bob van der Zwaan,<sup>[e, f, g]</sup> and Gadi Rothenberg<sup>\*,[e]</sup>

We studied the possibility of converting waste toilet paper (WTP) into electricity. WTP is a waste stream with continuous availability and negative cost, but it is difficult to handle, as it contains fecal matter. The process we explored had two stages: WTP gasification followed by direct conversion into electricity in a high-temperature solid-oxide fuel cell (SOFC). The process was studied on a 10 ktpa scale by using real-life parameter values obtained from industrial sources. We presented the basic system design, as well as its electricity yield and overall efficiency on the basis of detailed mass- and energy-balance calculations. By explorative technoeconomic analysis and sensitivity analysis, we found an electric efficiency of 57%, which is similar to that of a natural gas

combined cycle plant. The levelized cost of electricity (LCOE) was 20.3  $\text{¢kWh}^{-1}$ , which is comparable at present to that of residential photovoltaic installations. The system's capital costs are relatively high, mainly as a result of SOFC investment costs, but we expect these costs to decrease as the market of cells develops. The operating costs are relatively low, partly thanks to the high thermodynamic efficiency ( $\approx 70\%$ ). Currently, the fuel costs are negative (because we use waste as a raw material), yet this could change if the value of WTP would increase as a result of this process. Learning effects could make the system more competitive in the future with an LCOE of approximately 11  $\text{¢kWh}^{-1}$ .

## Introduction

One of the biggest challenges of a sustainable society is the efficient matching of resources and demands.<sup>[1–3]</sup> In our changing world, one way to increase resource efficiency is by looking at waste from a different perspective—as a resource. This idea is highly attractive, as it enables society to close loops and ultimately to become truly sustainable.<sup>[4]</sup> Another advantage of waste is that, per definition, no one wants it, and therefore, its cost is negative. This condition, however, does not apply to all forms of biomass waste: in many cases, waste biomass streams are already part of an existing process.<sup>[5–7]</sup>

Nevertheless, streams of “true waste” do exist. A good example is waste toilet paper (WTP), which is a special and relatively unexplored case. The presence of fecal matter gives it a different juridical status, which limits its use. Waste toilet paper is not considered a resource—as a matter of fact, people usually prefer not to think about it at all. Yet it is a rich source of carbon and contains 70–80 wt% of cellulose on a dry basis.<sup>[8,9]</sup> Furthermore, it is continuously available in the developed world regardless of country and season. In Western Europe, the WTP stream is estimated at 10–14  $\text{kgcapita}^{-1}\text{year}^{-1}$ ,<sup>[8,9]</sup> and accounts for 30–50% of the floating parts of sewage waste water.<sup>[9]</sup> Relative to other forms of municipal waste such as animal/vegetal (average 61  $\text{kgcapita}^{-1}\text{year}^{-1}$  in Europe) or mixed ordinary waste (average 259  $\text{kgcapita}^{-1}\text{year}^{-1}$  in Europe), the stream is modest but is significant.<sup>[10]</sup> Furthermore, WTP is one of the few raw materials with a negative cost. Whereas its value may vary across countries and regions, in the Netherlands

- [a] E. van der Roest, Dr. M. van der Spek, Prof. Dr. A. Ramirez  
Copernicus Institute of Sustainable Development  
University of Utrecht  
Heidelberglaan 2, 3584 CS Utrecht (The Netherlands)  
E-mail: m.w.vanderspek@uu.nl  
Homepage: <http://www.uu.nl/en/research/copernicus-institute-of-sustainable-development>
- [b] E. van der Roest  
Current address: KWR  
Groningenhaven 7, 3430BB Nieuwegein (The Netherlands)  
Homepage: <http://hims.uva.nl/hcsc>
- [c] Dr. M. van der Spek  
Current address: Faculty of Mechanical Engineering, Separation Process Laboratory  
ETH Zürich, Sonneggstrasse 3, 8092 Zürich (Switzerland)
- [d] Prof. Dr. A. Ramirez  
Current address: Department of energy systems and services, section energy & industry, Delft university of technology, Jaffalaan 5, 2628 BX Delft (The Netherlands)
- [e] Prof. Dr. B. van der Zwaan, Prof. Dr. G. Rothenberg  
Van't Hoff Institute for Molecular Sciences  
University of Amsterdam  
Science Park 904, 1098XH, Amsterdam (The Netherlands)  
E-mail: g.rothenberg@uva.nl
- [f] Prof. Dr. B. van der Zwaan  
Energy Research Centre of the Netherlands, Policy Studies  
Amsterdam (The Netherlands)
- [g] Prof. Dr. B. van der Zwaan  
Johns Hopkins University  
School of Advanced International Studies  
Bologna (Italy)

Supporting Information for this article can be found under:  
<https://doi.org/10.1002/ente.201700247>.

© 2017 The Authors. Published by Wiley-VCH Verlag GmbH & Co. KGaA. This is an open access article under the terms of the Creative Commons Attribution License, which permits use, distribution and reproduction in any medium, provided the original work is properly cited.

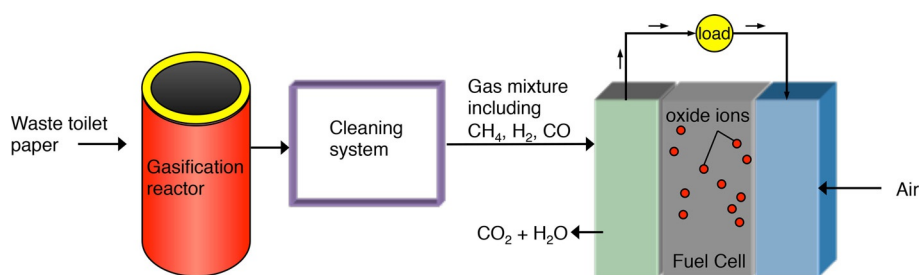


Figure 1. Schematic of the two-step process for converting WTP into electricity by using a gasification device and a SOFC.

the current price is  $-70 \text{ €t}^{-1}$ .<sup>[9]</sup> This value could change if WTP would be viewed as a resource rather than a waste.

In this paper, we match the continuous availability of WTP with society's increasing demand for electricity. We examine the possibility of combining gasification devices with high-temperature solid-oxide fuel cells (SOFCs) by creating a direct route from unwanted waste to a useful product (see Figure 1). Our goal is to assess the feasibility of a WTP-to-electricity system. Using technoeconomic analysis methods for early assessment, we present a basic process design, an overall energy balance, and an economic study for this concept. Our calculations are based on a 10 ktpa scale on the basis of the amount of waste toilet paper that is gathered in the Amsterdam region. The input data were obtained from a sewage-processing company (WaterNet) and a waste-to-energy company (Afvalenergiebedrijf). These companies are located next to each other, which facilitates the logistics of the concept and eliminates transport costs. WaterNet has the possibility to sieve WTP from the wastewater that they collect from all Amsterdam households through the sewage system. This would usually become part of the sludge, but applying WTP separation will result in a 40% reduction in WaterNet's energy use.<sup>[8]</sup> Therefore, WaterNet is currently looking into alternative ways to process waste toilet paper. Here, we discuss one possible option. In other countries and locations, waste-water treatment plants could install sieves to filter out toilet paper, which would thereby reduce their energy use. With the system explained here, WTP can be pressed and processed further on site.

## Results and Discussion

### A process workflow for converting waste toilet paper into electricity

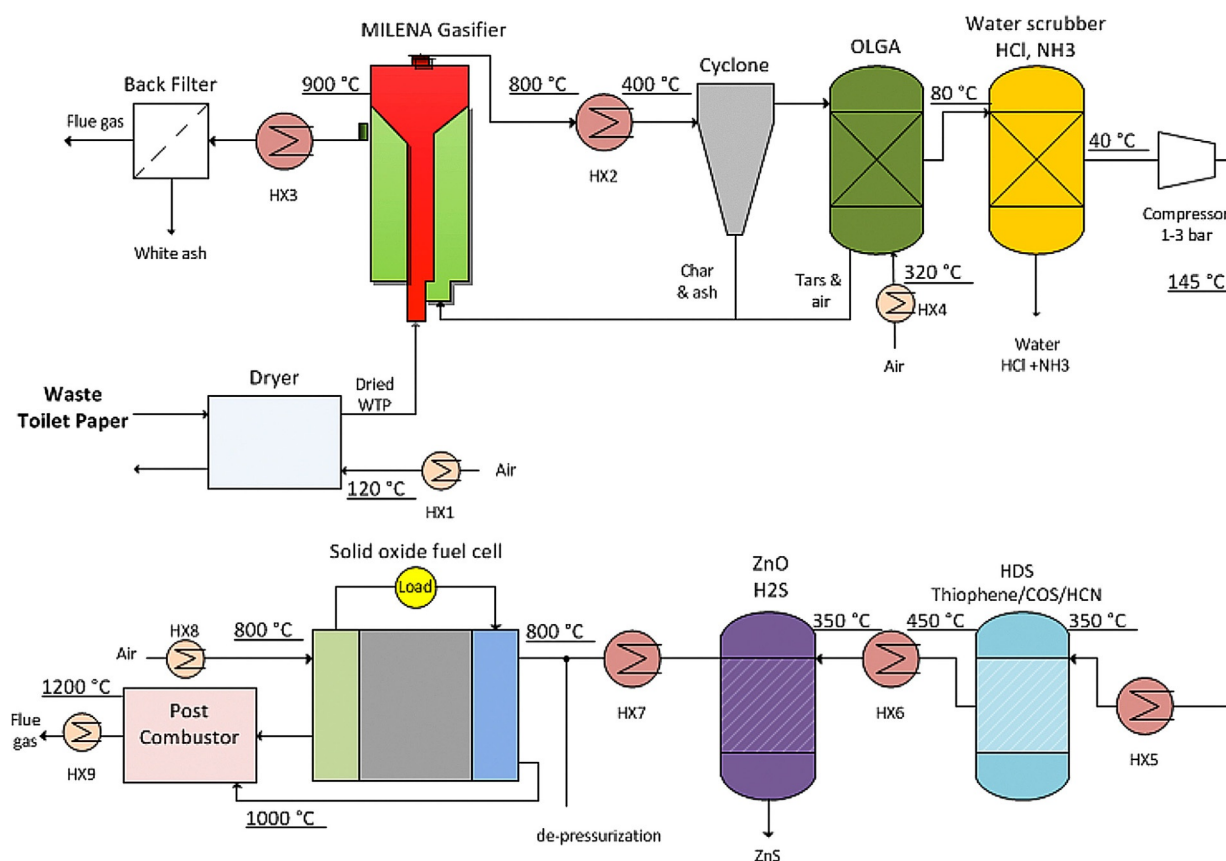
First, we analyzed the composition and calculated the heating value of waste toilet paper (Table 1). These data were used as input for a gasification model based on wood gasification, as wood and WTP have similar cellulose contents.<sup>[11]</sup> For comparison, the data for wood used in the original gasification model are also shown. The model data was integrated into a three-step workflow: gasification, cleaning, and electrochemical conversion.

Figure 2 shows the key units of the process. Before entering the gasifier, the waste toilet paper is dried from 60%

Content	WTP	Standard deviation	Wood <sup>[a]</sup>
<i>Elemental [wt% daf]<sup>[b]</sup></i>			
C	44.92	0.84	48.25
H	6.53	0.38	6.37
O	47.47	1.14	45.23
N	0.58	0.27	0.13
S	0.32	0.48	0.1
Cl	0.19	n.a. <sup>[c]</sup>	0.1
ash <sup>[d]</sup>	4.75	1.35	0.32
moisture <sup>[e]</sup>	60		25
<i>Energy [MJ kg<sup>-1</sup>]<sup>[f]</sup></i>			
LHV <sup>[g]</sup>	16.13		
HHV <sup>[h]</sup>	17.49		

[a] White Labeer pallets, as used in the ECN model.<sup>[11]</sup> [b] daf=dried, ash-free. [c] Not available. [d] In wt% dry. [e] Moisture content for WTP in wt% is before drying; after drying it is reduced to 25% and is thus comparable to that of wood. [f] Derived using the formula of Channiwala and Parikh.<sup>[12]</sup> [g] LHV=lower heating value. [h] HHV=higher heating value.

down to 25% moisture. The energy needed for this drying process can be fulfilled with the rest heat from the gasifier and solid-oxide fuel cell; details of the energy analysis and heat integration can be found in the Supporting Information (parts S1-B and S1-C). It is then gasified in the MILENA gasifier (the inner part, shown in red). The energy for this endothermic step comes from burning char and tar—which are rest products from gasification—in the combustion chamber (the outer part, shown in green). The organic matter is converted into a product gas, which mainly contains hydrogen, carbon monoxide, carbon dioxide, and methane. More information about the reactions occurring during gasification can be found in the Supporting Information (part S1-A). The product gas then passes through a cyclone, which removes char and ash. These are recycled into the combustion chamber of the gasifier. Subsequently, the gas enters the tar removal system (OLGA), which consists of three separate columns to remove both light and heavy tars with scrubbing oil.<sup>[13]</sup> The product gas is cooled to 80 °C in the first column (collector) and removes the heavy tars with scrubbing oil. Then, the product gas enters an absorber, in which light tars are removed and absorbed by scrubbing oil. In the third column, the tars are removed from the scrubbing oil with hot air (320 °C) and are recycled into the combustor. Moreover,



**Figure 2.** Basic process scheme for a plant converting waste toilet paper into electricity. The inner (red) part of the MILENA is the gasifier, whereas the outer (green) part represents the combustor. HDS stands for hydrodesulfurization. Heat exchangers (HX) that are part of the main stream are large, whereas those of side streams are drawn smaller.

the product gas is pumped into the water scrubber, which reduces its water content and removes HCl and a portion of NH<sub>3</sub>. Next, the gas is compressed, because the hydrodesulfurization (HDS) reactor requires an elevated pressure. The HDS reactor converts all the organic sulfur in the gas (such as COS and thiophene) into hydrogen sulfide. It also converts HCN into NH<sub>3</sub> and hydrogenates all of the aliphatic olefins (but no aromatics). The gas goes to the ZnO reactor, which converts H<sub>2</sub>S into ZnS. Finally, the gas is depressurized and heated to 800 °C before entering the fuel cell.

### Electricity production and process efficiency

We generated mass and energy balances for each system component in Figure 2, and this was followed by preliminary integration of possible heat sources and sinks. Combining these, we obtained an overall energy balance containing the main energy flows. Table 2 gives an overview of this energy analysis on the basis of Equations (1) and (2) given in the Experimental Section (a detailed mass and energy balance of all equipment parts is included in the Supporting Information, part S1-B). The energy content of the 10 kt year<sup>-1</sup> (dry) toilet paper is 44.7 GWh (161 PJ), which by continuous operation results in an input of 5 MW thermal energy. With this input, our system can produce 2.8 MW of electricity. Because

**Table 2.** Electricity yield, electrical efficiency, and total system efficiency.

Parameter	Unit	Value
material input: WTP	MW	4.9
yield of electricity (output)	MW	2.8
yield of heat (output)	MW	0.62
electrical efficiency SOFC (LHV-based)	%	57.2
total efficiency	%	69.7

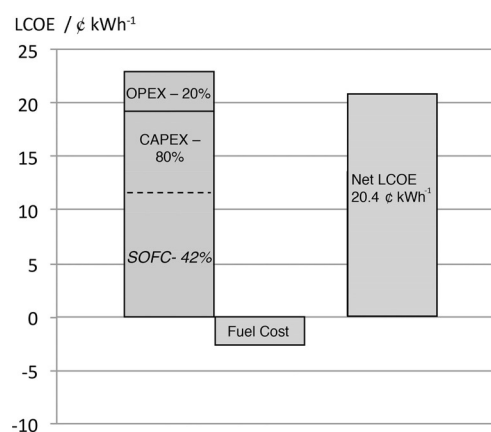
the availability of the system is set at 80% (see Table 3), this gives a total yearly electricity production of 20.2 GWh. This is enough for 6400 Amsterdam households (the average household consumes 3150 kWh year<sup>-1</sup>[14]). The electric efficiency of the system is 57.2%. If the rest heat is included, the total system efficiency increases to nearly 70%. To put this value into perspective, we compare it to waste incineration, the logical alternative for electricity production from WTP. The electric efficiency of waste incineration is 20–30%,<sup>[15–17]</sup> so our process appears to be 2–3 times more efficient. Indeed, it is comparable to the natural gas combined cycle process (NGCC), which has an electrical efficiency of 56–60%.<sup>[18–20]</sup>

Table 3. Economic input data and key results.			
Economic data	Abbreviation	Unit	Value
<i>Economic input data</i>			
project lifetime	<i>L</i>	year	16 <sup>[a]</sup>
discount rate	<i>r</i>	%	5 <sup>[b]</sup>
availability		%	80
electricity price		€ MWh <sup>-1</sup>	49.2 <sup>[c]</sup>
fuel costs	<i>F</i>	€ t <sup>-1</sup>	-20 <sup>[d]</sup>
heat price		€ GJ <sup>-1</sup>	5 <sup>[e]</sup>
plant construction time		year	1
scale factor SOFC			0.85 <sup>[f]</sup>
indirect cost factor SOFC			1.14 <sup>[g]</sup>
contingencies		%	10
<i>Key results</i>			
total plant costs <sup>[h]</sup> (CAPEX)	<i>I/TPC</i>	M€	32.7
OPEX	<i>OM</i>	M€ year <sup>-1</sup>	0.91 <sup>[i]</sup>
annual benefits	<i>B</i>	M€ year <sup>-1</sup>	1.06
electricity production	<i>E</i>	GWh	20.2

[a] Based on fuel-cell lifetime.<sup>[25]</sup> [b] We assume that this type of installations will be at the interface of the public and private sectors; hence, the discount rate lies in between a commercial (10%) and social (3%) rate.<sup>[27]</sup> [c] Average sale price for electricity over the last 10 years in the Netherlands.<sup>[28]</sup> [d] This price was chosen at -20 € t<sup>-1</sup> instead of the current -70 € t<sup>-1</sup> on the basis of the assumption that the price of WTP will increase if it is considered a resource rather than a waste. [e] Obtained from the Amsterdam Waste-to-Energy company. [f] Large-scale FCs are made of modular stacks, so scaling effects are small. Only the stack packaging is affected by scaling.<sup>[29]</sup> [g] On the basis of the recommendations for post-combustion CO<sub>2</sub> capture.<sup>[30]</sup> [h] See the Supporting Information for a detailed breakdown of CAPEX. [i] On the basis of supplier data (Royal Dahlen) for a stand-alone installation.

### Economic feasibility of the system

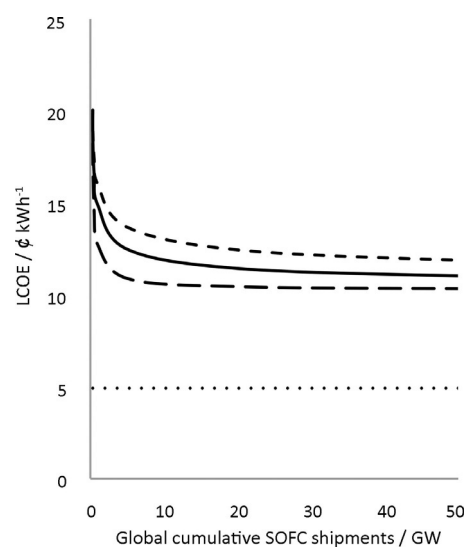
This WTP-to-electricity process shows high electrical and total efficiency. However, is it economically viable? To answer this, we calculated the levelized cost of electricity (LCOE) as well as the net present value (NPV) by following Equations (3) and (4) (see the Experimental section). With the economic assumptions given in Table 3, the NPV for this system is -32.3 M€, whereas the LCOE is 20.3 ¢ kWh<sup>-1</sup>, and the internal rate of return would be -16.2%. These results show that the system is currently economically unfeasible. This is mainly due to the large capital expenses (CAPEX) of the system, as shown in Figure 3. Within the CAPEX, the investment in SOFCs and later stack replacements have the largest impact on the LCOE (42%). In this respect, learning effects on the costs of SOFCs could have a significant impact,<sup>[21,22]</sup> as the SOFC market is not yet mature.<sup>[23,24]</sup> However, with the extraordinary increase in renewable energy production, SOFCs could soon play an important role in grid balancing.<sup>[25]</sup> The capacity of installed photovoltaics grew by 25% (50 GW) to 227 GW in 2014, whereas for wind power 63 GW extra capacity was installed in that year.<sup>[26]</sup> SOFC technology could assist in balancing the intermittent nature of renewable energy, and therefore, we expect a considerable growth in SOFC capacity in the future. This will significantly reduce the costs of SOFC systems because of the “economies of scale” effect.



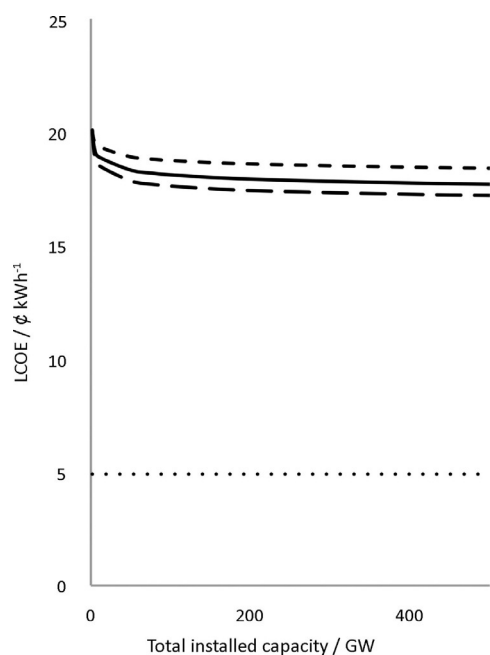
**Figure 3.** LCOE build up. Left column shows the division between CAPEX (80%) and OPEX (20%) in terms of the LCOE. Of the total LCOE, the SOFC investment costs take up 42%. Fuel costs are negative, yielding an LCOE of 20.3 ¢ kWh<sup>-1</sup> (right column).

Our analysis shows that with an average learning scenario (see the Experimental Section) for SOFCs, the LCOE could decrease to 11. ¢ kWh<sup>-1</sup> with an installed capacity of 50 GW (Figure 4). The different learning scenarios for the gasifier lead to a LCOE of 17.7 ¢ kWh<sup>-1</sup> at 500 GW installed capacity for the average scenario (Figure 5). Learning curves for the cleaning system are not shown, as the effect is too small. Overall, this implies that even with learning effects the LCOE will not reach the current average electricity selling price of 4.9 ¢ kWh<sup>-1</sup>.

From another perspective, the electricity from WTP could displace electricity from fossil sources such as coal and gas. The CO<sub>2</sub> emissions for this system on the basis of the gasification model are 157 g<sub>CO2</sub> kWh<sup>-1</sup>, whereas bituminous coal power plants emit 860–920 g<sub>CO2</sub> kWh<sup>-1</sup> and lignite power plants emit 990 g<sub>CO2</sub> kWh<sup>-1</sup>.<sup>[31]</sup> Upon taking into account that

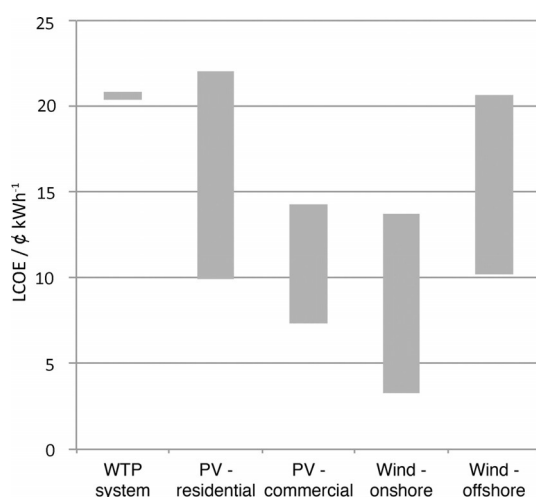


**Figure 4.** Learning curve with three different scenarios for the SOFC component of the WTP-to-electricity system compared with the current electricity price.



**Figure 5.** Learning curve with three different scenarios for the gasifier component of the WTP-to-electricity system compared with the current electricity price.

WTP originates from biomass, the CO<sub>2</sub> emissions would be comparable to those of electricity from renewable sources. As Figure 6 shows, the LCOE of the WTP-to-electricity system is higher than that of commercial PVs and that of on-shore wind energy, yet it lies within the higher range of that of residential PVs and that of off-shore wind energy. Thus, in terms of economic attractiveness, our concept can compete with the higher end of renewable energy systems.



**Figure 6.** Comparison of our WTP-to-electricity system with renewable energy technologies. Data from the International Energy Agency/Nuclear Energy Agency projected costs of generating electricity;<sup>[32]</sup> values with a 7% discount rate were used.

### Sensitivity analysis

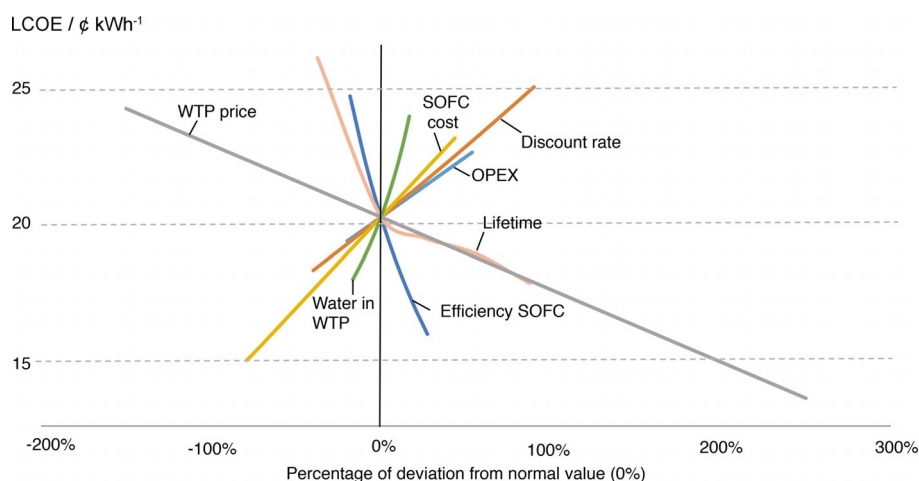
Given the novelty of the concept and the uncertainty in the data assumptions, it was important to conduct a sensitivity analysis.<sup>[33]</sup> In this study, eight input parameters were selected and varied over an appropriate range to assess their impact on the LCOE in a local sensitivity analysis (see Table 4).

**Table 4.** Parameters, values, and ranges used in the sensitivity analysis.

Parameter	Base value	Range
water content WTP [%]	60	50–70 <sup>[a]</sup>
price of WTP [€ t <sup>-1</sup> ]	–20	–70 to +10 <sup>[b]</sup>
SOFC investment costs [M€]	11.8	2.5–17.0 <sup>[c]</sup>
efficiency SOFC [%] (LHV)	55	45–70 <sup>[d]</sup>
lifetime of project [year]	16	10–30 <sup>[e]</sup>
discount rate [%]	5	3–10 <sup>[f]</sup>
OM costs [k€ year <sup>-1</sup> ]	911	730–1400 <sup>[g]</sup>

[a] Variation found in the STOWA/WaterNet report on WTP.<sup>[9]</sup> [b] –70 € t<sup>-1</sup> is the current price WaterNet now pays to process WTP, whereas +10 € t<sup>-1</sup> pertains to a scenario in which there are more competitive processes for converting WTP. We expect that once WTP is used as a process feed, its value will increase. [c] Lower and higher range based on published work.<sup>[21,22,34–36]</sup> [d] On the basis of published work.<sup>[24,36–39]</sup> [e] Lower range is based on lowest lifetime of similar projects,<sup>[13,40,41]</sup> higher range is expected lifetime of the gasifier (Royal Dahlman, personal communication). [f] Lower range is discount rate for government projects; higher range for commercial projects.<sup>[27]</sup> [g] Lower range –20%, higher range +50%.<sup>[42]</sup>

The results of the sensitivity analysis are shown in Figure 7. This graph gives a broad overview of the change in the LCOE if other data assumptions would be applied in the calculations. The range of these data was carefully chosen, so the graph gives a good overview of the possible changes in the LCOE. The price of WTP has the highest impact on the LCOE. The project lifetime is second, and is now set to a fuel-cell lifetime of 16 years (although the relation is not linear, because we assumed that the SOFC stacks would be replaced every 4 years<sup>[25]</sup>). The third most-sensitive input parameter is the SOFC cost. Data from different sources vary, and some papers include learning effects, which results in a broad range.<sup>[22,24,25,29,34,43,44]</sup> The graph underlines that learning in the SOFC market significantly reduces the LCOE. The discount rate stands in the fourth place, which shows, as expected, that a decrease in the discount rate leads to a lower LCOE and vice versa. Next, the lines for efficiency of the SOFC and the amount of WTP overlap in range and slope. Thus, an increase in SOFC efficiency leads to a reduced LCOE, though the average effect is smaller than that for the aforementioned parameters. In addition to more detailed parameter sensitivity analysis, further insight can be obtained by investigating parameter strength, for instance by performing a pedigree analysis.<sup>[45,46]</sup>



**Figure 7.** Sensitivity plot, wherein the abscissa shows the deviation from the base value of the LCOE (at 0%), whereas the ordinate shows the LCOE value. The project lifetime has an irregular shape because the stack replacement costs for the SOFC were done at fixed moments instead of continuously.

## Conclusions

In this paper, we examined the potential of waste toilet paper as a resource instead of an unwanted waste stream. It can be converted into electricity at an exceptionally high electric efficiency of 57% by using a combination of gasification and fuel-cell technology. This option was found to be more efficient than incineration (which gives 20–30% electric efficiency<sup>[47,48]</sup>). On this basis, a first techno-economic analysis was conducted. The system is, under the current conditions, not competitive with a levelized cost of electricity (LCOE) of approximately 20.3 €/kWh<sup>-1</sup>. The price of WTP will depend on the country or case under consideration, and it will influence the LCOE. Our findings indicate that the LCOE is mainly driven by the fuel-cell investment cost, which has a large sensitivity range. Learning effects could reduce the LCOE substantially. Given that the solid-oxide fuel cell market is still developing, strong learning-by-doing and economies-of-scale effects are expected. This could result in a decrease in the LCOE on the longer term from 20.3 to 11 €/kWh<sup>-1</sup> in an average learning scenario. All in all, we believe that this concept can bring us one step closer to creating sustainable and healthy urban environments and deserves further attention.

## Methods

### Process design elements

Our conceptual process design has three steps: gasifier, a cleaning system, and a SOFC. We chose the indirect MILENA gasifier because it utilizes air as an oxidant. This avoids an expensive oxygen-separation unit, without diluting the product gas with nitrogen.<sup>[11,49,50]</sup> The gasifier is called indirect because the gasification and combustion process are separated. The gasification chamber is located within the combustion chamber to achieve good heat exchange, yet it avoids mixing exhaust and product gases. The other indirect gasifier available at the right scale and level of development is the fast internally circulated fluidized

bed (FICFB).<sup>[51–53]</sup> The MILENA gasifier, however, has a higher efficiency for the production of synthetic natural gas thanks to a low steam/biomass ratio.<sup>[11]</sup>

We modeled the unit by working at atmospheric pressure with a gasifier temperature of 850 °C, a gasifier outlet temperature of 800 °C, and a combustor temperature and outlet temperature of 900 °C. The gas cleaning system is partly based on the ECN methanation system (ESME) for biosynthetic natural-gas production. This system can remove all necessary contaminants from the gas.<sup>[54]</sup> Furthermore, it recycles tars to the gasifier by using the OLGA tar-removal system.<sup>[13]</sup> The tars are burned as fuel, which thereby increases the energy efficiency. The fuel-cell stage comprises a solid-oxide fuel cell (SOFC) that can utilize light hydrocarbons as fuel. This cell has an all-solid construction, and its high operation temperature allows heat cogeneration, which can be used for drying the feed.<sup>[37,38,55]</sup> The SOFC was modeled by operating at 800 °C with an outlet temperature of 1000 °C and a pressure of 0.14 MPa.<sup>[43]</sup>

### Energy analysis

To the best of our knowledge, there is no published data for WTP gasification. We therefore based our system on the ECN model for wood gasification<sup>[11]</sup> yet used the composition of actual WTP. Wood and WTP both have cellulose as their main component. Wood contains 40–80% cellulose,<sup>[56]</sup> whereas WTP has 70–80% cellulose.<sup>[8,9]</sup> By combining the product gas composition from our model with conversion and/or removal rates of the cleaning equipment, we set up mass and energy balances. Pressure drops were not considered. For the SOFC, we used an efficiency of 55% on the basis of the lower heating value (LHV).<sup>[25,43]</sup> We performed heat integration by matching heat sources and sinks and calculated the final energy balance and the net electricity yield. The electric efficiency ( $\eta_{\text{elec}}$ ) and total efficiency ( $\eta_{\text{total}}$ ) were calculated according to Equations (1) and (2).

$$\eta_{\text{elec}} = \frac{E_{\text{elec,out}} - E_{\text{elec,in}}}{\sum E_{\text{fuel}} + E_{\text{heat,in}}} \times 100 \% \quad (1)$$

$$\eta_{\text{total}} = \frac{E_{\text{elec,out}} + E_{\text{heat,out}} - E_{\text{elec,in}}}{\sum E_{\text{fuel}} + E_{\text{heat,in}}} \times 100 \% \quad (2)$$

in which  $E_{\text{elec,out}}$  is the electricity produced,  $E_{\text{elec,in}}$  is the electricity consumption of the system,  $E_{\text{fuel}}$  is the energy in the fuel,  $E_{\text{heat,in}}$  is the heat requirement of the system, and  $E_{\text{heat,out}}$  is the heat that can be utilized at temperatures above 80°C. All energy values are given in kW.

### Economic analysis

We calculated two economic indicators: the net present value [NPV, Equation (3)] and the levelized cost of electricity [LCOE, Equation (4)]. The NPV estimates the current value of a project if all cash flows over the project lifetime are discounted. The LCOE gives the price at which electricity is produced by the system over the project lifetime.<sup>[27,57]</sup>

$$\text{NPV} = -I + \sum_{i=1}^L \frac{B - OM - F}{(1+r)^i} \quad (3)$$

$$\text{LCOE} = \frac{I_0 + \sum_{i=1}^L \frac{OM-F}{(1+r)^i}}{\sum_{i=1}^L \frac{E}{(1+r)^i}} \quad (4)$$

in which  $I_0$  is the total plant cost (CAPEX) in €,  $B$  is the annual benefits in €year<sup>-1</sup>,  $OM$  is the operation and maintenance cost (or OPEX) in €year<sup>-1</sup>,  $F$  is the fuel cost in €year<sup>-1</sup>,  $r$  is the discount rate in %,  $L$  is the project lifetime in years, and  $E$  is the electricity production in kWhyear<sup>-1</sup>.

The input data used in the calculations are given in Table 4 (note that the current price for WTP is -70 €t<sup>-1</sup>, but if WTP is viewed as a resource rather than a waste the price may increase; thus, we set a price of -20 €t<sup>-1</sup> for economic analysis). As capital expenses (CAPEX), the total plant costs are calculated, including the investment costs of the gasifier, cleaning system, and SOFC plus engineering, procurement, and construction (EPC) costs and contingencies. The costs of the gasifier and cleaning system were obtained from a supplier directly and already include EPC. The costs for the SOFC were obtained from a 2015 European fuel-cell market report and were scaled appropriately.<sup>[25]</sup> Cost escalation was performed to include indirect costs and to obtain the EPC of the SOFC (detailed CAPEX specifications are included in the Supporting Information).

### Learning-curve analysis

As the technology is at an early stage of development, there is significant space for improvement. We ran a learning-curve analysis to study possible future scenarios for the LCOE. Basically, the use of learning curves is based on empirical experience showing that production costs will decrease by a constant factor with each doubling of the production amount.<sup>[57]</sup> There are two main types of learning. The first is pure learning, which is due to increased knowledge and experience with increasing production. The second is economy of scale, for which the building and use of larger units decreases capital expenses. In our analysis, we used classic learning equations [Equations (5) and (6)] to generate the learning curves.

$$C_t = C_0 \cdot \left(\frac{P_t}{P_0}\right)^{-\alpha} \quad (5)$$

$$lr = 1 - 2^{-\alpha} \quad (6)$$

in which  $C_t$  is the cost at produced or installed capacity  $P_t$  and  $C_0$  and  $P_0$  are the current price and capacity, respectively. The costs are expressed in terms of the LCOE in €kWh<sup>-1</sup>, and the capacity is expressed in gigawatt (GW). The learning rate ( $lr$ ) is expressed as a percentage, for which  $\alpha$  is the learning index and  $2^{-\alpha}$  is the progress ratio.

To create the learning curve, the LCOE was split up into four components: fuel cell, gasifier, cleaning system, and “the rest”. The first three parts all have their own learning rates, whereas the fourth is kept constant. We analyzed three scenarios with appropriate learning rates for each respective component (see Table 5).

**Table 5.** Learning rates for learning curve analysis.<sup>[a]</sup>

Component	Scenario <sup>[b]</sup>			Current installed capacity [GW]		
	conserv.	Ref. av.	Ref. optim.	Ref.	Ref.	Ref.
gasifier	6	[58] 10	[59] 14	[18]	1	1
cleaning system	11	[18] 11.5	12	[58]	50	50
fuel cell	20	[21] 27	[21] 44	[21]	0.2	0.2

[a] The learning rates are given in %. The current installed capacity is most accurate for SOFC fuel cells.<sup>[60–62]</sup> For the cleaning system<sup>[18,58]</sup> (mainly sulfur removal) and a biomass gasifier,<sup>[18,58,59]</sup> approximations were made. [b] Conservative, average, and optimistic.

### Acknowledgements

We thank Royal Dahlman, WaterNet, and Afvalenergiebedrijf for their contributions to this research. B.v.d.Z. thanks the “Stichting Physica” for allowing him to contribute to this work through his chair “Sustainable Energy Technology”. This work is part of the UvA Research Priority Area Sustainable Chemistry, <http://suschem.uva.nl>

**Keywords:** cellulose • circular economy • energy conversion • gasification • sustainable chemistry • waste reuse

- [1] J. Klimstra, *Smart Power Generation: The Future of Electricity Production* (Eds.: J. Klimstra, M. Hotakainen), Avain, Helsinki, 2011.
- [2] C. Rae, F. Bradley, *Renewable Sustainable Energy Rev.* **2012**, *16*, 6497–6506.
- [3] M. Asif, T. Muneer, *Renewable Sustainable Energy Rev.* **2007**, *11*, 1388–1413.
- [4] European Commission, *Closing the Loop—An EU Action Plan for the Circular Economy*, **2015**, [http://ec.europa.eu/environment/circular-economy/index\\_en.htm](http://ec.europa.eu/environment/circular-economy/index_en.htm).
- [5] B. D. Solomon, *Ann. N. Y. Acad. Sci.* **2010**, *1185*, 119–134.
- [6] M. Harvey, S. Pilgrim, *Food Policy* **2011**, *36*, S40–S51.
- [7] Z. Strassberger, S. Tanase, G. Rothenberg, *RSC Adv.* **2014**, *4*, 25310–25318.
- [8] C. J. Ruiken, G. Breuer, E. Klaversma, T. Santiago, M. C. M. van Loosdrecht, *Water Res.* **2013**, *47*, 43–48.
- [9] C. Ruiken, E. Klaversma, G. Breuer, R. Neef, *Influent Fijnzeven in RWZI'S*, STOWA, **2010**, [http://www.stowa.nl/publicaties/publicaties/influent\\_fijnzeven\\_in\\_rwzi\\_s](http://www.stowa.nl/publicaties/publicaties/influent_fijnzeven_in_rwzi_s).
- [10] Eurostat, *Waste—Main Tables*, European Commission, **2014**, <http://ec.europa.eu/eurostat/web/environment/waste/main-tables>, accessed 14. May 2017.



- [11] C. M. van der Meijden, *Development of the MILENA Gasification Technology for the Production of Bio-SNG*, Technische Universiteit Eindhoven, **2010**.
- [12] S. A. Channiwala, P. P. Parikh, *Fuel* **2002**, *81*, 1051–1063.
- [13] H. Boerrigter, S. V. B. van Paasen, P. C. A. Bergman, J. W. Köne-mann, R. Emmen, A. Wijnands, “OLGA” Tar Removal Technology—Proof-of-Concept (PoC) for Application in Integrated Biomass Gasification Combined Heat and Power (CHP) Systems, Energy Research Centre of the Netherlands (ECN), Petten, The Netherlands, **2005**, <http://www.ecn.nl/docs/library/report/2005/c05009.pdf>.
- [14] CBS—Centraal Bureau voor de Statistiek, *Energieverbruik particuliere woningen; woningtype en regio's*, **2015**, <http://statline.cbs.nl/StatWeb/publication/?DM=SLNL&PA=81528NED>, accessed 25 January 2016.
- [15] M. J. Murer, H. Spliethoff, C. M. W. D. Waal, S. Wilpshaar, B. Berkhout, M. A. J. V. Berlo, O. Gohlke, J. J. E. Martin, *Waste Manage. Res.* **2011**, *29*, S20–S29.
- [16] M. Münster, H. Lund, *Waste Manage.* **2010**, *30*, 1251–1263.
- [17] L. Lombardi, E. Carnevale, A. Corti, *Waste Manage.* **2015**, *37*, 26–44.
- [18] M. van den Broek, R. Hoefnagels, E. Rubin, W. Turkenburg, A. Faaij, *Prog. Energy Combust. Sci.* **2009**, *35*, 457–480.
- [19] W. Graus, M. Roglieri, P. Jaworski, L. Alberio, *Efficiency and capture-readiness of new 517 fossil power plants in the EU*, European Commission, Utrecht, **2008**.
- [20] A. T. Thattai, B. J. Wittebrood, T. Woudstra, J. J. C. Geerlings, P. V. Aravind, *Energy Procedia* **2014**, *63*, 1996–2007.
- [21] R. Rivera-Tinoco, K. Schoots, B. van der Zwaan, *Energy Convers. Manage.* **2012**, *57*, 86–96.
- [22] K. Schoots, G. J. Kramer, B. C. C. van der Zwaan, *Energy Policy* **2010**, *38*, 2887–2897.
- [23] N. Mahato, A. Banerjee, A. Gupta, S. Omar, K. Balani, *Prog. Mater. Sci.* **2015**, *72*, 141–337.
- [24] S. J. McPhail, L. Leto, C. Boigues-Muñoz, *The Yellow Pages of SOFC Technology: International Status of SOFC Deployment 2012–2013*, Italian National Agency for New Technologies, Energy and Sustainable Economic Development, **2013**, <http://www.ieafuelcell.com/documents/YellowpagesSOFC.pdf>.
- [25] H. Ammermann, P. Hoff, M. Atanasiu, J. Ayllor, M. Kaufmann, O. Tisler, *Advancing Europe's Energy Systems: Stationary Fuel Cells in Distributed Generation*, Fuel Cells And Hydrogen Joint Undertaking (FCH JU) & Roland Berger, **2015**, <http://www.fch.europa.eu/publications/advancing-europes-energy-systems-stationary-fuel-cells-distributed-generation>.
- [26] REN21—Renewable Energy Policy Network for the 21st Century, *Renewables 2016: Global Status Report*, Paris, **2016**, <http://www.ren21.net/gsr-2016-report-full-report-en/>.
- [27] W. Short, D. J. Packey, T. Holt, *A Manual for the Economic Evaluation of Energy Efficiency and Renewable Energy Technologies*, **1995**, <http://www.nrel.gov/docs/legosti/old/5173.pdf>.
- [28] EPEX SPOT, *Monthly average price past years*, **2016**, <http://www.apx-group.com/market-results/apx-power-nl/dashboard/>, accessed 09. February 2016.
- [29] J. H. J. S. Thijssen, J. Thijssen, *The Impact of Scale-Up and Production Volume on SOFC Manufacturing Cost*, NETL—National Energy Technology Laboratory, **2007**, [http://www.netl.doe.gov/File\\_Library/research/coal/energy\\_systems/fuel\\_cells/JT-Manufacturing-Study-Report-070522.pdf](http://www.netl.doe.gov/File_Library/research/coal/energy_systems/fuel_cells/JT-Manufacturing-Study-Report-070522.pdf).
- [30] Carbon-free electricity by sorption enhanced water gas shift (SEWGS): advanced materials, reactor and process design (CAESAR), *D 4.9 European Best Practice Guidelines for Assessment of CO<sub>2</sub> Capture Technologies*, Politecnico Di Milano, Alstom UK, **2011**, [http://www.energia.polimi.it/news/D%204\\_9%20best%20practice%20guide.pdf](http://www.energia.polimi.it/news/D%204_9%20best%20practice%20guide.pdf).
- [31] *CO<sub>2</sub> Emissions from Fuel Combustion: Documentation for beyond 2020 Files*, International Energy Agency (IEA), **2012**, [http://wds.iea.org/wds/pdf/documentation\\_co2\\_2011.pdf](http://wds.iea.org/wds/pdf/documentation_co2_2011.pdf).
- [32] *Projected Costs of Generating Electricity: 2015 Edition*, IEA, Nuclear Energy Agency (NEA), OECD, **2015**, <https://www.oecd-nea.org/ndd/pubs/2015/7057-proj-costs-electricity-2015.pdf>.
- [33] D. P. Loucks, E. van Beek, UNESCO, *Water Resources Systems Planning and Management: An Introduction to Methods, Models Applications*, Springer, Cham, **2005**.
- [34] M. R. Weimar, L. A. Chick, D. W. Gotthold, G. A. Whyatt, *Cost Study for Manufacturing of Solid Oxide Fuel Cell Power Systems*, Pacific Northwest National Laboratory (PNNL), Richland, WA, **2013**, [http://www.pnnl.gov/main/publications/external/technical\\_reports/PNNL-22732.pdf](http://www.pnnl.gov/main/publications/external/technical_reports/PNNL-22732.pdf).
- [35] J. Thijssen, *Natural Gas-Fueled Distributed Generation Solid Oxide Fuel Cell Systems*, Report Number R102 04 2009/1, **2009**, <https://www.netl.doe.gov/File%20Library/research/coal/energy%20systems/fuel%20cells/Natural-Gas-DG-FC-paper-update-090330a.pdf>.
- [36] K. Krulla, D. Kearns, A. Iyengar, D. Newby, *Assessment of the Distributed Generation Market Potential for Solid Oxide Fuel Cells*, National Energy Technology Laboratory, US Department of Energy, **2013**, [https://www.netl.doe.gov/energy-analyses/temp/FY14\\_AssessmentoftheDistributedGenerationMarketPotentialforSolidOxideFuelCells\\_092913.pdf](https://www.netl.doe.gov/energy-analyses/temp/FY14_AssessmentoftheDistributedGenerationMarketPotentialforSolidOxideFuelCells_092913.pdf).
- [37] H. R. Ellamla, I. Staffell, P. Bujlo, B. G. Pollet, S. Pasupathi, *J. Power Sources* **2015**, *293*, 312–328.
- [38] S. J. Mcphail, V. Cigolotti, A. Moreno, *Fuel Cells in the Waste-to-Energy Chain*, Springer, London, **2012**.
- [39] A. Vieira da Rosa, *Fundamentals of Renewable Energy Processes, 2nd ed.*, Elsevier, Amsterdam, **2009**, pp. 287–416.
- [40] M. Asadullah, *Renewable Sustainable Energy Rev.* **2014**, *40*, 118–132.
- [41] R. W. R. Zwart, H. Boerrigter, E. P. Deurwaarder, C. M. van der Meijden, S. V. B. van Paasen, *Production of Synthetic Natural Gas (SNG) from Biomass*, Energy Research Centre of the Netherlands (ECN), Petten, The Netherlands, **2006**, <http://www.ecn.nl/docs/library/report/2006/e06018.pdf>.
- [42] G. Towler, R. Sinnott, *Chemical Engineering Design: Principles, Practice and Economics of Plant and Process Design, 2nd ed.*, Elsevier, Oxford, **2013**.
- [43] B. D. James, A. B. Spisak, W. G. Colella, *Manufacturing Cost Analysis of Stationary Fuel Cell Systems*, SA—Strategic Analysis Inc., Arlington, VA, **2012**, <http://hfcarchive.org/fuelcells/pdfs/Strategic%20Analysis%20Report.pdf>.
- [44] Battelle, *Manufacturing Cost Analysis of 1 kW and 5 kW Solid Oxide Fuel Cell (SOFC) for Auxilliary Power Applications*, Columbus, OH, **2014**, [http://eippcb.jrc.ec.europa.eu/reference/BREF/wi\\_bref\\_0806.pdf](http://eippcb.jrc.ec.europa.eu/reference/BREF/wi_bref_0806.pdf).
- [45] J. P. van der Sluijs, M. Craye, S. Funtowicz, P. Klopogge, J. Ravetz, J. Risbey, *Risk Anal.* **2005**, *25*, 481–492.
- [46] M. van der Spek, A. Ramirez, A. Faaij, *Comput. Chem. Eng.* **2016**, *85*, 1–15.
- [47] European Commission, *Integrated Pollution Prevention and Control, Reference Document on the Best Available Techniques for Waste Incineration*, **2006**, <http://www.detroitstoker.com/clientuploads/News/Integrated%20Pollution%20Prevention%20and%20Control%20July%202006.pdf>.
- [48] Gemeente Amsterdam, AEB, AEB Nieuws, **2012**, <http://www.aebamsterdam.nl/over-aeb/technologie/>.
- [49] C. M. van der Meijden, H. J. Veringa, L. P. L. M. Rabou, *Biomass Bioenergy* **2010**, *34*, 302–311.
- [50] C. Pfeifer, S. Koppatz, H. Hofbauer, *Biomass Convers. Biorefinery* **2011**, *1*, 39–53.
- [51] H. Hofbauer, G. Veronik, T. Fleck, R. Rauch, H. Mackinger, E. Fercher, *Developments in Thermochemical Biomass Conversion* (Eds.: A. V. Bridgwater, D. G. B. Boocock), Springer, Dordrecht, **1997**, pp. 1016–1025.
- [52] H. Hofbauer, R. Rauch, K. Bosch, R. Koch, C. Aichernig, *Expert Meeting on Pyrolysis and Gasification of Biomass and Waste* **2002**, <http://members.aon.at/biomasse/strassbourg.pdf>.
- [53] “Indirectly heated gasifiers—the case of the Güssing reactor”, R. Rauch in *Proceedings of the 1st European Summer School on Renewable Motor Fuels*, **2005**, 29–31.
- [54] L. P. L. M. Rabou, G. Aranda Almansa, *500 Hours Producing Bio-SNG from MILENA Gasification Using the ESME System—ECN System for Methanation (ESME): A Novel Technology Successfully Proven*, Energy Research Centre of the Netherlands (ECN) **2015**, <https://www.ecn.nl/publications/PdfFetch.aspx?nr=ECN-E-15-008>.

- [55] Z. Ud Din, Z. A. Zainal, *Renewable Sustainable Energy Rev.* **2016**, *53*, 1356–1376.
- [56] F.-P. Nagel, Ph.D. Thesis, ETH Zurich, **2008**.
- [57] K. Blok, *Introduction to Energy Analysis*, Techné Press, Amsterdam, **2007**.
- [58] M. M. J. Knoope, J. C. Meerman, A. Ramírez, A. P. C. Faaij, *Int. J. Greenhouse Gas Control* **2013**, *16*, 287–310.
- [59] G. Aranda, A. van der Drift, R. Smit, *The Economy of Large Scale Biomass to Substitute Natural Gas (bioSNG) Plants*, Energy Research Centre of the Netherlands (ECN), Petten, The Netherlands, **2014**, <https://www.ecn.nl/publications/PdfFetch.aspx?nr=ECN-E-14-008>.
- [60] Grand View Research, *Fuel Cell Market Analysis By Product (PEMFC, DMFC, PAFC, SOFC, MCFC, AFC) and Segment Forecasts to 2020*, San Francisco, **2014**, <http://www.grandviewresearch.com/industry-analysis/fuel-cell-market/request>.
- [61] D. Hart, F. Lehner, R. Rose, J. Lewis, M. Klippenstein, *The Fuel Cell Industry Review*, **2015**, <http://www.fuelcellindustryreview.com/archive/TheFuelCellIndustryReview2015.pdf>.
- [62] D. Hart, F. Lehner, R. Rose, J. Lewis, M. Klippenstein, *Platinum Met. Rev.* **2012**, *56*, 272–273, <https://doi.org/10.1595/147106712X657535>.

---

Manuscript received: April 21, 2017

Revised manuscript received: June 19, 2017

Accepted manuscript online: June 23, 2017

Version of record online: August 11, 2017