

# MODIFICATION DRAWINGS

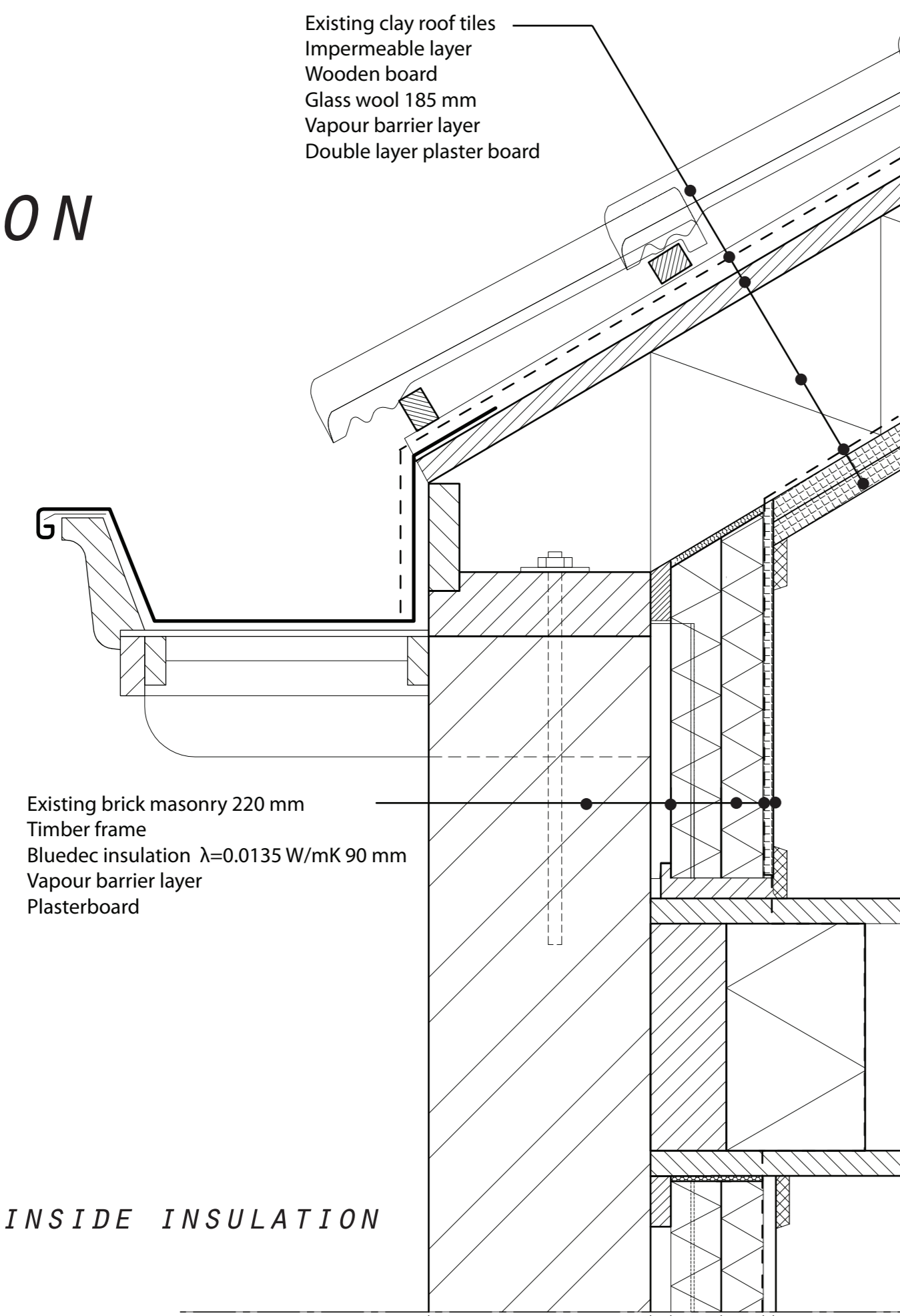

DETAIL 1:  
ROOF WITH INSIDE INSULATION  
1:5

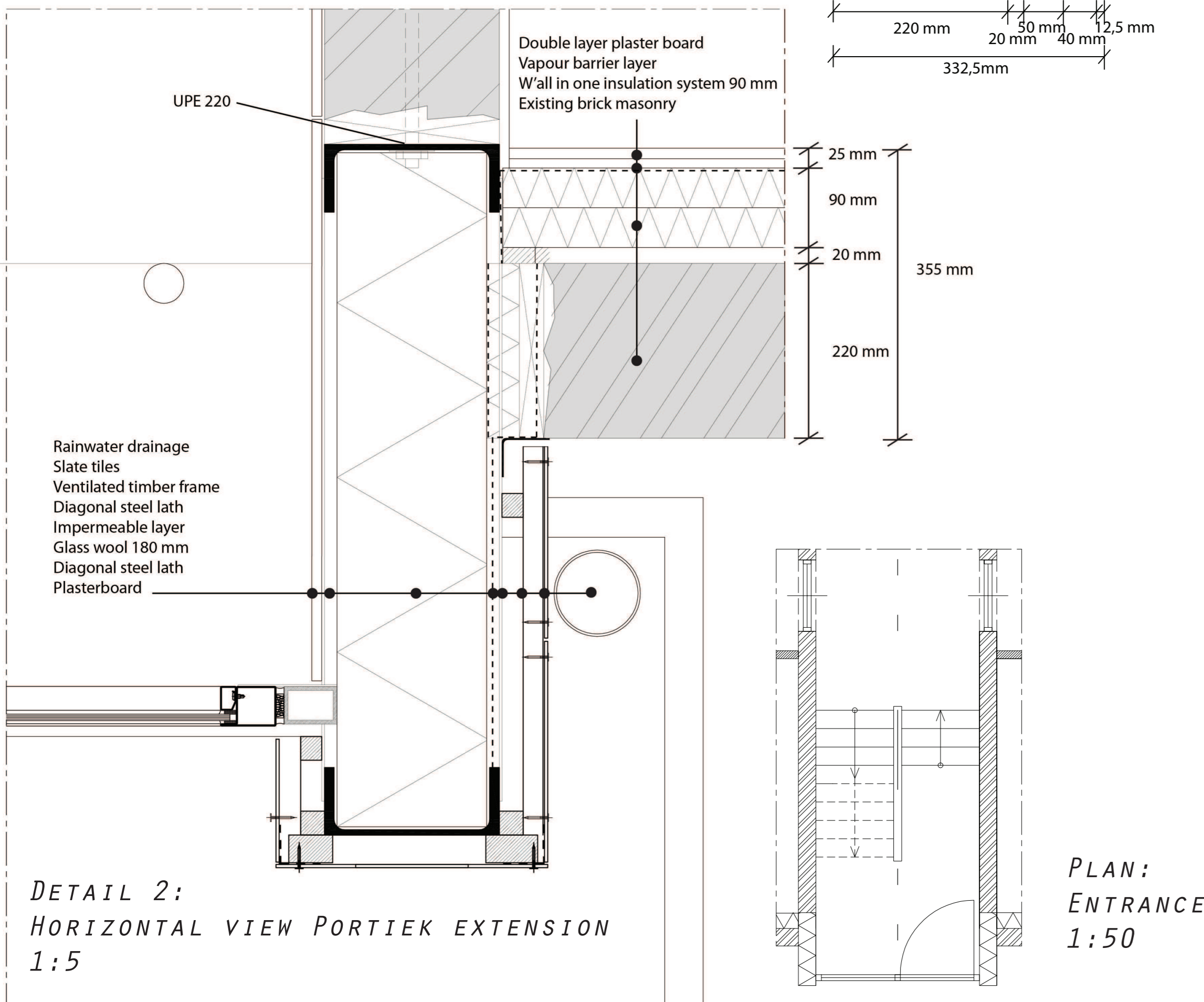

DETAIL 2:  
HORIZONTAL VIEW PORTIEK EXTENSION  
1:5

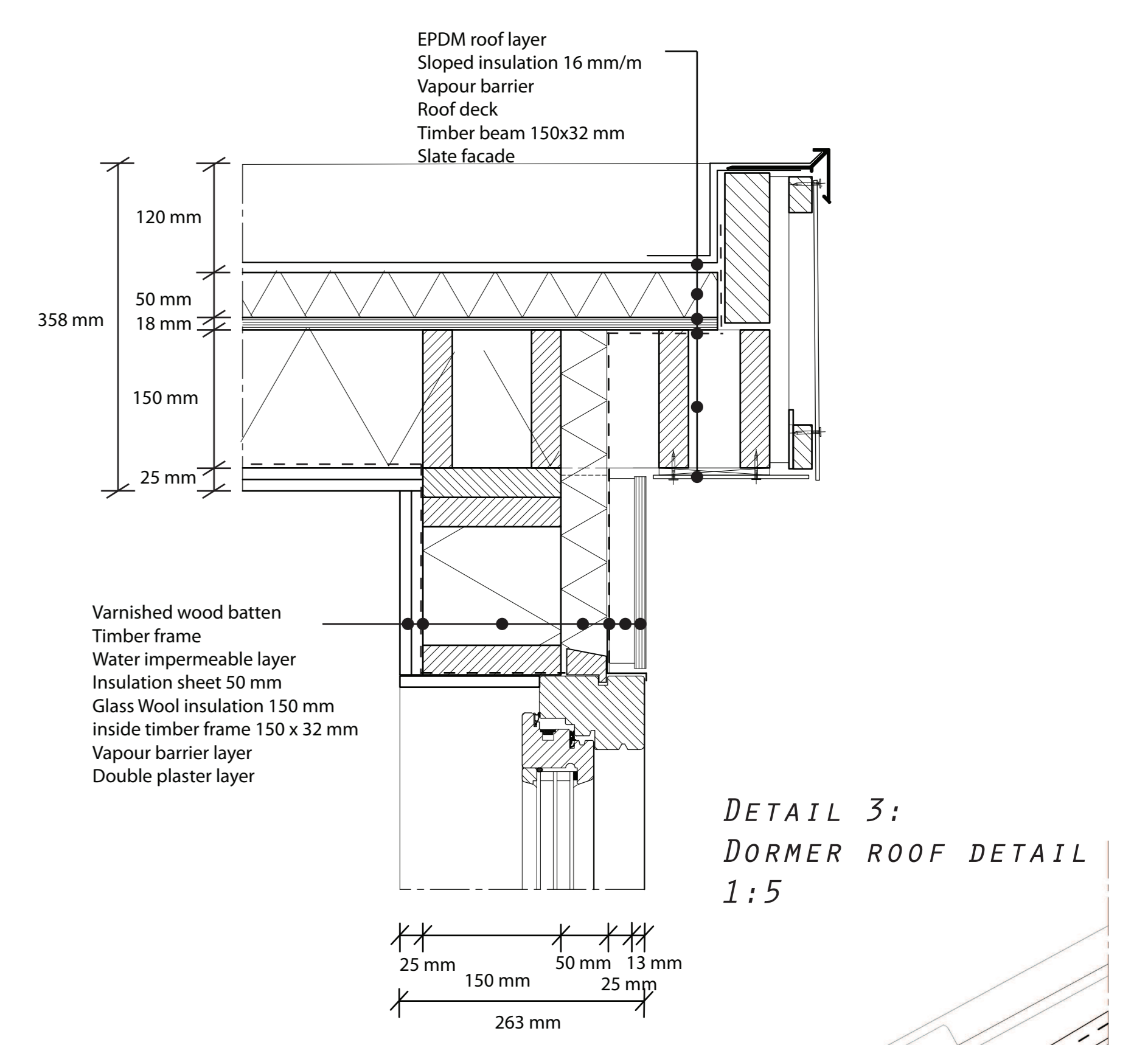
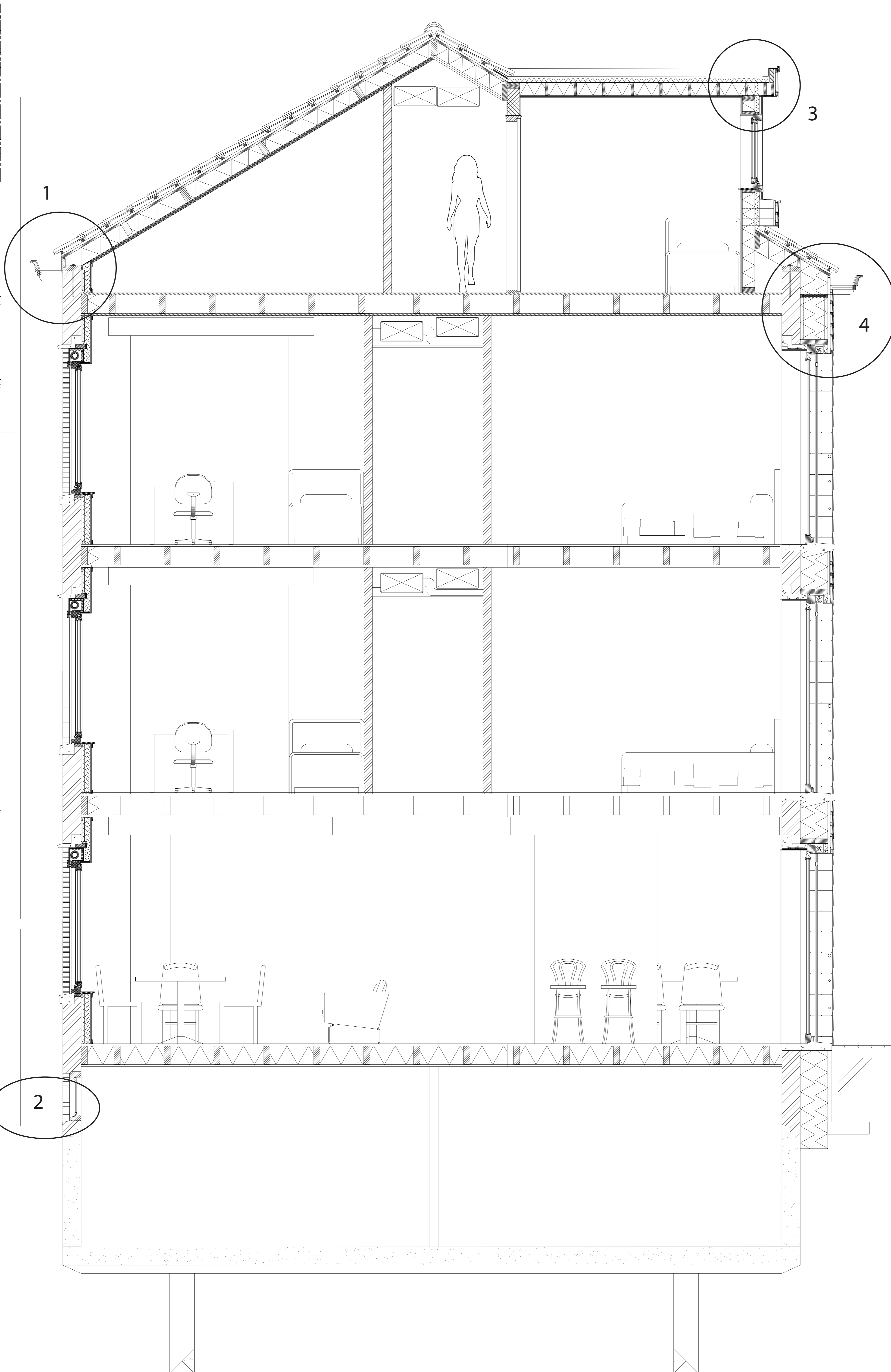

DETAIL 3:  
DORMER ROOF DETAIL  
1:5

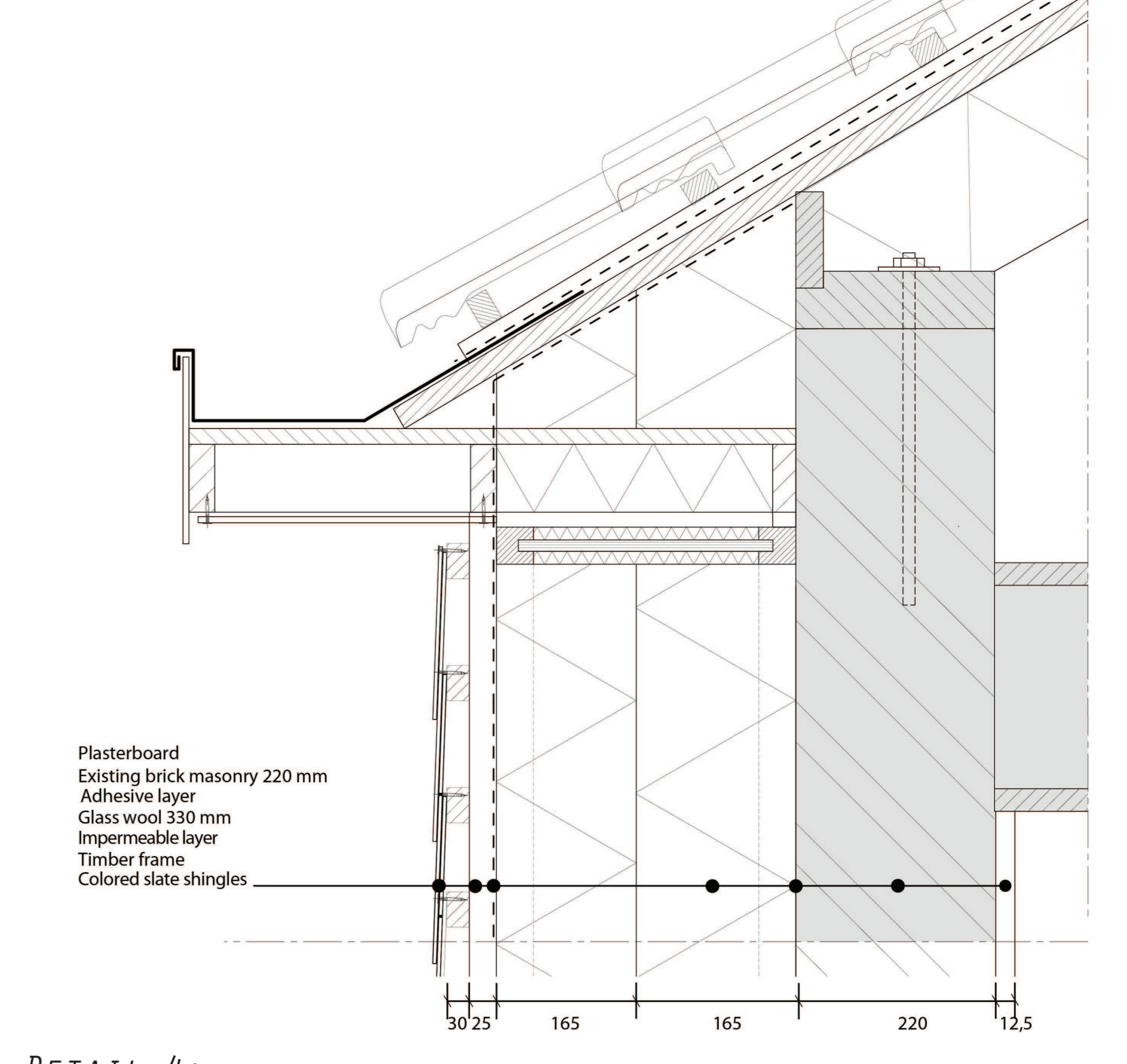

DETAIL 4:  
ROOF DETAIL OUTSIDE INSULATION  
1:5

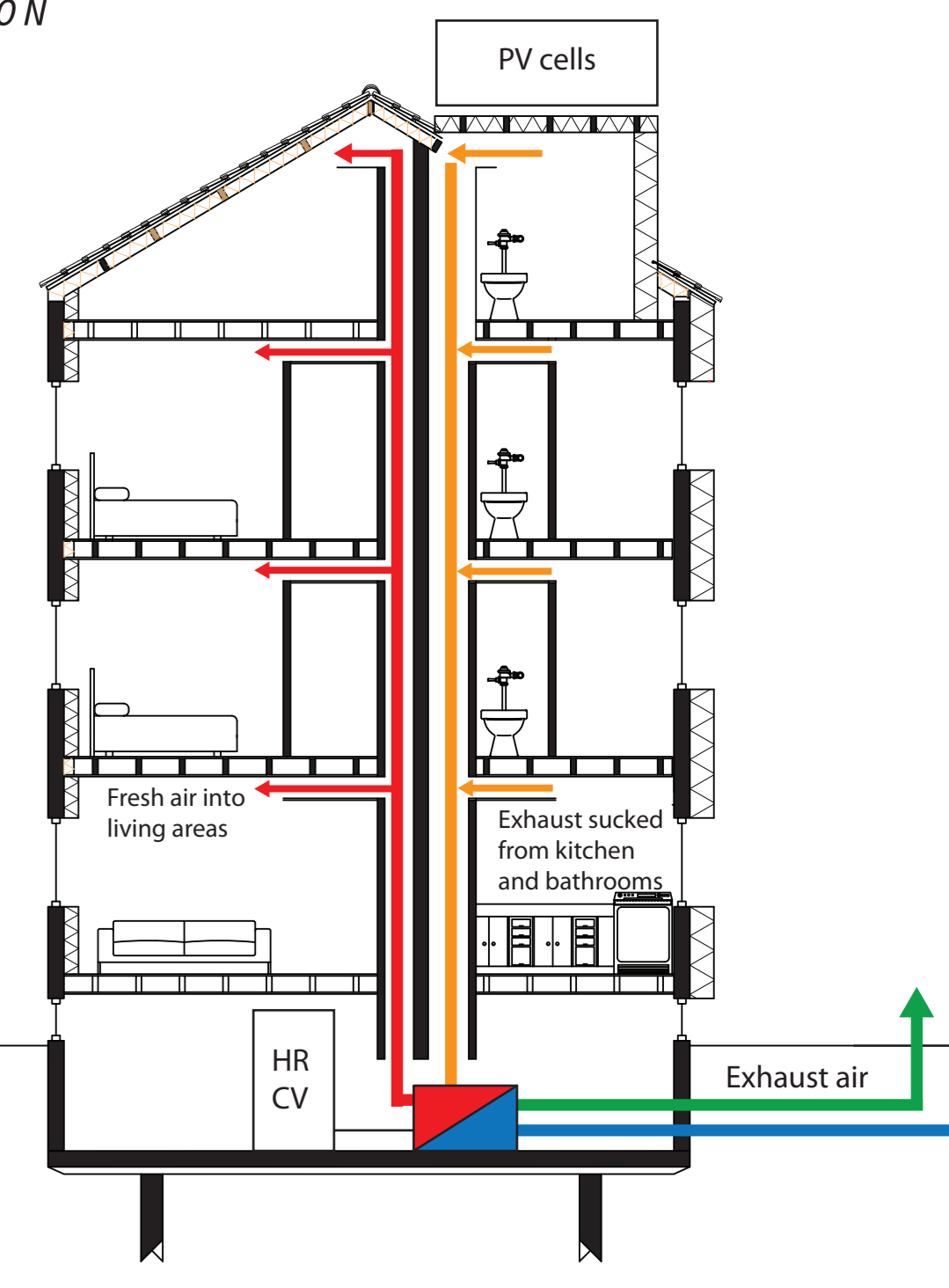

DIAGRAM: CLIMATE CONCEPT

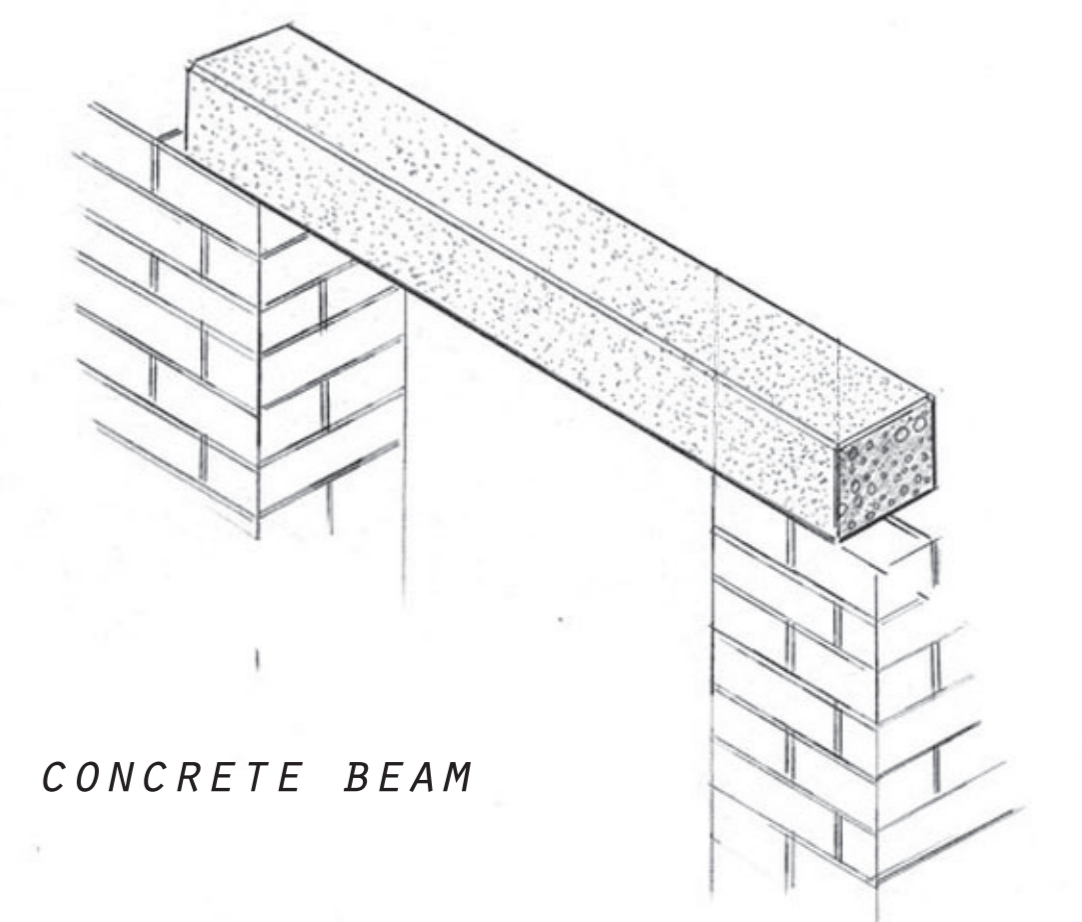

DIAGRAM: CONCRETE BEAM

