

P5 Presentatie Peter Kaijser



Inhoudsopgave

- Introductie
- Gehele structuur
- Interne structuur
- Conclusie
- Probleemstelling
- Fascinatie
- Uitgangspunten

Inhoudsopgave

- Introductie
- Gehele structuur
- Interne structuur
- Conclusie
- Opbouw
- Transformatie
- Details

Inhoudsopgave

- Introductie
- Gehele structuur
- Interne structuur
- Conclusie
- Verschillende ruimtes
- Transformaties
- Details

Inhoudsopgave

- Introductie
- Gehele structuur
- Interne structuur
- Conclusie

Probleemstelling

Zandtransport

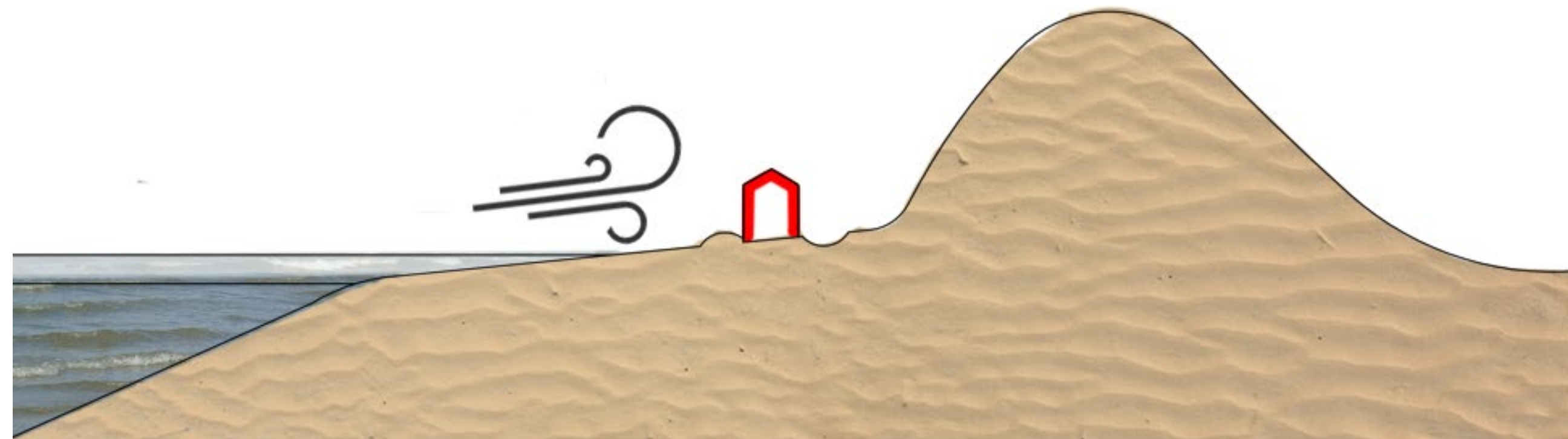
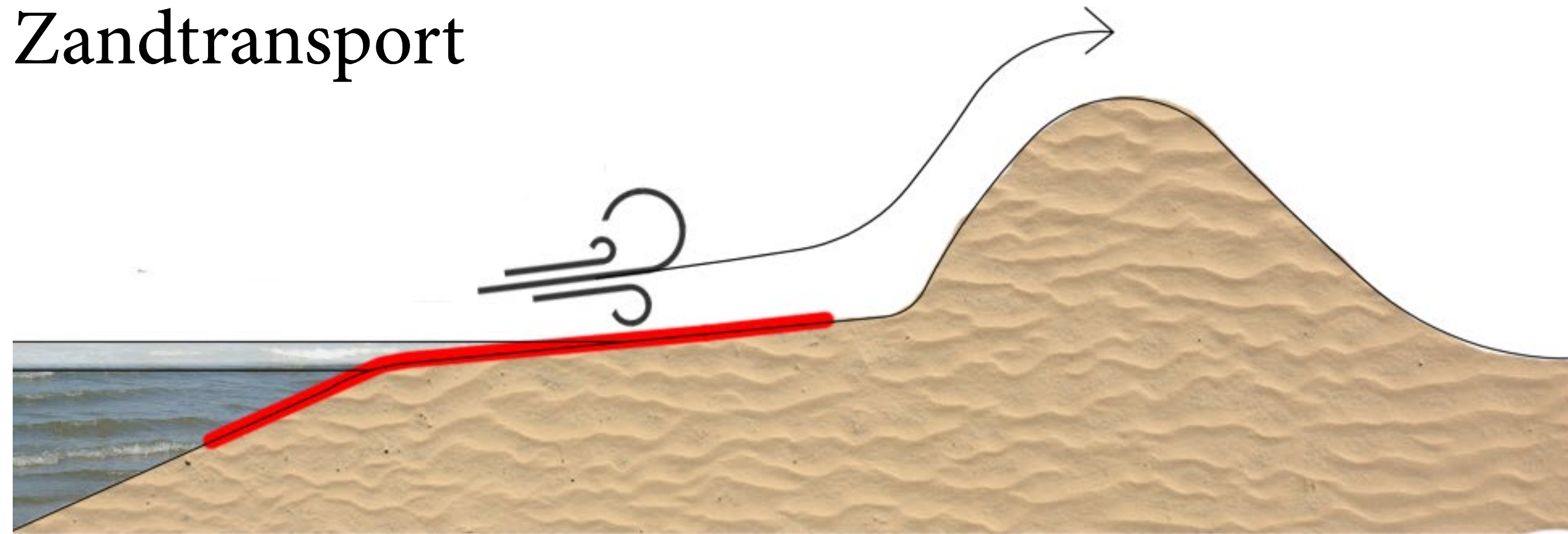

Probleemstelling

Extra kosten en ongemak



Kinetisch ontwerpen

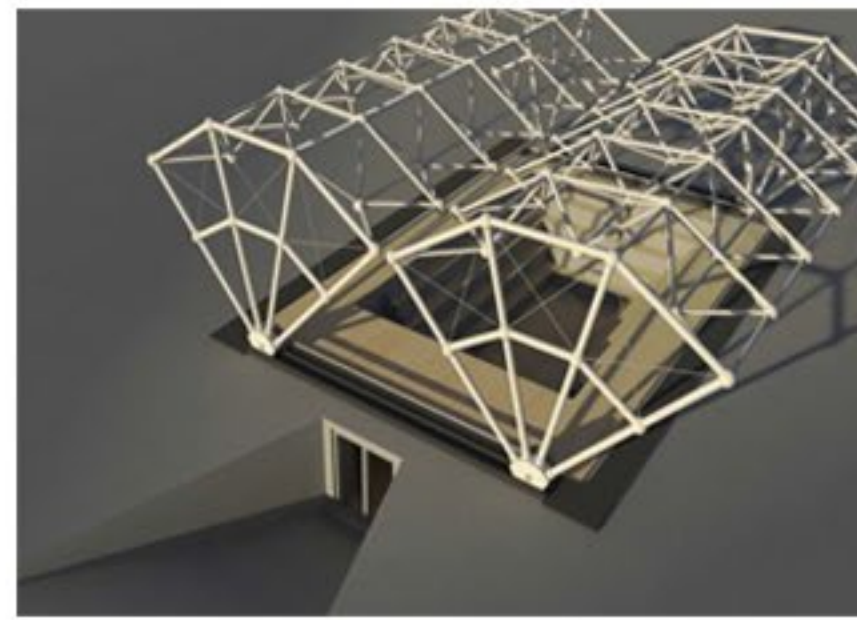
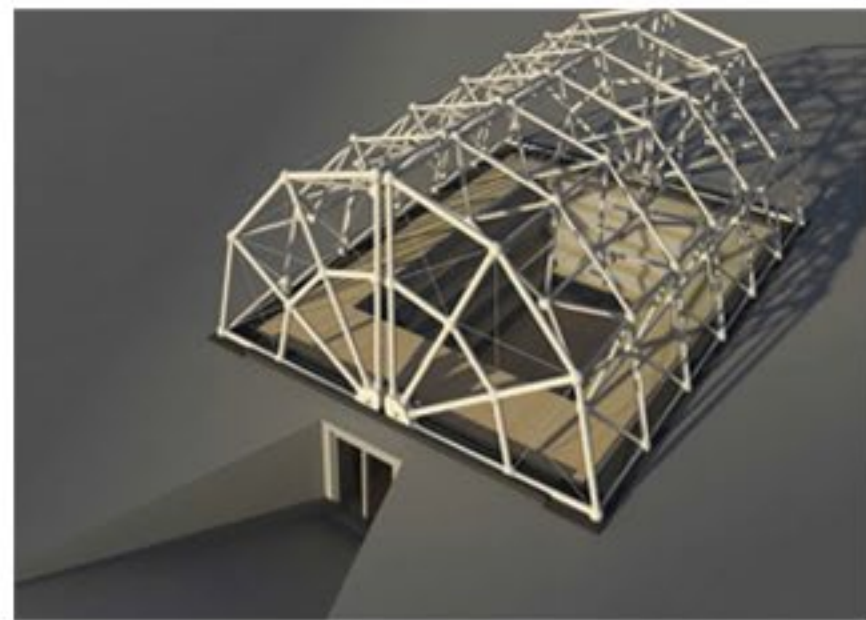

Kinetisch ontwerpen conclusies

Structuren

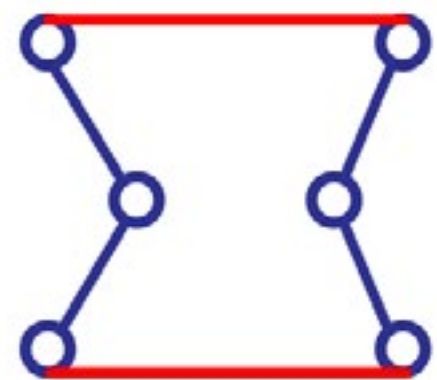

Embedded
Kinetic
Structure

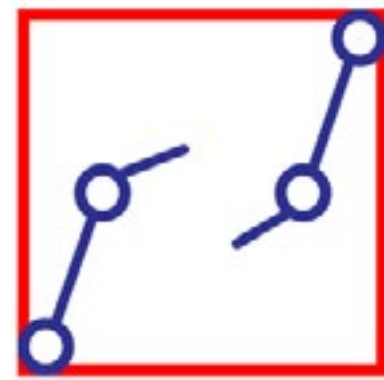

Dynamic
Kinetic
Structure

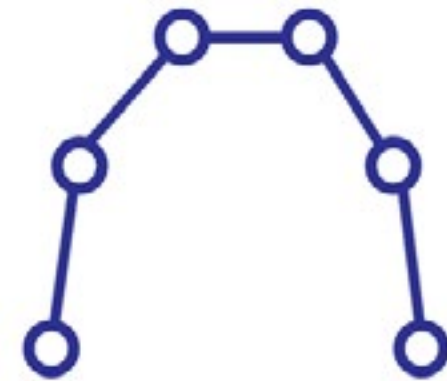

Deployable
Kinetic
Structure

Fox, Michael (2009) *Empheralization*

Uitgangspunten

Spatial
Optimization

Multifunction
Design

Contextual
Adaptability

Mobility

Fox, Michael (2009) *Interactive Architecture*
Zuk, William (1970) *Kinetic Architecture*

Embedded Kinetic Structure



Sliding house - dRMM Architects

Kinetisch ontwerpen conclusies

Structuren

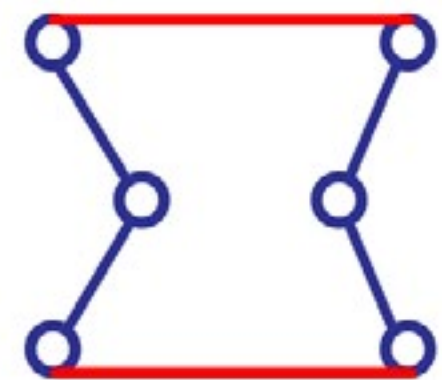

Embedded
Kinetic
Structure

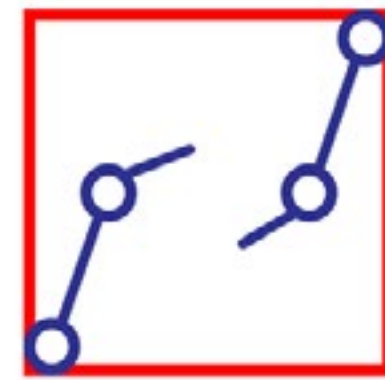

Dynamic
Kinetic
Structure

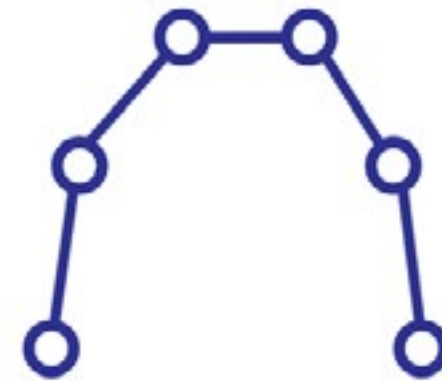

Deployable
Kinetic
Structure

Fox, Michael (2009) *Emphemeralization*

Uitgangspunten

Spatial
Optimization

Multifunction
Design

Contextual
Adaptability

Mobility

Fox, Michael (2009) *Interactive Architecture*
Zuk, William (1970) *Kinetic Architecture*

Uitgangspunten

- Kinetisch ontwerpen

- Onderzoeksvraag:

“Hoe kan kinetisch ontwerpen helpen om een strandhuis te maken dat minder schadelijk is voor de duinen en verder minder kosten met zich meebrengt?”

- Locatie

- Doelgroep

Gehele Structuur

Vorm

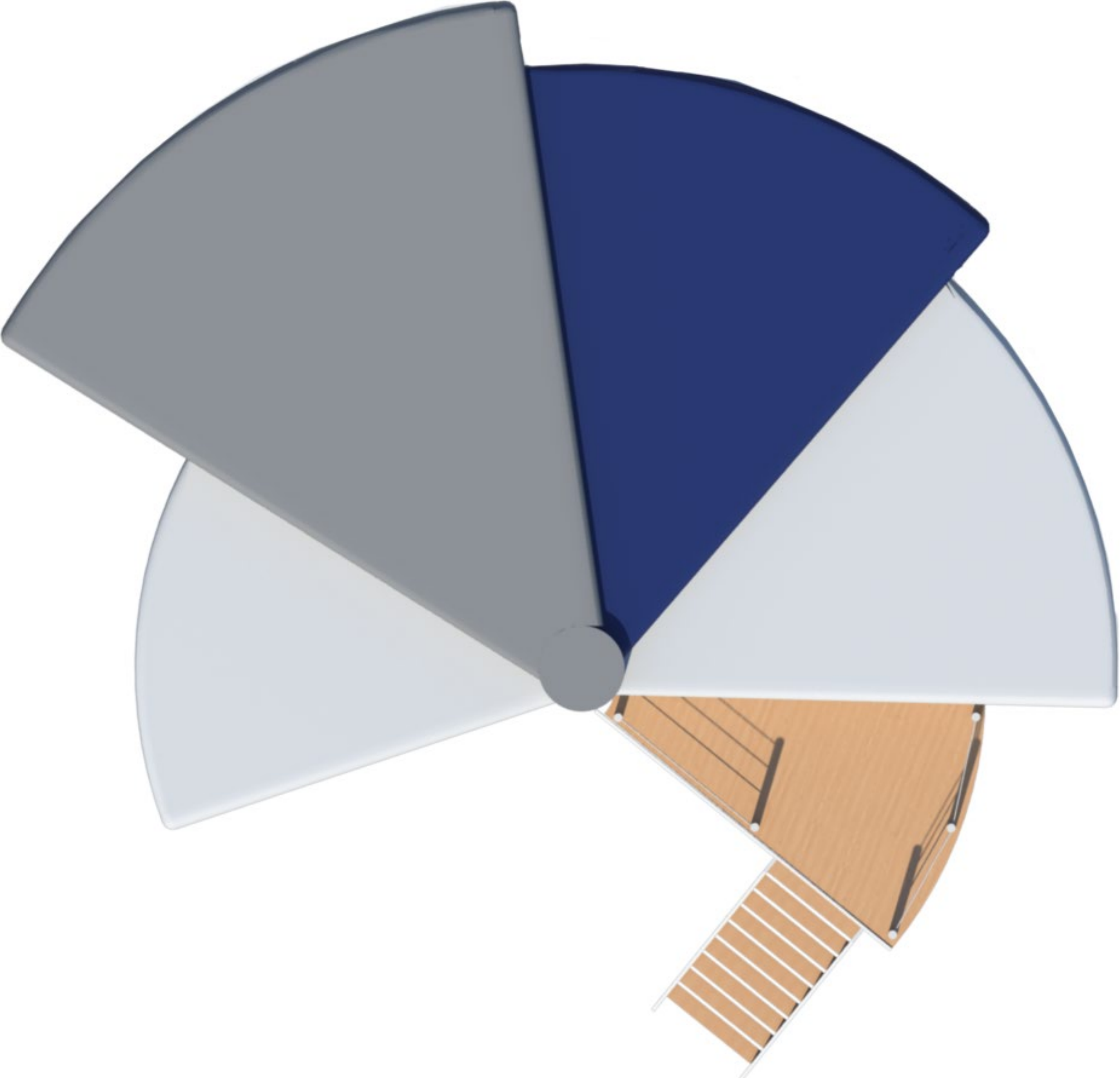

Vorm

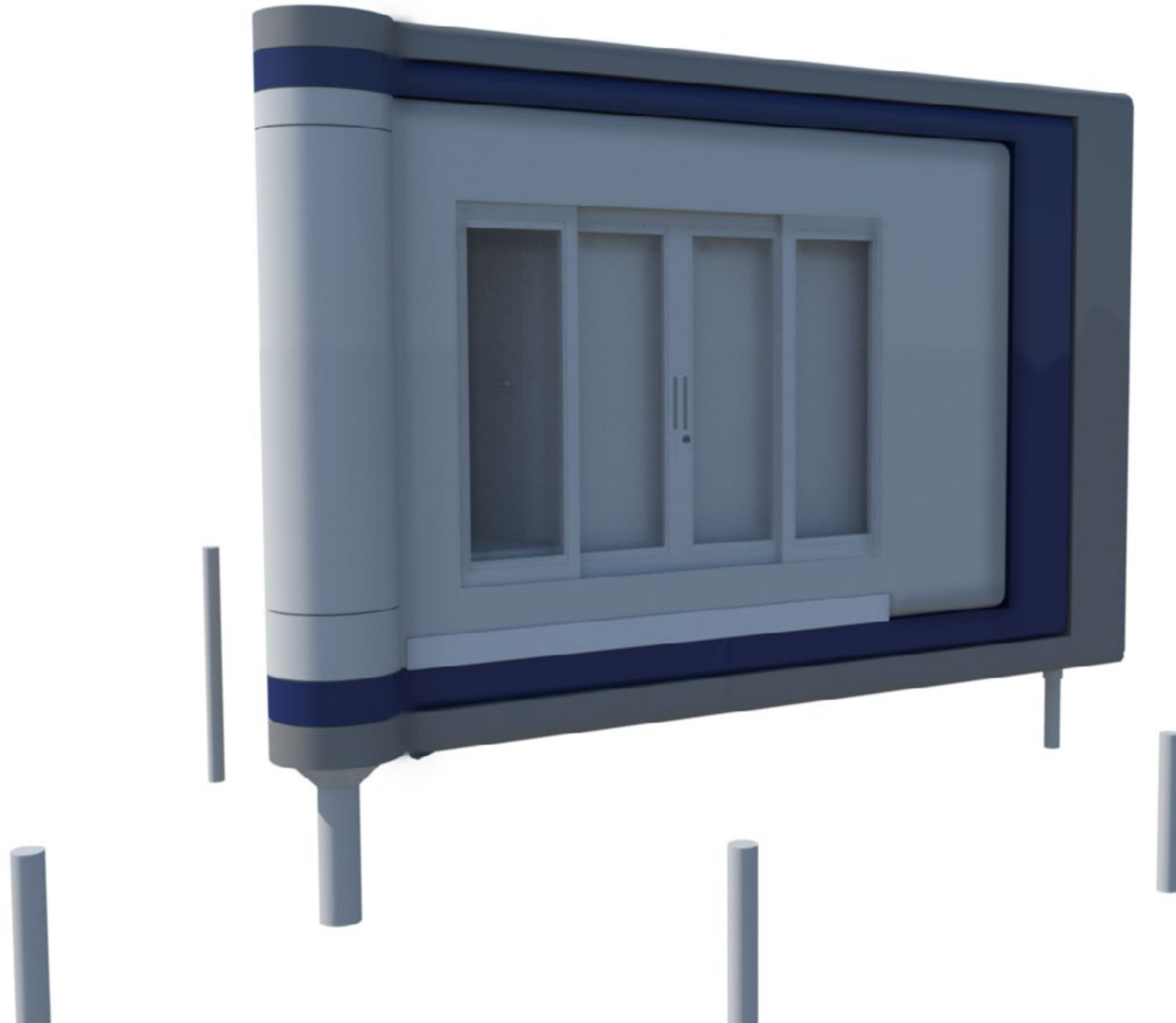

Plaatsing

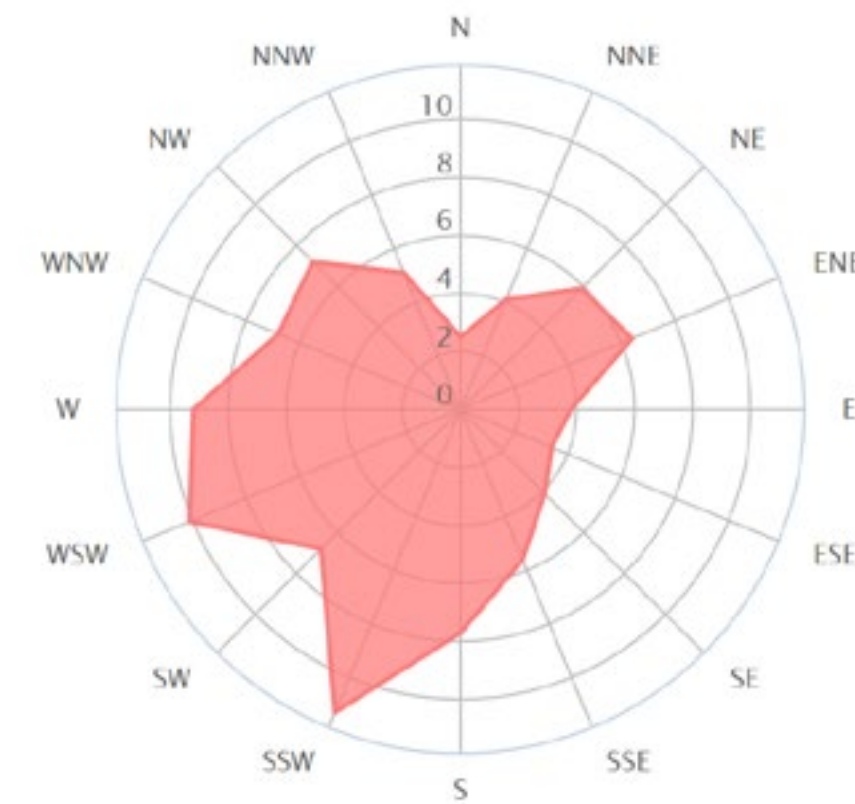
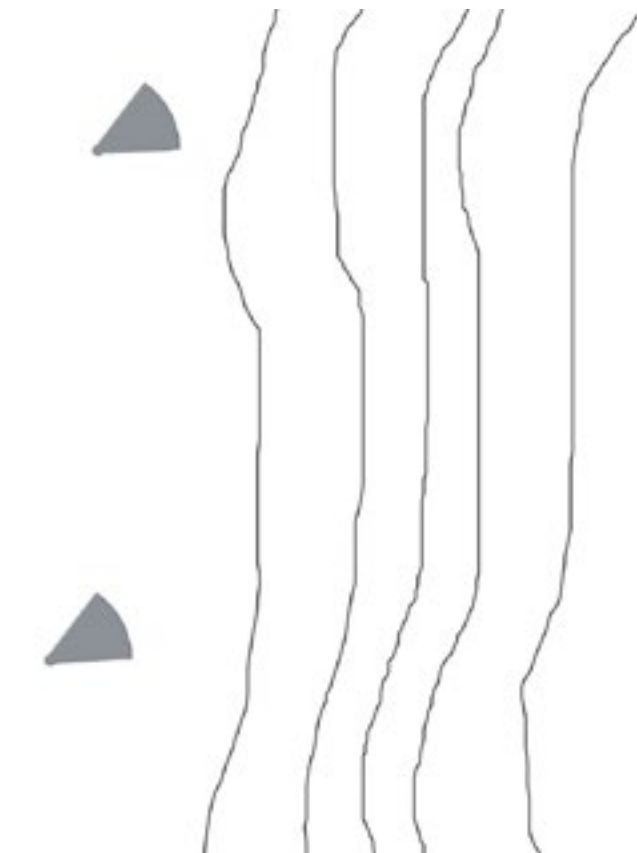
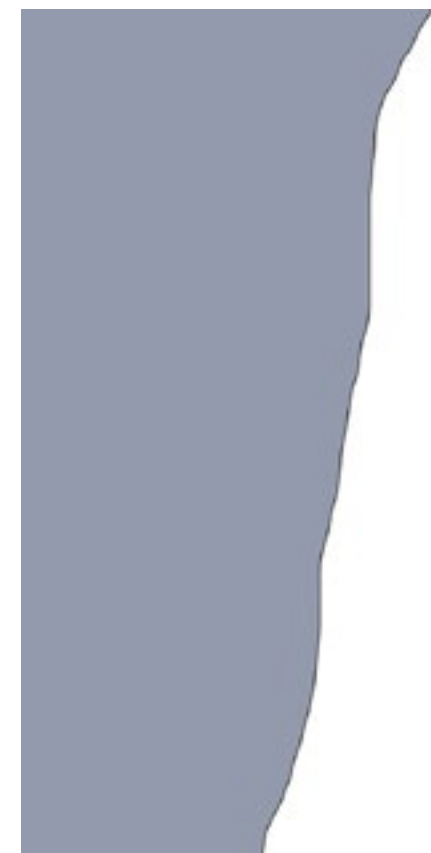
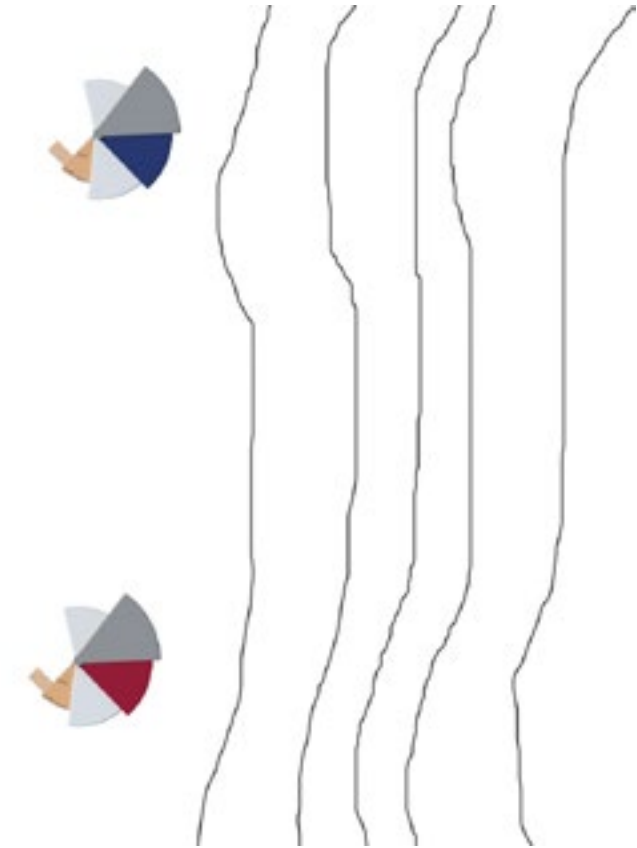
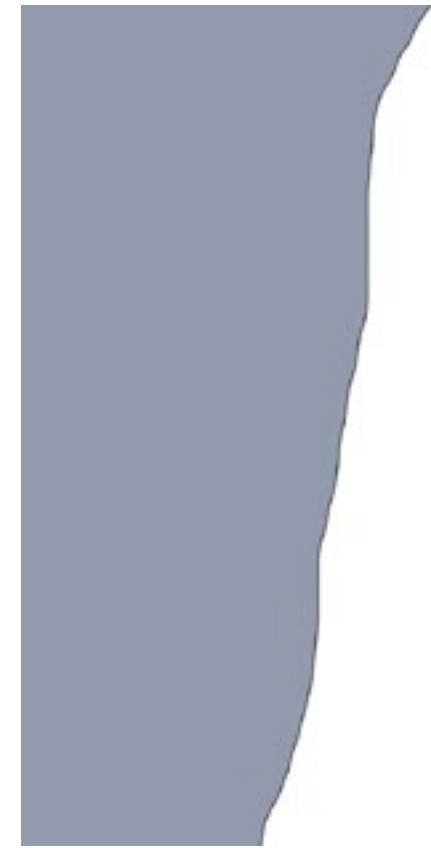

Transformatie

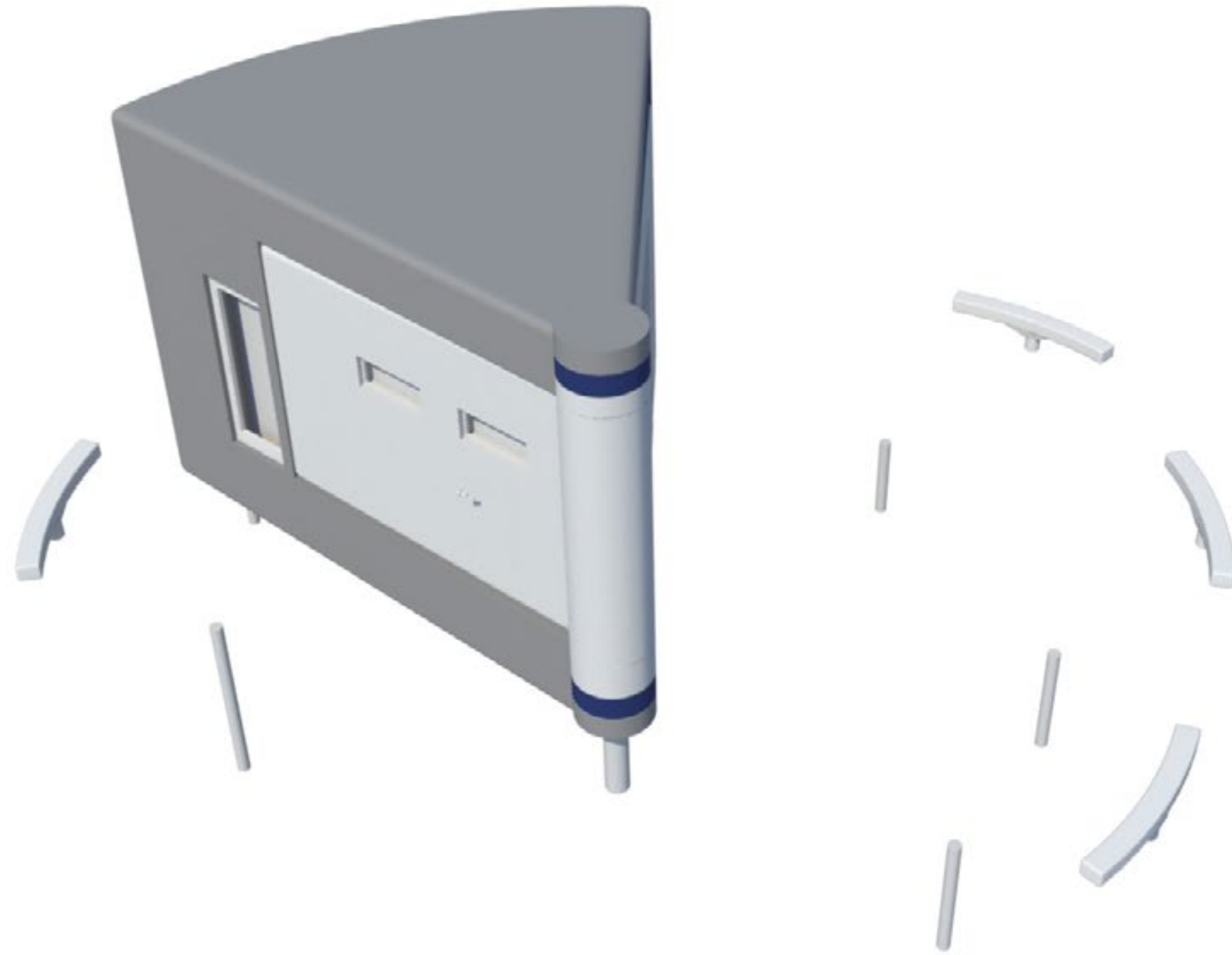

Transformatie

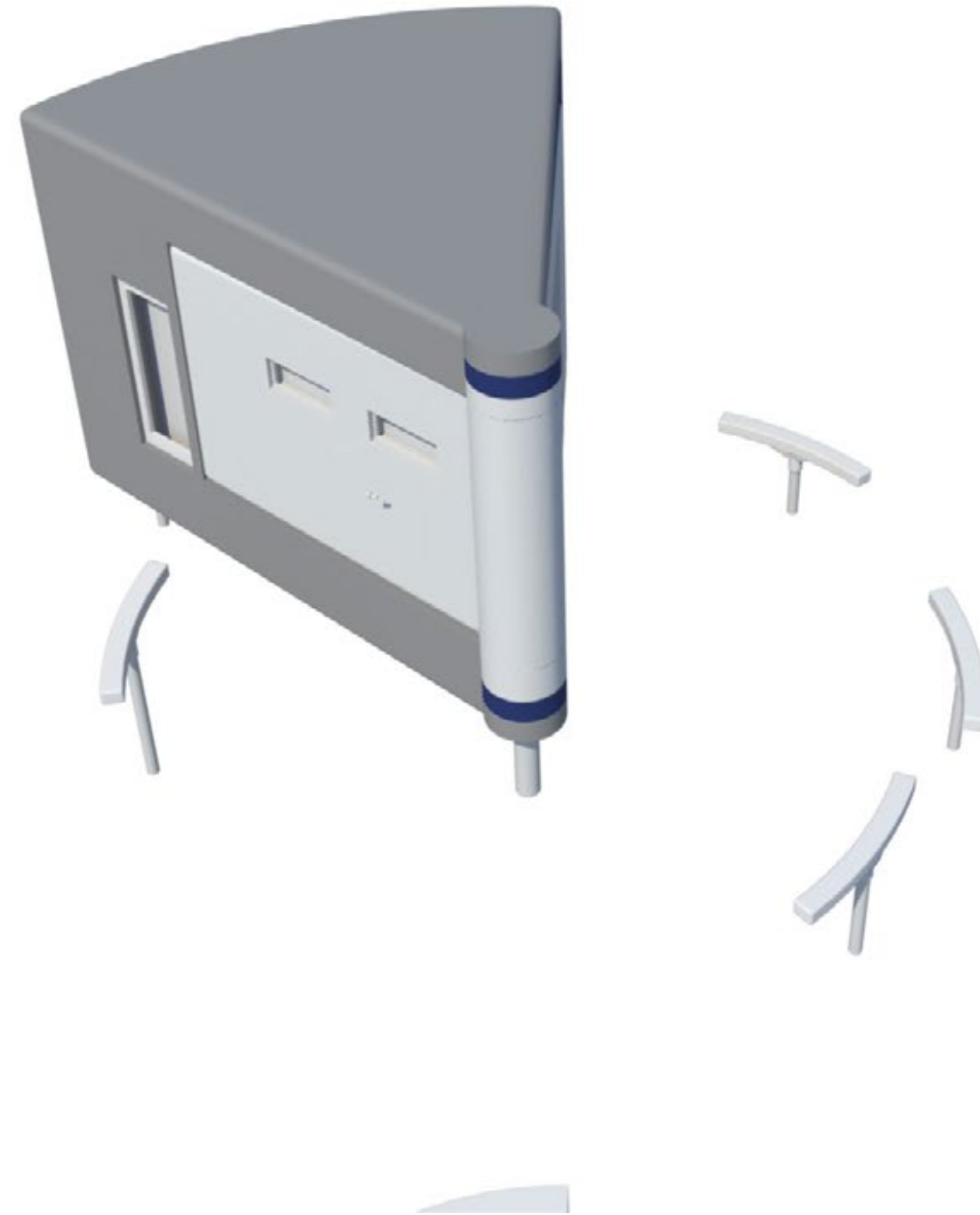

Transformatie

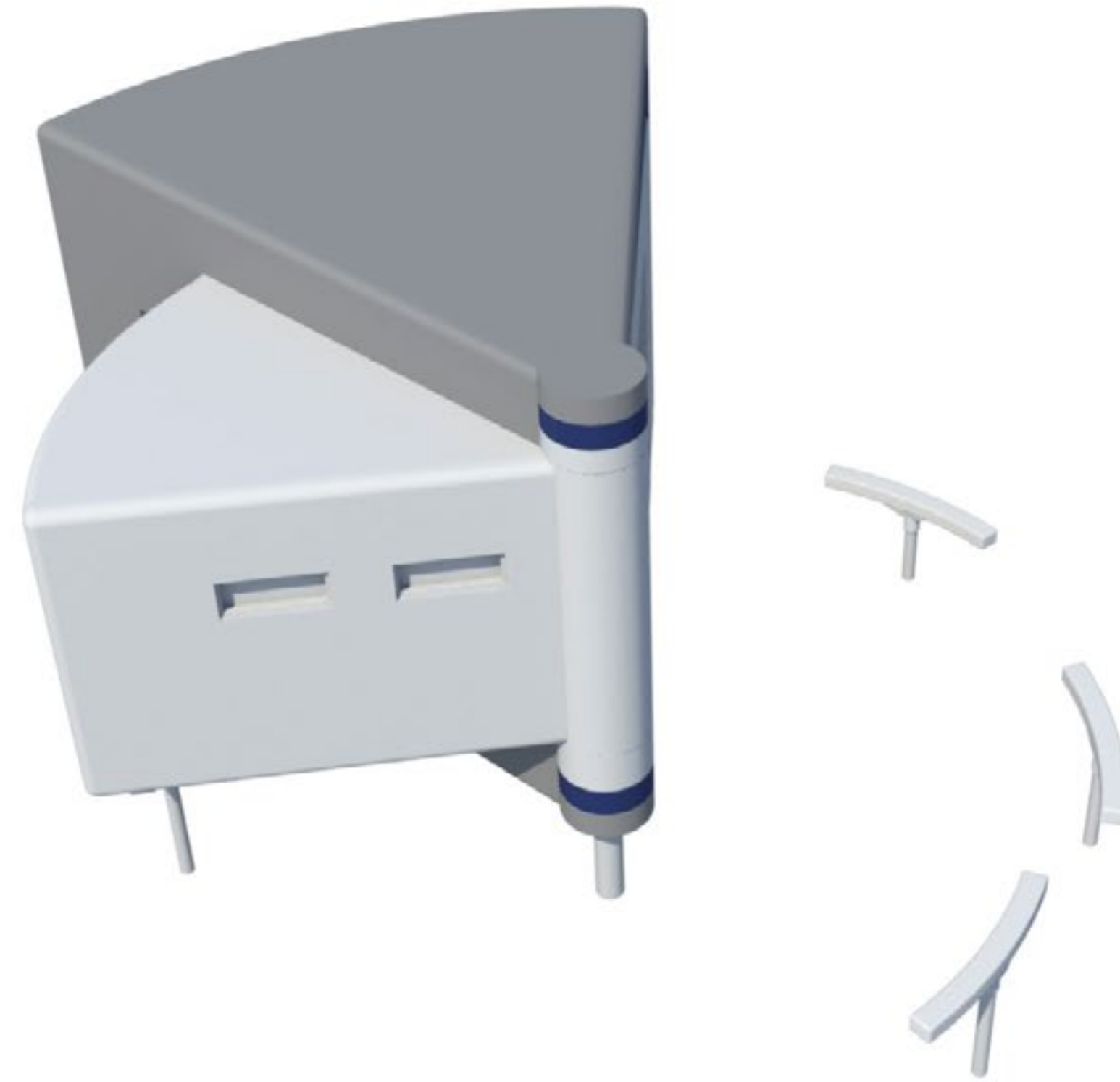

Transformatie

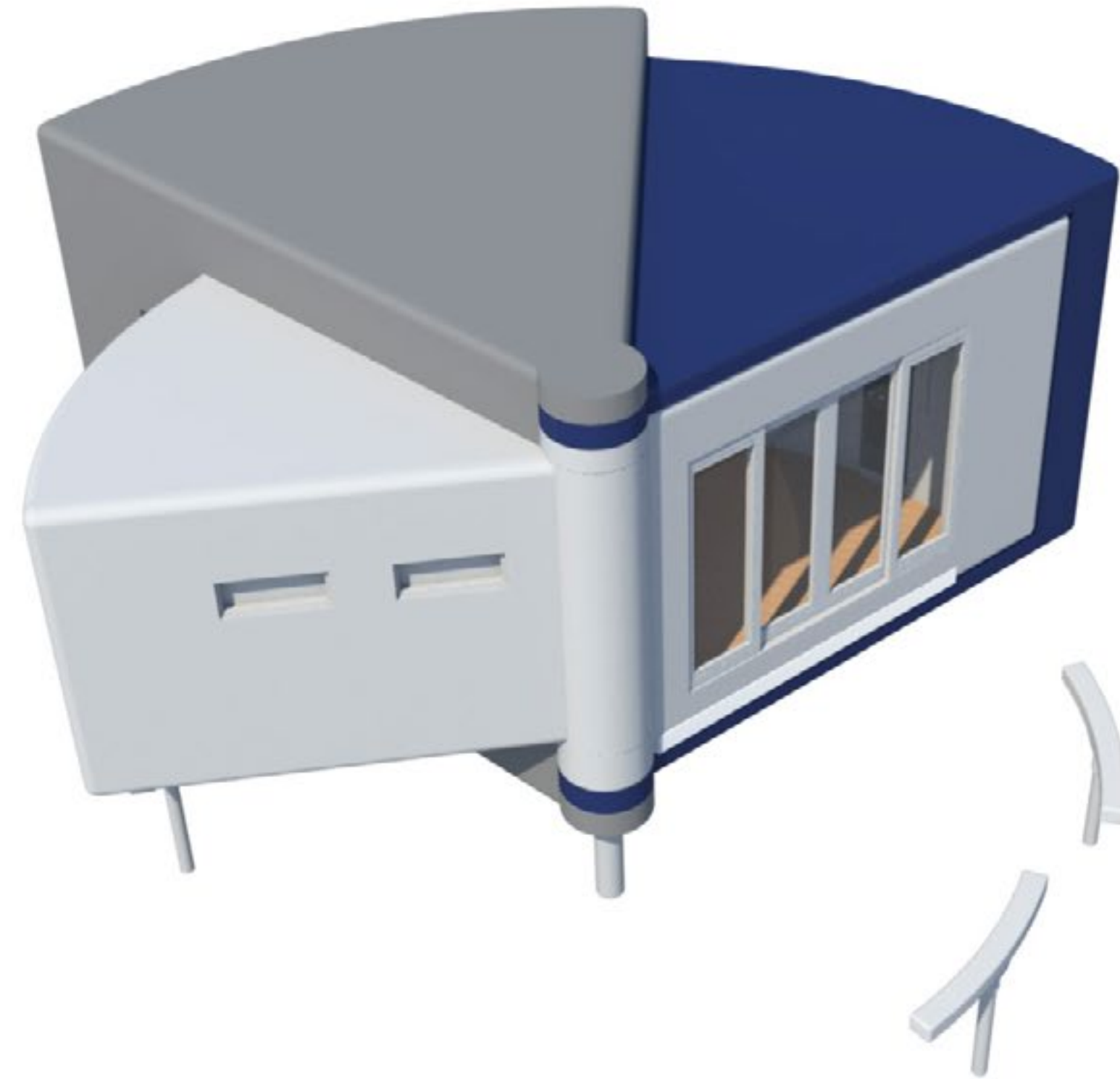

Transformatie

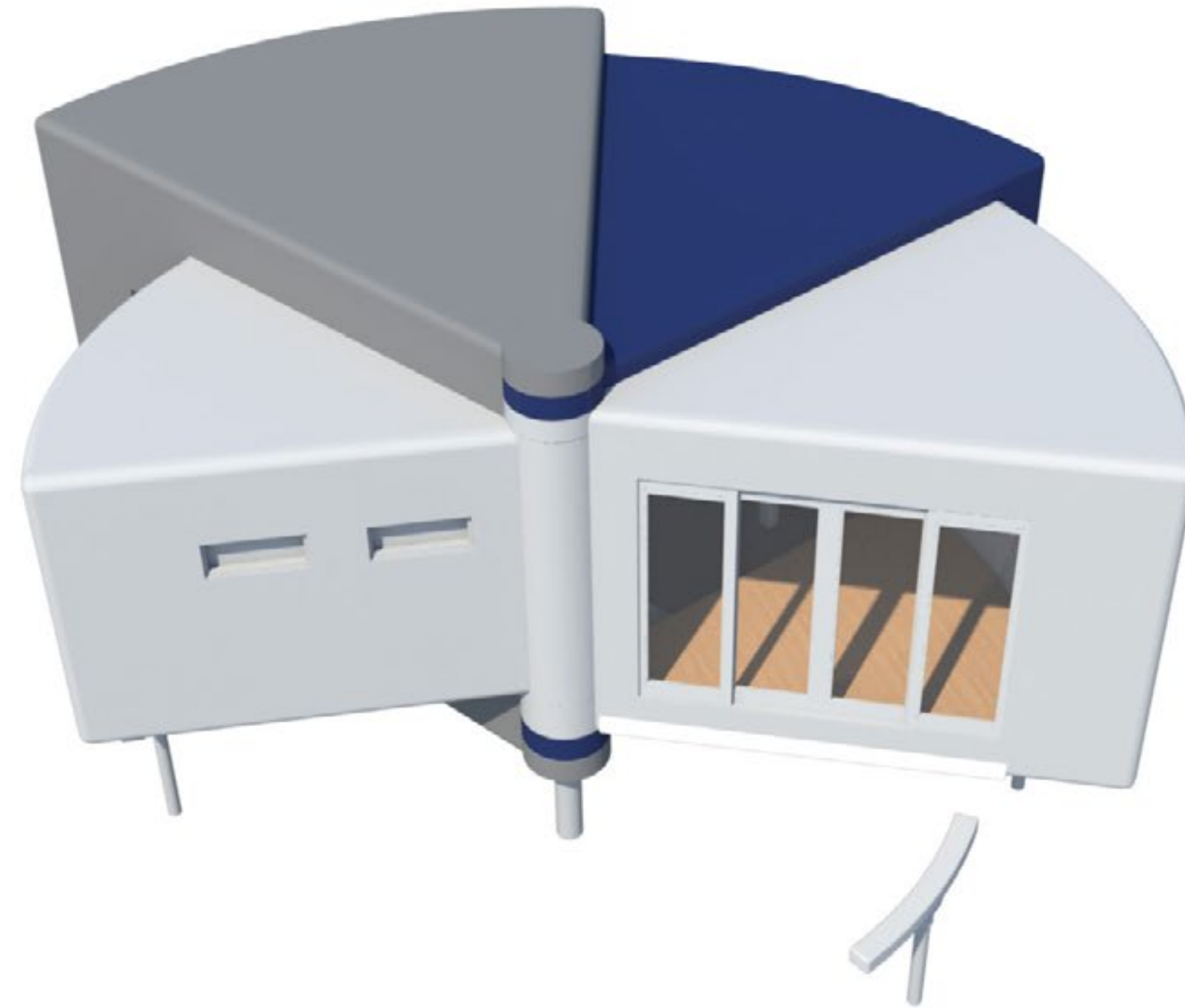

Transformatie

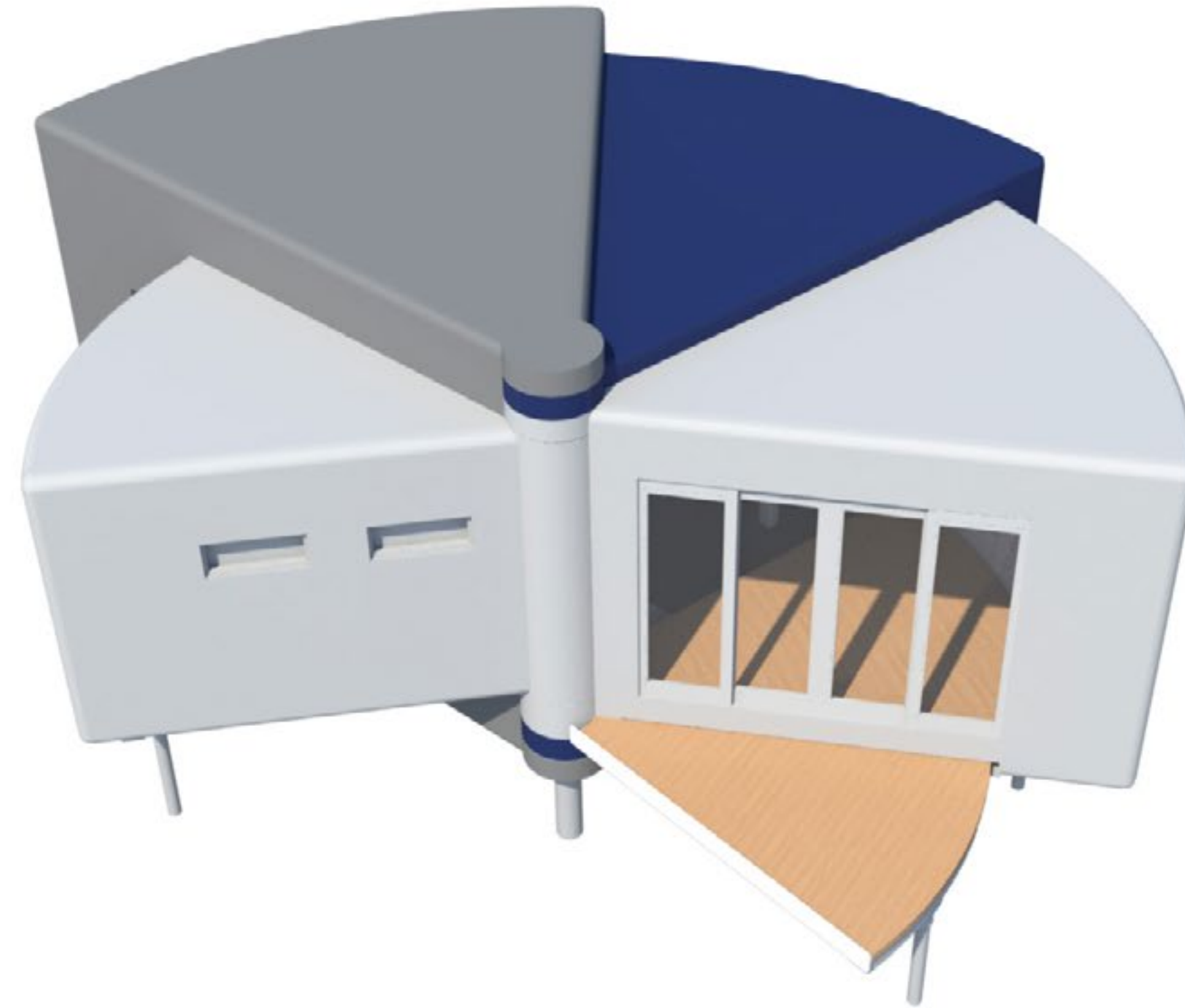

Transformatie



Materiaal

- Stalen Liggers
 - extra sterk vloervlak
- Vezelversterkte composieten
 - gewichtsbeparend
 - sterk, stijf, thermische- en elektrische weerstand
 - waterbestendig en bestand tegen zout

Opbouw vloervlak



Opbouw vloervlak

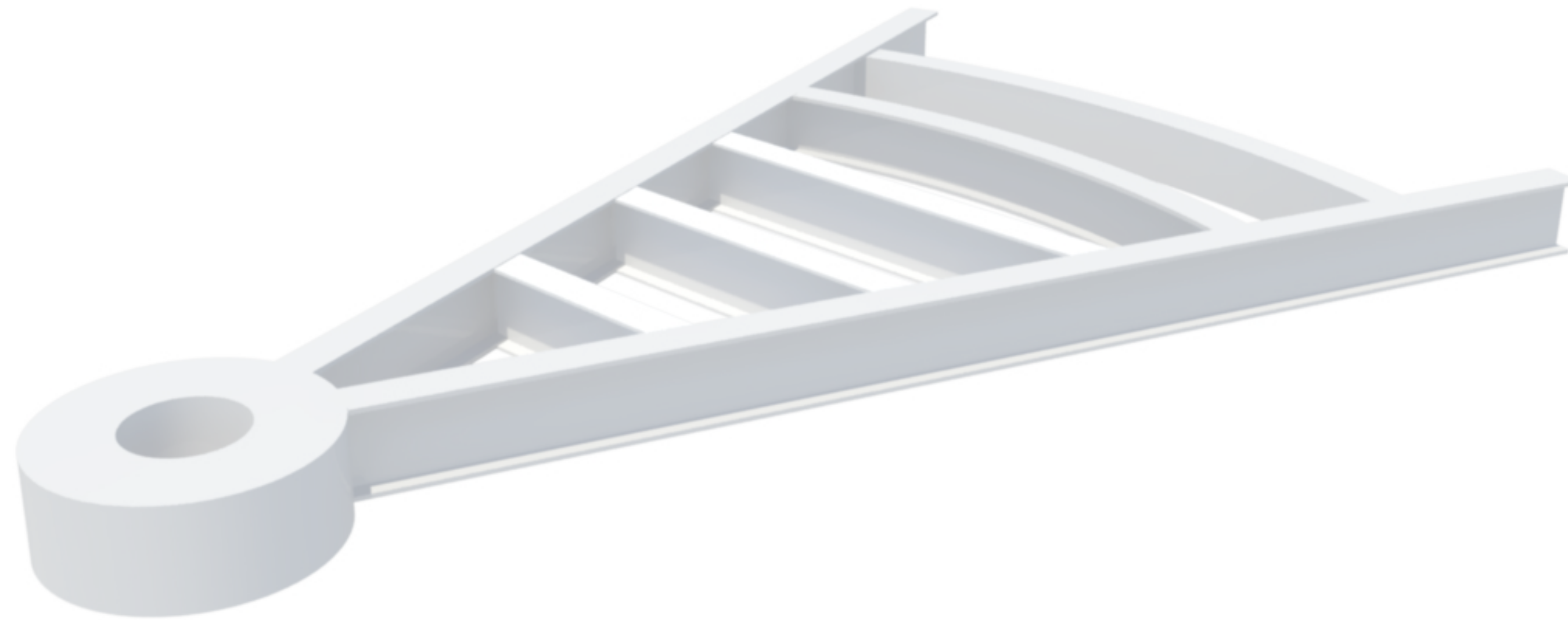

Opbouw vloervlak

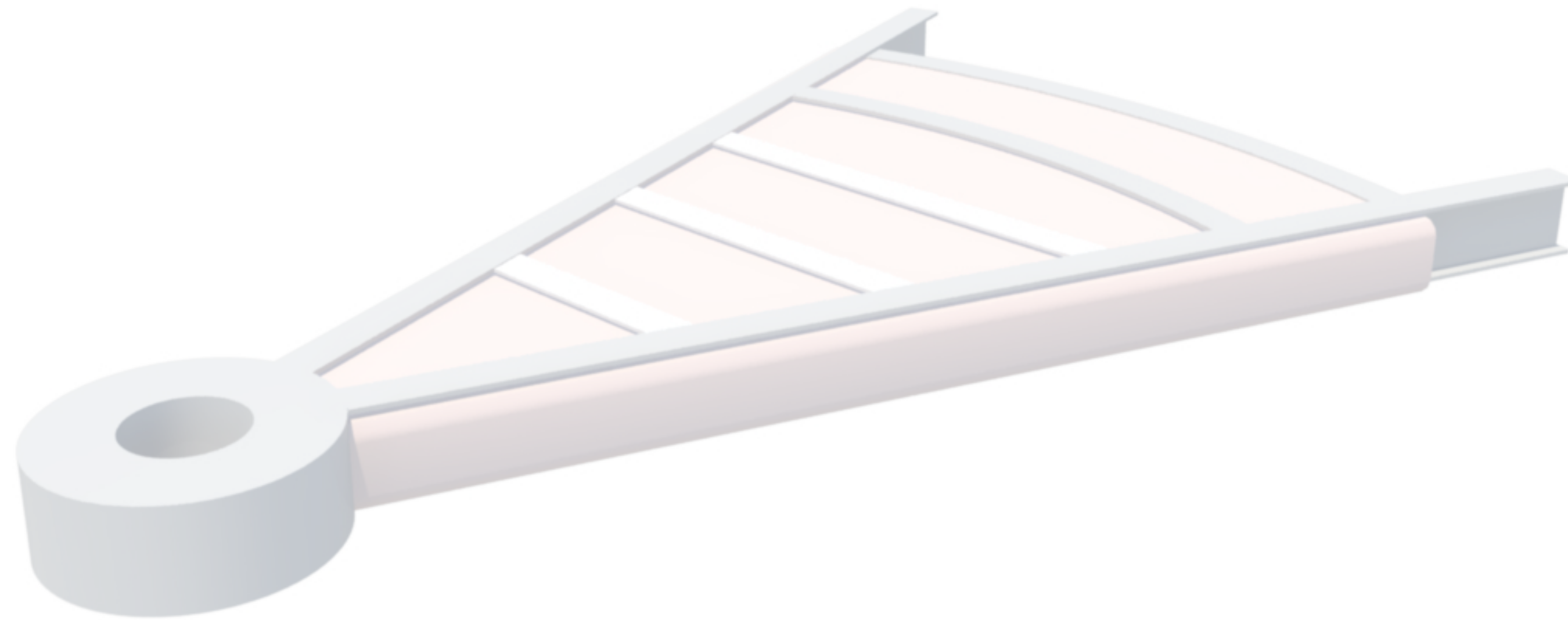

Opbouw vloervlak

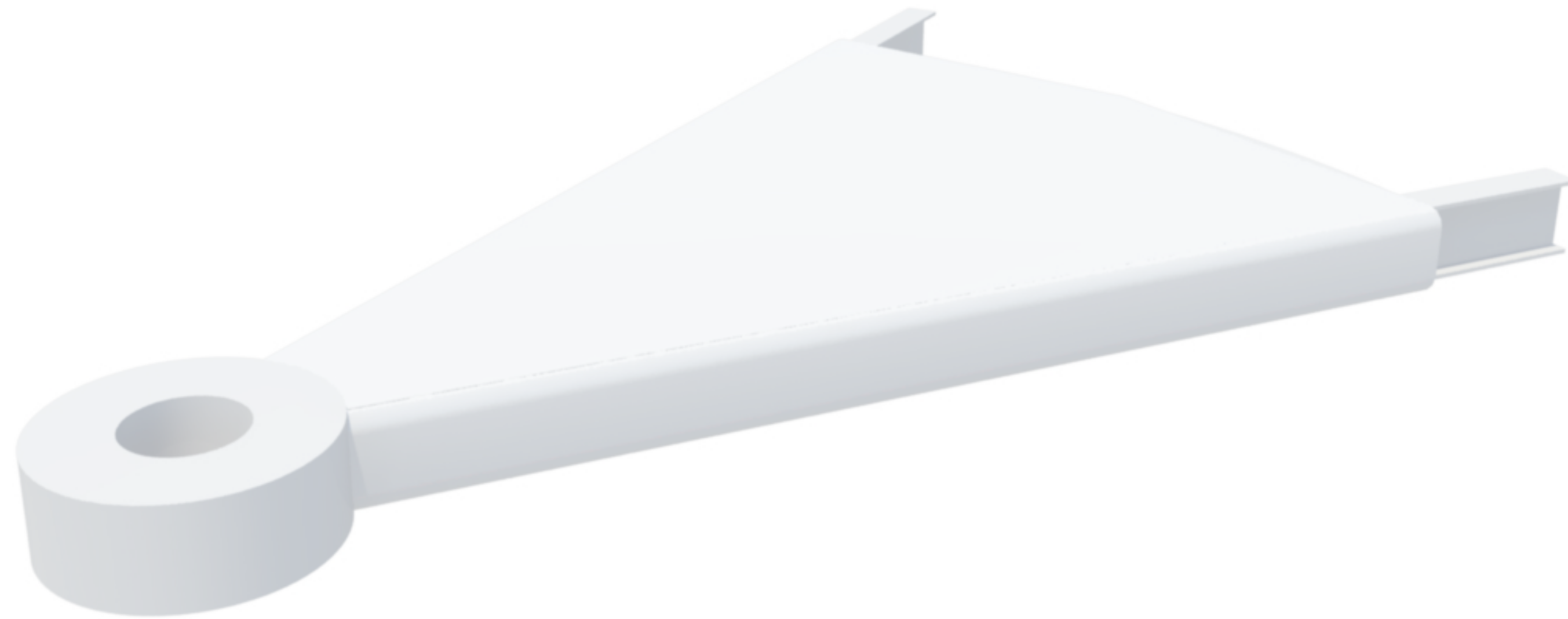

Opbouw vloervlak



Plattegrond

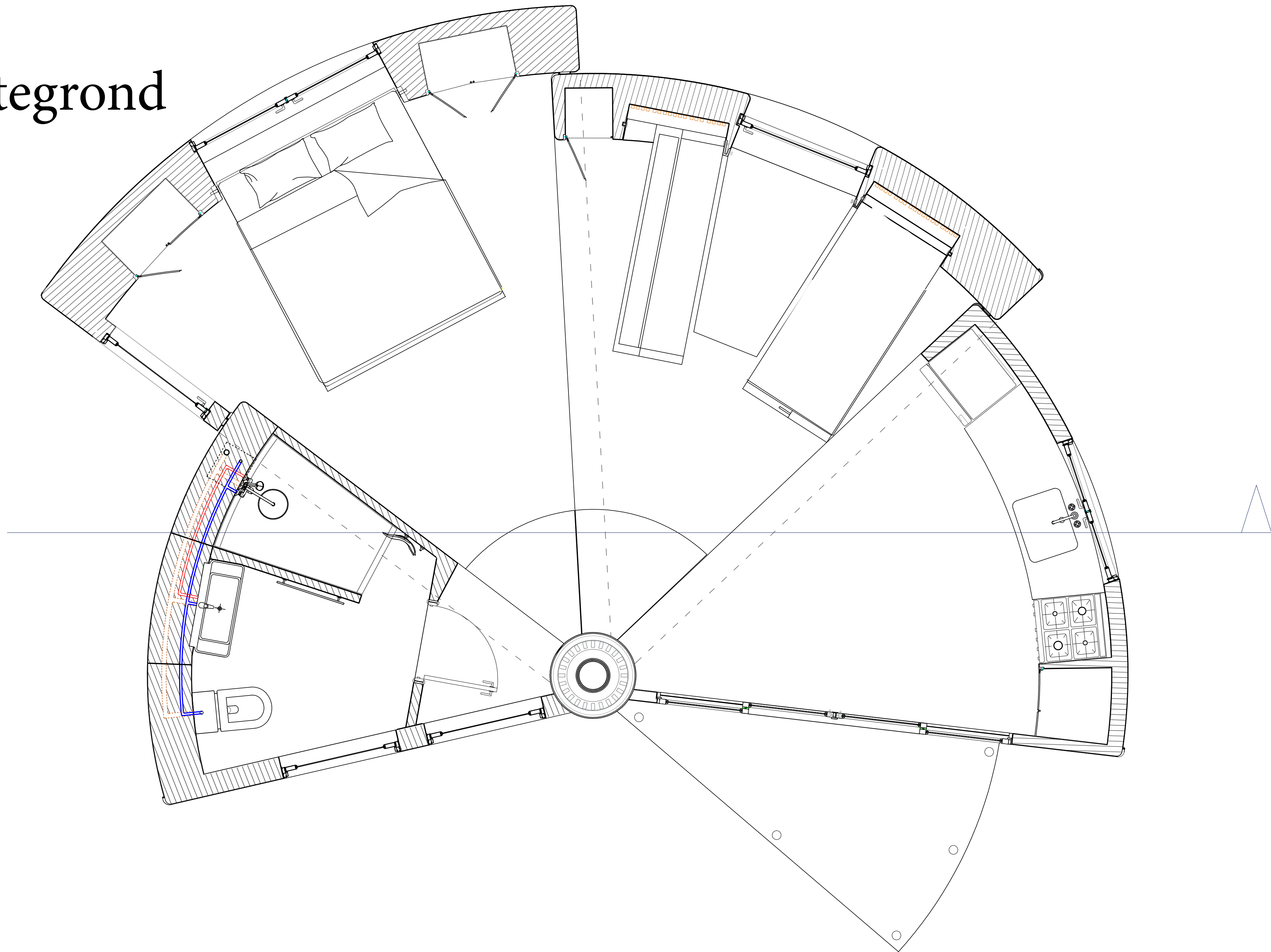

Plattegrond

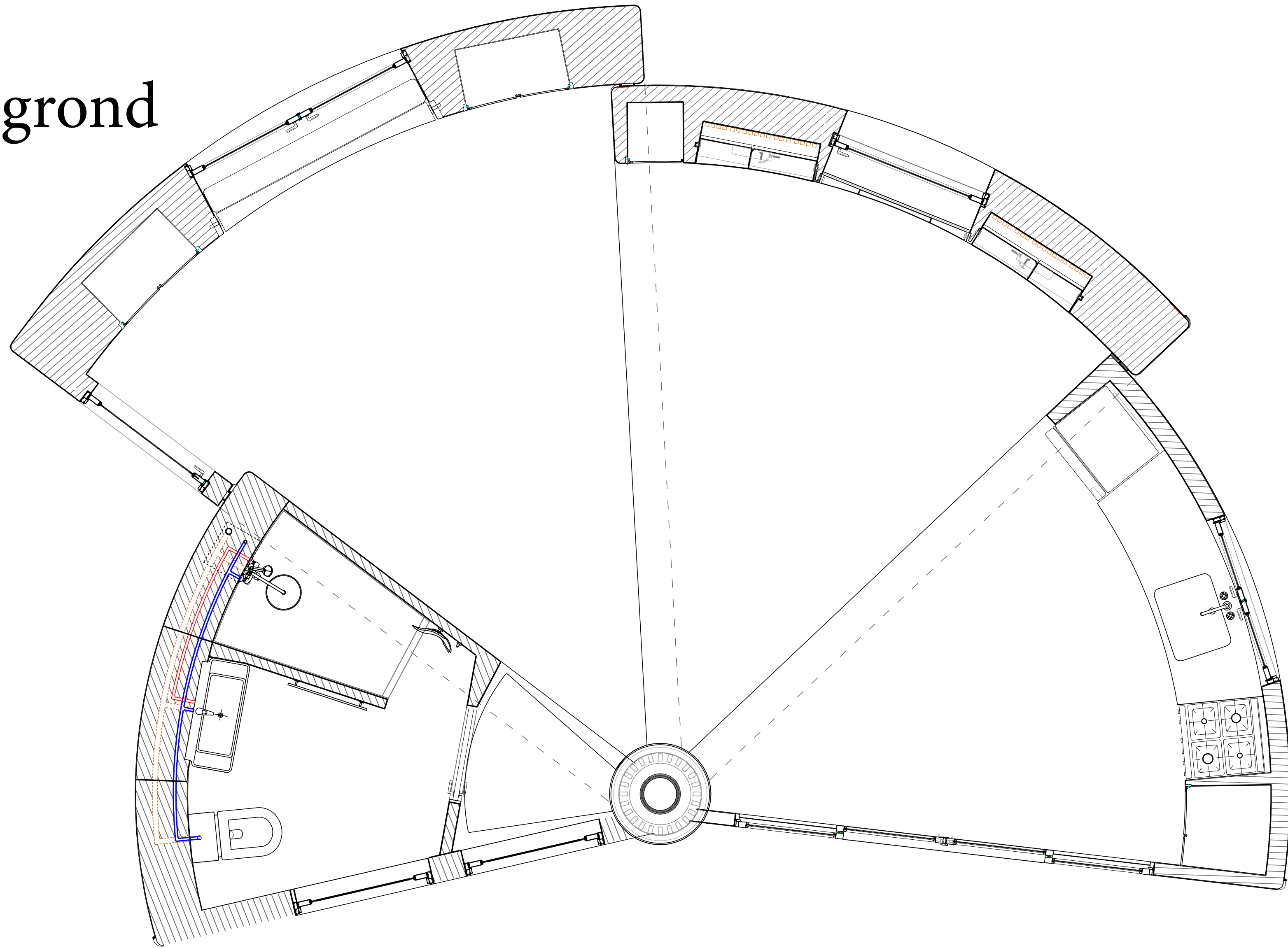

Plattegrond

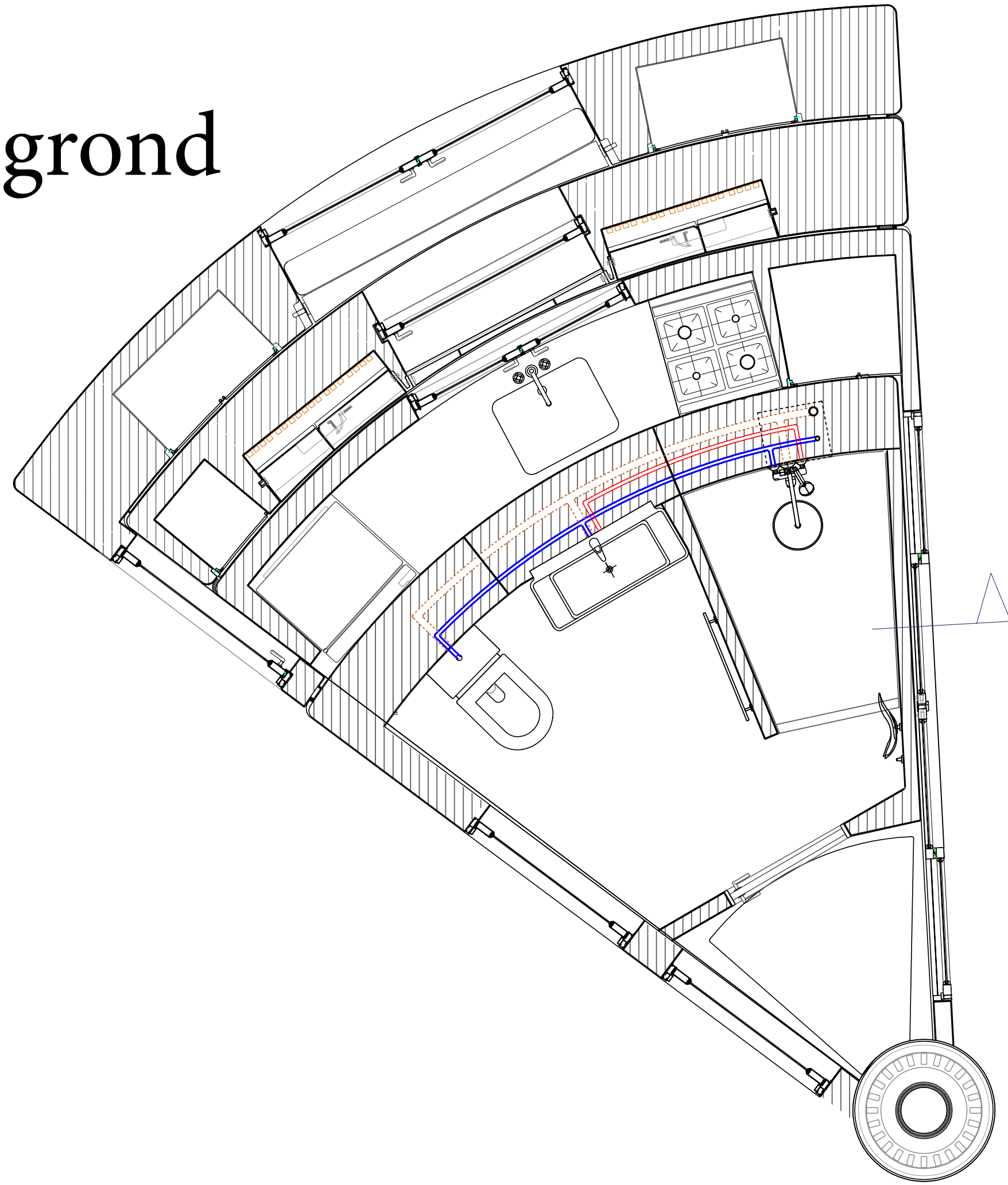

Details

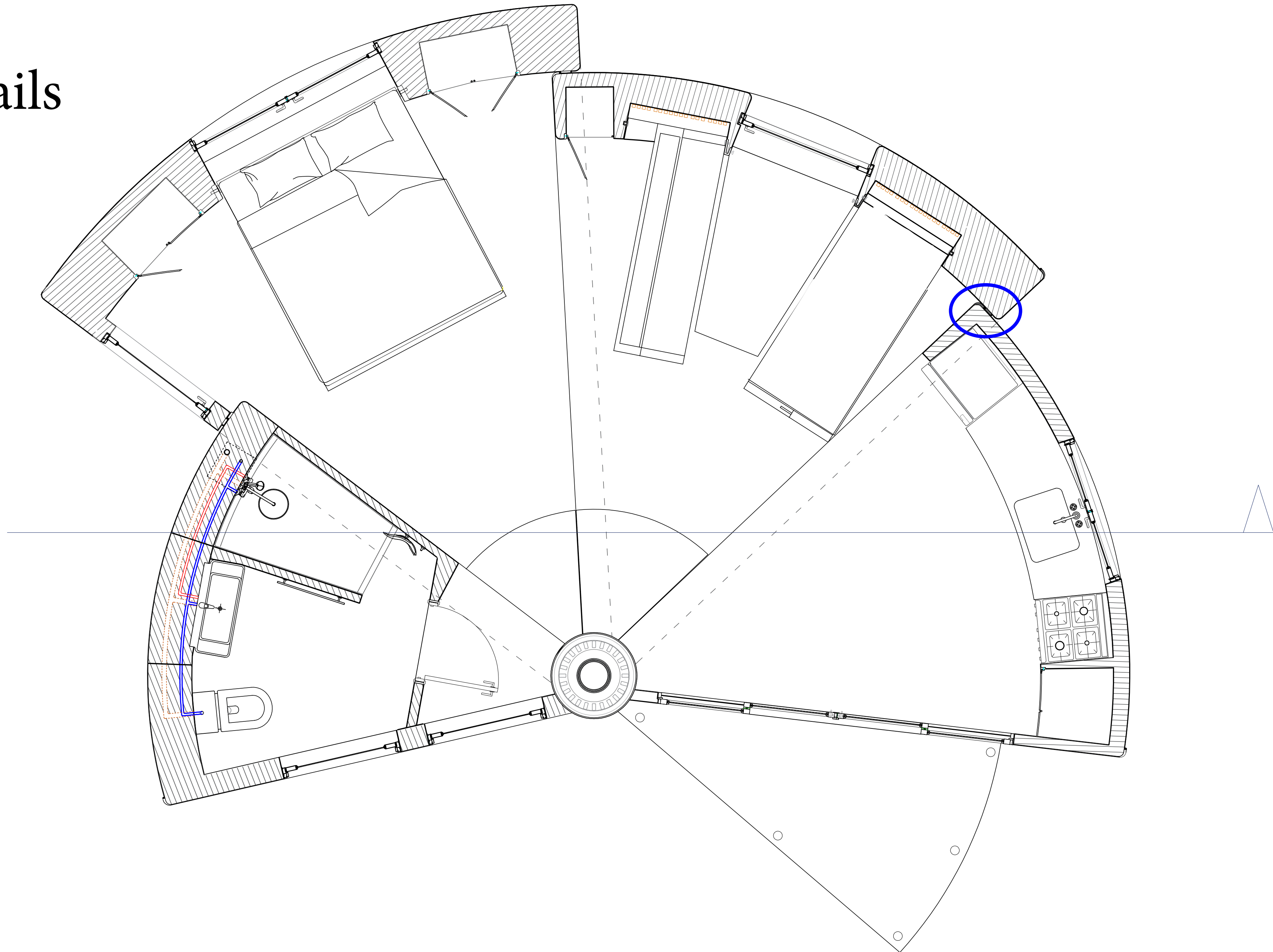

Details



Details

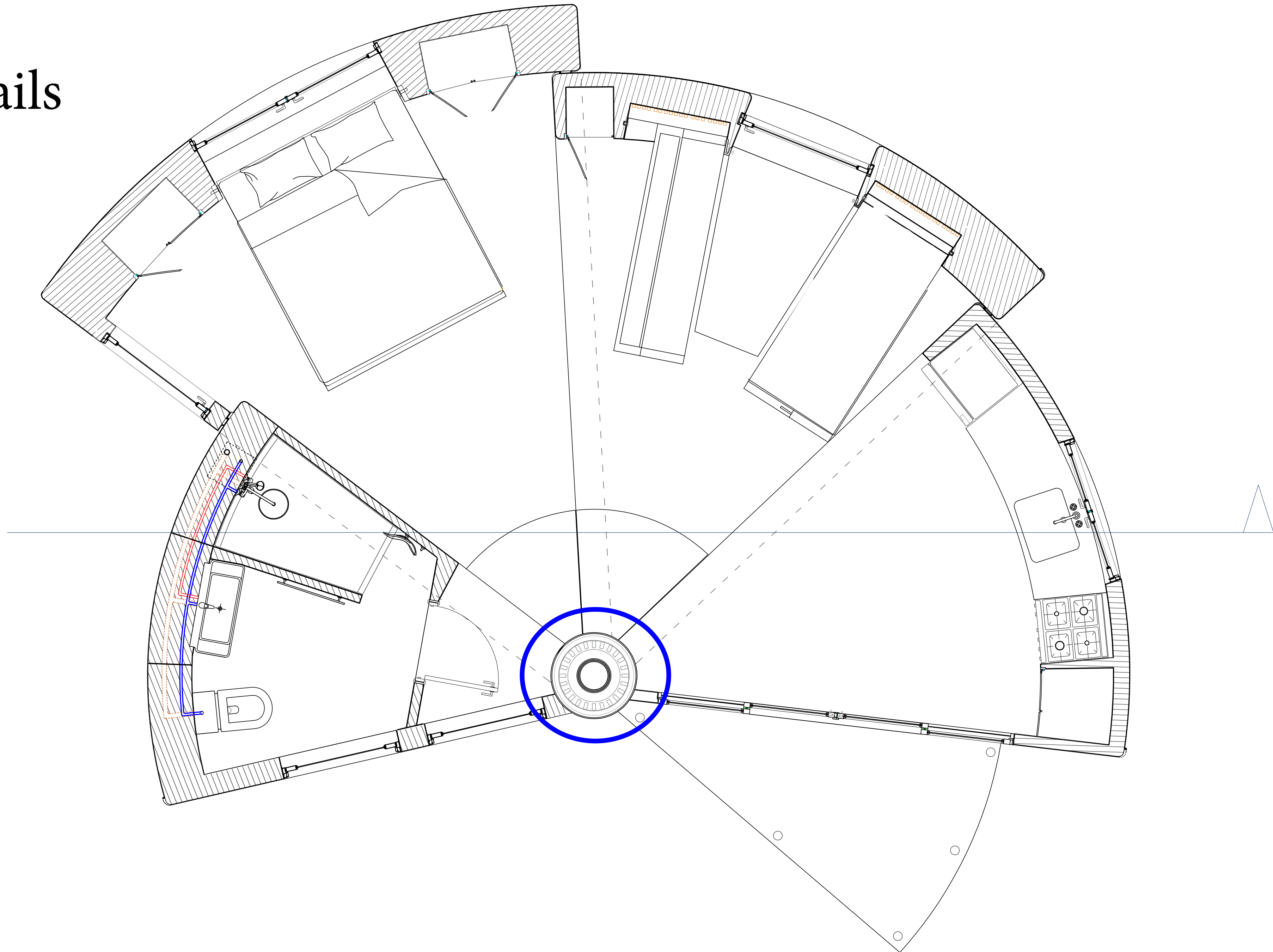

Details

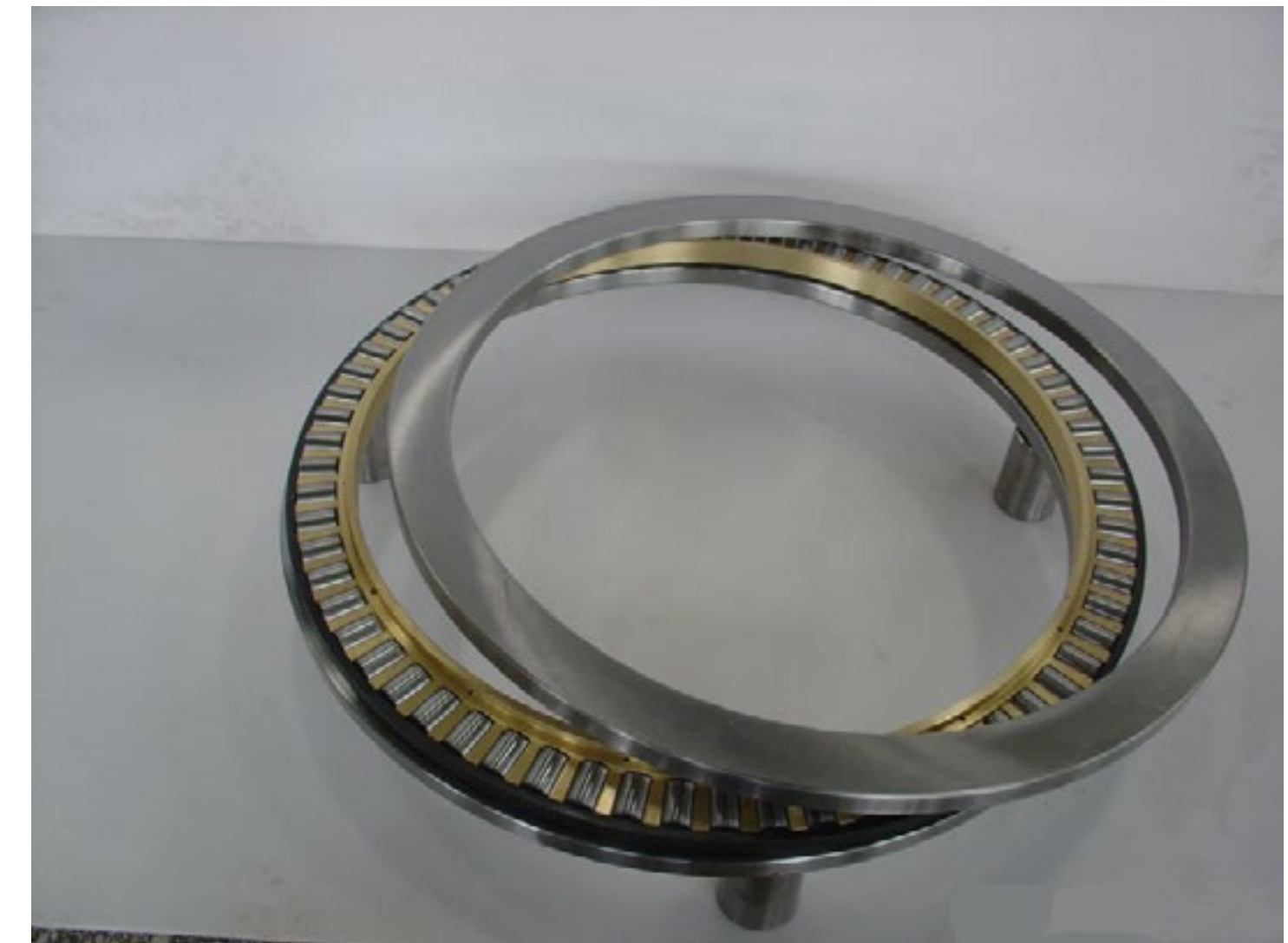
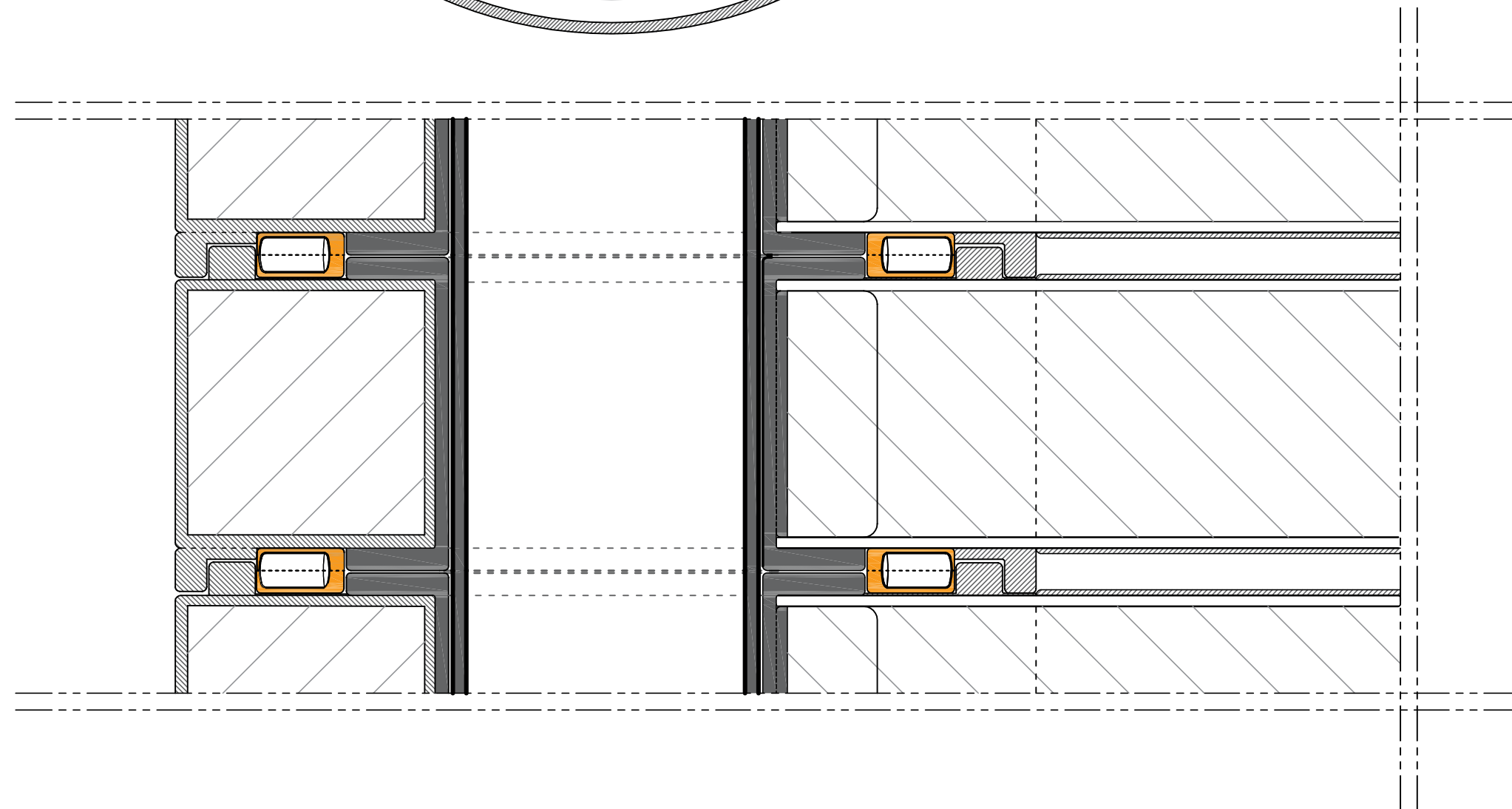
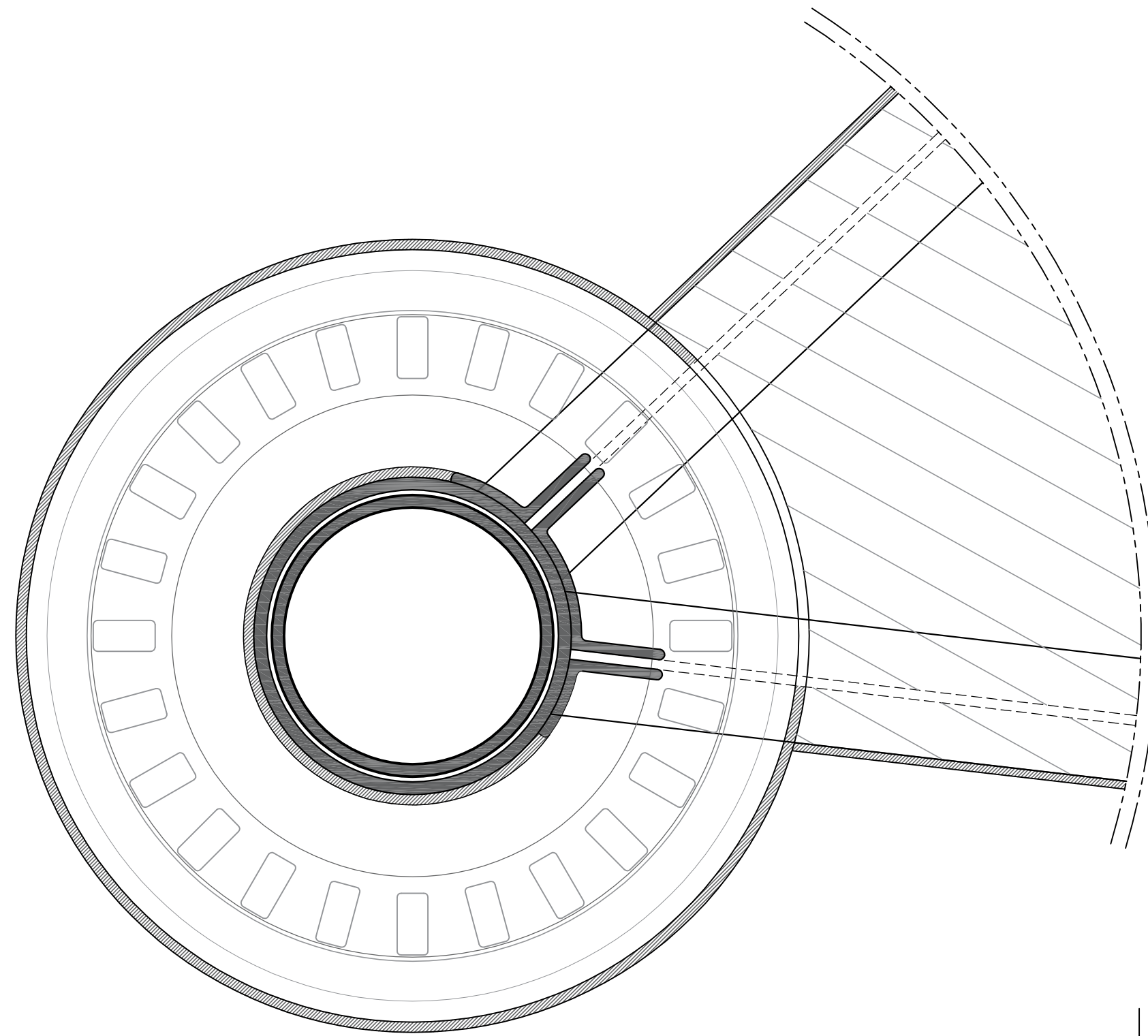

Doorsnede

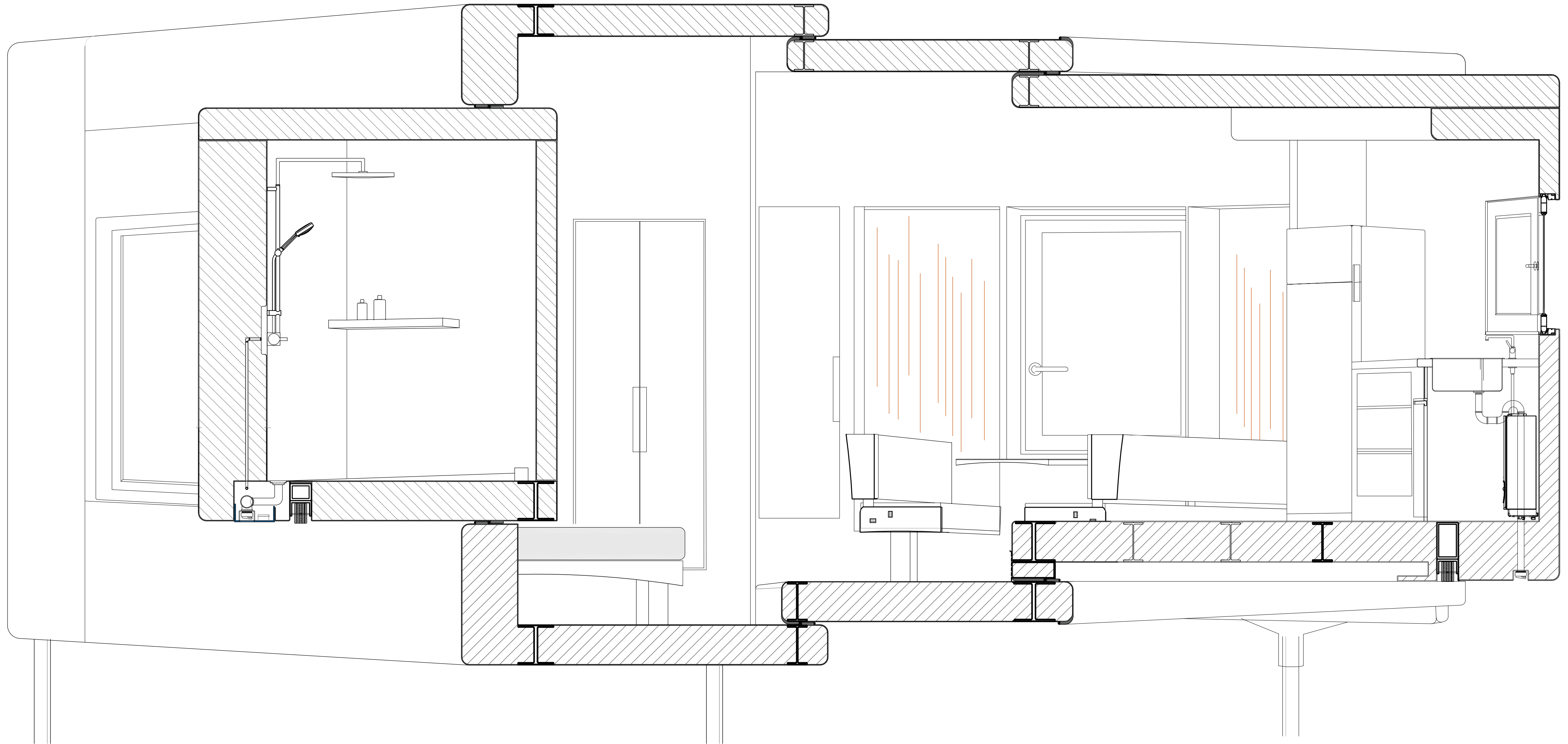

Details

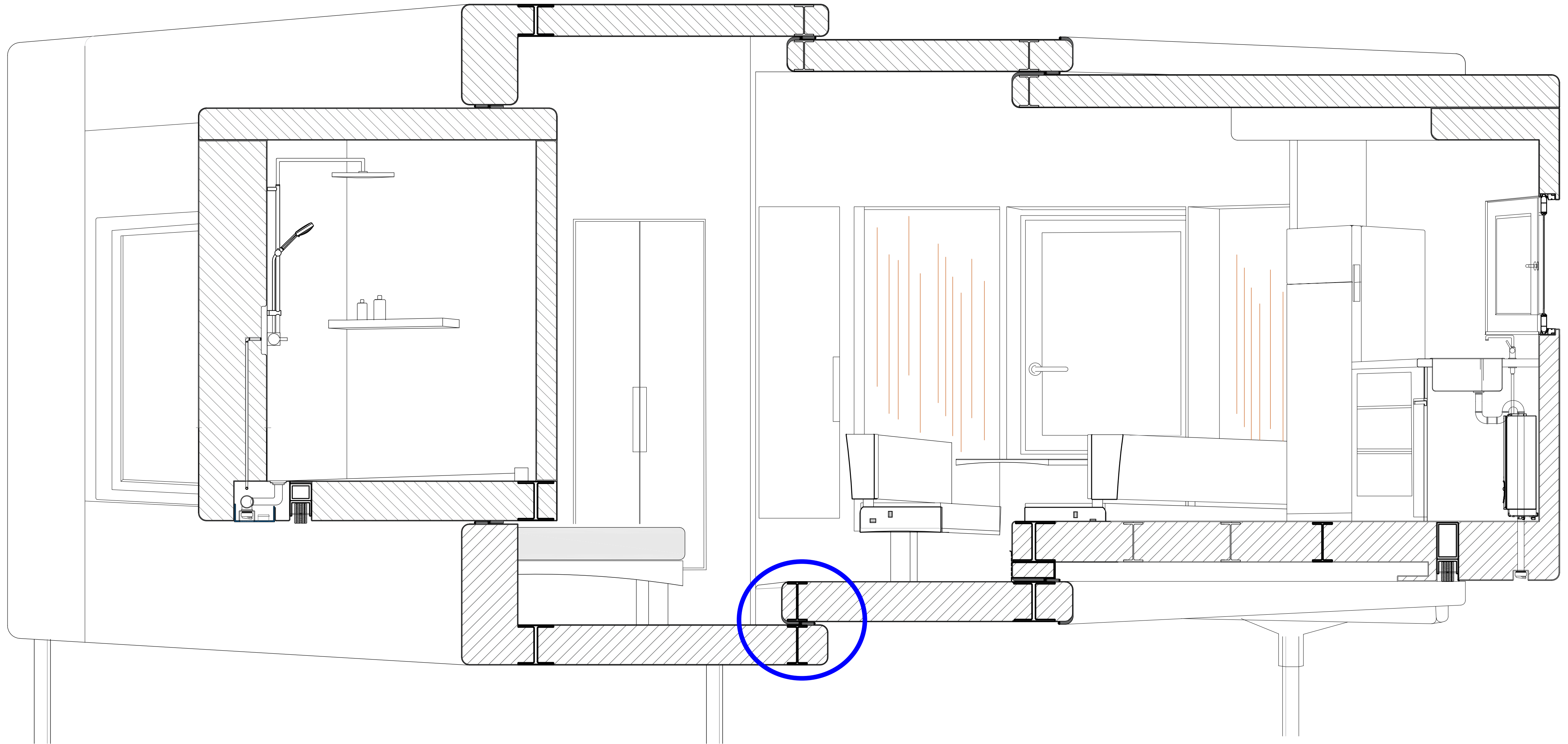

Details

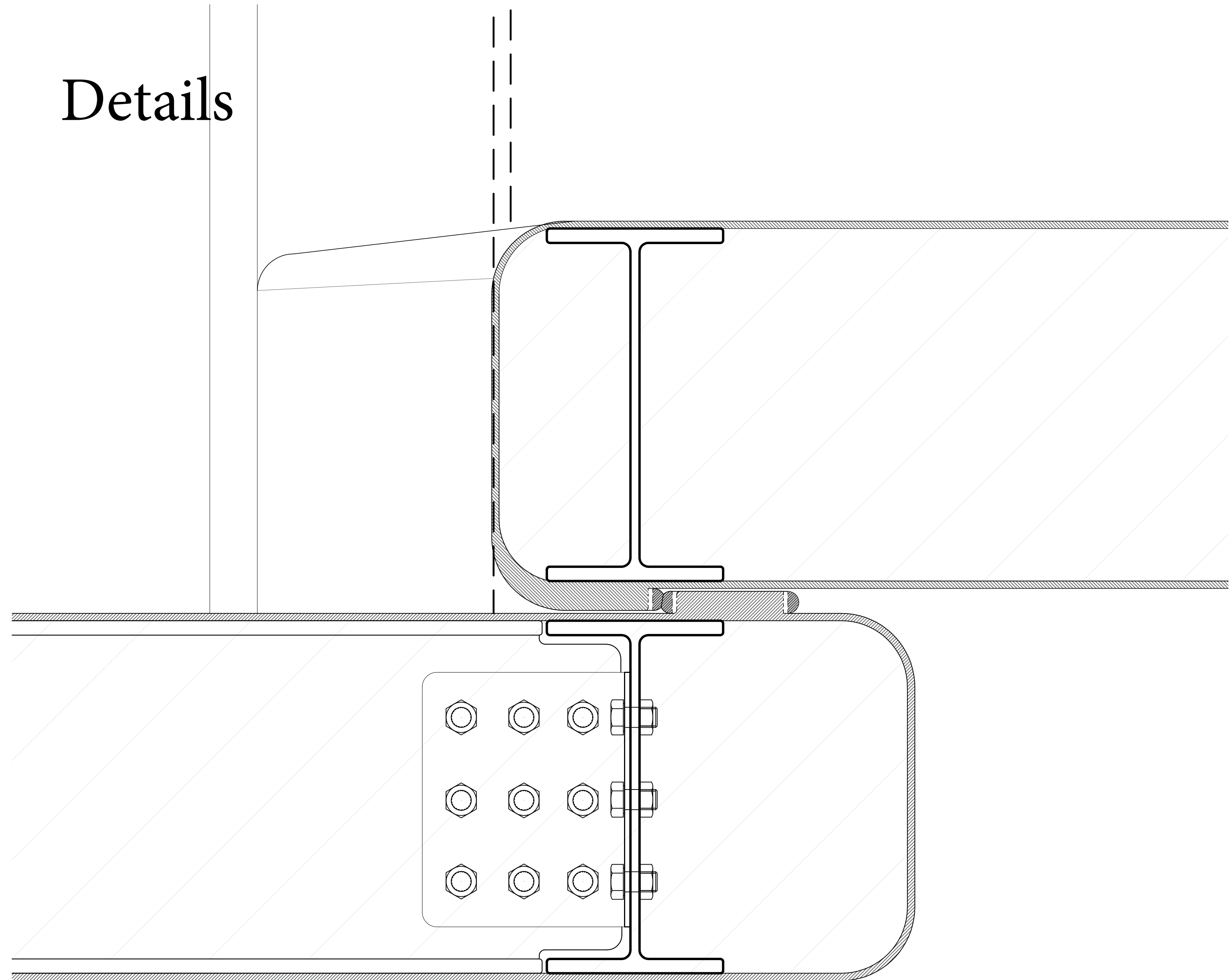

Details

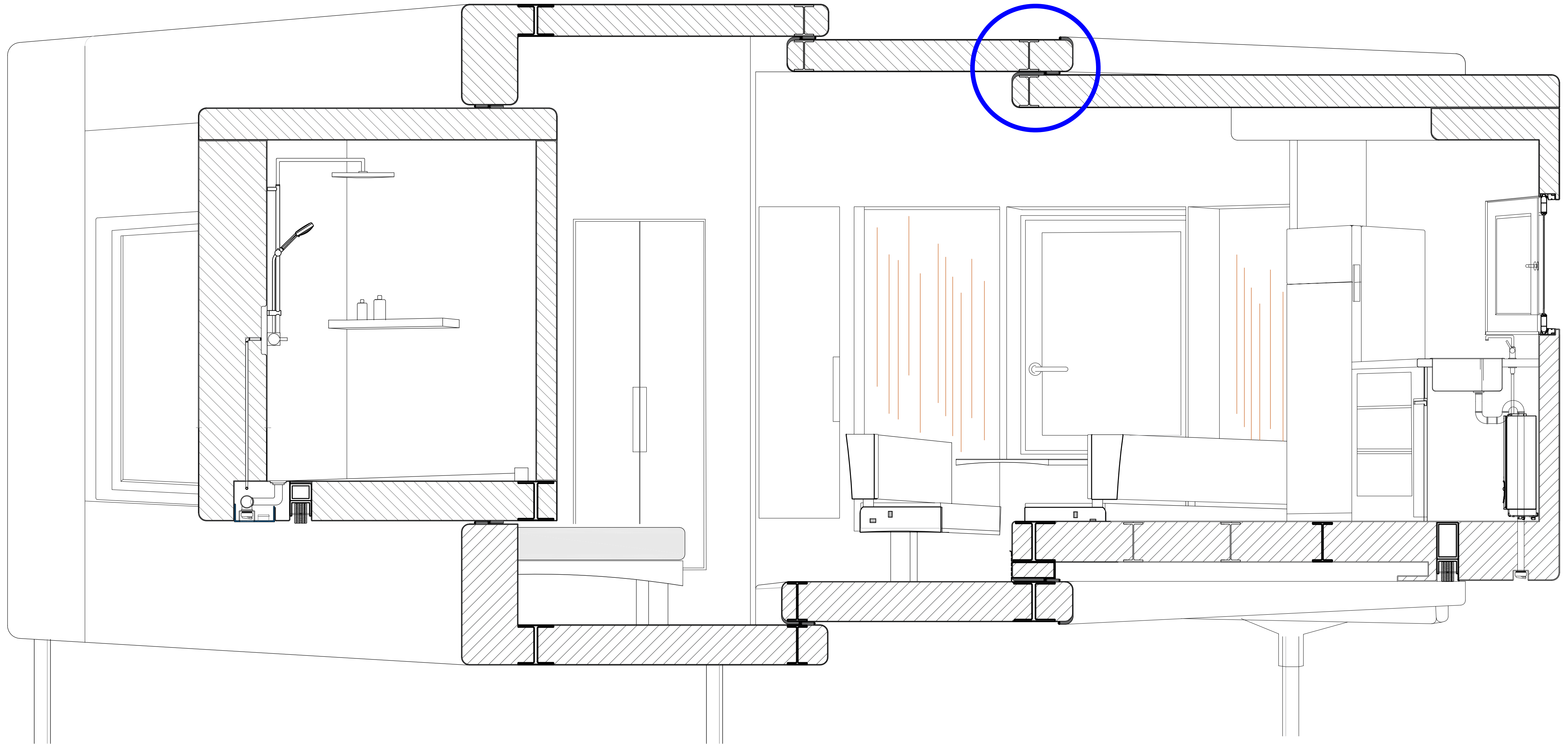

Details

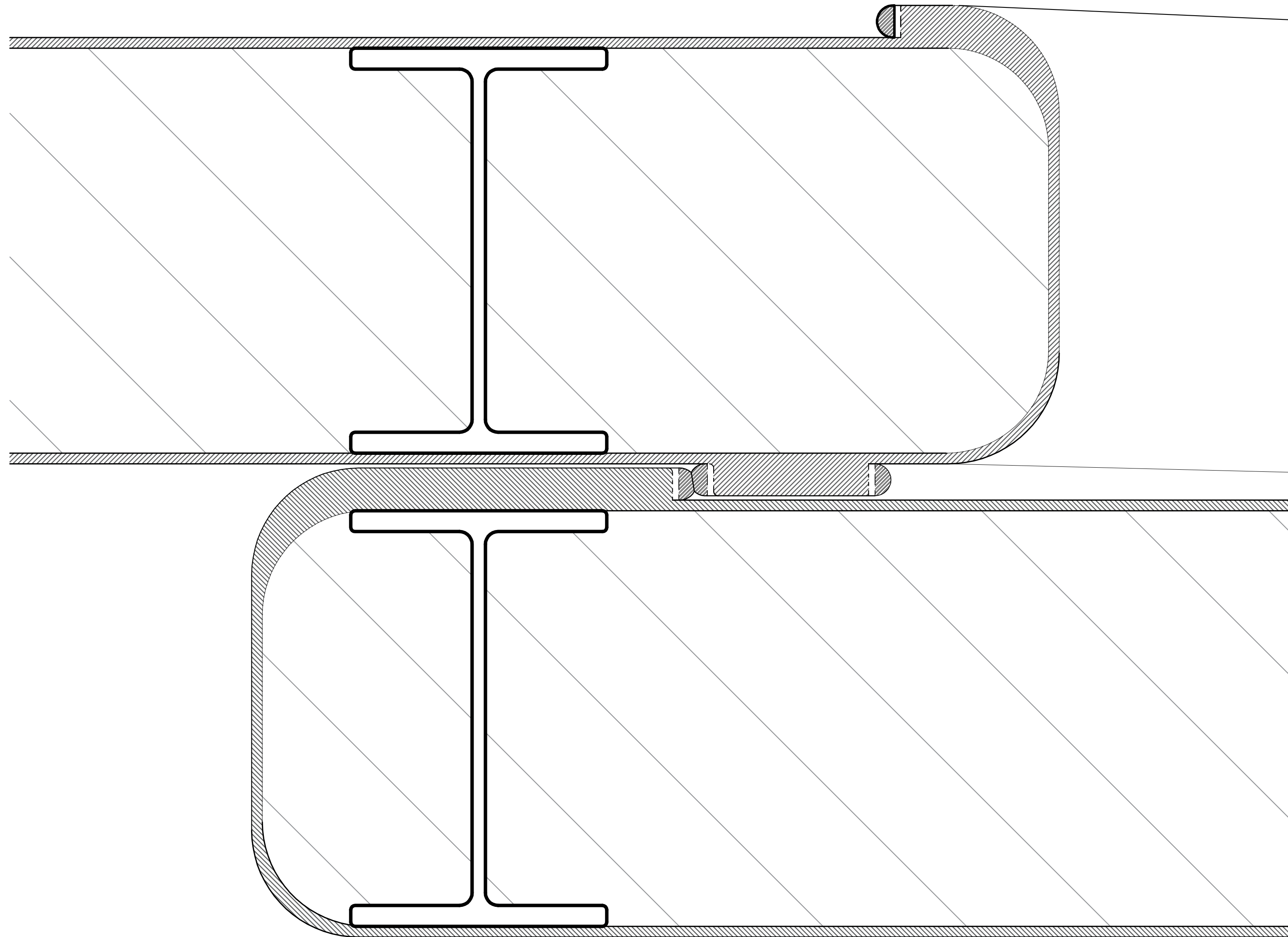

Details

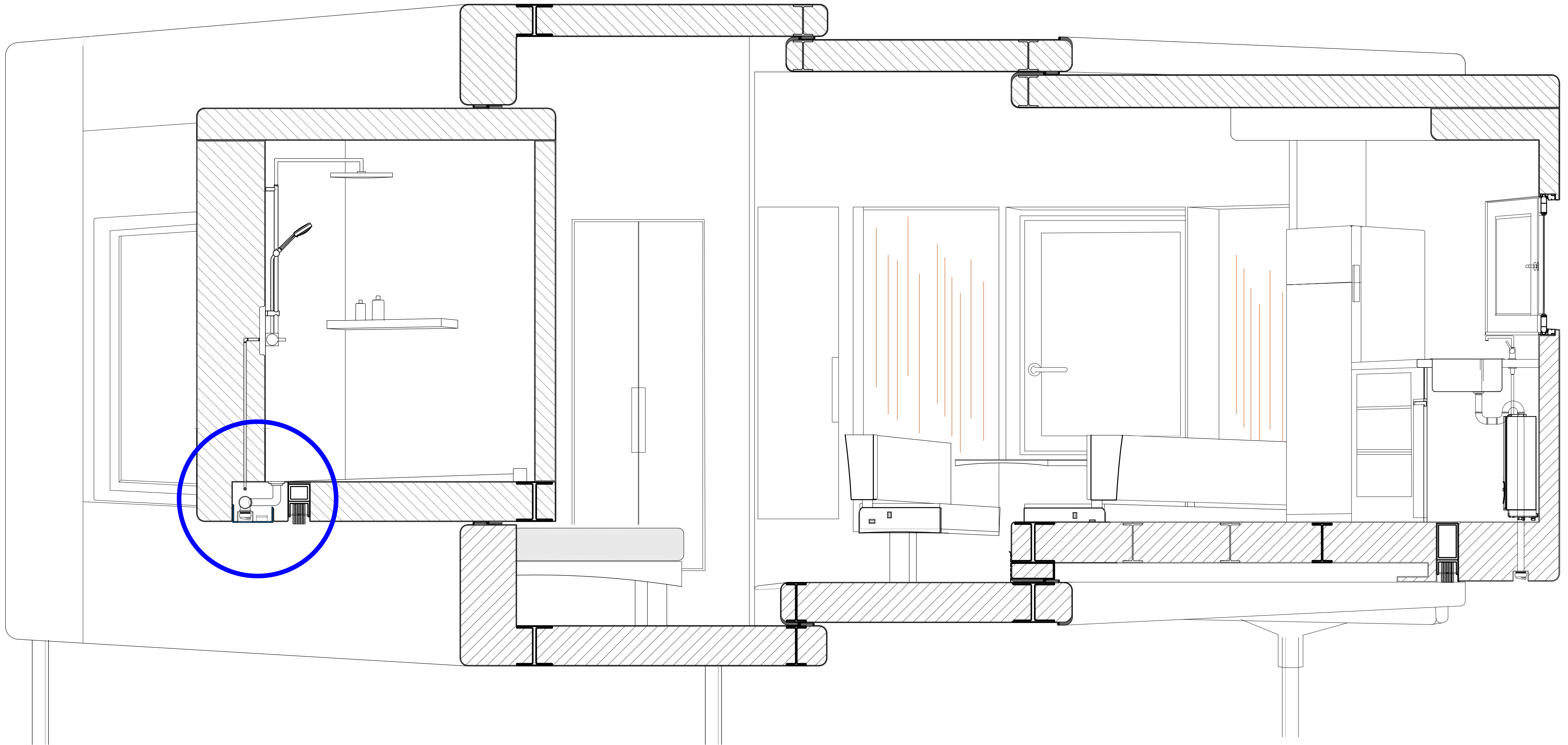

Details

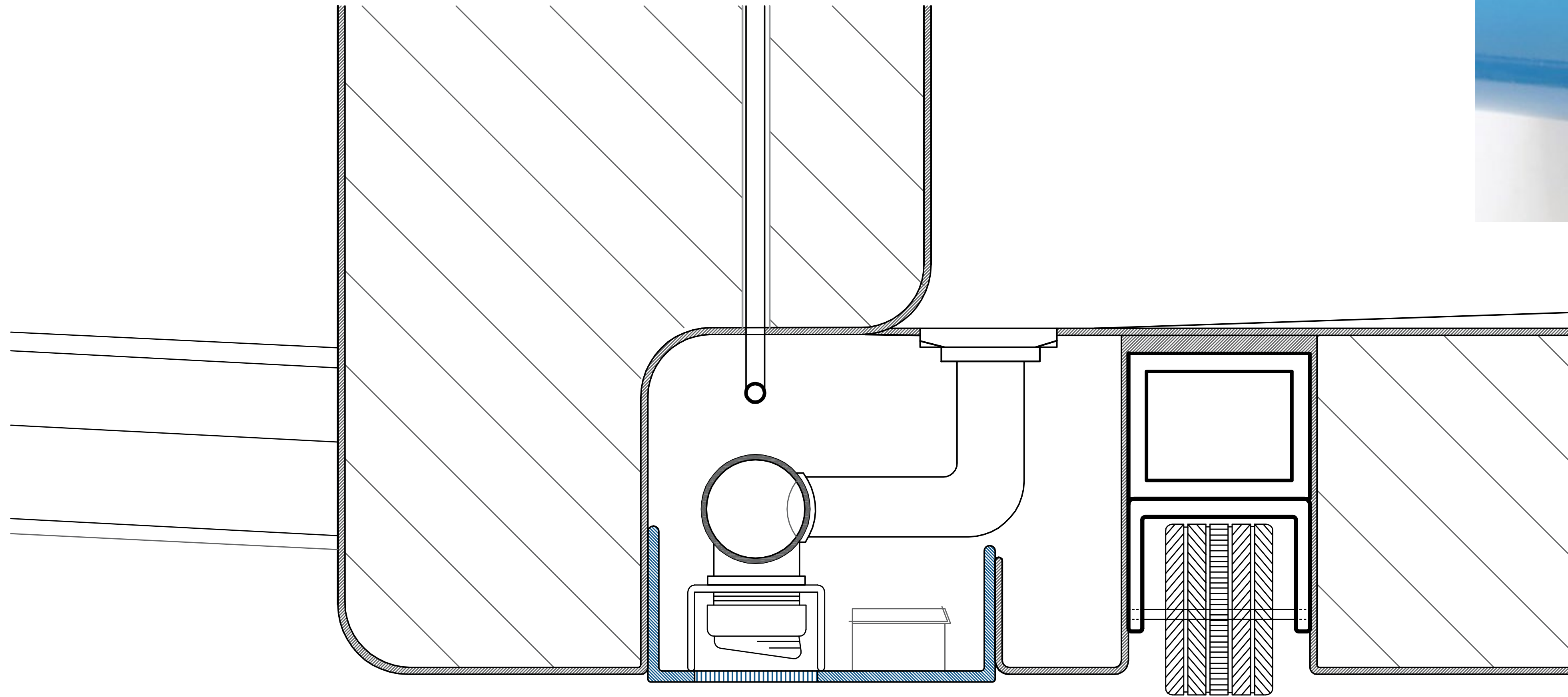
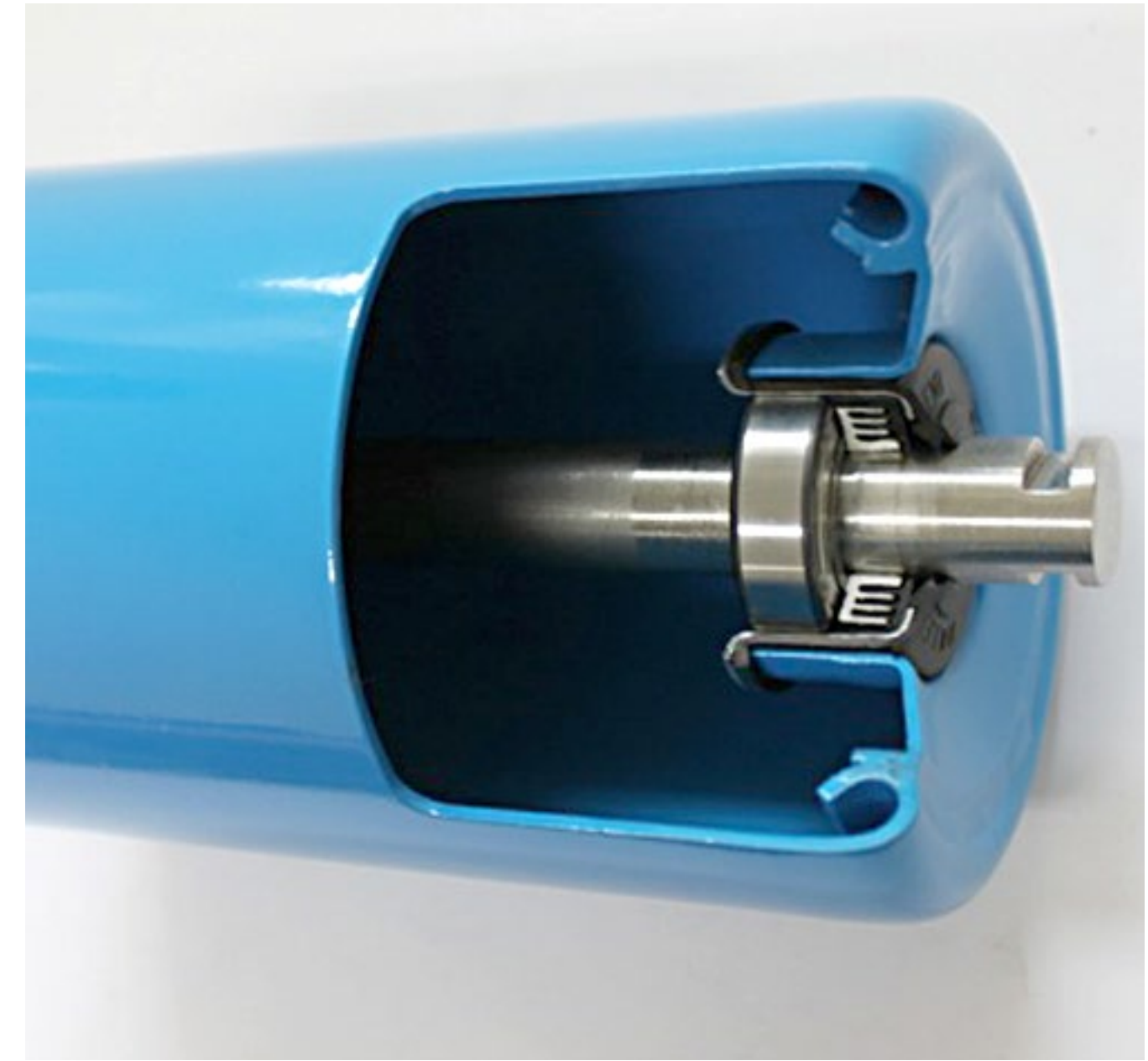

Details

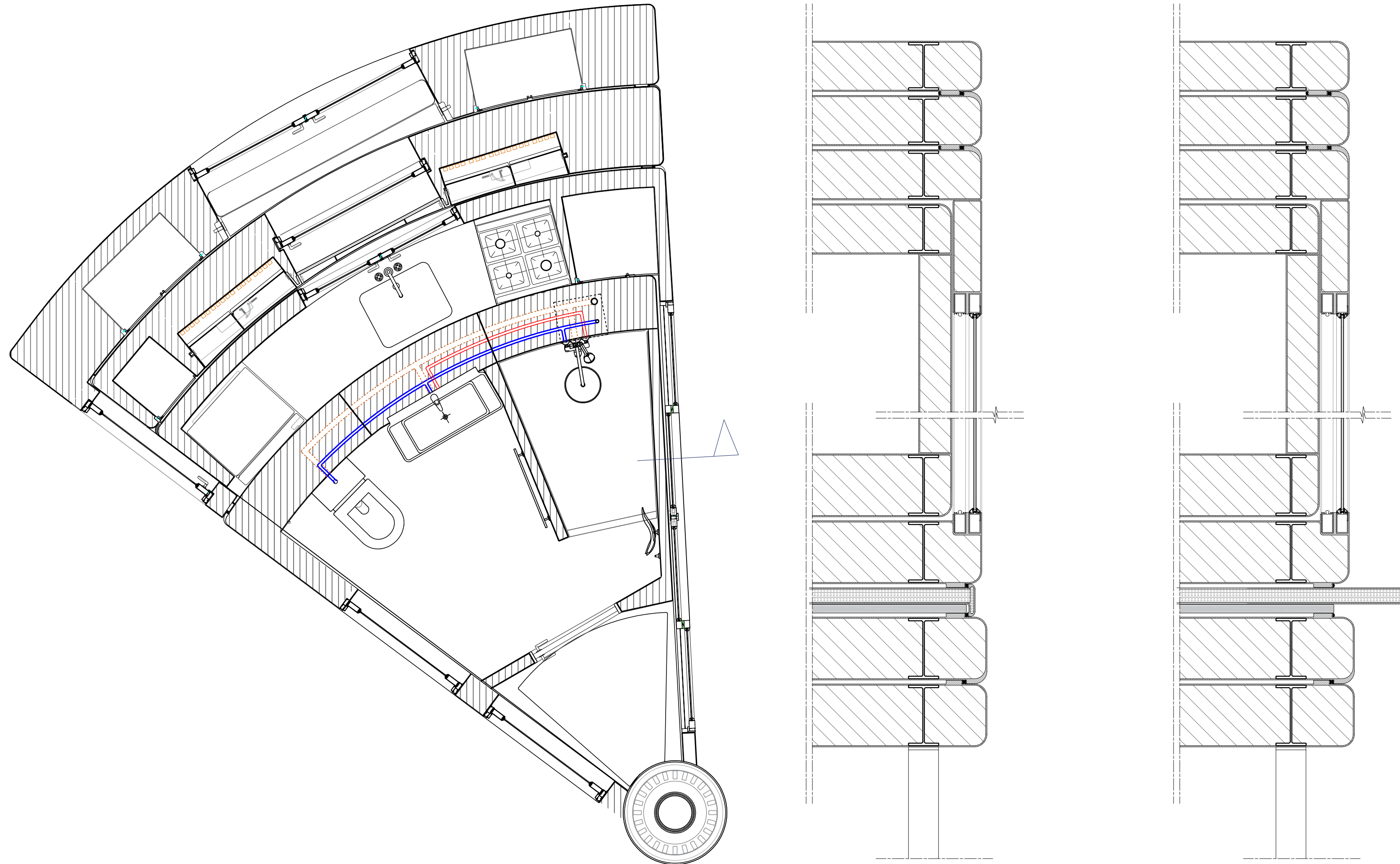



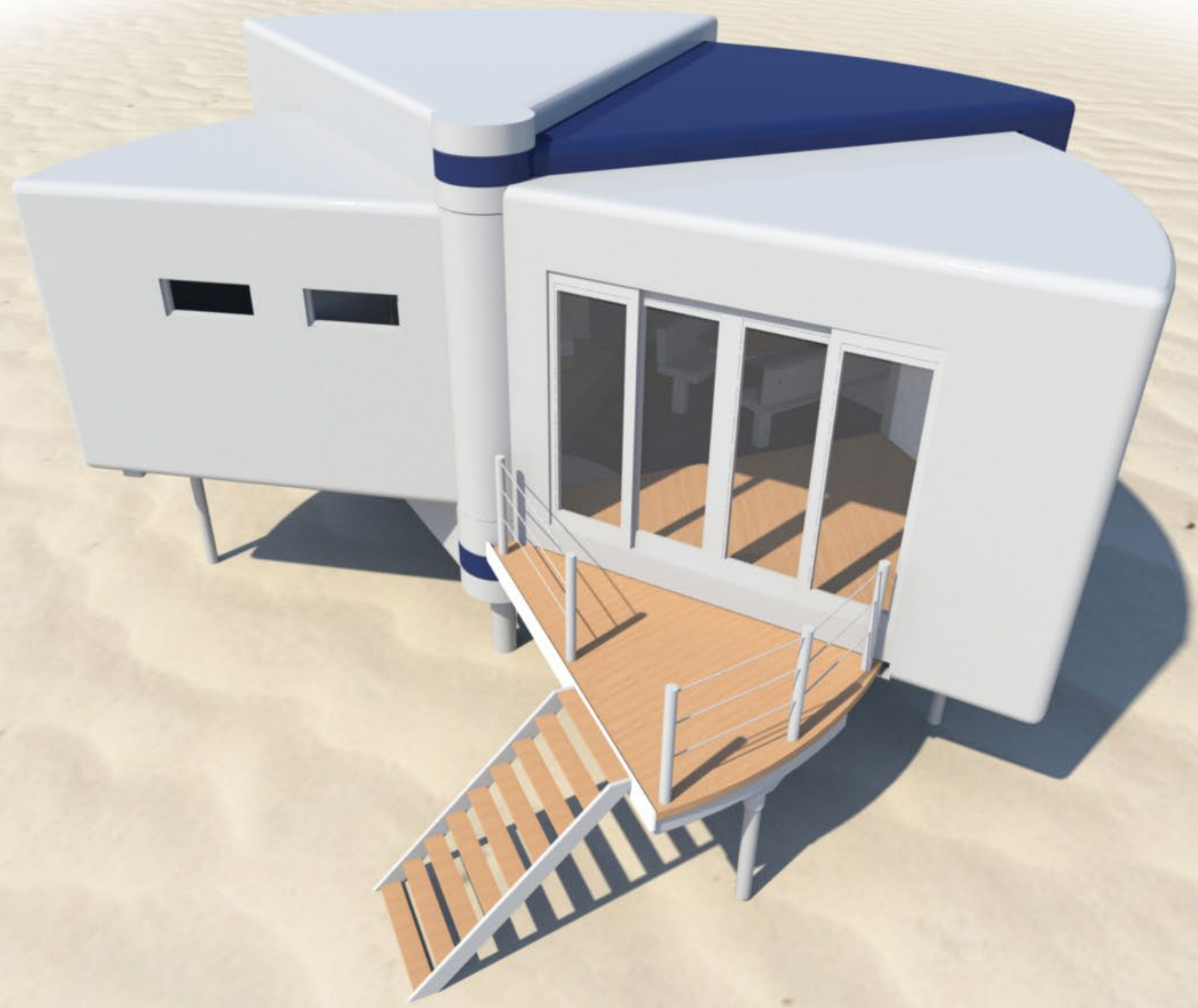

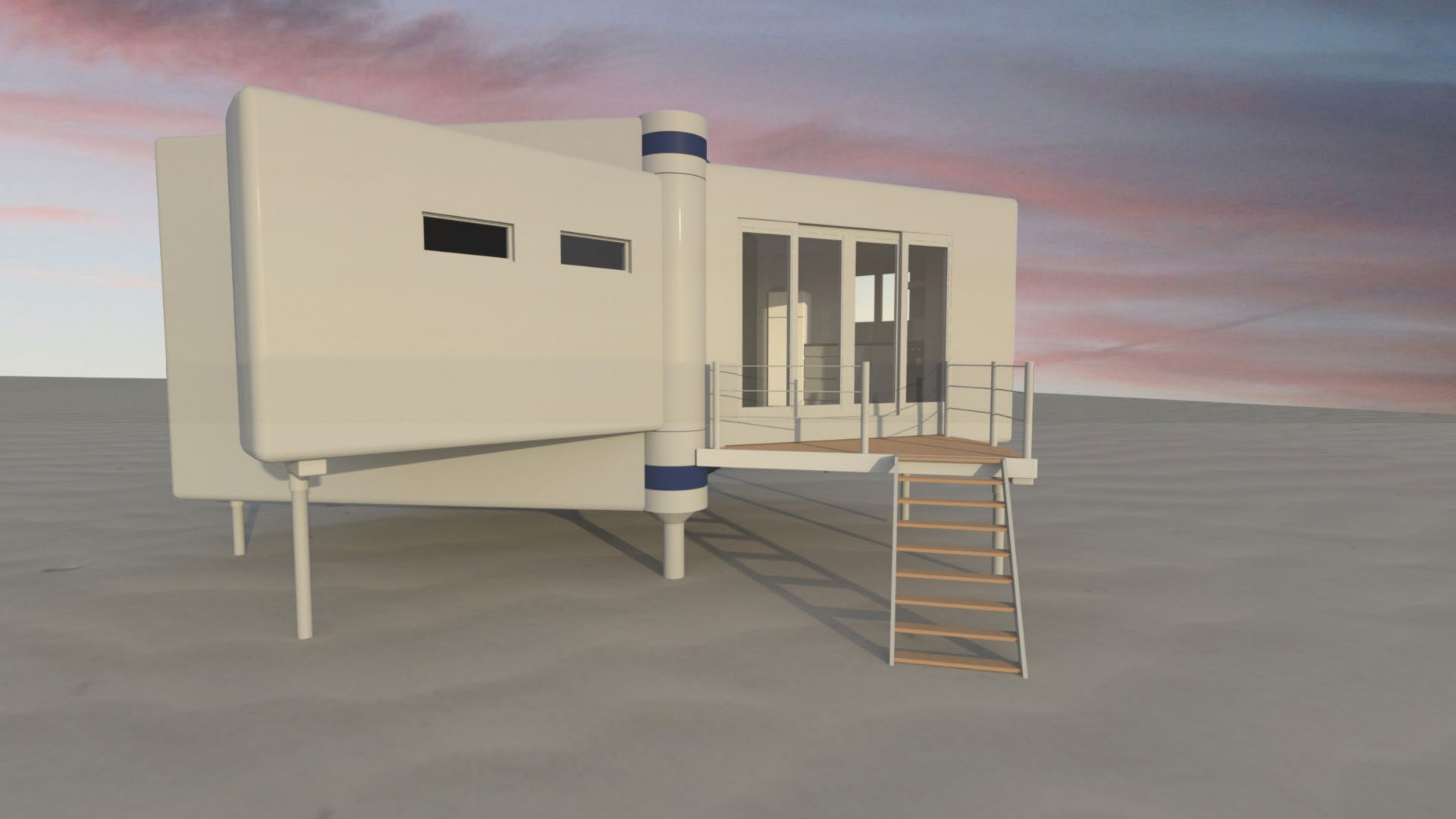



Interne Structuur

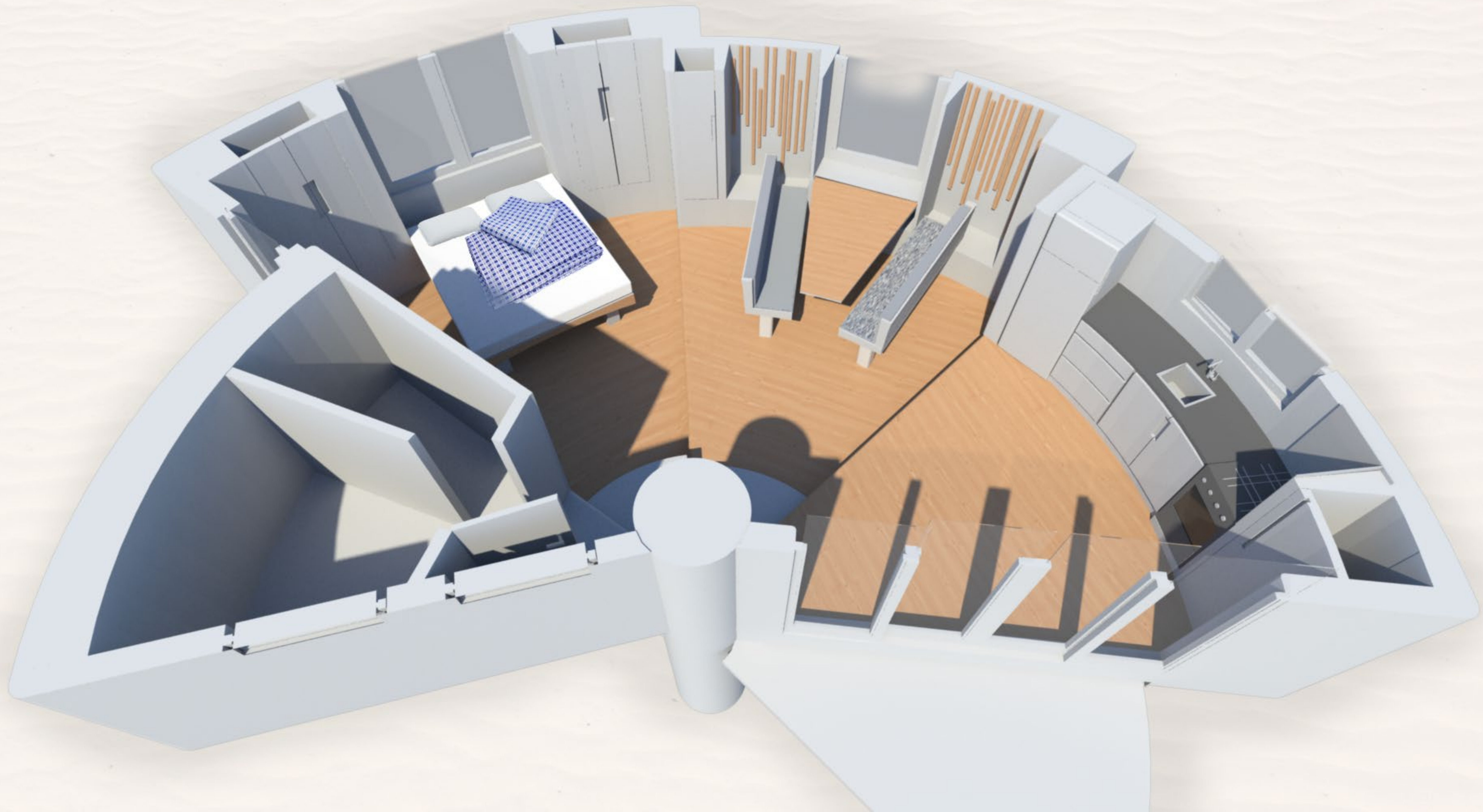

Interne Transformatie Slaapkamer + Woonkamer

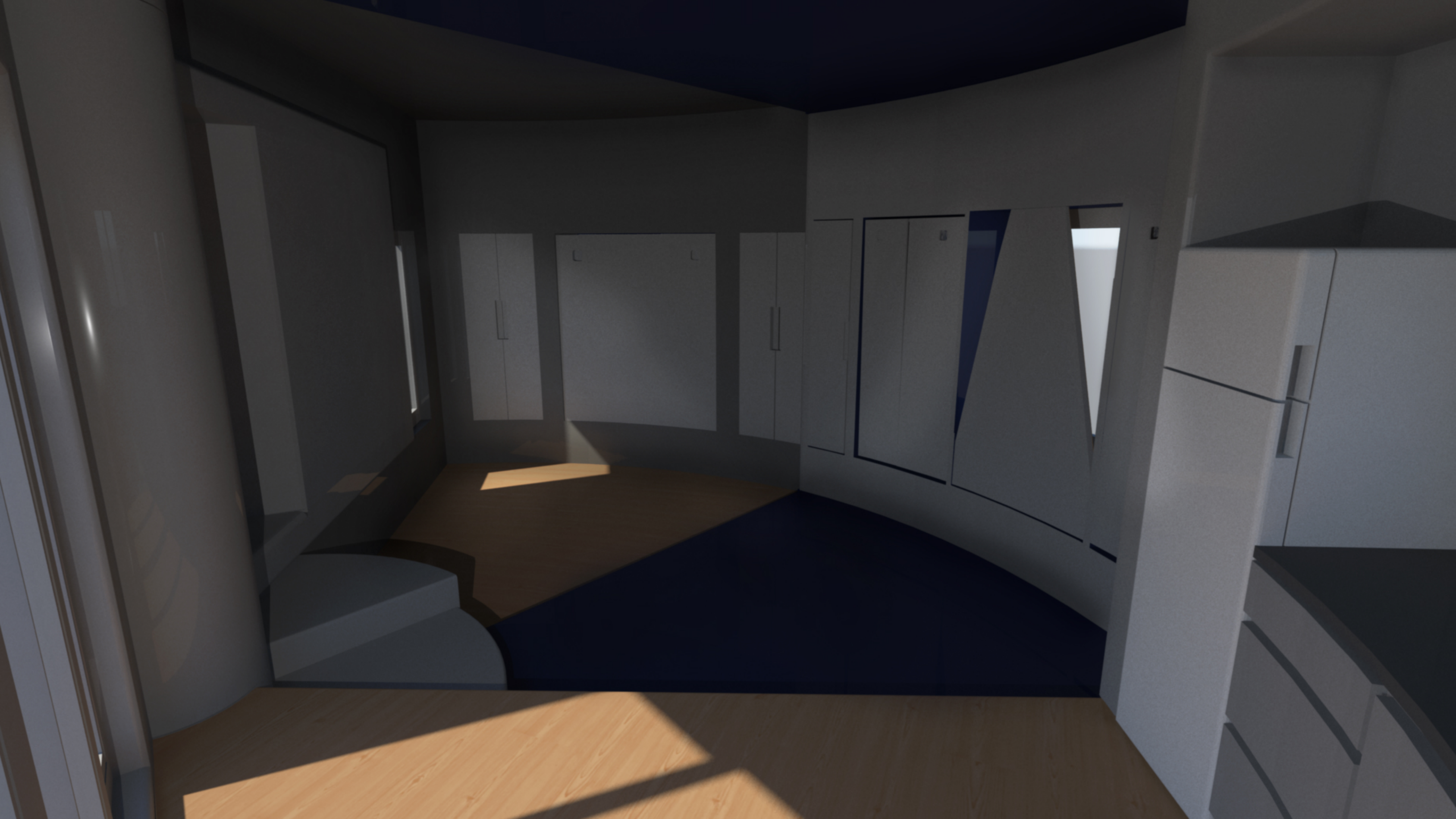

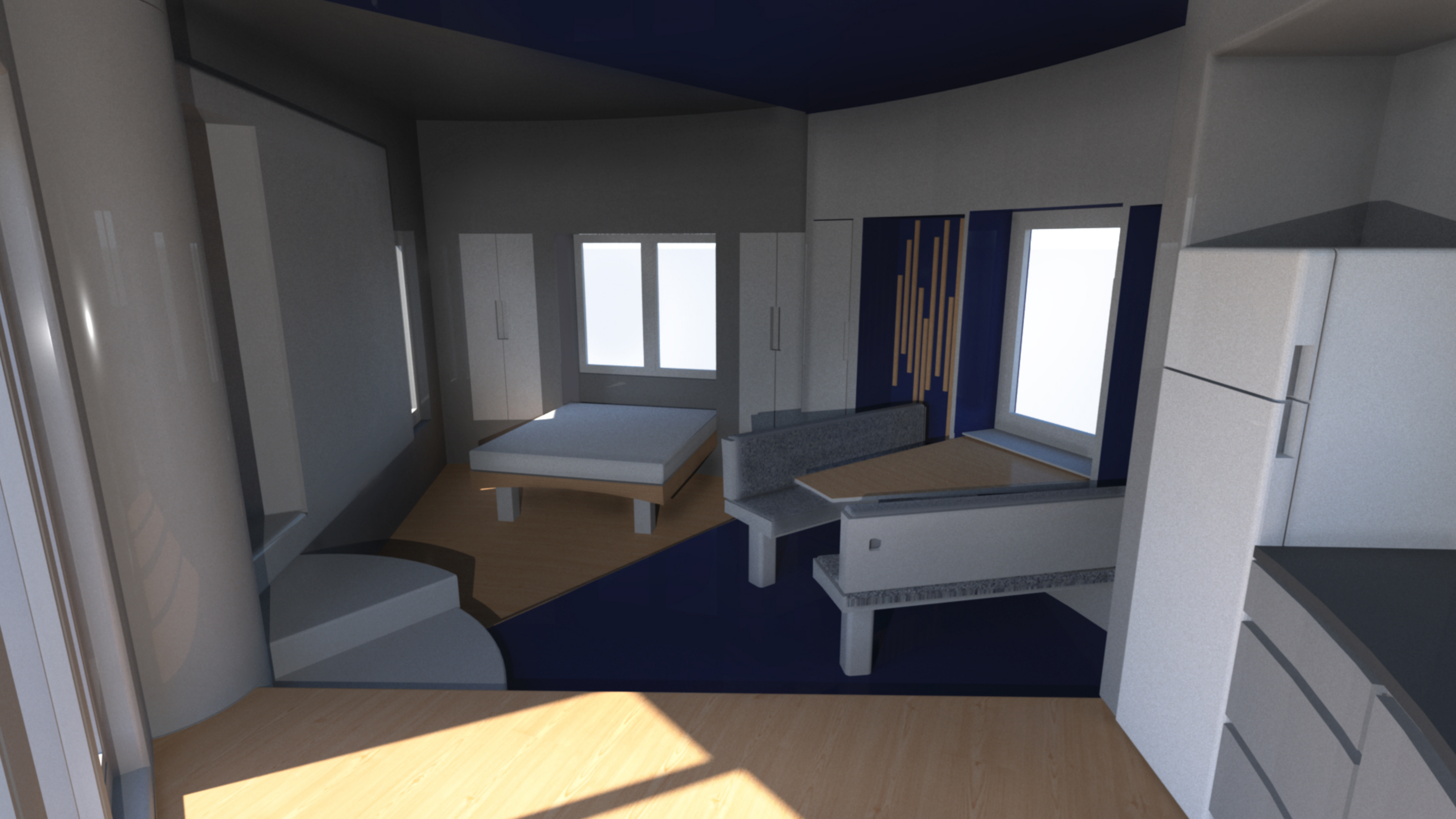

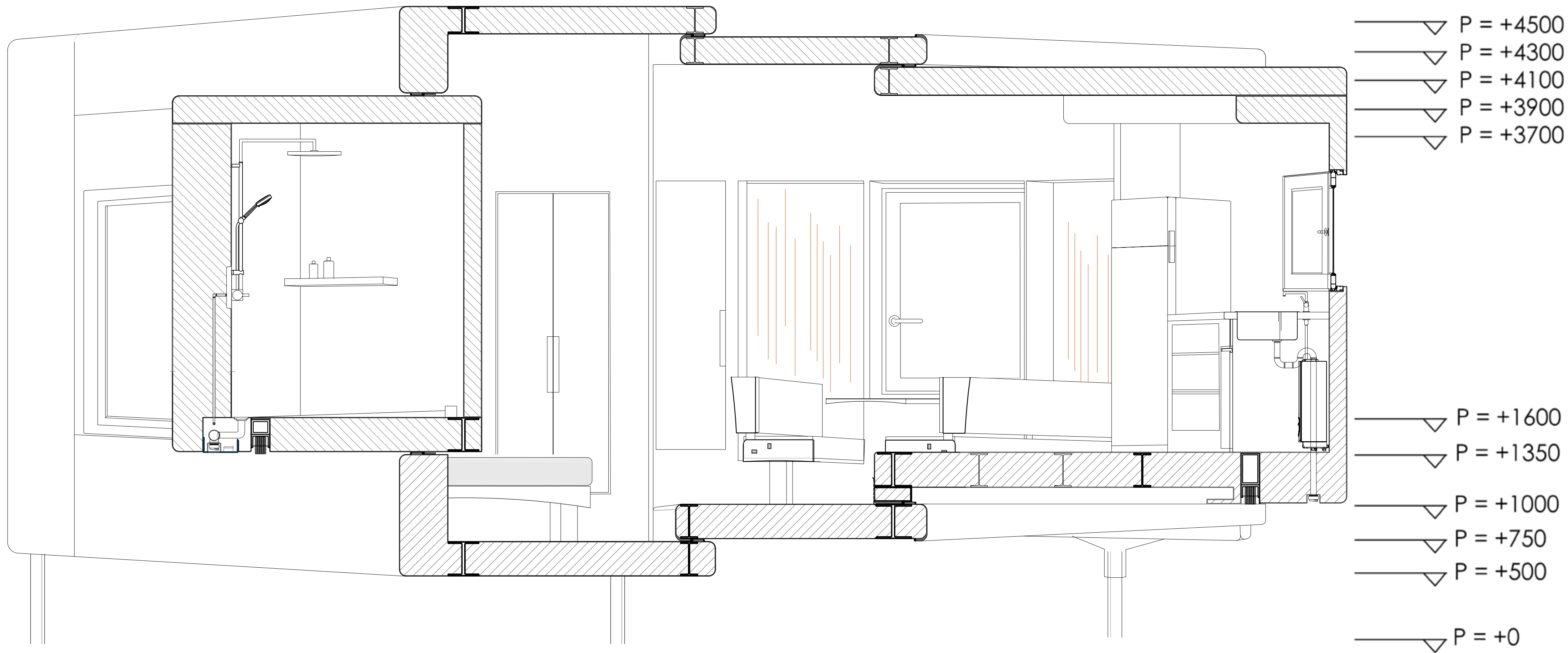

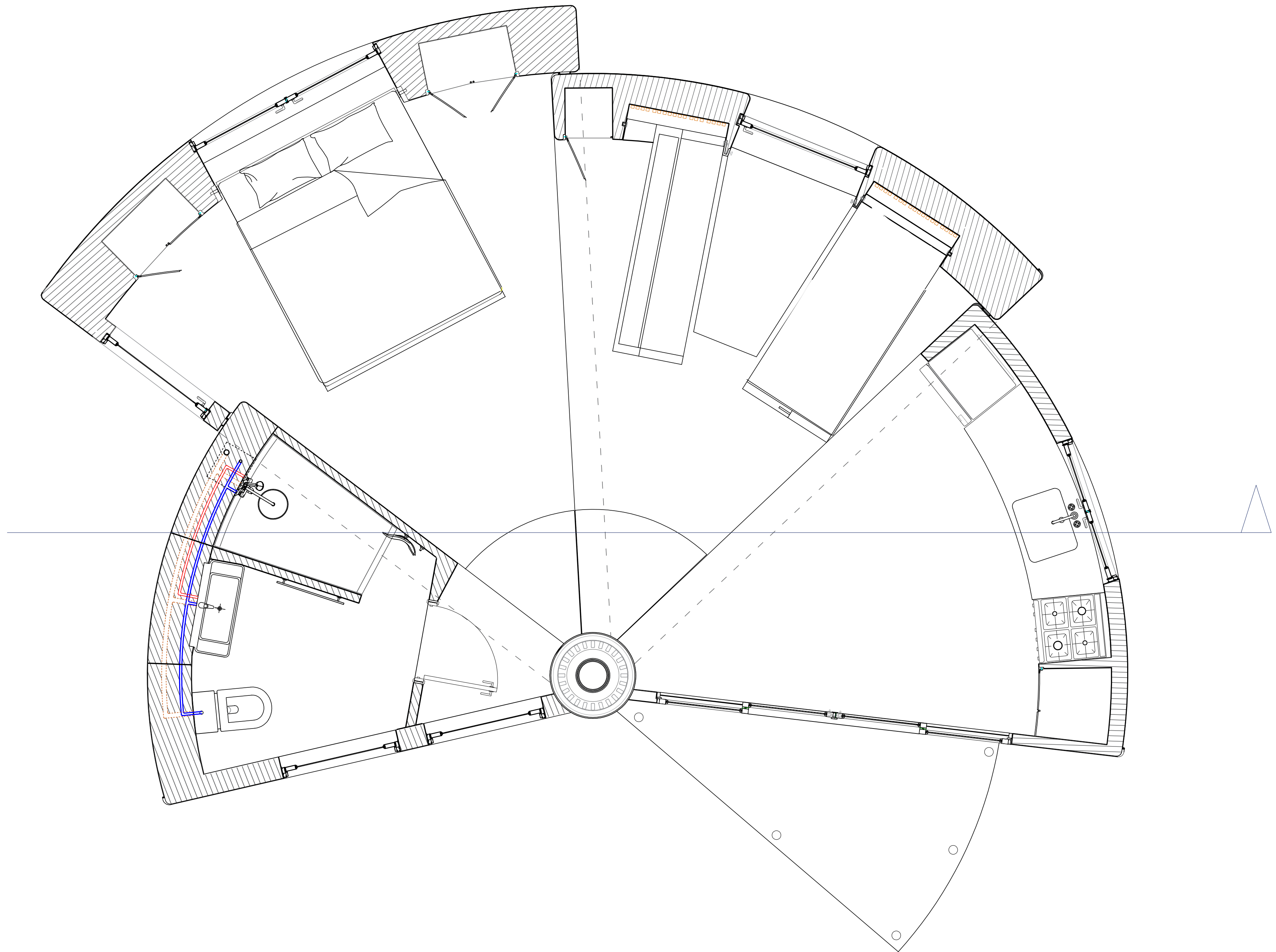



Interne Transformatie Woonkamer

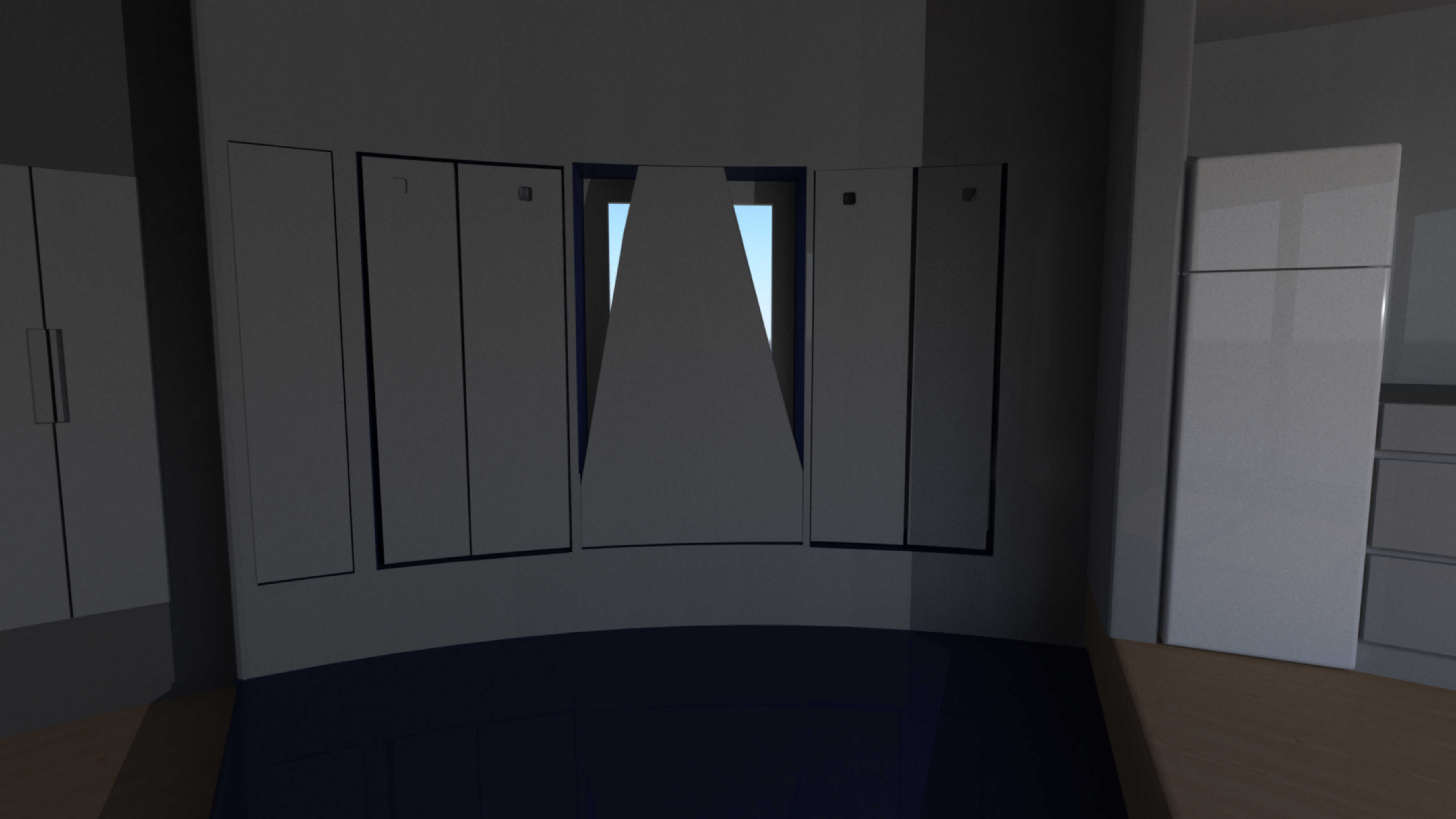

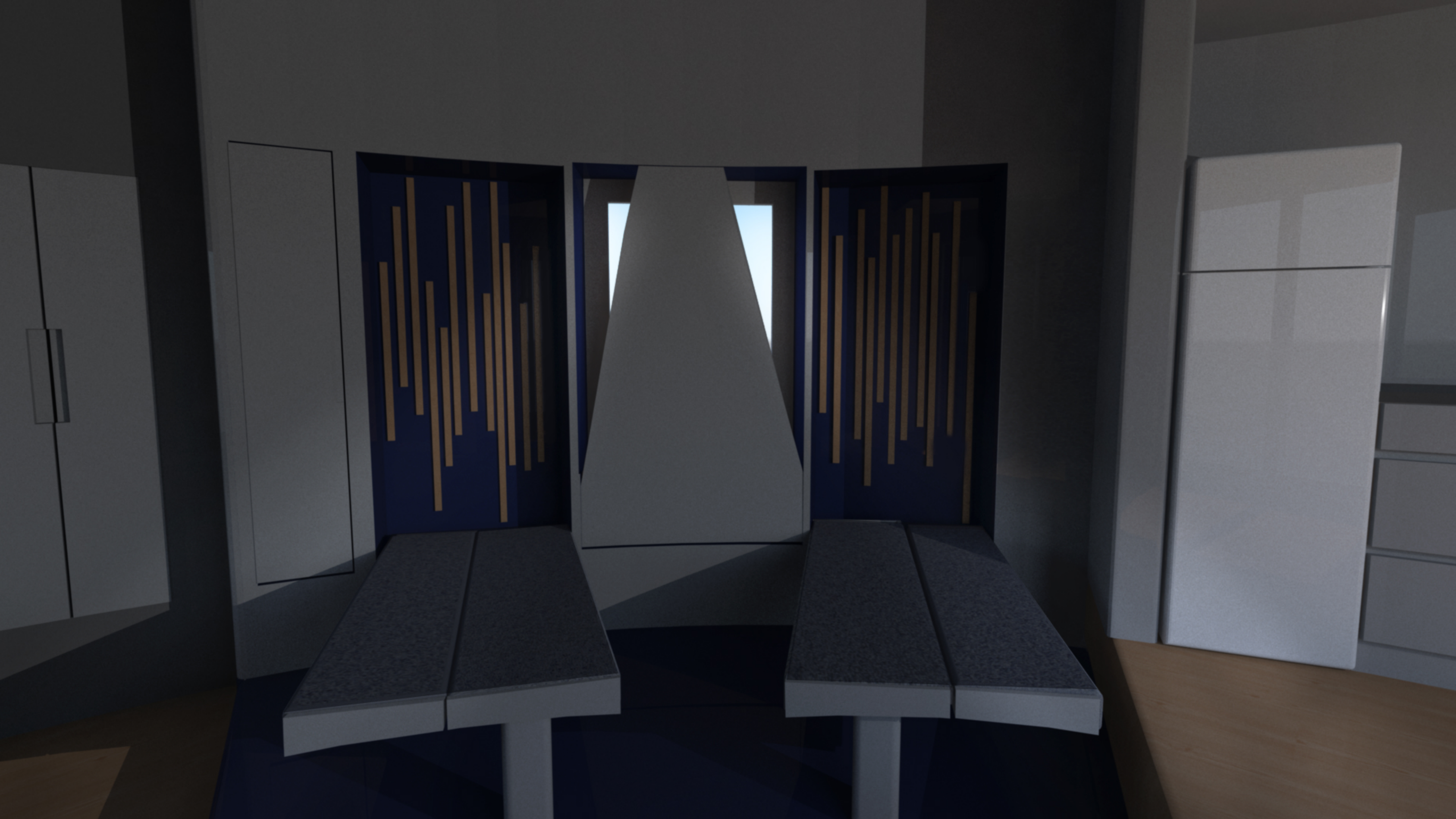



Bank/Bed

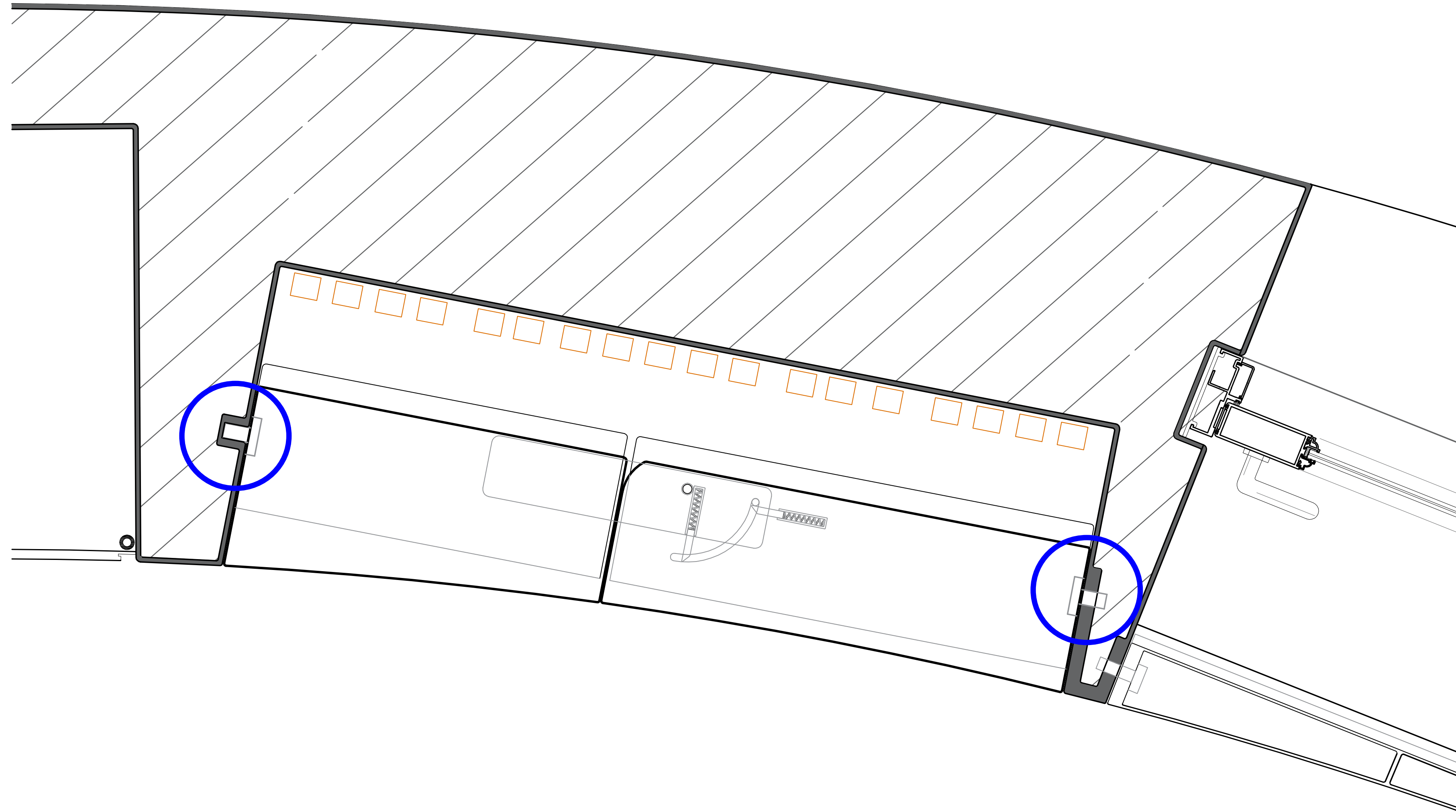

Bank/Bed

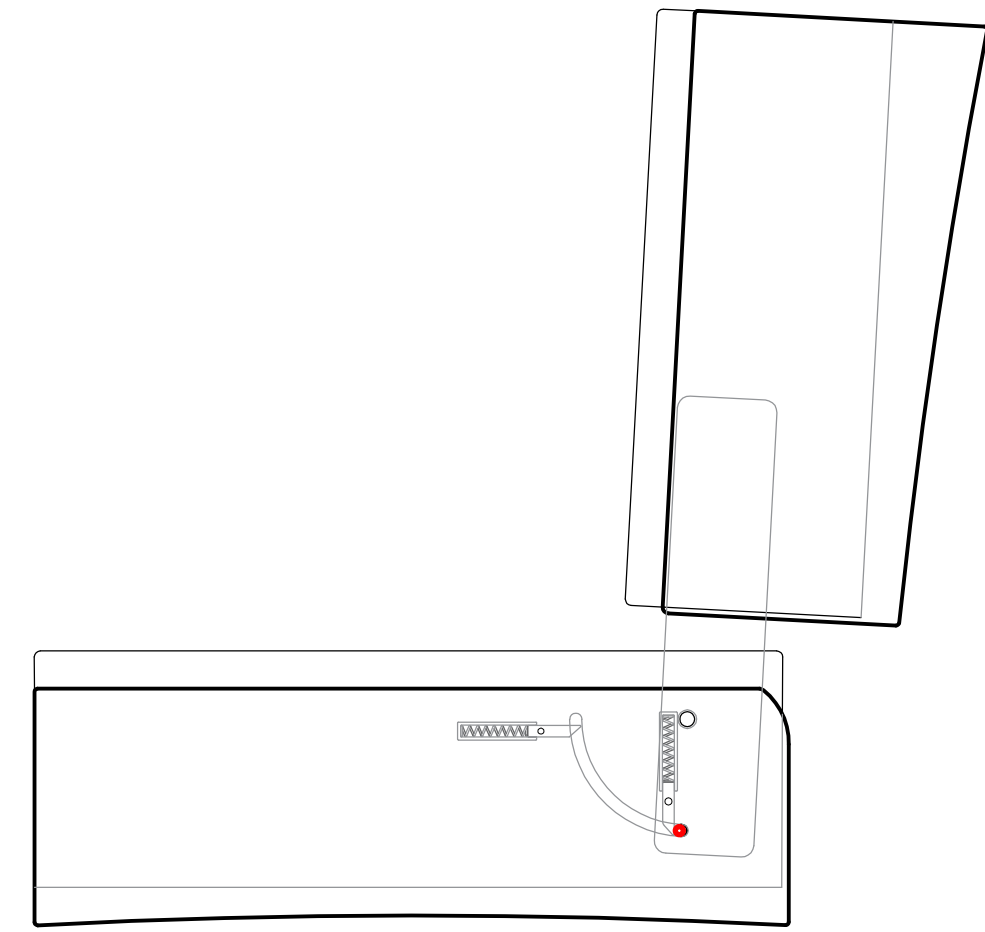
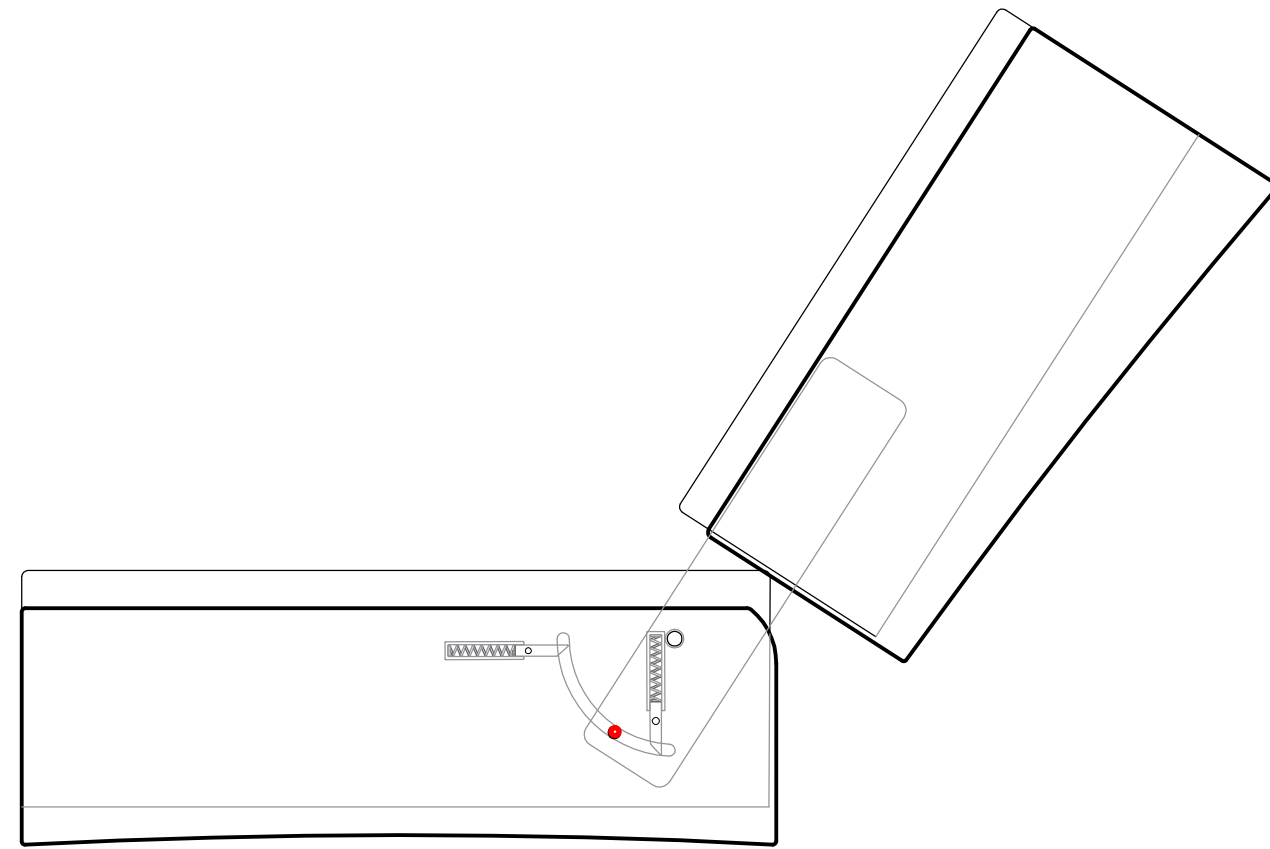
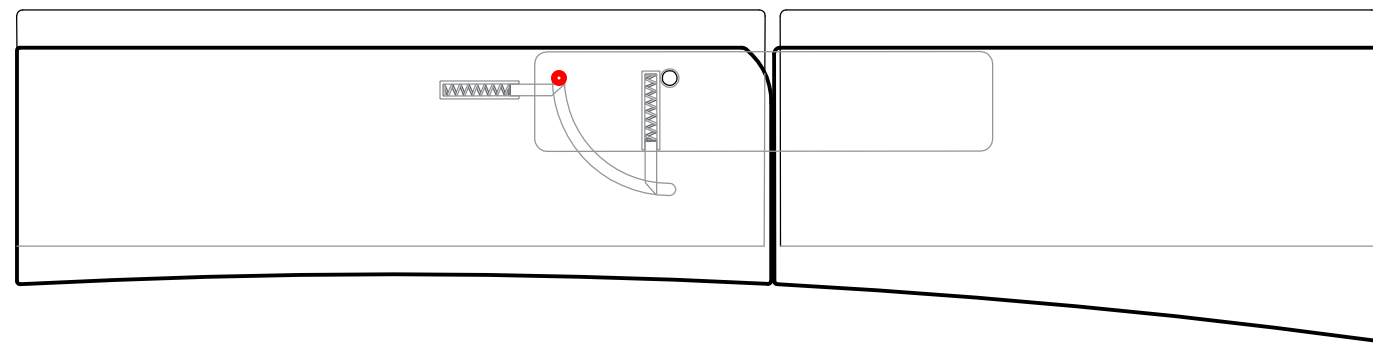



Tafel inklappen

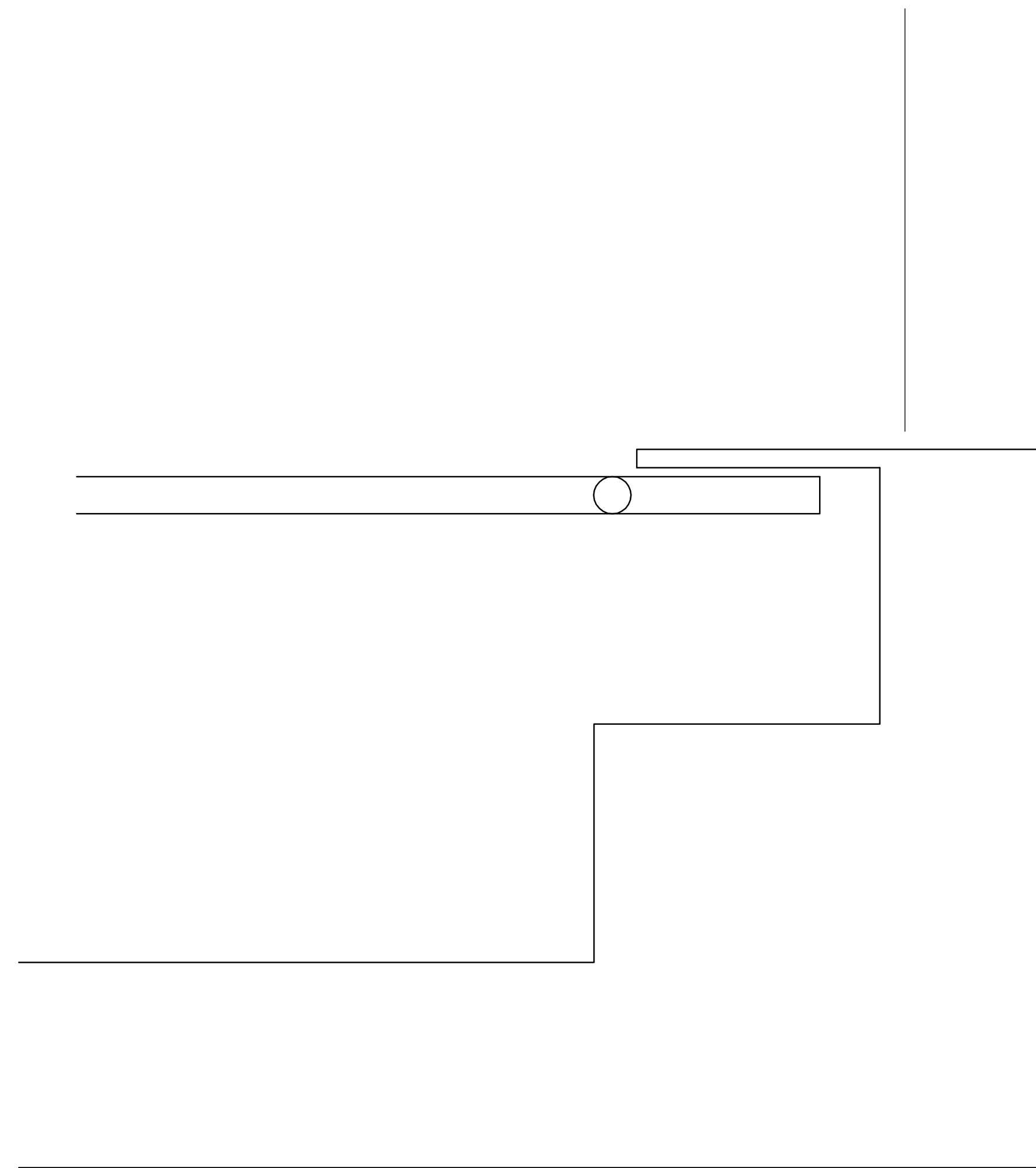
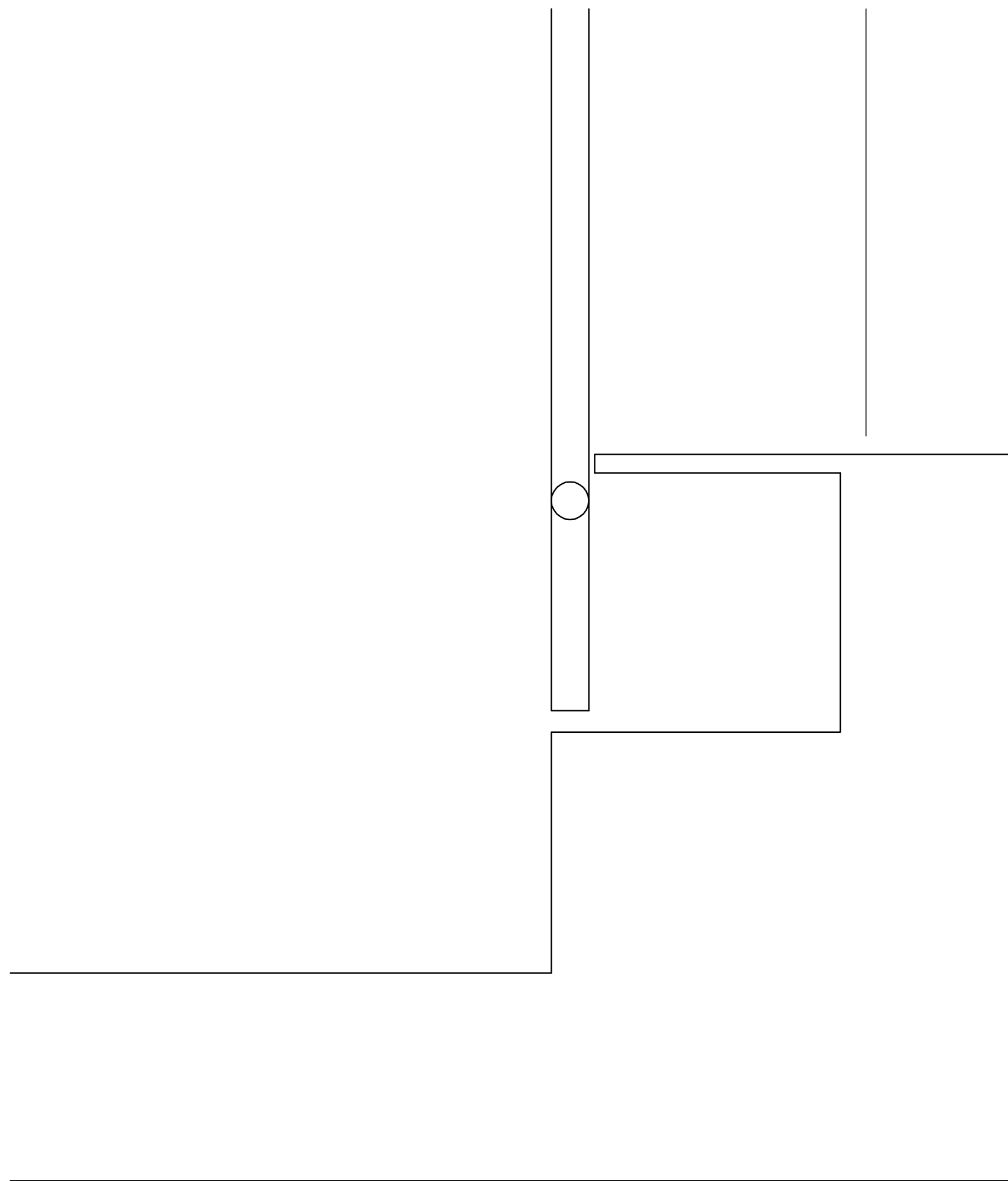

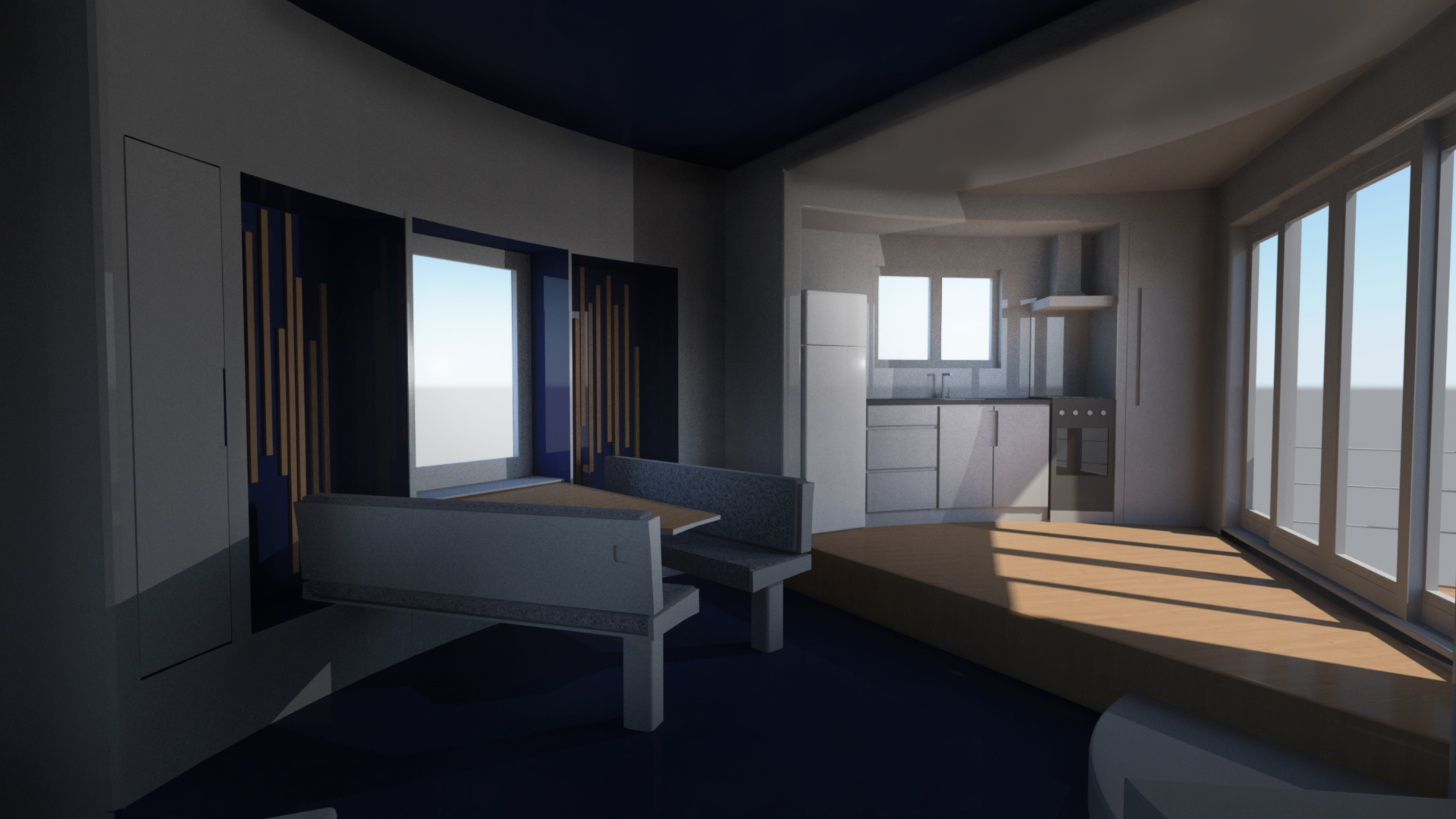

Elektricititeit

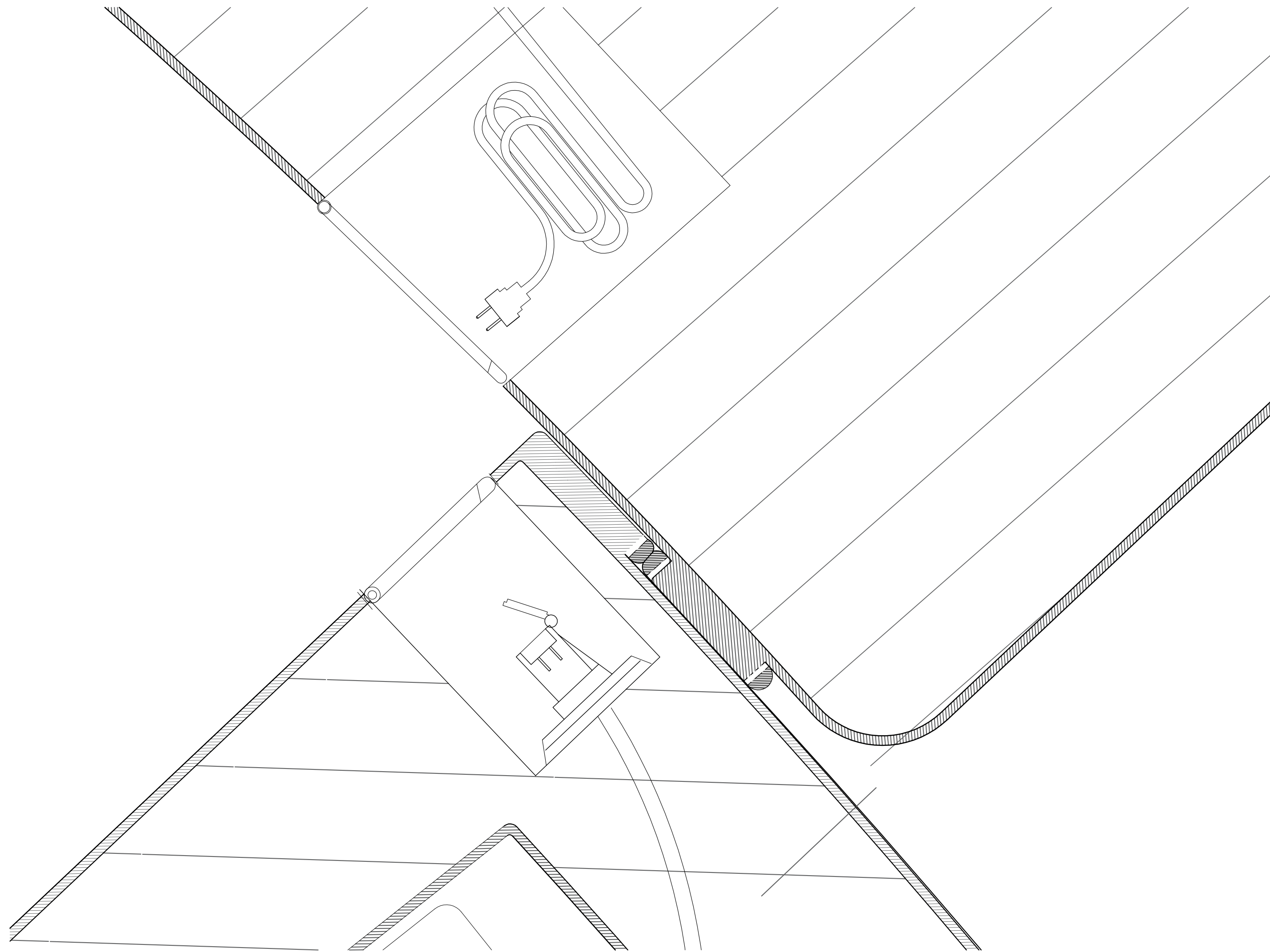

Conclusie

Conclusie

Kinetisch ontwerpen toegepast op meerdere niveaus

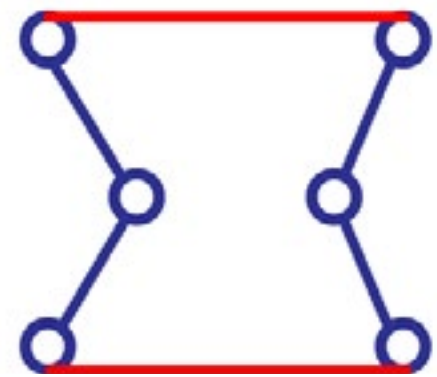

Embedded
Kinetic
Structure

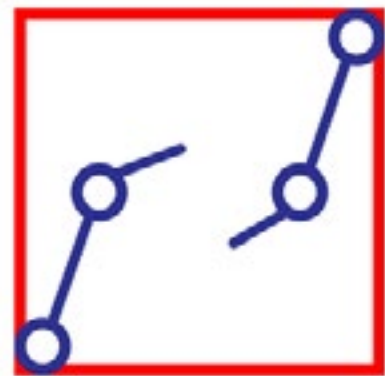

Dynamic
Kinetic
Structure

Spatial
Optimization

Contextual
Adaptability

Conclusie

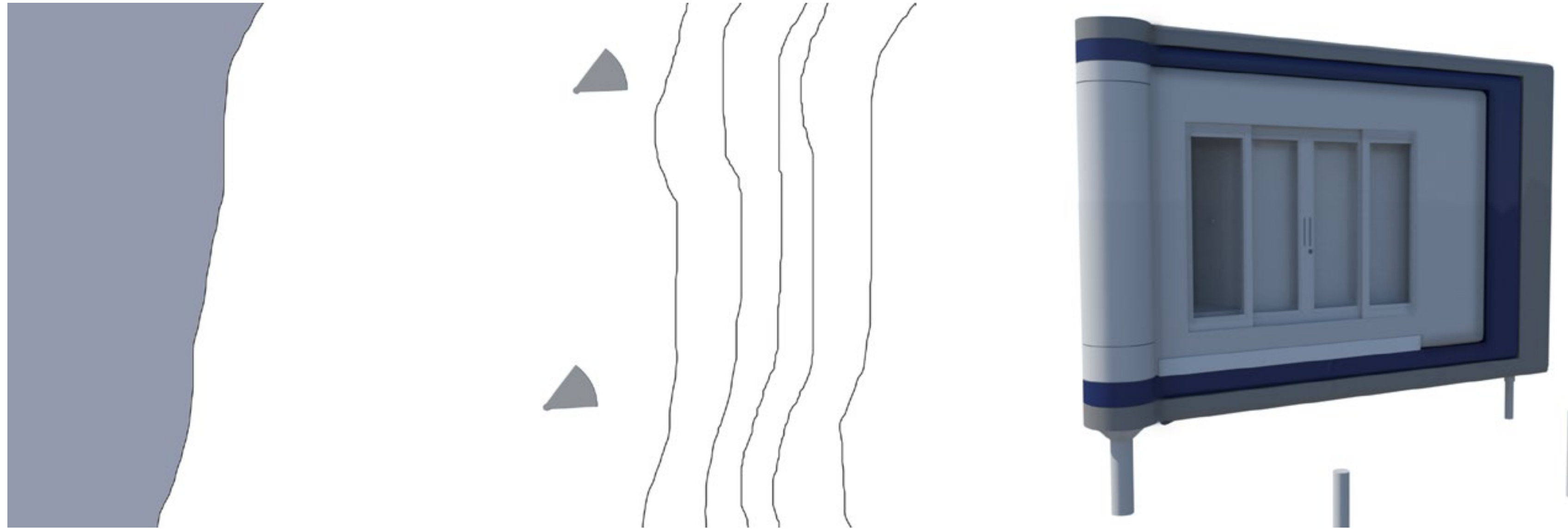

“Hoe kan kinetisch ontwerpen helpen om een strandhuis te maken dat minder schadelijk is voor de duinen en verder minder kosten met zich meebrengt?”



Vragen?