











..LIKE NO VACATION ON EARTH.....LIKE

..LIKE NO VACATION ON EARTH.....LIKE



hair.spray





PURVEYORS OF FINE LIQUORS

Quill & Compass

The Roadmap Towards Circular Cruise Ships

Preventing waste discharge into the environment



Deirdre van Gameren
08-07-2020



Seastainability

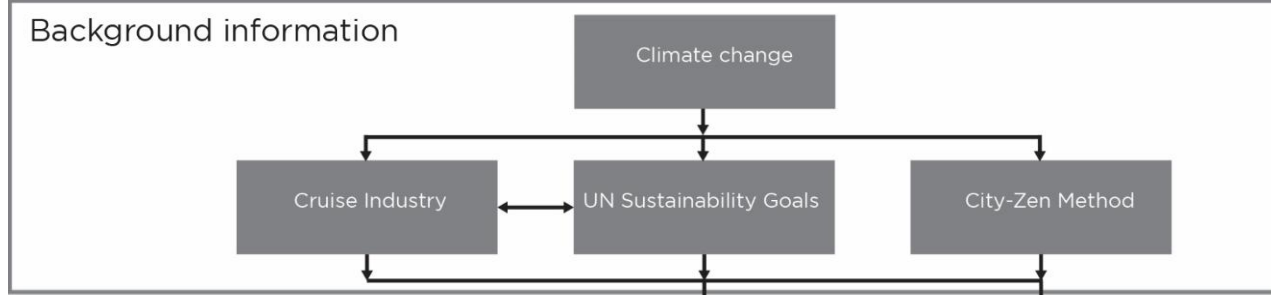

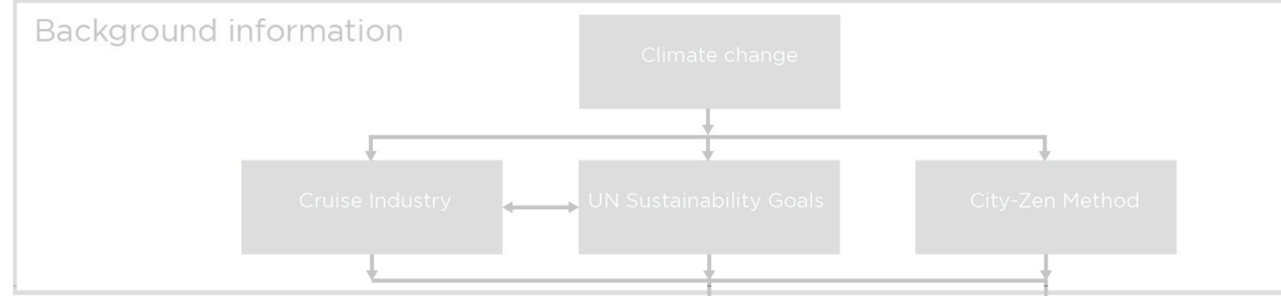

Research Framework

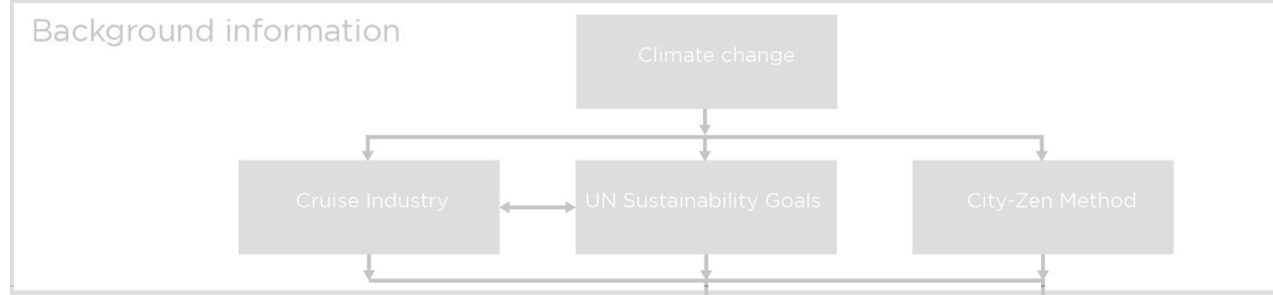

Research Framework

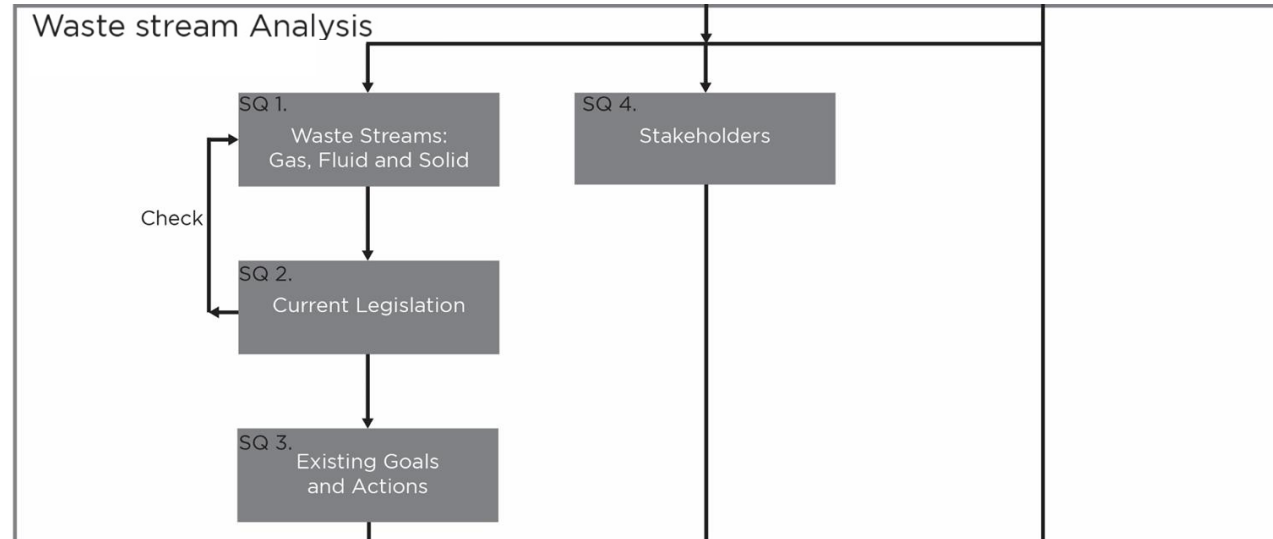

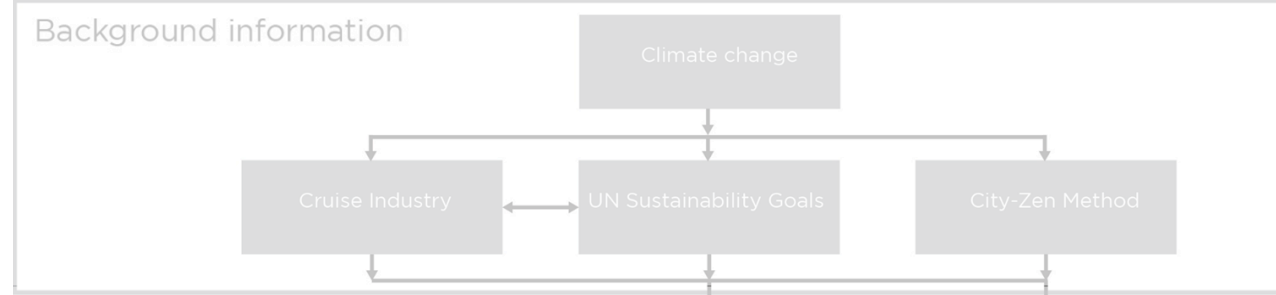

Research Framework

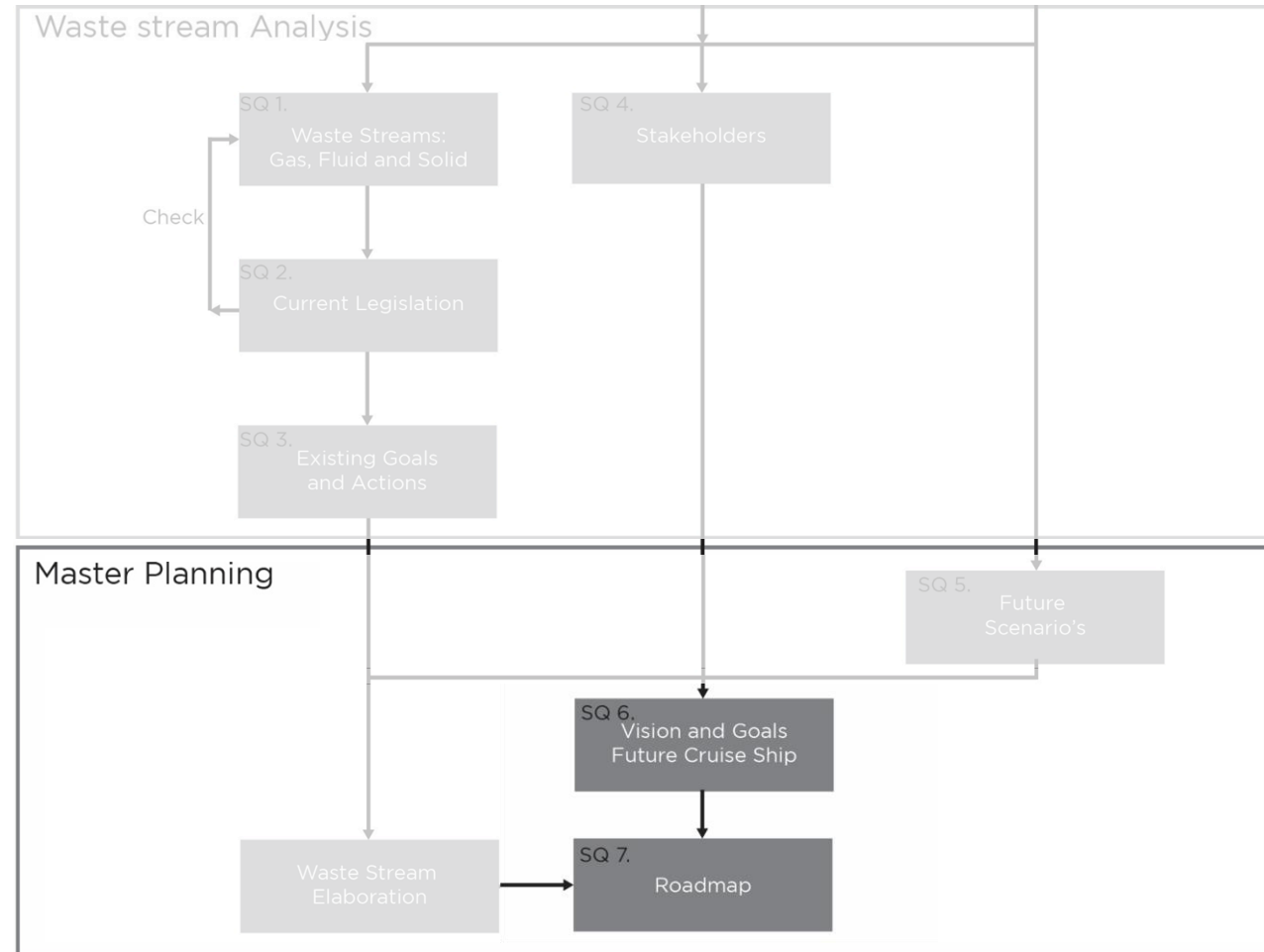

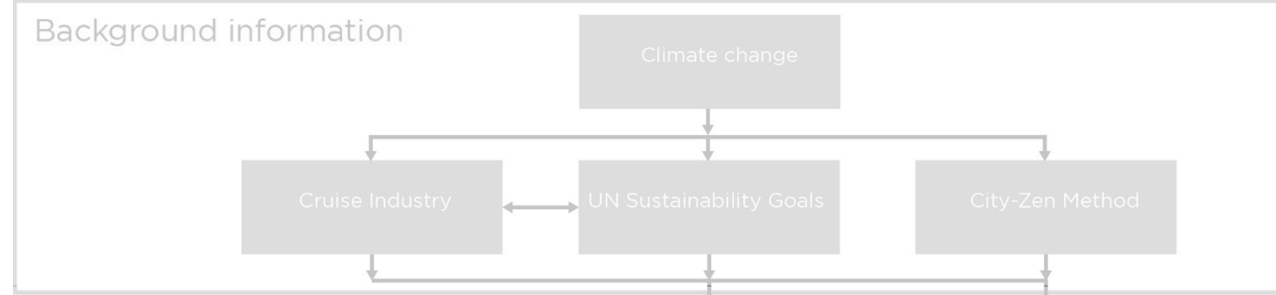

Research Framework

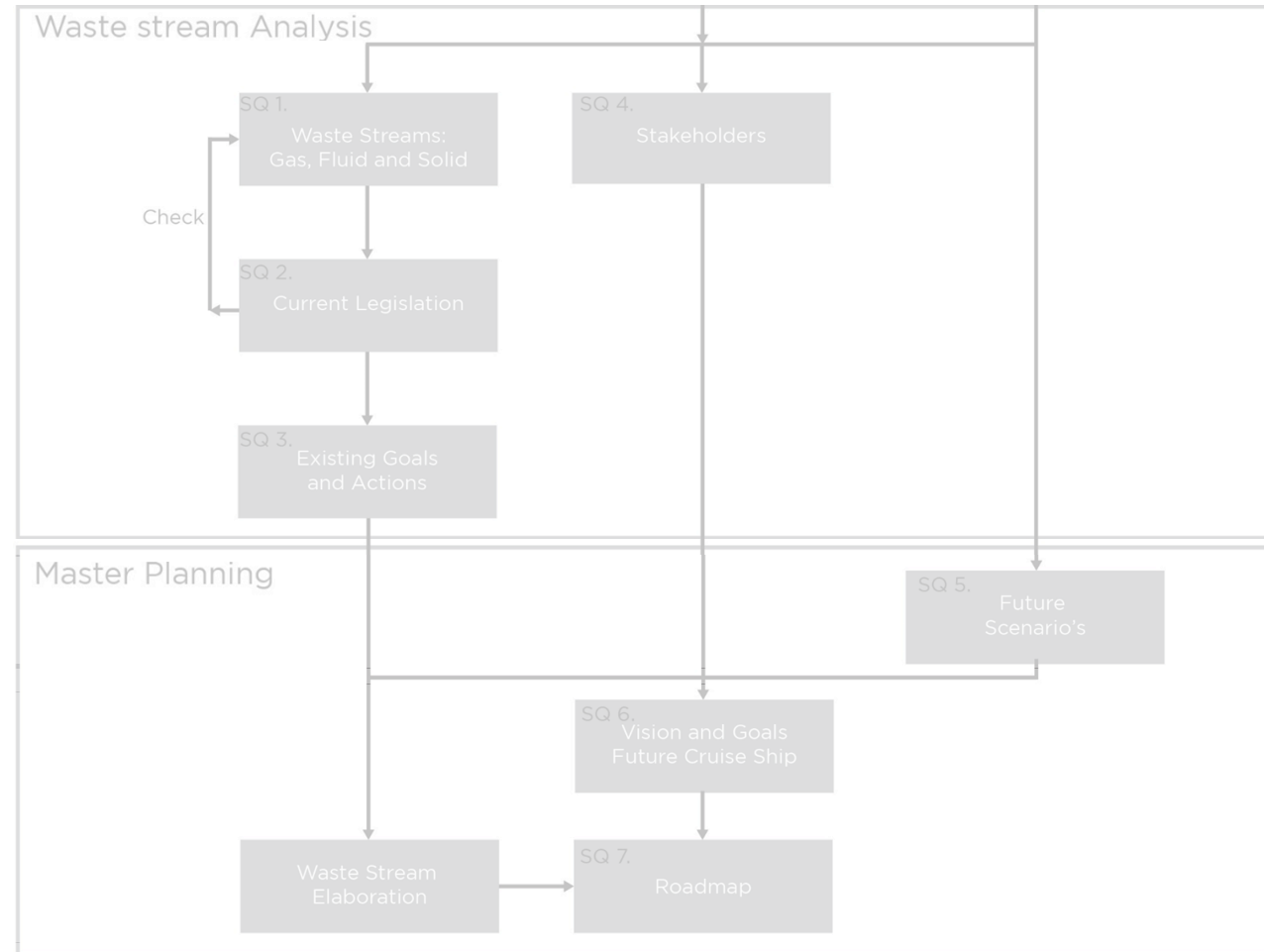

Possible Future Cruise Ship







314



30 Million

Royal Caribbean, (n.d.)



5500 + 2000

Hof Staff, (2017)

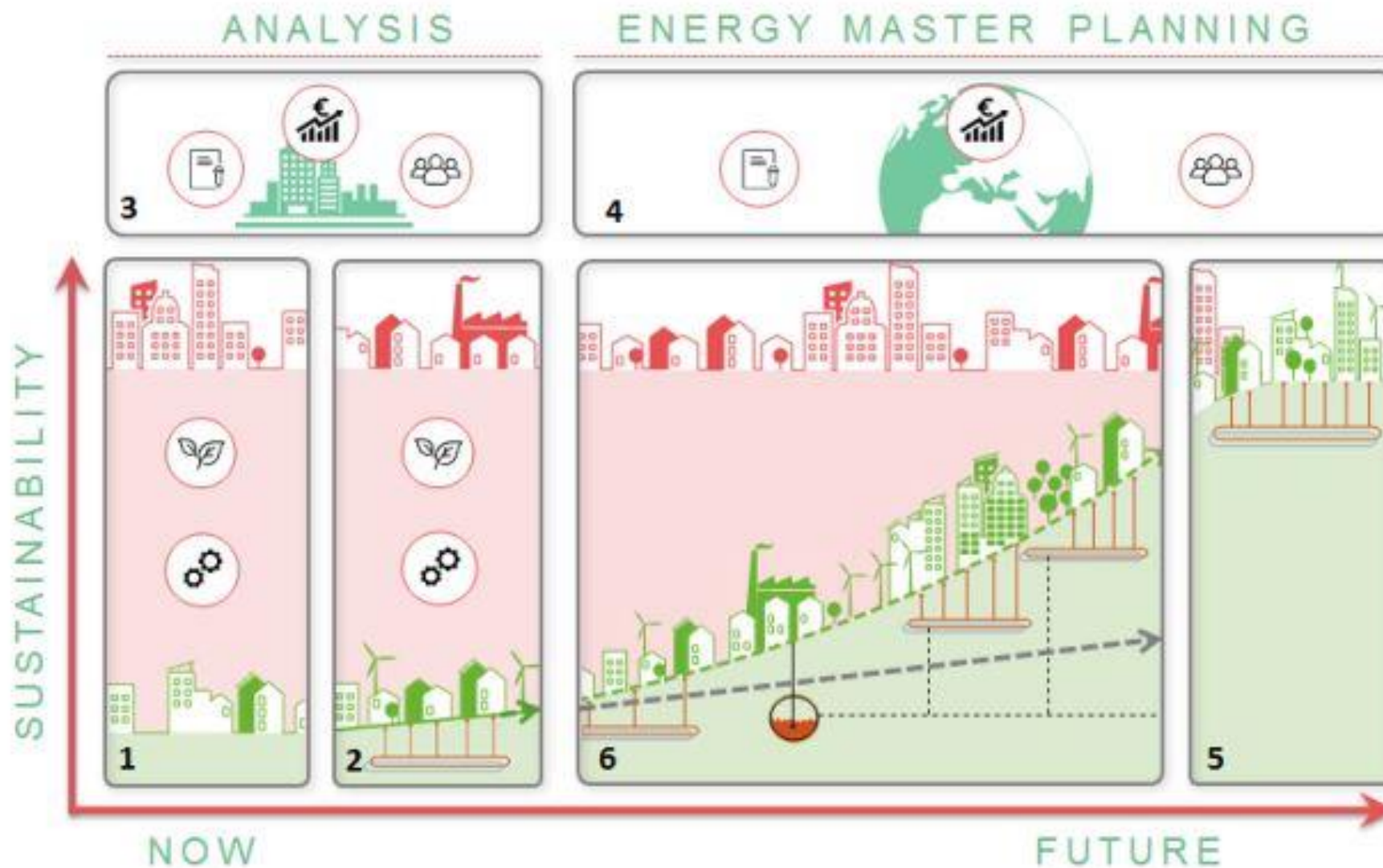
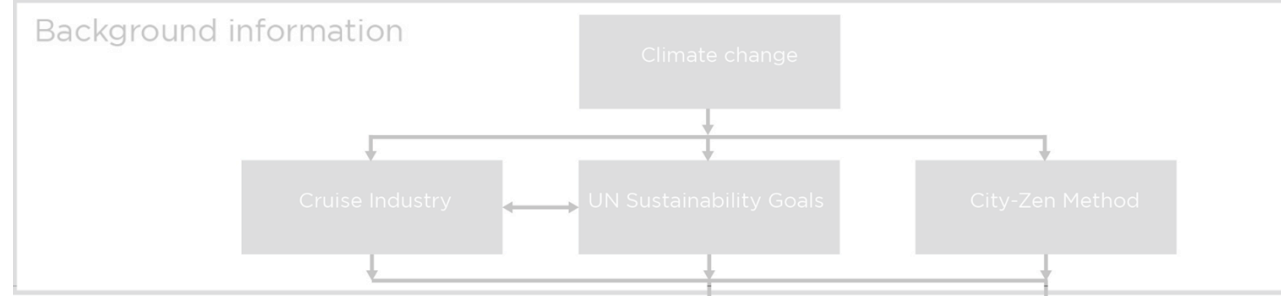

Figure 1: City-zen energy transition methodology.

ANALYSIS: Step 1: Basic energy analysis, Step 2: Present planning and trends, Step 3: Stakeholder analysis.

ENERGY MASTER PLANNING: Step 4: Scenario for the future, Step 5: Energy vision, Step 6: Roadmap.



Research Framework

“ Waste streams from cruise ships come back into nature which negatively influences the environment.”

Gas

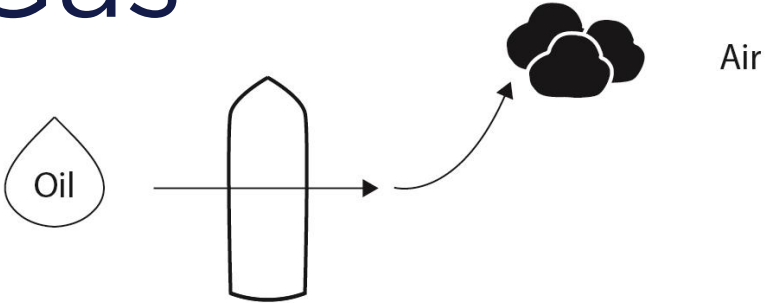

Gas

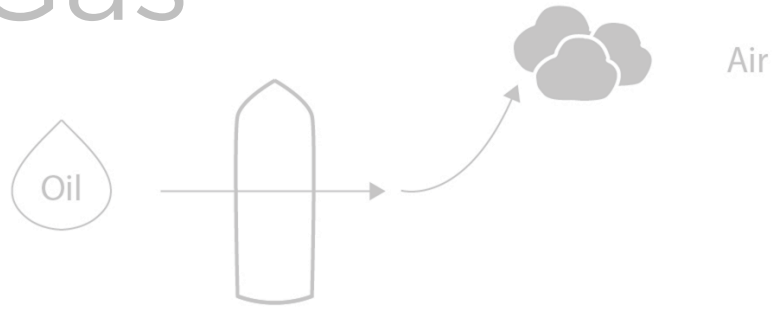

Fluid

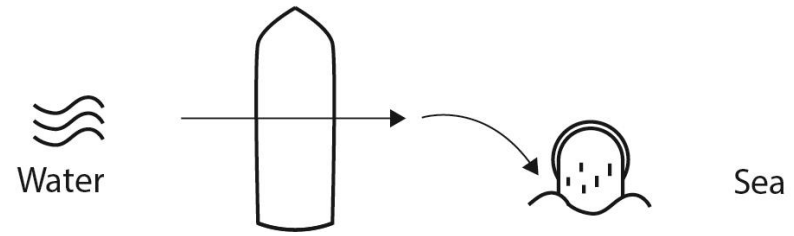

Gas

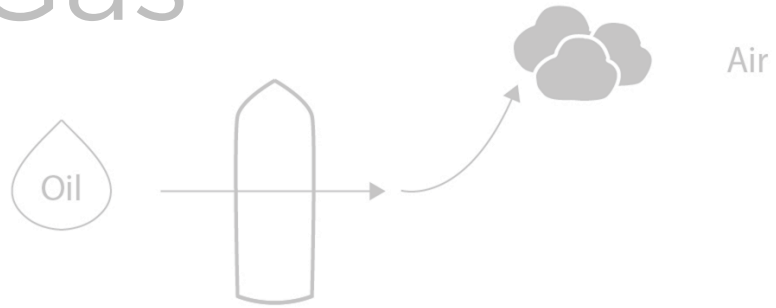

Fluid

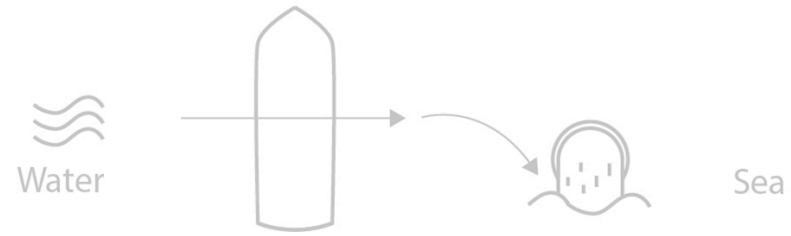

Solid

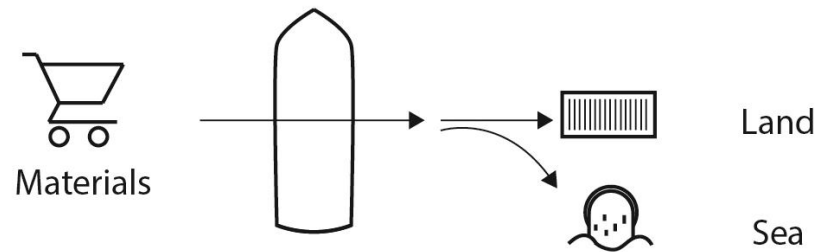

“To **contribute** to the **development of sustainable, circular cruise ships**. Specifically, the gas-, fluid- and solid waste streams.”

The **final product** is a **roadmap**, based on waste stream analyses, towards a set of targets and goals.

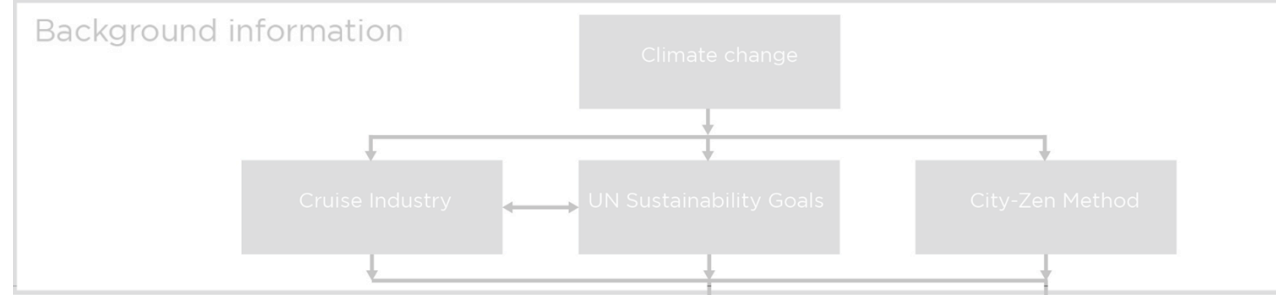

Research Framework

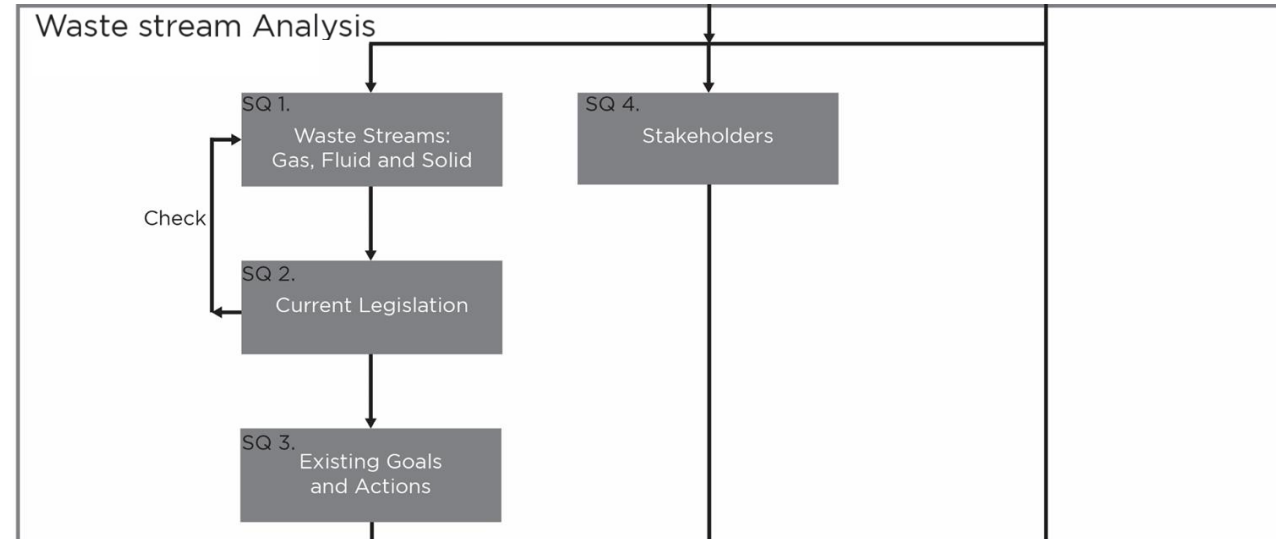

A photograph showing the deck of a cruise ship. A large, dark plume of smoke or steam is rising from the funnel area. The ship's funnel is blue with a white sun-like logo. The deck is made of wood and has white railings. In the background, a coastal town is visible across the water.

Gas

Moss And Fog, (2019)

A photograph of a ship's deck. A high-pressure hose is spraying water overboard into the ocean. The water is creating a large splash and white foam. The ship's structure and railings are visible in the foreground.

Fluid

USCG, (n.d.)

Two recycling bins are shown. They have blue lids and white bodies. The lids are labeled 'PAPER', 'PLASTIC', and 'GLASS'. The bodies have the text 'The Waves' and a recycling symbol. The bins are on a wooden deck.

Solid

Less Haines, (n.d.)

Gas

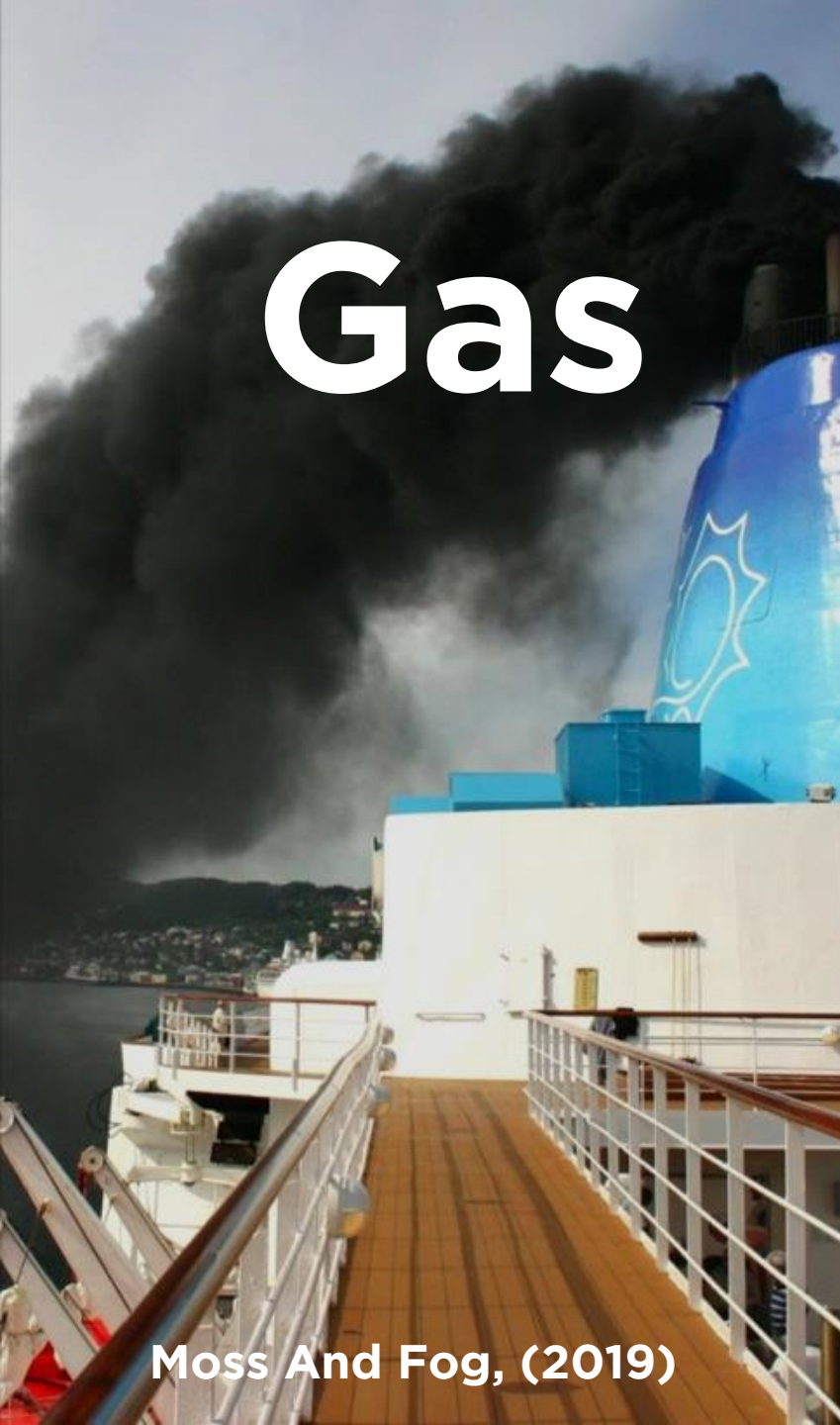

Moss And Fog, (2019)

Fluid

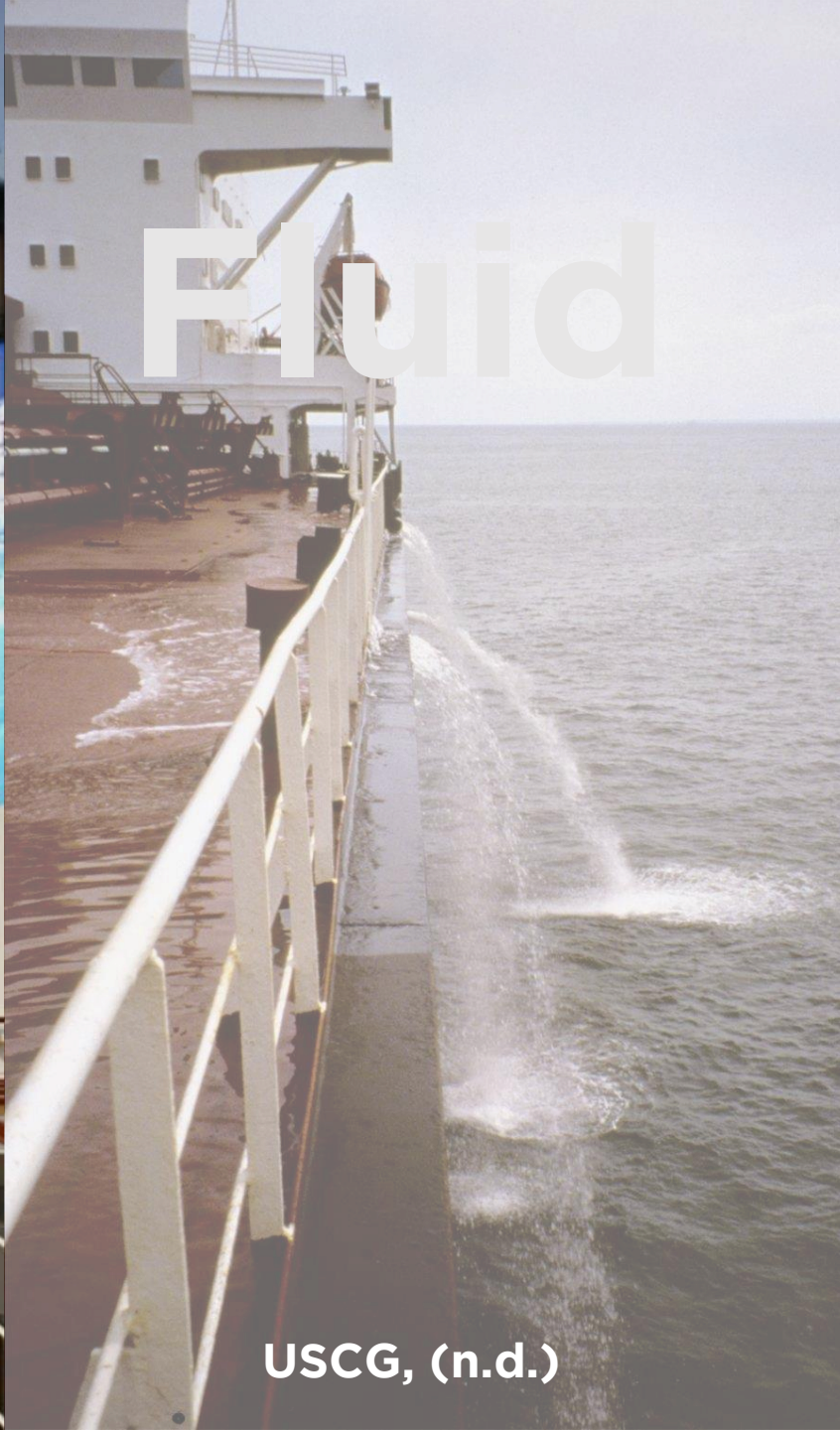

USCG, (n.d.)

Solid



Less Haines, (n.d.)



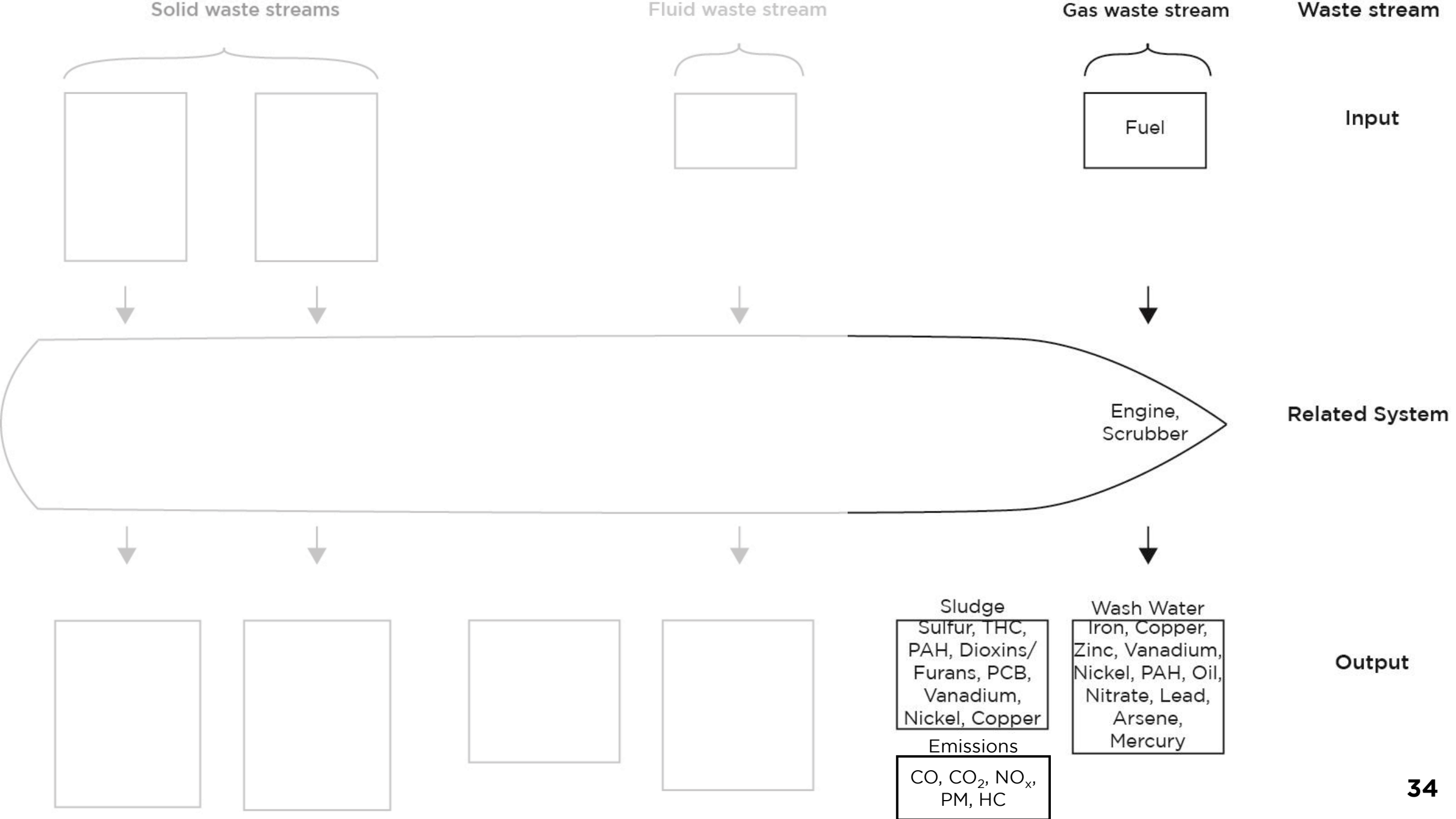



Gas

Moss And Fog, (2019)



Fluid

USCG, (n.d.)



Solid

Less Haines, (n.d.)

1.Black Water



1.Black Water 2.Grey Water



1.Black Water

2.Grey Water

3.Ballast Water



1. Black Water 2. Grey Water 3. Ballast Water
4. Bilge Water



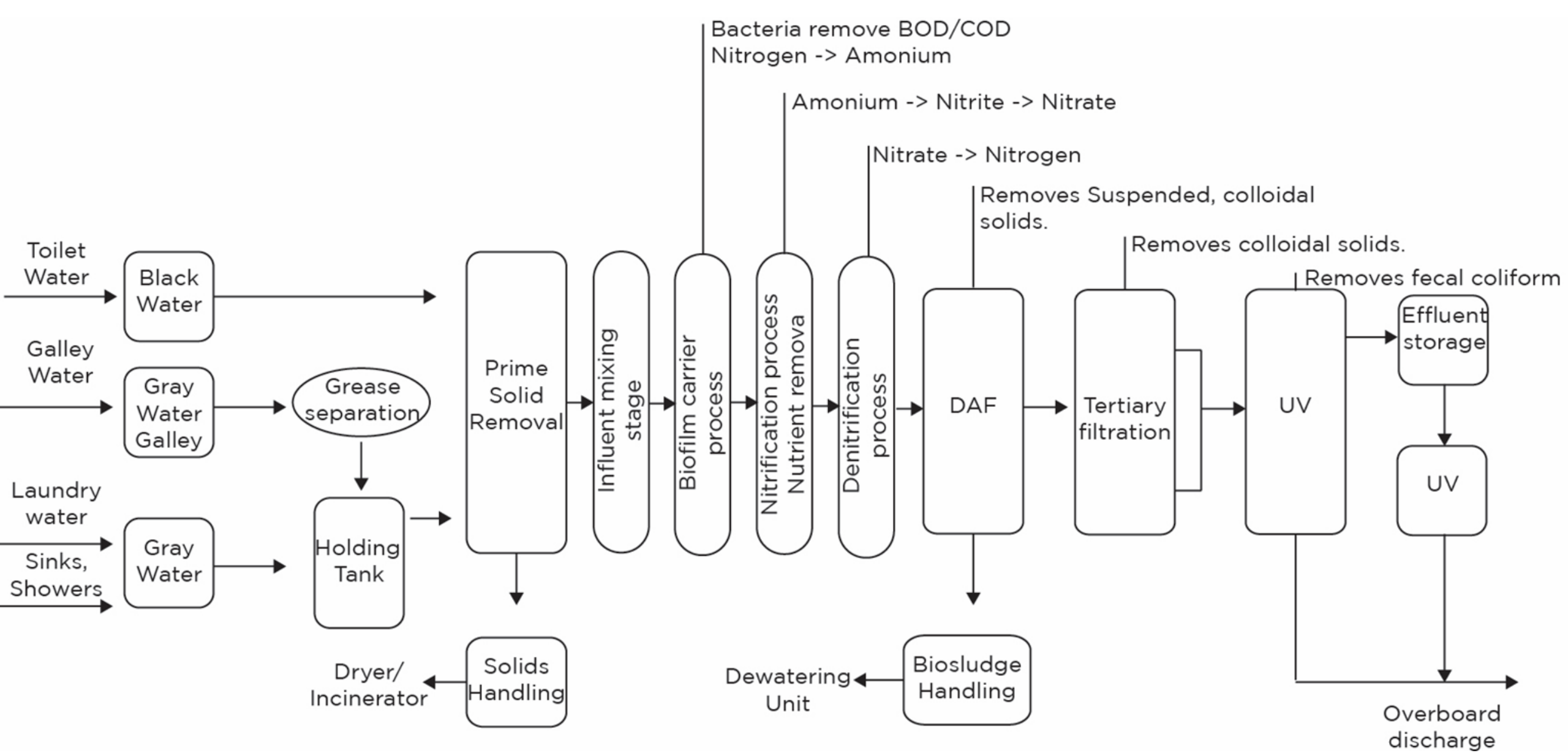

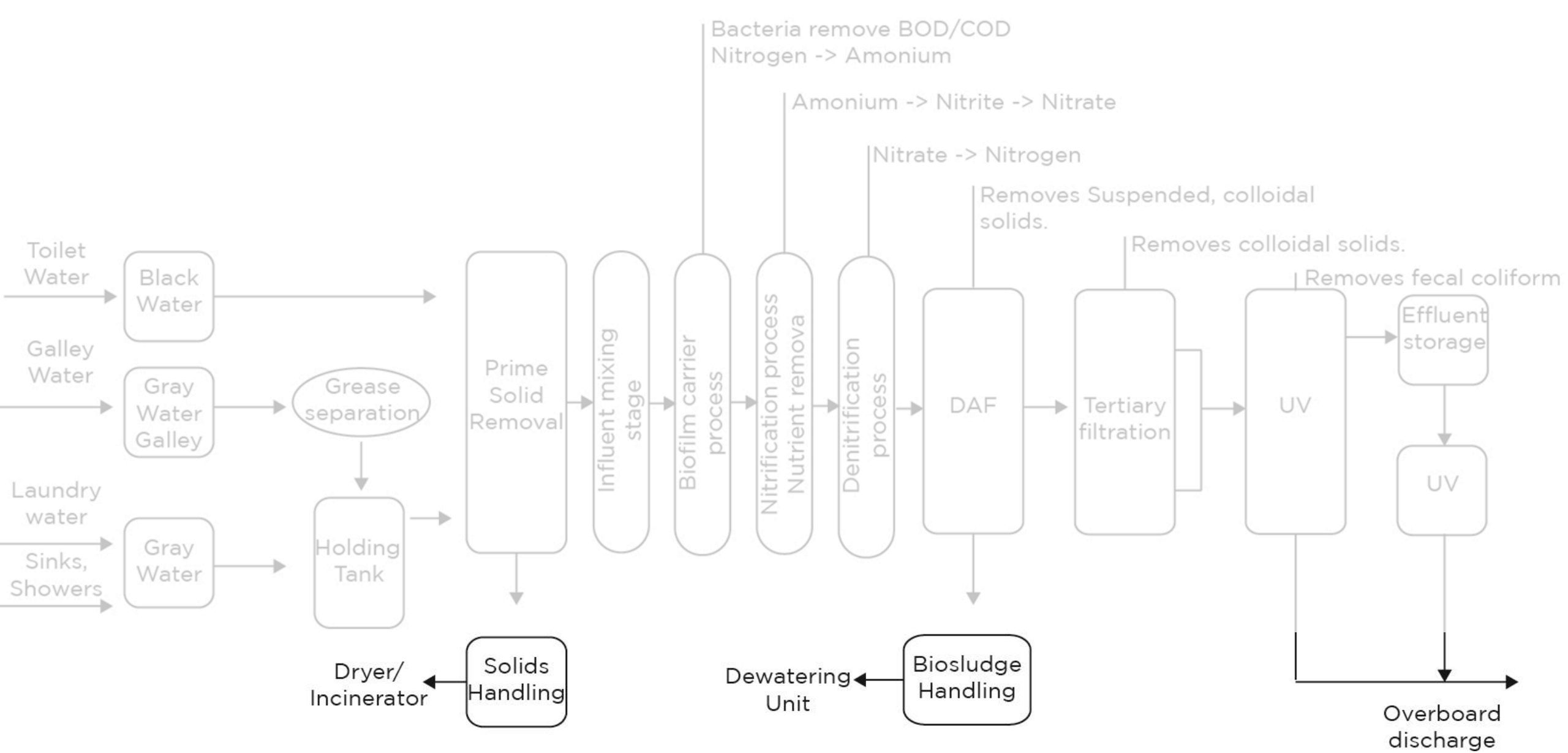

| Component |
|--|
| (partly) Removed |
| Ammonia Nitrogen mg/L as N |
| BOD5 mg/L |
| COD mg/L |
| Faecal Coliform |
| Hexane Extractable Material (Oil and Grease) mg/L |
| Nitrate mg/L |
| Nitrite mg/L |
| Total Kjeldahl Nitrogen mg/L (Nitrogen contained in organic substances and inorganic compounds) |
| Properties that must be met |
| Alkalinity mg/L (capacity to resist pH changes) |
| Conductivity uS/cm (capability to pass electrical flow) |
| Temperature °C |
| pH |
| Turbidity mg/L |
| Not verified |
| Chloride mg/L |
| Settable Residue mg/L |
| Sulfate mg/L |
| Total Dissolved solids mg/L (Organic and inorganic substances) |
| Total organic carbon mg/L (Acids, fats, sugars, proteins, enzymes, and hydrocarbon fuels) |
| Total phosphorous mg/L |
| Total Residual Chlorine mg/L |
| TSS mg/L Total suspended solids |

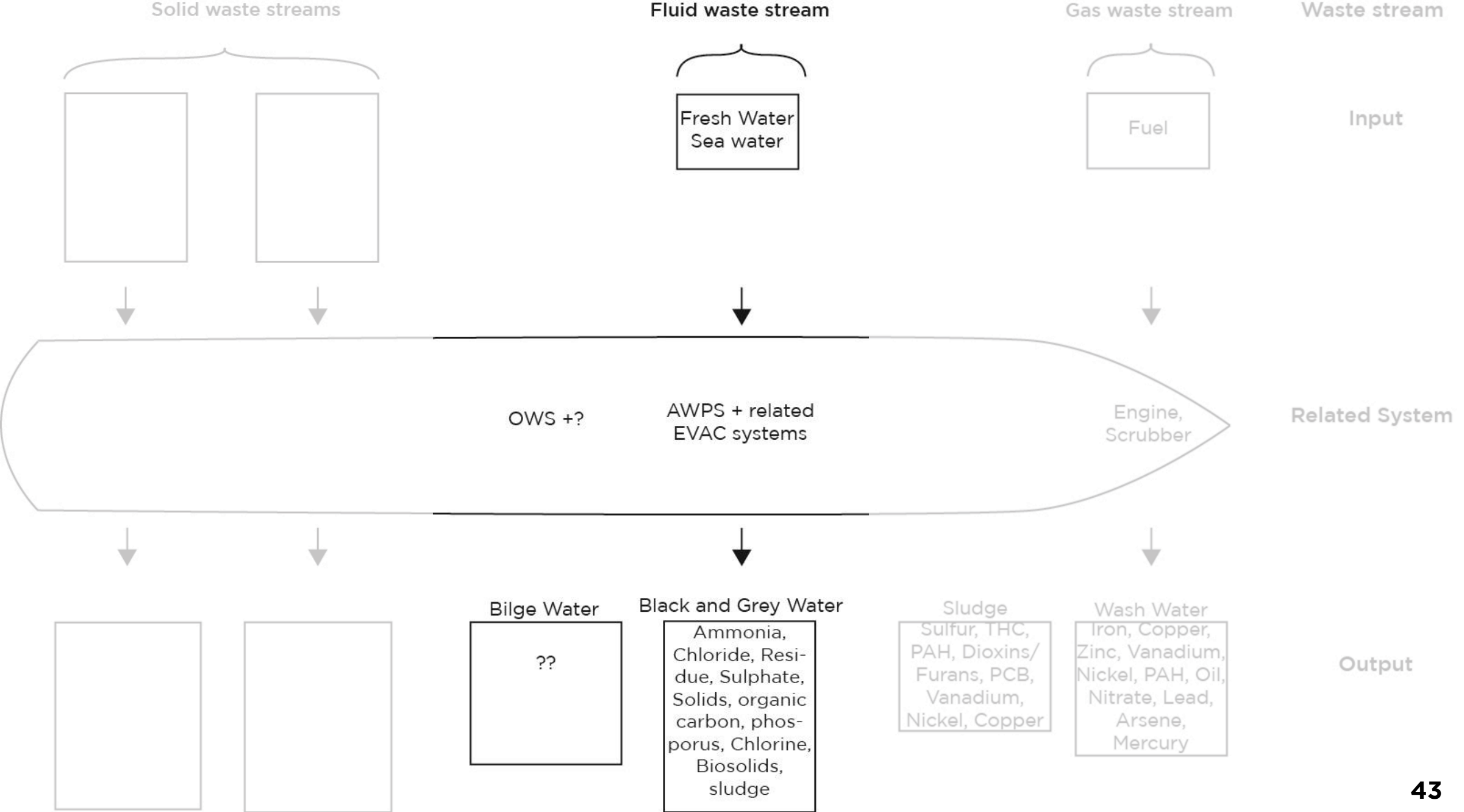

OWS + a Polishing treatment process

Polishing treatment processes:

- **Absorption and Adsorption**
- Biological Treatment
- **Coagulation and Flocculation**
- Flotation
- Membrane Technologies (ultrafiltration).

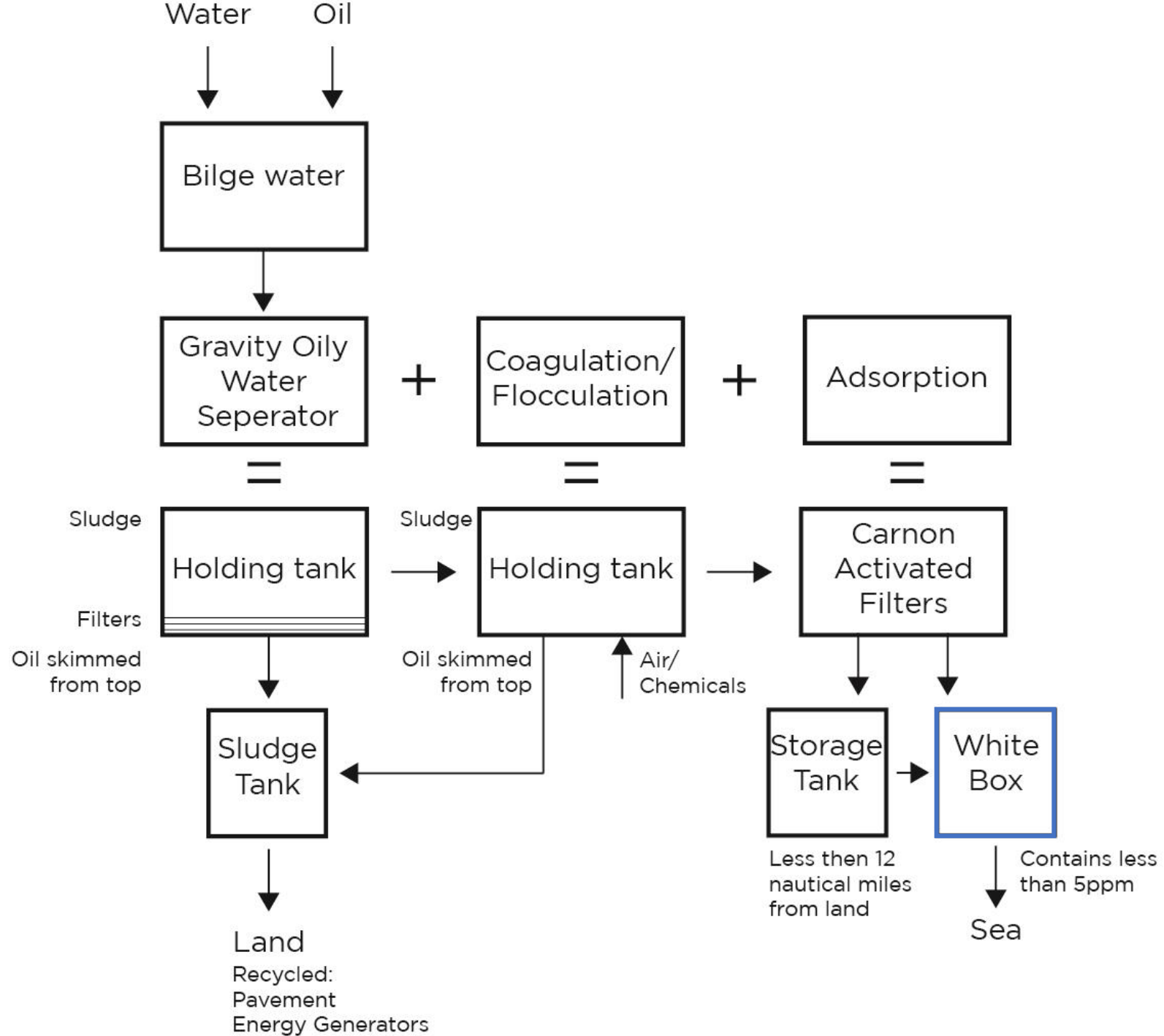

But still contains:

- Heavy metals
- Emulsified oils

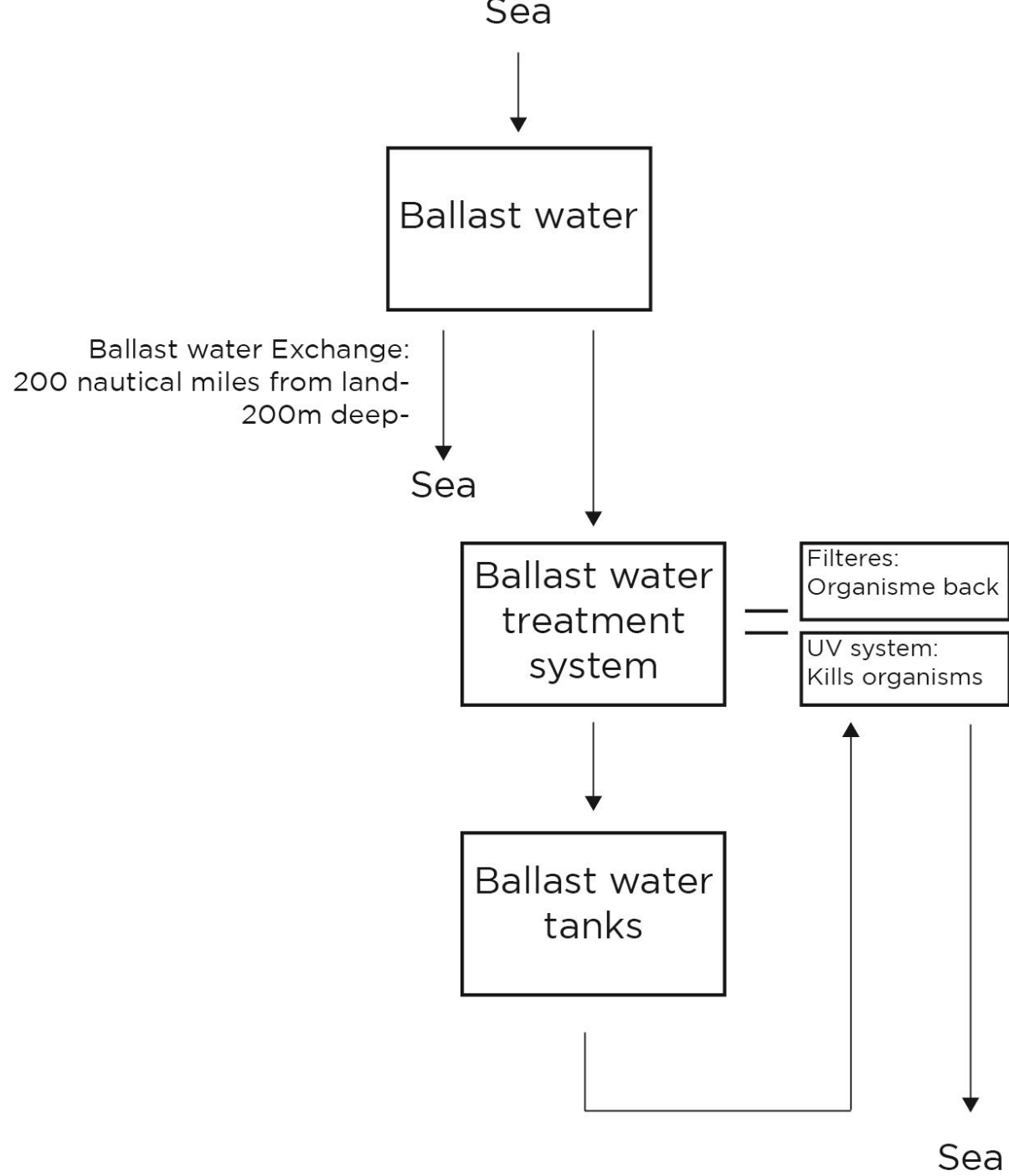

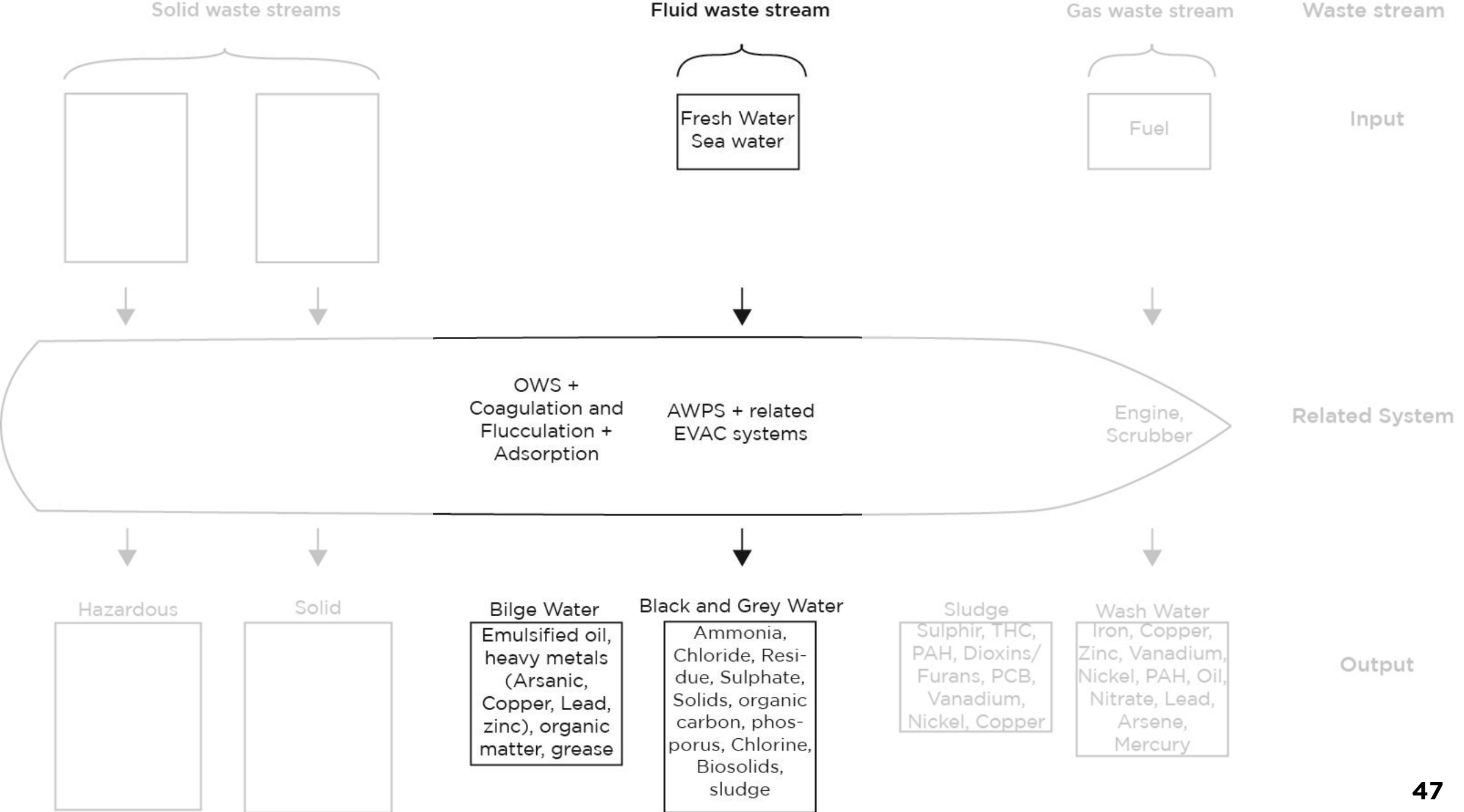



Gas

Moss And Fog, (2019)



Fluid

USCG, (n.d.)



Solid

Less Haines, (n.d.)

| Non-hazardous Solid Waste | Used for | Treatment | Ends up |
|----------------------------------|---|---------------------------------|------------------|
| Glass | Food and beverage jars & bottles. | Crushed | Land |
| Plastic | ropes, containers, bags, biodegradable plastics, poly-ethylene terephthalate plastics, high-density polyethylene plastics | Incinerated, recycled | Land, Air, (Sea) |
| Aluminium & Metal Cans | Soft drink cans, tin cans (food), steel cans ship maintenance | Crushed, recycled | Land |
| Paper | Paper and packing | Incinerated, recycled | Land, Air, (Sea) |
| Cardboard | Dunnage, packing | Incinerated, recycled | Land, Air, (Sea) |
| Food waste | Food scraps, table refuse, galley refuse, food wrappers contaminated with food. | Pulped, compressed, incinerated | Land, Air, (Sea) |
| Wood | Pallets, waste wood | Incinerated | Land, Air, (Sea) |
| Incinerator ash | Ash from packing material, paper, cardboard, etc. | - | Sea |

| Hazardous waste | Hazardous waste Substances |
|--|-----------------------------------|
| Paints waste | Perchloroethylene |
| Incinerator ash | Hydrocarbons |
| Fluorescent and mercury vapour light bulbs | Chlorinated hydrocarbons |
| Batteries | Heavy metals |
| Medical waste | Solvents |
| Photo waste | Silver |
| Explosives | Aerosol liquids |
| Chemical | |

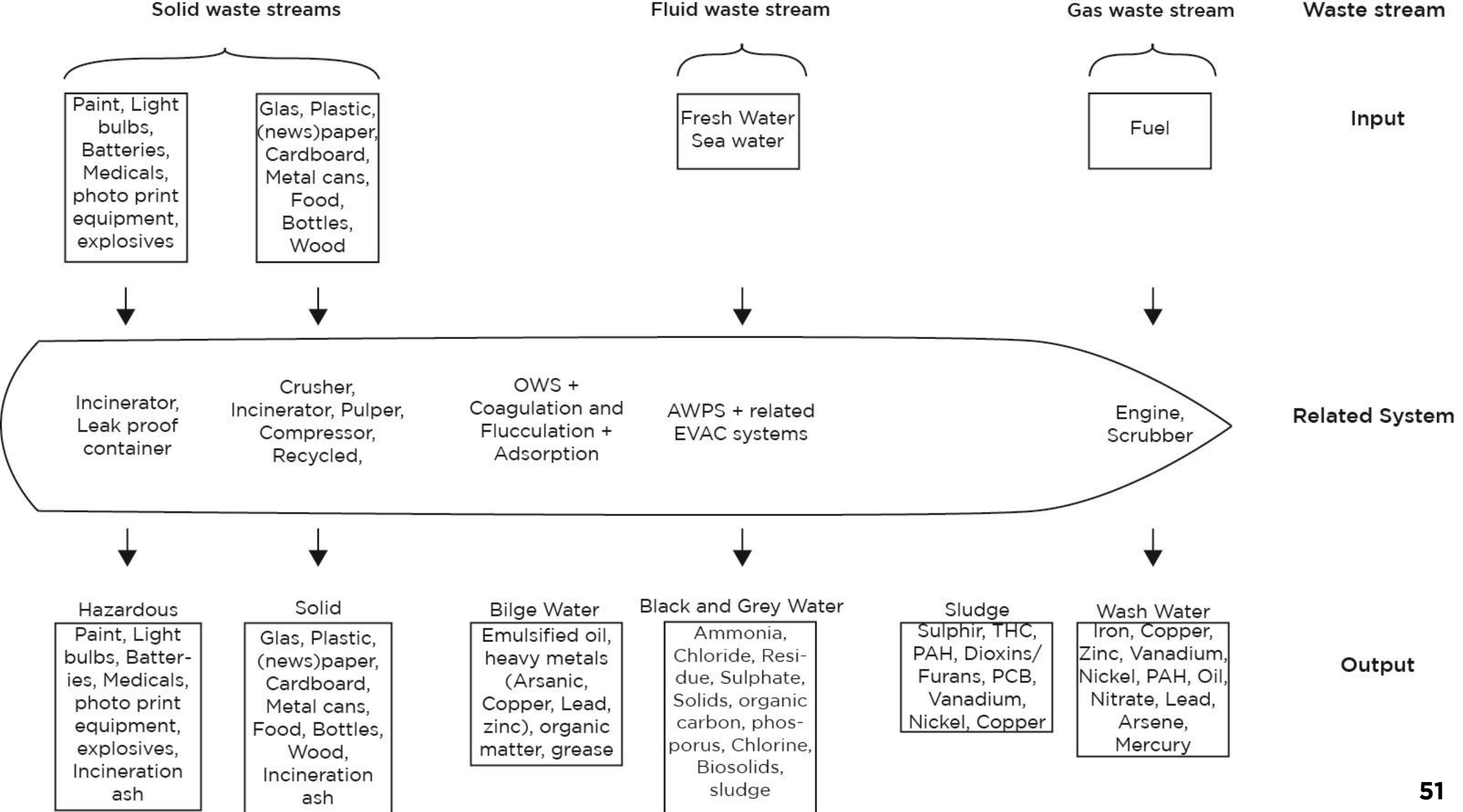

Taken measures by Royal Caribbean

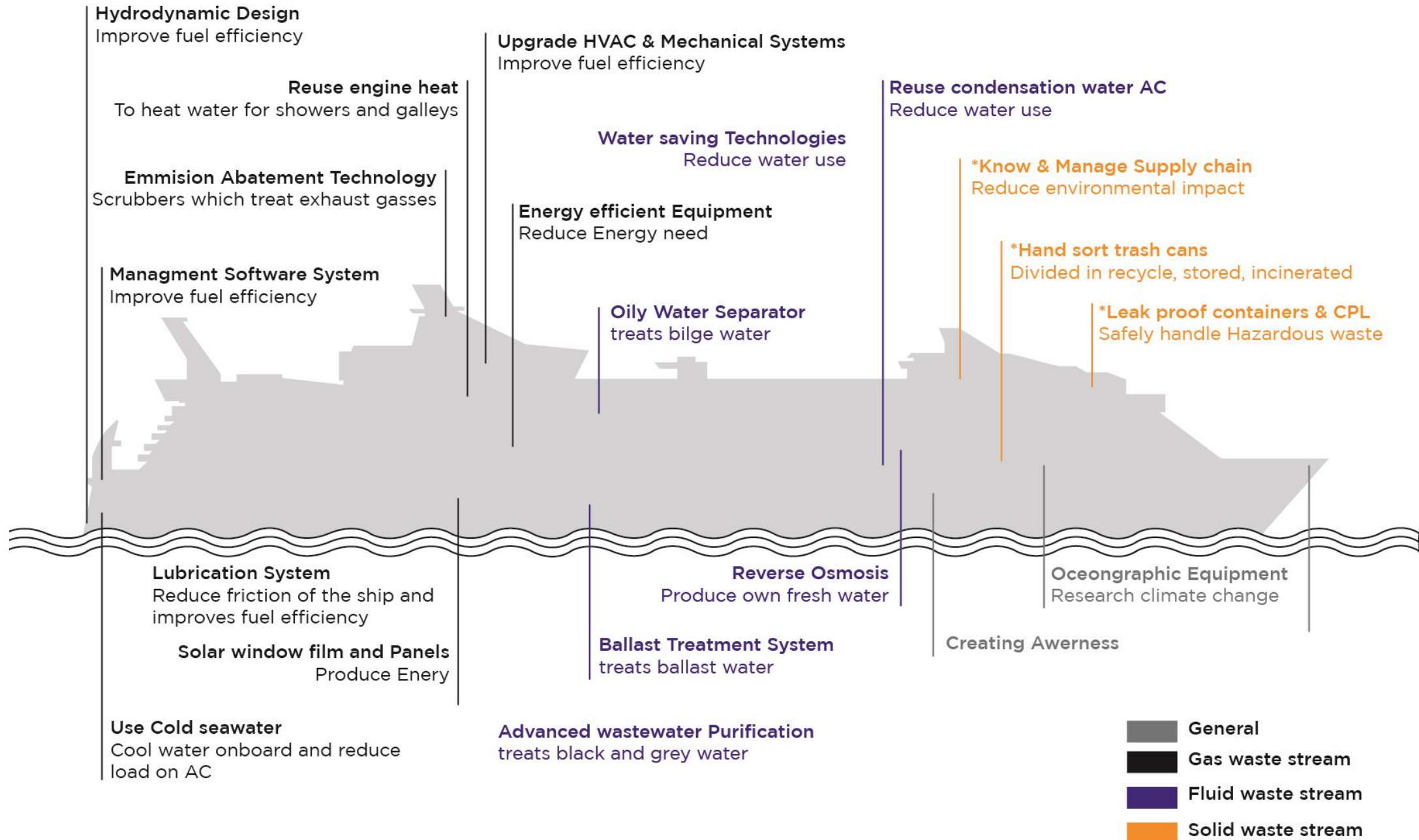

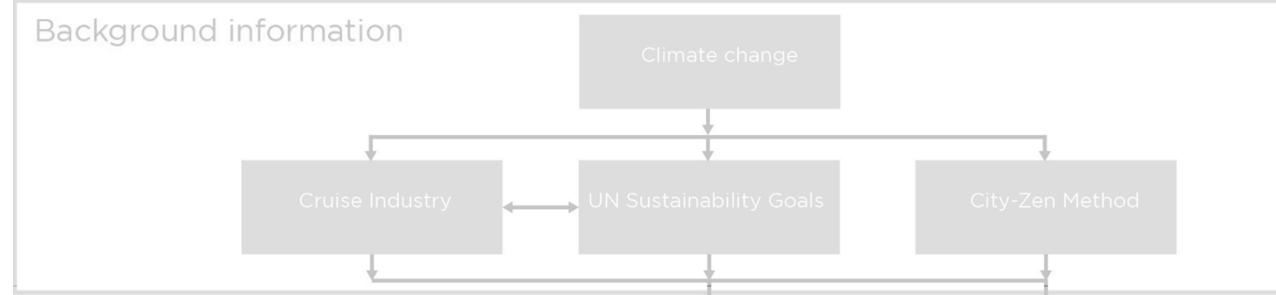

Research Framework

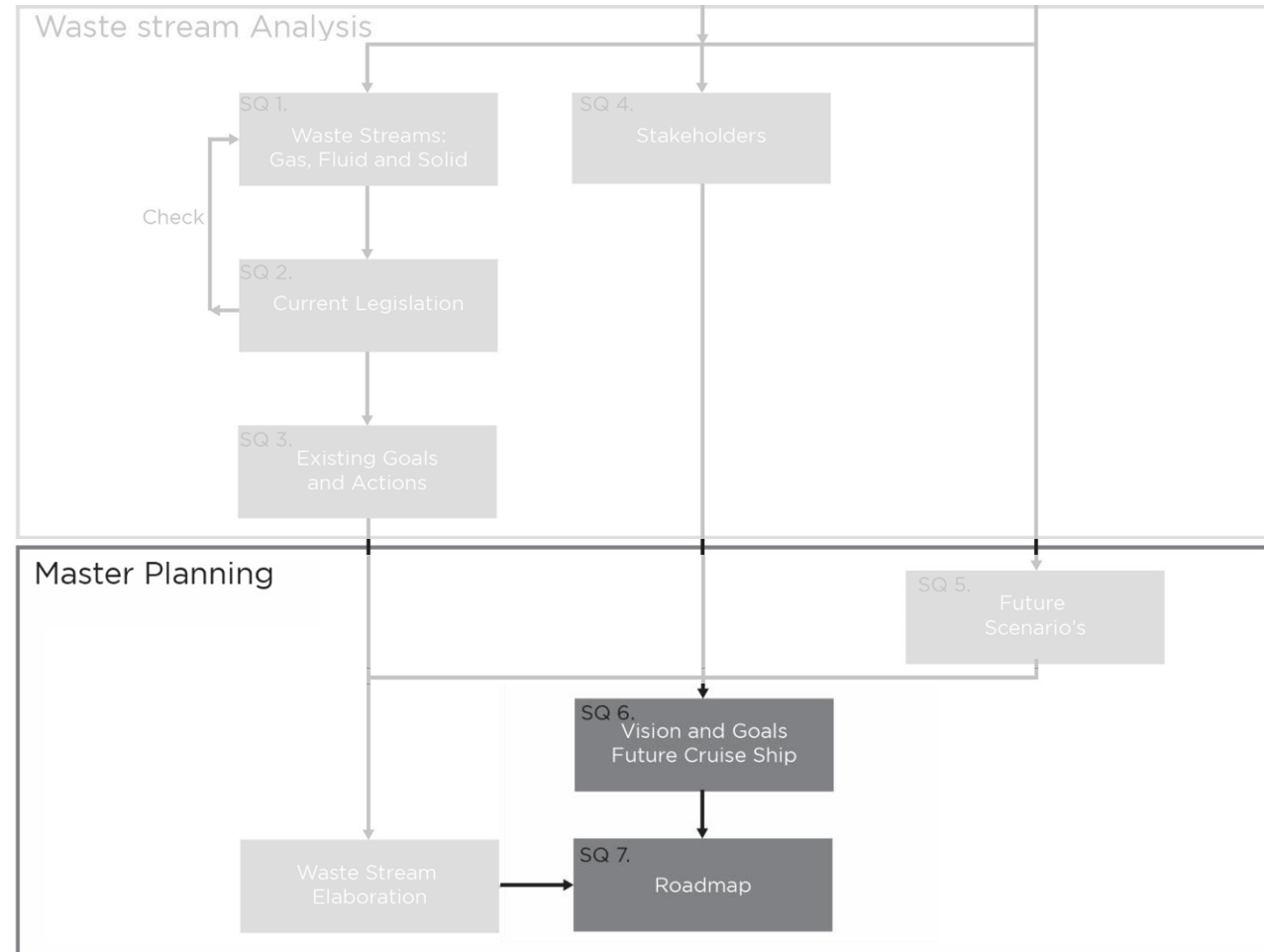

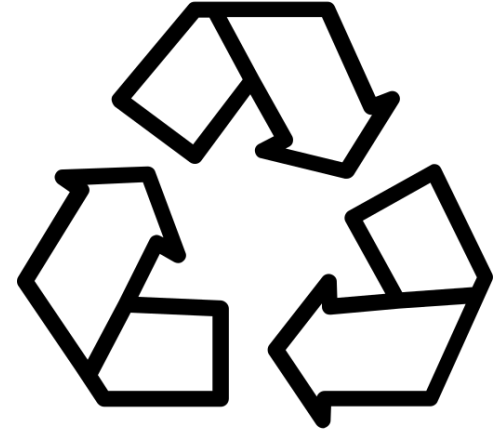

- A. Fully Circular
- B. Collaboration Cruise Ship & Harbour
- C. Positive effect on the Environment

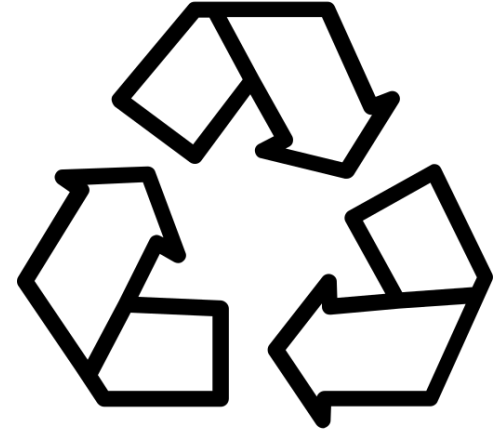

- A. Fully Circular

- B. Collaboration Cruise Ship & Harbour

- C. Positive effect on the Environment

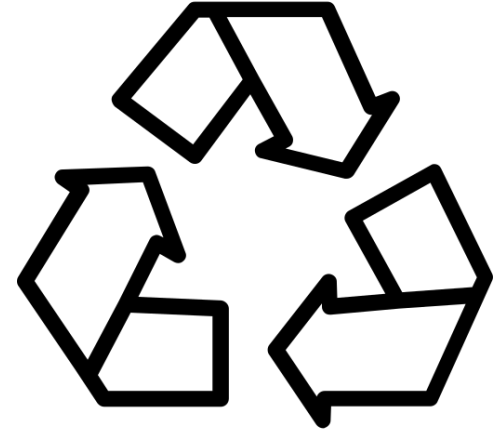

- A. Fully Circular
- B. Collaboration Cruise Ship & Harbour
- C. Positive effect on the Environment

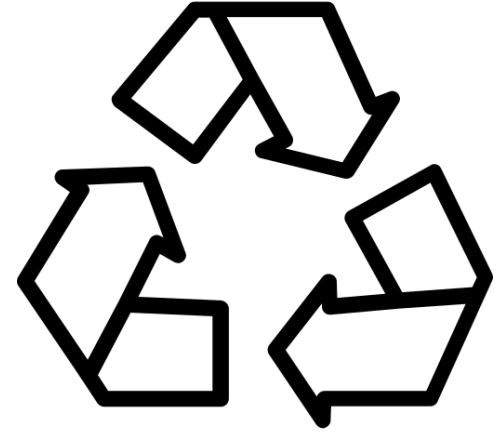

- A. Fully Circular
- B. Collaboration Cruise Ship & Harbour
- C. Positive effect on the Environment

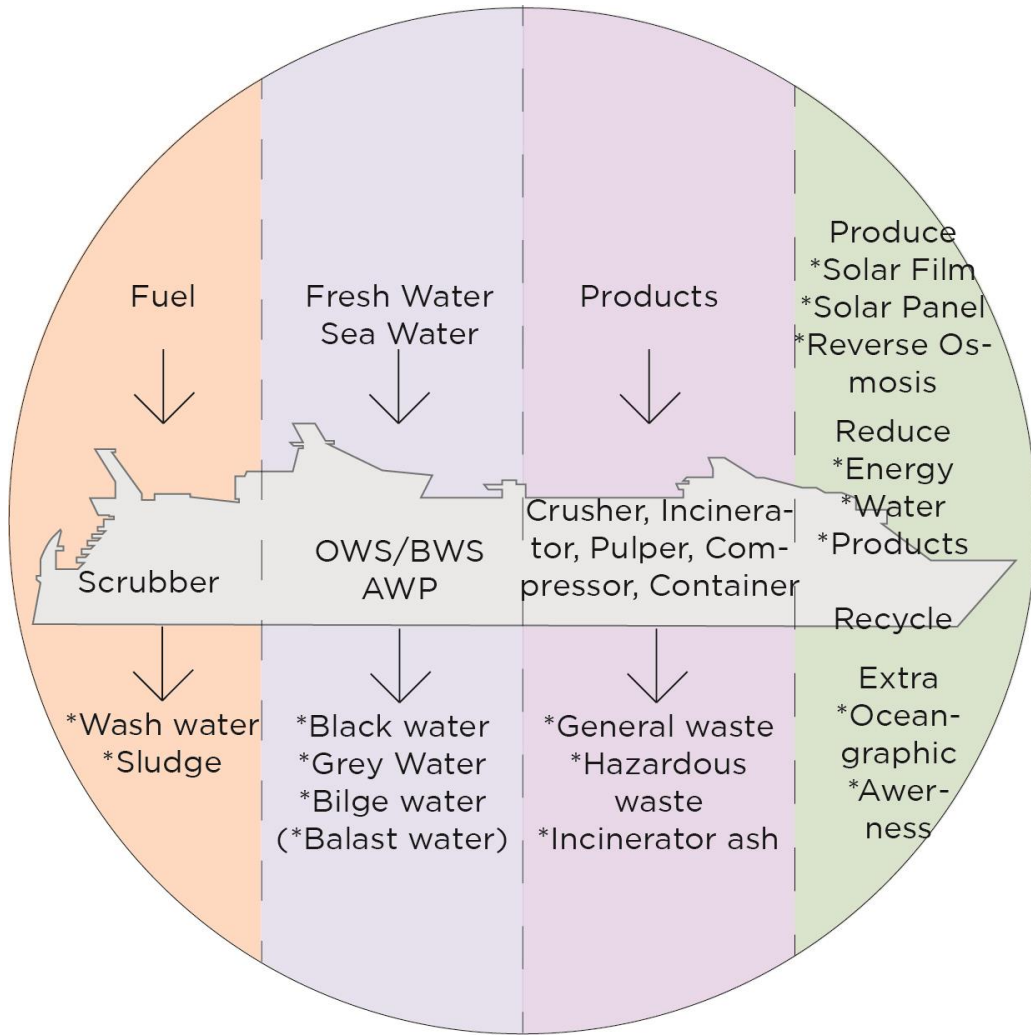

Today

Roadmap A

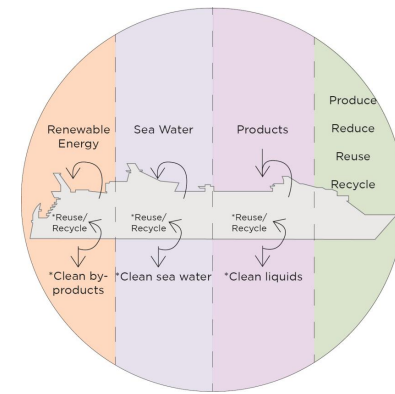

Roadmap B

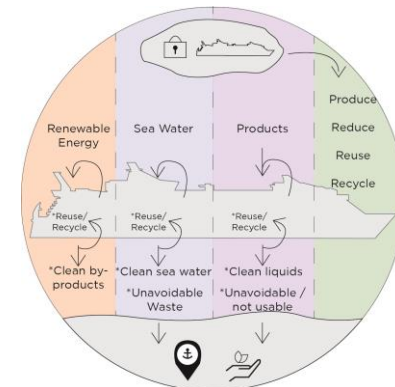

Roadmap C

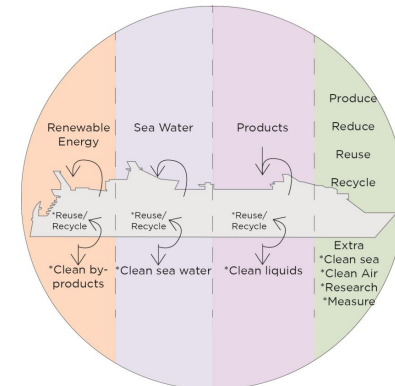

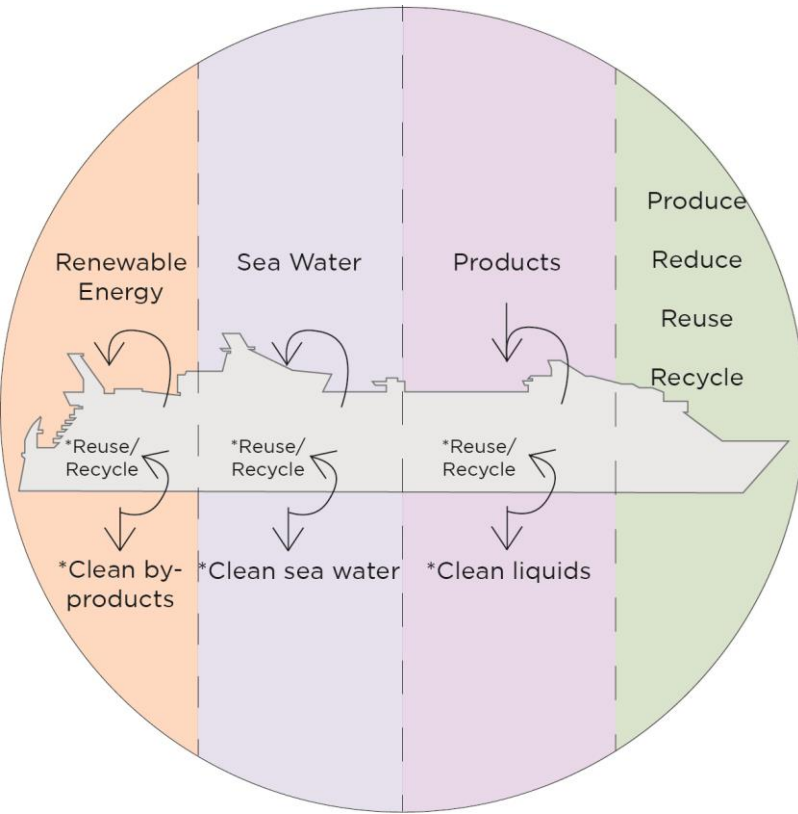

Roadmap A

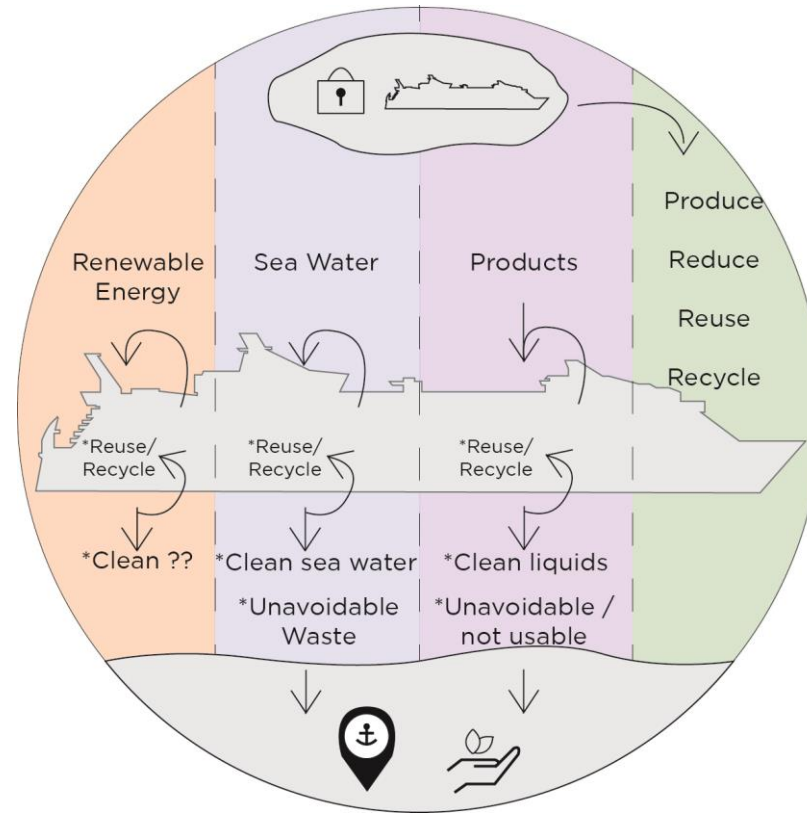

Roadmap B

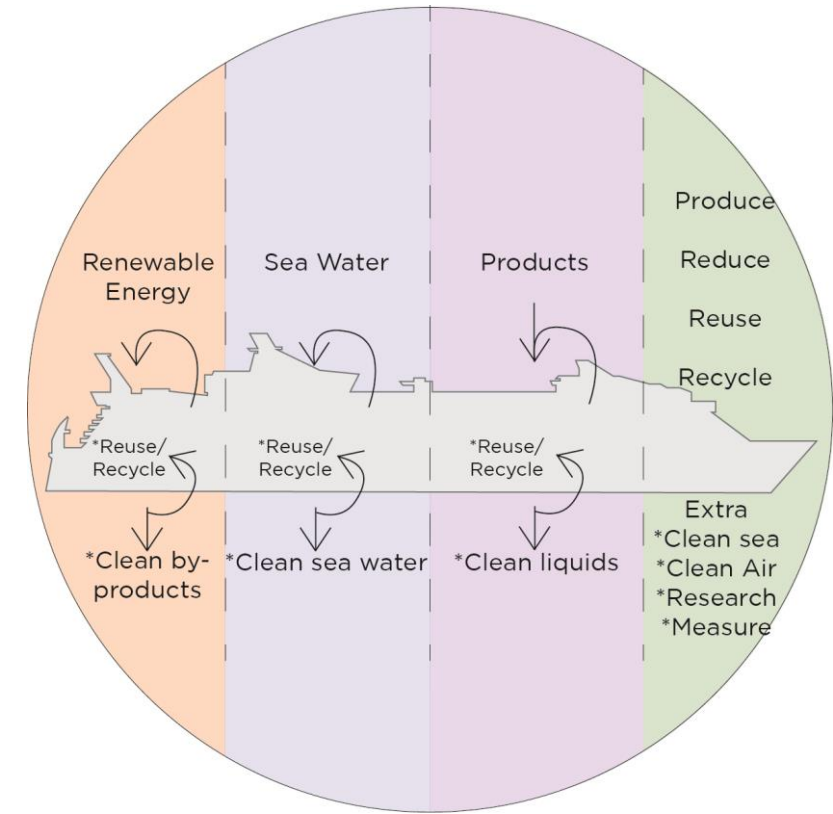

Roadmap C

Gas



Moss And Fog, (2019)

Fluid

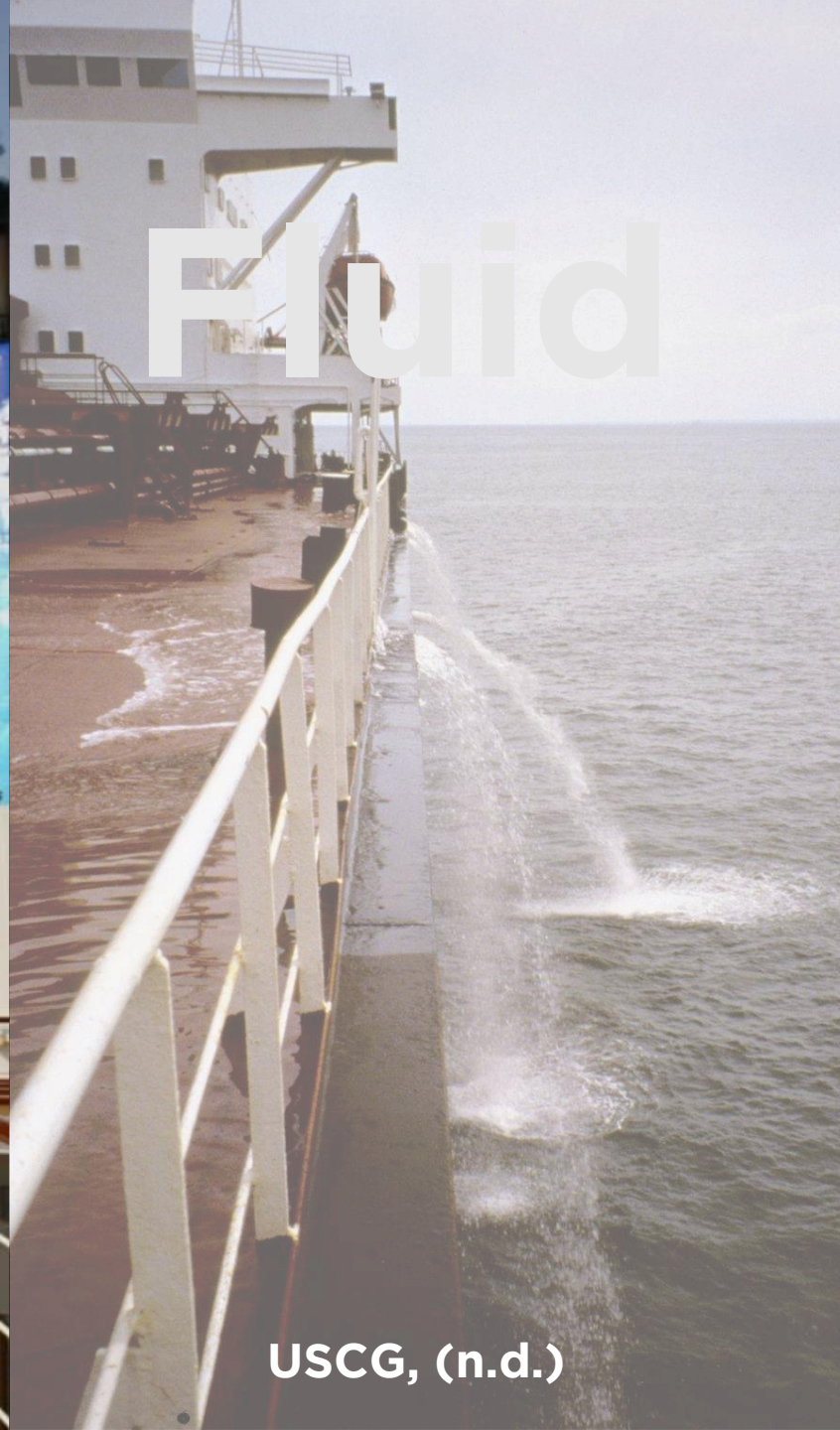

USCG, (n.d.)

Solid



Less Haines, (n.d.)

| | Hydrogen | Methanol | Bio-diesel | Dimethyl ether | Biogas | Renewable Energy Ship | Renewable Energy Island |
|-------------------|-------------|-------------|------------|----------------|--------|-----------------------|-------------------------|
| Fuel Cell | | | | | | | |
| Dual Fuel Engine | | | | | | | |
| Combustion Engine | | | | | | | |
| Now | Near future | Late future | | | | | |

Retrofit

- Combustion engine -> Biodiesel/Dimethyl ether
-> Methanol
- Dual Fuel engine -> Methanol

Newly Build

- Fuel Cell -> Hydrogen

Hydrogen

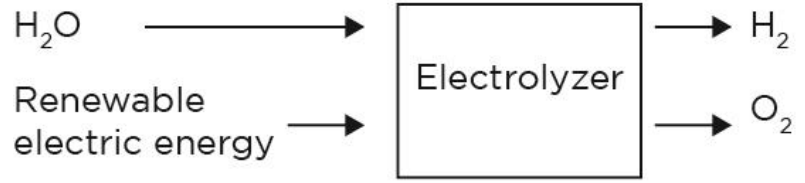

Methanol

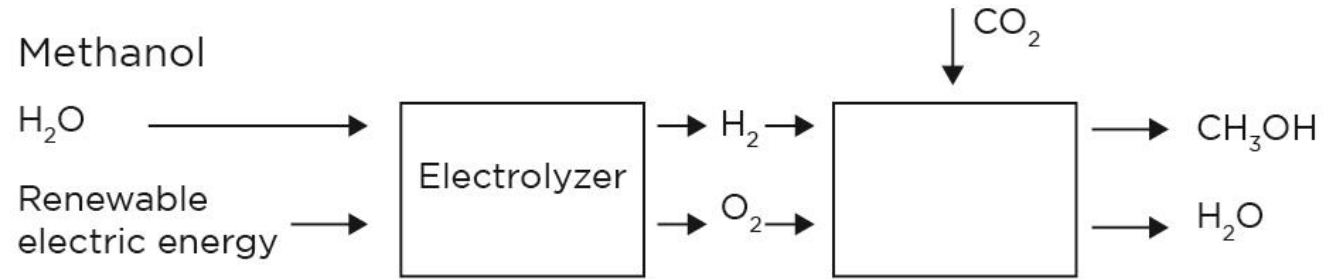

Biodiesel - Onboard

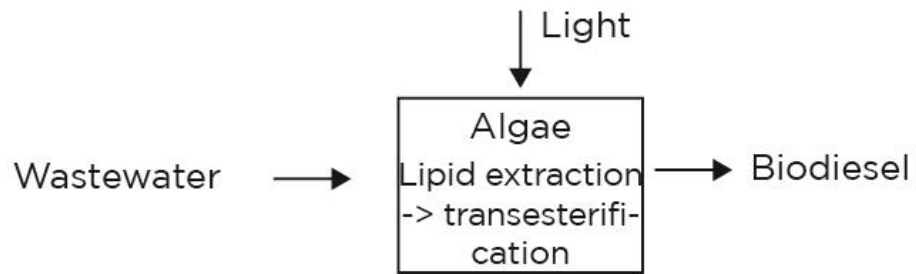

Dimethyl ether



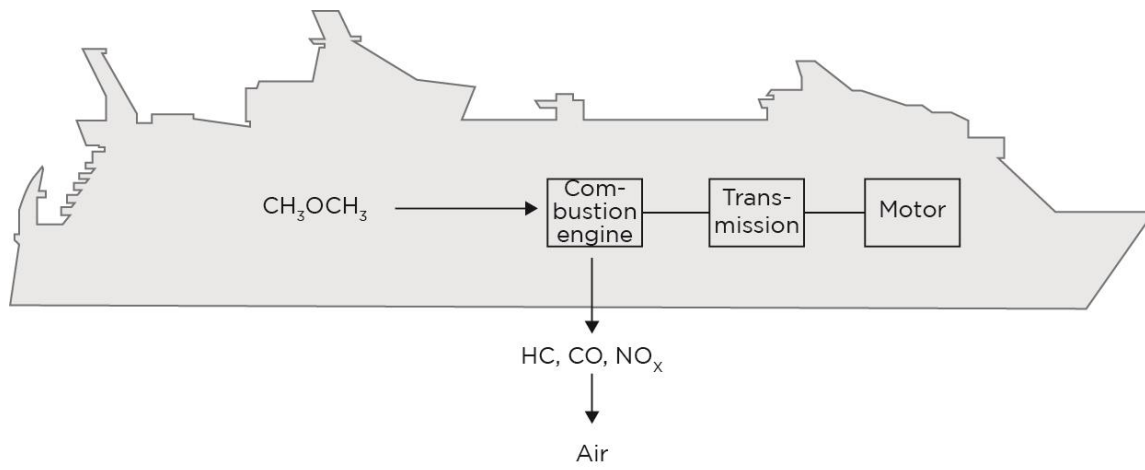

Combustion engine

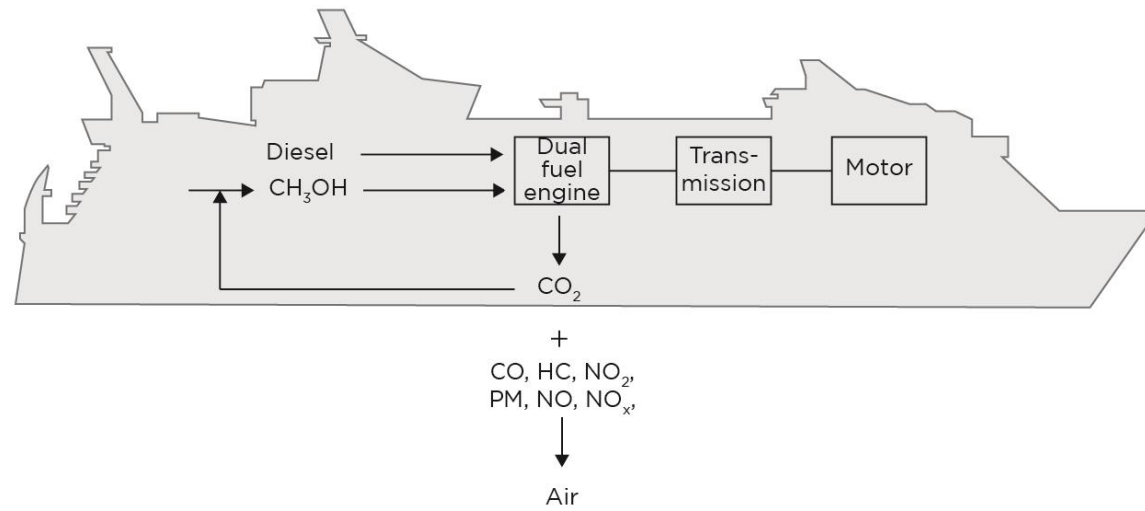

Dual Fuel engine

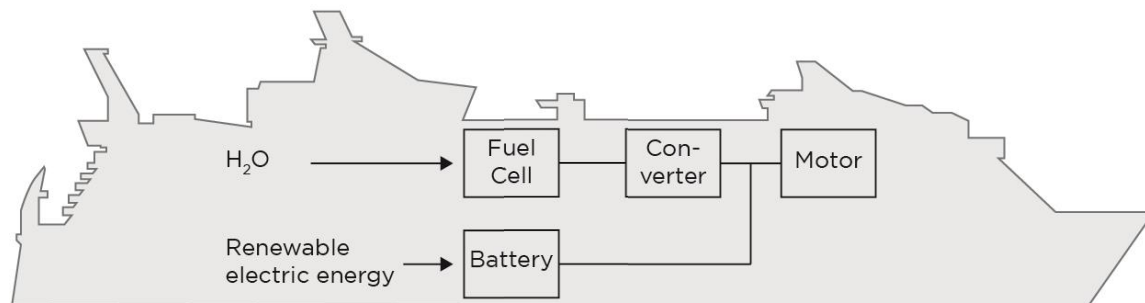

Fuel Cell



Gas

Moss And Fog, (2019)



Fluid

USCG, (n.d.)



Solid

Less Haines, (n.d.)

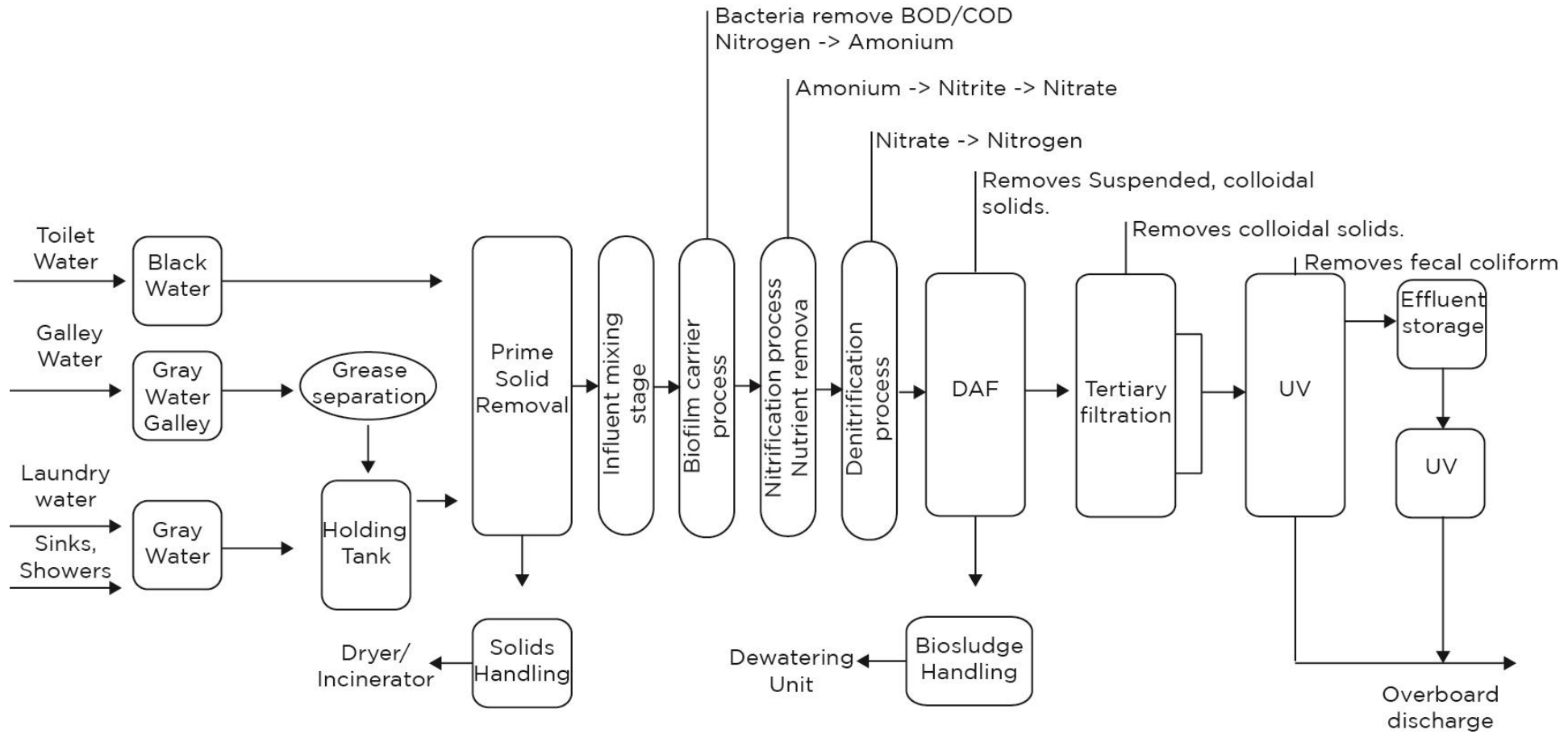

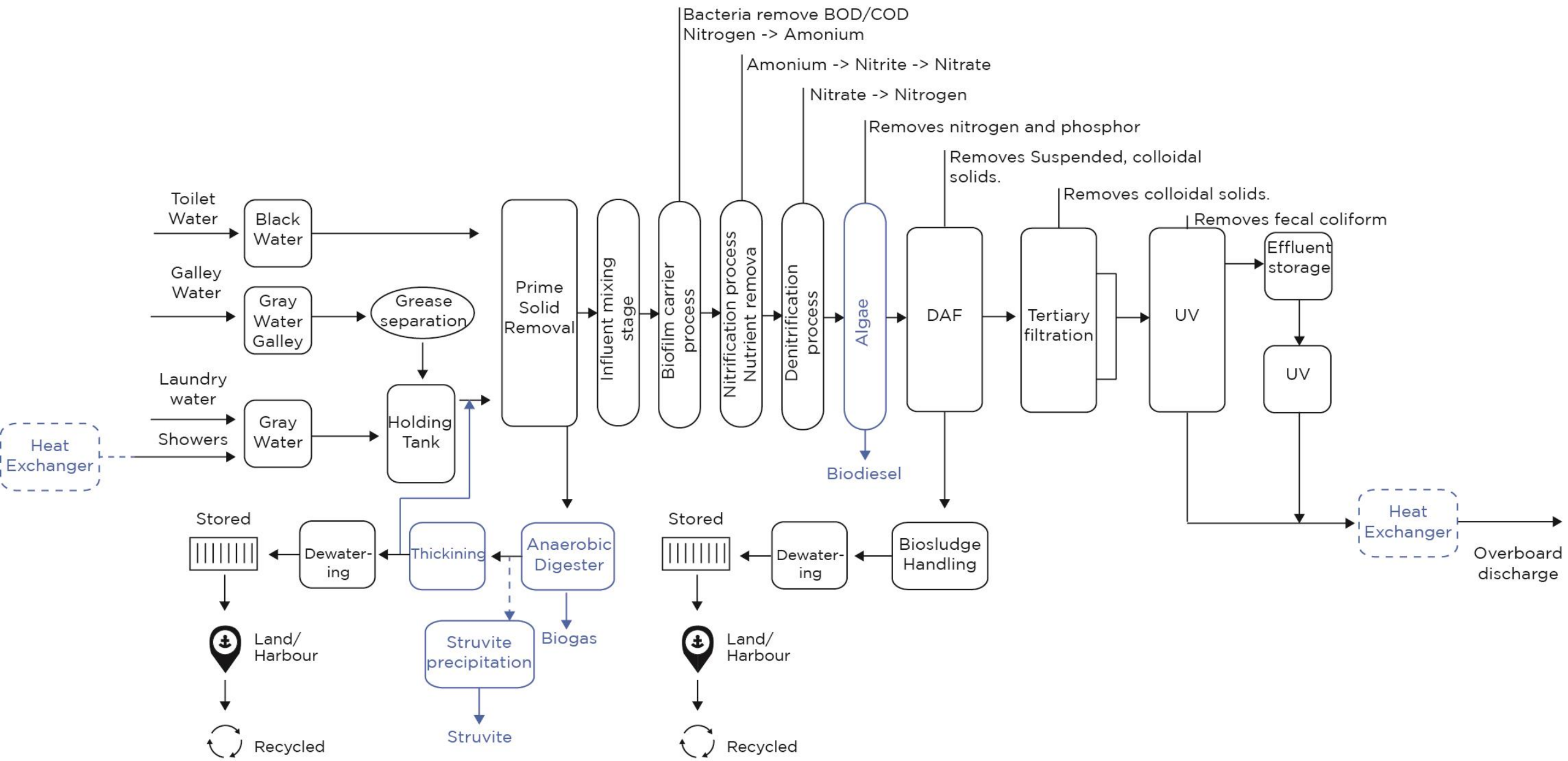

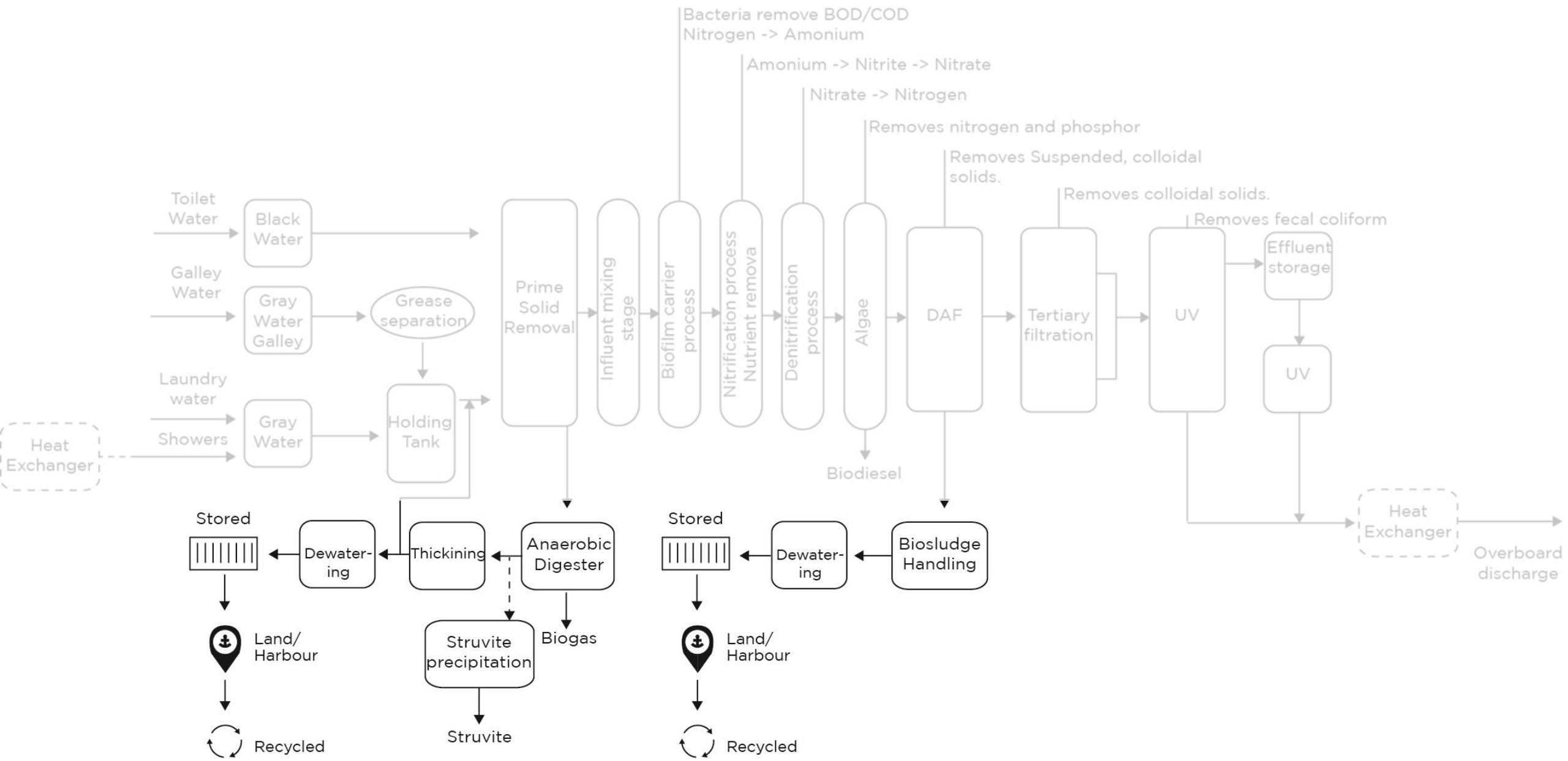

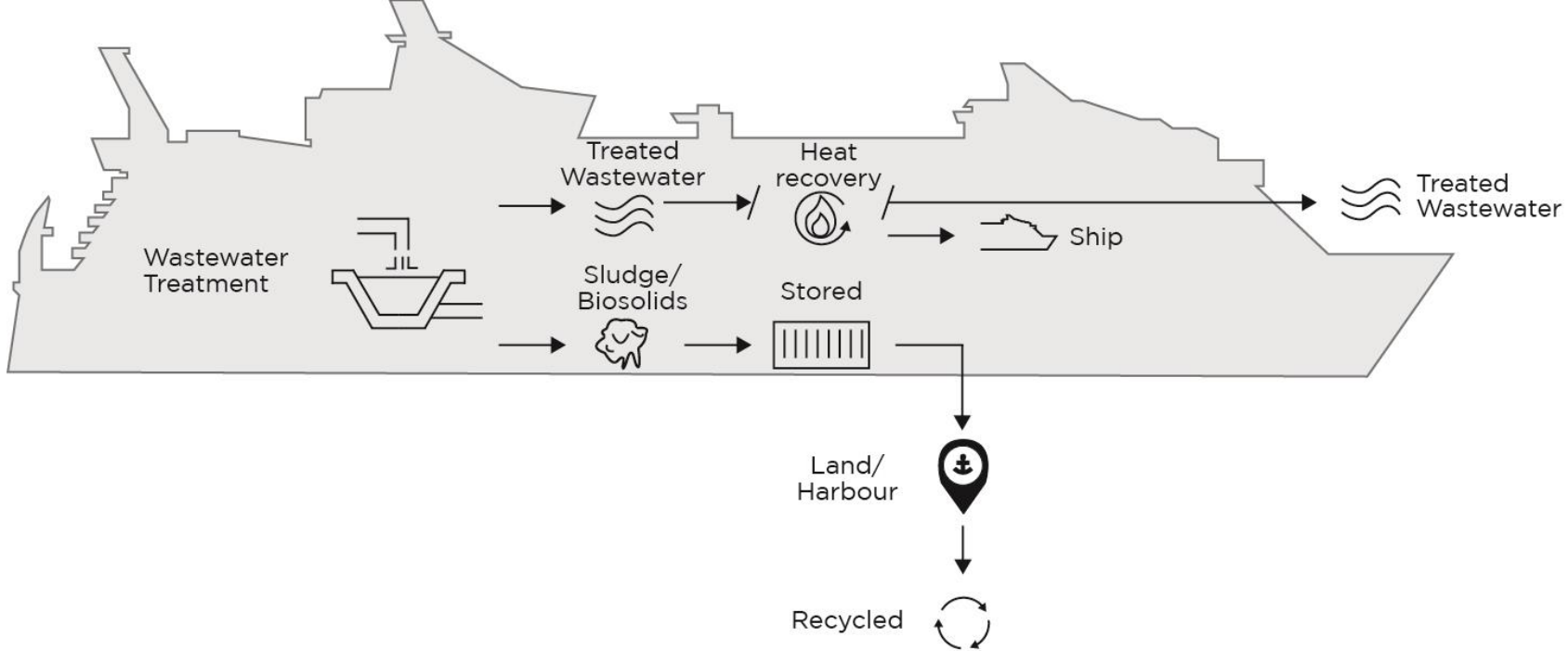

• Retrofit

- Heat recovery black and grey water
- Recycling biosolids and sludge

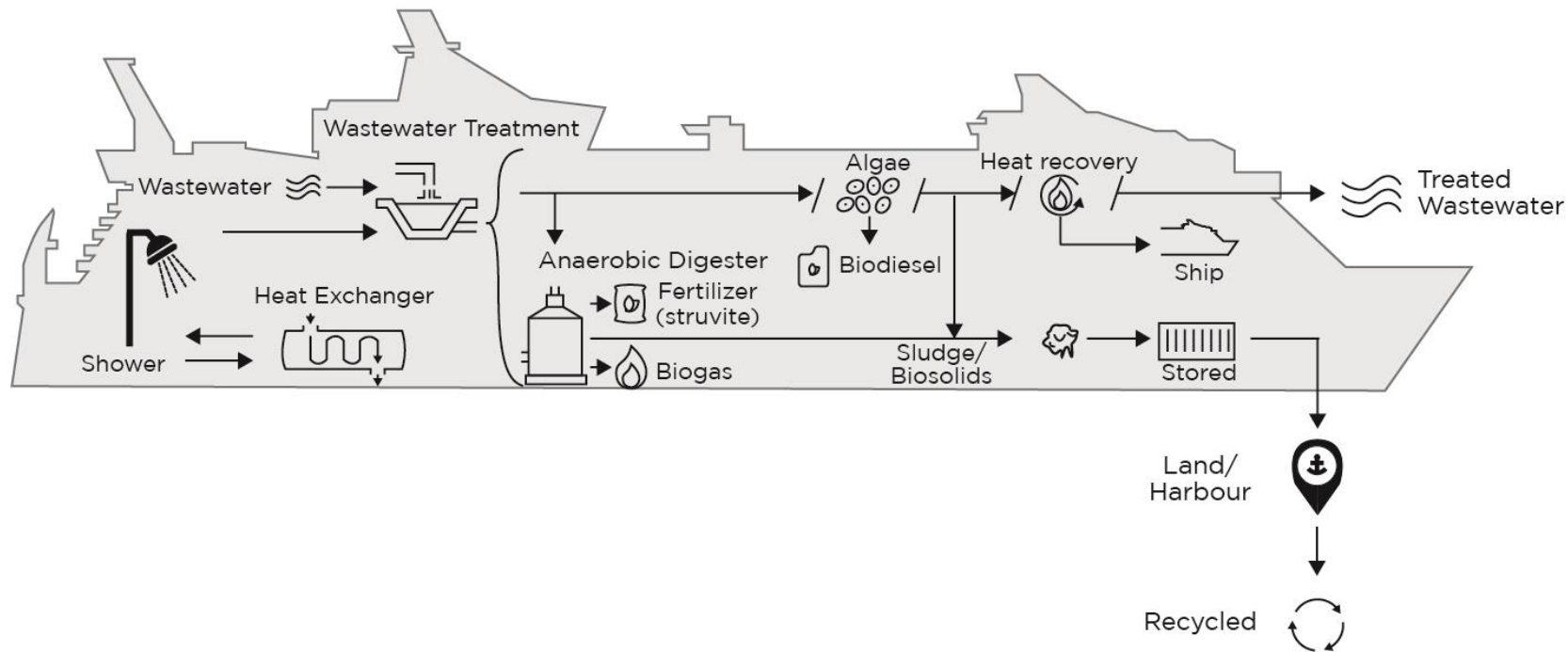

• Newly Build

- Heat recovery black and grey water
- Recycling biosolids and sludge
- Heat exchanger shower
- Anaerobic digester
- Struvite recovery
- Algae system

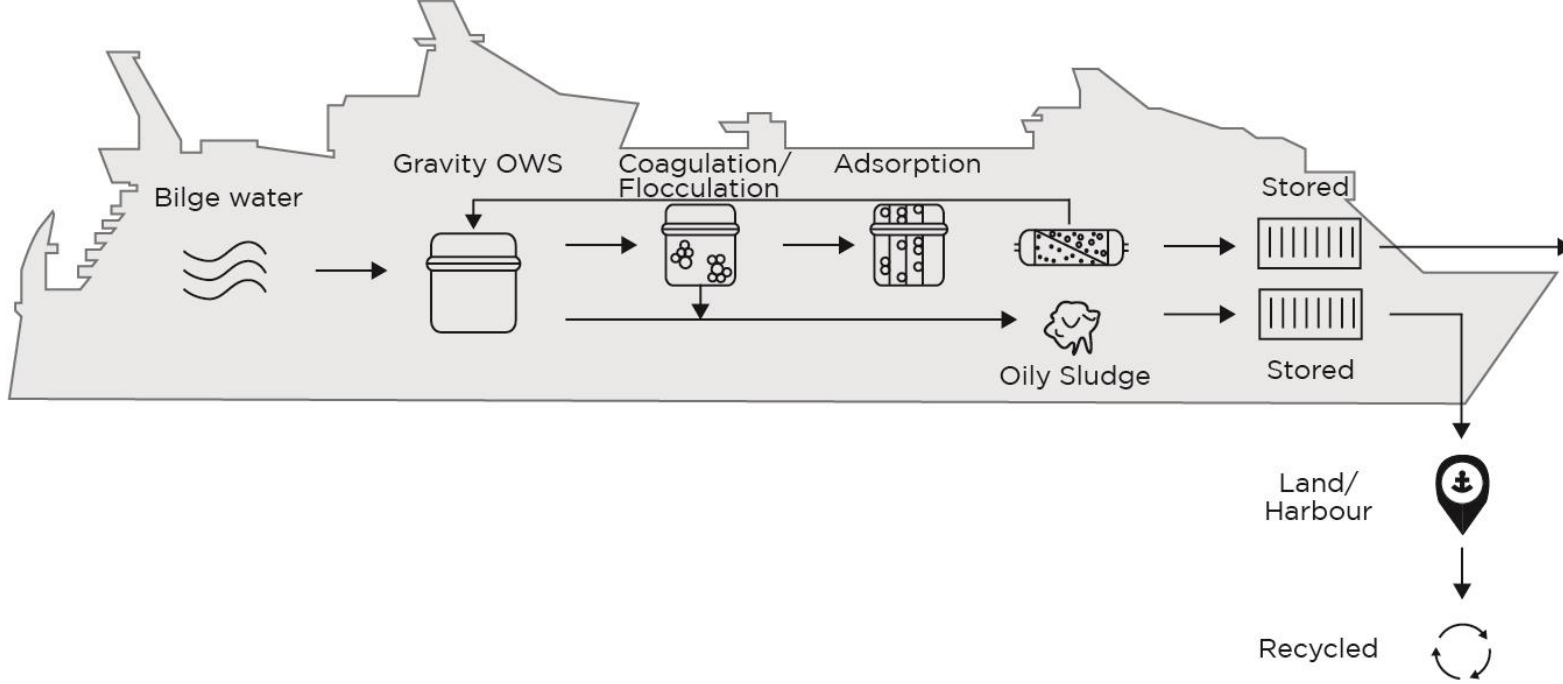

• Retrofit

- Membrane treatment (Nanofiltration/ Reverse osmosis)
- Recycling of oily sludge on land

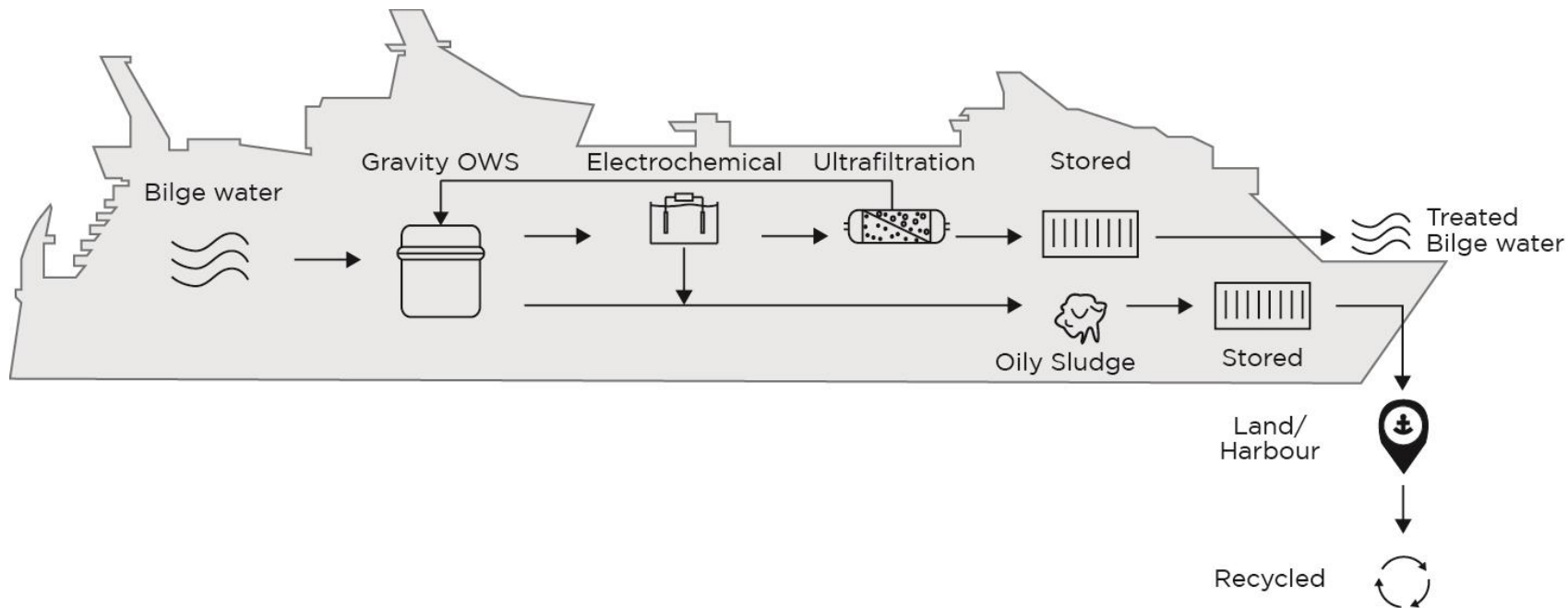

• Newly Build

- Electrochemical treatment
- Recycling of oily sludge on land

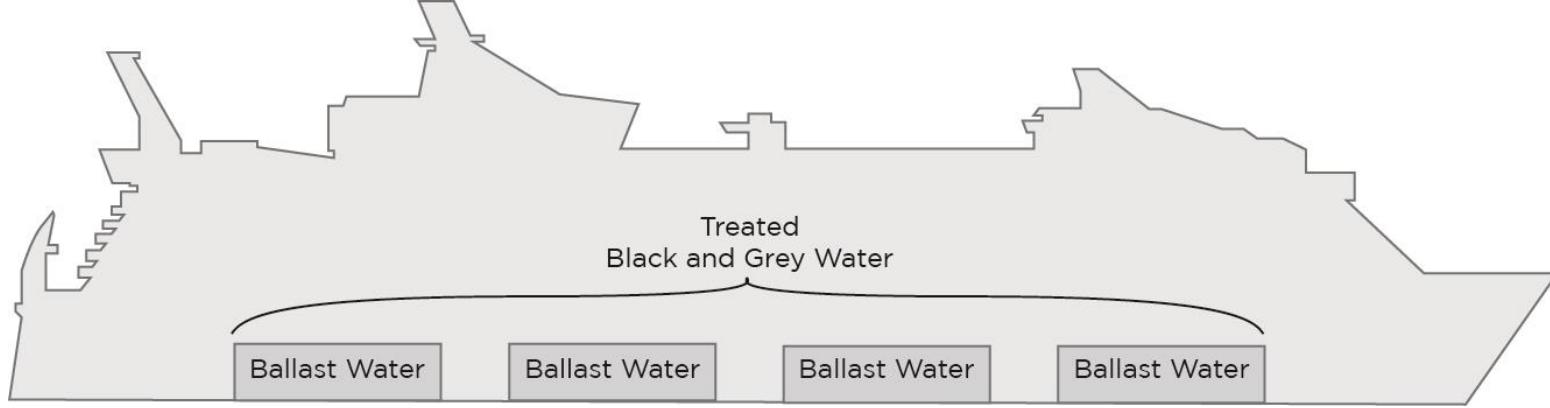

- Retrofit
 - Treated black and grey water as ballast water

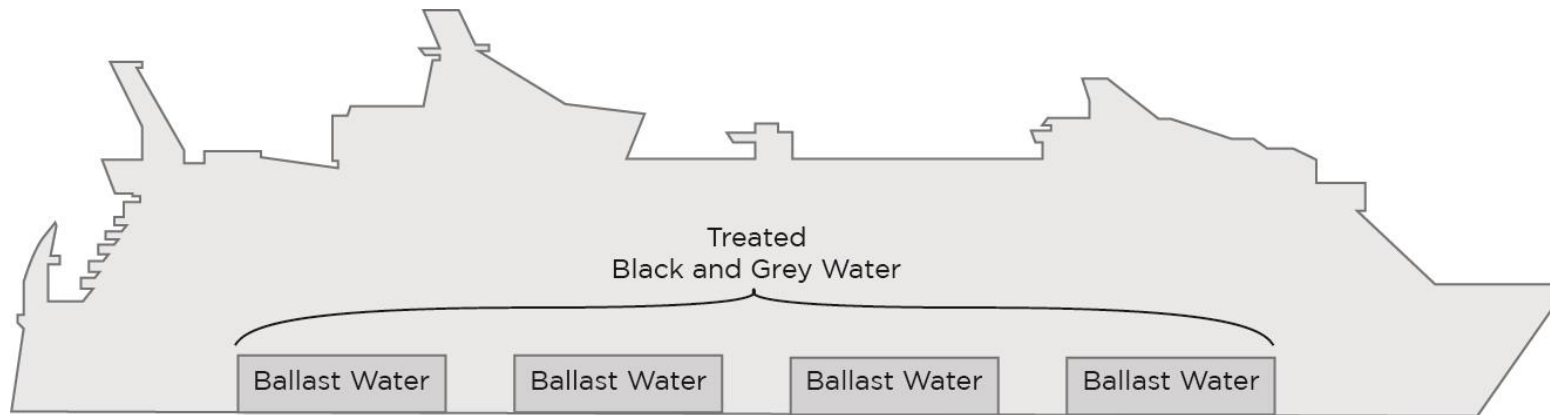

- Newly Build
 - Treated black and grey water as ballast water



Gas

Moss And Fog, (2019)



Fluid

USCG, (n.d.)



Solid

Less Haines, (n.d.)

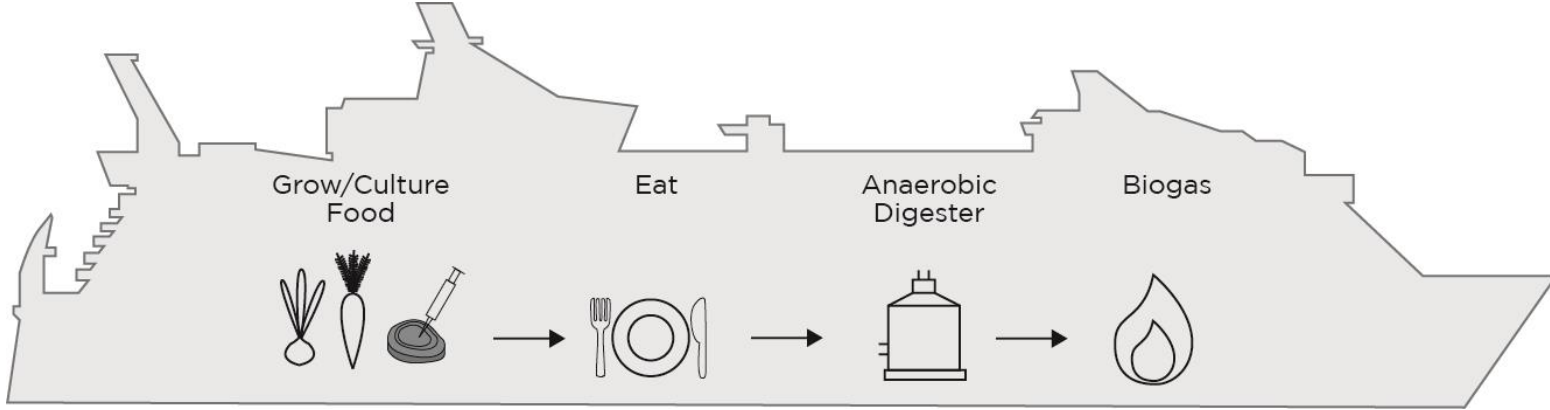

Non-hazardous solid waste

- Newly Build
 - Eliminate explosive use for pleasure
 - Prohibit the burning of hazardous waste
 - Install wet cleaning facilities

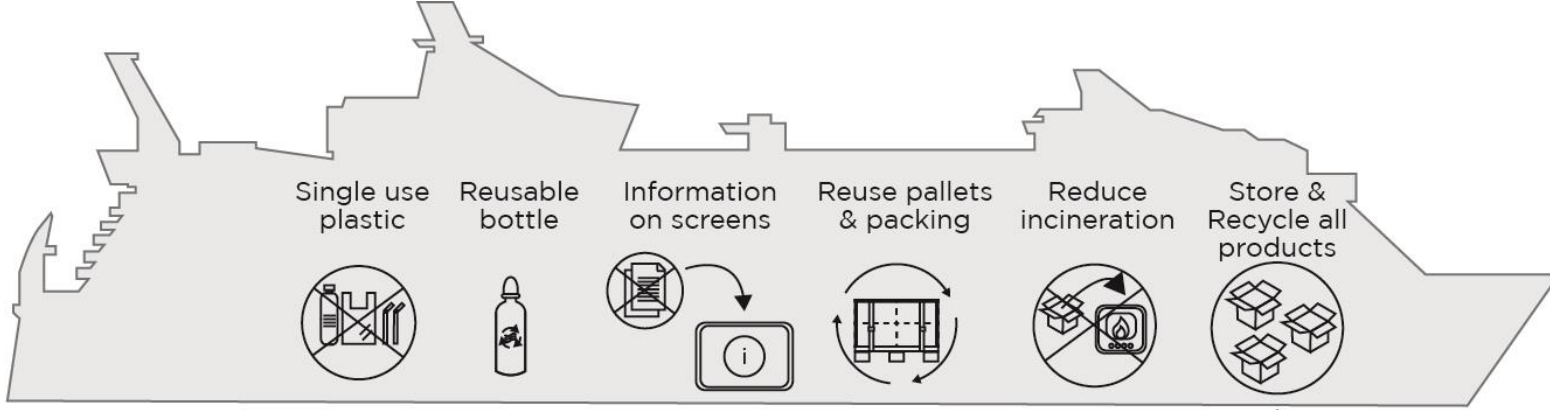

Land/
Harbour

Recycled

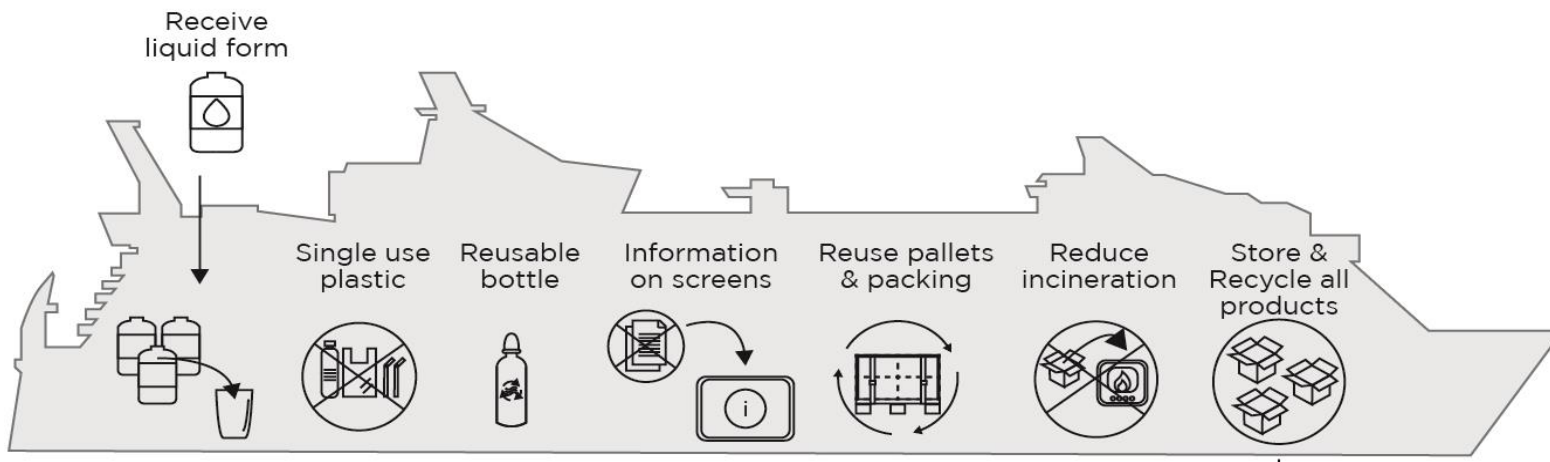

Land/
Harbour

Recycled

• Retrofit

- Eliminate single use plastic
- Give a reusable plastic bottle to every passenger onboard
- Eliminated all the paper information, show everything on screens.
- Reuse packaging and pallets multiple times
- Recycle the products instead of incineration.
- Dispose waste to land where it can be recycled.

• Newly Build

- Receive all the drinks in liquid form and store it in tanks. This eliminates the need for single used glass, plastic and aluminium bottles.

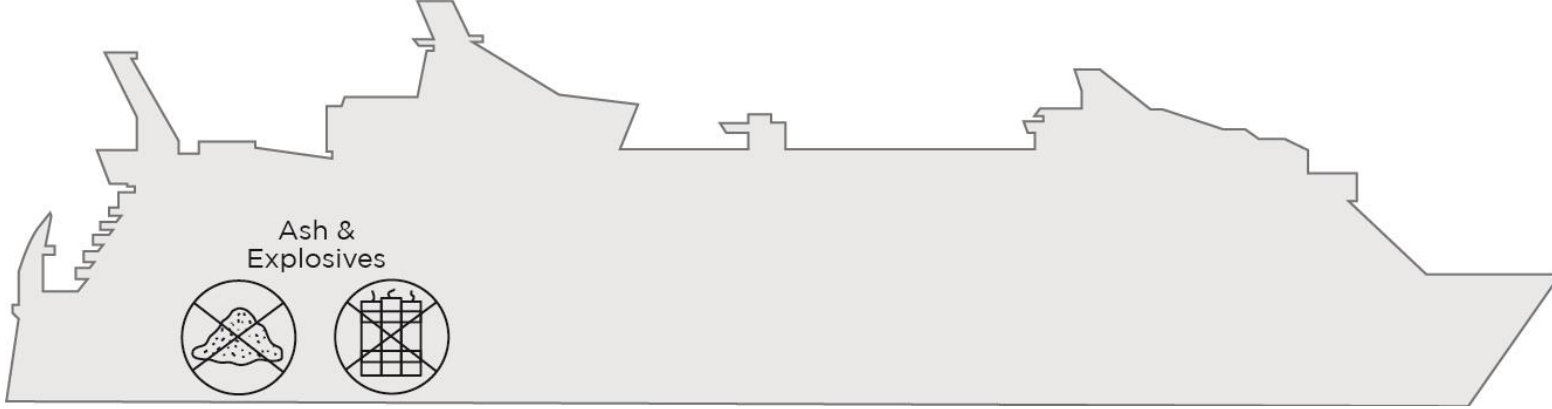

Hazardous solid waste

- Retrofit
 - Eliminate explosive use for pleasure
 - Prohibit the burning of hazardous waste

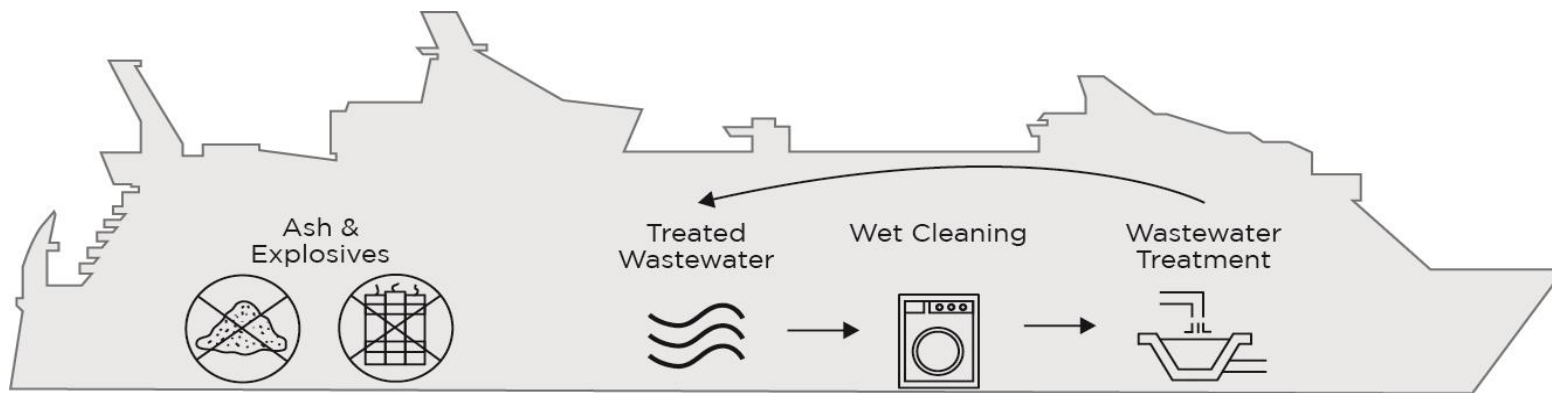

Hazardous solid waste

- Newly Build
 - Eliminate explosive use for pleasure
 - Prohibit the burning of hazardous waste
 - Install wet cleaning facilities

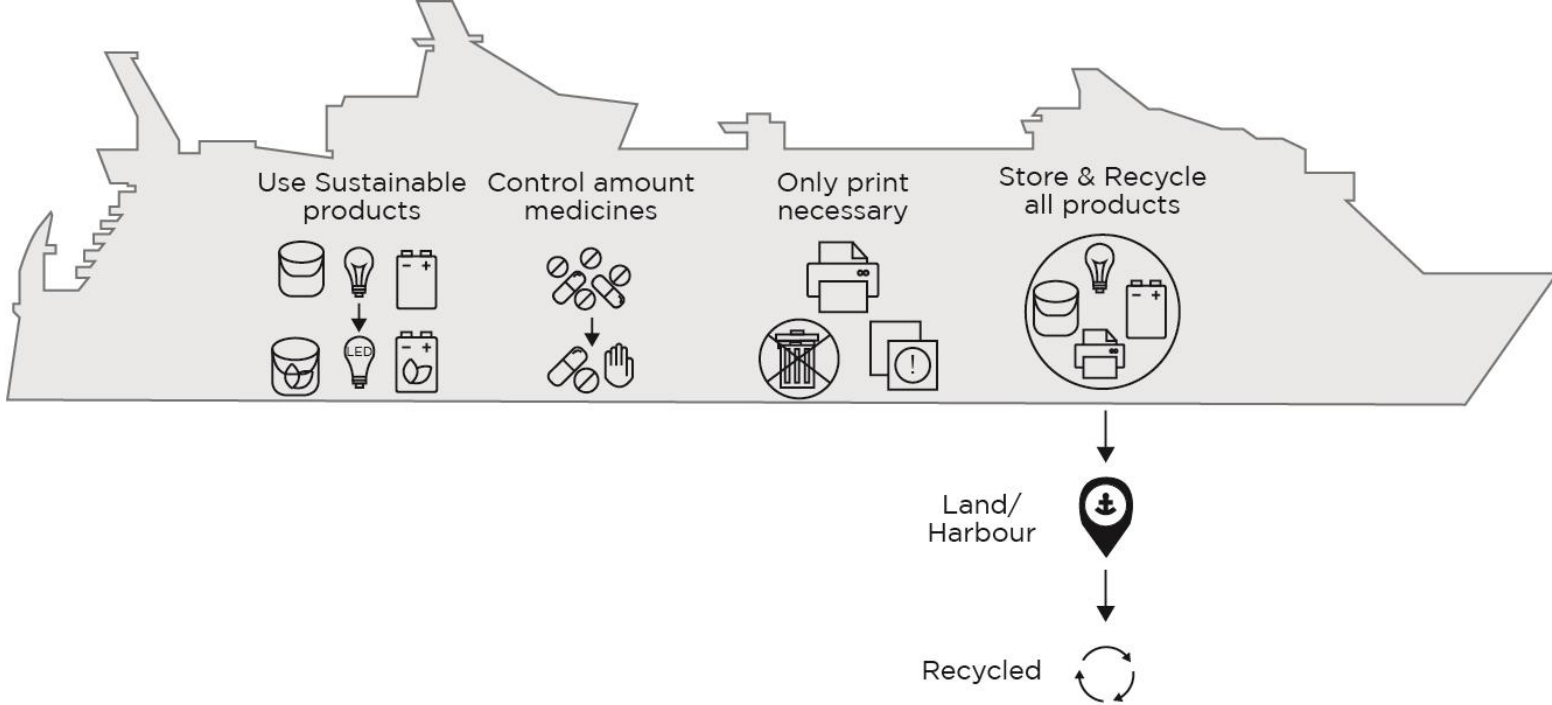

• Retrofit

- Replace the paints, lights, and batteries with sustainable alternatives.
- Only buy the needed amount of pharmaceuticals
- Only print when a hardcopy is needed and pictures are bought.
- Dispose of paint waste, lights, batteries and photo, and printing waste to land where it can be recycled.

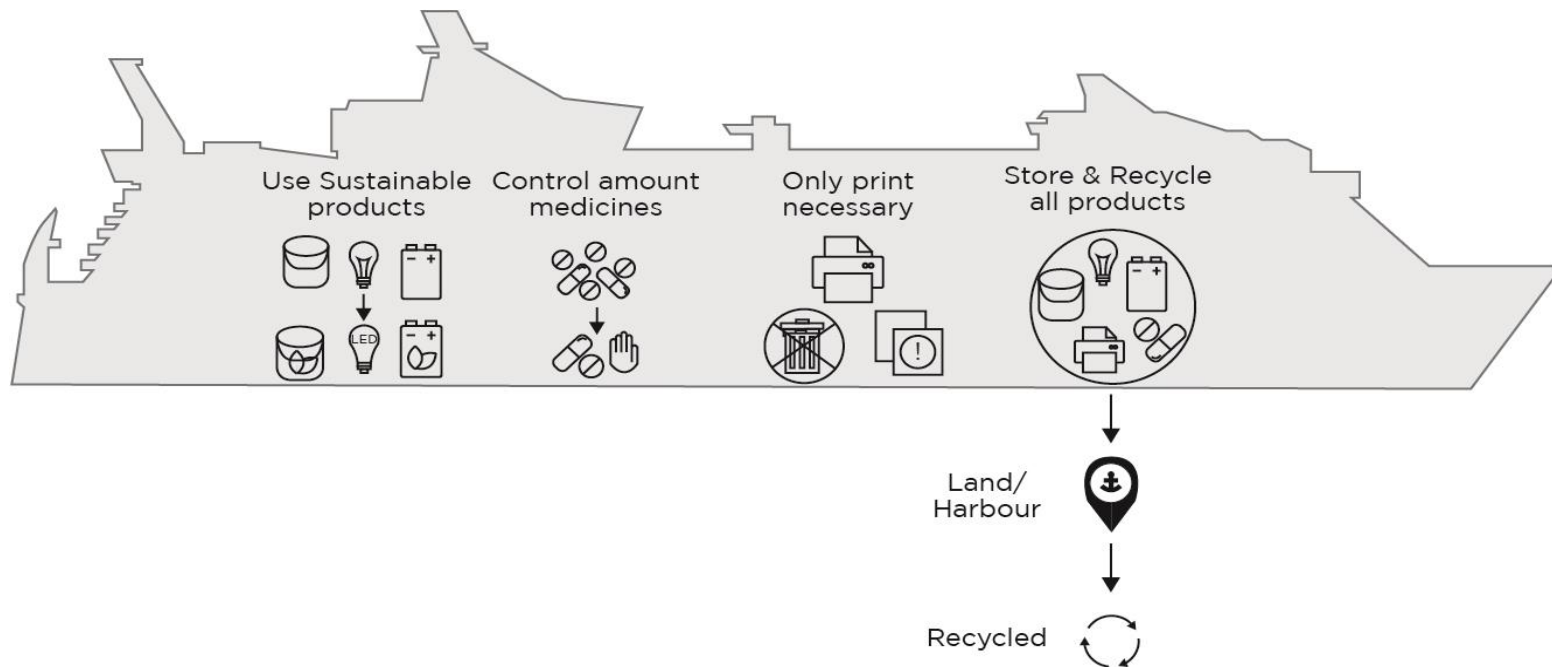

• Newly Build

- Recycling of medical waste

Combination - Retrofit

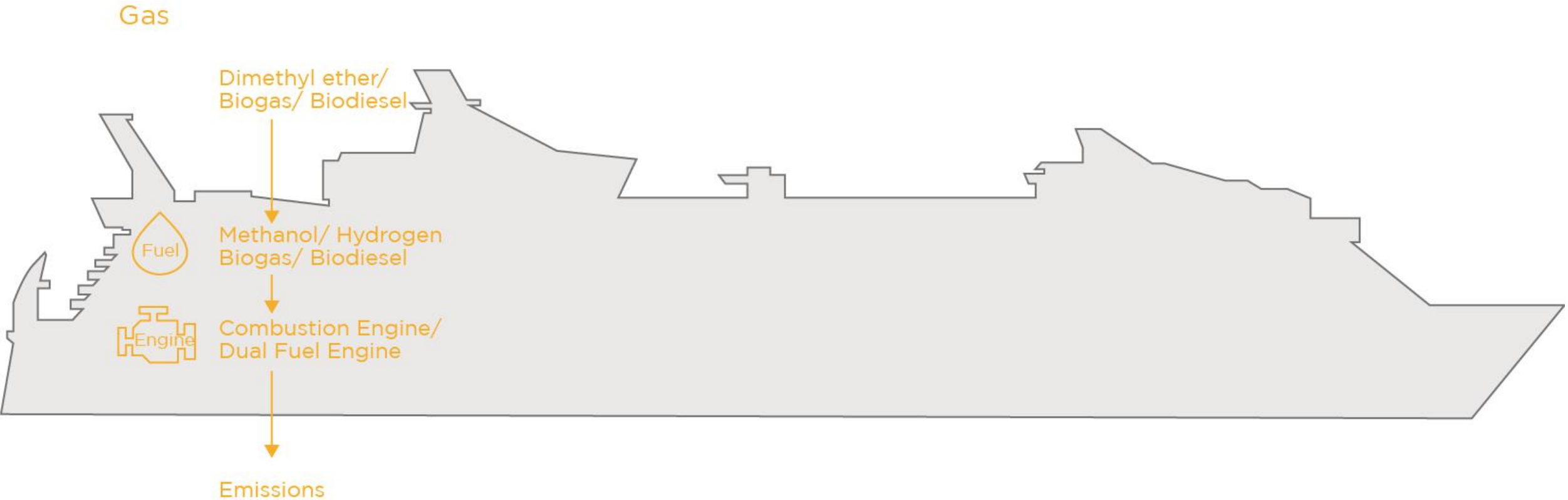

Combination - Retrofit

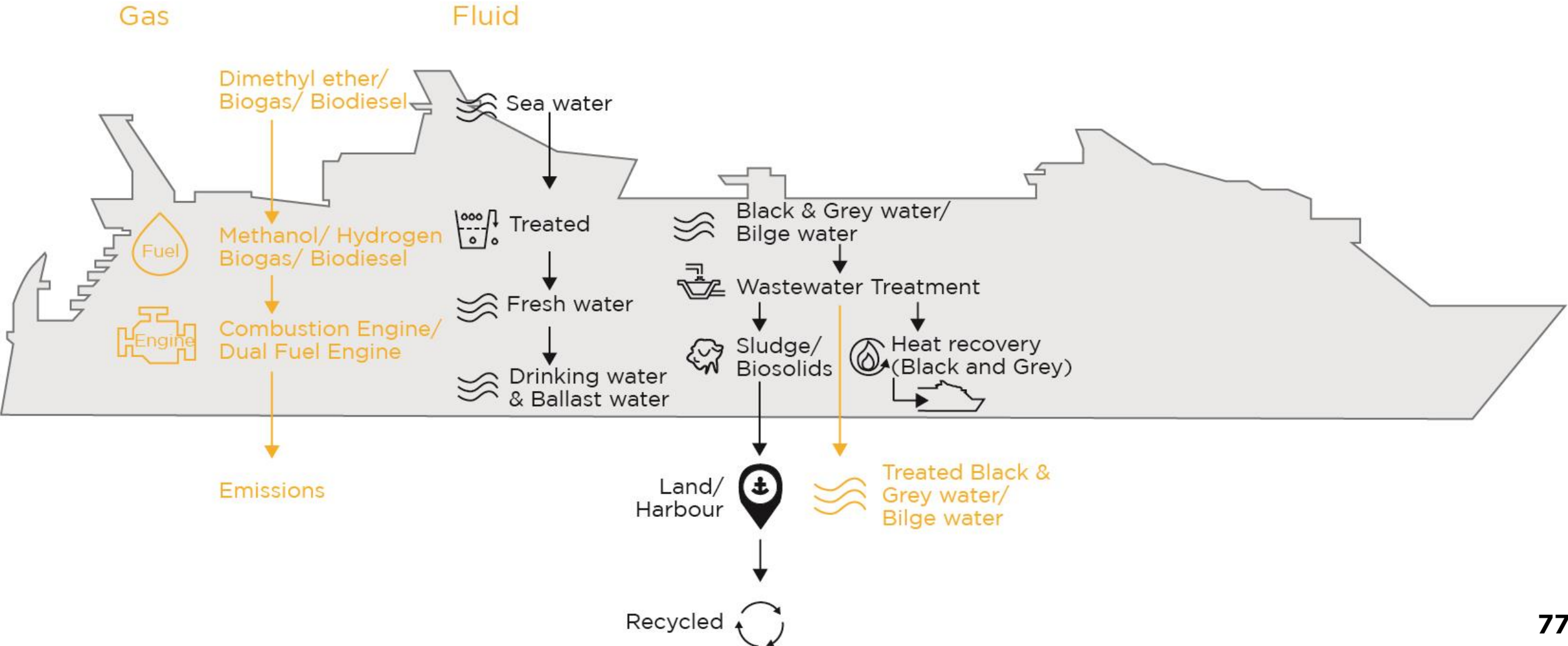

Combination - Retrofit

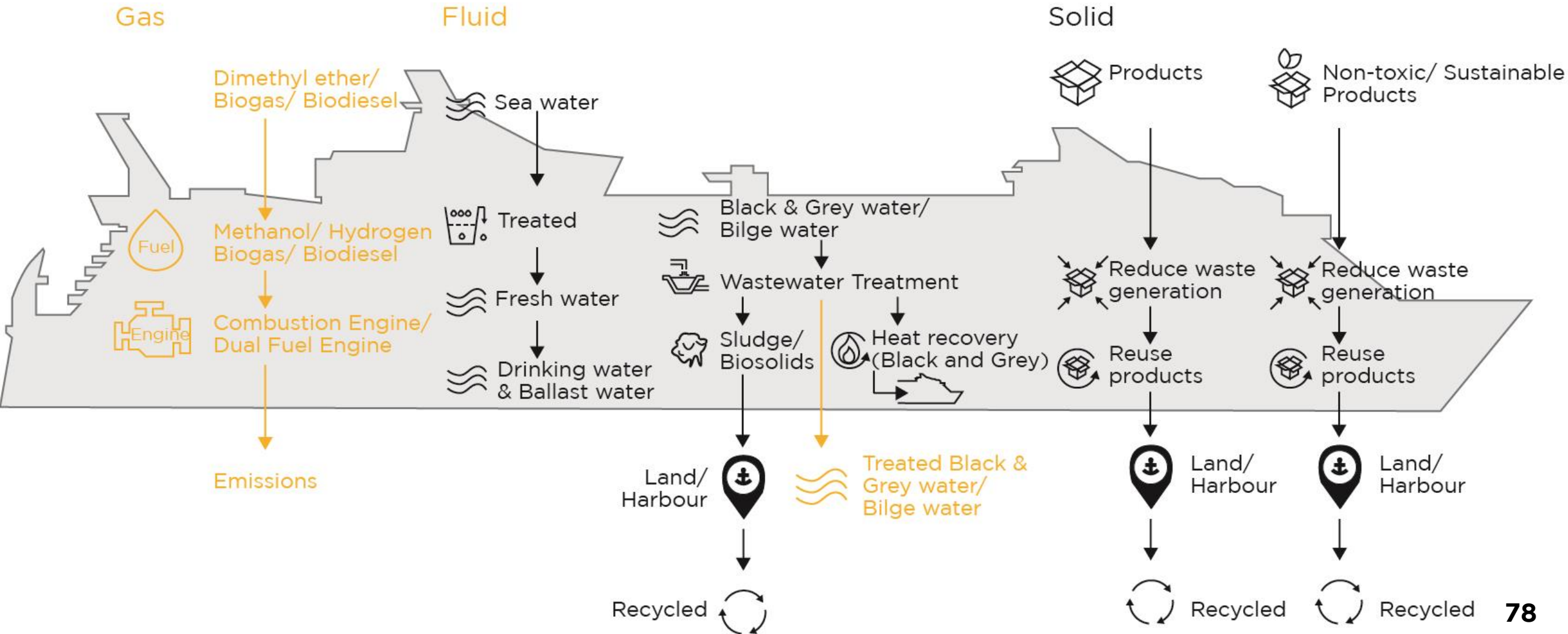

Combination - Newly build

Gas

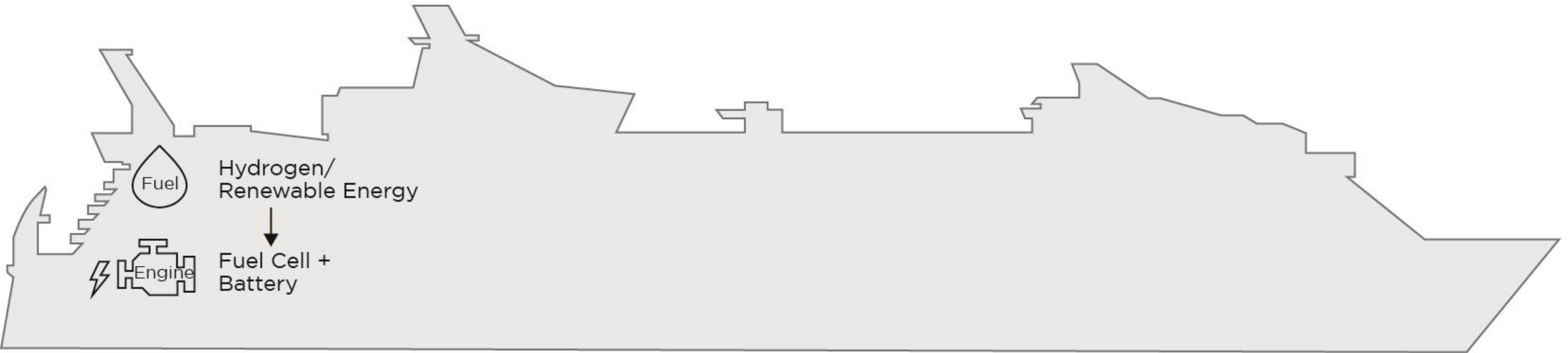

Combination - Newly build

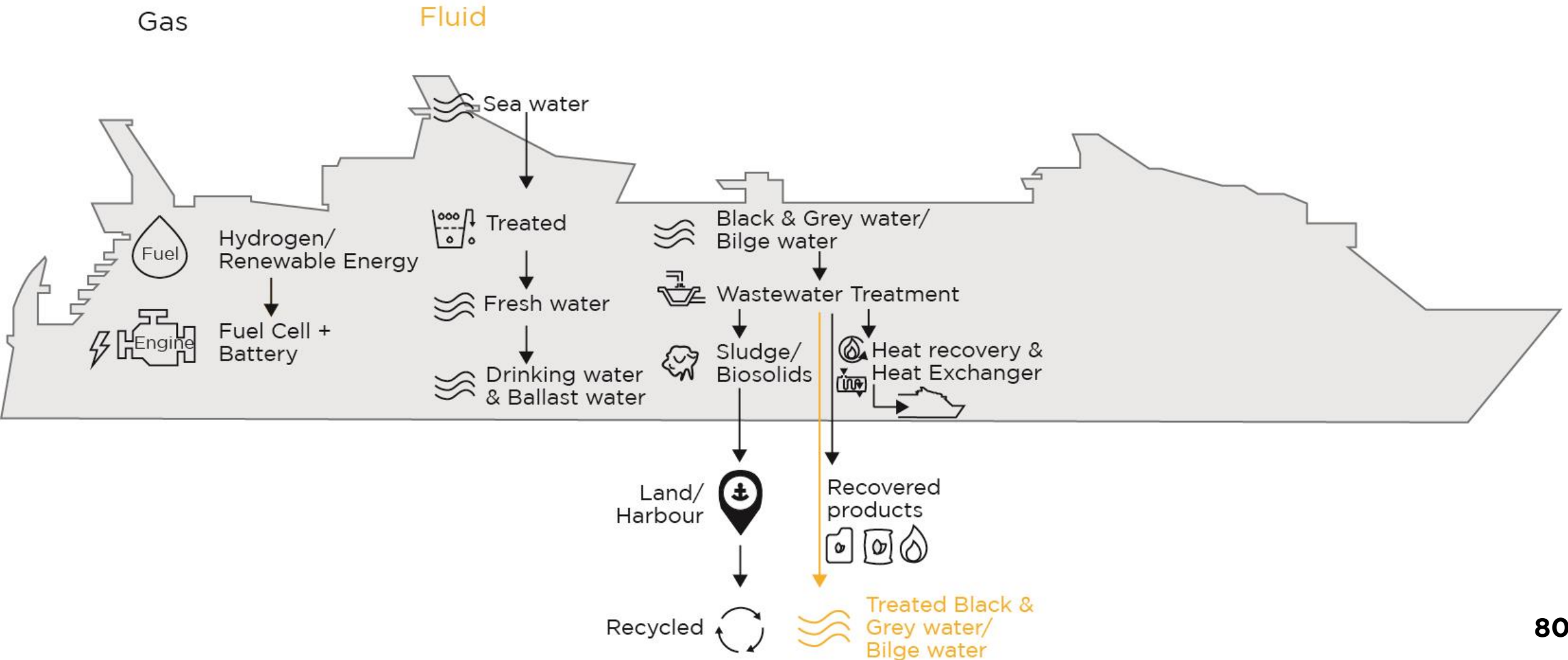

Combination - Newly build

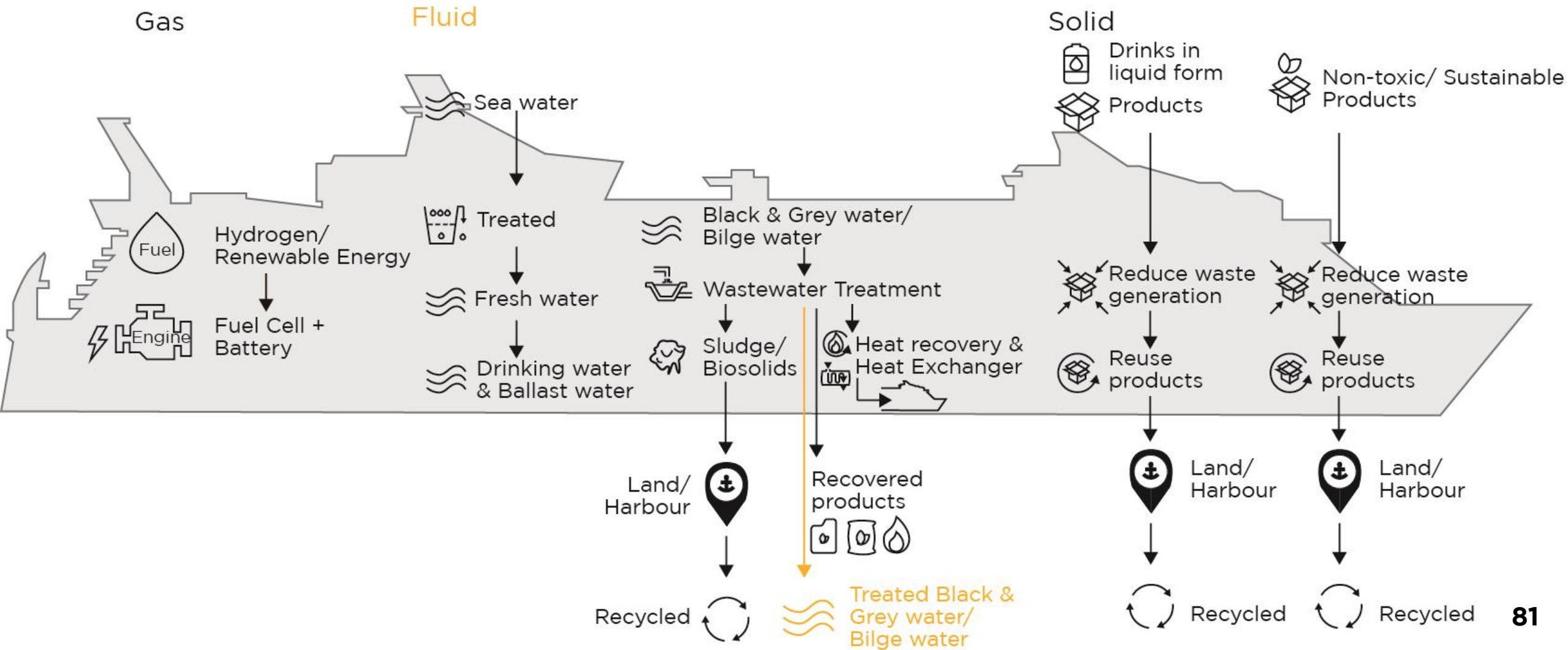

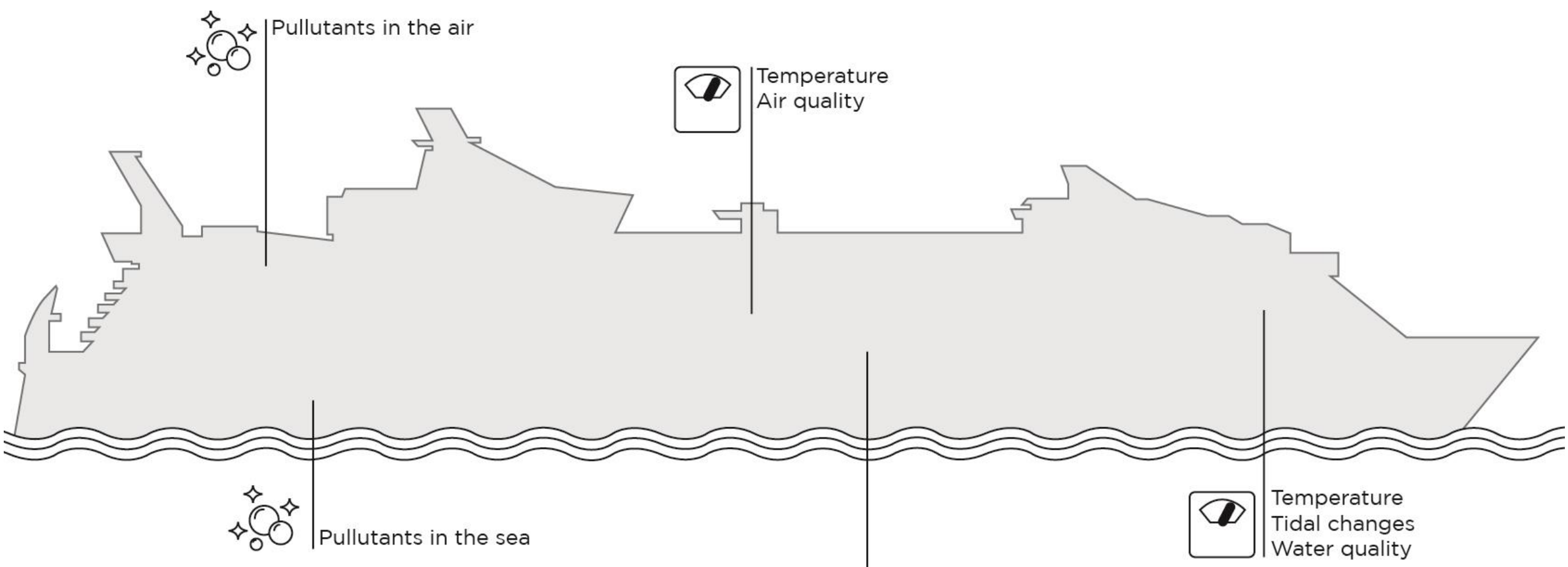

Marine life
Seabed

-  Measure
-  Research
-  Clean

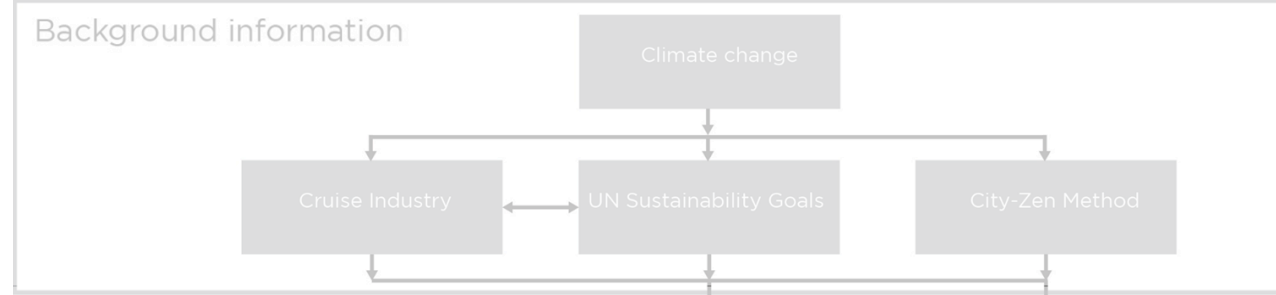

Research Framework

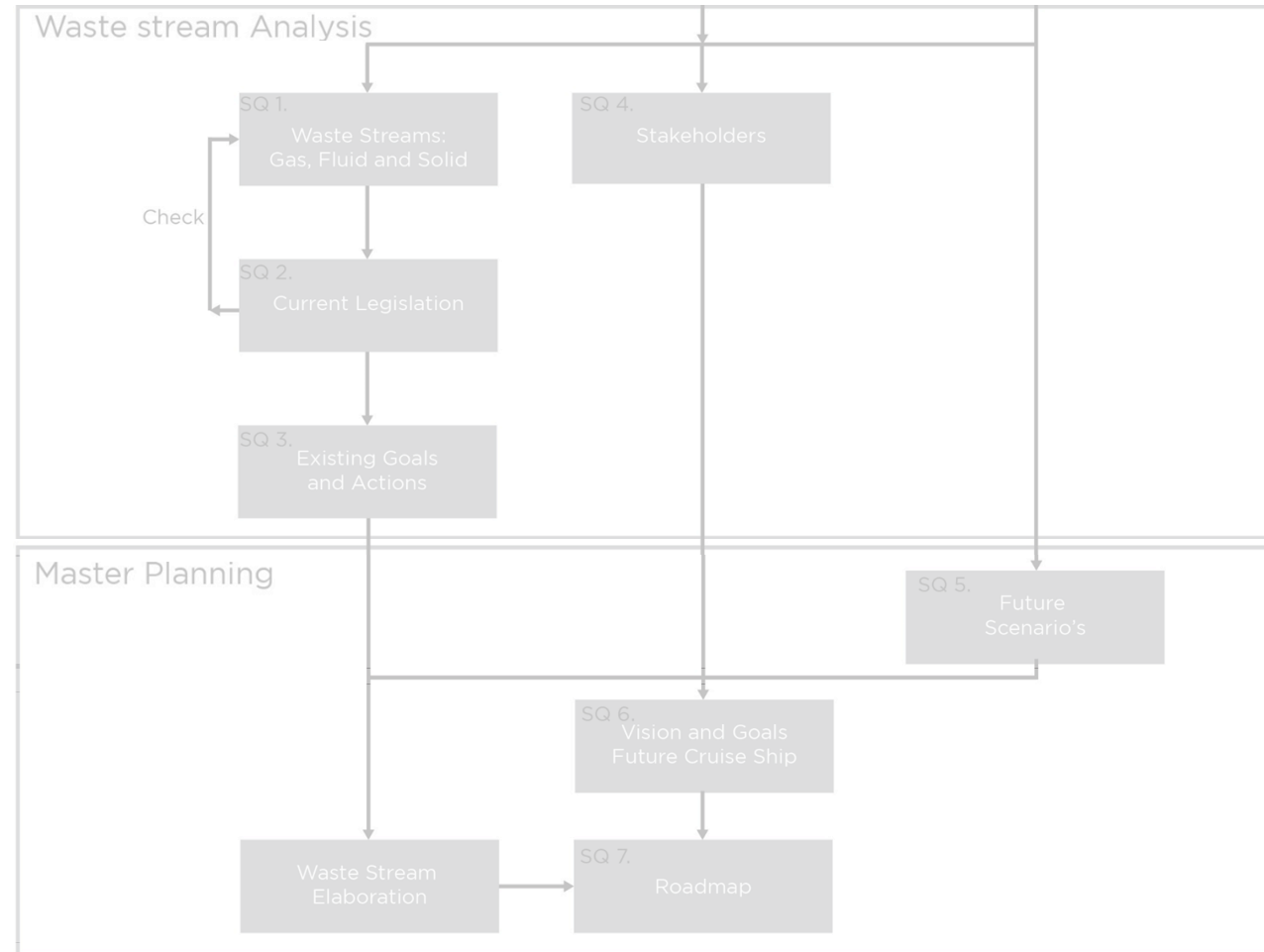

Possible Future Cruise Ship

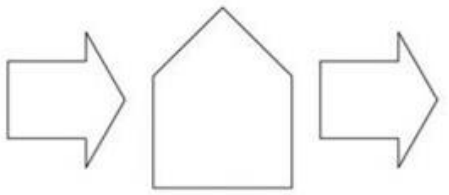

00 Standard Building

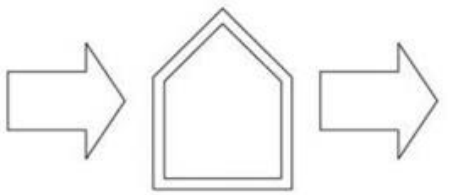

01 Reduce consumption

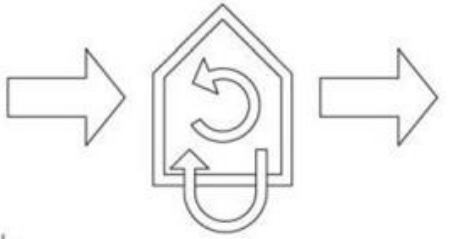

02 Reuse waste energy streams

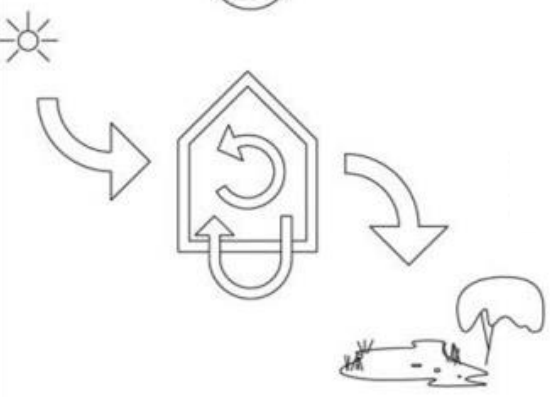

**03a Renewable energy production
for remaining demand**
03b waste = food

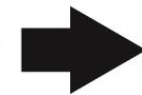
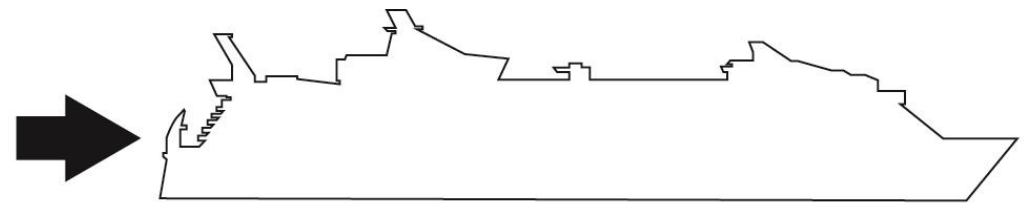
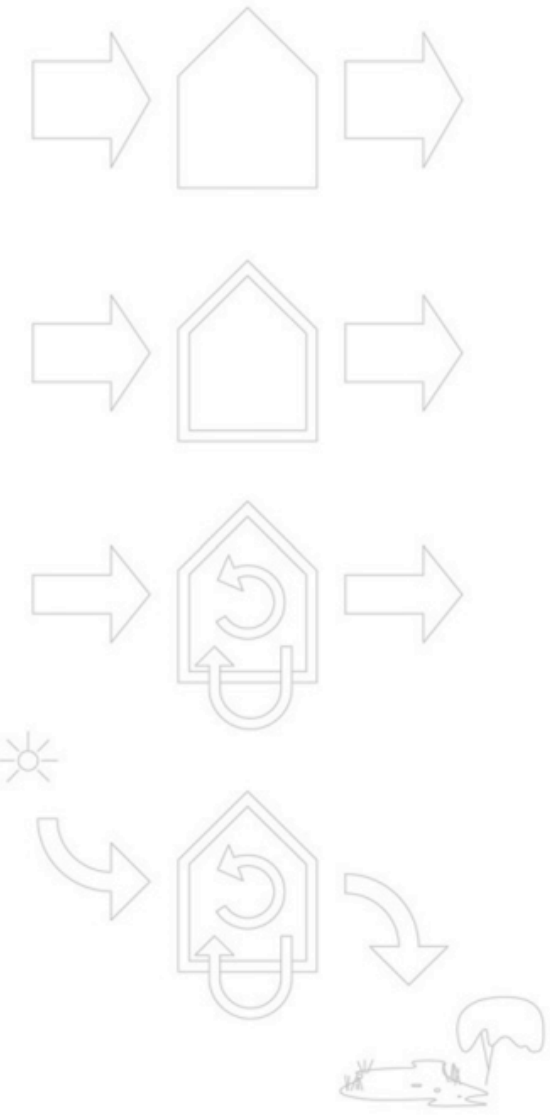

00 Standard Cruise Ship

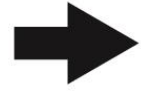
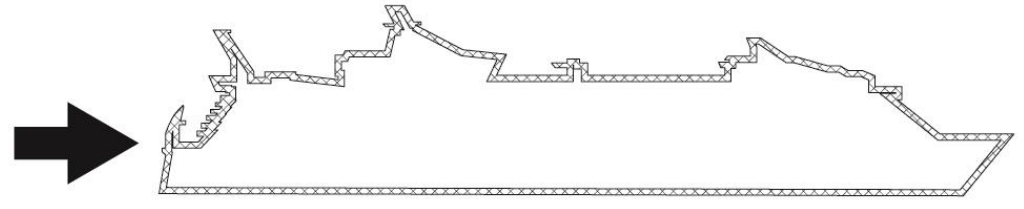

01 Reduce Consumption
-Passive, Smart & Bioclimatic Design

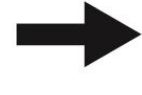
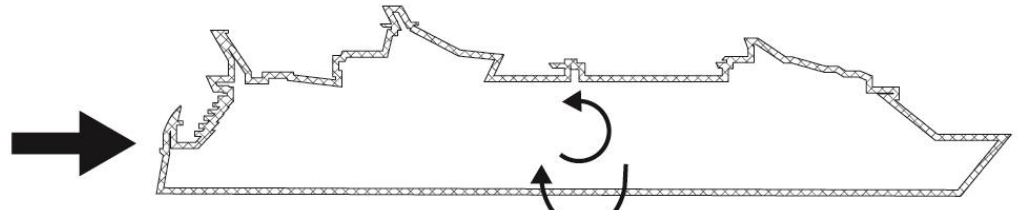

02 Reuse Waste Energy Streams
-waste heat, waste water, waste material
-In closed or Connected Cycles

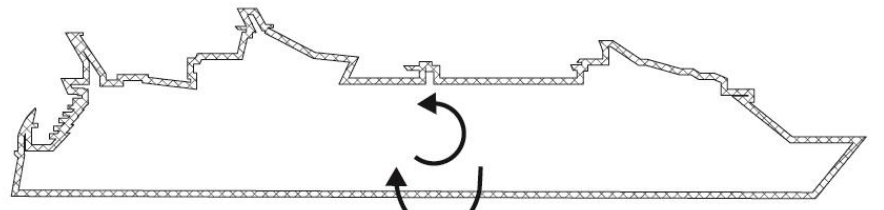
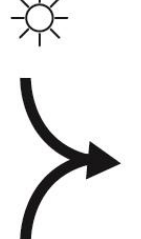

03a Renewable Energy Production for Remaining Demand
03b Waste = Food



BAMB
BUILDINGS AS MATERIAL BANKS



CAMB
CRUISE SHIP AS MATERIAL BANKS



SILVER



BASIC

BRONZE

SILVER

GOLD

PLATINUM



MATERIAL HEALTH



MATERIAL REUTILIZATION



RENEWABLE ENERGY



WATER STEWARDSHIP



SOCIAL FAIRNESS





10km

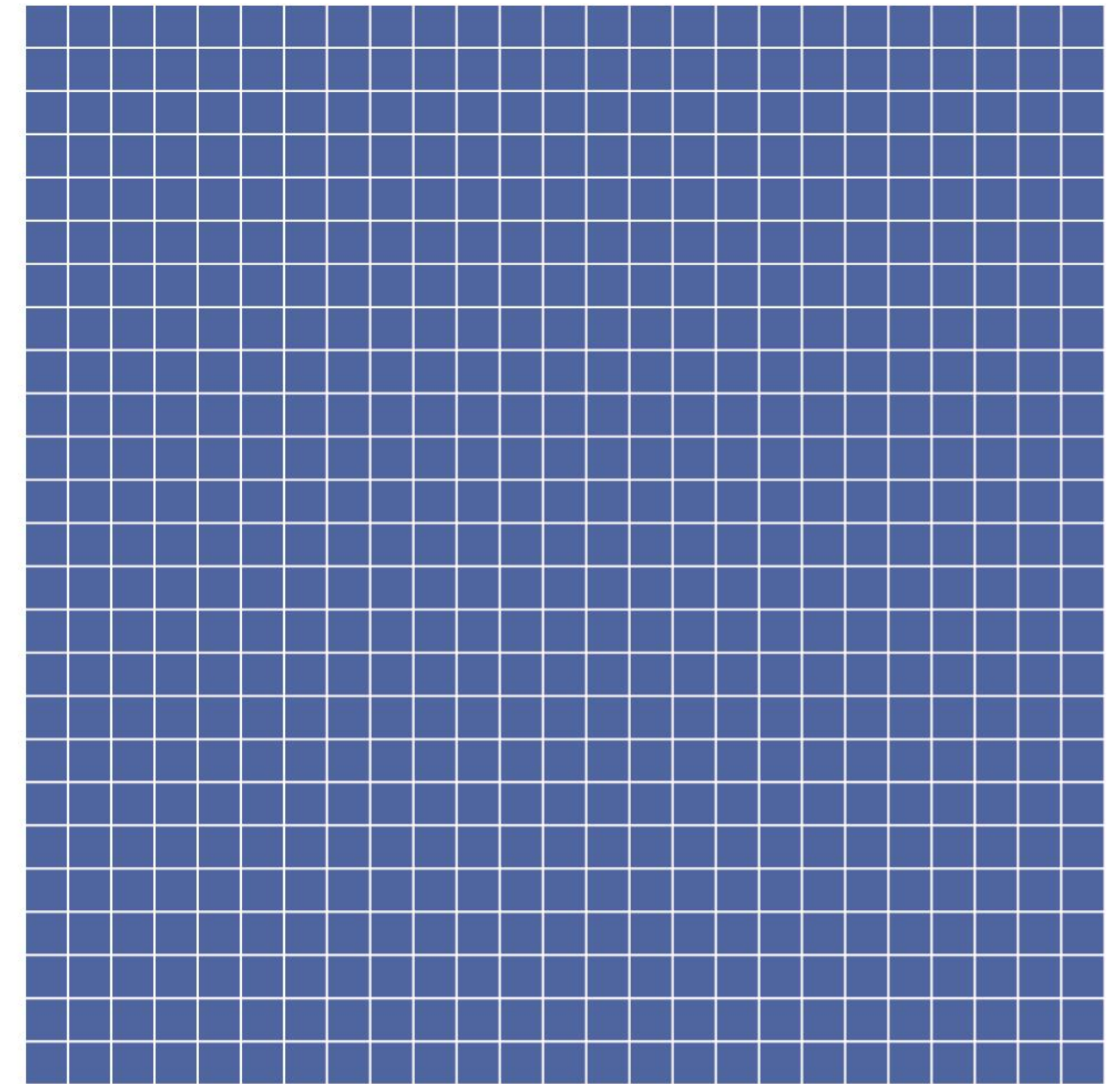

1km

25km



3 times

The sustainable Cruise Ship



NSS 1



NSS 3



NSS 3



NSS 3



NSS 3



NSS 3



Plants



Plants



Newly build

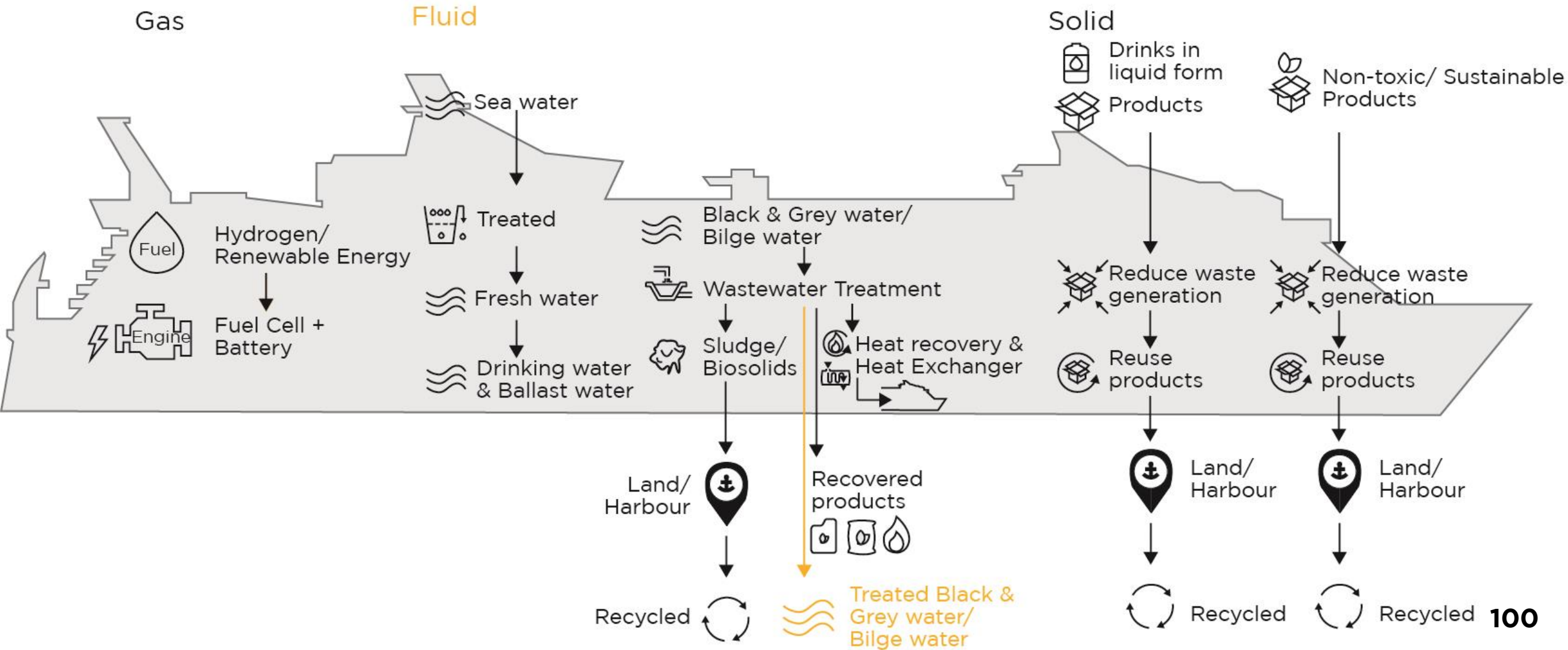



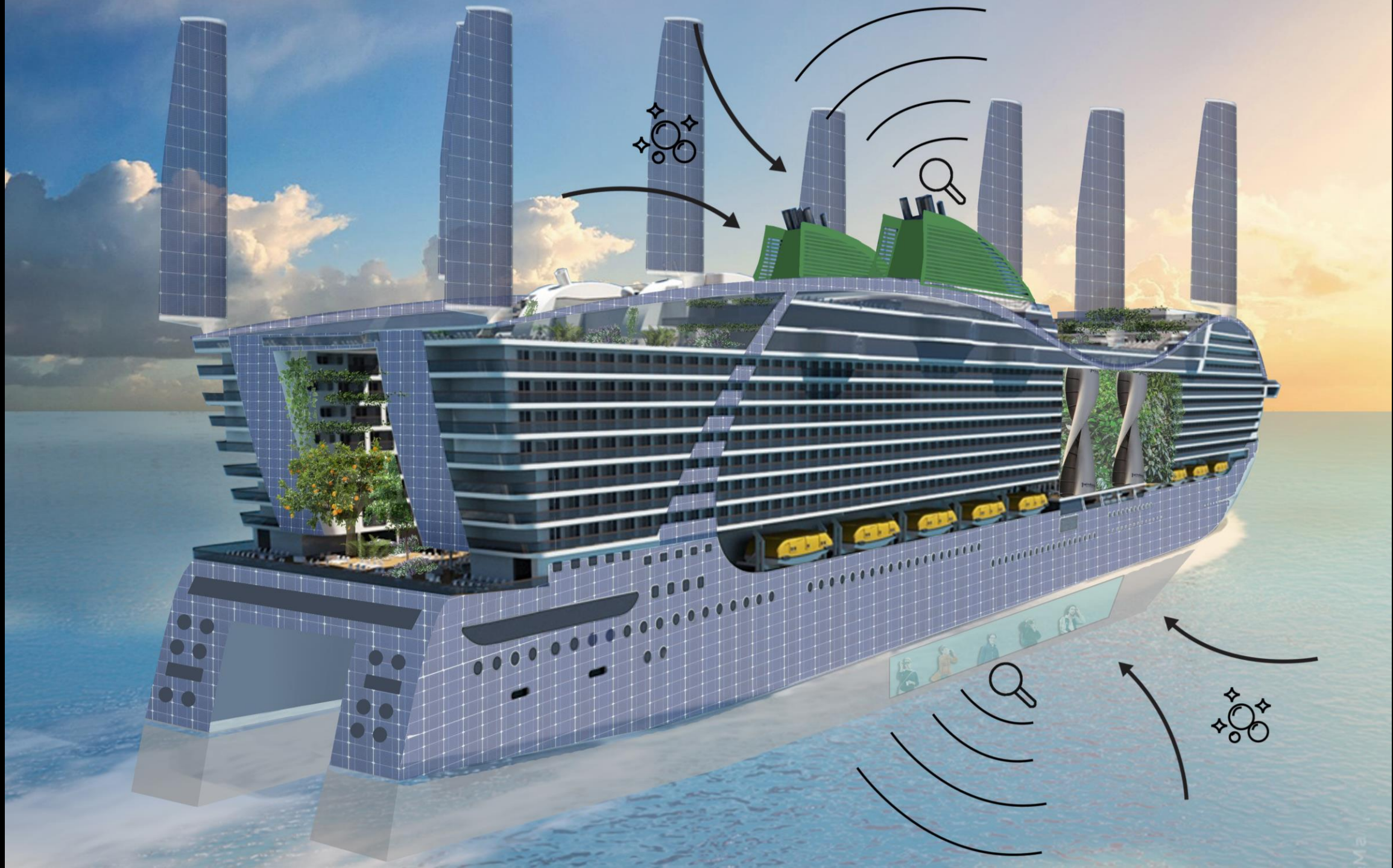



















Warm Climate

| | | |
|---|--|---|
| <p>Cabins</p>  <p>W K E</p> <p>t: 22-9</p> | <p>Restaurant</p>  <p>W K E</p> <p>t: 17-22</p> | <p>Bar</p>  <p>W K E</p> <p>t: 11-01</p> |
| <p>Theatre</p>  <p>W K E</p> <p>t: 17-22</p> | <p>Ice Rink</p>  <p>W K E</p> <p>t: 12-22</p> | <p>Casino</p>  <p>W K E</p> <p>t: 10-03</p> |
| <p>Arcade</p>  <p>W K E</p> <p>t: 10-22</p> | <p>Solarium</p>  <p>W K E</p> <p>t: 9-18</p> | <p>Atrium/ walkways</p>  <p>W K E</p> <p>t: 24/7</p> |
| <p>Pools</p>  <p>W K E</p> <p>t: 7-23</p> | <p>Gym</p>  <p>W K E</p> <p>t: 6-24</p> | <p>Spa</p>  <p>W K E</p> <p>t: 7-22</p> |
| <p>Shops</p>  <p>W K E</p> <p>t: 10-23</p> | <p>Play rooms</p>  <p>W K E</p> <p>t: 9-20</p> | <p>Food Storage</p>  <p>W K E</p> <p>t: 24/7</p> |

Warm Climate

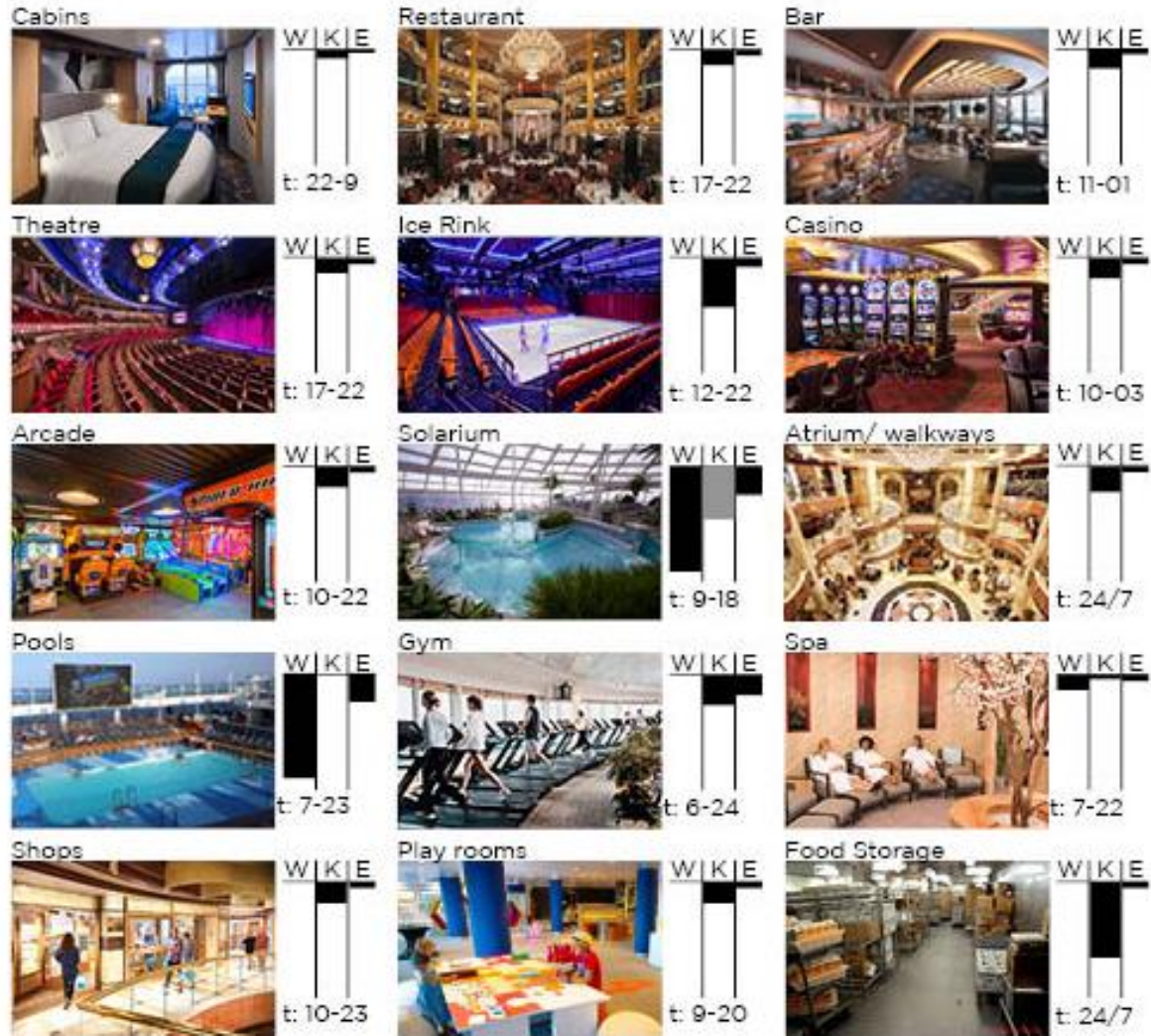

Warm Climate

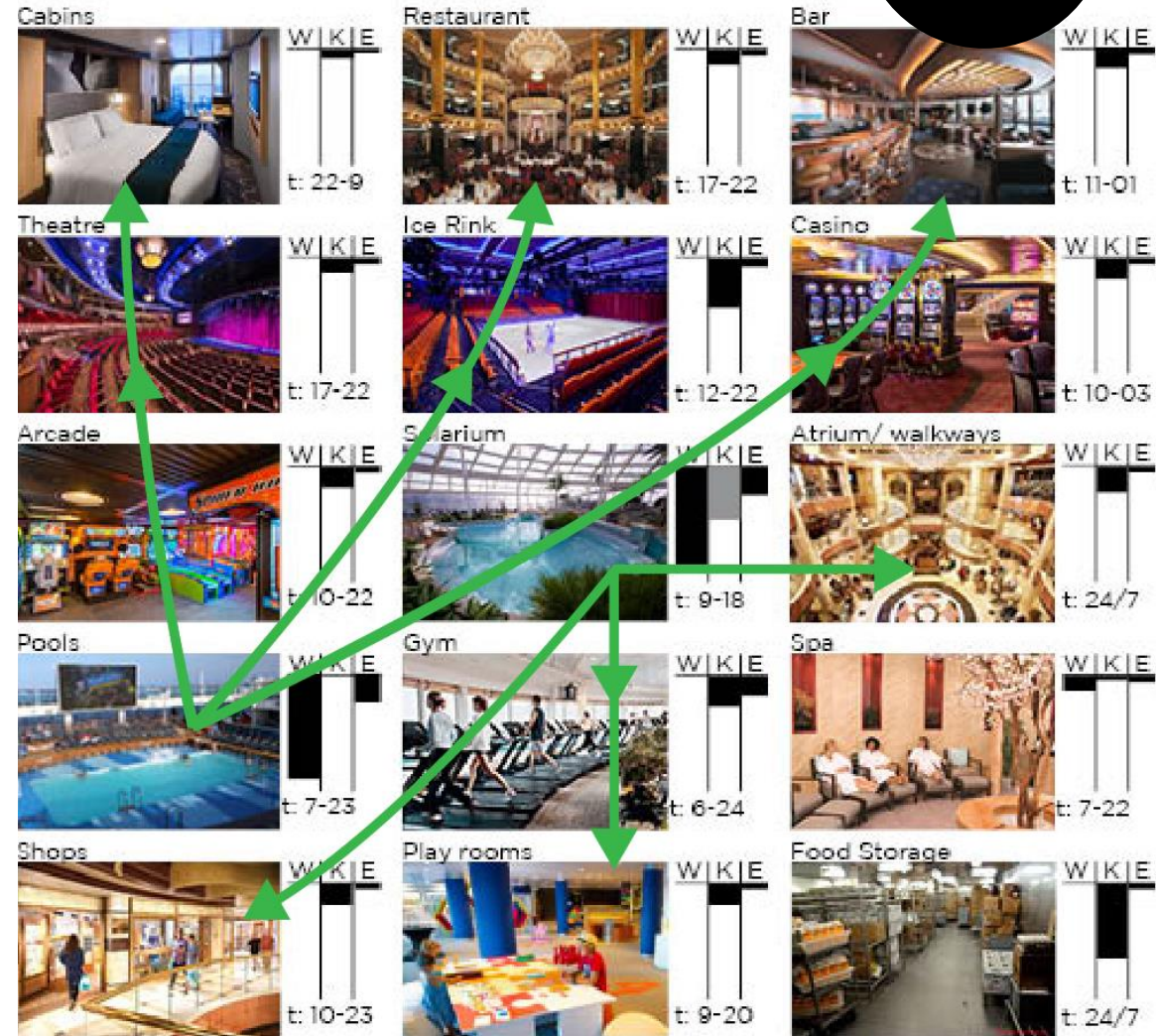

NSS 2



NSS 2

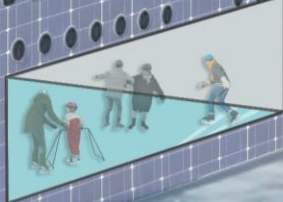



Food



NSS 3

Bolidt.

110



Fluid

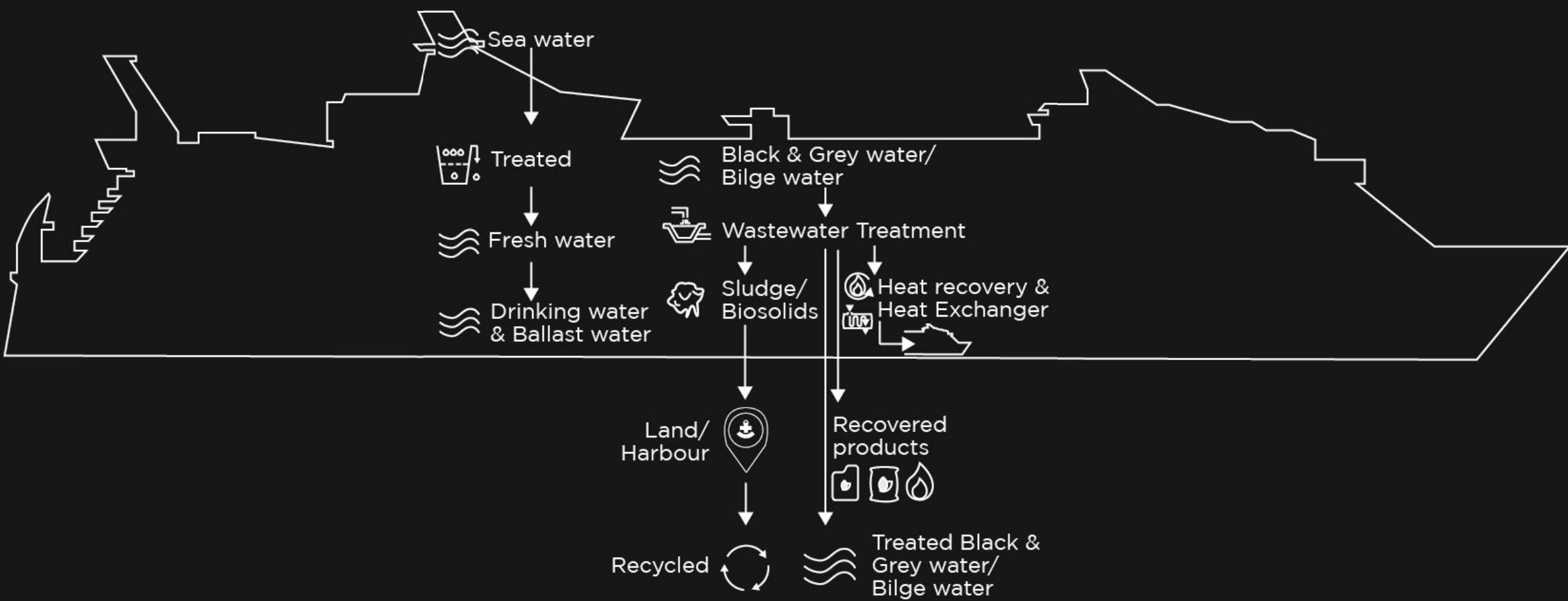

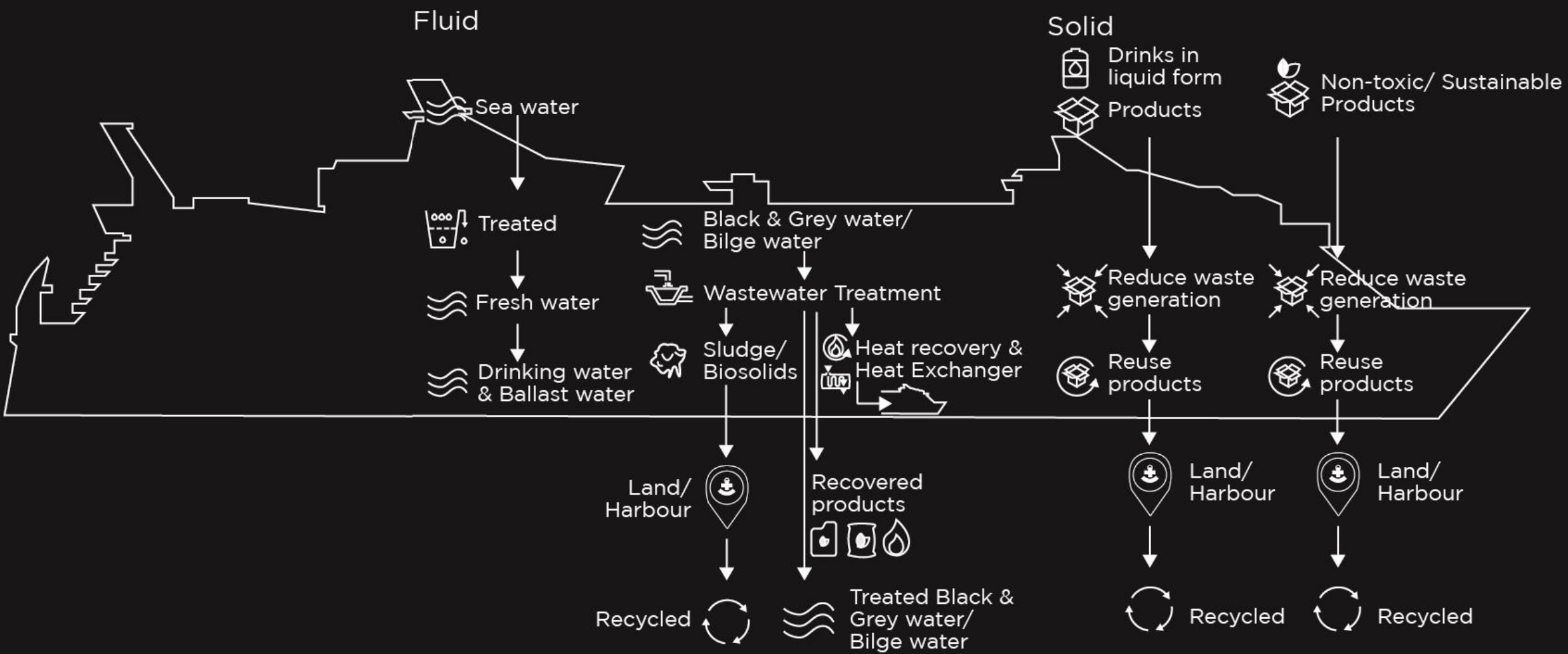

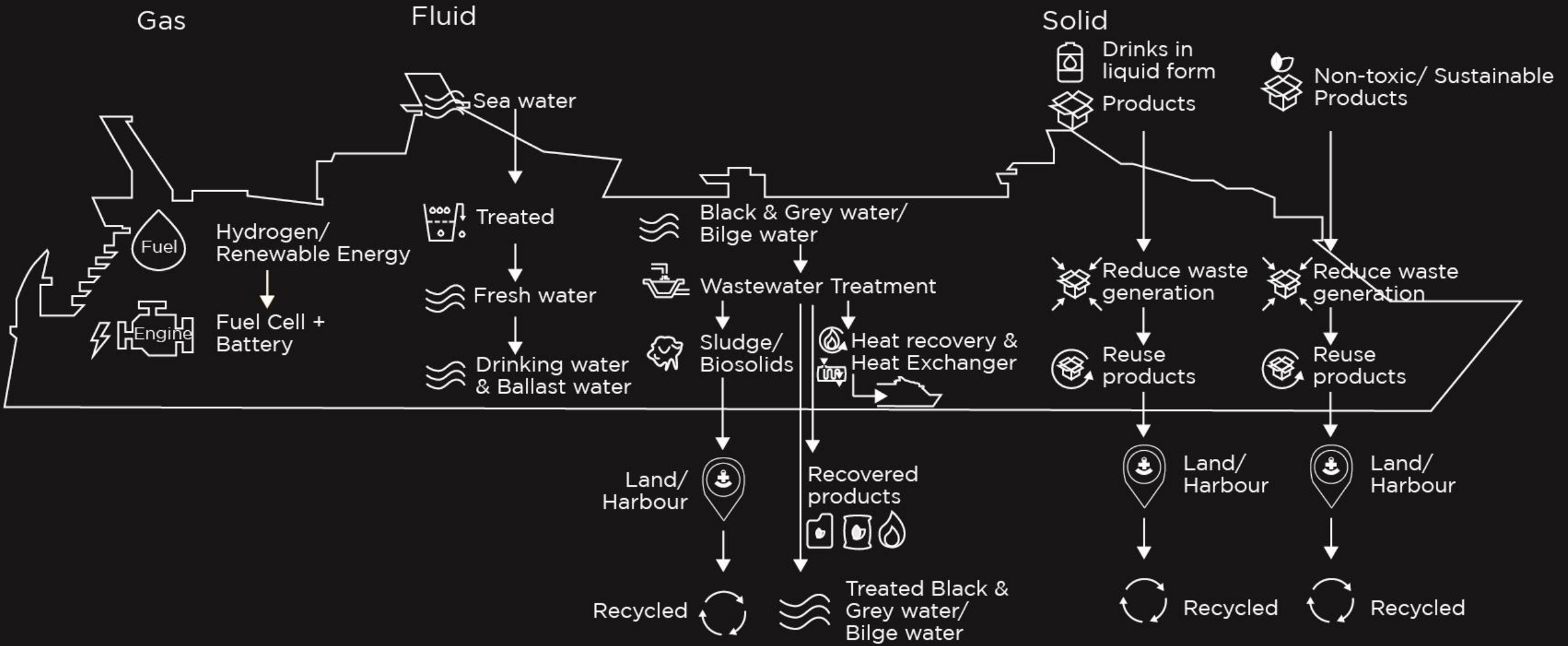



Trajkovska (2019).



u/RPBot (2018).



