

GROUND FLOOR
1:100

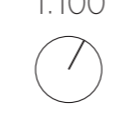

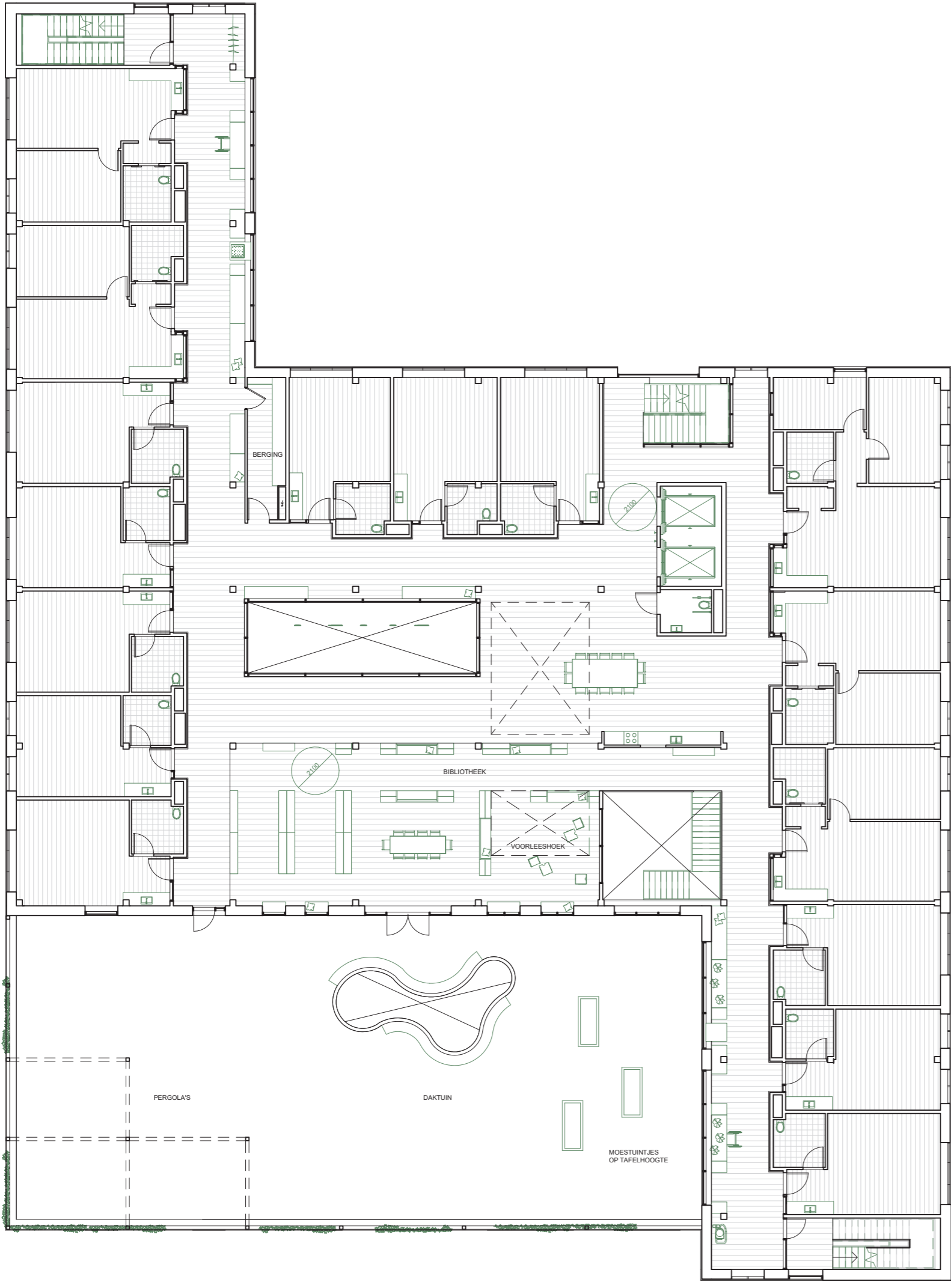

FIRST FLOOR
1:200



SECOND FLOOR
1:200

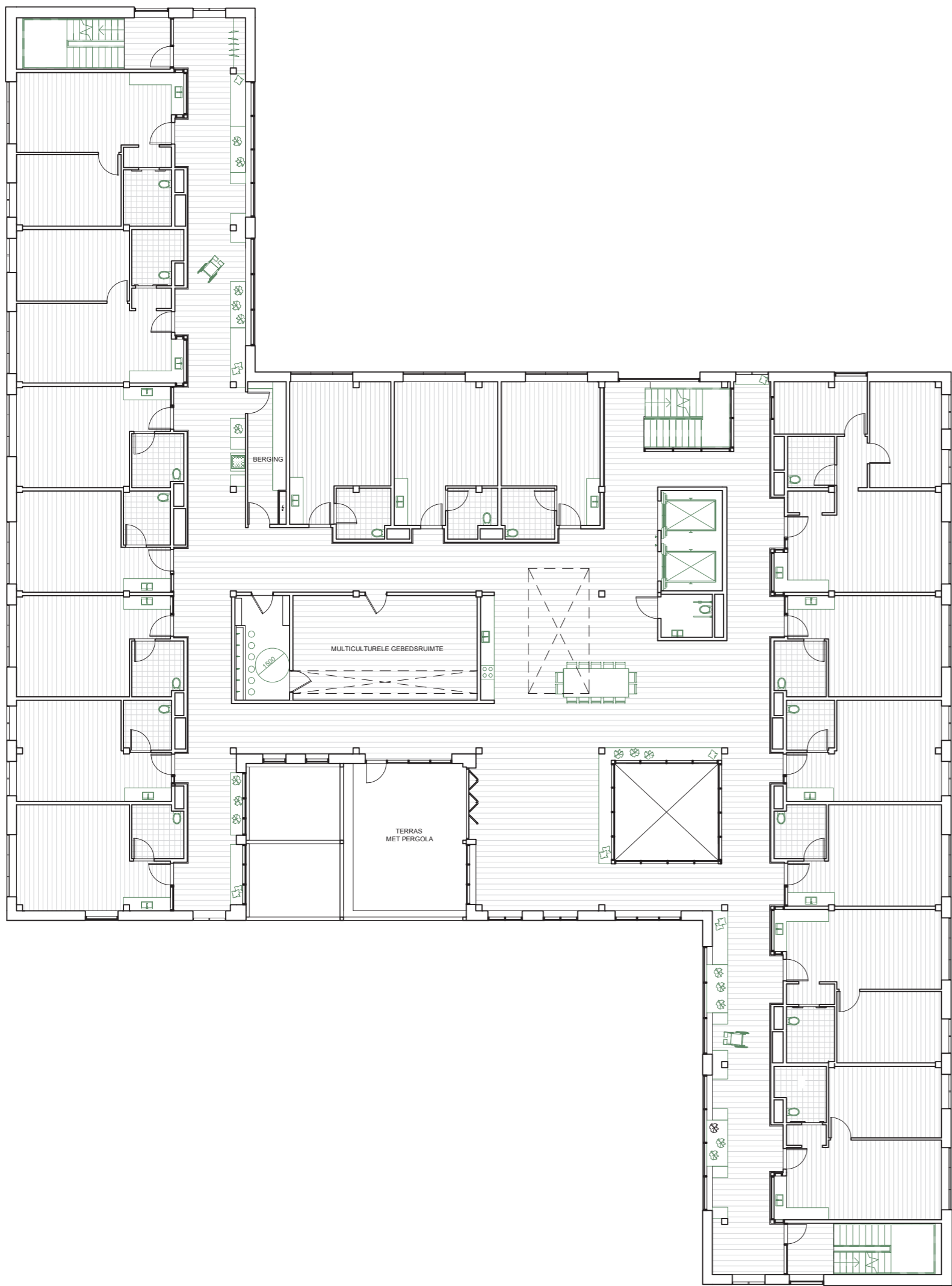

THIRD FLOOR
1:200

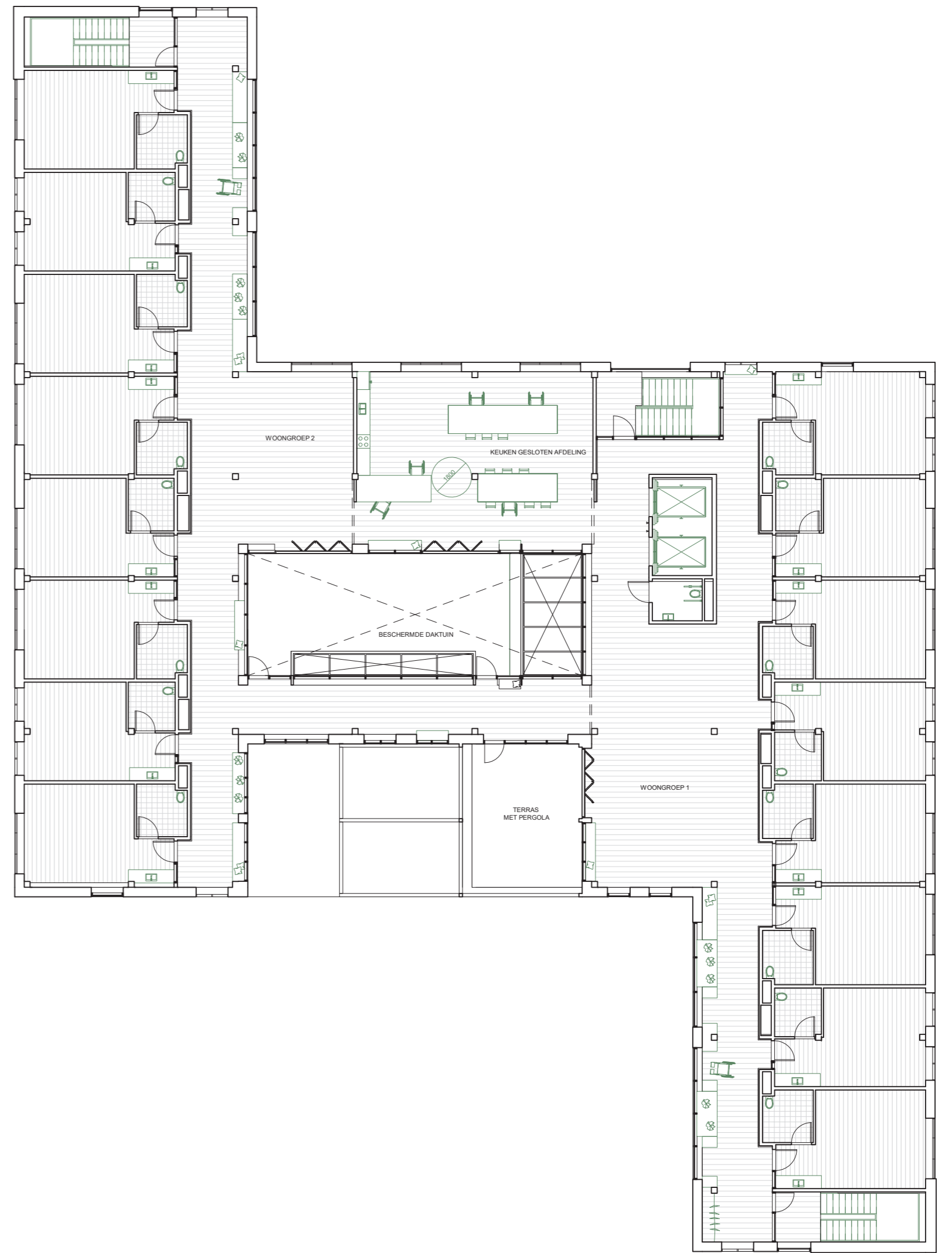

FOURTH FLOOR
1:200



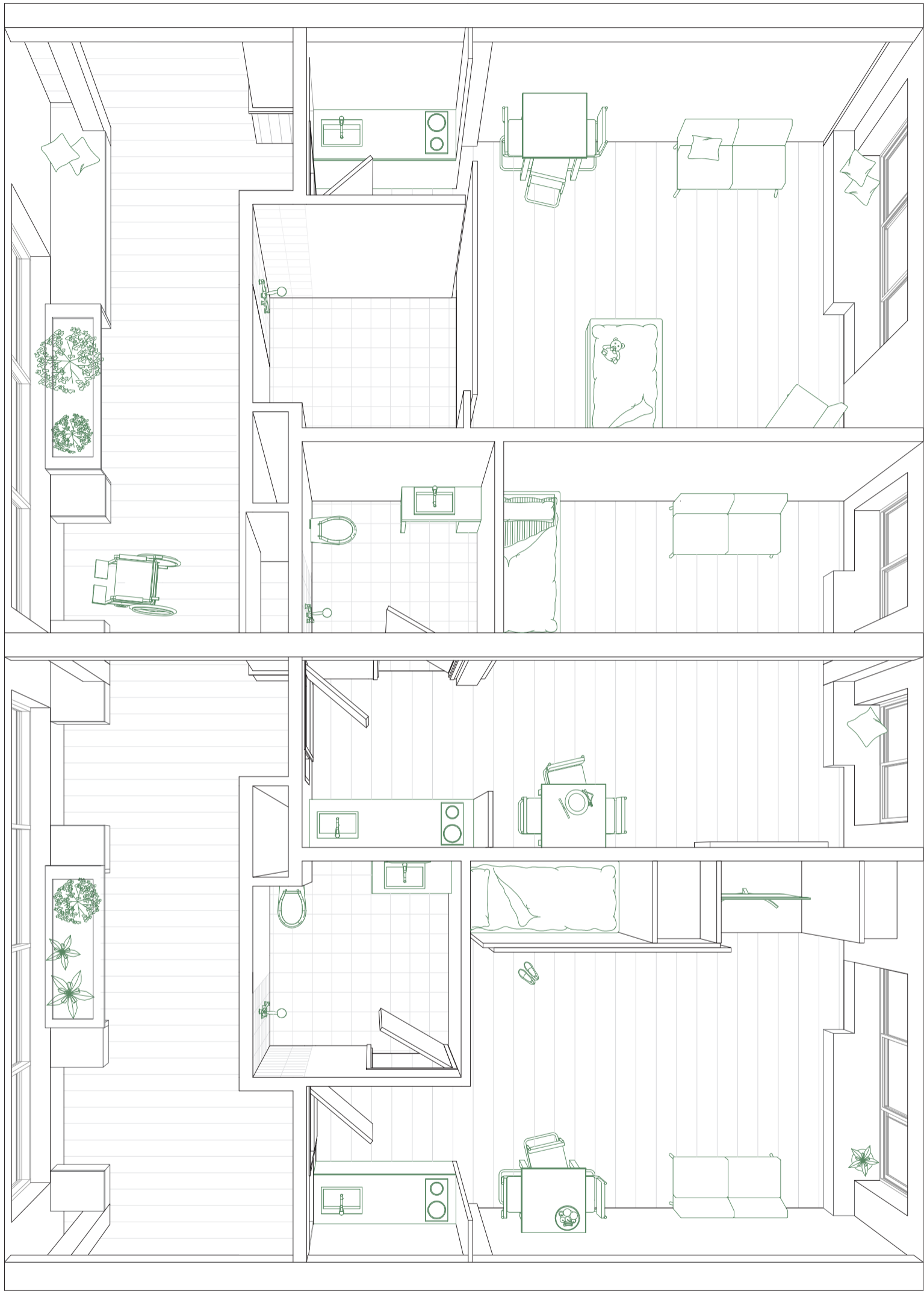

FLOOR PLAN 30M²
1:50

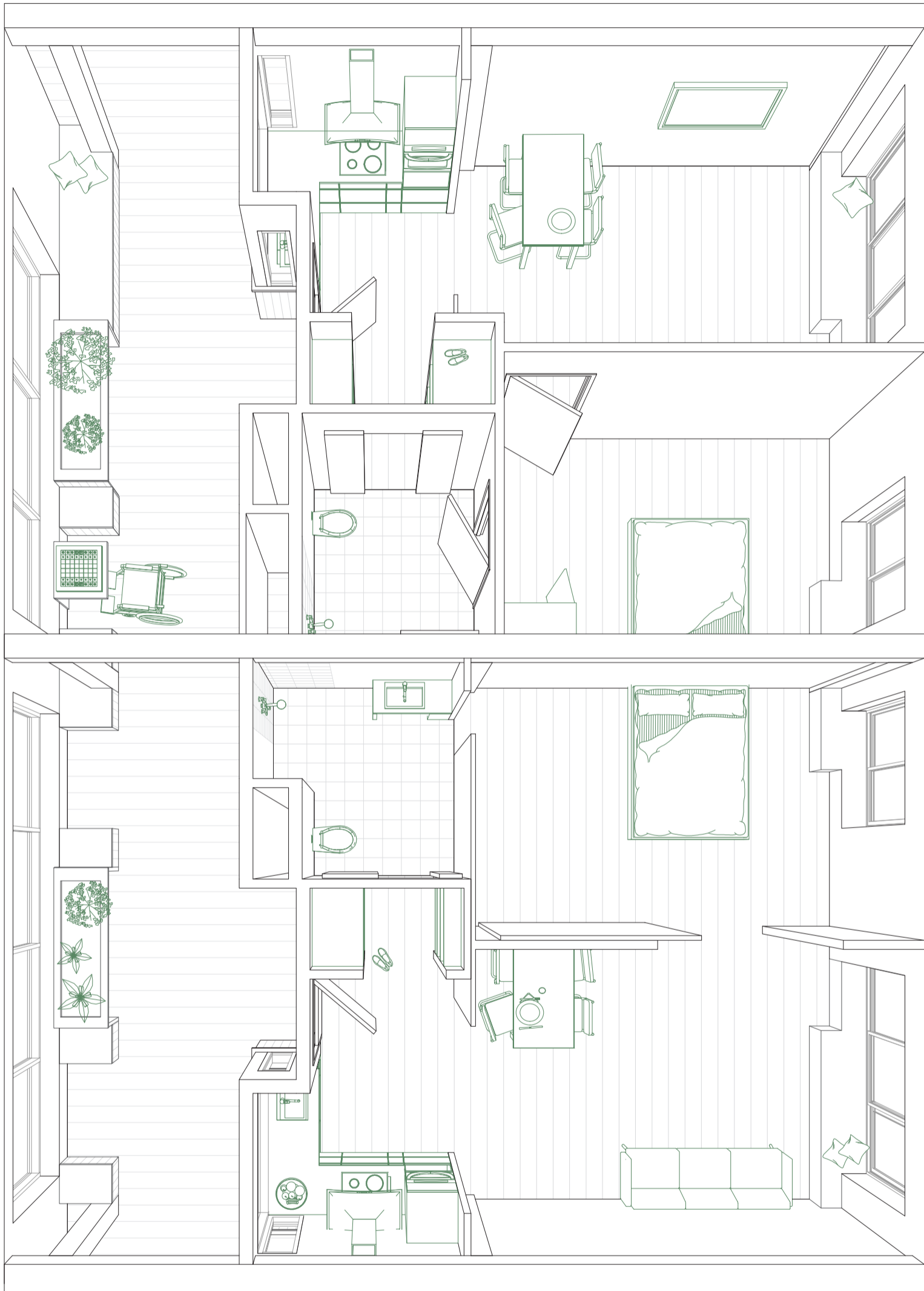

FLOOR PLAN 45M²
1:50

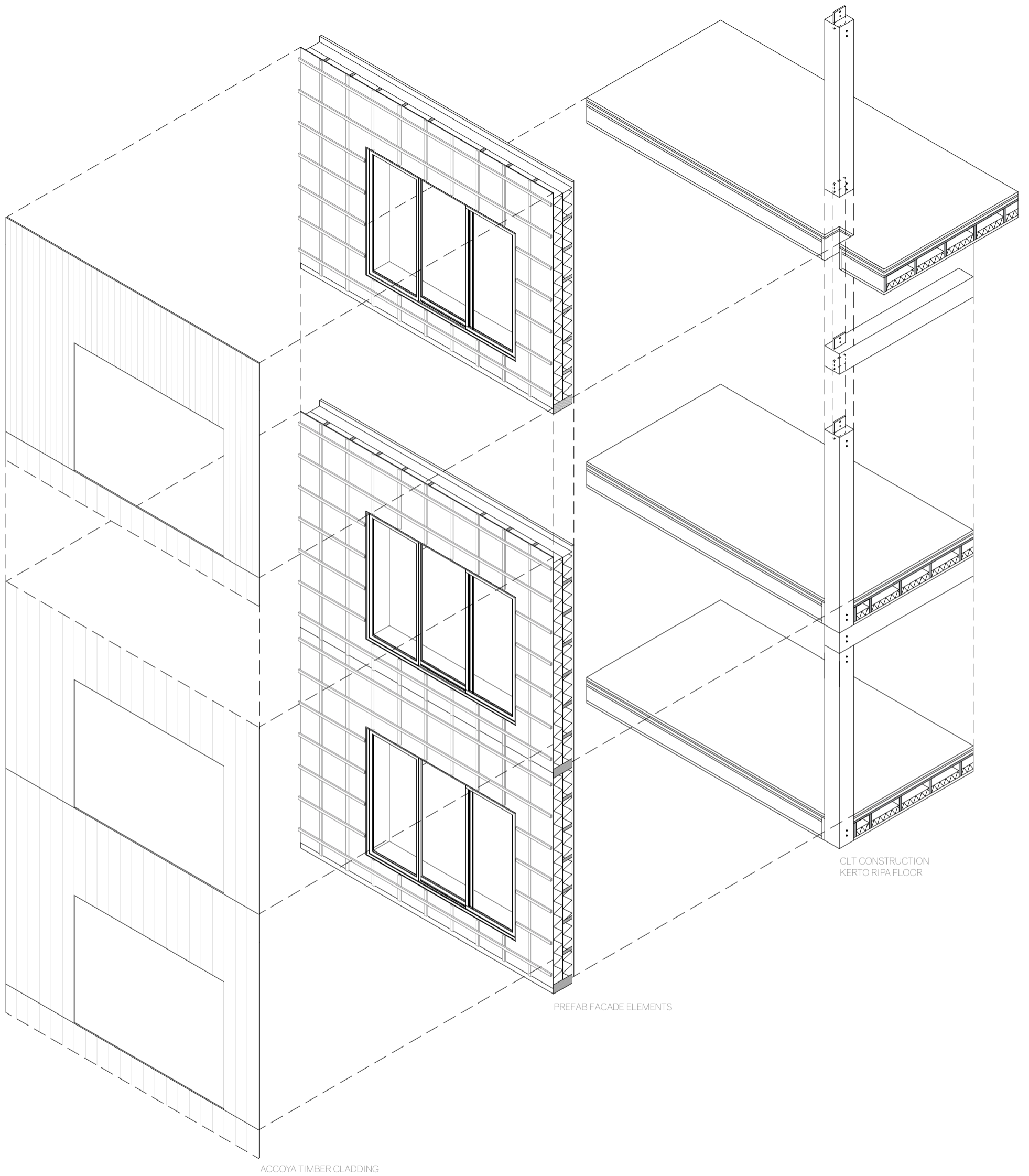

ASSEMBLY FACADE & CONSTRUCTION



NORTH FACADE
1:200



EAST FACADE
1:200

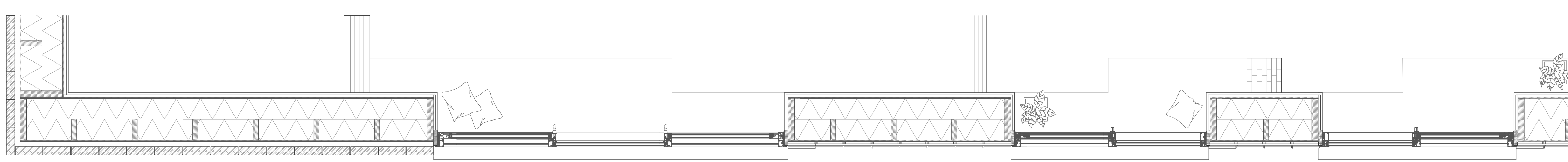
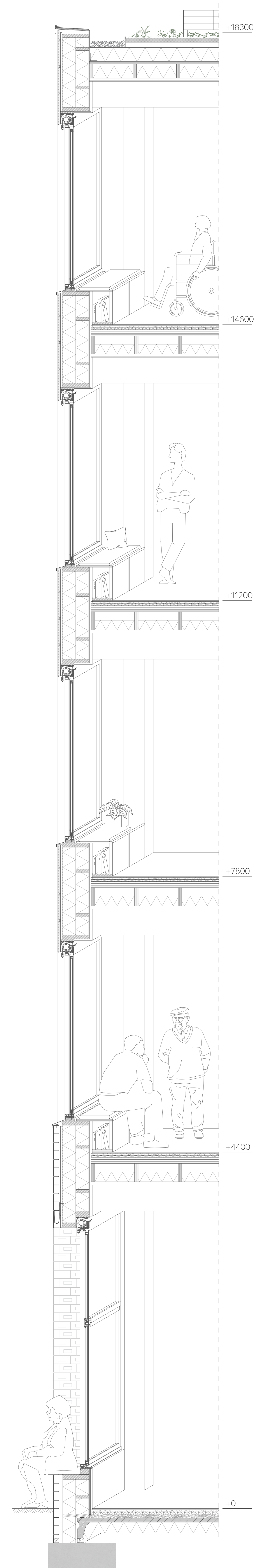
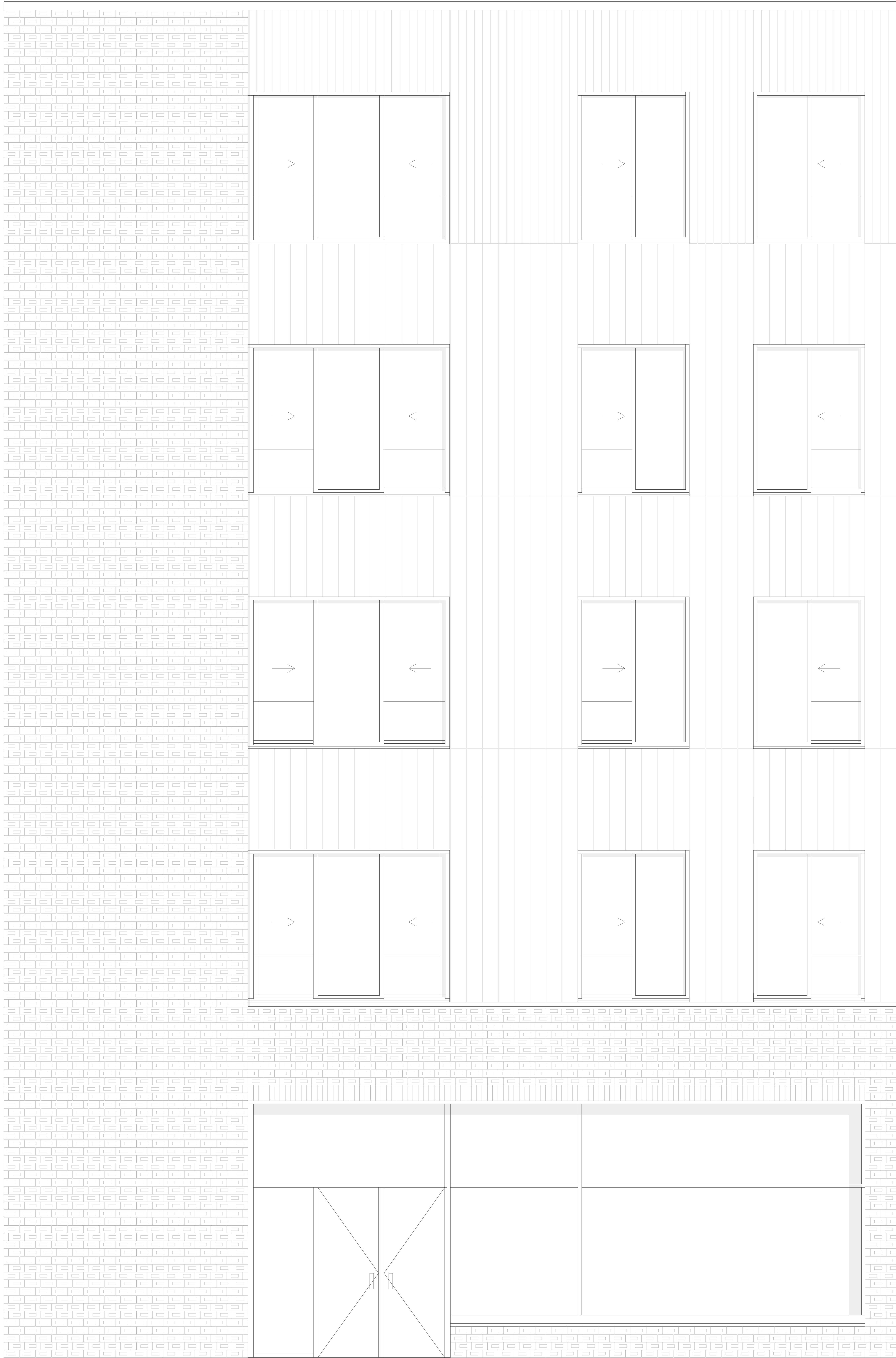

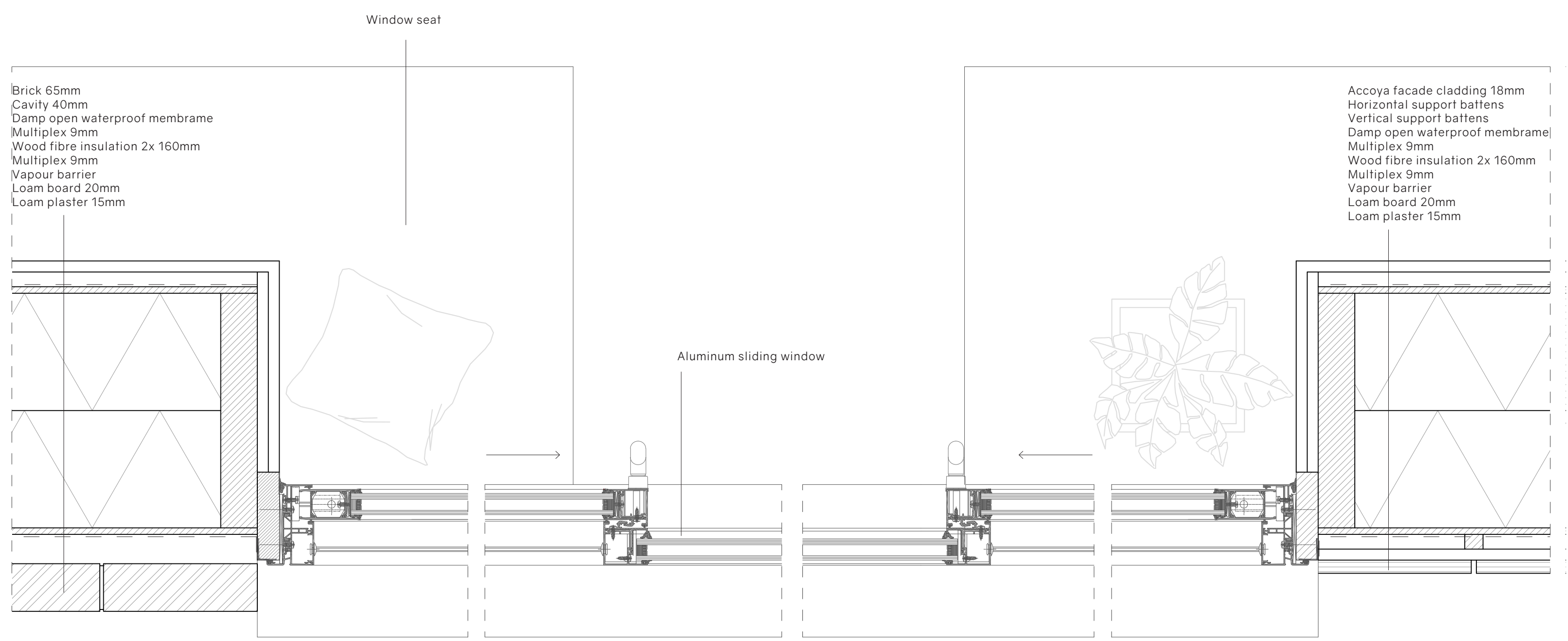

HORIZONTAL WINDOW DETAIL
1:5

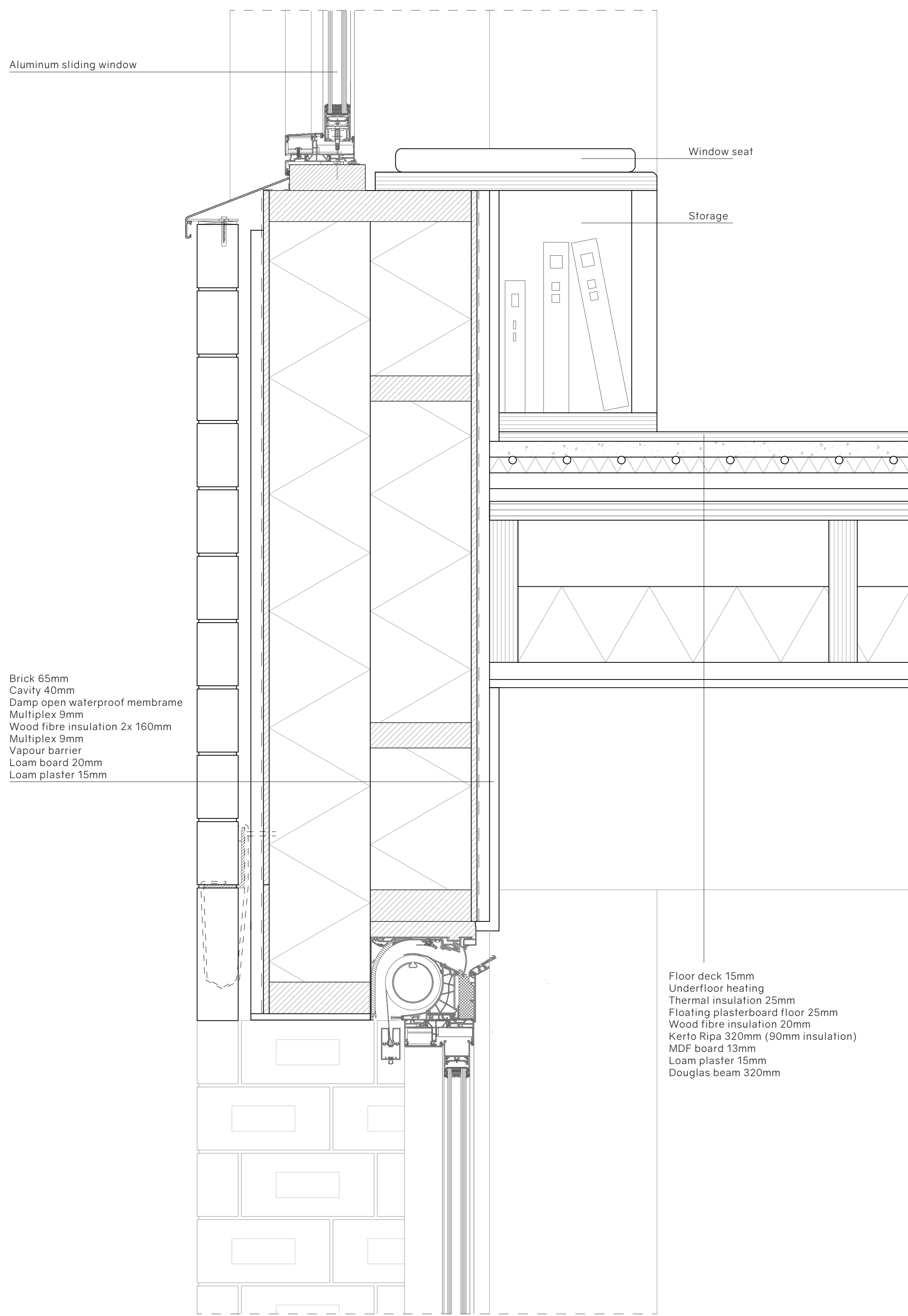

VERTICAL WINDOW DETAIL
1:5

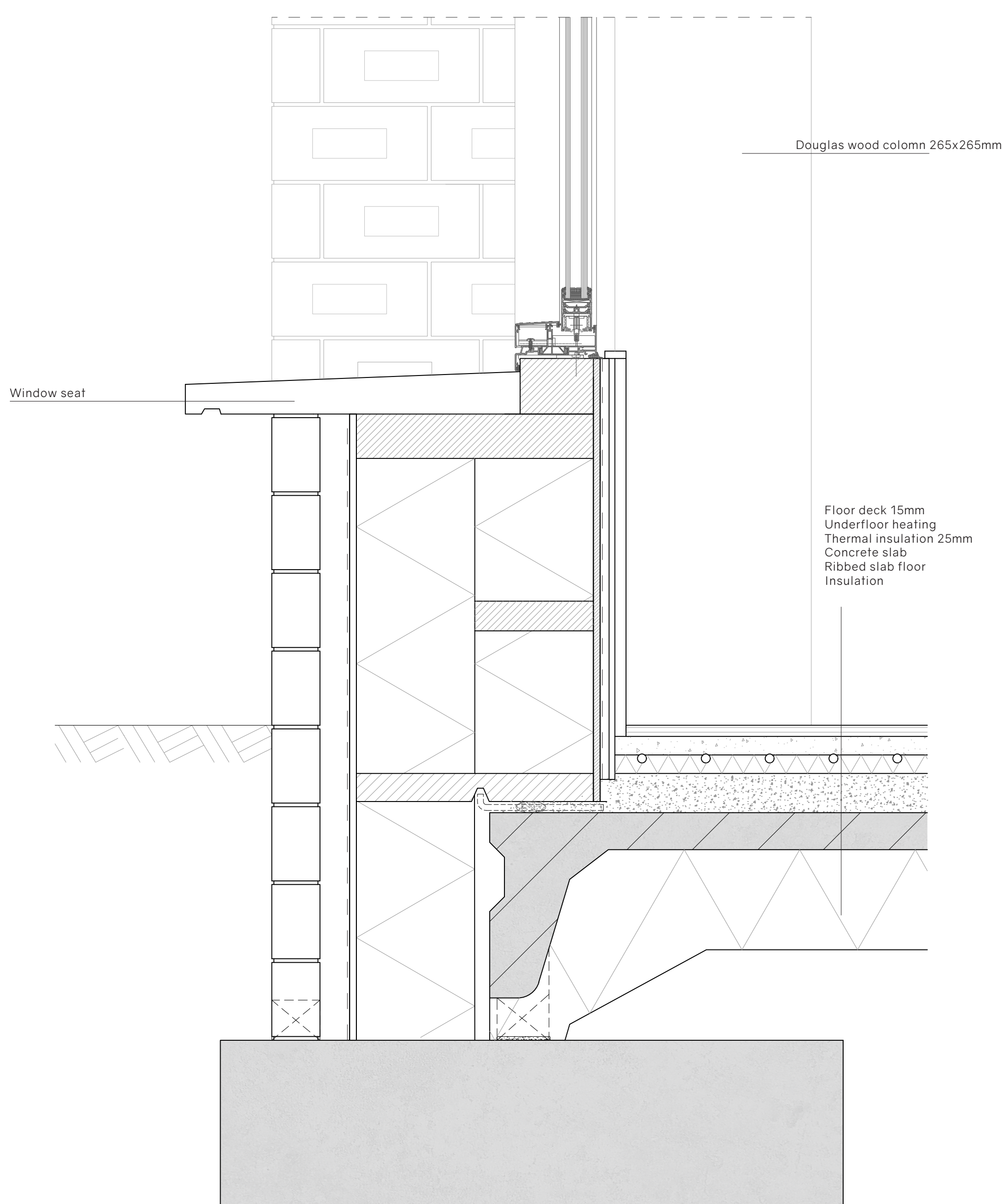

FOUNDATION DETAIL
1:5





