

MEDIAHEIM BERLIN

MEDIATHEQUE & COMMUNITY LOUNGE



Iris van der Moolen
MSc4 Public Building
21 June 2023

PUBLIC CONDENSER

A CONTEMPORARY PUBLIC CONDENSER SHOULD BE ...

A CREATIVE SPACE...

A place to work & develop
For activities and participation
A place to play
To learn and expand



AN URBAN HOTSPOT...

A connection point in the neighbourhood
A place of attraction
A place of diversity
A place to discover

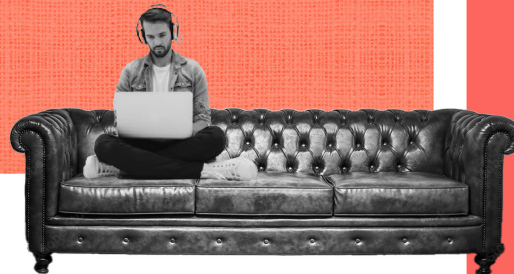

A COMMUNAL LIVING ROOM...

A place to be yourself
A place to relax
To do more than one thing
To feel at home



A SOCIAL STAGE...

A place of exchange
A central meeting point
For spontaneous interaction
An inclusive & democratic space

GENTRIFICATION

THE NEED OF A PUBLIC CONDENSER

MEDIAHEIM BERLIN



© Fotolia/davis, 2013

GROWING URBANISATION

Development of apartment complexes, rising from the ground enlarges the individualism and isolation.



© Welters, 2017

EXTENSIVE MODERNISATION

of old buildings resulted in rents rise, which low-income groups can not afford.



© Andersen, 2019

SOCIAL UNREST INCREASES

because gentrification creates a significant socio-economic inequality and segregation.

SOCIAL IMPACT

WHAT DO THE NUMBERS SAY?

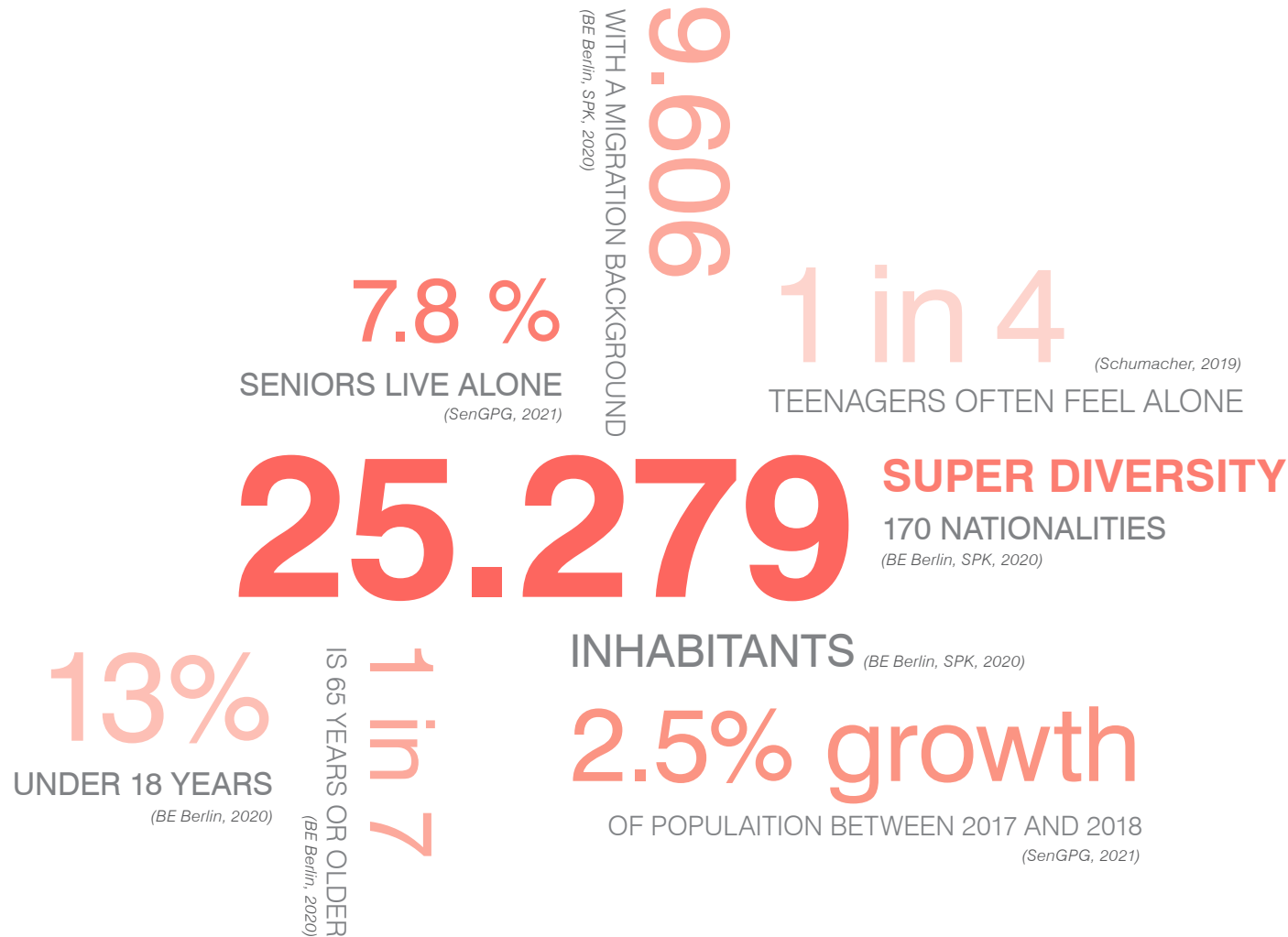

FRIEDRICHSHAIN

KARL-MARX-ALLEE SÜD

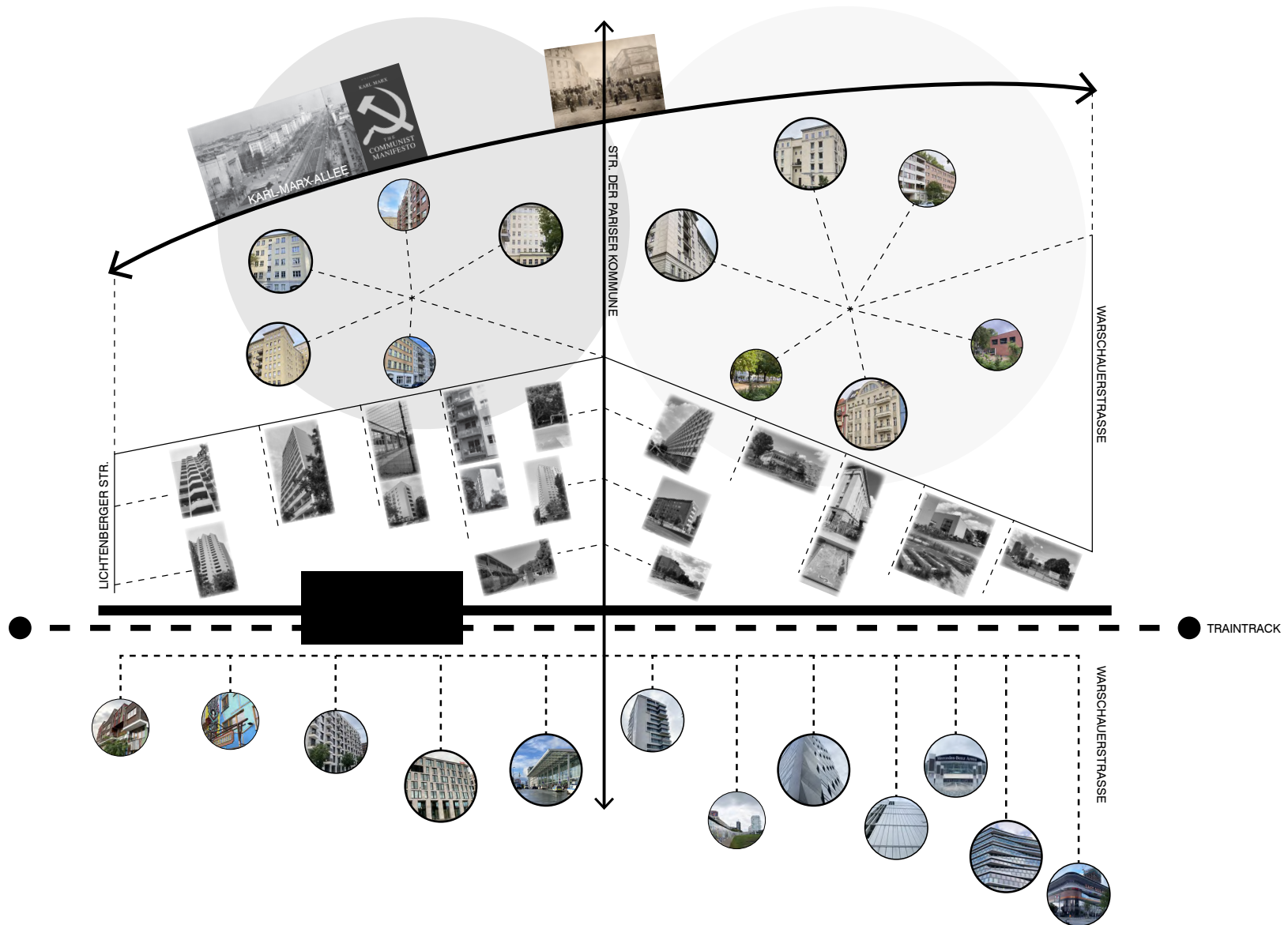

TARGET GROUPS

WHAT DO THE USERS WISH FOR?

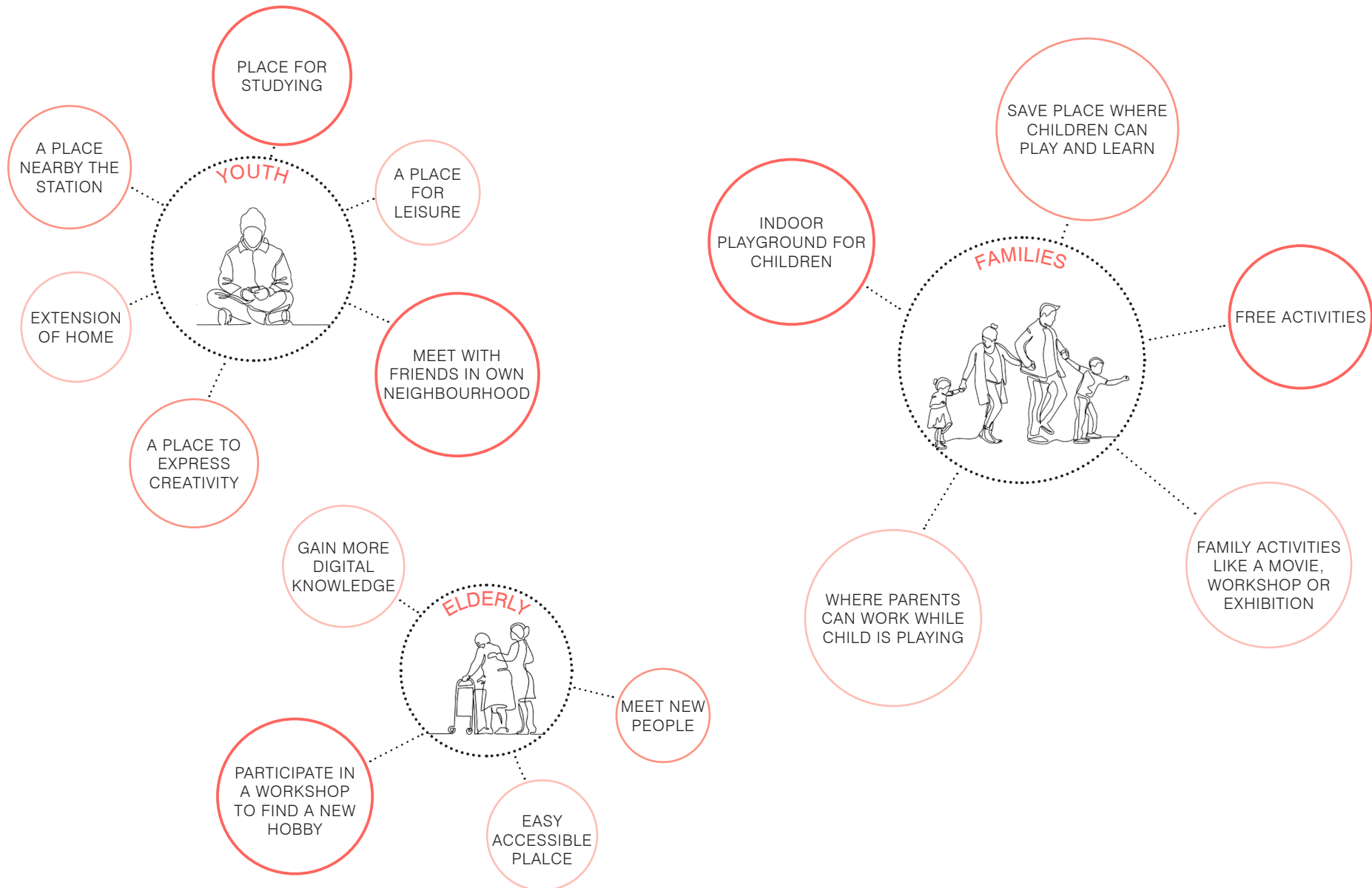

MEDIA LIBRARY

A PUBLIC CONDENSER FOR THE COMMONS

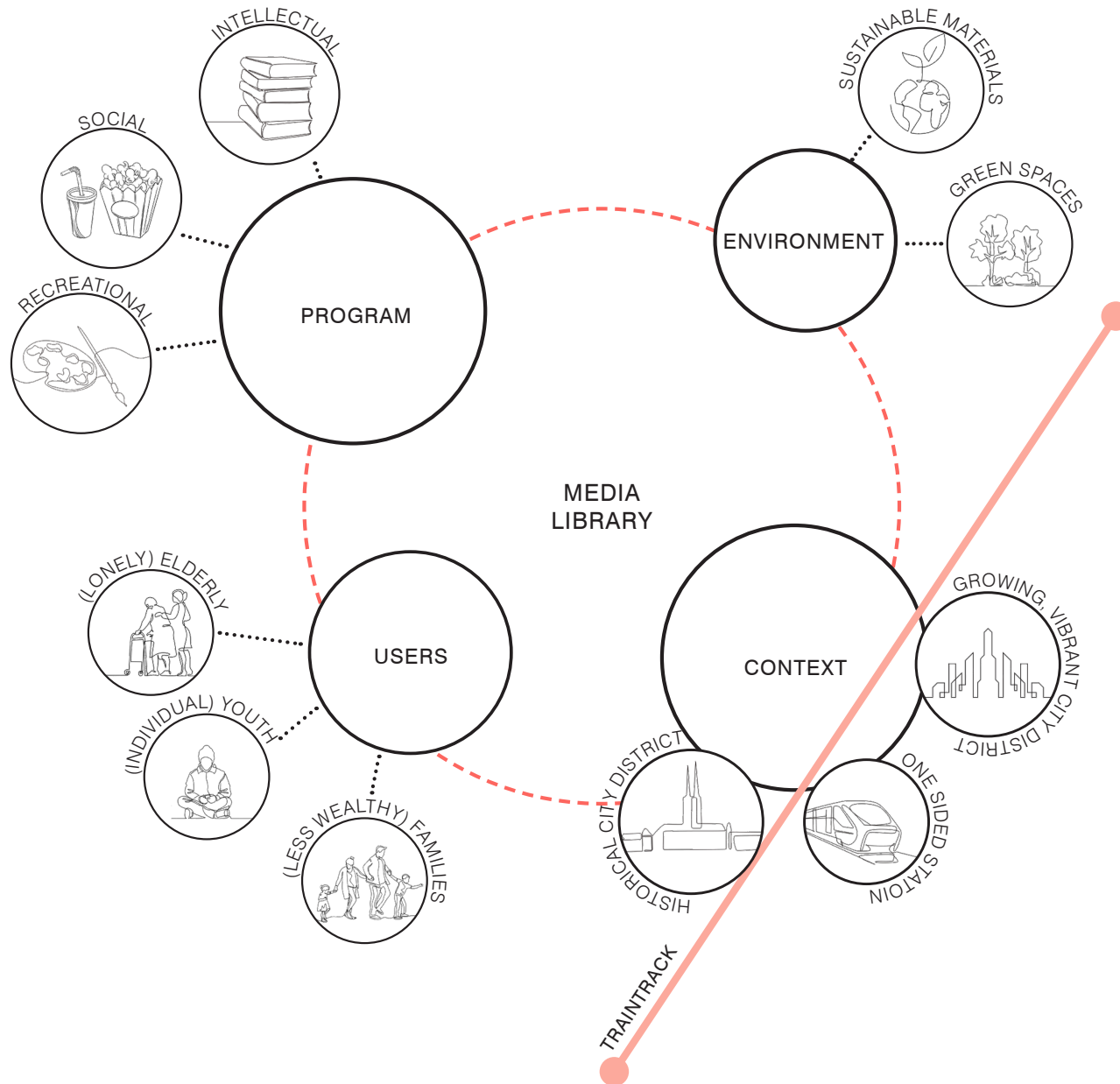

PROJECT LOCATION

PROJECT SITE ALIGNED TO BORDER

MEDIAHEIM BERLIN

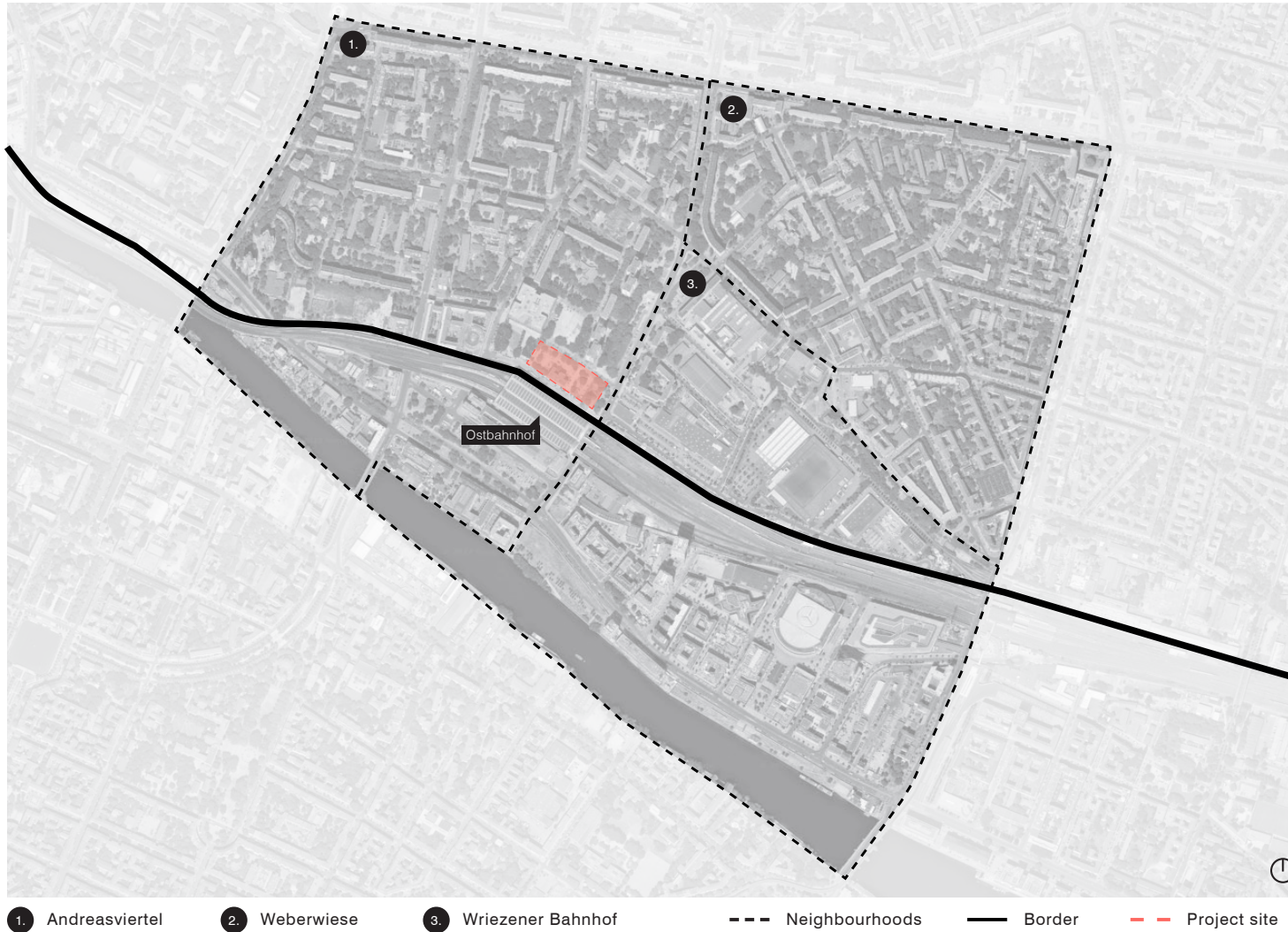

1. Andreasviertel

2. Weberwiese

3. Wriezener Bahnhof

--- Neighbourhoods

— Border

- - - Project site

CENTRAL LIBRARY

ADDITION TO THE CITY OF BERLIN

MEDIAHEIM BERLIN

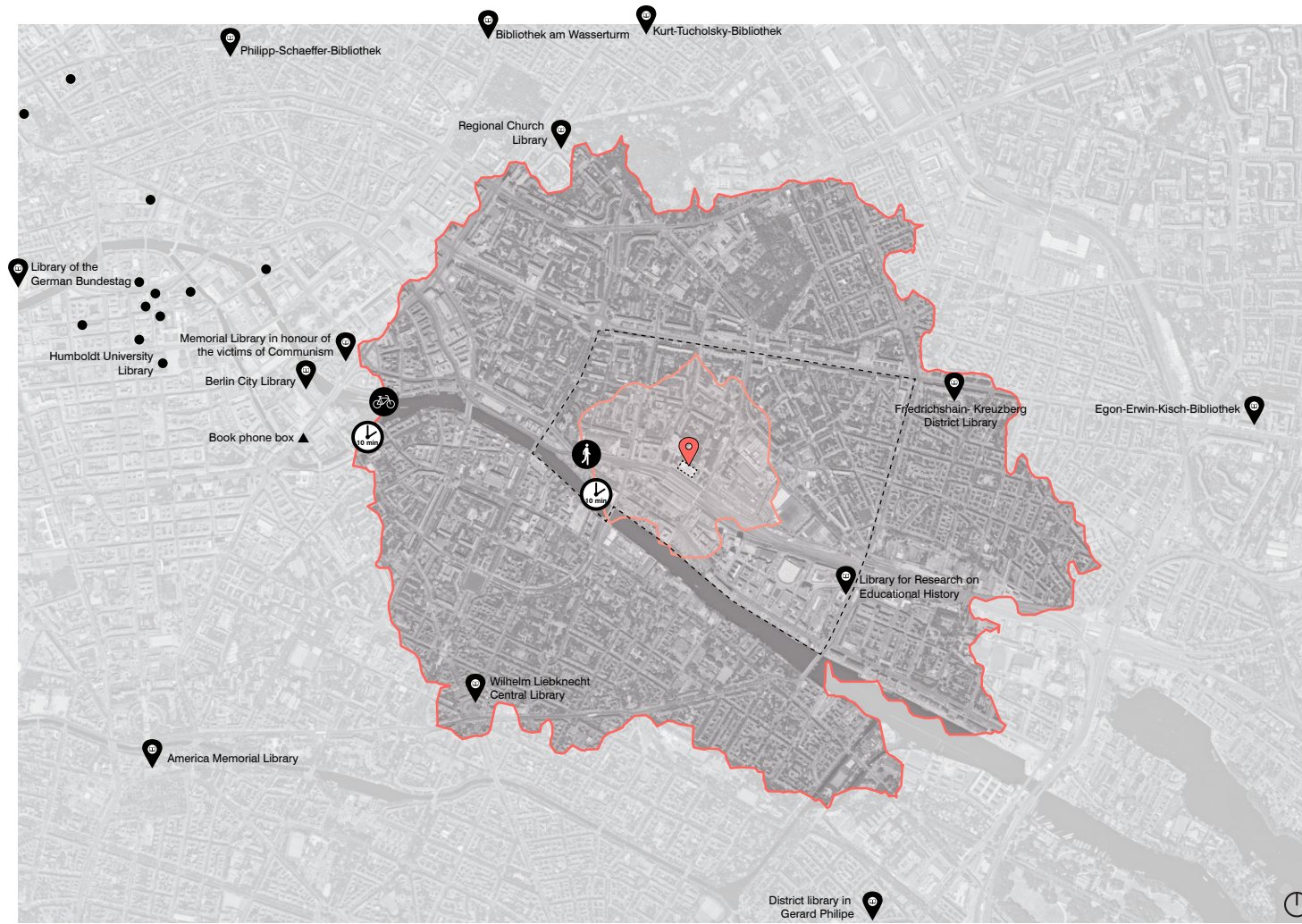

Public Libraries University Libraries 10 min bike 10 min walk District

900 m

An architectural rendering of a modern library interior. The space is characterized by a high ceiling with a series of horizontal wooden slats. Large windows on the left side provide ample natural light. The library is filled with bookshelves, some of which are integrated into a large, multi-level wooden structure. A prominent feature is a tall, cylindrical sculpture with a vibrant, multi-colored, wavy design. In the foreground, a man and a young child are walking. In the background, a woman is standing near a bookshelf. A small display area in the lower right corner shows a person sitting on the floor, looking at a screen, with the text "PUBLIC CONDENSER IN GENTRIFYING AREAS" above it.

"HOW CAN DIFFERENT **MEDIA TYPES** FORM A NEW **LIBRARY TYPOLOGY** THAT SERVES AS A **CULTURAL HEART** AMONG GENTRIFYING NEIGHBOURHOODS?"

LIBRARY TYPOLOGIES

HOW ARE PUBLIC LIBRARIES ORGANISED?



SEATTLE CENTRAL LIBRARY
OMA & LMN
2004

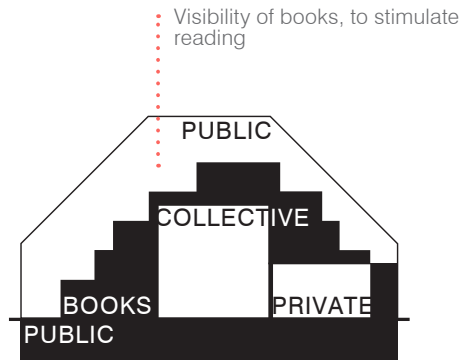

ROZET CULTURE HOUSE
NEUTELINGS RIEDIJK
2013

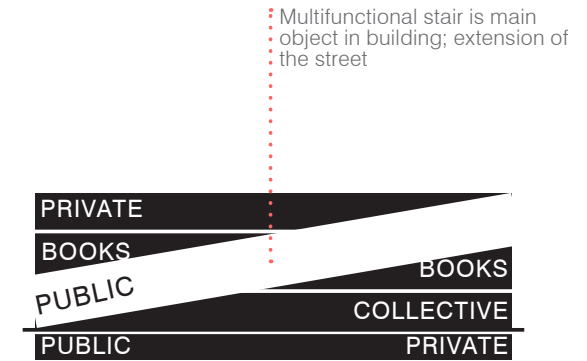

FORUM GRONINGEN
NL ARCHITECTS
2019

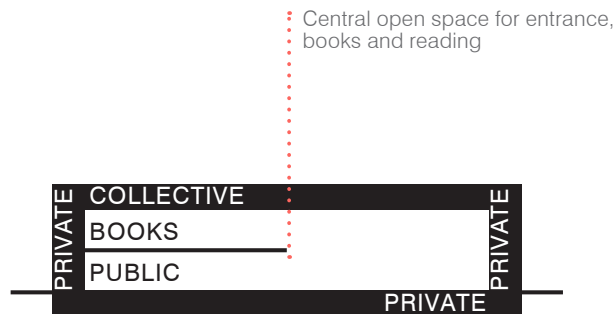

BOOK MOUNTAIN
MVRDV
2012

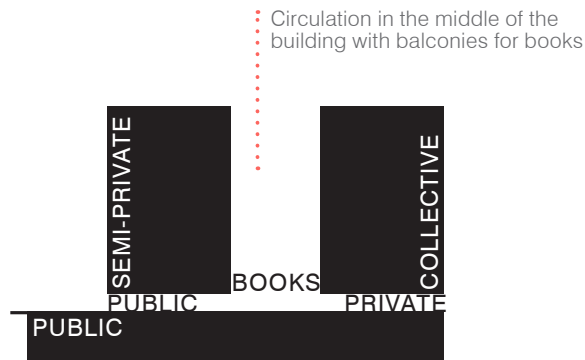

ALEXIS DE TOCQUEVILLE
OMA & BARCODE ARCHITECTS
2017

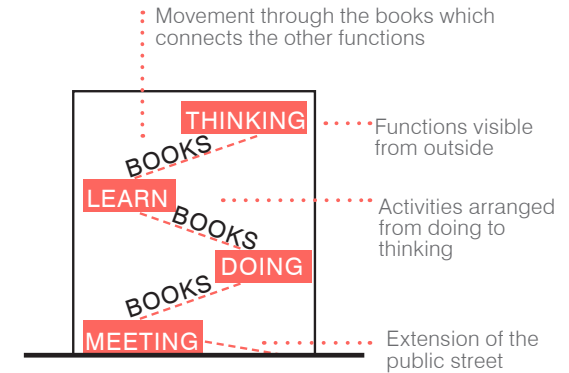

NEW TYPOLOGY

PROCESS OF LEARNING

STIMULATE THE SYNERGIES OF ACTIVITIES

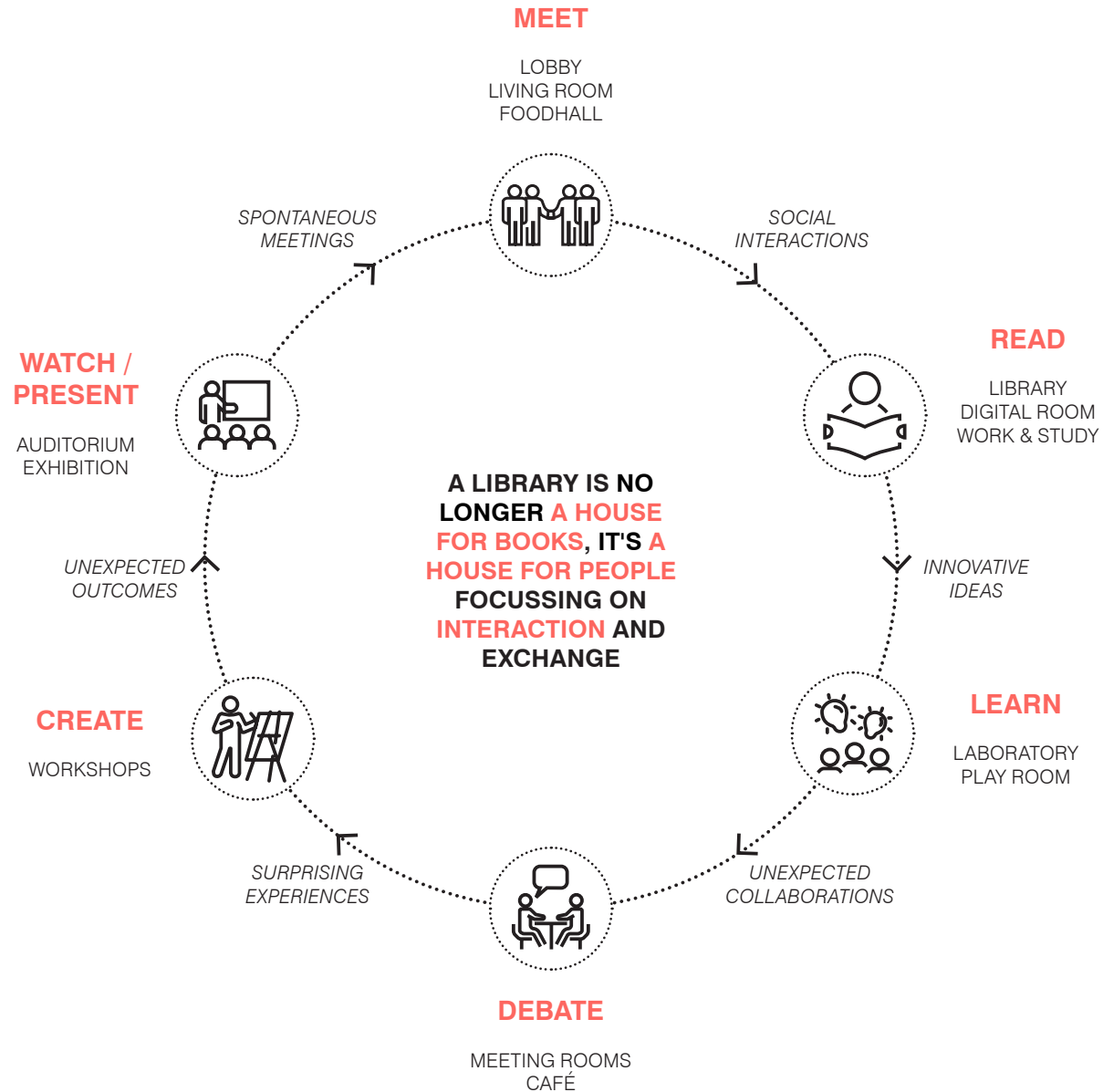

PROGRAM ORGANISATION

CONNECTING ACTIVITIES THROUGH THE LIBRARY

Category	Activity	Area (m²)	Percentage	Room	Area (M2)
INTELLECTUAL	Operate	180 m²	4%	OFFICES	180 M2
	Debate	270 m²	6%	MEETING ROOMS	270 M2
	Focus	450 m²	10%	LIBRARY	450 M2
	Study	495 m²	11%	DIGITAL ROOM	180 M2
SOCIAL	Recreate	450 m²	10%	WORK & STUDY	315 M2
	Arrive	450 m²	10%	LOUNGE	450 M2
	Consume	675 m²	15%	LOBBY	225 M2
				PARKING	225 M2
	CREATIVE	Present	450 m²	10%	CAFÉ
FOODHALL					450 M2
Learn		630 m²	14%	AUDITORIUM	225 M2
				EXHIBITION	225 M2
Create		450 m²	10%	LABORATORY	180 M2
				GAME AREA	180 M2
				PLAY AREA	270 M2
	WORKSHOPS	450 M2			

BUILDING PROGRAM

4.500M2

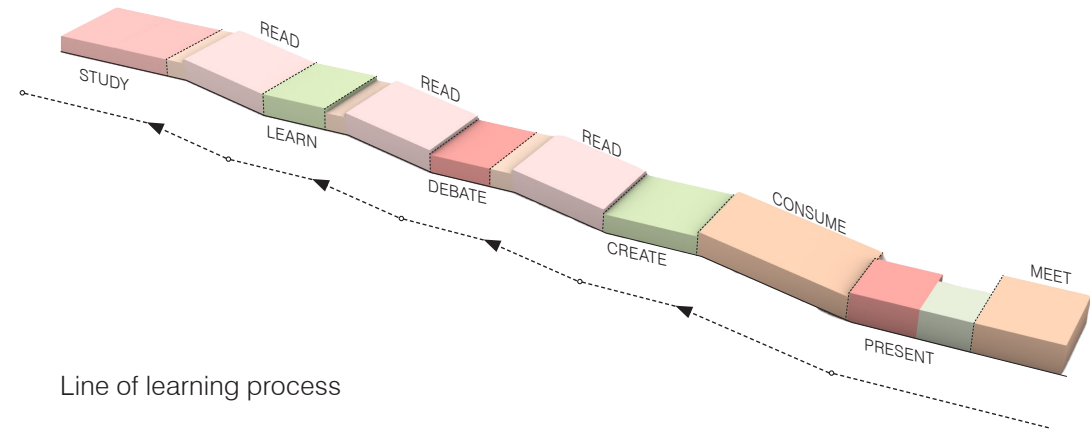

Line of learning process

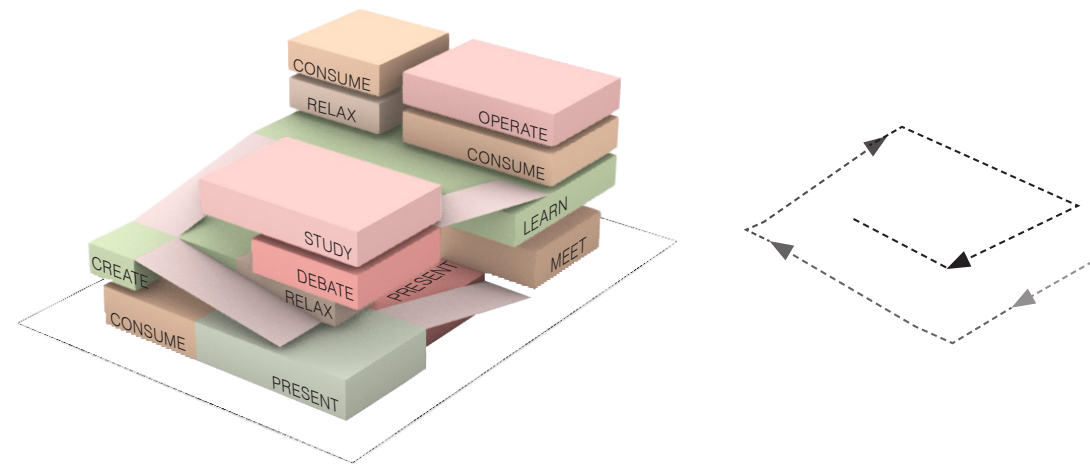

Spiral of learning

MEDIA FORMS

MULTIMEDIA THROUGH FUNCTION MIX

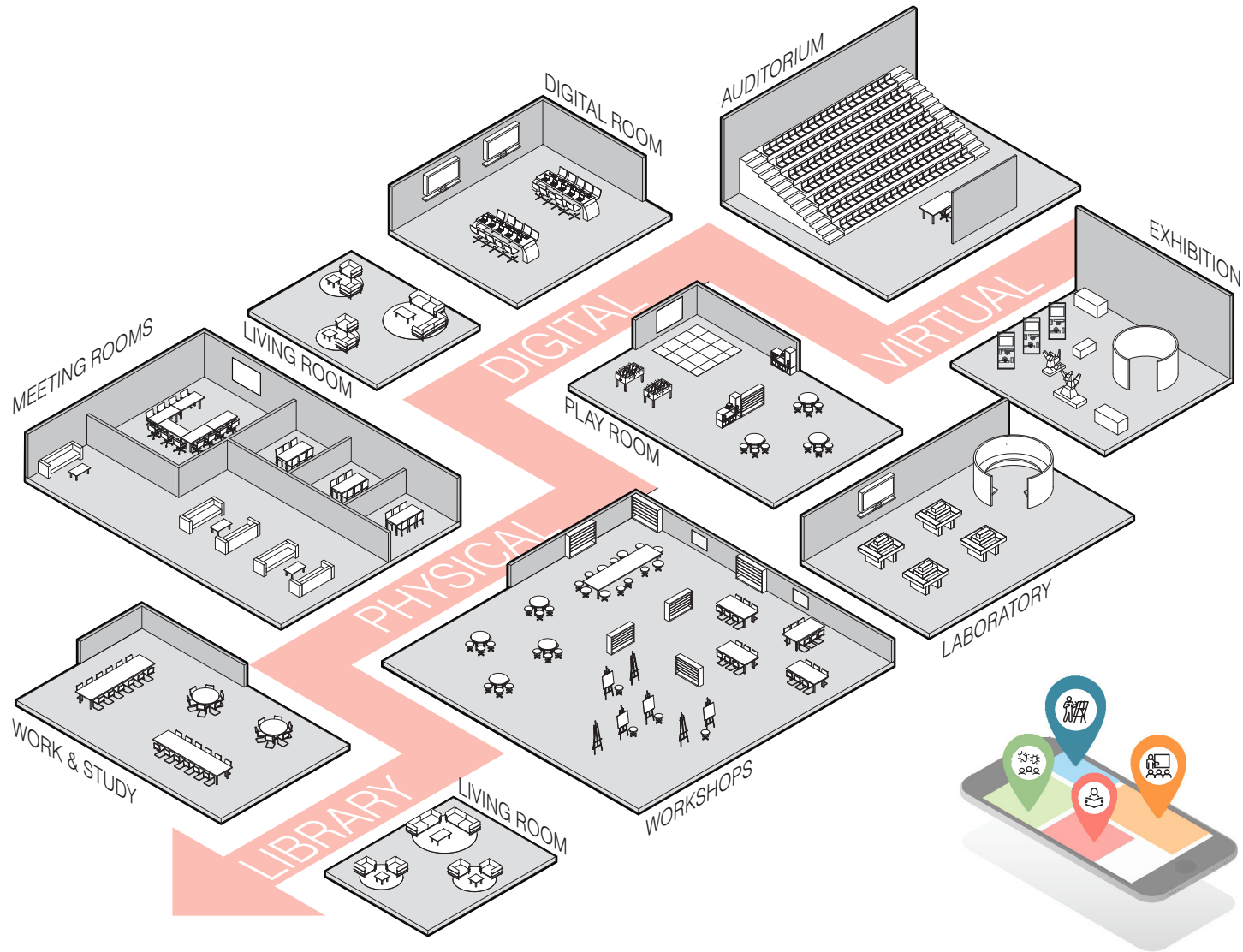

USER SCENARIO'S

FACILITATING ALL GENERATIONS



70 year old

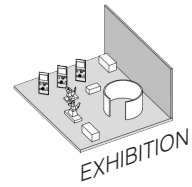

9 AM

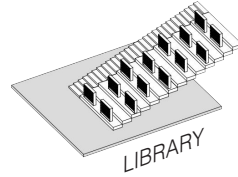

10 AM

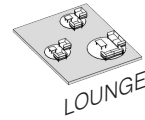

Noon

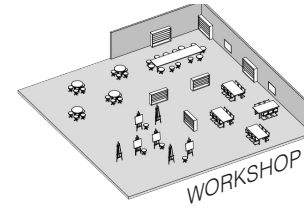

13 PM

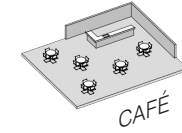

15 PM



15 year old student

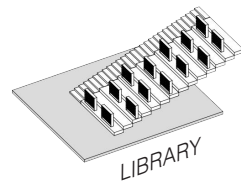

13 PM

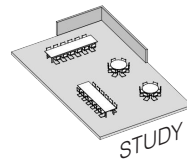

14 PM

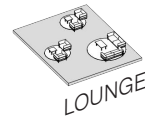

16 PM

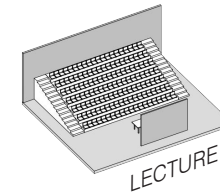

17 PM

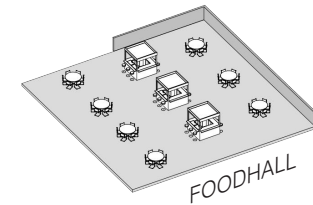

19 PM



6 year old with mother

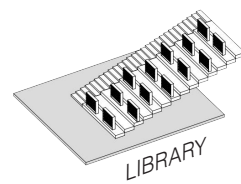

9 AM

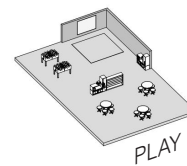

10 AM

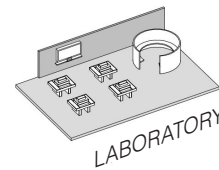

Noon

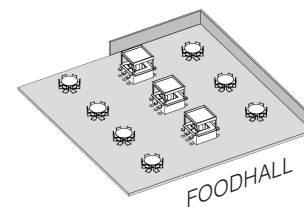

14 PM

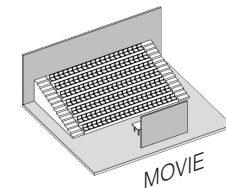

15 PM

ARCHITECTURAL DESIGN

TRANSLATING RESEARCH INTO DESIGN

MEDIAHEIM BERLIN



DESIGN STRATEGY

TRANSFORM THE ORIGINAL LIBRARY TYPOLOGY

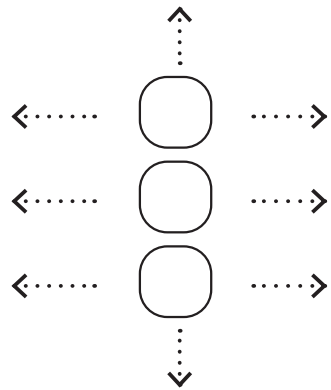

VISIBILITY AND ACCESSIBILITY

What if everything is visible and accessible?

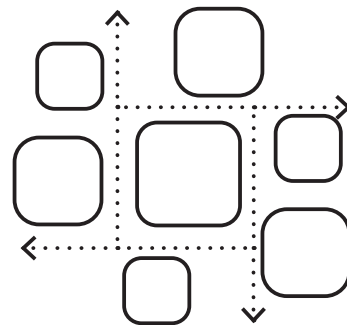

INTERACTIVITY

What if the circulation is the catalyst of social encounter?

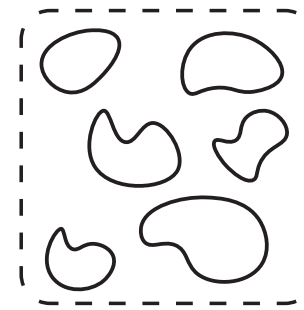

DIVERSITY AND HYBRIDITY

What if every space has its own character?

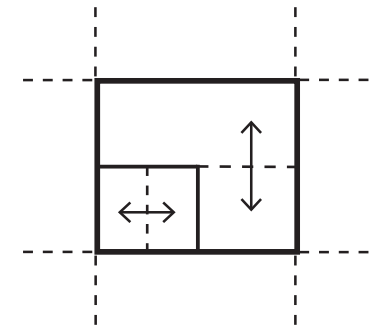

ADAPTABILITY

What if the building can change through time?

URBAN CONCEPT

MEANING FOR THE SURROUNDINGS

MEDIAHEIM BERLIN

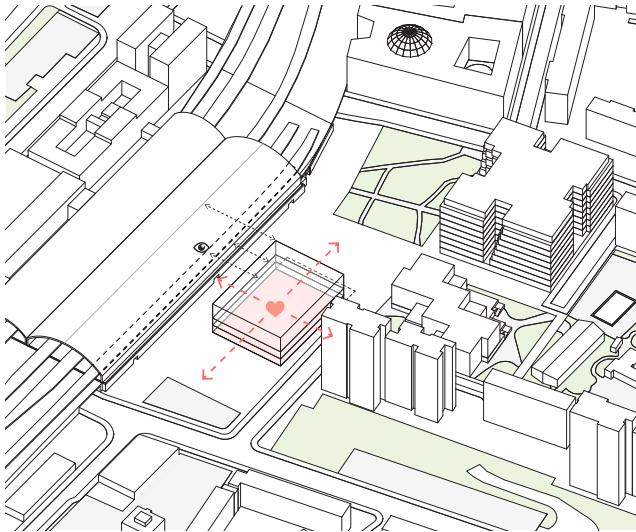

Cultural heart

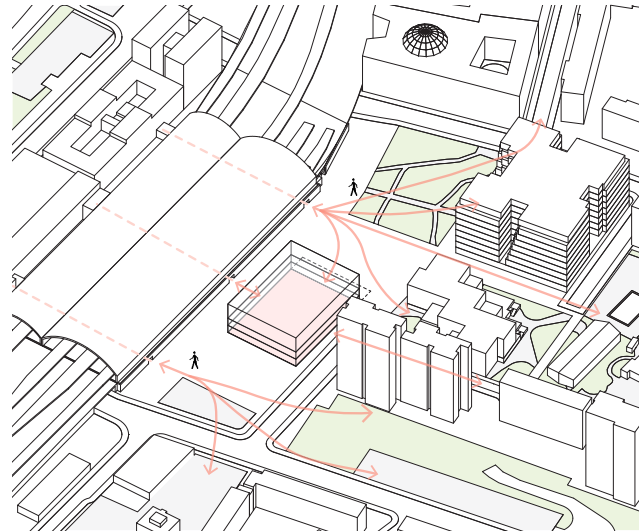

In centre of flows

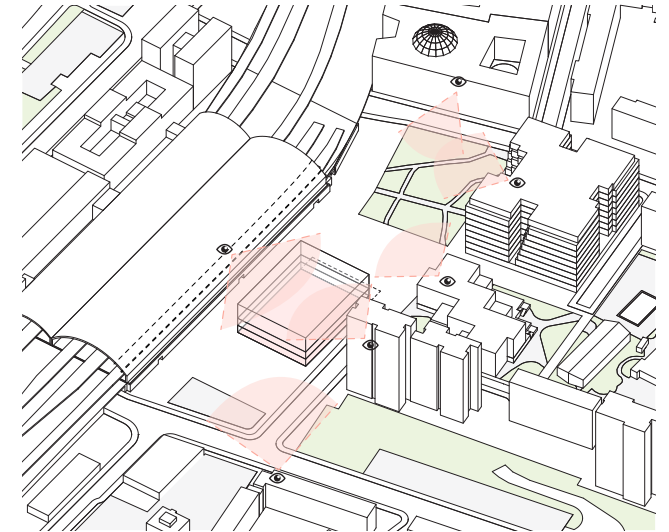

Allowing sightlines

URBAN CONCEPT

FORM DEVELOPMENT

MEDIAHEIM BERLIN

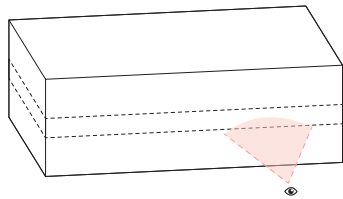

Basic volume

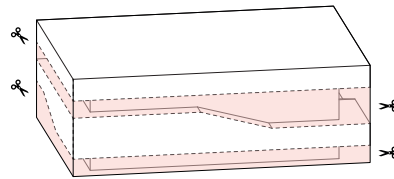

Split by library routing

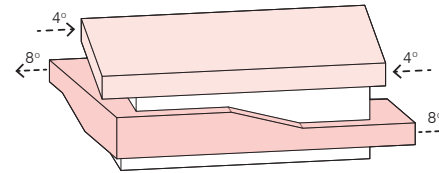

Rotation to other buildings

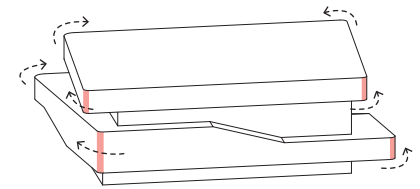

Soften the corners

URBAN INTEGRATION

INTERACTION WITH SURROUNDING

MEDIAHEIM BERLIN

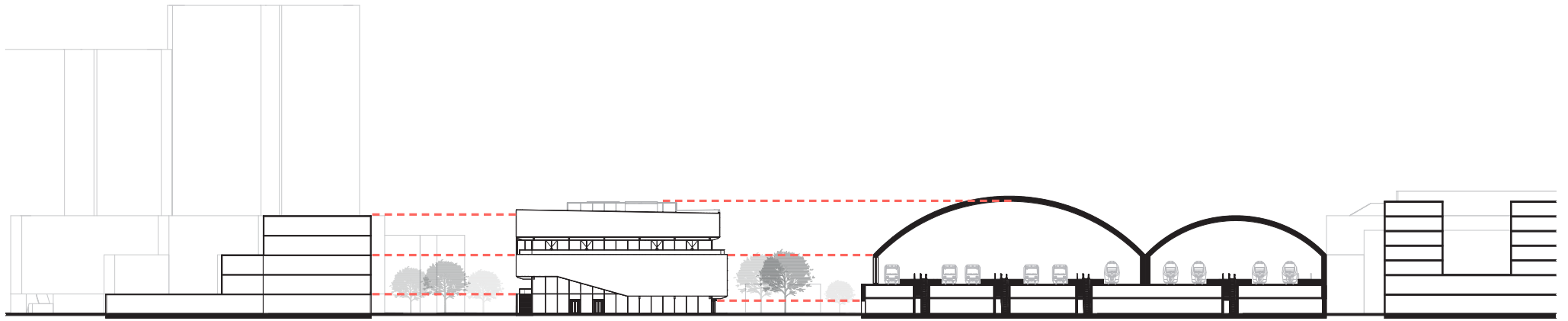

West facade in cross section of the site, scale 1:2000

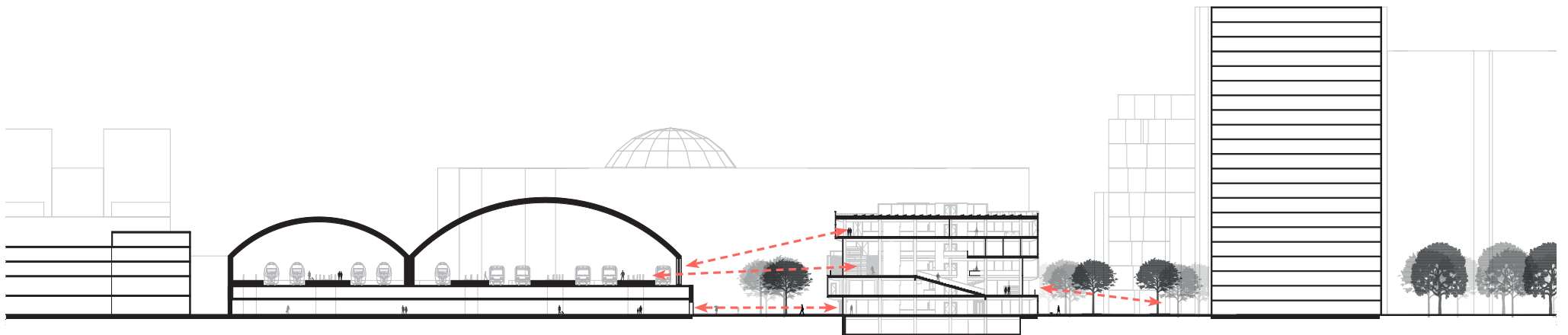

Cross section, Scale 1:2000

URBAN INTEGRATION

INTERACTION WITH SURROUNDING

MEDIAHEIM BERLIN

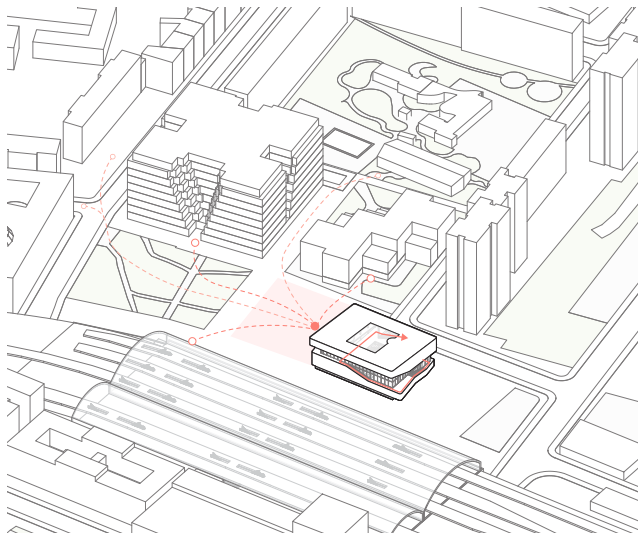

Extension of the street

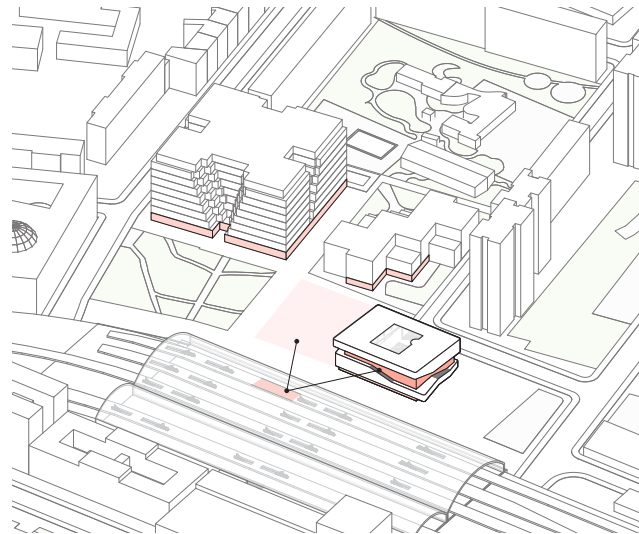

Library as connecting element

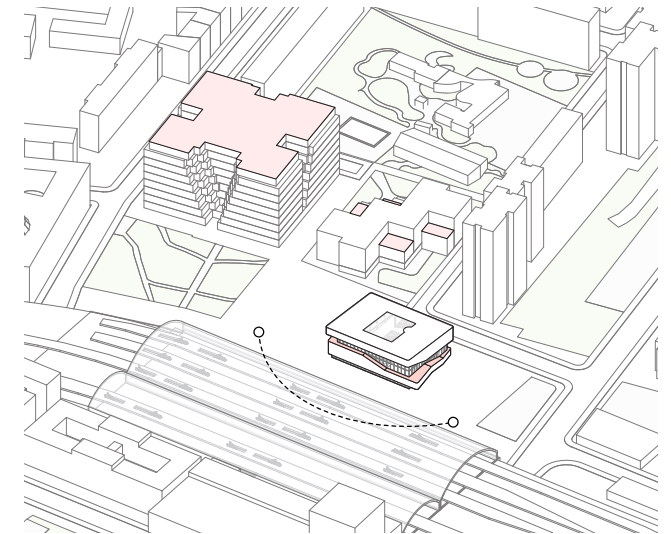

Utilising outdoor spaces

SITE INTEGRATION

EXISTING SITUATION

MEDIAHEIM BERLIN



Scale, 1:2000

PUBLIC CONDENSER



SLIDE 22 OF 65

SITE INTEGRATION

PLANNED INTEGRATION

MEDIAHEIM BERLIN

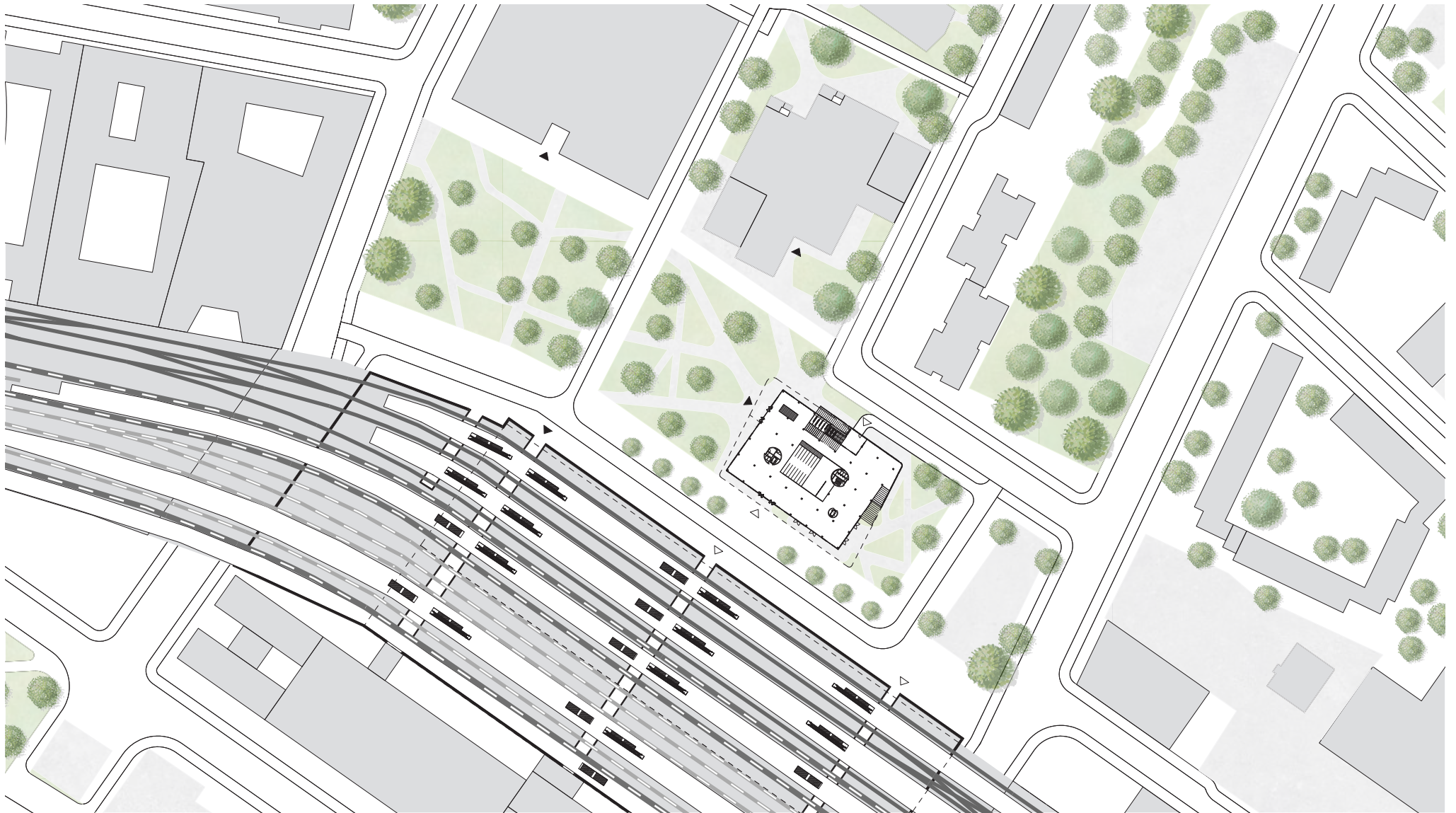

Scale, 1:2000

PUBLIC CONDENSER



SLIDE 23 OF 65

SITE INTEGRATION

ENTRANCE RELATION

MEDIAHEIM BERLIN

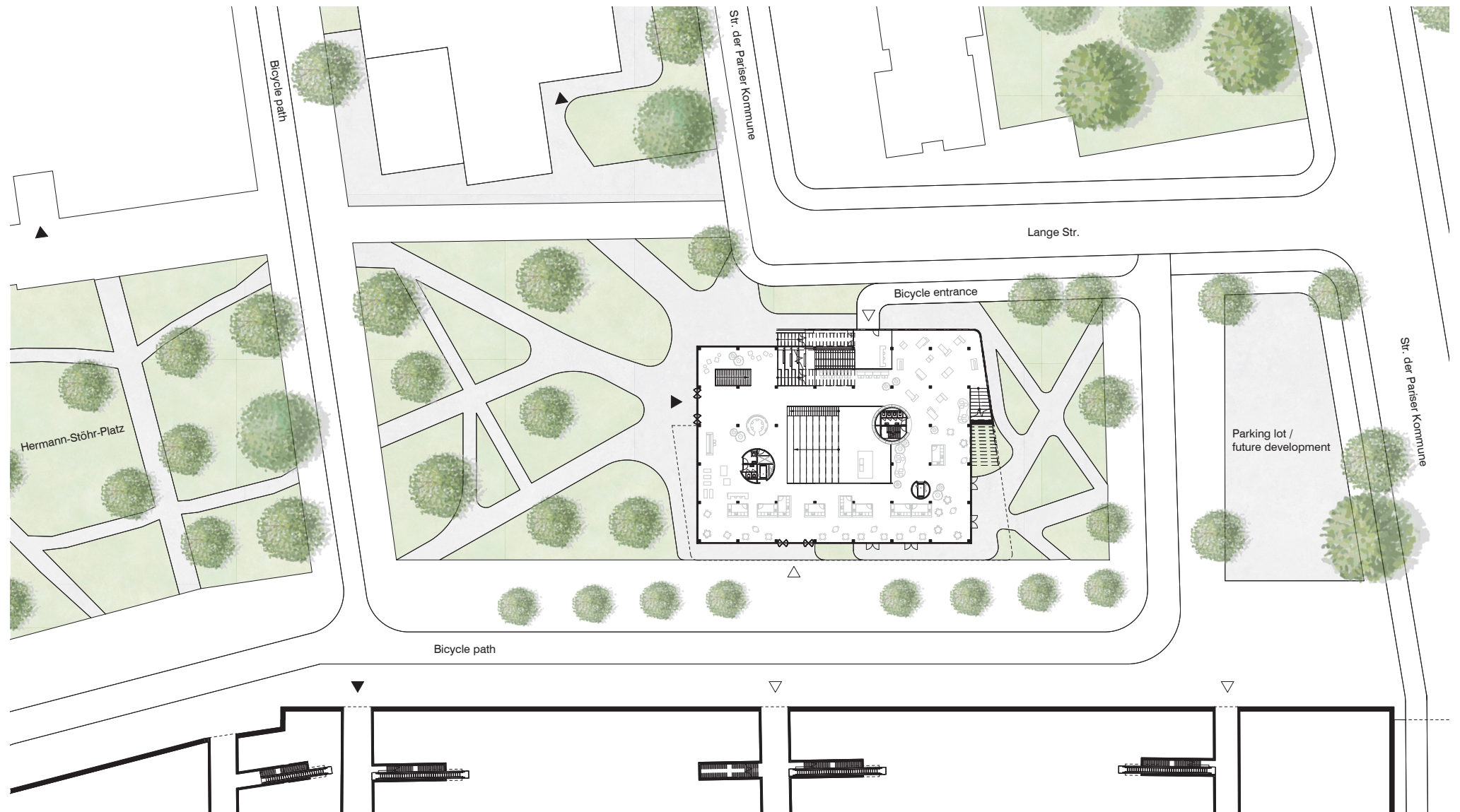

Scale, 1:1000



SITE INTEGRATION

ENTRANCE FROM STATION

MEDIAHEIM BERLIN



BUILDING CONCEPT

DEVELOPED ORGANISATION

MEDIAHEIM BERLIN

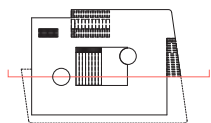
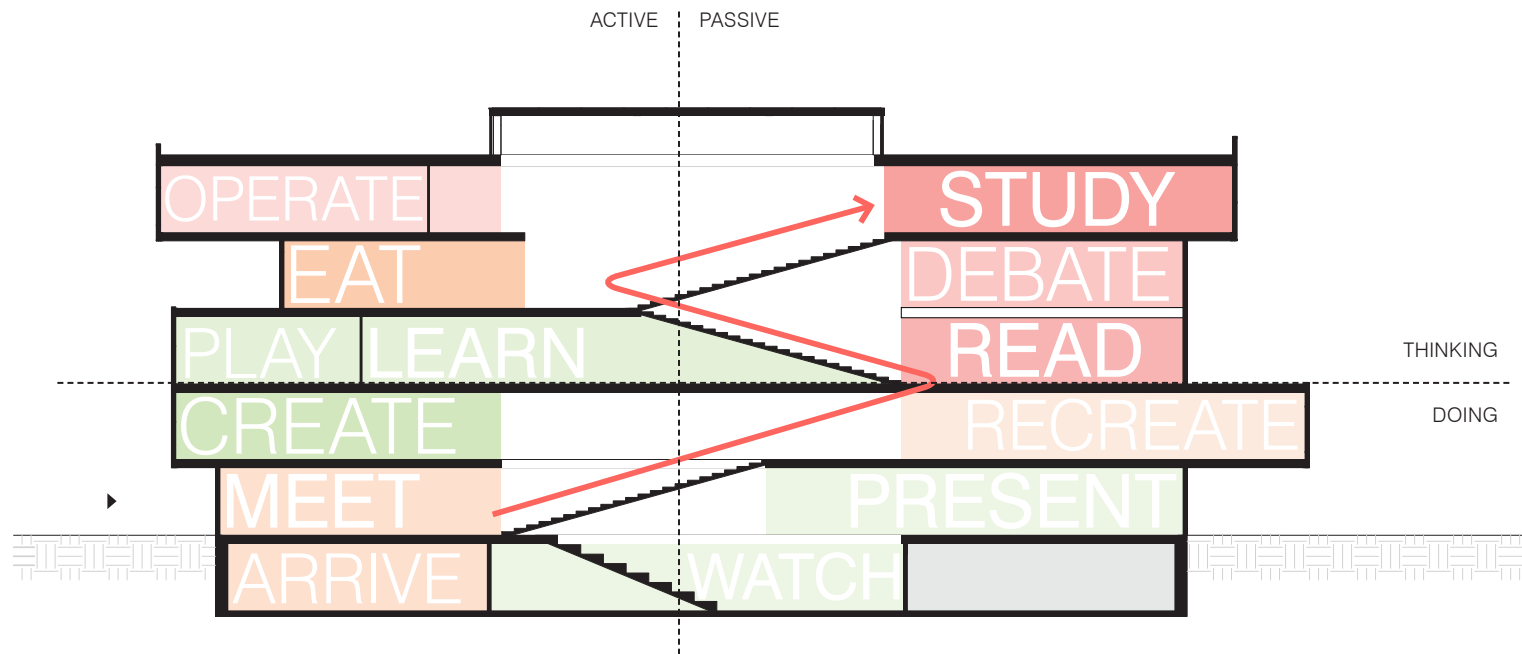

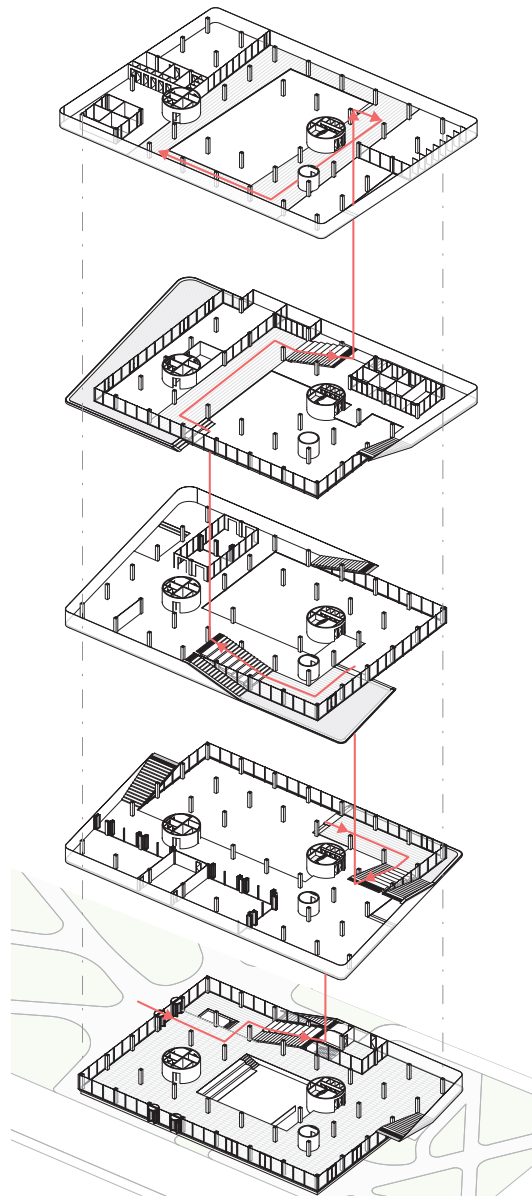

Approach and interior routing

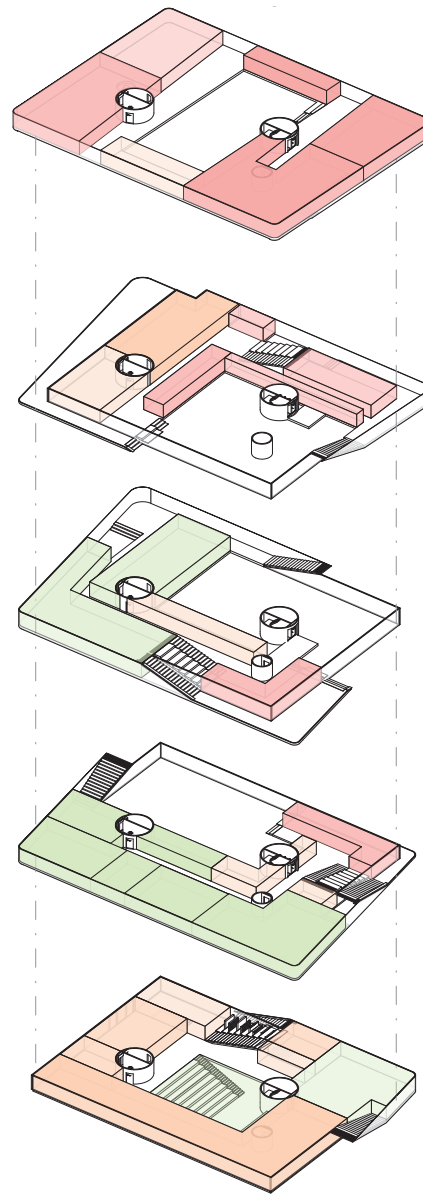

Programmatic placement

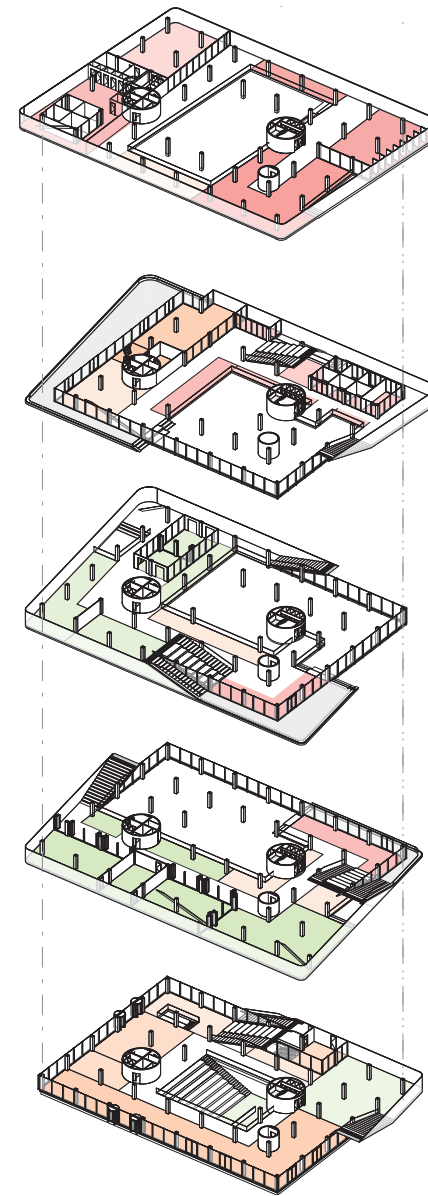

Spatial structure

BASEMENT

PRESENT AND OPERATE

MEDIAHEIM BERLIN

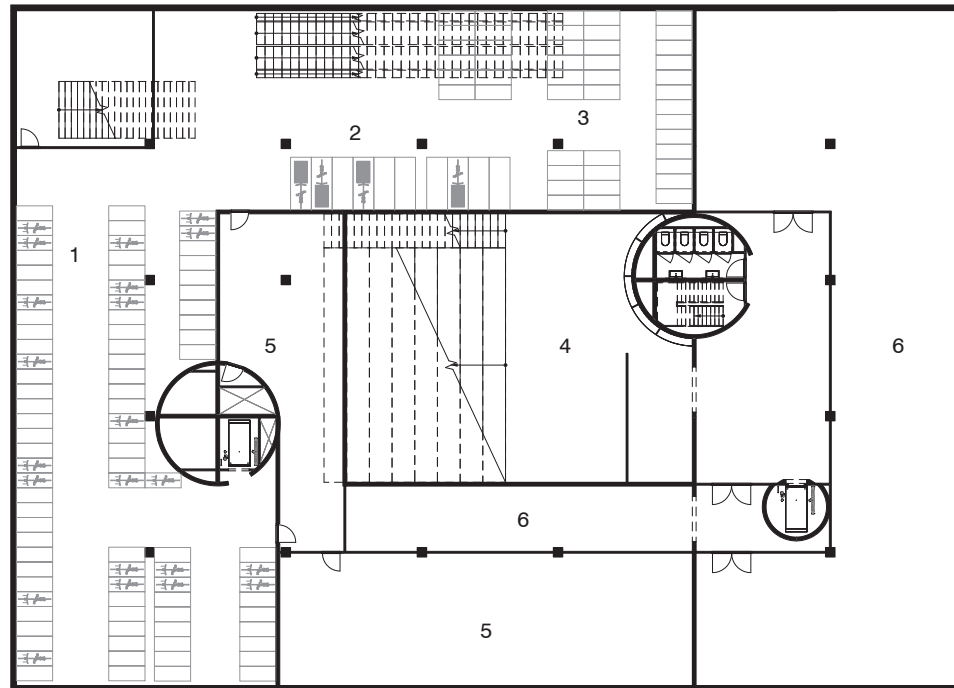

1. Stacked bike parking
2. Cargo bike parking
3. E-step parking
4. Auditorium
5. Mechanical room
6. Storage

GROUND FLOOR

MEET AND PRESENT

MEDIAHEIM BERLIN

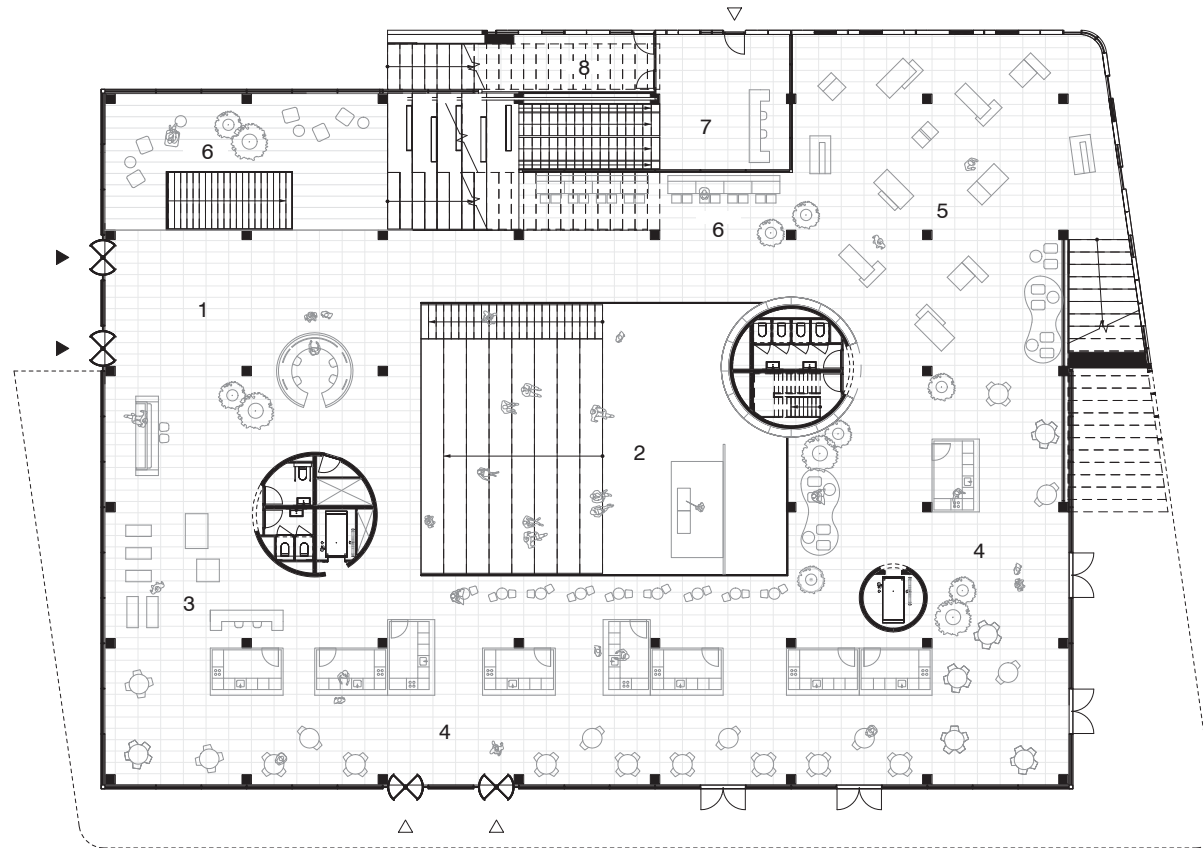

1. Entrance / Lobby
2. Auditorium
3. Media shop
4. Food-court
5. Exhibition
6. Lounge
7. Parking entrance
8. Storage

GROUND FLOOR

MEET AND PRESENT

MEDIAHEIM BERLIN

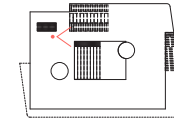

FIRST FLOOR

SEARCH AND CREATE

MEDIAHEIM BERLIN

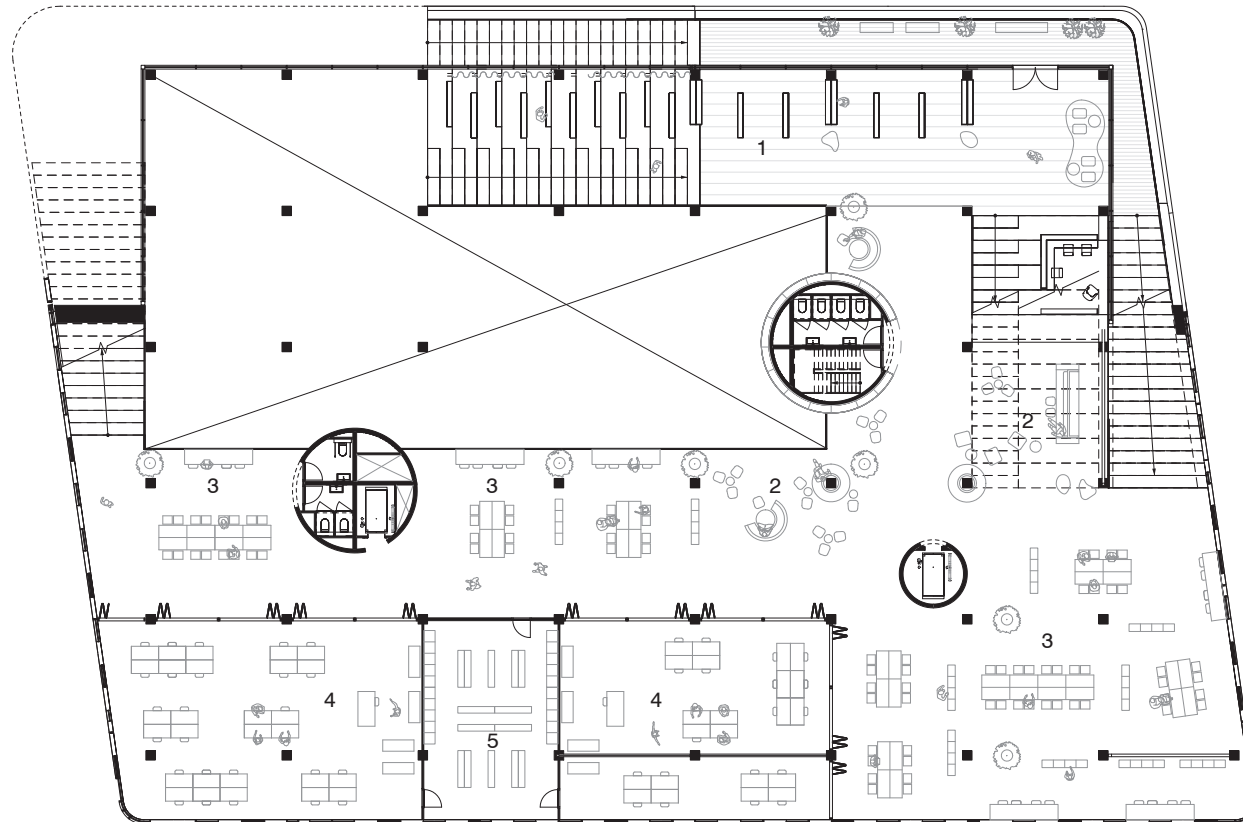

1. Library
2. Lounge
3. Open workshop
4. Workshop
5. Storage

FIRST FLOOR

SEARCH AND CREATE

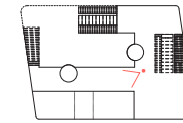

MEDIAHEIM BERLIN



SECOND FLOOR

LEARN AND PLAY

MEDIAHEIM BERLIN

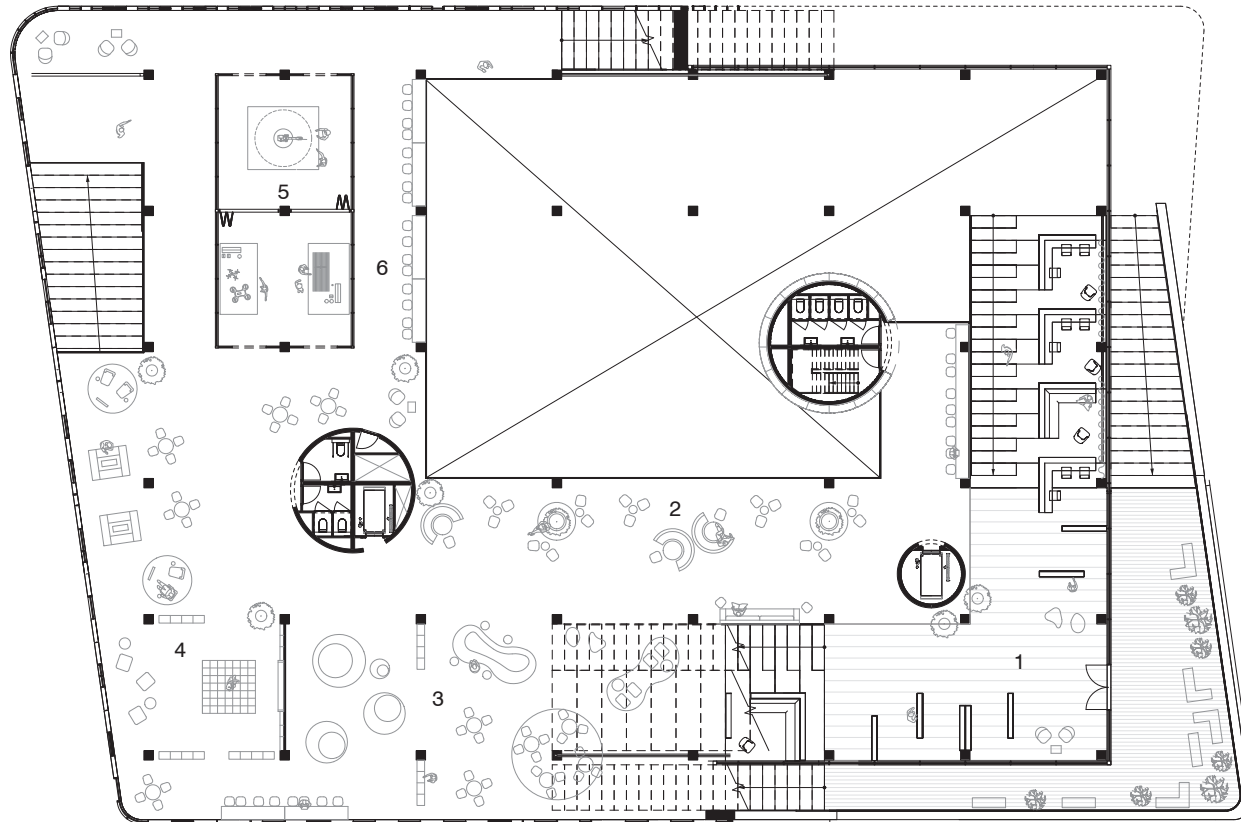

1. Library
2. Lounge
3. Kids area
4. Interactive play & learn
5. Laboratory
6. Workspaces

SECOND FLOOR

LEARN AND PLAY

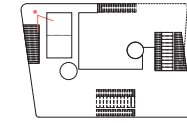

MEDIAHEIM BERLIN



THIRD FLOOR

MEET AND DEBATE

MEDIAHEIM BERLIN

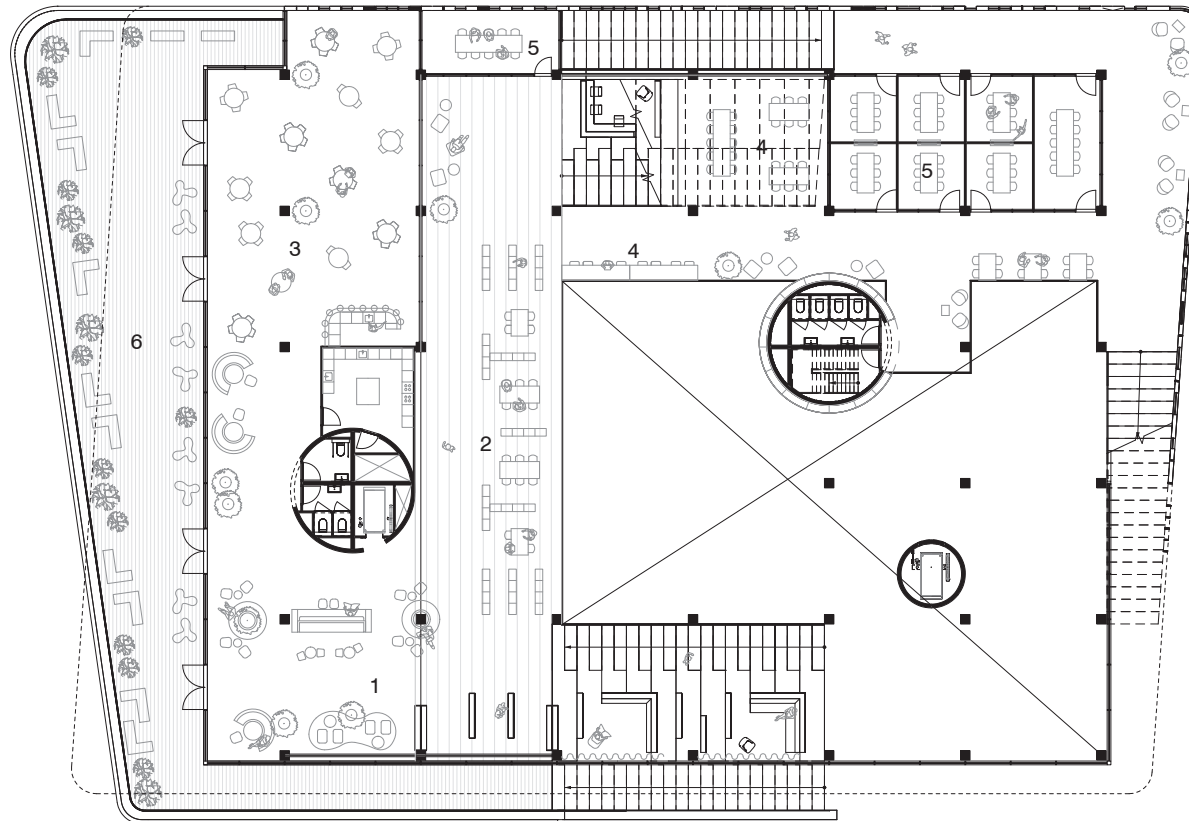

1. Lounge
2. Multimedia library
3. Café
4. Workspaces
5. Meeting rooms
6. Terrace

THIRD FLOOR

MEET AND DEBATE

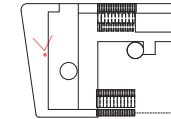

MEDIAHEIM BERLIN



FOURTH FLOOR

STUDY AND LISTEN

MEDIAHEIM BERLIN

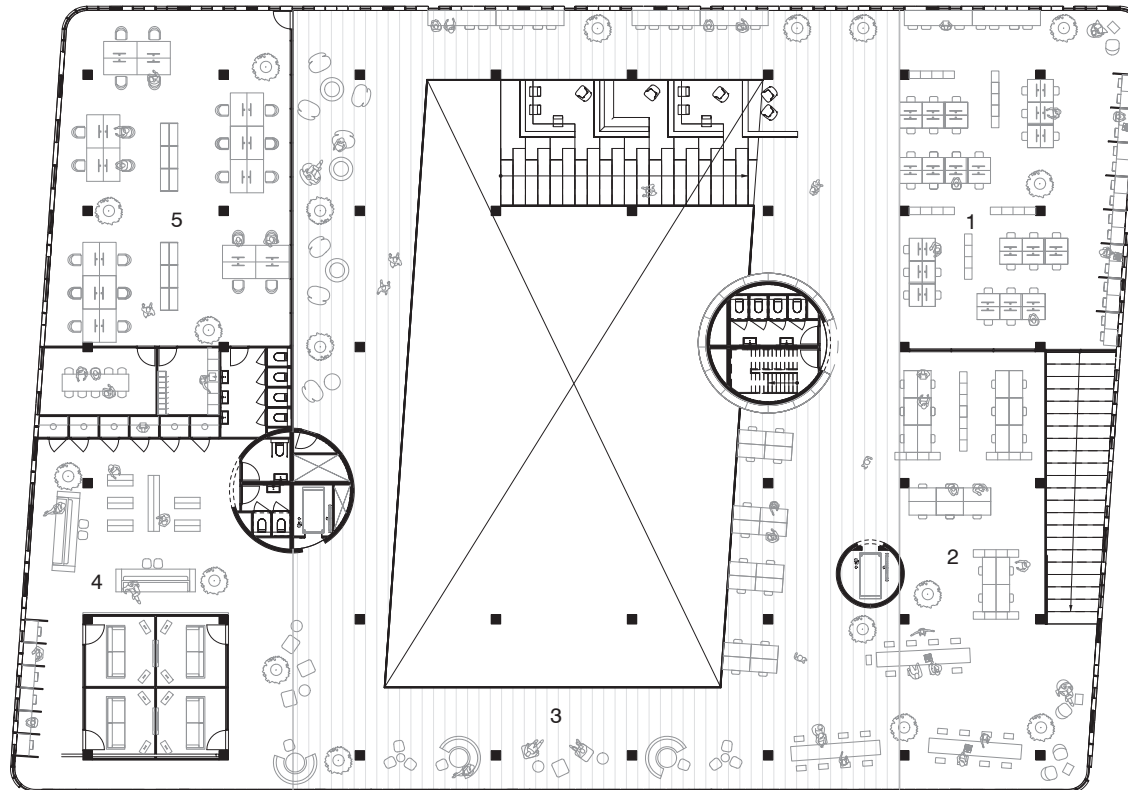

1. Digital area with focus rooms
2. Work & Study area
3. Lounge
4. Audio area with listen rooms
5. Offices

FOURTH FLOOR

STUDY AND LISTEN

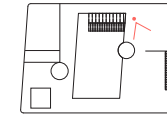

MEDIAHEIM BERLIN



MULTIPLICITY CONCEPT

MULTIFACETED PERFORMANCES

MEDIAHEIM BERLIN

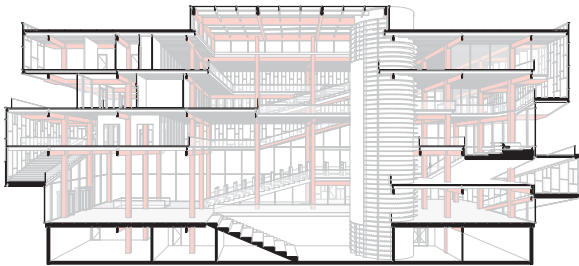
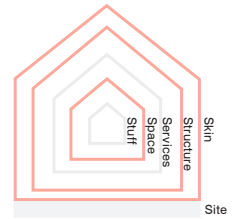

STRUCTURE FOR...

- the framework of the building
- defining rooms and spaces
- the flexibility of rooms and divisions
- absorption of carbon

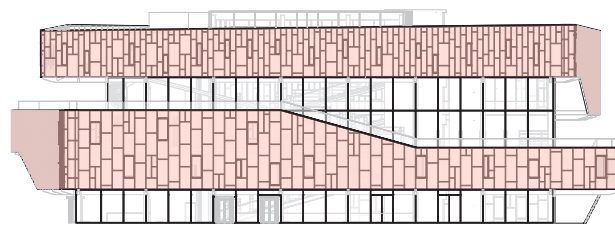

SKIN ACTS AS...

- separation between inside and outside
- relation with surrounding buildings
- communication of the buildings' function
- supply of natural ventilation and daylight

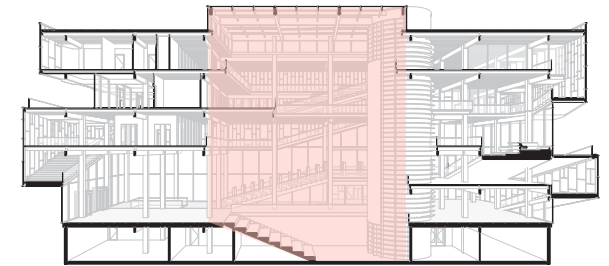

ATRIUM PROVIDES...

- a positive effect on the users' comfort perception
- sightlines and interaction between floors
- daylighting for centrally located functions
- night ventilation through the building

SHEARING LAYERS

GENERIC VS SPECIFIC ELEMENTS

GENERIC

STRUCTURE

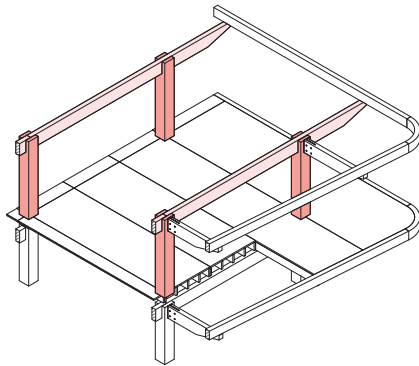

Columns and beams

SKIN

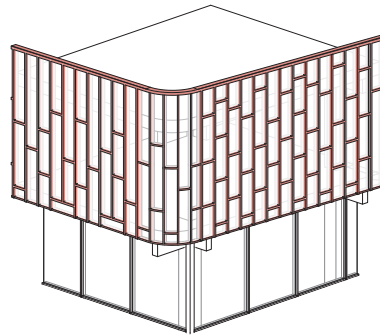

Facade system

SERVICES

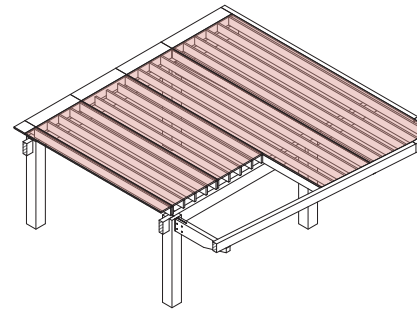

Hollow floors

SPACE

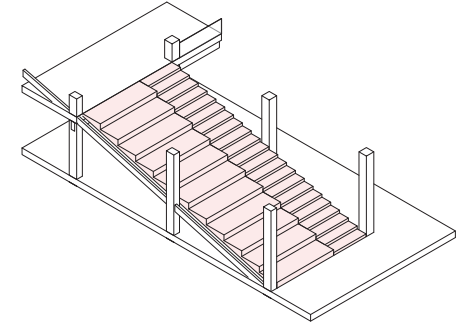

Circulation

SPECIFIC

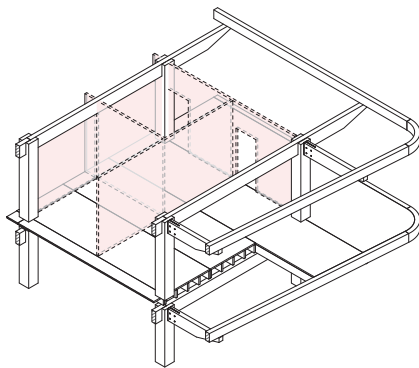

Spaces and infill

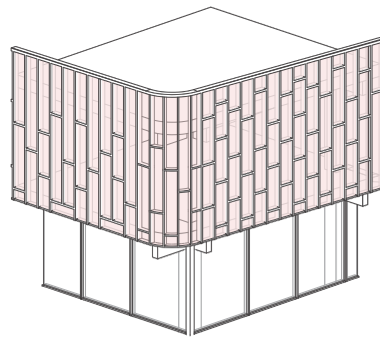

Panels and openings

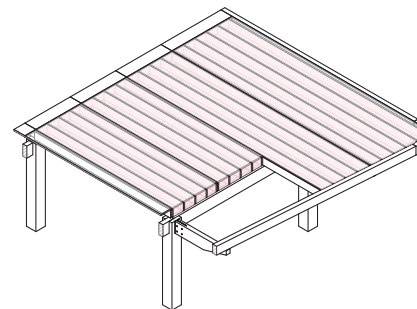

Open space for services

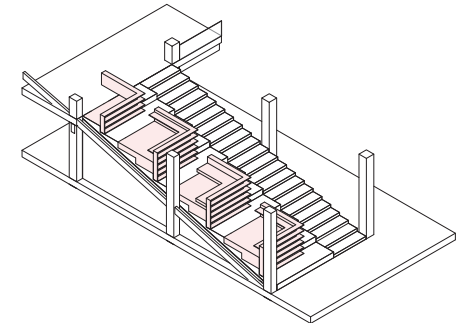

Multi-functionality of stair

STRUCTURE

STRUCTURAL AND STABILITY PRINCIPLES

MEDIAHEIM BERLIN

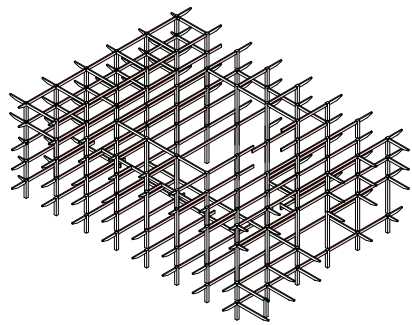
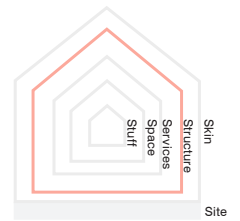

Post and Beam structure

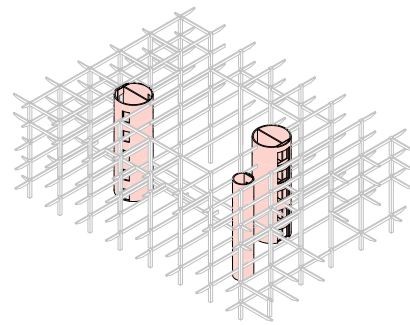

Concrete cores

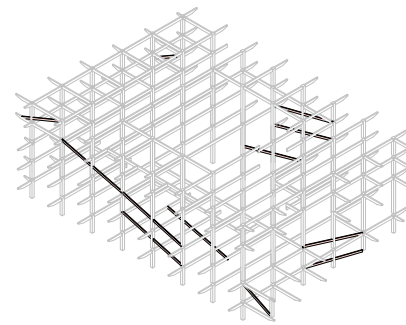

Trusses for stability

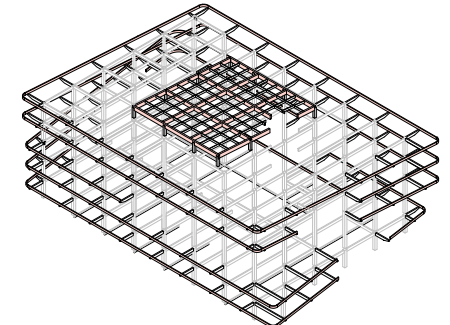

Extra construction

STRUCTURE

SUPPORTING STRUCTURE AND SPANS

MEDIAHEIM BERLIN

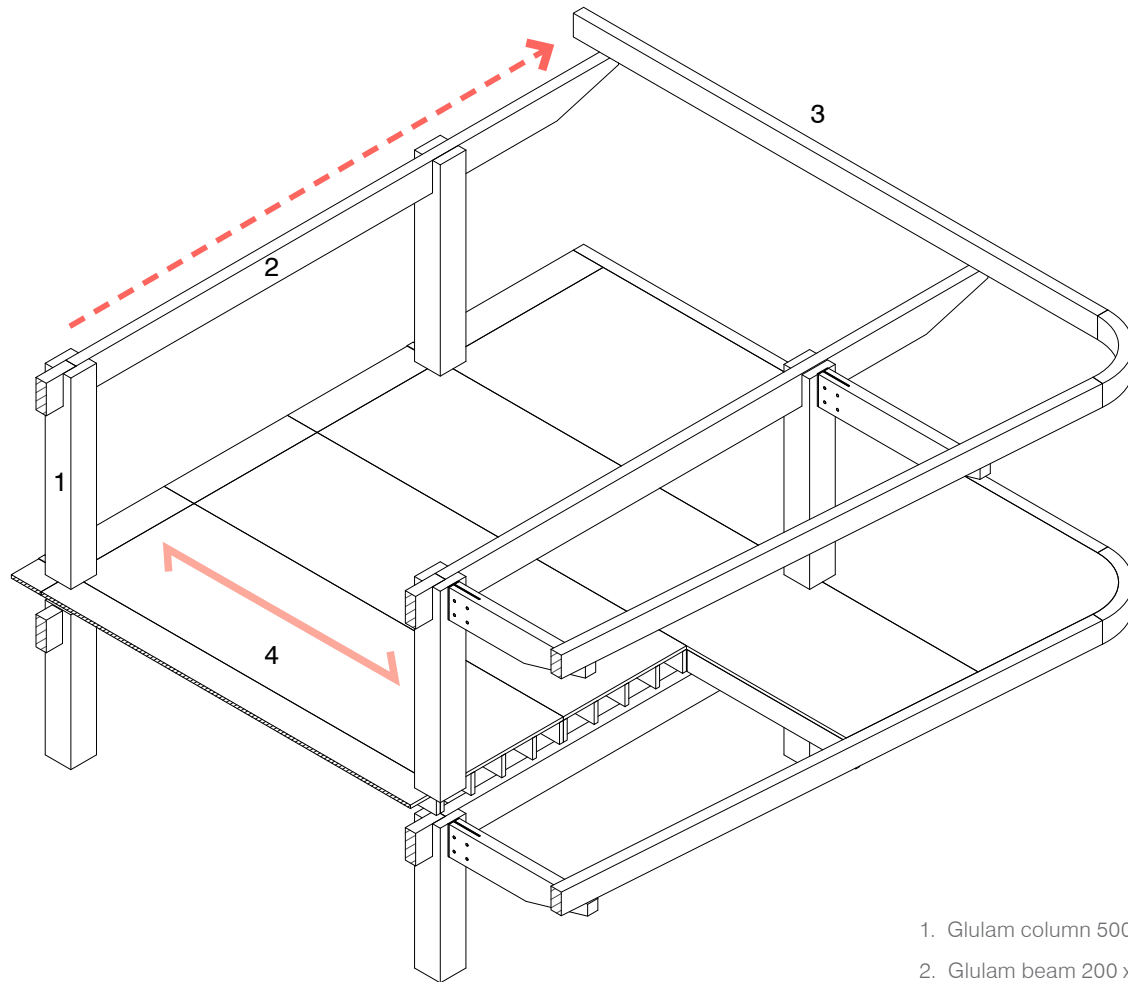
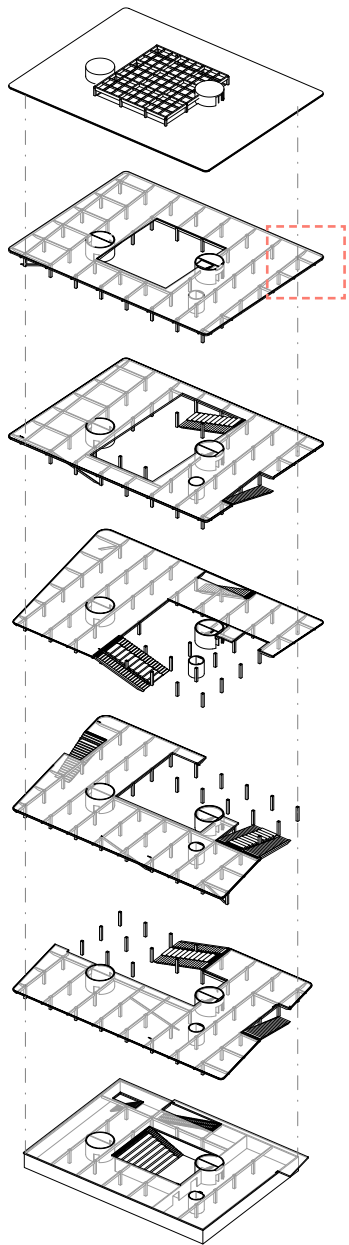

1. Glulam column 500 x 500
2. Glulam beam 200 x 500
3. Glulam facade edge beam 126 x 380
4. Kerto Ripa T system 7200 x 2400 x 380

SKIN LANGUAGE

CONCEPT OF SKIN CONTRASTS

MEDIAHEIM BERLIN

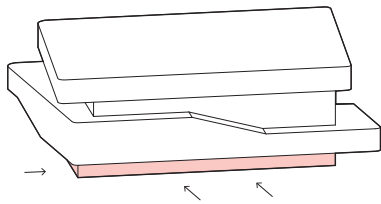
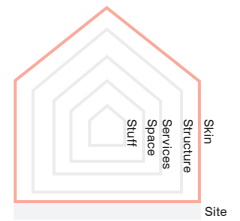

Transparent plinth

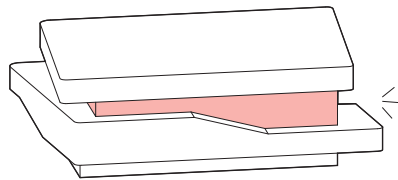

Library clearly visible from outside

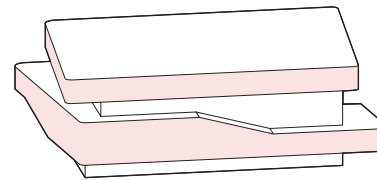

Other functions are semi-transparent

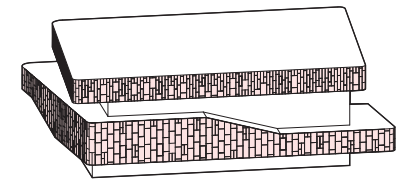

Facade pattern refers to bookcase

SKIN DEVELOPMENT

FACADE LAYOUT AND OPENINGS

MEDIAHEIM BERLIN



north facade - entrance outdoor route

west facade - main entrance



south facade - entrance foodcourt

east facade - entrance food-court

STRUCTURE AND SKIN

TRANSPARENCY AND TRANSLUCENCY

MEDIAHEIM BERLIN



Fragment of south facade

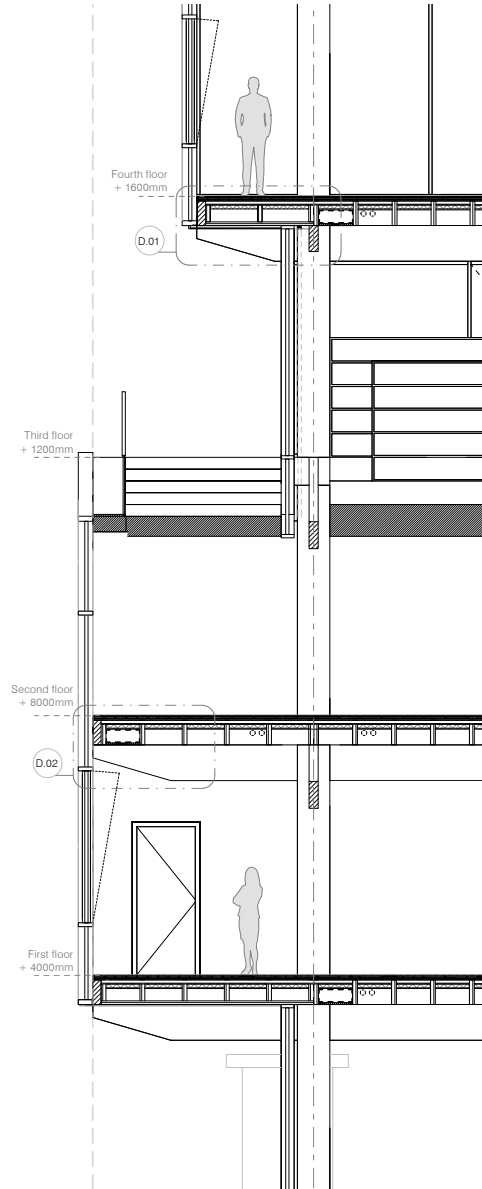

Section of south facade

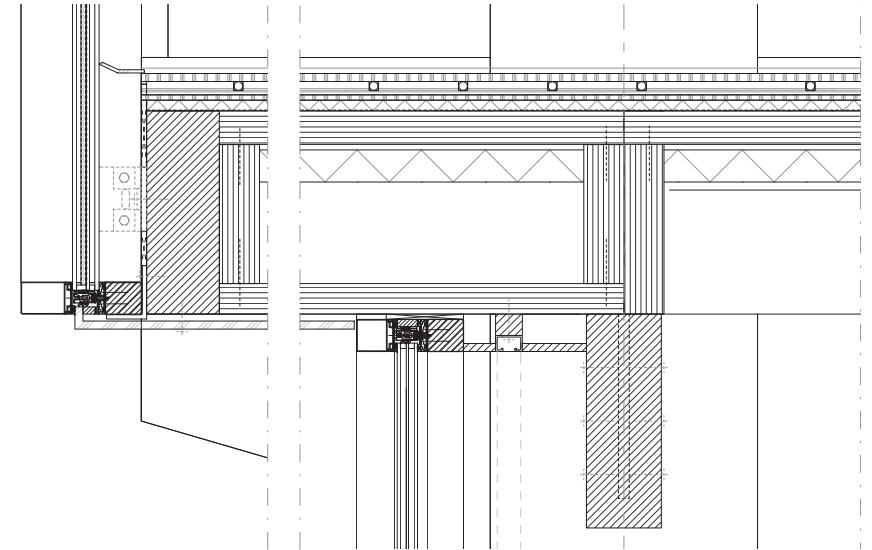

Detail 01 - Overhang

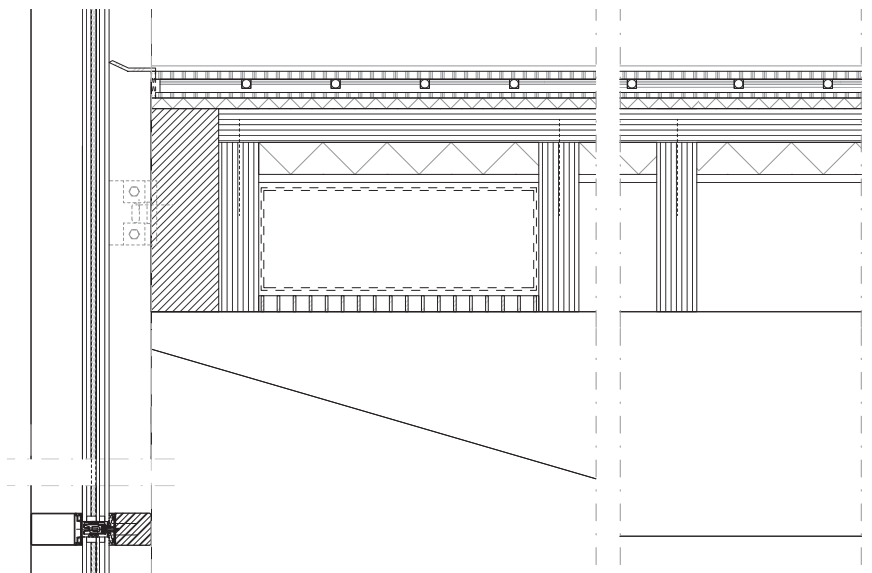

Detail 02 - Translucent facade

FIFTH FACADE

INCREASE BIODIVERSITY AND PRODUCE ENERGY

MEDIAHEIM BERLIN

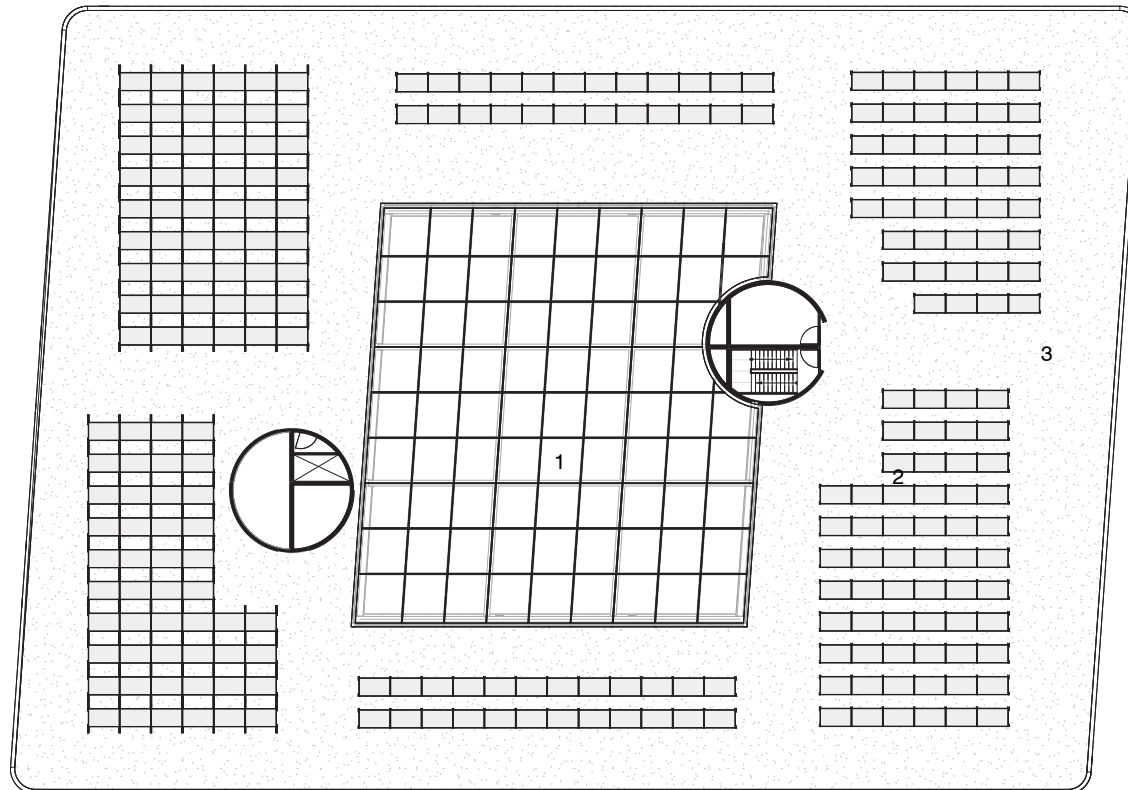
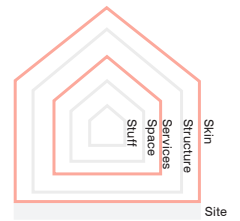

1. Atrium roof with translucent glass
2. Solar panels facing south-west
3. Green roof, collecting rainwater

BUILDING SERVICES

CLIMATE SYSTEM IN SUMMER

MEDIAHEIM BERLIN

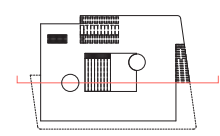
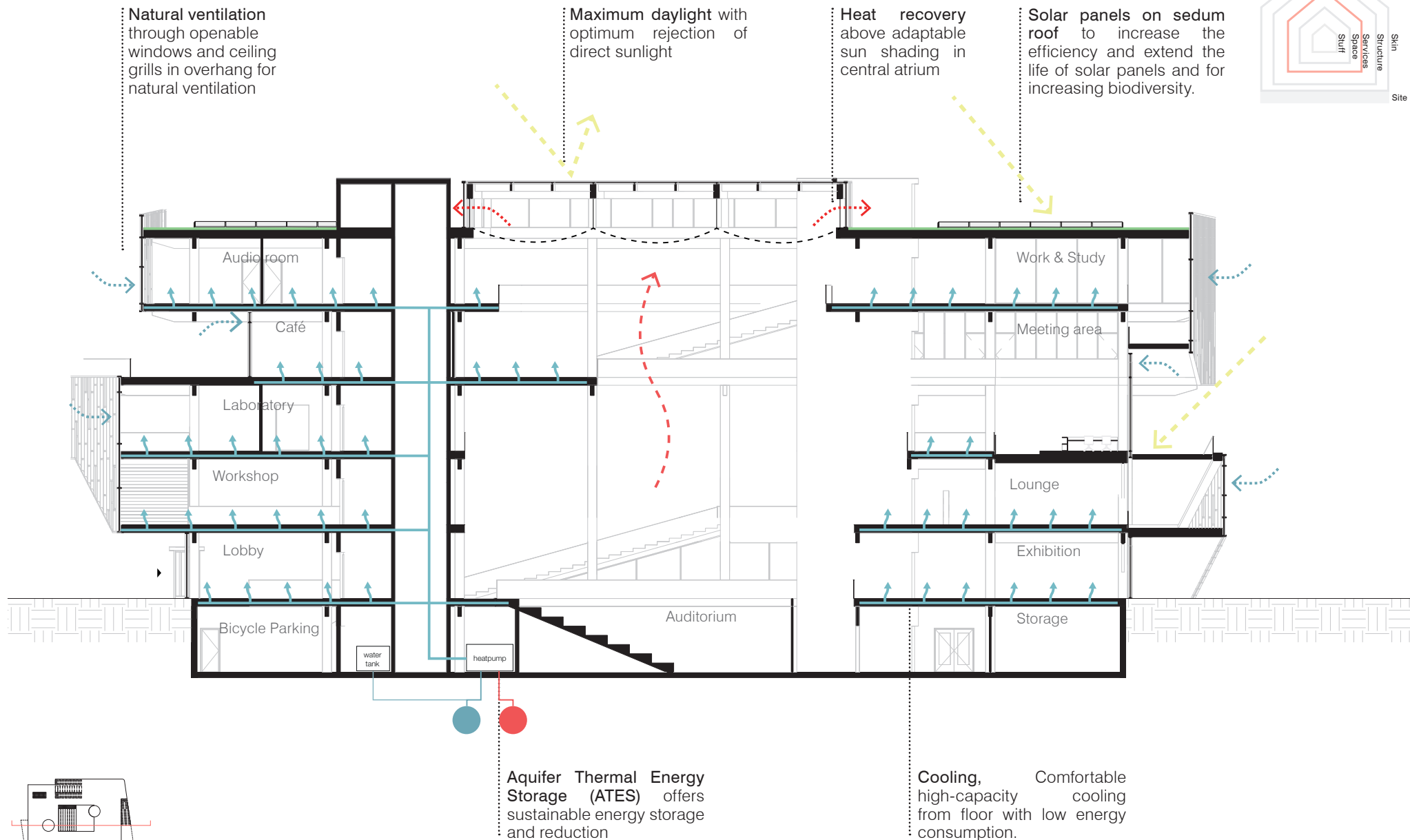
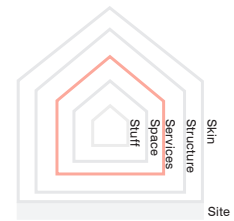

BUILDING SERVICES

CLIMATE SYSTEM IN WINTER

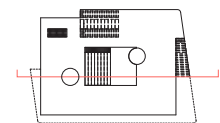
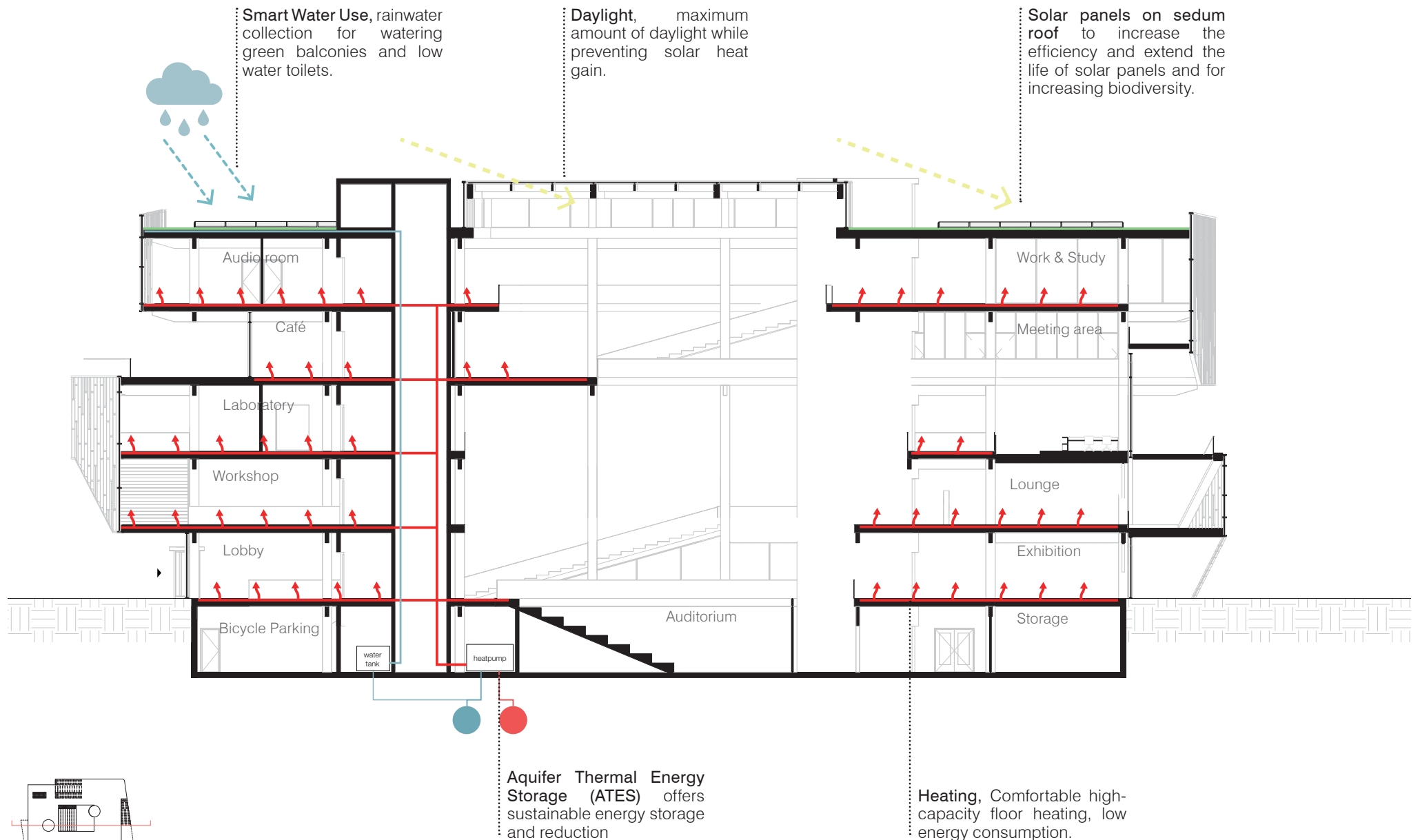

BUILDING SERVICES

VENTILATION SYSTEM

MEDIAHEIM BERLIN

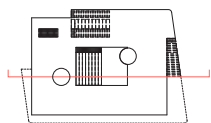
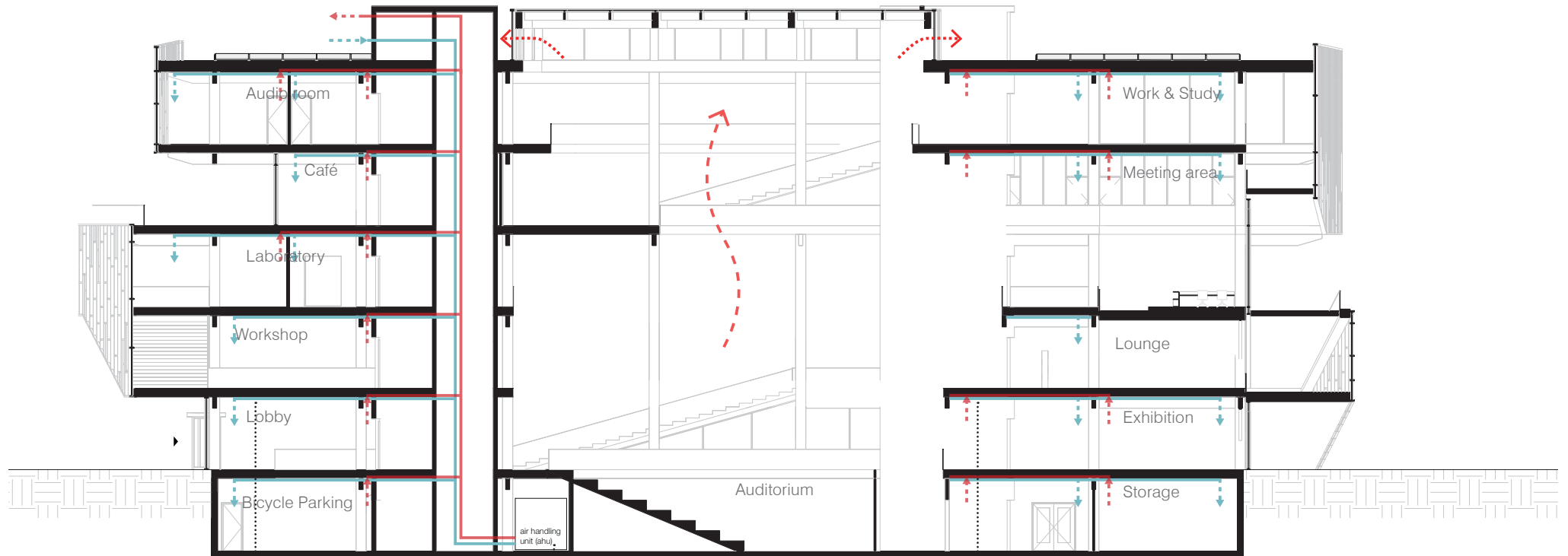

Fresh air supply from facade, through ceiling

Ventilation type C (natural supply and mechanical extraction) with heat recovery system

Mechanical extraction with heat recovery system

Scale, 1:200

CARBON BASED DESIGN

REDUCE, REUSE AND RECYCLE

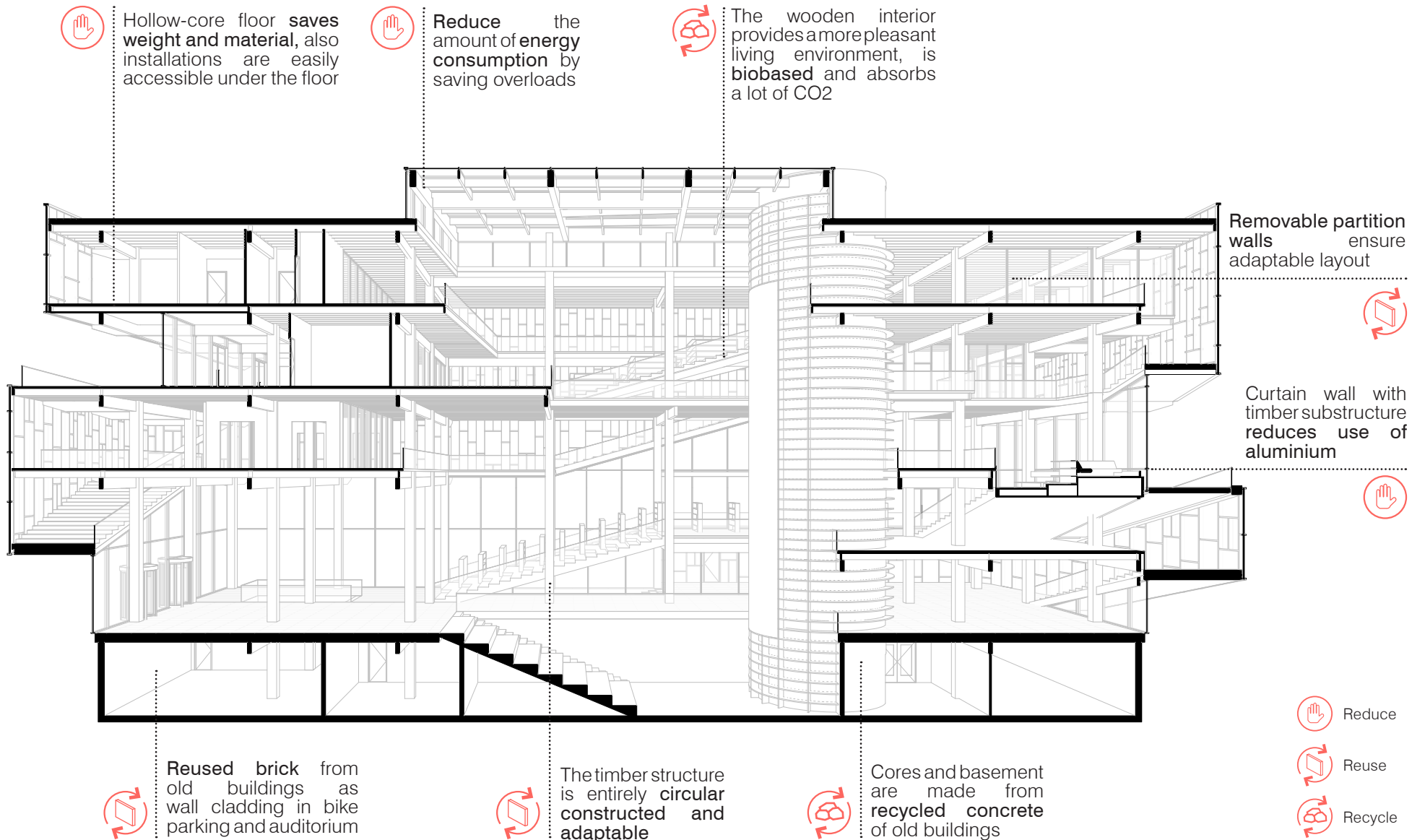

CARBON IN STRUCTURE AND SKIN

CARBON POSITIVE BUILDING

MEDIAHEIM BERLIN

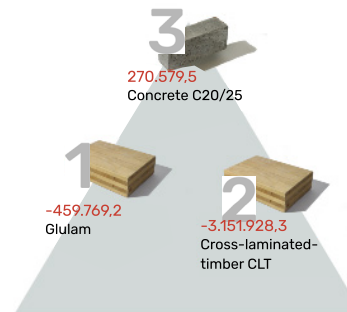
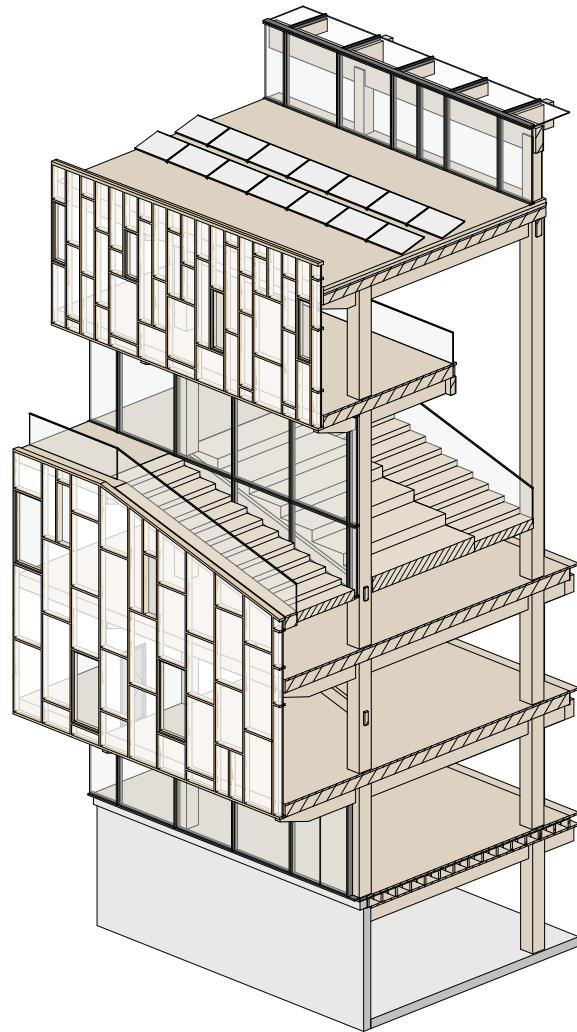
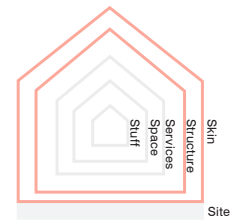

| kg CO₂ eq
| module A1-A3

Timber structure

Your pyramid:
-3.341.118,0 kg CO₂ eq

-334.1 kg CO₂ eq/m²

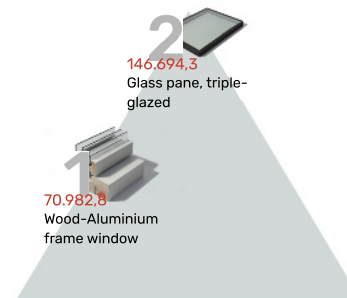

| kg CO₂ eq
| module A1-A3

Facade

Your pyramid:
217.677,1 kg CO₂ eq

21.8 kg CO₂ eq/m²

Total GWP impact of structure and facade:

-3.123.440,9 kg CO₂ eq

-312,3 kg CO₂ eq / m²

CARBON IN STEEL AND CONCRETE

CHANGING USUAL BUILDING STRUCTURES

MEDIAHEIM BERLIN

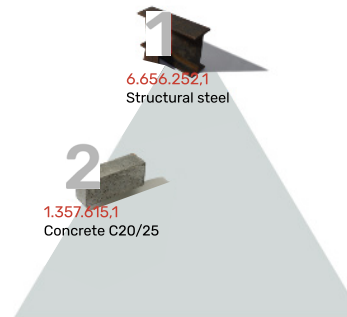
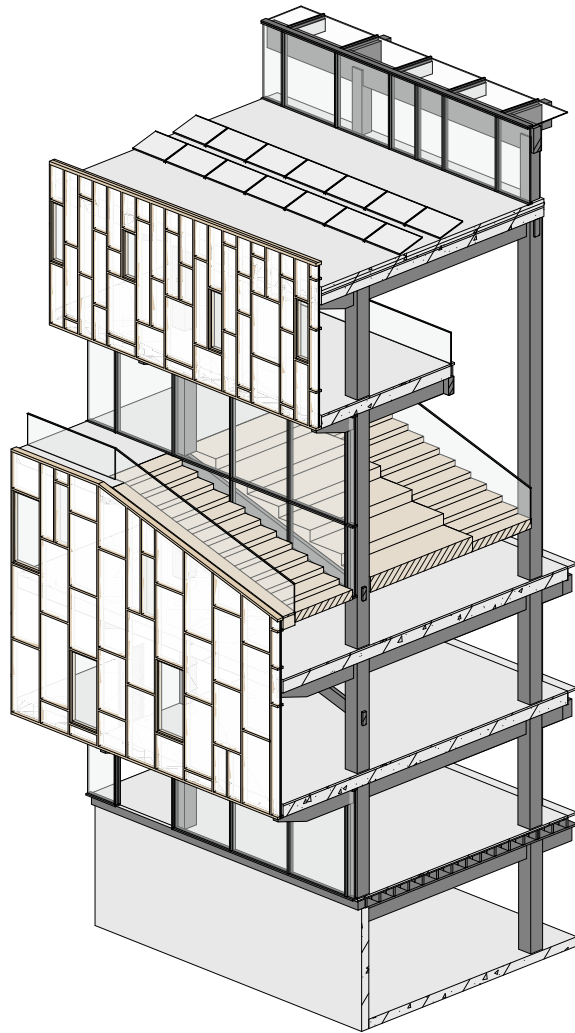
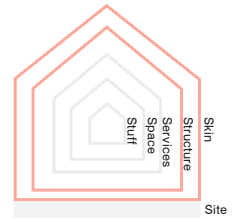

| kg CO₂ eq
| module A1-A3

Steel / Concrete structure

**Your pyramid:
8.013.867,1 kg CO₂ eq**

801.4 kg CO₂ eq/m²

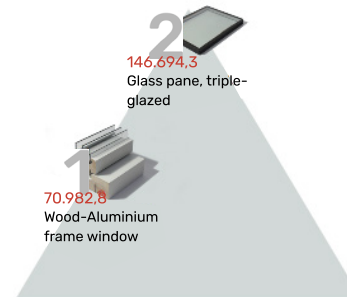

| kg CO₂ eq
| module A1-A3

Facade

**Your pyramid:
217.677,1 kg CO₂ eq**

21.8 kg CO₂ eq/m²

Total GWP impact of structure and facade:

8.231.544,2 kg CO₂ eq
823,1 kg CO₂ eq / m²

ACTIVE DESIGN

CIRCULATION VISIBLE IN FACADE

MEDIAHEIM BERLIN



ACTIVE DESIGN

STIMULATE USERS TO TAKE THE STAIRS

MEDIAHEIM BERLIN

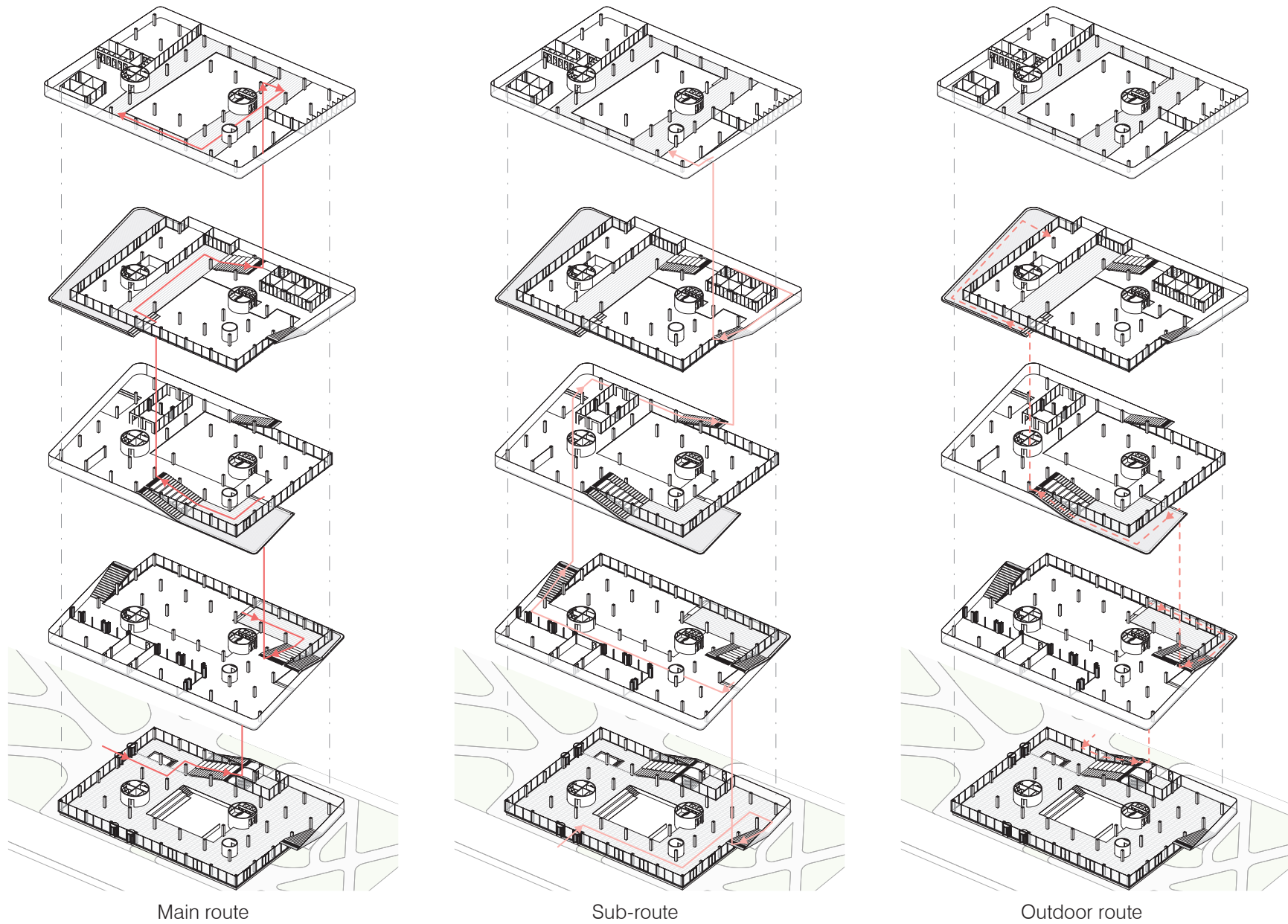

ACTIVE DESIGN

STIMULATE USERS TO TAKE THE STAIRS

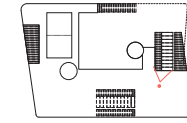

MEDIAHEIM BERLIN



MAIN ROUTE

MULTIFUNCTIONAL CIRCULATION

MEDIAHEIM BERLIN

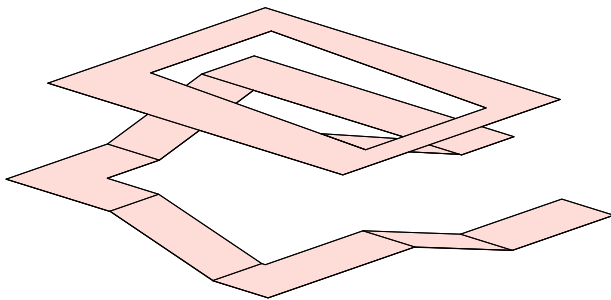

Spiral routing upwards

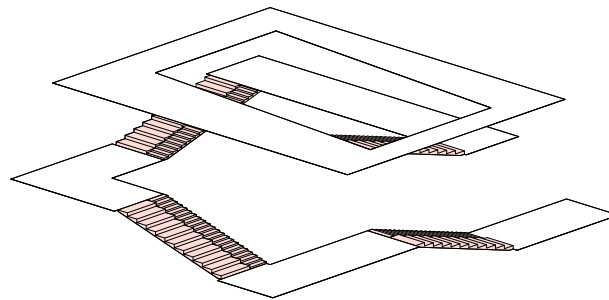

Division of stairs

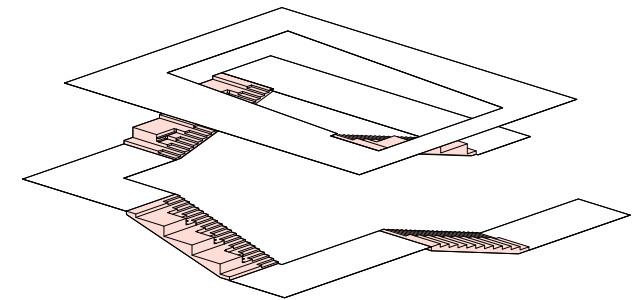

Multiplicity of stairs

MAIN ROUTE

MULTIFUNCTIONAL CIRCULATION

MEDIAHEIM BERLIN

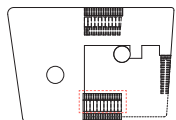
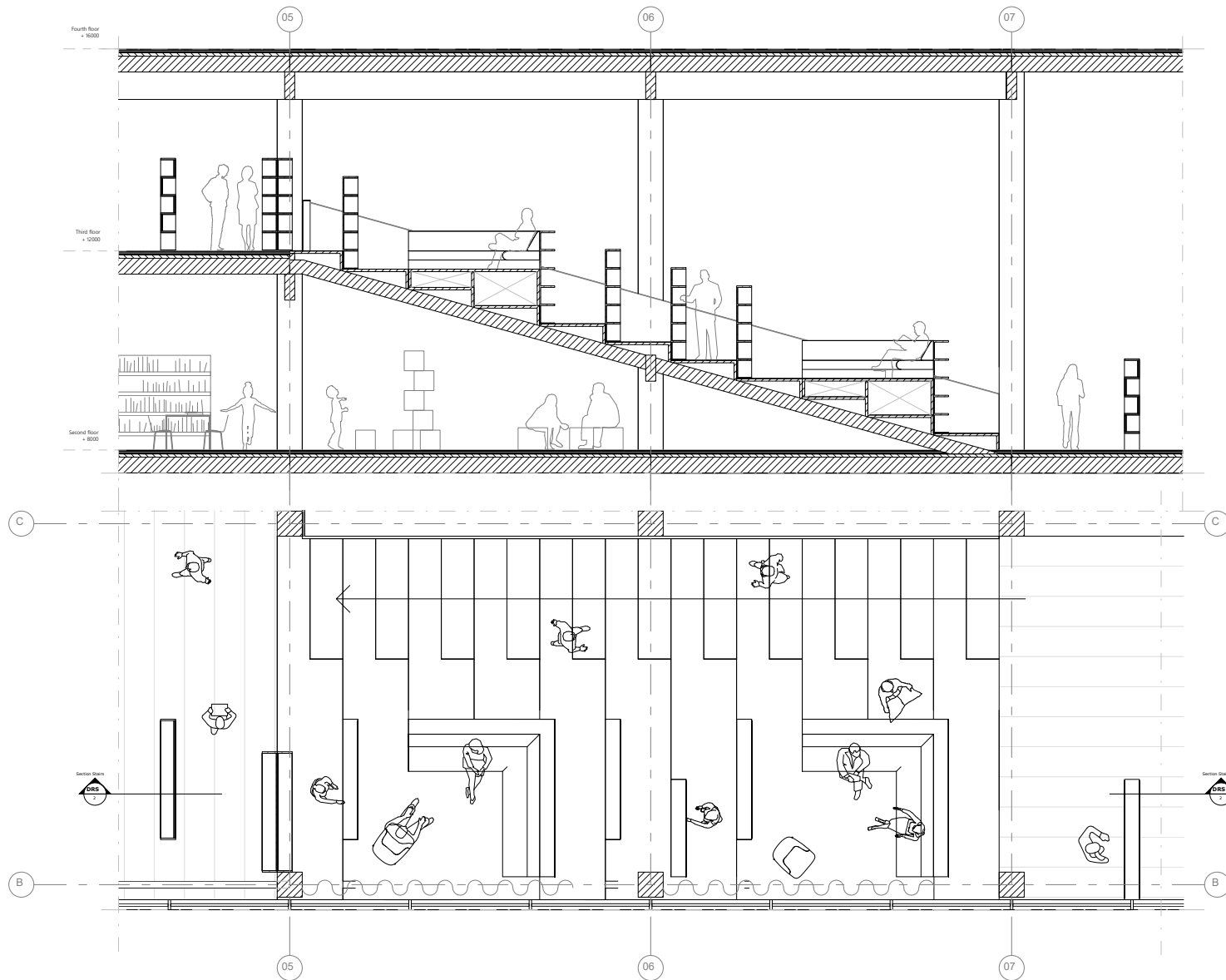
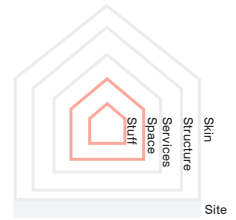

MULTIFUNCTIONAL DESIGN

STORAGE FOR BOOKS AND SCREEN TO STREAM

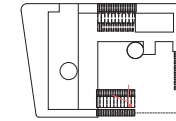

MEDIAHEIM BERLIN



MULTIFUNCTIONAL DESIGN

FUNCTION OF MAIN STAIRS CAN CHANGE

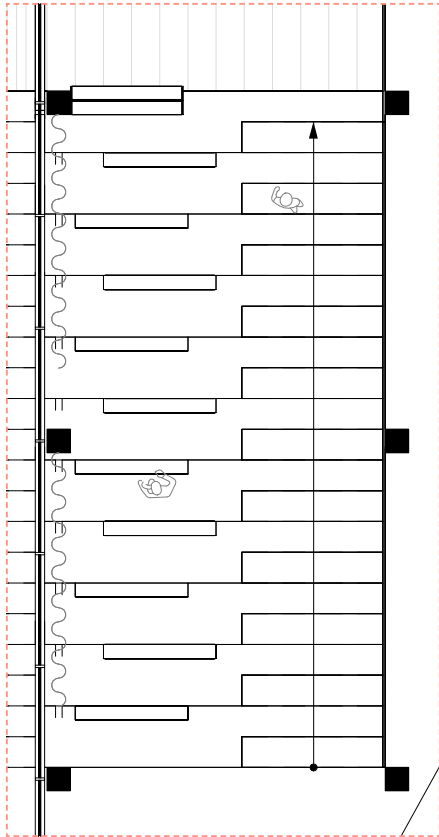

Book storage

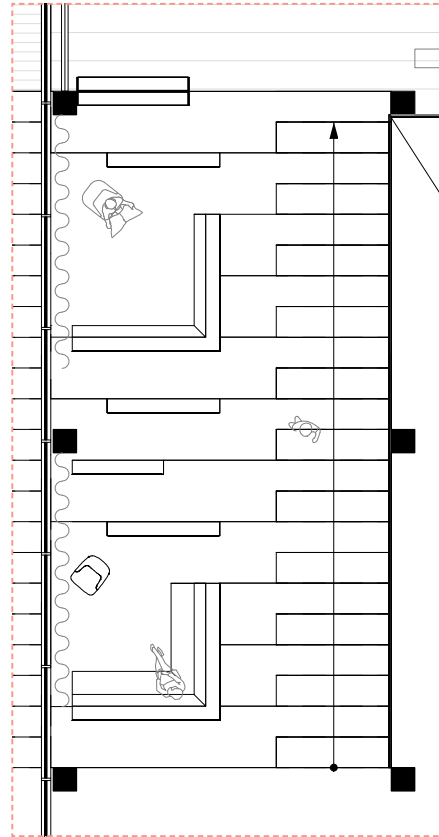

Books and lounge

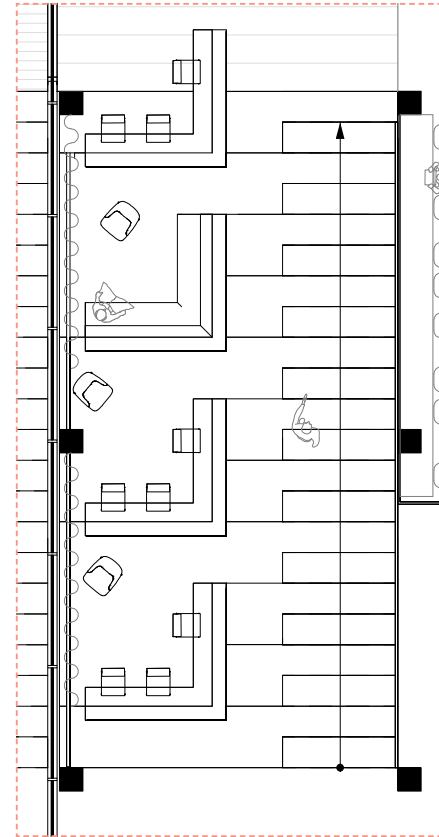

Read and work

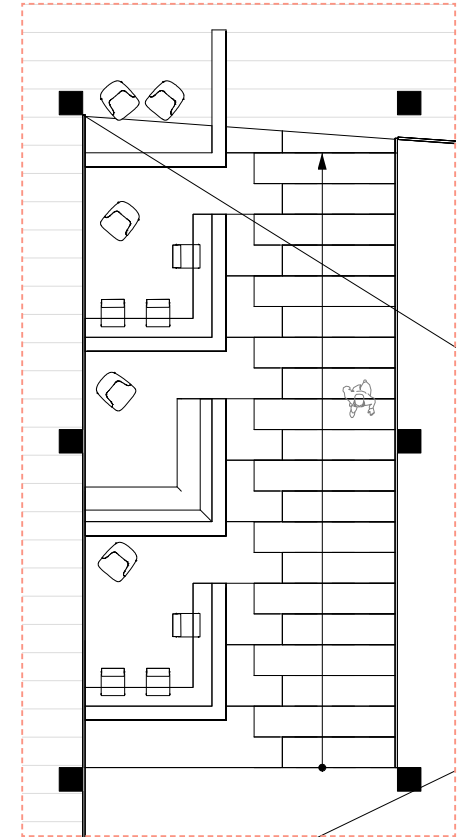

Read and study

ADAPTABLE DESIGN

SPATIAL VARIABILITY

WALL BASED

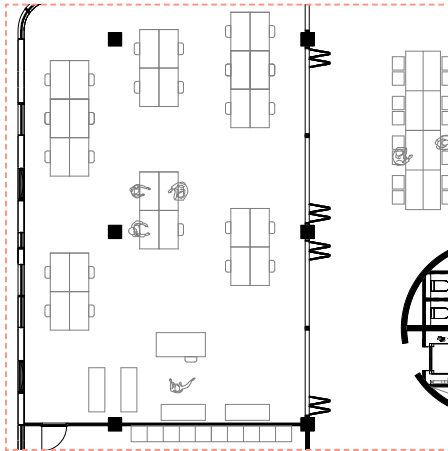

Facade oriented

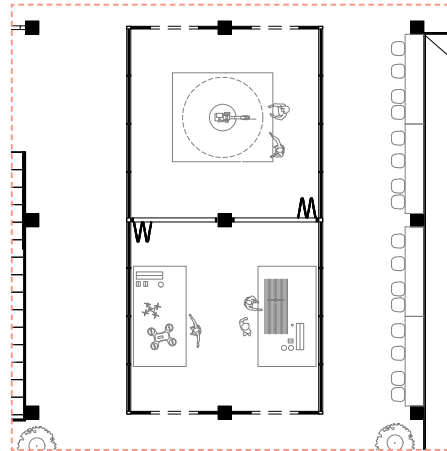

Centred

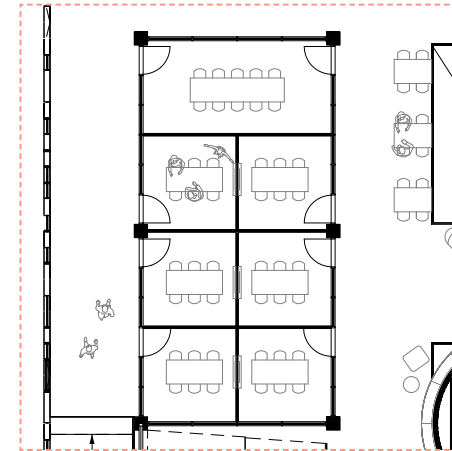

Within structure

OPEN INFILL

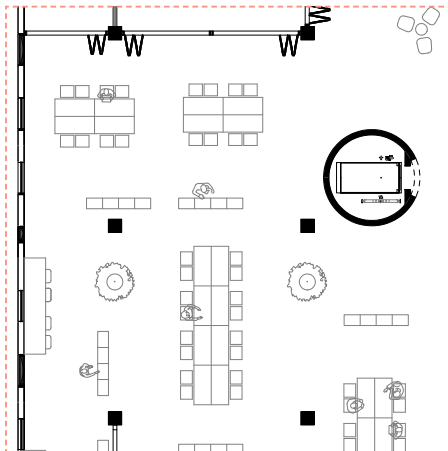

Wall elements

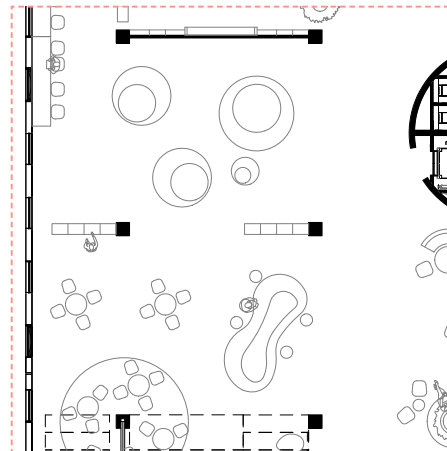

Different modules

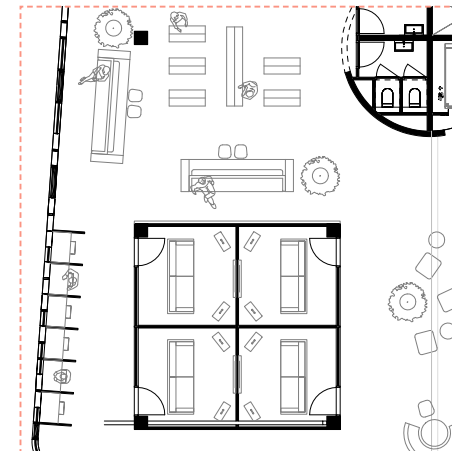

Small box

ADAPTABLE DESIGN

FLEXIBLE INFILL

MEDIAHEIM BERLIN

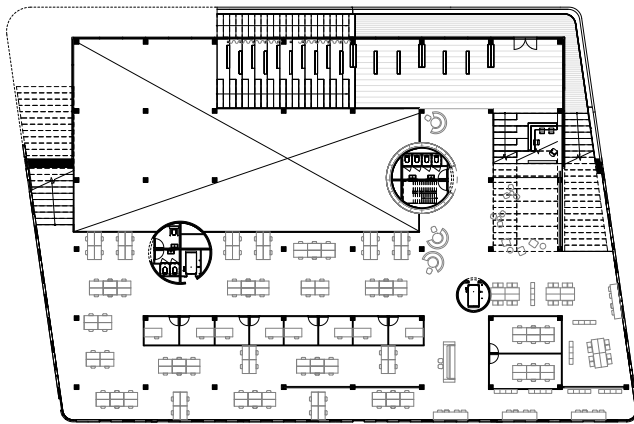

Open workspaces

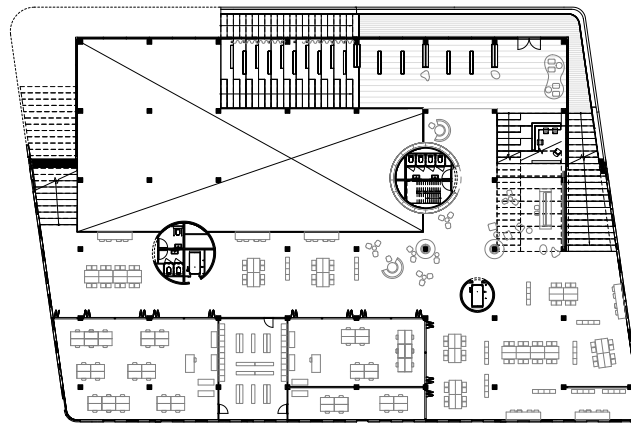

Semi-open workshops

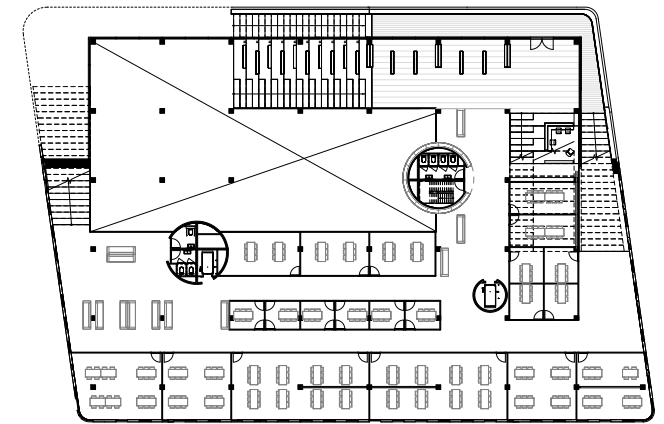

Closed offices



CONCLUSION

NEW LIBRARY TYPOLOGY

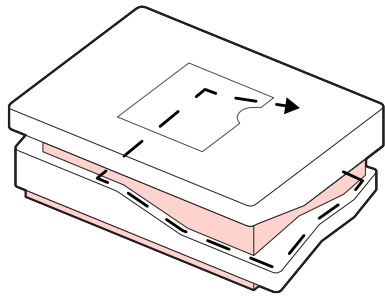

VISIBLE AND ACCESSIBLE

Library route is folded as a spiral around the building, in this way it is clearly visible and accessible from the public street

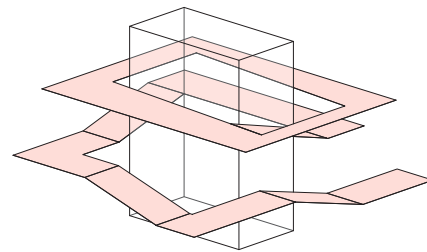

INTERACTIVE

Circulation and functions organised around central atrium with sightlines between floors

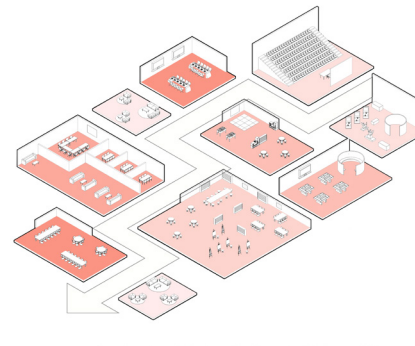

DIVERSITY

Different spatial experiences attracts multiple target groups and generations

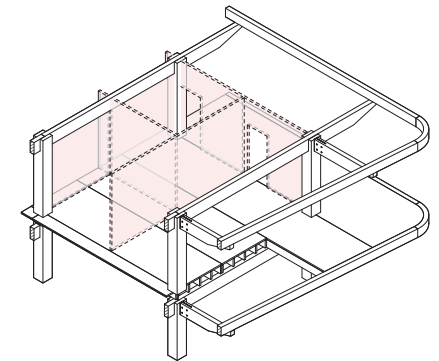

FLEXIBLE

Infill of structure, facade and multifunctional stairs are adaptable for future changes



Iris van der Moolen | 5482887
MSc 4 Studio | 2022-2023
Chair of Public Building