

Document Version

Accepted author manuscript

Citation (APA)

Broos, E., Sibbes, R., & de Gijt, J. (2017). Widening a harbor basin, demolition of a deep see quay wall in Rotterdam. In *Conference Proceedings COME 2017 - Decommissioning of Offshore Geotechnical Structures: March 28-29, 2017 Hamburg, Germany* (Vol. 38). (Veröffentlichungen des Institutes Geotechnik und Baubetrieb; Vol. 38). Hamburg University of Technology.

Important note

To cite this publication, please use the final published version (if applicable).
Please check the document version above.

Copyright

In case the licence states "Dutch Copyright Act (Article 25fa)", this publication was made available Green Open Access via the TU Delft Institutional Repository pursuant to Dutch Copyright Act (Article 25fa, the Taverne amendment). This provision does not affect copyright ownership.
Unless copyright is transferred by contract or statute, it remains with the copyright holder.

Sharing and reuse

Other than for strictly personal use, it is not permitted to download, forward or distribute the text or part of it, without the consent of the author(s) and/or copyright holder(s), unless the work is under an open content license such as Creative Commons.

Takedown policy

Please contact us and provide details if you believe this document breaches copyrights.
We will remove access to the work immediately and investigate your claim.

Widening a harbor basin, demolition of a deep sea quay wall in Rotterdam

Erik Broos, Rob Sibbes, Jarit de Gijt

Abstract: The rapid development in containership dimensions creates a huge challenge for ports. But for one port basin in Rotterdam this challenge was too big. The nautical restrictions for the Amazonehaven would start at such moderate conditions that the basin would be closed for Ultra Large Container Ships (ULCS) about a 100 days a year. As this basin contains more than 60 percent of the deep sea quay length at ECT, Europe's largest container terminal, the Port of Rotterdam Authority decided to widen the basin by demolishing the opposite iron ore bulk quay wall. In this way vessels up to 18.000 TEU have access up to 6 Beaufort wind speed.

This quay wall, with a length of 950 meters and a retaining height of 32 meters, was constructed between 1988 and 1990 with an inclined steel combi wall, concrete pre stressed bearing piles, MV piles and a massive concrete superstructure. It is the first ever demolished quay wall on this scale in Rotterdam and, as far as the authors know, even globally.

Before the demolition could start, a new quay wall, with a length of 2500 meters was constructed and over 3 million cubic meters of sand had to be removed. All works are executed without interrupting the process at the ECT terminal.

The paper describes the necessity of the widening project and focusses on the demolishing process and especially the lessons learned from this project. Most important items are unexpected heavy pile damage probably due to heavy pile driving during construction and the drill and blast operation in an operational port basin.

1 The up come of the ULCS

In the past vessel sizes grew steady but rather slow. At the start of this century ships of 10,000 TEU were expected between 2005 and 2010. This development changed in 2006 when Maersk introduced the E-class. This class made a rough step from expected 10,000 TEU towards 14,500 TEU. This step initiated a rapid growth in vessel dimensions and resulted today in a large fleet of ULCS.

ULCS are defined as larger than 10,000 TEU, longer than 350 m and wider than 42 m. The most frequent used size is the New Panamax, length 366 m, width 49 m, draft 15.2 m, with a capacity between 13,000 and 14,000 TEU. Today ships grow over 20,000 TEU and 22,000 is (in 2017) talk of the town.

2 The challenge of ever growing ships at the ECT delta

ECT Delta Terminal at the Maasvlakte in Rotterdam is the largest container terminal in Europe. All major shipping lines at ECT Delta started to use ULCS. The ECT Delta terminal uses two main deep sea quays. The Europahaven and the Amazonehaven (Figure 1). There are no nautical issues at the Europahaven side, smallest sailing path is 355 m wide, but there were major issues at the Amazonehaven side.

Some ULCS would get, under the worst current conditions, sailing restrictions starting at 3 Beaufort wind speed. 3 Beaufort is exceeded a hundred days a year. These restrictions would

mean that the terminal would no longer be commercial viable. As the Amazonehaven contains 2.6 of the total of 4 km deep sea quay wall at ECT Delta, this would be a disaster.



Figure 1: ECT Delta Terminal (yellow area), with Amazonehaven on the front

3 Nautical simulation studies

The Nautical department of the Port of Rotterdam Authority started a large nautical simulation program to predict what shape of the Amazonehaven basin would be needed to host the largest ships. The research started with desk (computer) studies and ended with real time full mission bridge simulations. These simulations indicated that a ULCS of 387x56x17 m (LxBxD) could safely enter the widened basin up to at least 6 Beaufort wind speed. During the demolition the CMA CGM Marco Polo set sail. This vessel was simulated as well and was only allowed to enter the basin after the widening. 5 days after the project delivery by the contractor, the CMA CGM Marco Polo ‘officially opened’ the widened Amazonehaven.

4 The proposed profile

The outcome of this study was that the EMO quay wall (EMO = Europese Massagoed Overslag) on the south of the Amazonehaven had to be removed (Figure 2). However, at the same time a new power plant was constructed at the south side of the basin and this created some extra challenges (Broos, 2014).

The ideal profile was a 275 m wide sailing path for the ULCS with additional 35 m maneuvering space for assisting tugs. This results in a 310 m wide basin. After 2 ship lengths i.e. 800 m, the width of the basin could be reduced down to 240 m plus additional tug maneuvering space. This profile fitted rather well with the coal mixing silos (section A3-1 in Figure 2) that were newly constructed just west of the EMO quay, about 1100 m from the entrance of the basin.

As after the coal mixing silos there was some spare land that was turned in to barge berths, resulting in a visual wider basin of 340 m. But draught is limited to 4.5 m in this area (section

A3-3 in Figure 2). Although the other 1800 m are designed as a quay wall, this is in fact a very heavy earth retaining wall, as mooring is forbidden (sections A1 till A3-2 in Figure 2).

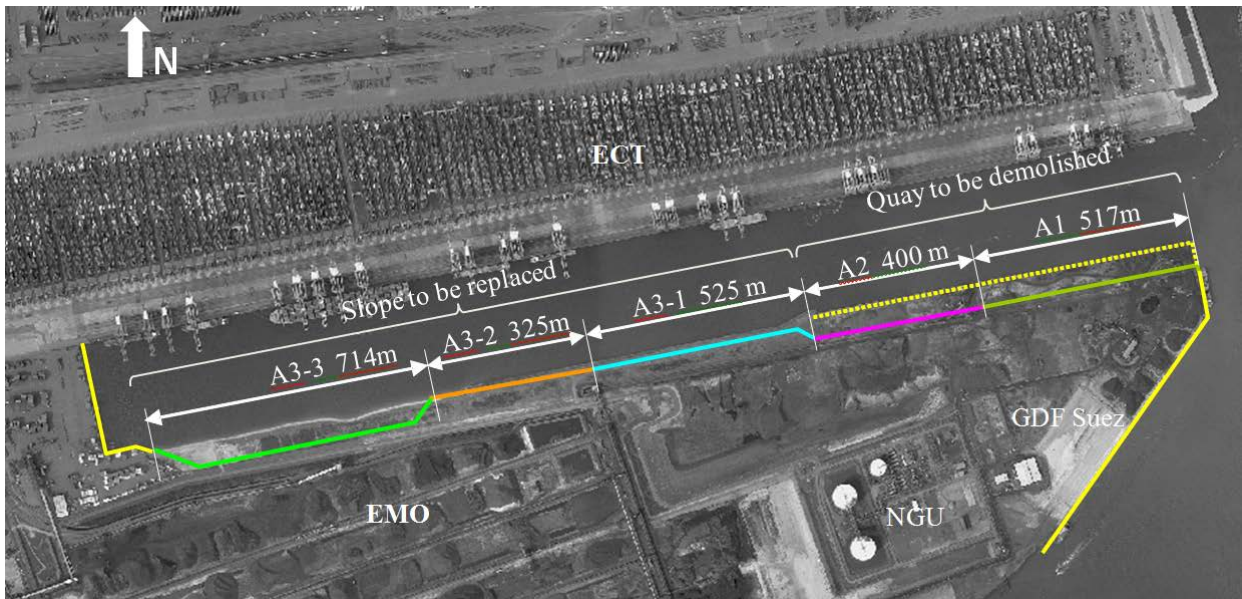

Figure 2: Aerial picture with in color the new basin shape & quay wall

5 How to widen a port basin

To create this profile, first a new quay/ earth retaining wall had to be constructed south of the old quay and south of the old slope. Then the soil had to be removed and finally the old quay wall had to be demolished. Obviously shipping towards ECT had to continue always. This limited the contractor in his marine activities.

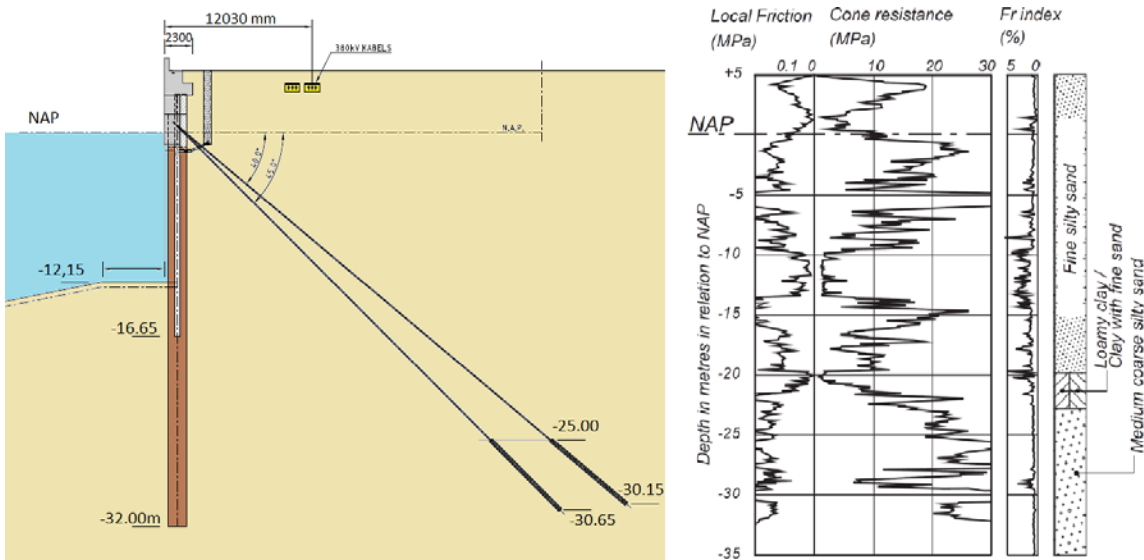

Figure 3: Cross section quay wall and typical CPT for Maasvlakte area

6 The new build quay wall

The new quay wall (Figure 3) is a rather simple construction with a retaining height of 20 m. It is a typical Rotterdam solution. There is a firm Pleistocene sand layer below NAP -20 m covered with silty sandy Holocene layers (see Cone Penetration Test (CPT) in Figure 3).

NAP means ‘Normaal Amsterdams Peil’ and is the Dutch reference level, it is roughly Mean Sea Level. Groundwater at the site is at NAP or above. The tubular king piles in the combi-wall bear the vertical loads and resist the bending moments. The intermediate sheet piles provide soil tightness. The drilled anchors provide horizontal stability and the concrete capping beam spreads the loads and provides a mooring surface. More can be found in Rijckaert (2014).

7 The quay wall to be demolished

The real challenge in the project appeared to be the removal of the old quay wall. The cross section is indicated in Figure 4. This quay wall was designed for the import of iron ore and had a length of 950 m and a retaining height of 32 m. The quay was constructed between 1988 and 1990 with:

- an inclined steel combi-wall (tubes Ø1420-19 mm with triple Larsen IIIs),
- concrete pre stressed bearing piles (450x450 mm),
- MV piles (PSt 370/153 (Peiner profile), design capacity 2,000 kN, and successfully tested up to 5,000 kN)
- and a massive concrete superstructure with a 18 m long relief floor and a tunnel structure on the water side. The entire height of the concrete structure is 11 m, the thinnest (front) wall is 750 mm tick, the thickest part (floor) is 3 m. The concrete is segmented in 40 m long sections each weighting 5000 tons.

It is the first ever demolished quay wall on this scale in Rotterdam and, as far as the authors know, even globally. The quay wall is described in literature under its first name, Euroterminal or Swarttouwkwade (van Ast 1990, de Gijt 1990, van Schaik 1990). And recently in Dutch as ‘kademuur Amazonehaven’.

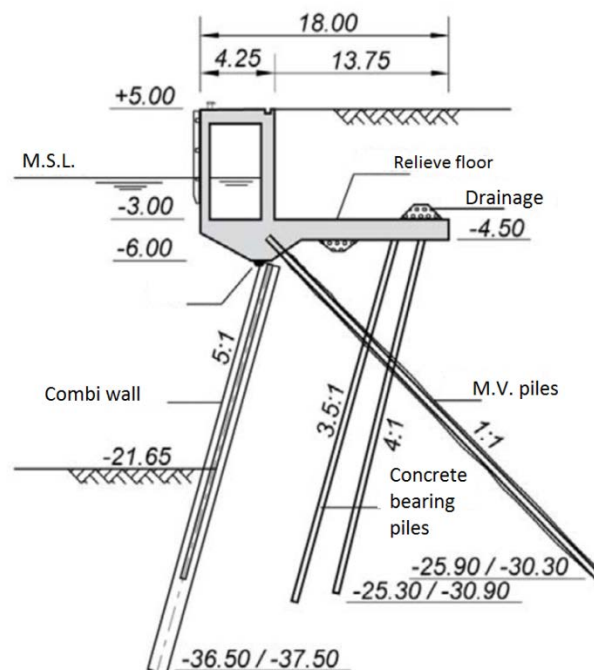

Figure 4: Cross section old quay to be demolished (Gijt, 2013)

Demolition companies advised the Port of Rotterdam to demolish the concrete super structure in dry conditions, just like it was build. However, there was only 50 m horizontal space avail-

able in front of the quay wall, with a water depth of 25 m. This was the previous nautical space of the EMO berths.

A dry pit would require a construction able to retain 9 m water level difference combined with ship impact and constructed in this confined water space with dense shipping. It was hard or even impossible to create a dry demolition pit that would also be safe and economically viable.

For this particular challenge, the Port of Rotterdam Authority tendered this job in a Design and Construct contract (or rather a Design and Destruct contract). The best bid was made by a consortium that planned to drill and blast the concrete under water.

8 Drill and blast operation

The entire demolition was a sequence of demolition and excavation as indicated in Figure 5.

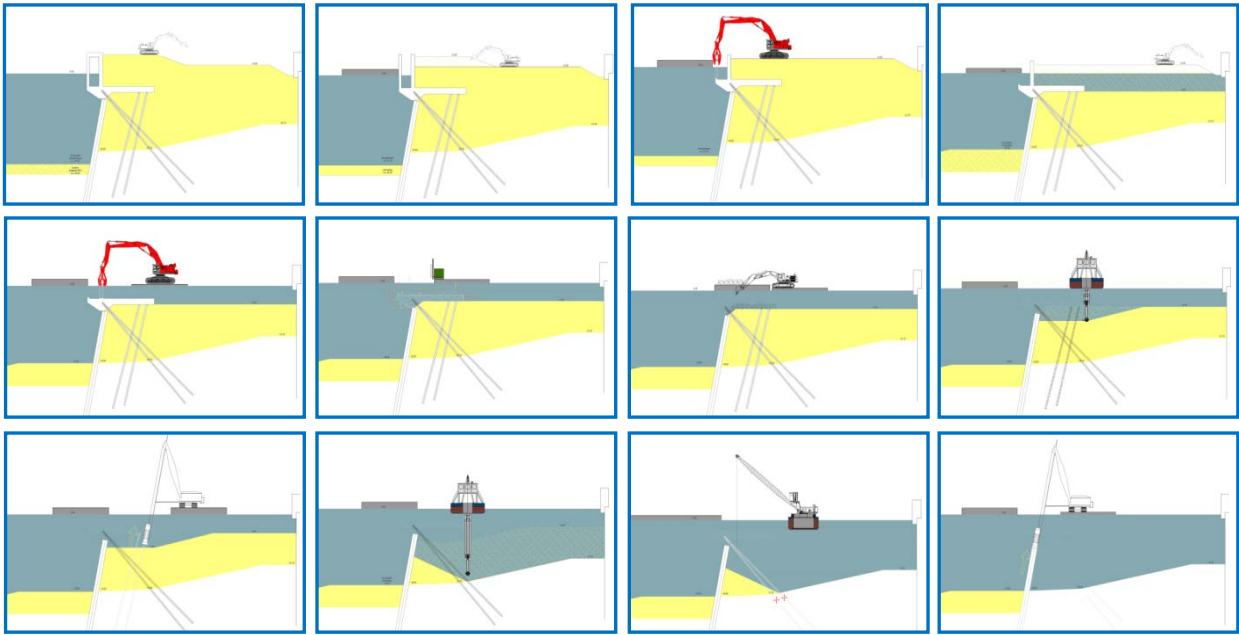







Figure 5: Demolition and excavation sequence.

After the removal of the concrete tunnel structure in a classical way using hydraulic demolition excavators, two mining drilling machines placed on a pontoon drilled holes according to an engineered pattern (Figure 6) and loaded the boreholes with dynamite. Every working day over roughly 20 weeks, the day production was blasted. Shipping in the Amazonehaven always continued, except for the first blast were a basin spanning transponder line proved that the blasts were harmless for sailing and moored ships.

After the blast concrete and rebar were removed. Rebar was completely separated from the concrete by the blast; this was caused by the difference in velocity of the pressure waves trough the steel and the concrete. Theoretically the rebar was ready to be reused after the blast, but not after removal with big cranes. The concrete fragmentation was fitted is such a way that relatively large cobbles were created that could be reused in the scour protection in front of the new quay wall. Although well planed and executed, total removal under water remains a difficult job.

	: lading TYPE A	$Q_s = 812 \text{ g/m}^3$, $Q_i = 2500 \text{ g}$, Eurodyn 2000, 1 x (65*500 mm)
	: lading TYPE B	$Q_s = 937 \text{ g/m}^3$, $Q_i = 3500 \text{ g}$, Eurodyn 2000, 1 x (65*500 mm) + 1 x (50*350 mm)
	: lading TYPE C	$Q_s = 966 \text{ g/m}^3$, $Q_i = 5000 \text{ g}$, Eurodyn 2000, 5 x (50*350)
	: lading TYPE D	$Q_s = 918 \text{ g/m}^3$, $Q_i = 5000 \text{ g}$, Eurodyn 2000, 5 x (50*350)
	: lading TYPE E	$Q_s = 1050 \text{ g/m}^3$, $Q_i = 4500 \text{ g}$, Eurodyn 2000, 1 x (65*500 mm) + 2 x (50*350 mm)
	: lading TYPE F	$Q_s = 912 \text{ g/m}^3$, $Q_i = 2500 \text{ g}$, Eurodyn 2000, 1 x (65*500 mm)

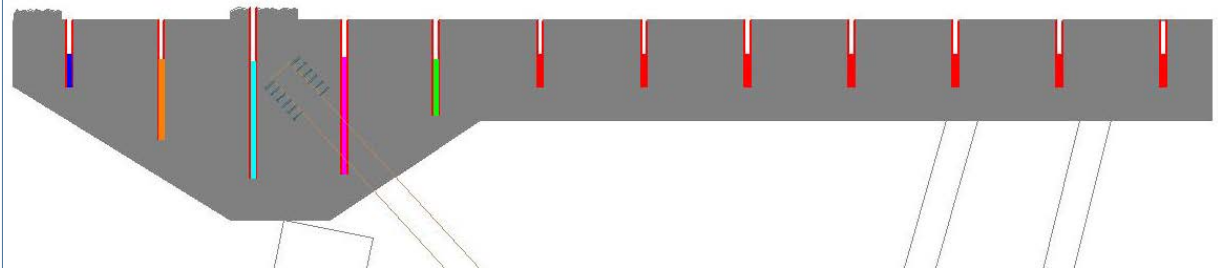

Figure 6: Blast pattern and blast

As the harbor is a rich fish ground, the contractor ‘warned’ the fish by firing five detonators in the five minutes before the blast. These little explosions should scare the fish away. This worked very well because no big fishes were seen at the surface after the blasts.

And although it might look strange, drilling and blasting is also a very silent way to demolish large concrete elements under water. The alternative for this very thick concrete elements (1.5 to 3 m) is demolishing with pneumatic hammers that create a constant high noise level for many months. So overall the drill and blast operation was a success.

9 Removal of the piles

Before the project was started, removal of the piles was assumed to be the easiest part of the demolition. Marine contractors did not expect many problems with the removal of the con-

crete piles and the combi-wall. During the tender procedure, after all parties presented their risk files, the Port of Rotterdam Authority decided that the MV piles should not be removed entirely, but cut away outside the new nautical profile. Complete removal would create a serious risk for the new build quay wall. Required vibrations could lead to liquefaction of the passive wedge, providing the stability of the quay wall (de Gijt, 2013).

Concrete piles were planned to be removed with a special casing, but in the end these piles were removed directly from the soil with a special clamp and a heavy vibrator. Most experts expected these pile to break under this activity, but they didn't. The final activity was assumed to be the easiest but appeared to be not.

10 Damage at intermediate sheet piles, unpleasant surprises

During the dredging works in 1990, 62 interlock openings on 31 intermediate sheet piles were discovered and repaired. When the sheet piles were retrieved, they appeared to be heavily damaged. Almost 50% of the sheet piles were damaged at the last few meters (Figure 7). This damage was never discovered during construction of the wall. The quay wall was never dredged to its final depth and these meters were below the initial construction depth of the quay wall.



Figure 7: Sheet pile damages

Research in old construction documents showed that the last 4 to 5 m were driven with a diesel hammer instead of a low frequency vibrator. Theory describes dense sand to plug inside the interlock under the action of a hammer, pushing the sheet pile out the interlock, creating the damage.

This demolition proves that ramming on sheet piles should be avoided under all circumstances. Current practice is to reduce the resistance by using an auger up to 2 m above the planned toe depth. Until 2010 jetting with water and air was the most common used way to reduce the resistance for the sheet piles. Between 2010 and 2014 both methods were used and currently the large auger is the preferred method to reduce the resistance.

It also appeared that during construction a few centimeters of one sheet piles interlock was removed to ease the positioning of the sheet piles between the tubular piles. This resulted in 'flapping' of this sheet pile edge. This has also been a trigger at other quay walls as described by De Gijt (1996). Today interlocks at the king piles have a 100 mm height difference at the top to ease the placing of the intermediate sheet piles without needing notches. In this way the interlock can save and easily be connected.

11 Damage of the tubular king piles

The worst discovery however was the condition of the tubular king piles. Over 20% of the pile toes appeared to be damaged (Figure 8). These piles were supposed to provide horizontal

stability. Figure 9 shows piles that were placed next to each other. This cross section did not provide the designed safety. This was further examined by Mourillon (2015), but needs to be studied in more detail.



Figure 8: Pile toe damages



Figure 9: Heavily damaged pile toes

Closer investigation of the piles indicated that soil was ‘burned’ on the pile toe. Apparently the steel has become that hot during installation. Steel strength reduces with temperature; perhaps this effect has played a role in the damage.

American Petroleum Institute (API) rules recommend a minimum D/t ratio of 70 for this kind of piles. This means that a Diameter (D) =1420 mm pile should have at least Wall thickness (t) =20.3 mm. In the past Rotterdam used a minimum D/t of 90 against buckling, with $t=17$ mm these piles had a D/t of 83.5. Today this would be considered to be too conservative, D/t ratios over 100 are seen in D&C projects.

Rotterdam installation practice is driving with a vibrator towards the Pleistocene layer and than using a diesel or hydro hammer to ram the pile towards the designed depth. This method is used to create maximum bearing capacity by plugging of the open pile.

History showed (van Ast, de Gijt 1990) that on this project both a D62 and a D100 diesel hammers were used to drive the piles, probably also often both on the same pile a few days after each other. Figure 10 shows the driving analysis of both hammers under Amazonehaven conditions and indicates that the D62 is too light. This shift in hammer is obviously not done

directly, it is a heavy operation and there have passed a few days between the different hammers. This time gap leads to setup as the water overpressure disappears, making it very difficult to get the pile moving again.

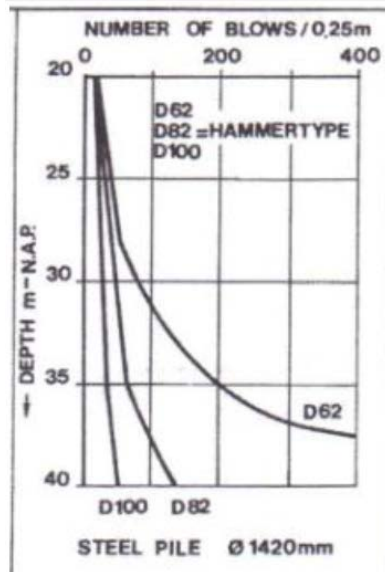

Figure 10: Results drivability of open steel tubular piles (Mourilon, 2015)

The last trigger might be the inclination of the combi-wall. The 5:1 inclination was used to reduce anchor forces, but it also resulted in placing the pile on one edge before the installation could start. This might have led to small dents. The pile, coming from the weak clay, hit the firm Pleistocene layer under the same inclination, so again not with the entire pile feet, probably also resulting in a dent. Whether the inclination plays a role or not, is uncertain, but current projects are constructed with a vertical combi-wall for safety.

12 Conclusions

The current assumption is that the pile damage is a result of a combination of factors. The first reaction of many experts in the field was that damage had to be expected on the combi-wall. All these experts however reacted shocked when confronted with the pictures of the damage. It appeared that this kind of combi-walls were never removed from a construction site in North West Europe on this scale. The Amazonehaven demolition appeared to be a unique project.

Lessons learned from this project are:

- Drilling and blasting of concrete under water is a good method to demolish. It is safe, silent, fast and environmentally friendly;
- Ramming on intermediate sheet piles must be forbidden;
- Notches and other cutting in sheet pile toes should be forbidden;
- Pile hammering should always be done in one flow to avoid setup;
- D/t ratios should not be too high. The API ratio of 60-70 is recommended for heavy pile driving;
- Heavy combi-walls are almost never removed. Expect damage at the pile toes.

References

- [1] Ast, W. van (1990). Uitvoeringsaspecten zeekeade, Diepwaterterminal op de Maasvlakte te Rotterdam, Polytechnisch Tijdschrift Civiele Techniek, april 1990
- [2] Broos, E.J., Gijt, J.G. de, (2014). Creating access for ultra large container ships to each berth in Rotterdam, Maasvlakte 2 and widening Amazonehaven, International Conference Ports for Container Ships of Future Generations, February 17th – 18th, 2014 Hamburg, Germany
- [3] Gijt, J.G.de; Brassinga, H.E.; (1990). Geotechnische aspecten van de zeekeade en de bewerkingskeade voor de Euroterminal op de Maasvlakte, Polytechnisch Tijdschrift Civiele Techniek, april 1990
- [4] Gijt, J.G.de; Heijndijk, P.J.M., (1996). Installation experience with combiwall systems in The Port of Rotterdam, 11th Harbour Congress Antwerpen 1996
- [5] Gijt, J.G. de, Broeken, M.L. (2013). Quay Walls – Second edition 2013, C211E, ISBN 978-1-138-00023-0
- [6] Mourillon, N.K.N. (2015). Stability analysis quay structure at the Amazonehaven port of Rotterdam, Master thesis, Delft University of Technology, October 14th 2015
- [7] Rijckaert, R., Broos, E.J., Bartholomeeusen, B. (2014). Widening of the Amazonehaven in the Port of Rotterdam for the safe entrance of Ultra Large Container Ships, PIANC World Congress San Francisco, USA 2014
- [81] Schaik, C.N. van (1990). Ontwerp zeekeade, Diepwaterterminal op de Maasvlakte te Rotterdam, Polytechnisch Tijdschrift Civiele Techniek, april

Authors

Erik Broos¹, Rob Sibbes², Jarit de Gijt²

1, Port of Rotterdam Authority, Port Development, PO Box 6622, 3002 AP Rotterdam, The Netherlands, Phone +31 10 252 1010, mail: EJ.Broos@portofrotterdam.com

2, Port of Rotterdam Authority, Harbor Master Division, PO Box 6622, 3002 AP Rotterdam, The Netherlands, Phone +31 10 252 1010

3, Delft University of Technology, Hydraulic Structures, PO BOX 5048, 2600GA Delft, The Netherlands, Tel:+31 6 52 85 04 52, Email: j.g.degijt@tudelft.nl