

# THE **HULL** INSTITUTE

## 3D bioprinting laboratory - Nijmegen

Charles Hull "the father of 3D printing"



# Index

## **Research**

- Fascination
- Research question
- Laboratory

## **Location**

- Orientation
- Analysis
- Values

## **Brief**

## **Design**

- Concept
- Central element
- Construction
- Design
- Walk through

## **Reflection**





# Craft in an Information Society

## Paradigm shifts

1. Anything is craft and everything is done by hand. <13 c.
2. Separation between craft en fine art. 14 c.
3. Craft is seperated from machine production. 19 c.
4. Distinction between machine manufacturing and hand finishing. 20 c.
5. Technology creating novel form through new materials using new production processes. >21 c.

## Paradigm shifts

1. Anything is craft and everything is done by hand. <13 c.
- 2. Separation between craft en fine art. 14 c.**
3. Craft is seperated from machine production. 19 c.
4. Distinction between machine manufacturing and hand finishing. 20 c.
5. Technology creating novel form through new materials using new production processes. >21 c.

## Paradigm shifts

1. Anything is craft and everything is done by hand. <13 c.
2. Separation between craft en fine art. 14 c.
- 3. Craft is seperated from machine production. 19 c.**
4. Distinction between machine manufacturing and hand finishing. 20 c.
5. Technology creating novel form through new materials using new production processes. >21 c.



## Paradigm shifts

1. Anything is craft and everything is done by hand. <13 c.
2. Separation between craft en fine art. 14 c.
3. Craft is seperated from machine production. 19 c.
- 4. Distinction between machine manufacturing and hand finishing. 20 c.**
5. Technology creating novel form through new materials using new production processes. >21 c.

## Paradigm shifts

1. Anything is craft and everything is done by hand. <13 c.
2. Separation between craft en fine art. 14 c.
3. Craft is seperated from machine production. 19 c.
4. Distinction between machine manufacturing and hand finishing. 20 c.
5. Technology creating novel form through new materials using new production processes. >21 c.

# intimate relation with the **TOOLS**



physical **PRODUCT**

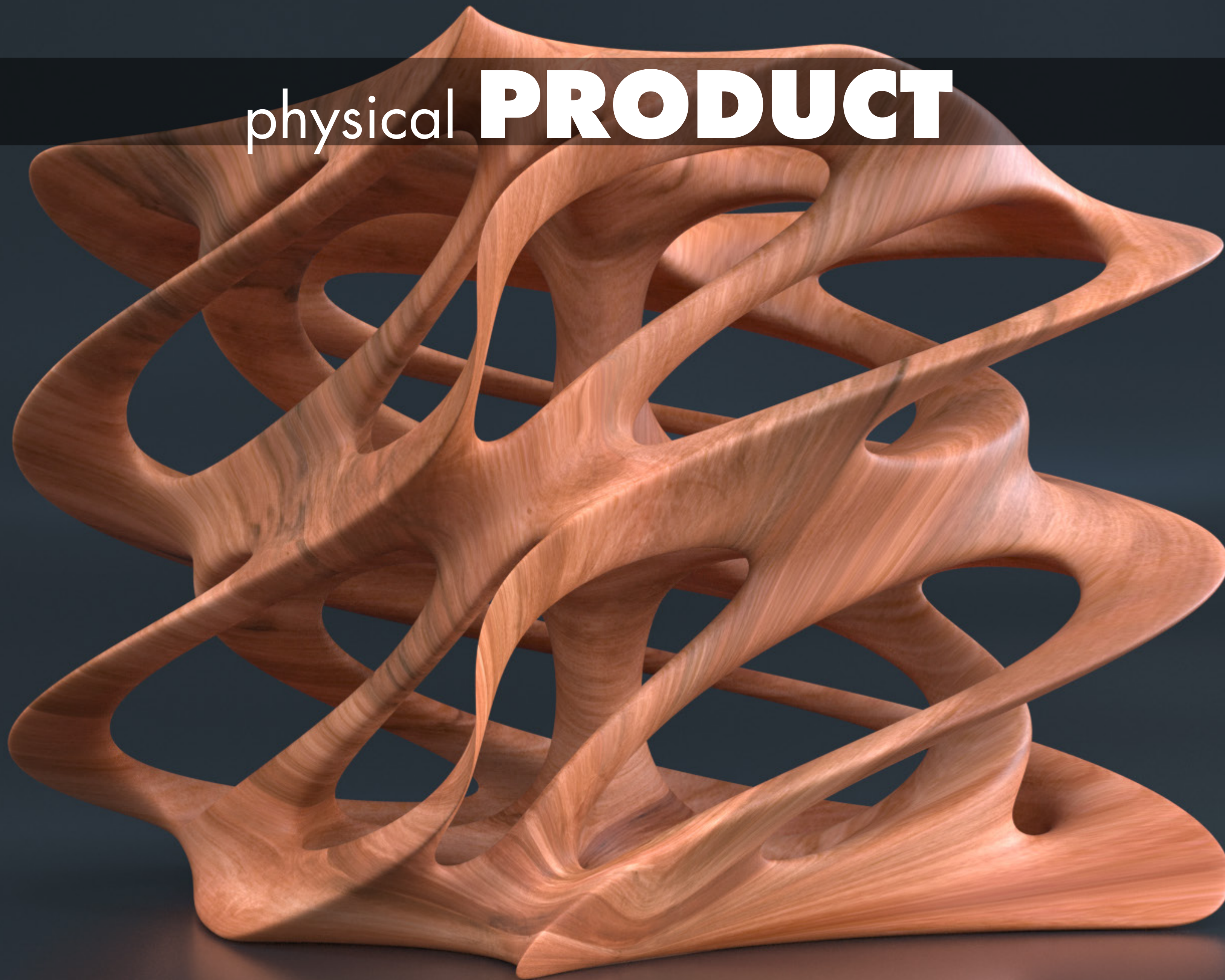

# **GUILD** education system



*“Future craft is a new design methodology that considers how the processes of design and production can be used to reflect new social values and to change dominant cultural processes.”*

# 3D - BIOPRINTING

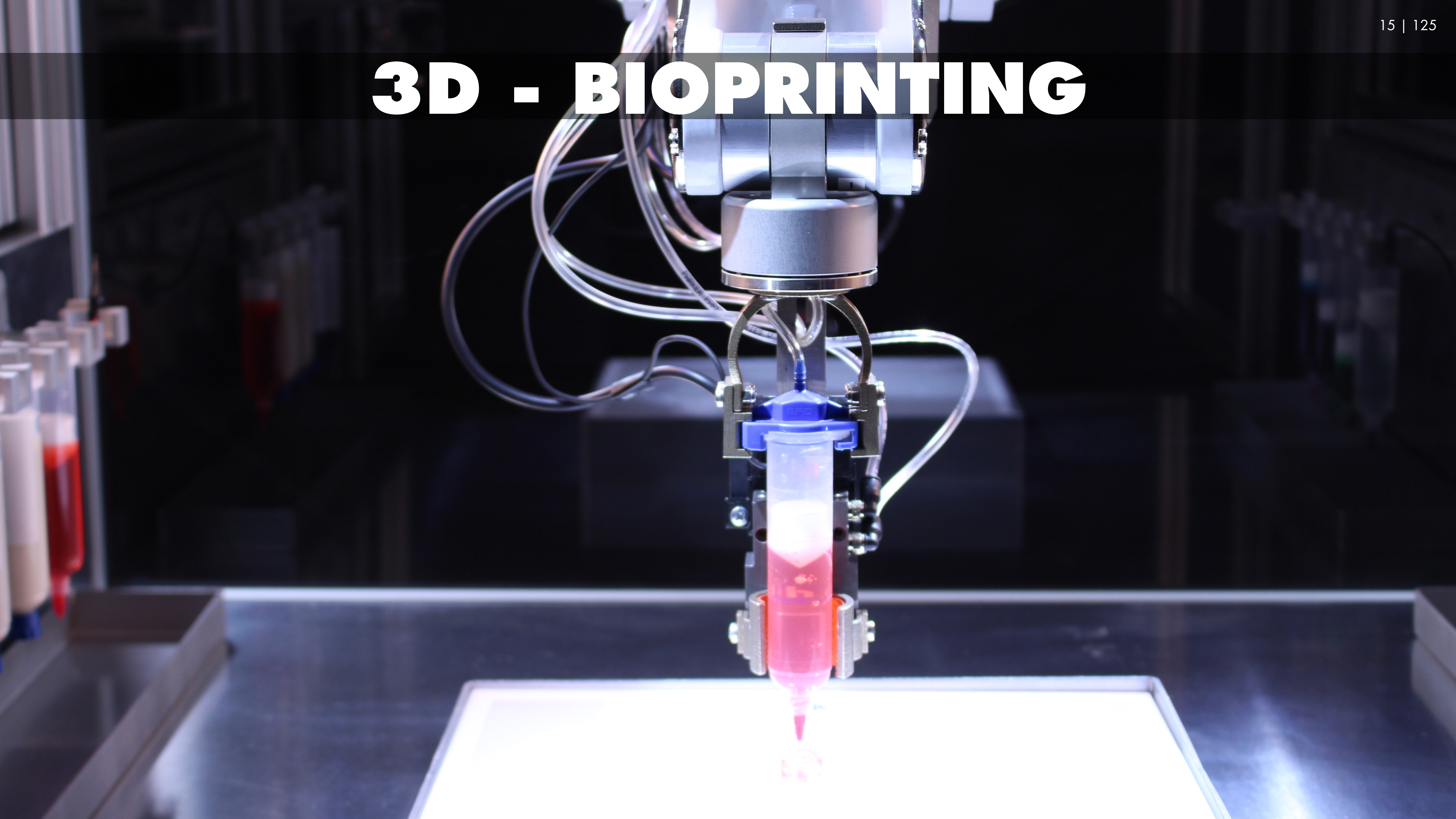

# IMAGING

MRI  
CT





# DESIGN APPROACH

BIOMIMICRY  
SELF-ASSEMBLY  
MINI-TISSUE



# MATERIAL SELECTION

SYNTHETIC POLYMERS  
NATURAL POLYMERS  
EXTRACELLULAR MATRIX

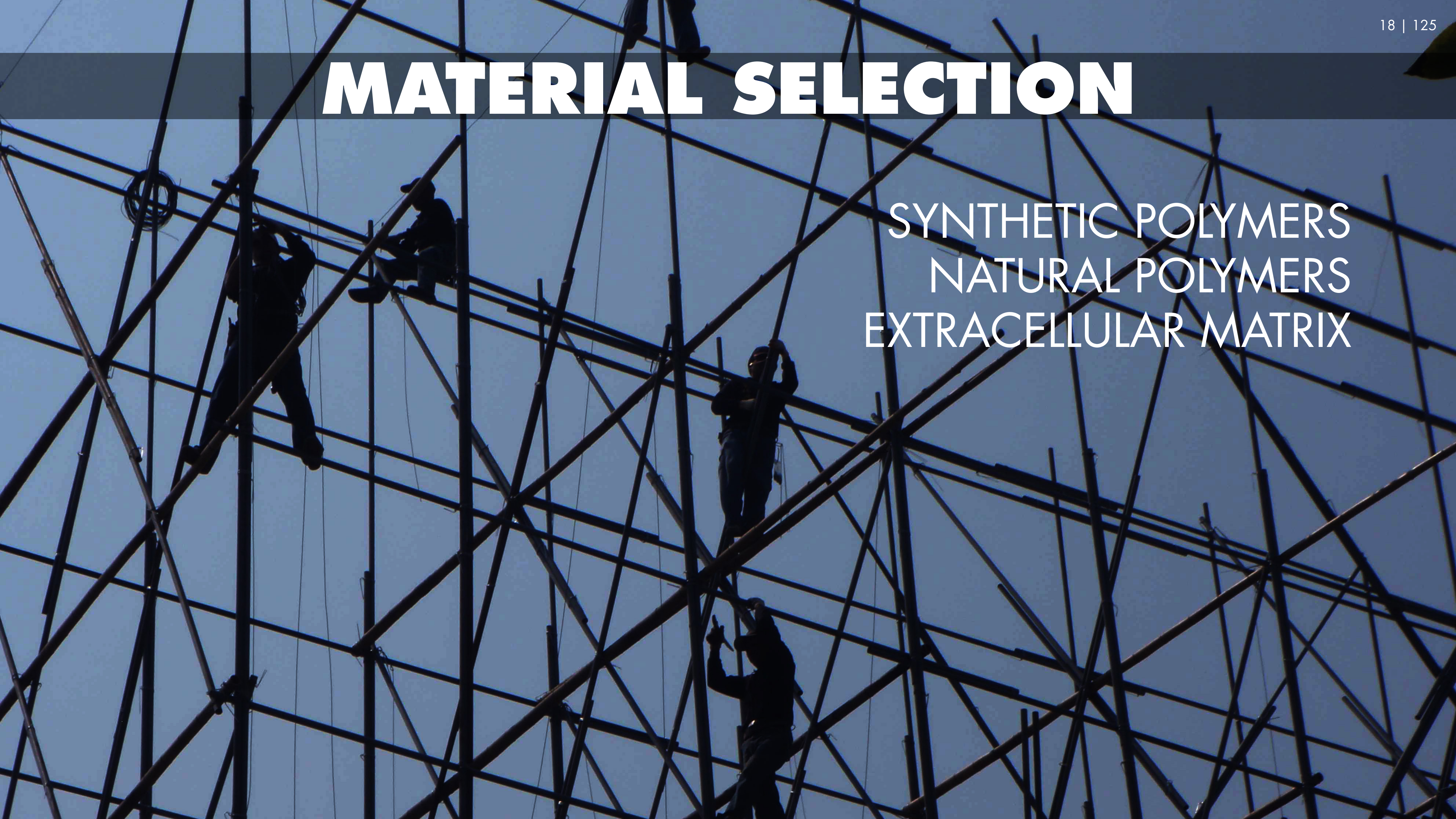

# CELL SELECTION

DIFFERENTIATED CELLS  
PLURIPOTENT STEM CELLS  
MULTIPOTENT STEM CELLS

The background of the slide is a dark blue field filled with numerous glowing, semi-transparent blue cells. Each cell contains a bright purple nucleus. The cells vary in size and focus, with one large cell in the center foreground being the most prominent and sharp. The overall effect is a sense of a vast population of cells, with some appearing more developed or selected than others.

# BIOPRINTING

INKJET  
MICROEXTRUSION  
LASER ASSISTED

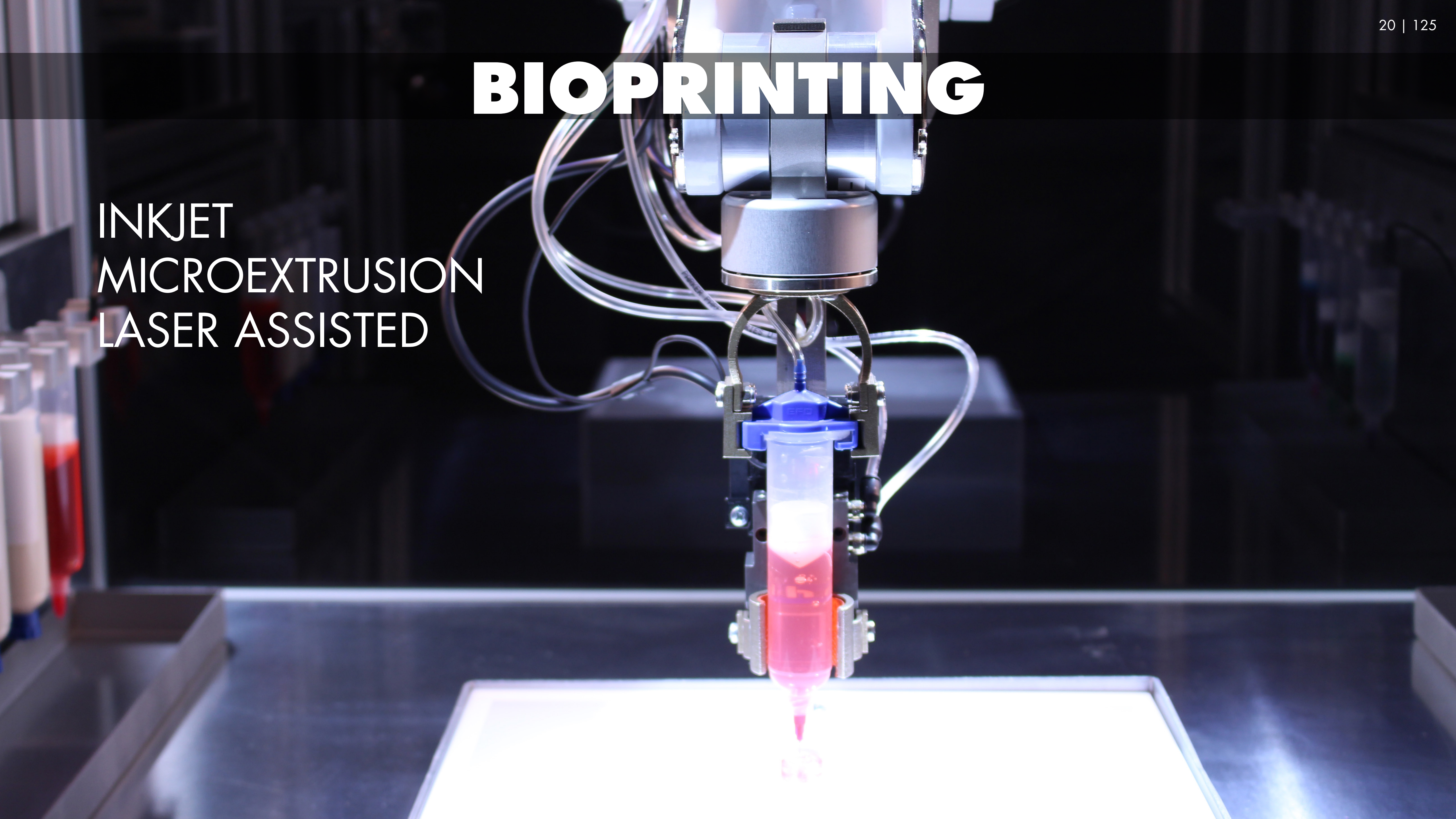

# APPLICATION

IMPLANTATION  
MATURATION  
IN VITRO TESTING



“WHAT KIND OF ARCHITECTURAL  
ENVIRONMENT ENCOURAGES AND STIMULATES THE  
DEVELOPMENT OF 3D BIOPRINTING.”

# THE LABORATORY



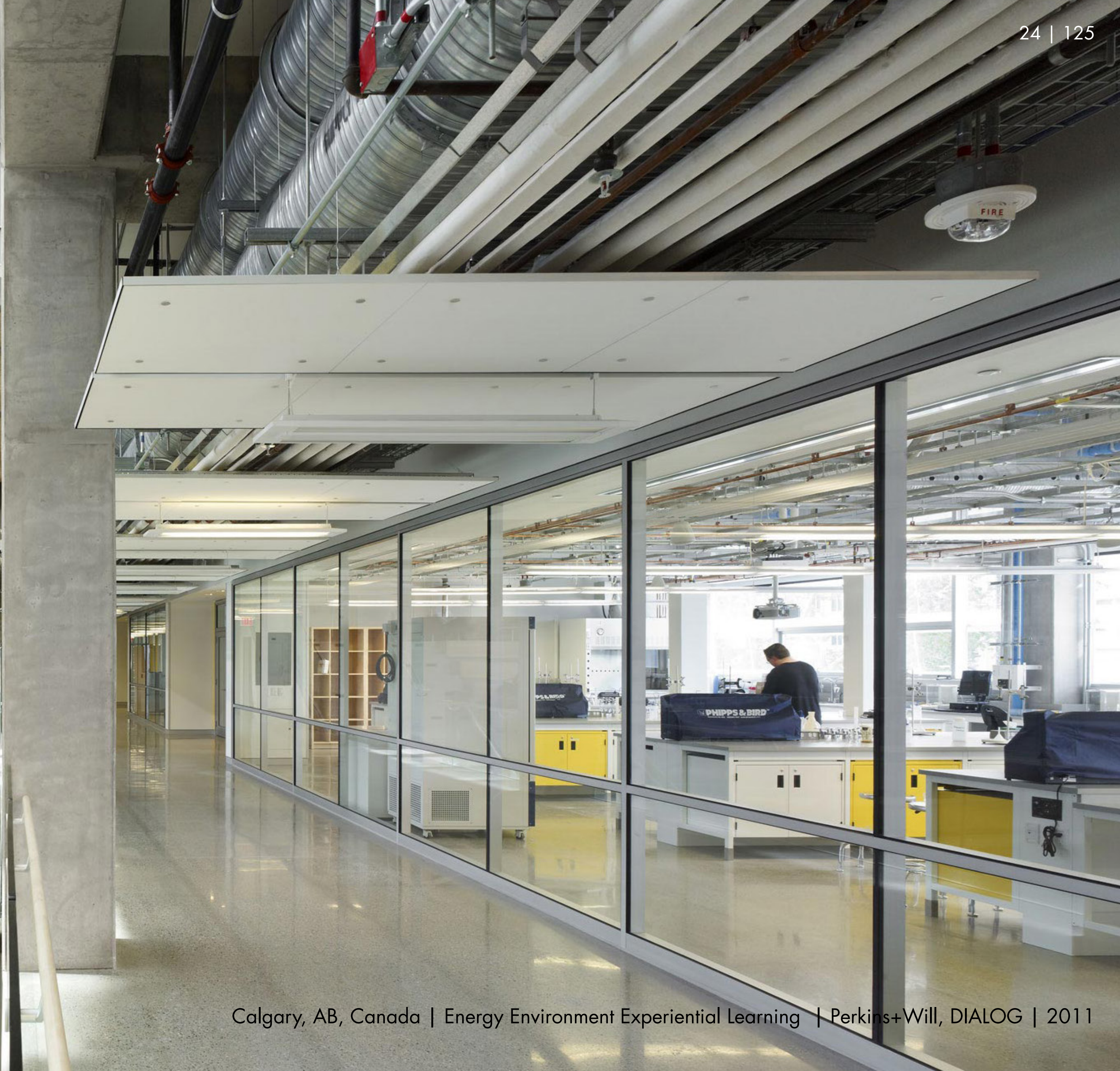



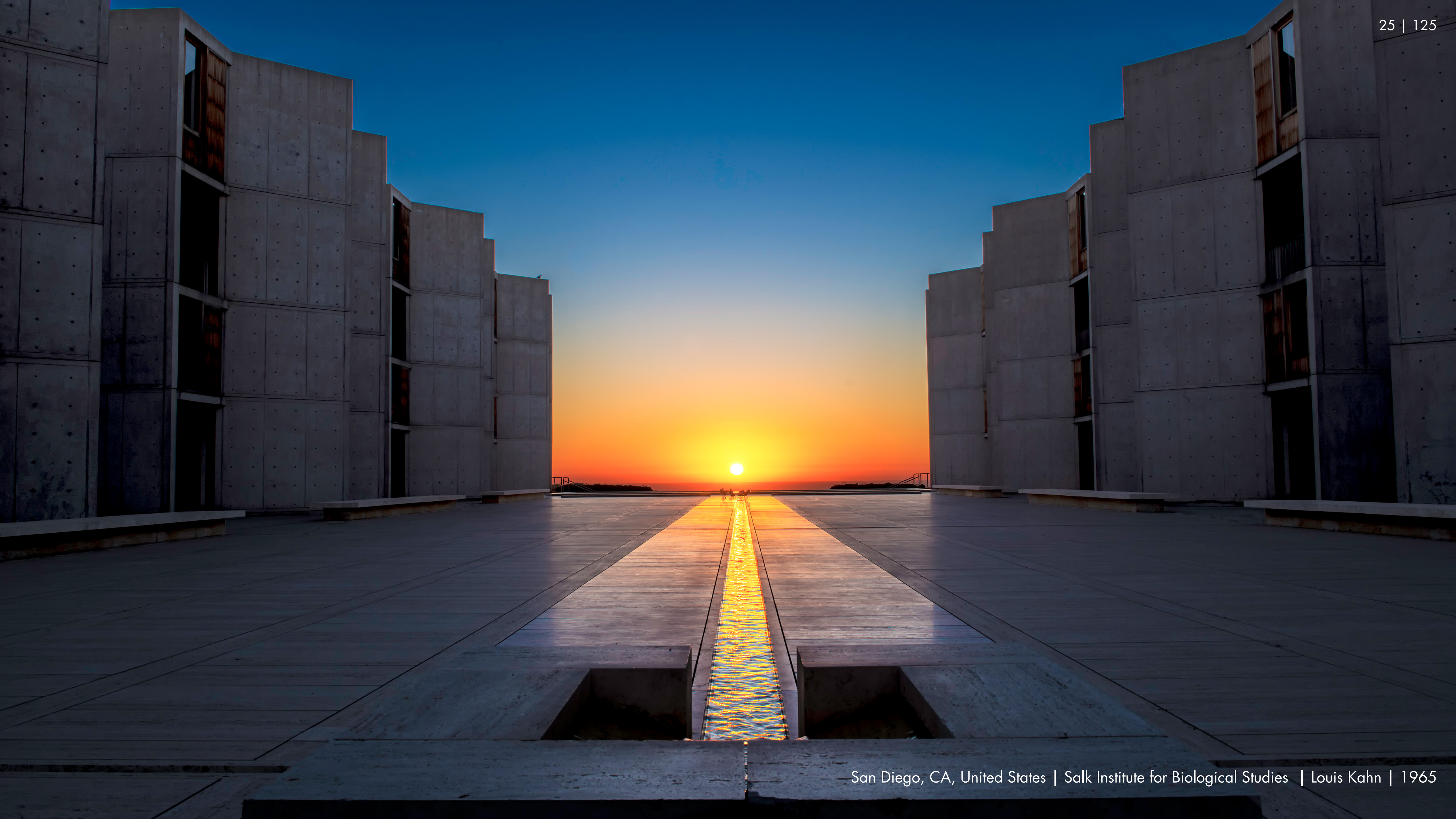

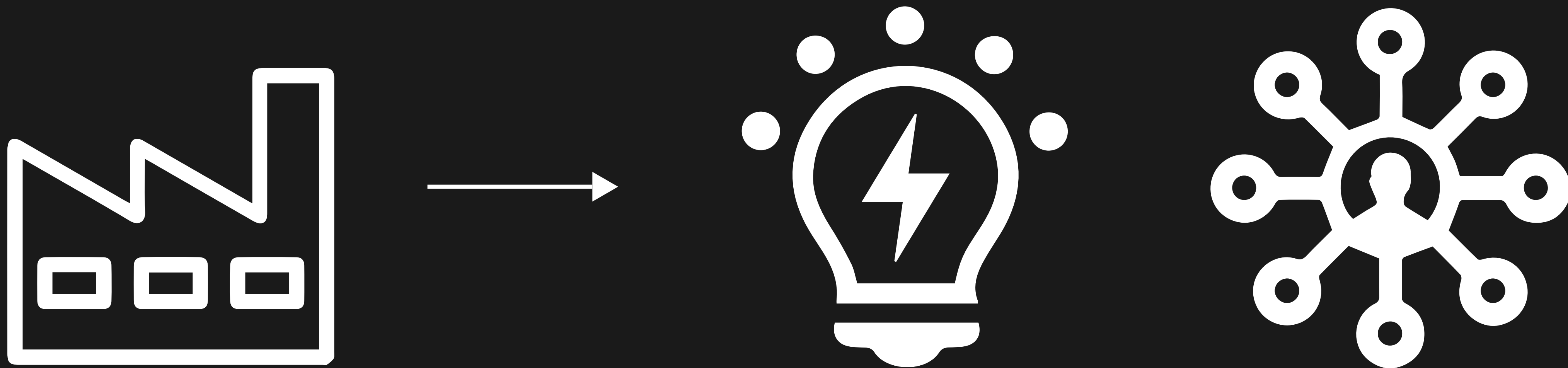

*“A building that is clearly designed for sustained intellectual, spiritual and aesthetic life.*

*A place where a variety of people can meet and can be distracted by a different kind of beauty.”*

# SOCIAL



# ADAPTABLE

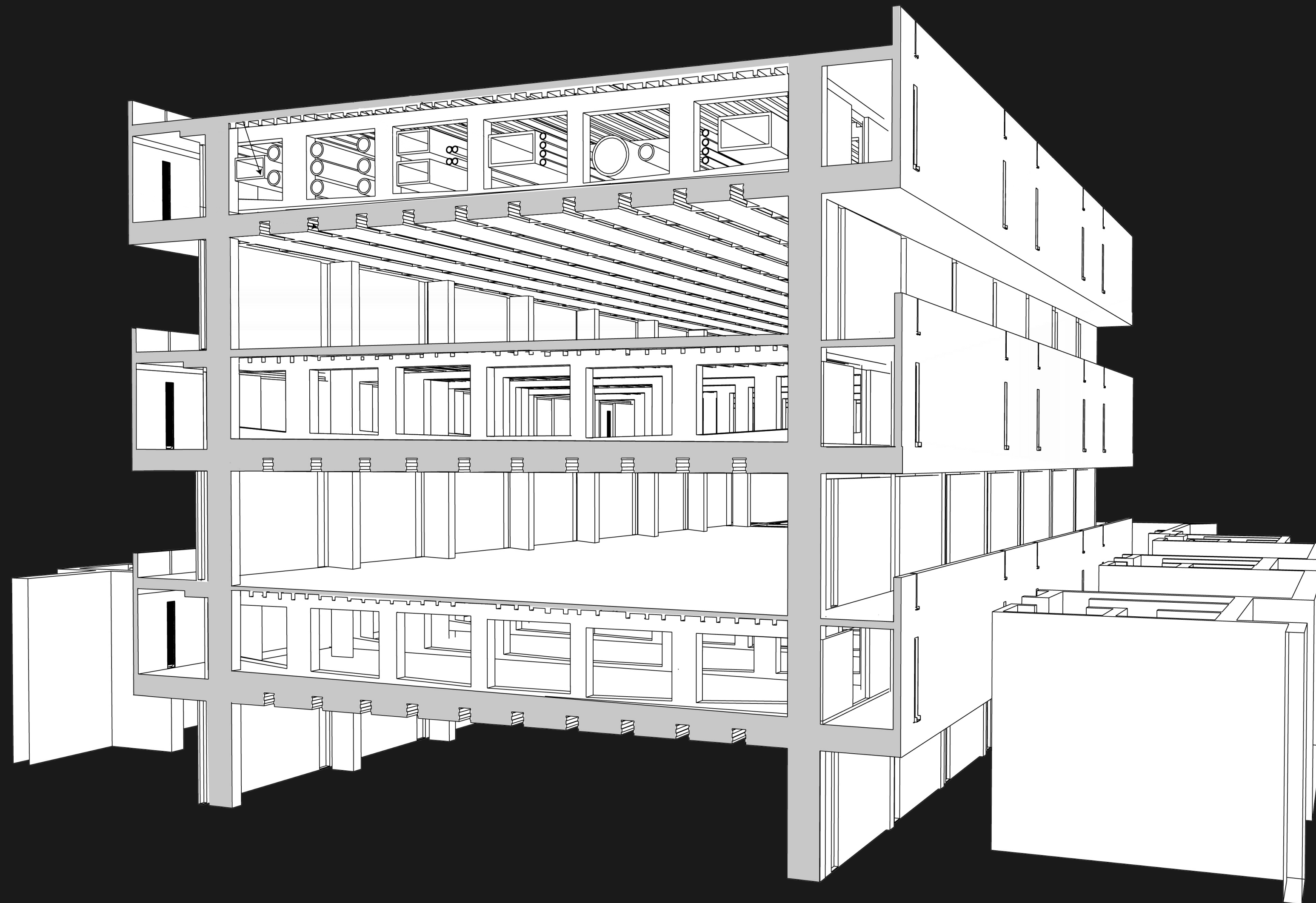

San Diego, CA, United States | Salk Institute for Biological Studies | Louis Kahn | 1965

# SUSTAINABLE



San Francisco, CA, United States | UCSF Sandler Neurosciences Center | Skidmore, Owings & Merrill, LLP | 2012

# CONNECTED



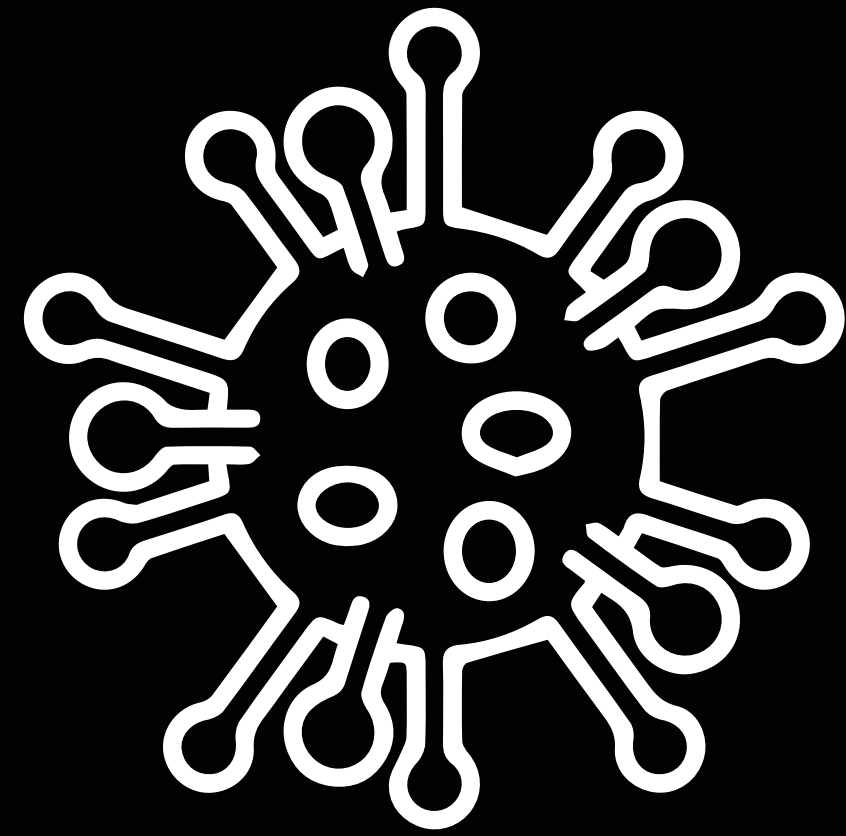

CELL BIOLOGY



BIOMATERIAL  
SCIENCE

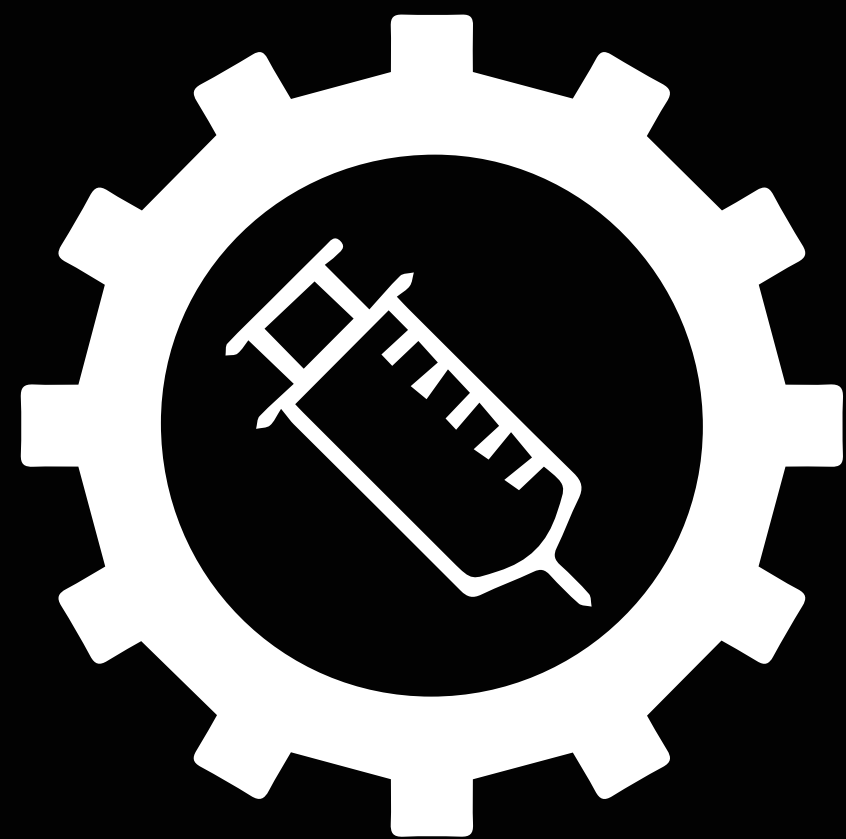

BIOMEDICAL  
ENGINEERING

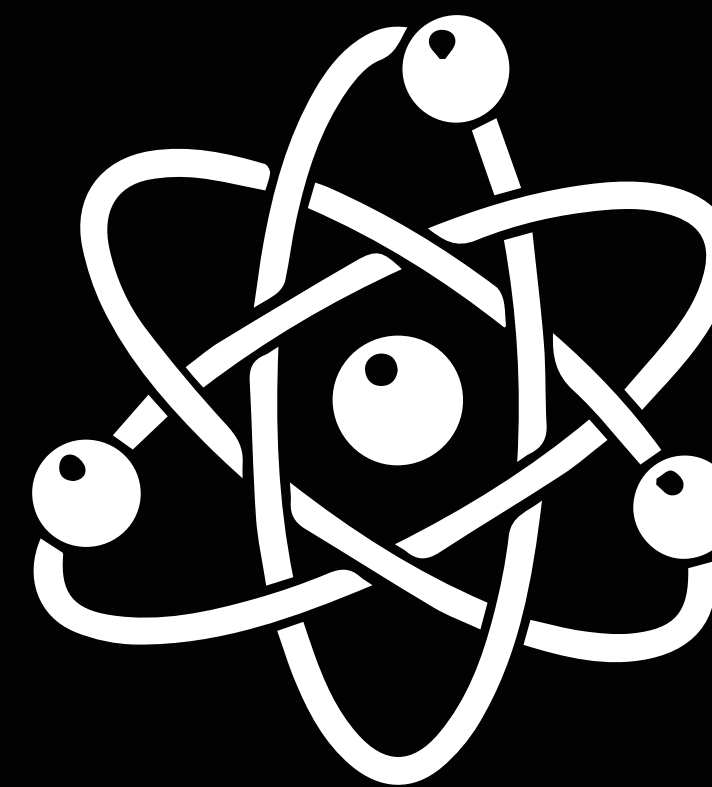

BIOPHYSICS









Huize Heyendael

Geert Groteplein Zuid  
Radboud Apotheek B.V.

Geert Groteplein Zuid

Radboudumc

Geert Groteplein Zuid  
Radboudumc  
Radiotherapie

Huygensgebouw

Department of  
Microbiology

High Field Magn  
Laboratory

Linnaeusgebouw

Radboudumc Neurologie

Radboudumc  
Tandheelkunde

Open Universiteit

Agricolaplaats  
Agricolaplaats

Dierenkliniek  
St. Anna 404

Aula Radboud  
Universiteit

Radboud  
Universiteit

Grotiusgebouw

Spinozagebouw

Copyshop

Collegezalenc  
complex

Erasmusplein  
Erasmusgebouw

Radboud Sportcentrum

Gymnasion

Restaurant BE









BUYTENDUKPAD









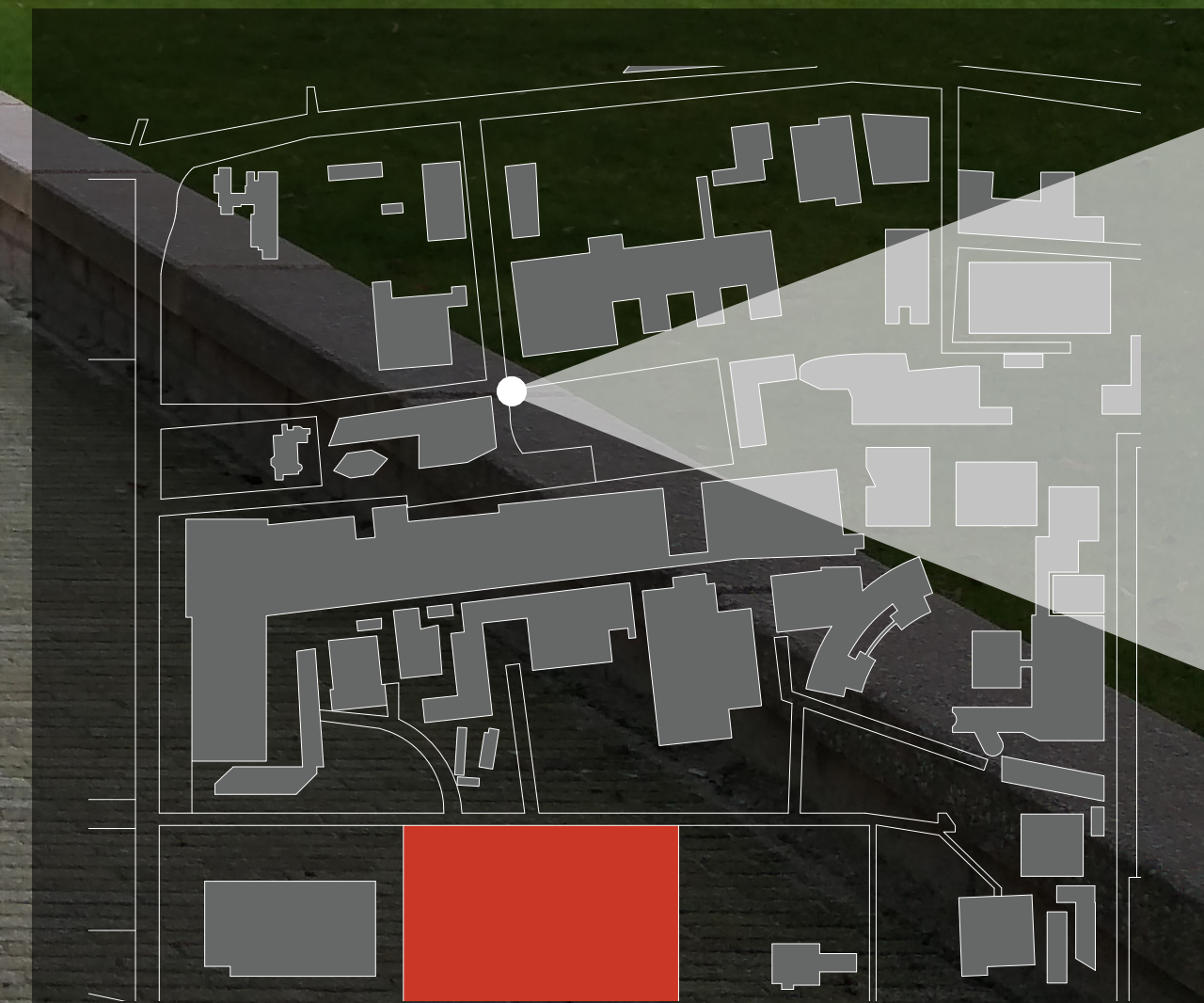

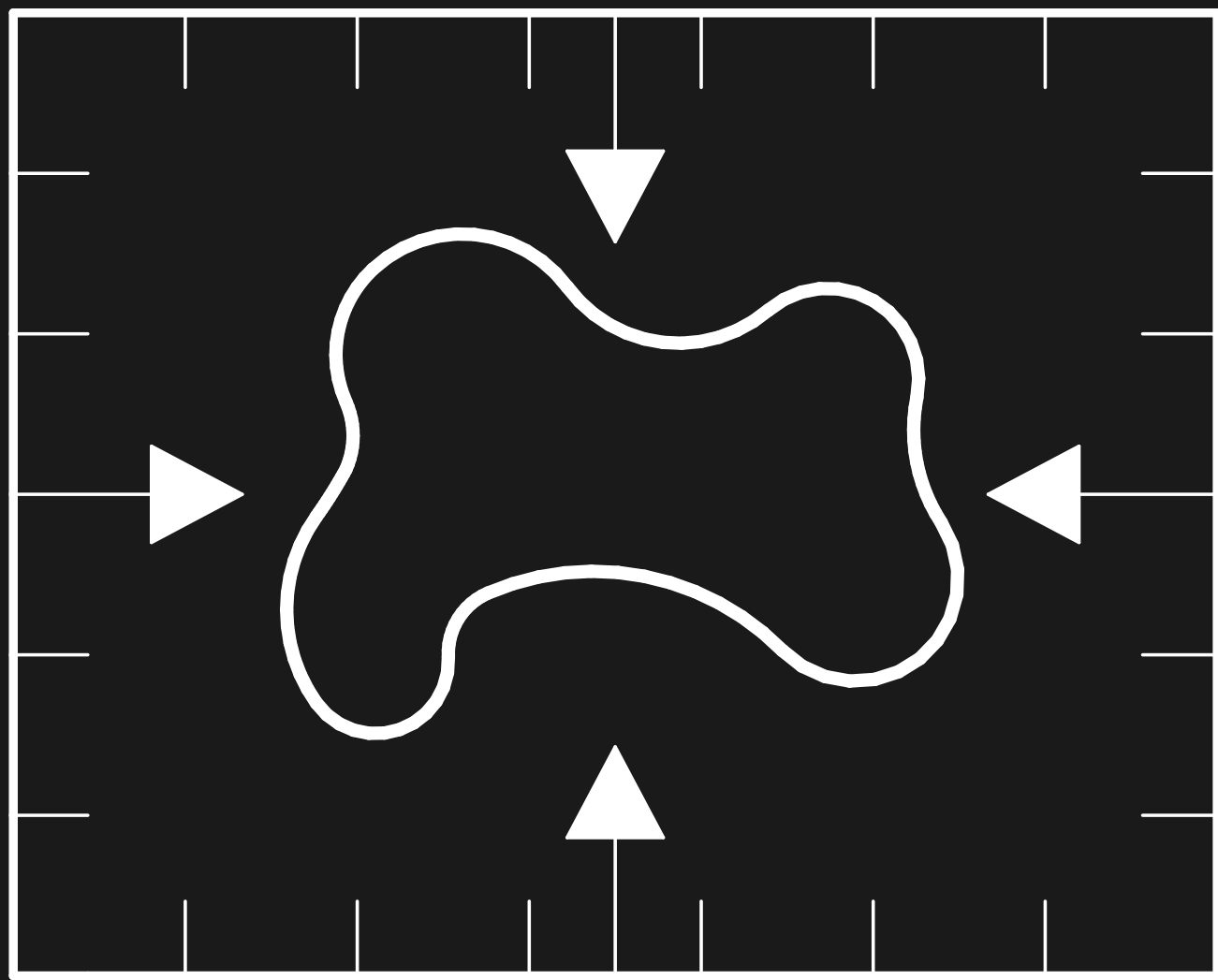

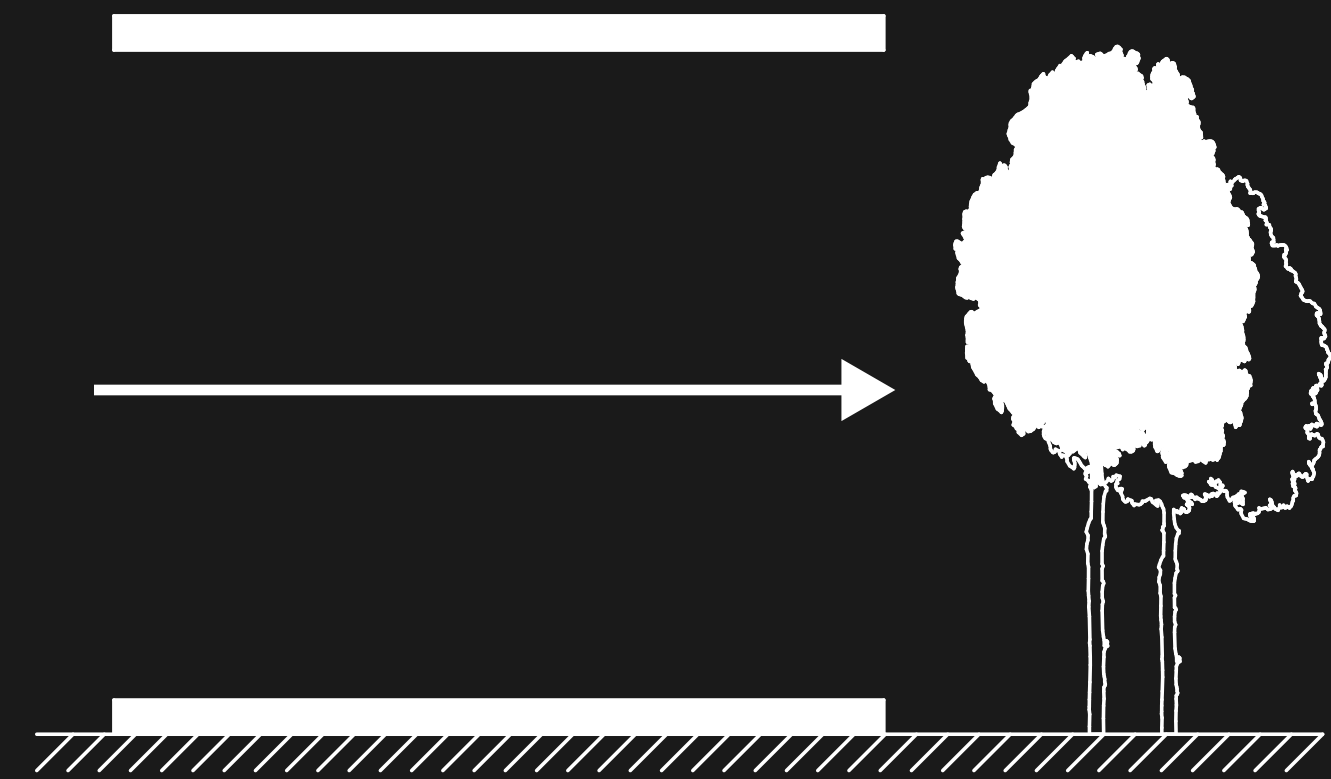
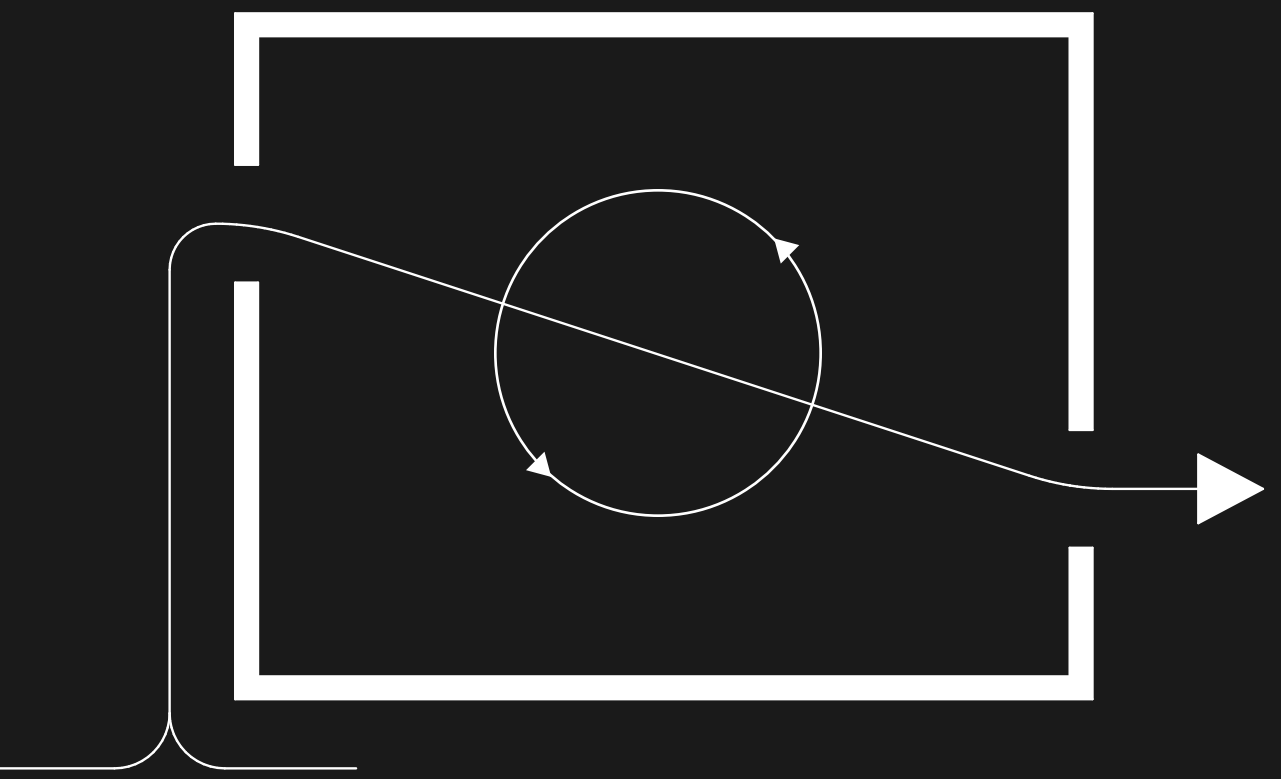

Program:	Area:
Laboratory:	
Medical Engineering	~1050 m <sup>2</sup>
Biomaterial Science	~1050 m <sup>2</sup>
Cell Biology	~1050 m <sup>2</sup>
Biophysics	~1050 m <sup>2</sup>
Open work tables	~3100 m <sup>2</sup>
Medicine / Imaging	~160 m <sup>2</sup>
Treatment Rooms	~50 m <sup>2</sup>
Imaging Rooms	~110 m <sup>2</sup>
Offices / Administration	~540 m <sup>2</sup>
Conference / Presentation	~340 m <sup>2</sup>
Changingrooms	~750 m <sup>2</sup>
Open worktables	~800 m <sup>2</sup>
	Subtotal ~ 9890 m <sup>2</sup>
Public Space:	
Reception	~45 m <sup>2</sup>
Lecture Hall	~150 m <sup>2</sup>
Library	~400 m <sup>2</sup>
Coffee Bar / Lounge	~350 m <sup>2</sup>
Public Facilities	~850 m <sup>2</sup>
Public open workspaces	~800 m <sup>2</sup>
	Subtotal ~2595 m <sup>2</sup>
Traffic space [~25%]	~4250 m <sup>2</sup>
	Total ~16750 m <sup>2</sup>

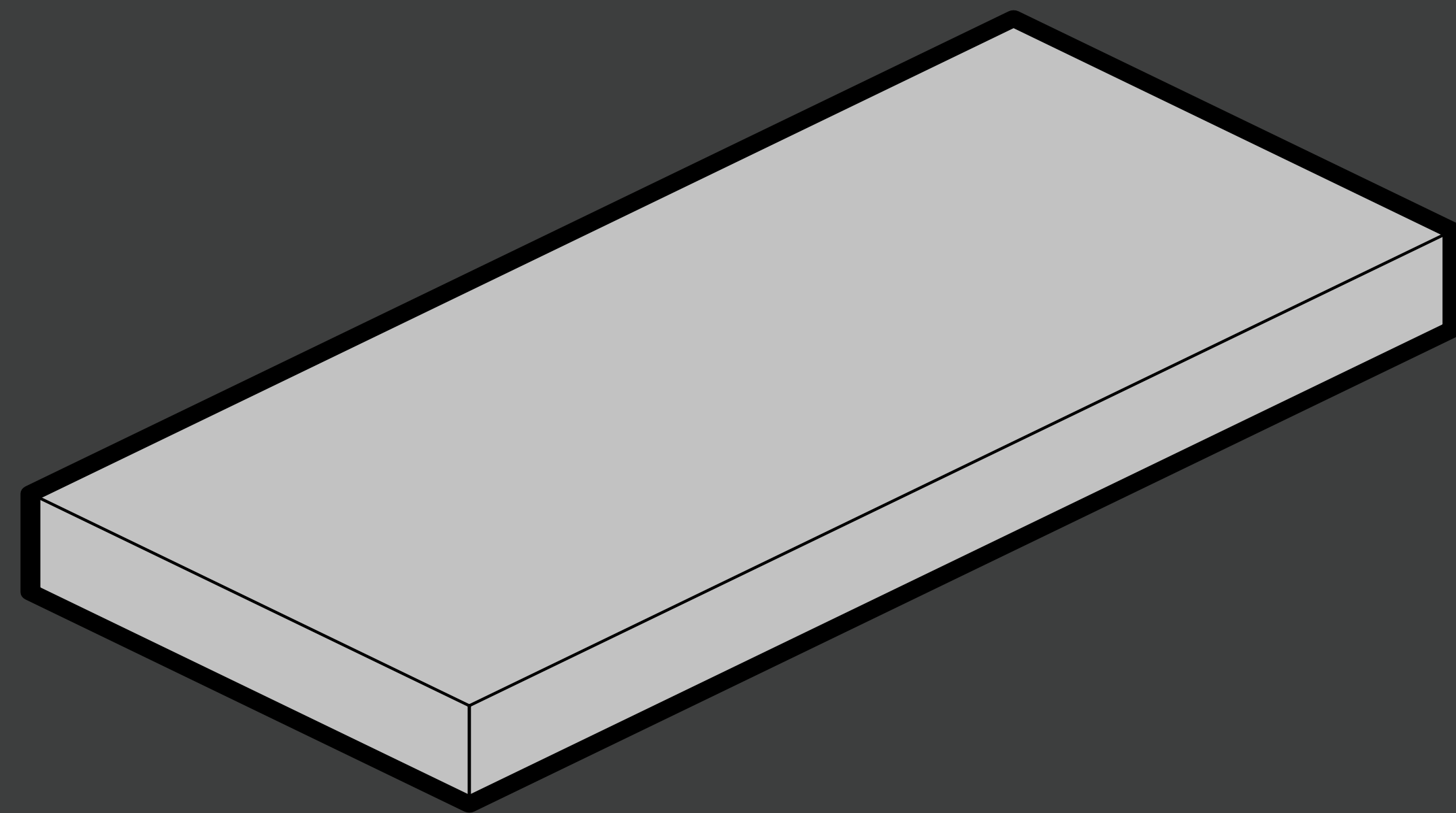

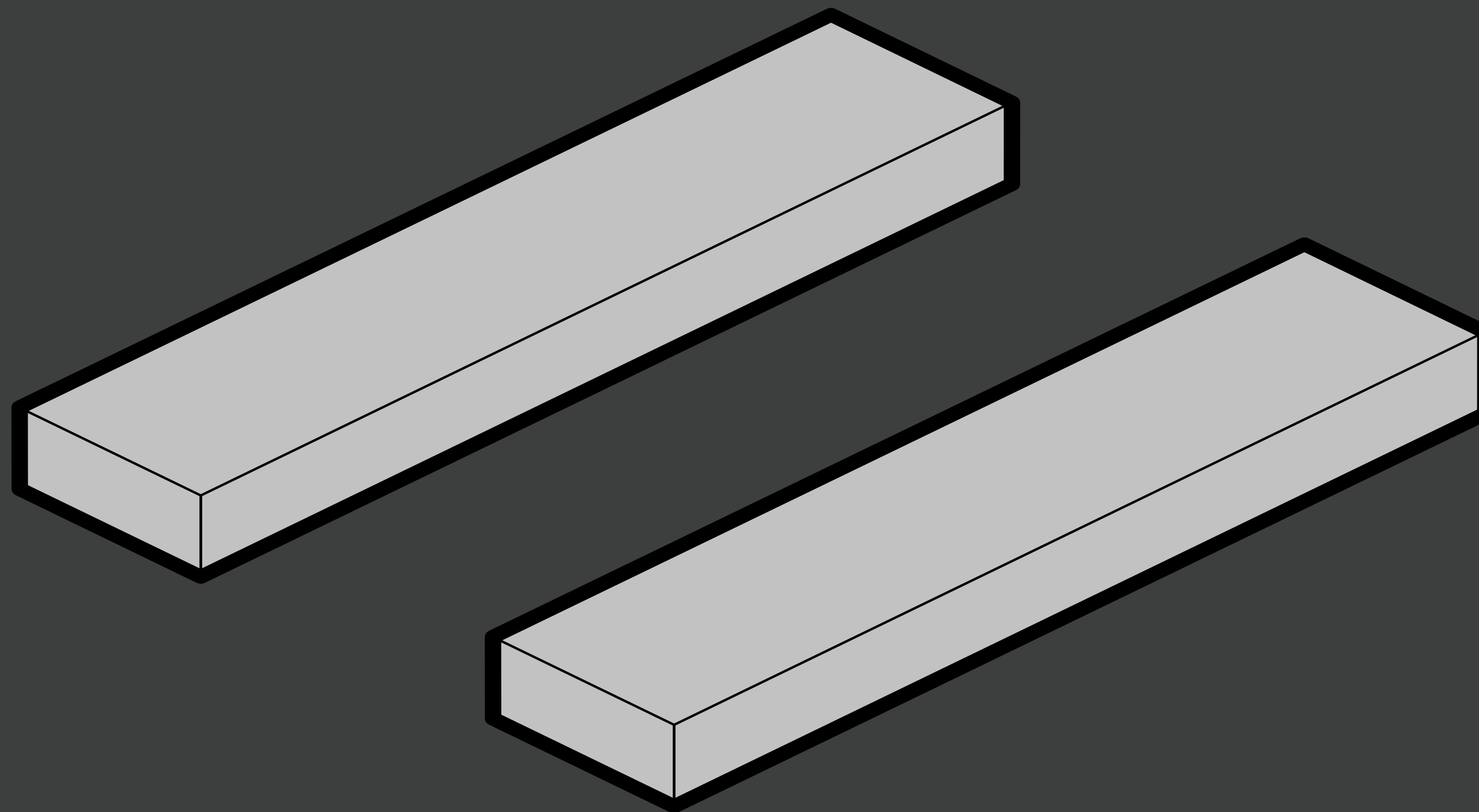

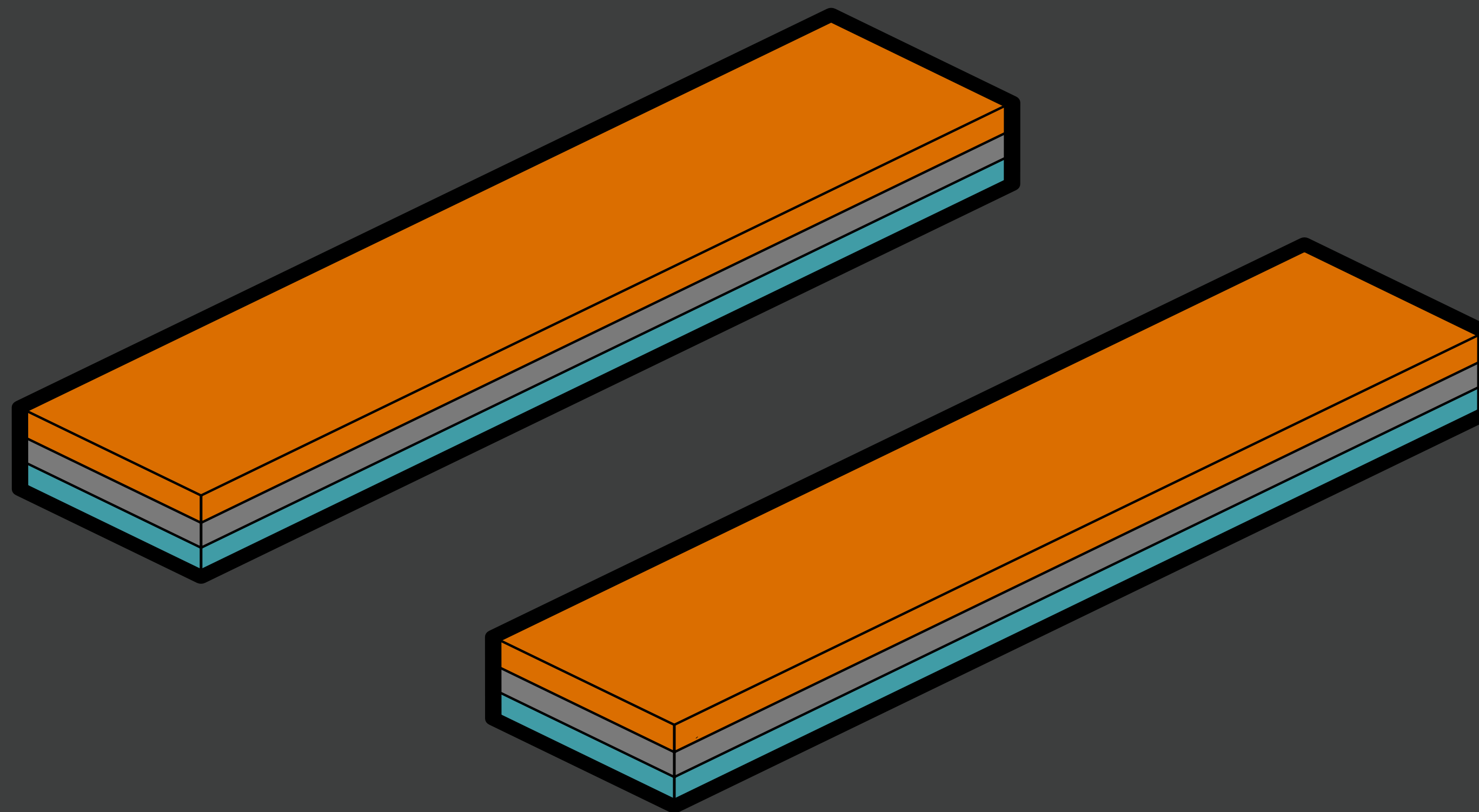



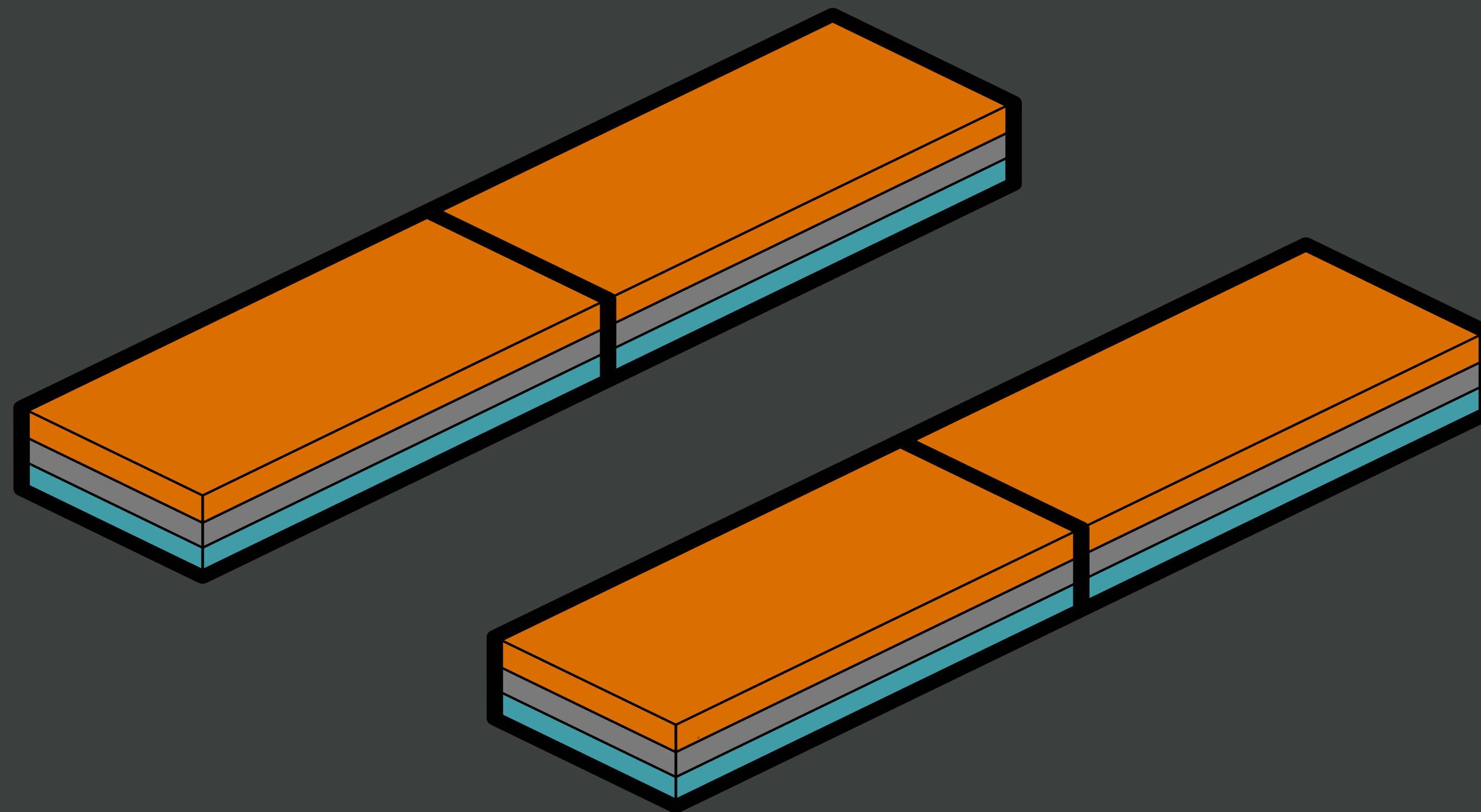

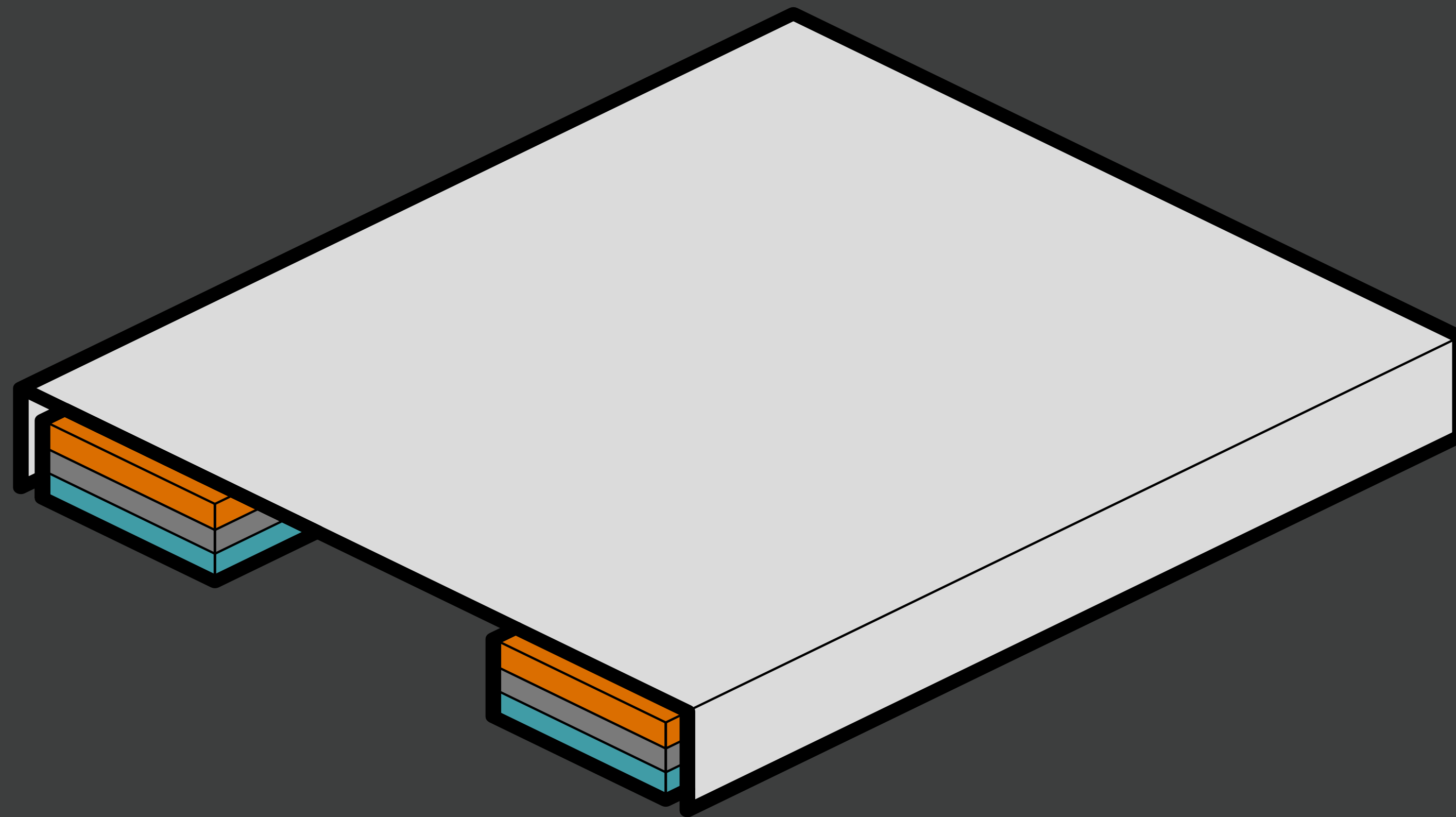

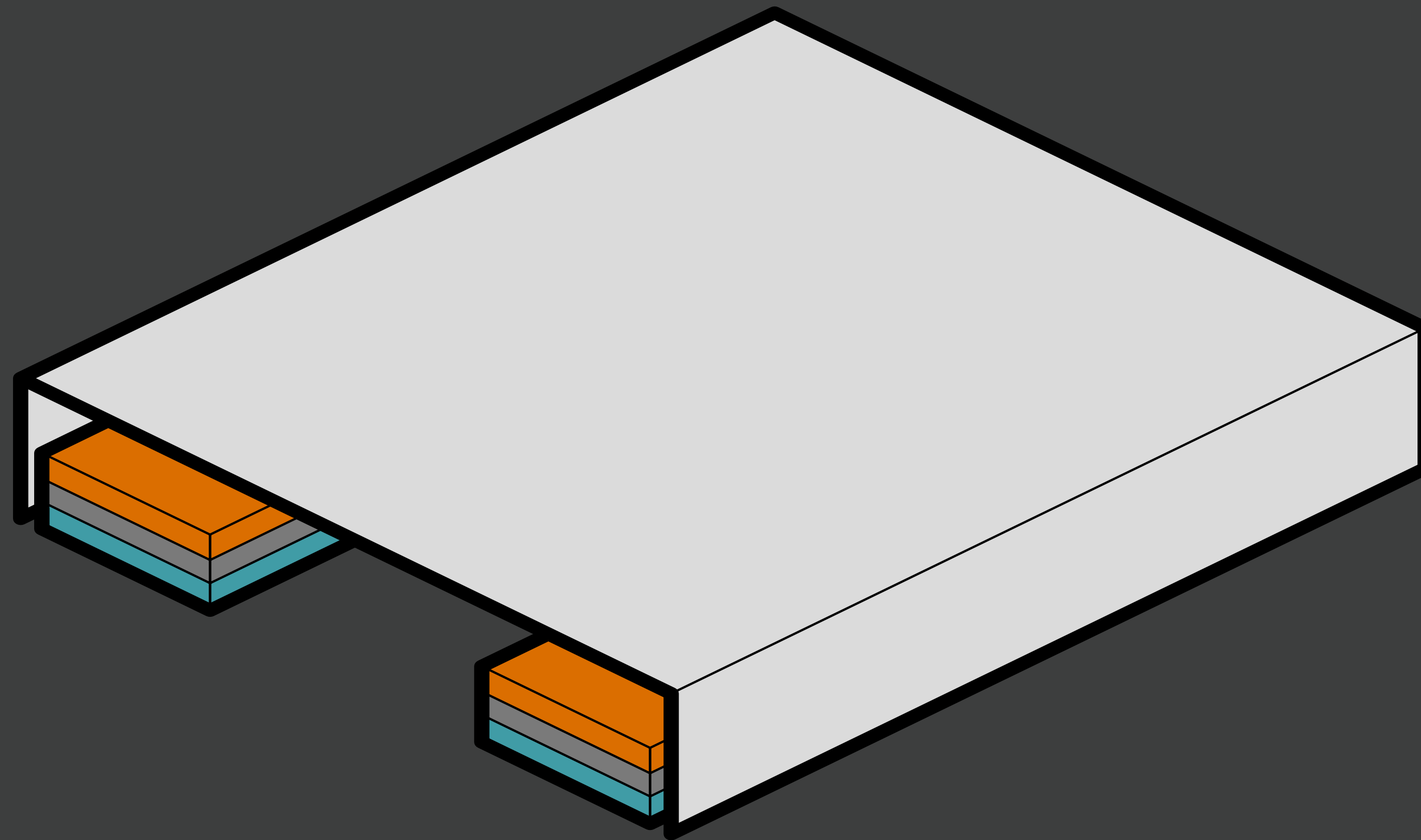

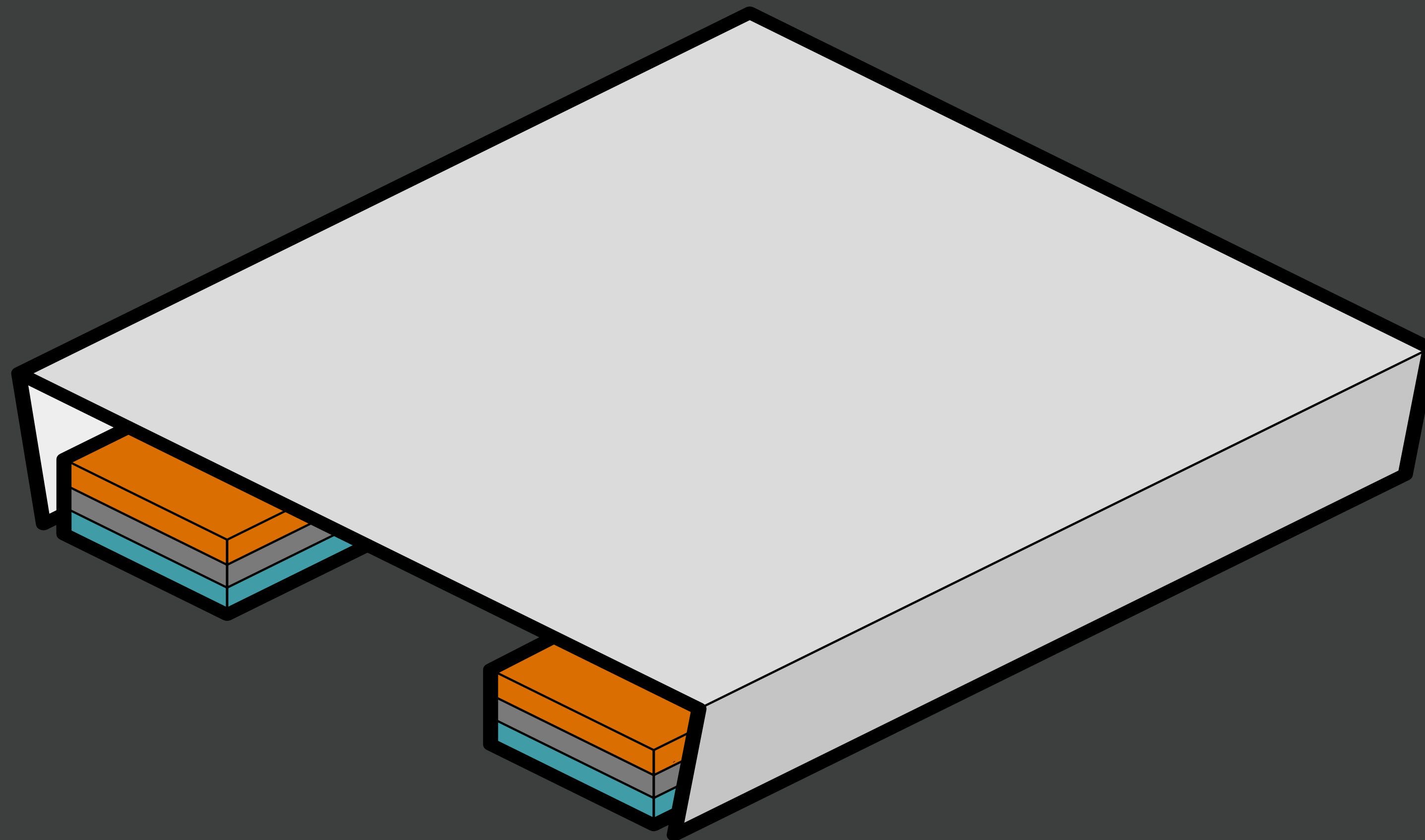

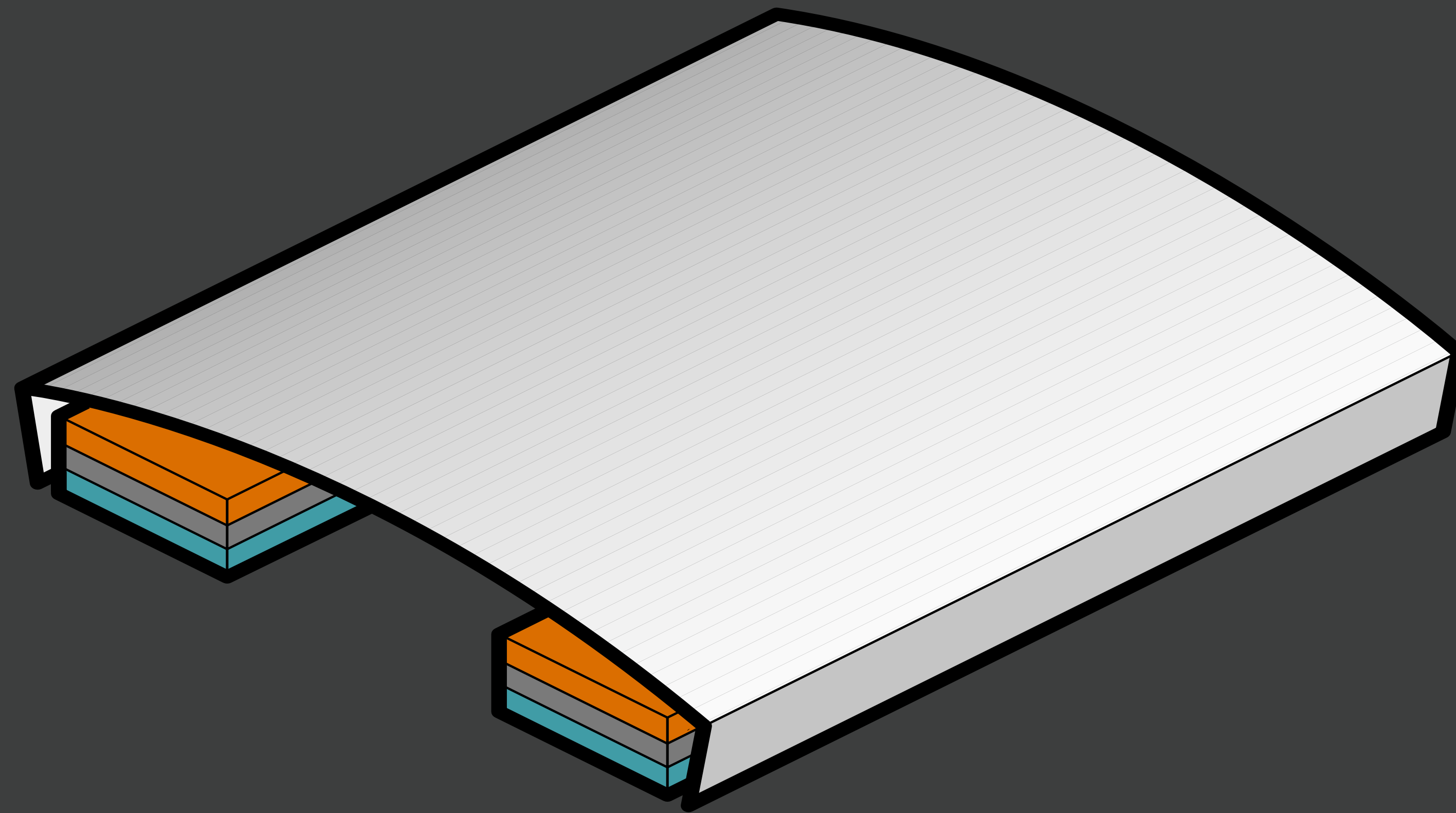

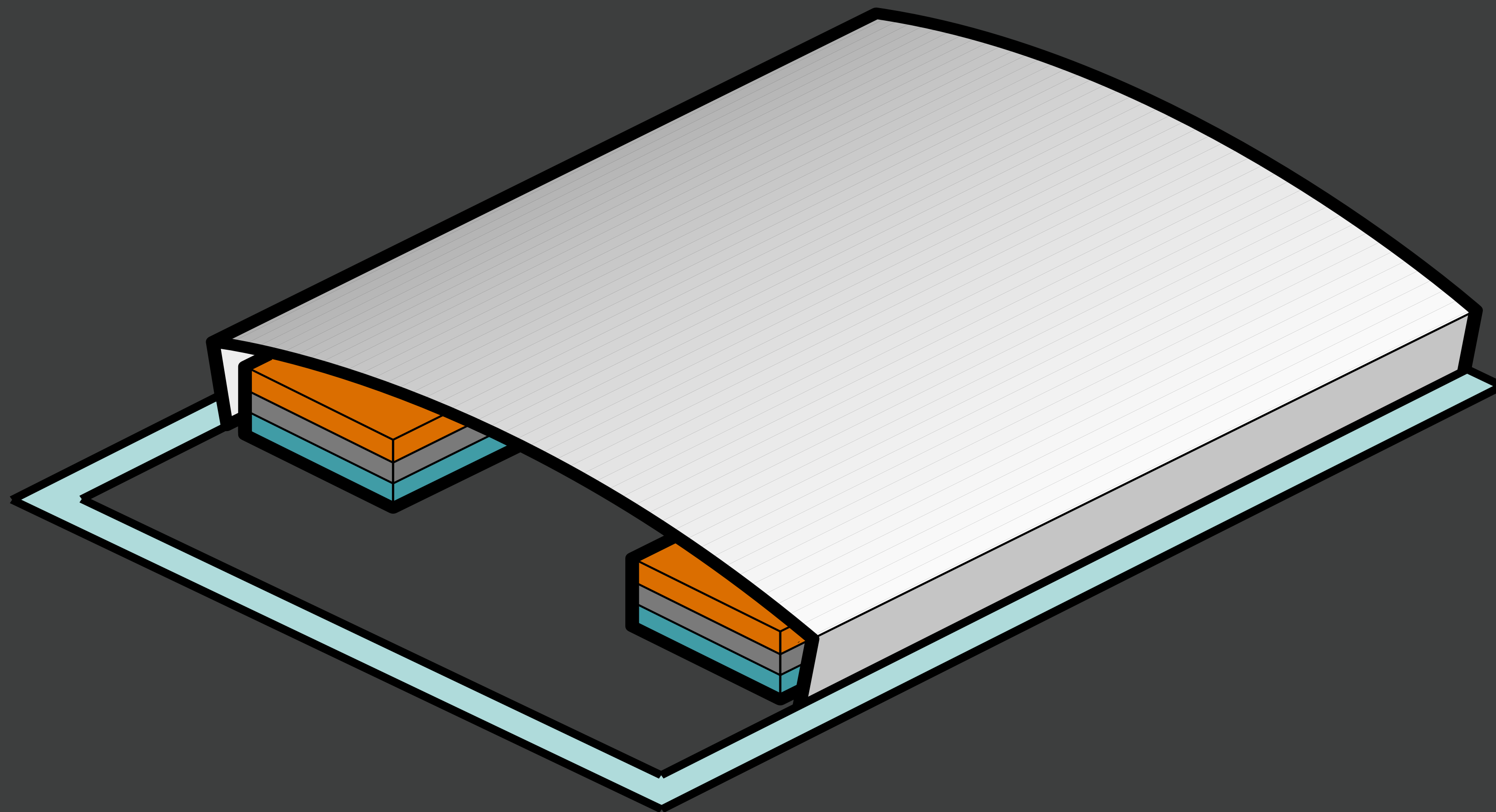

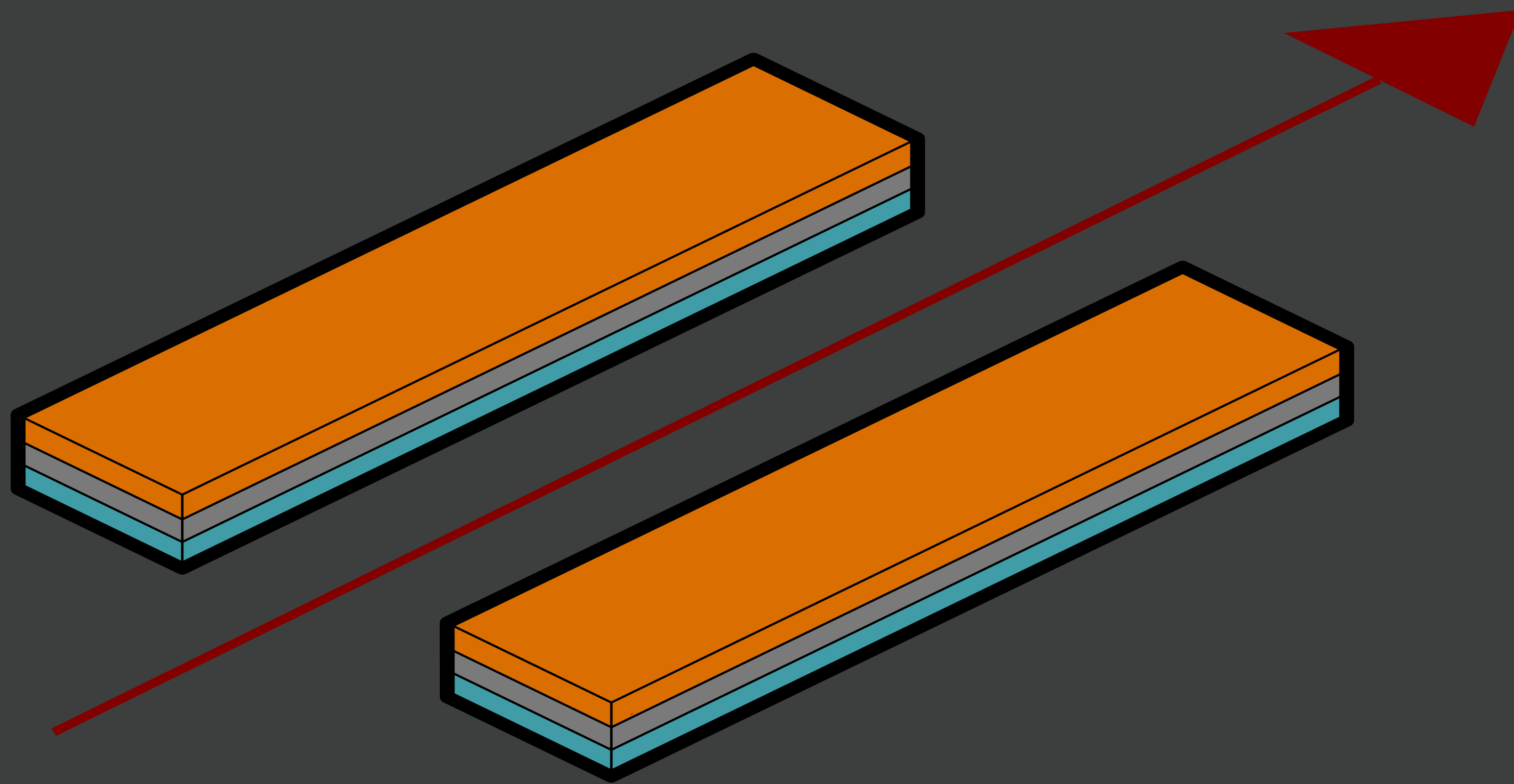

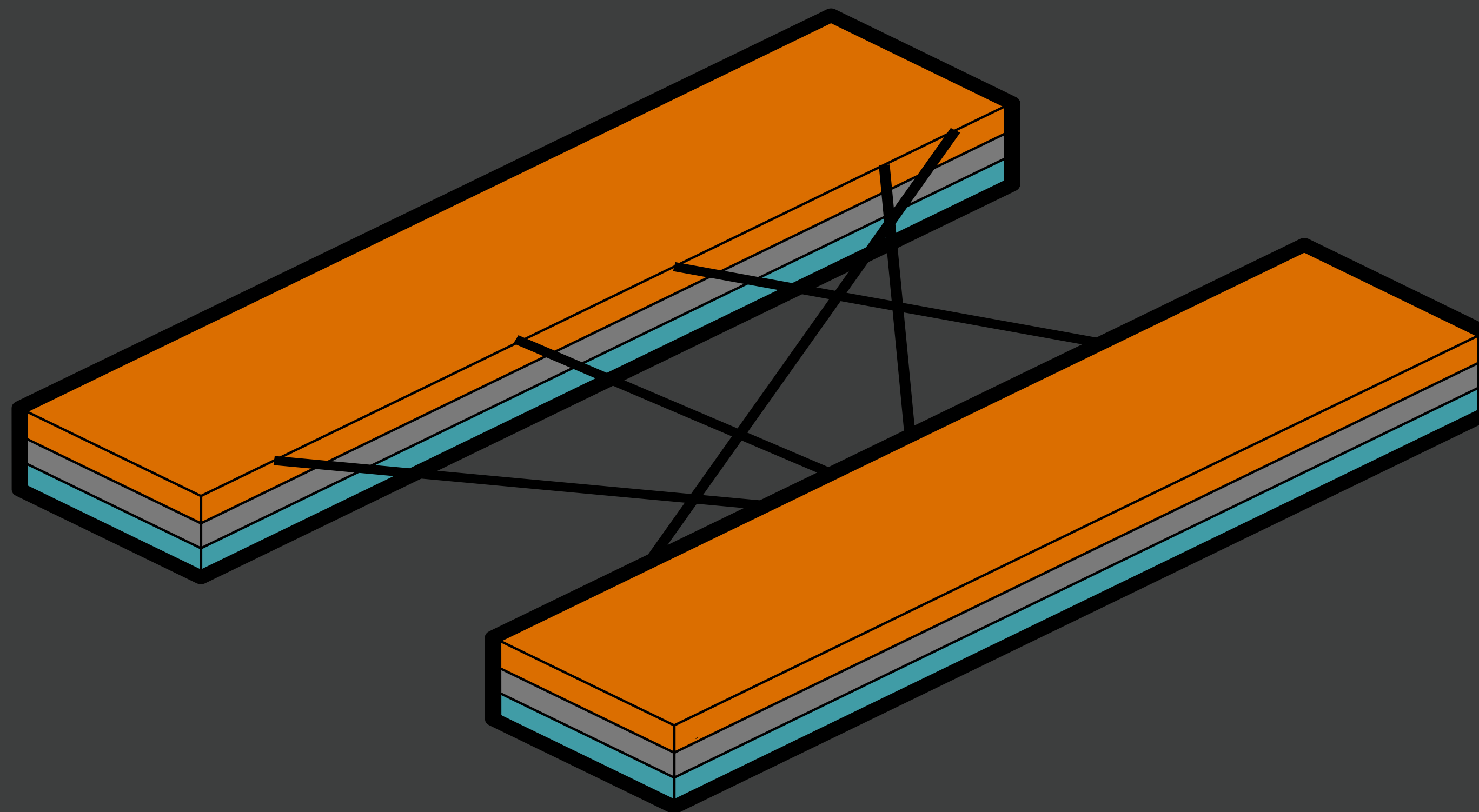



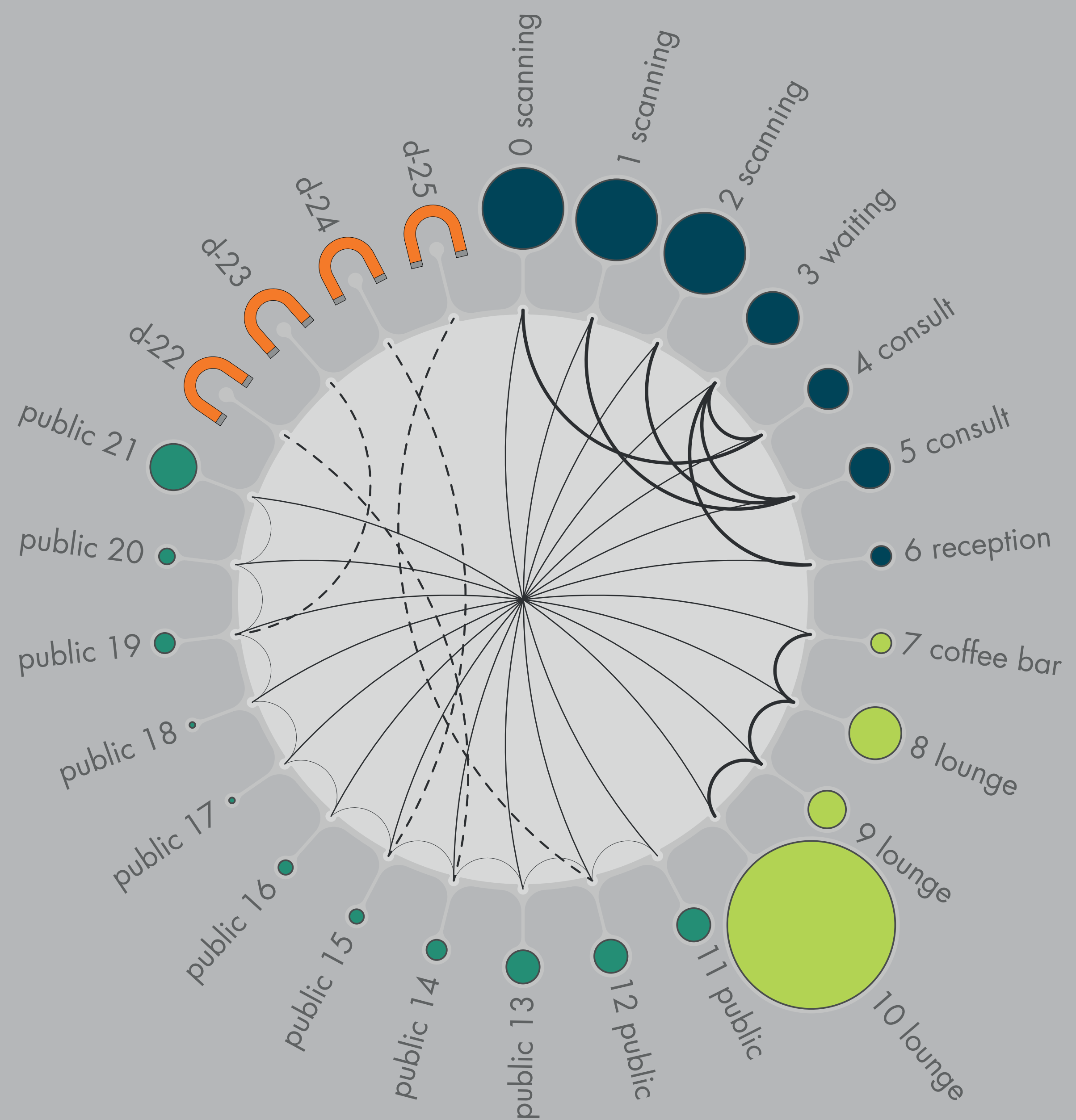

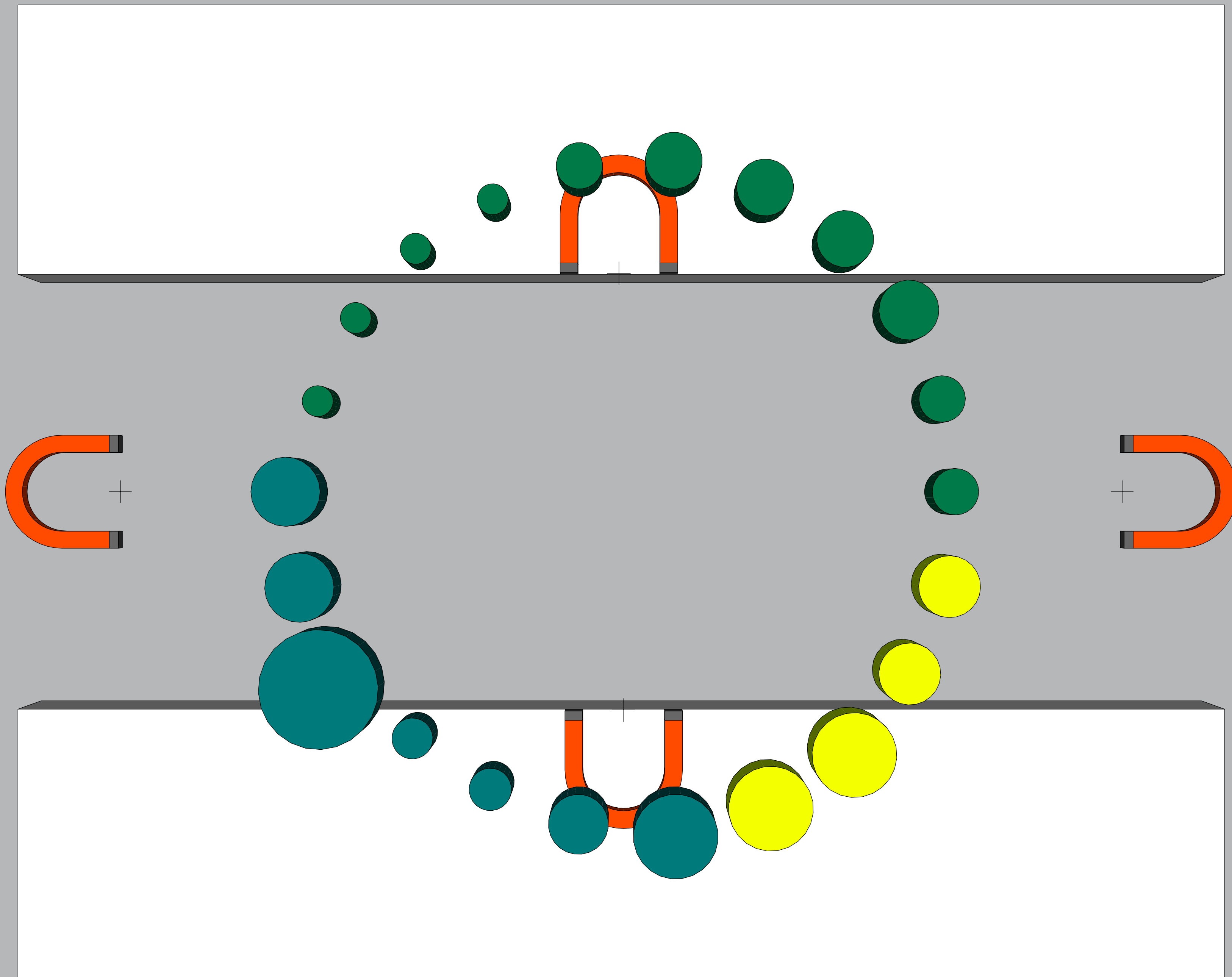

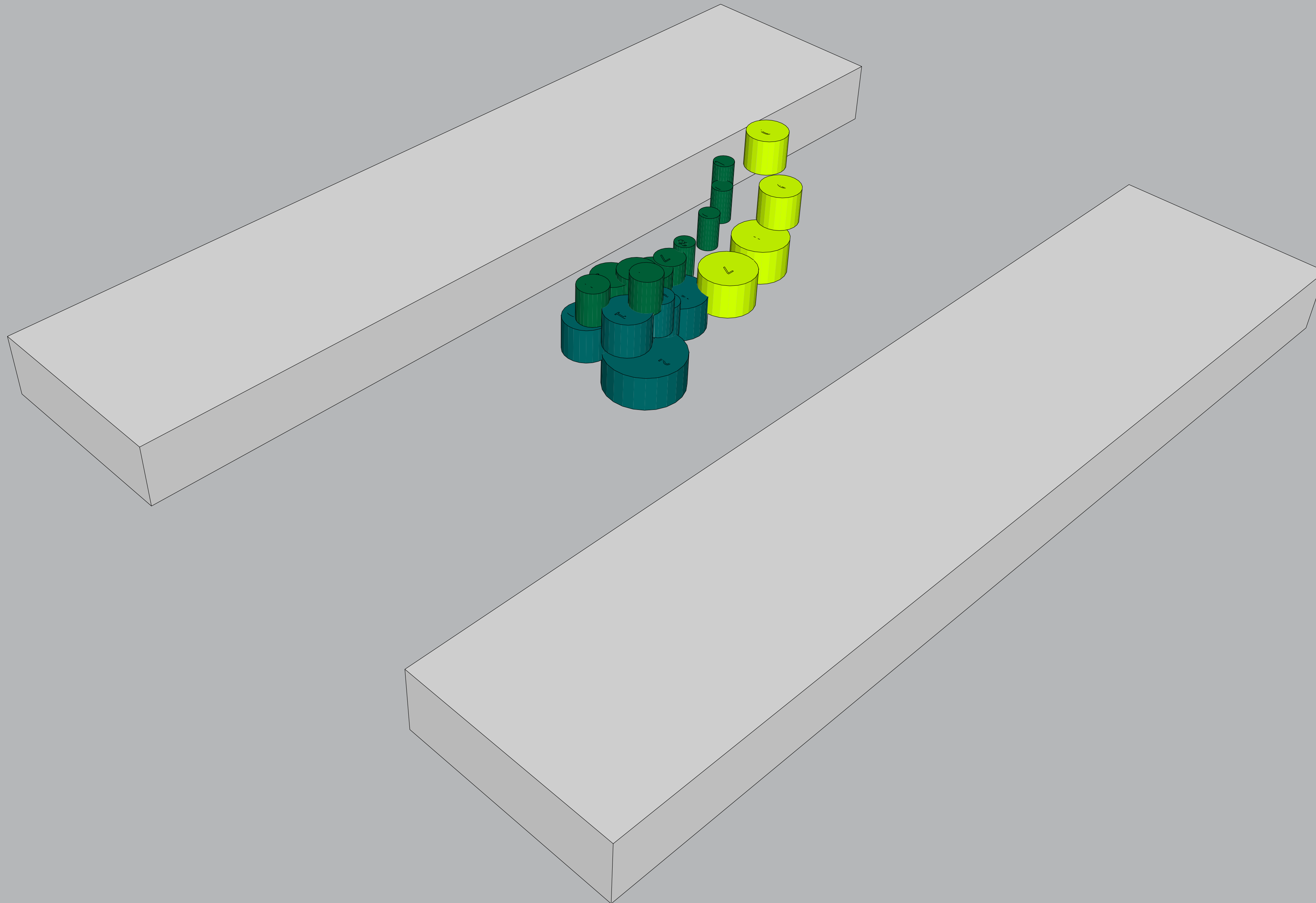

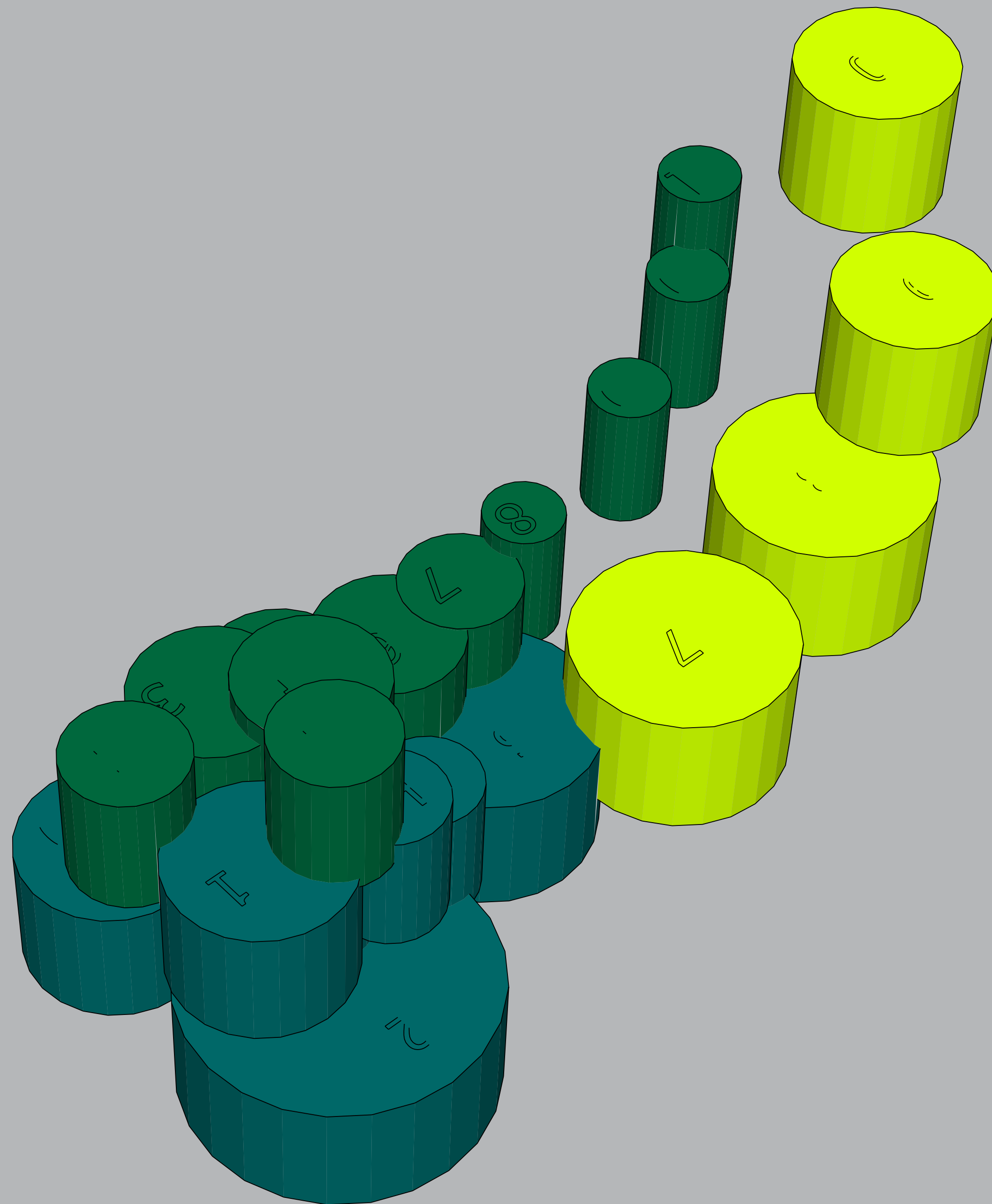

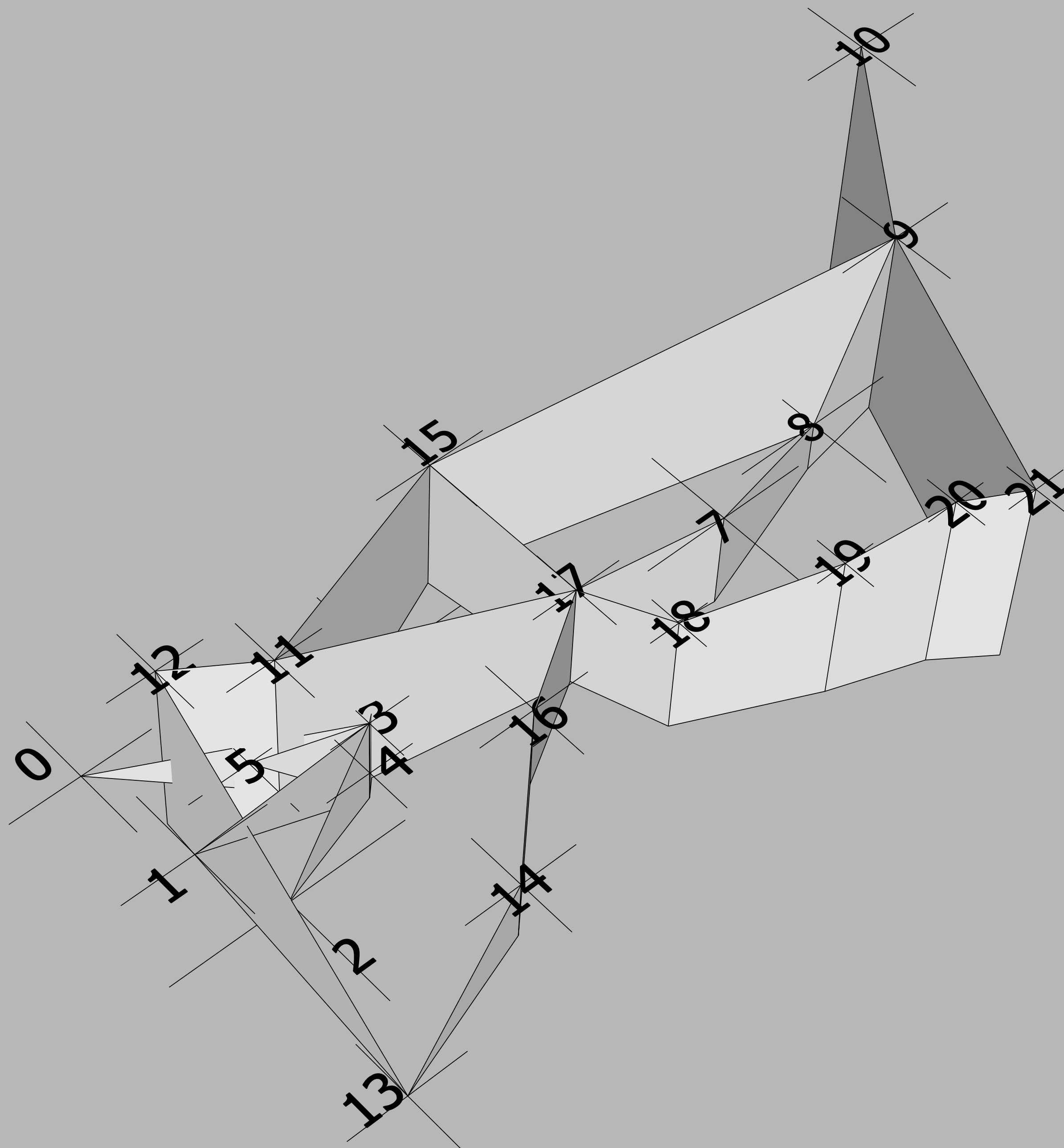

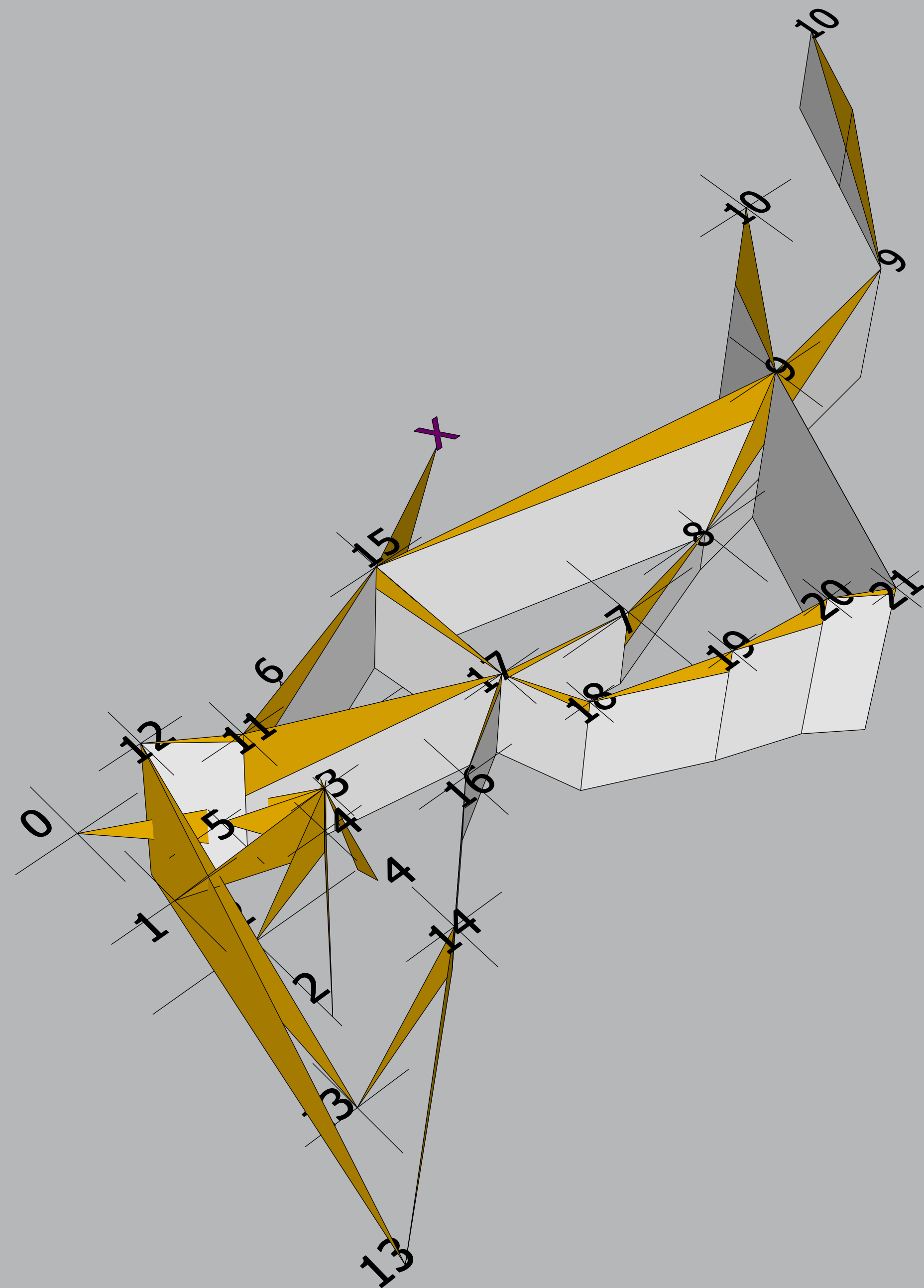

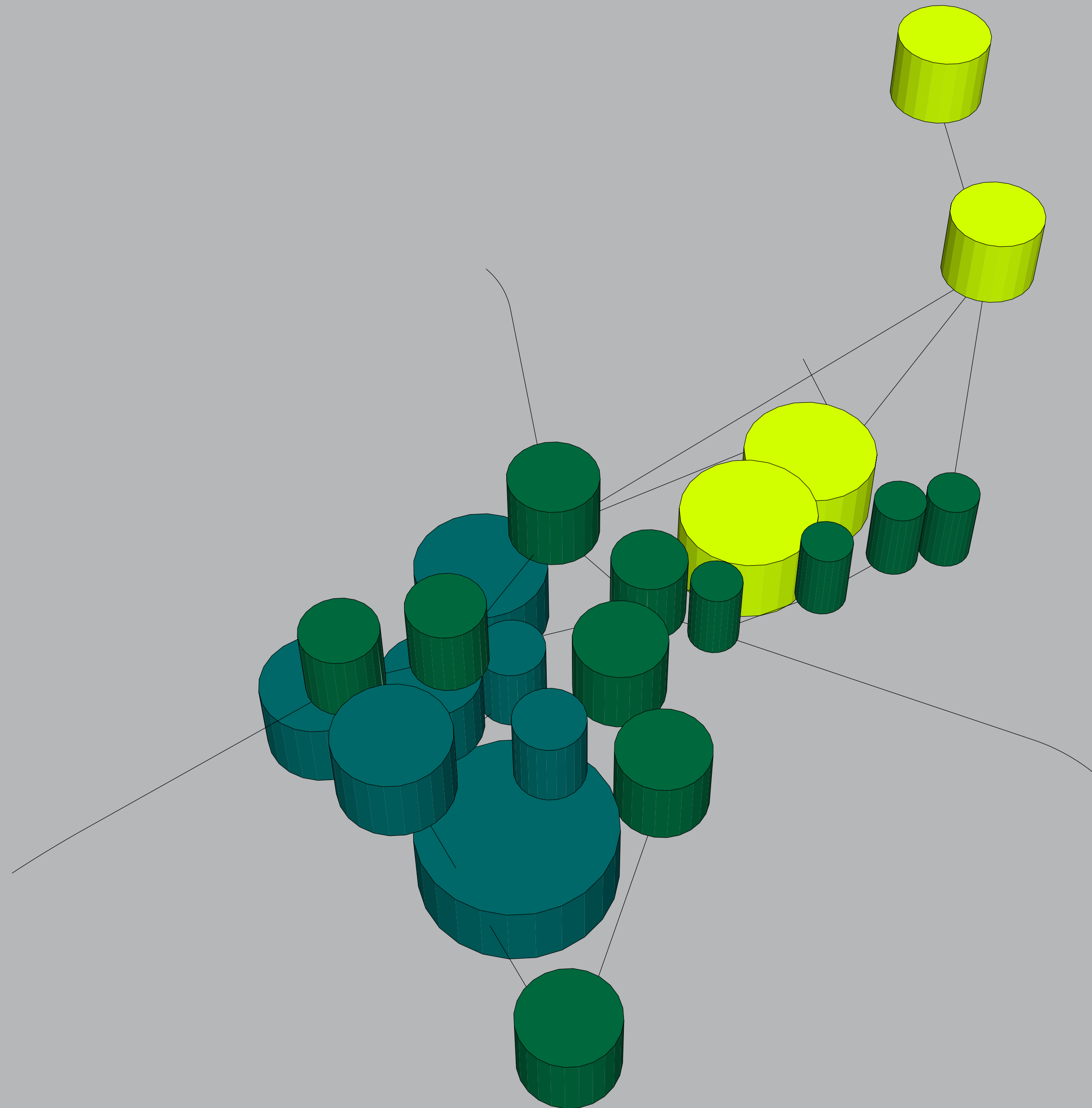

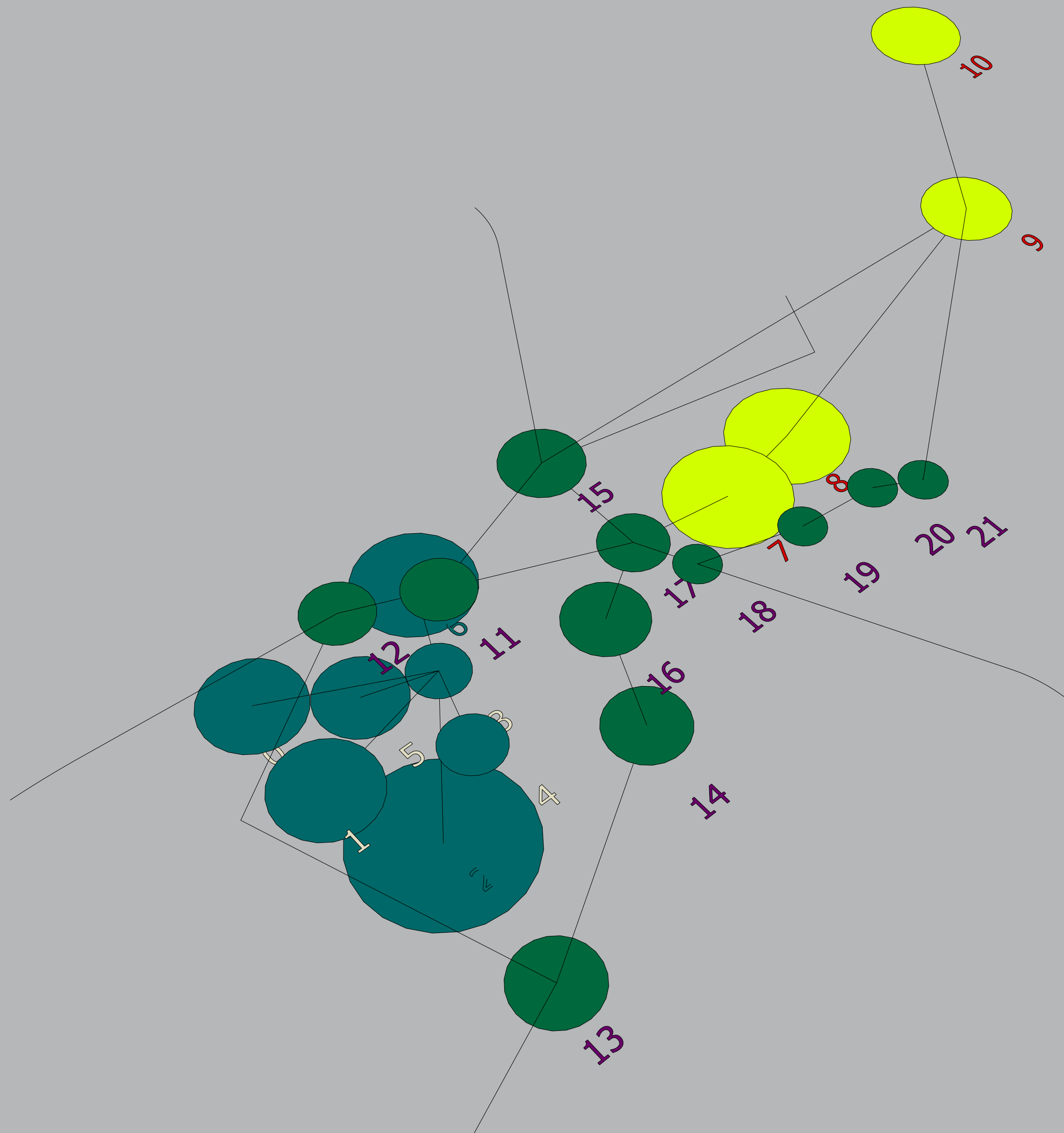





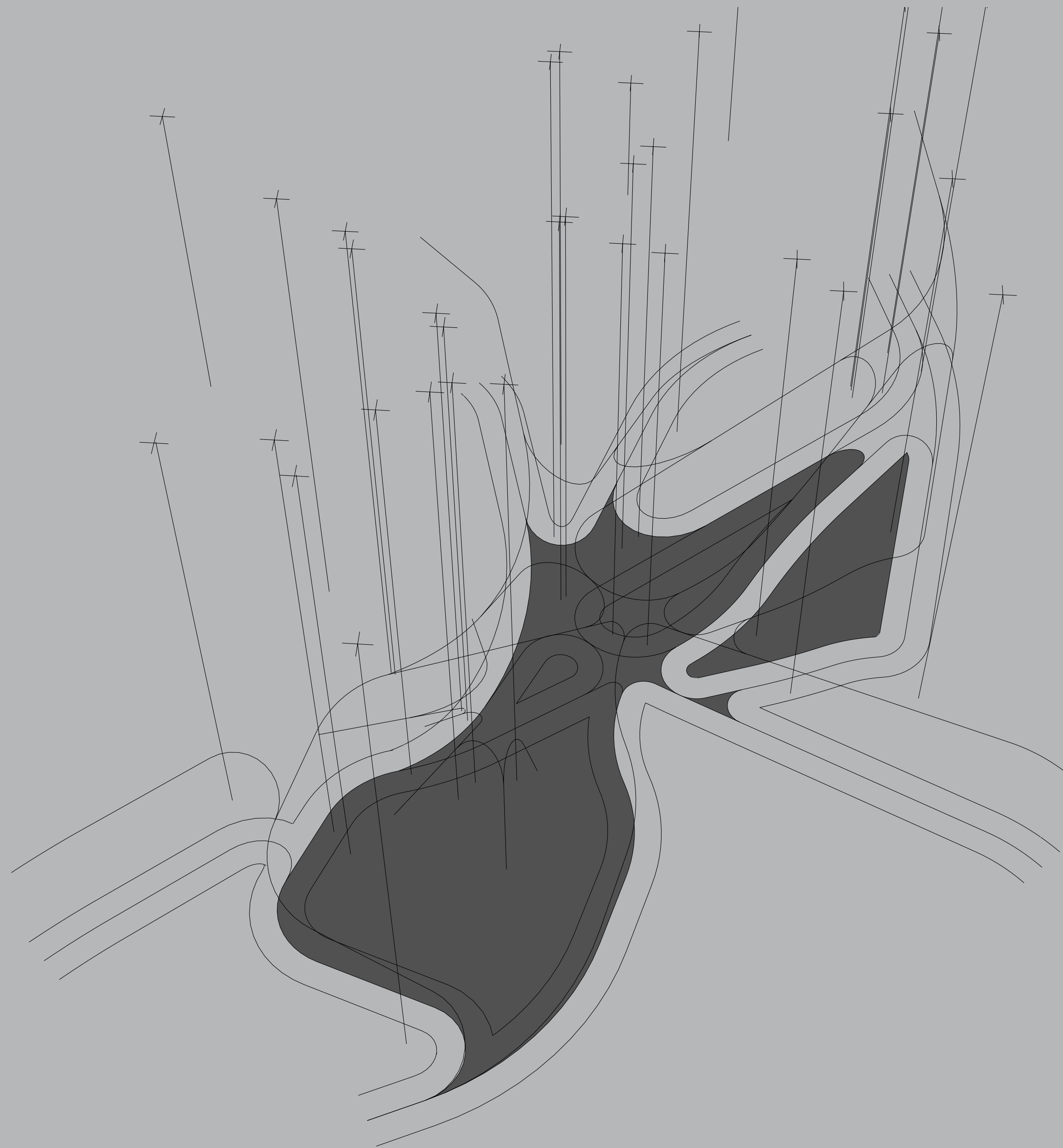

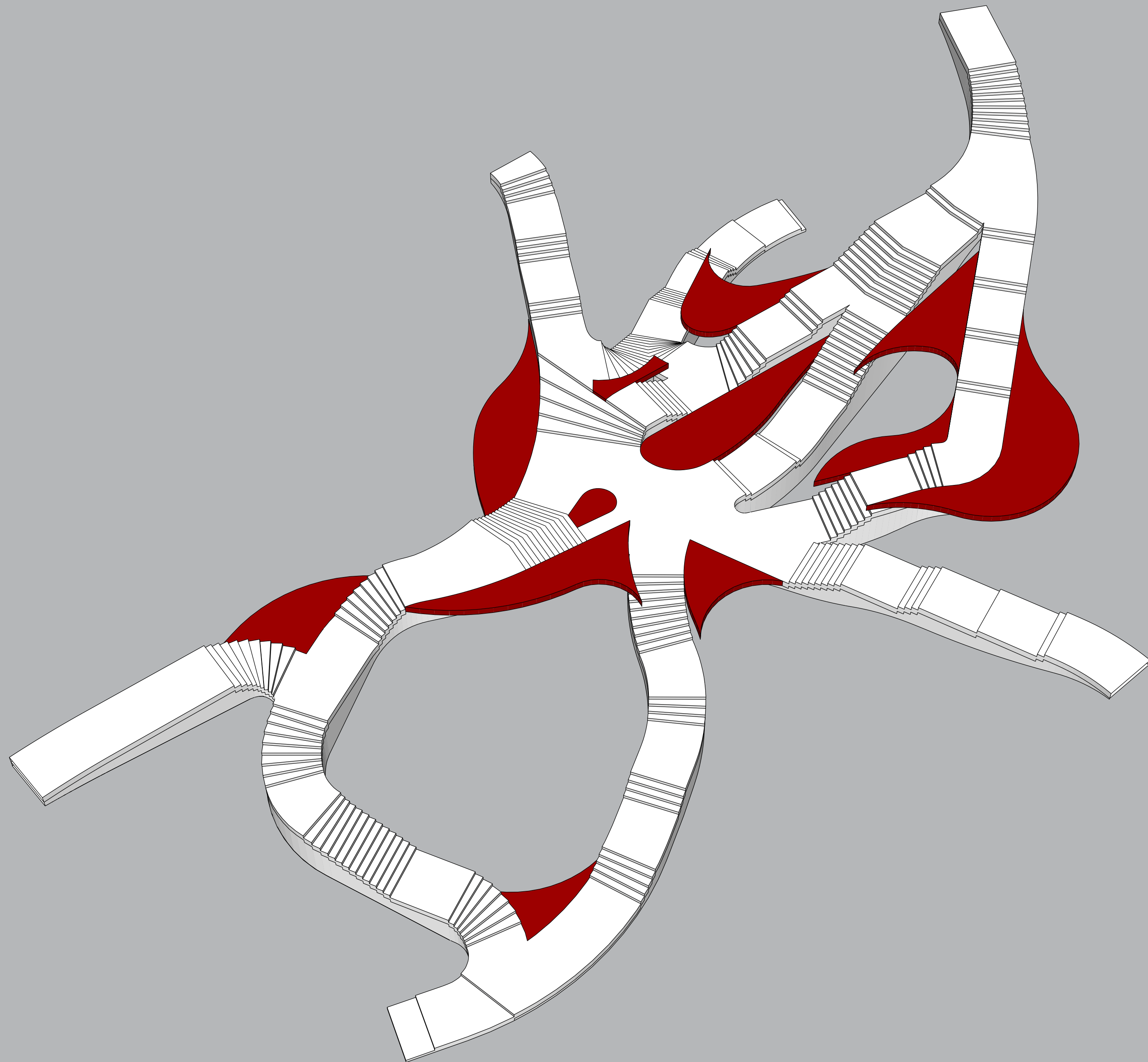

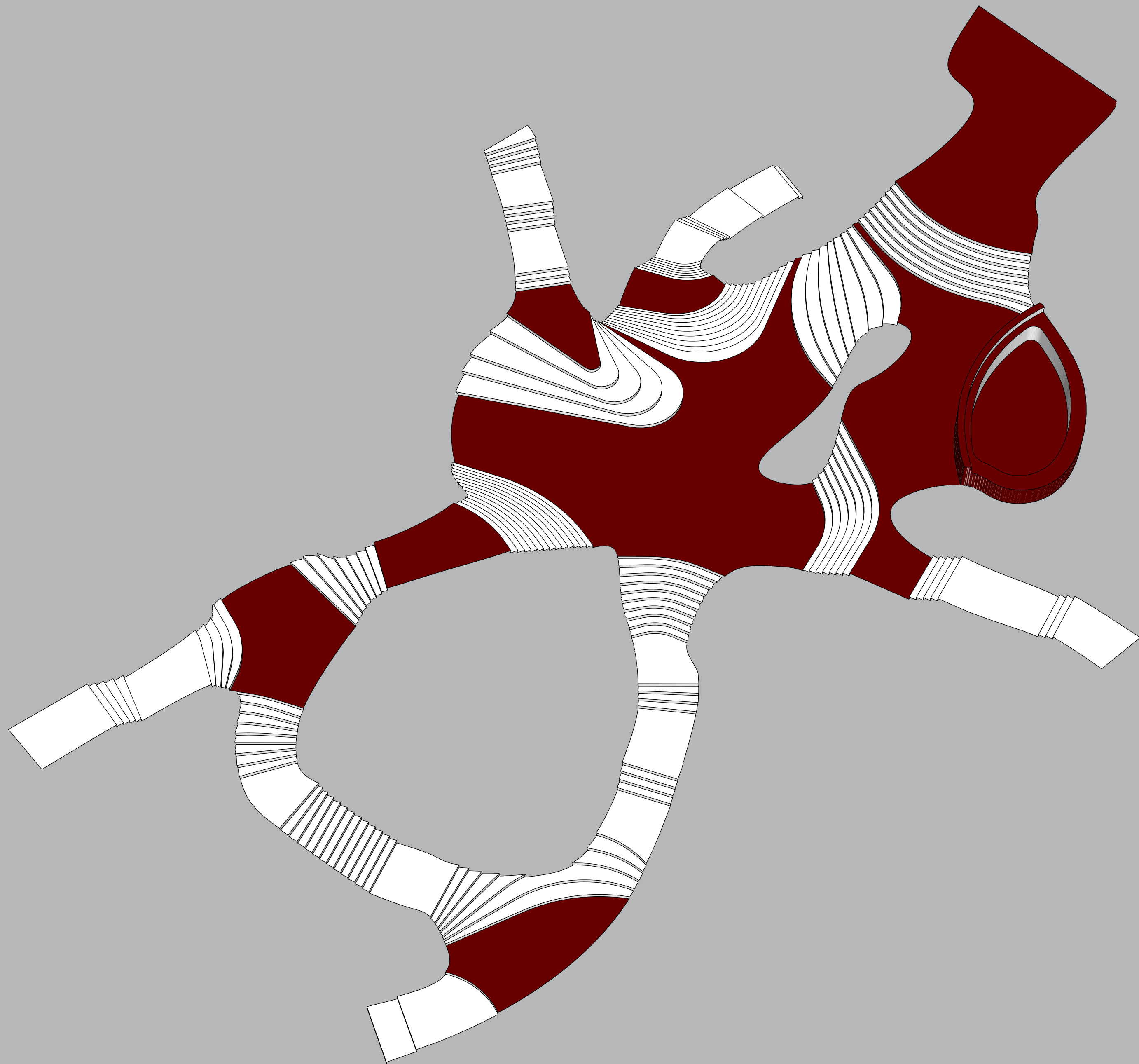



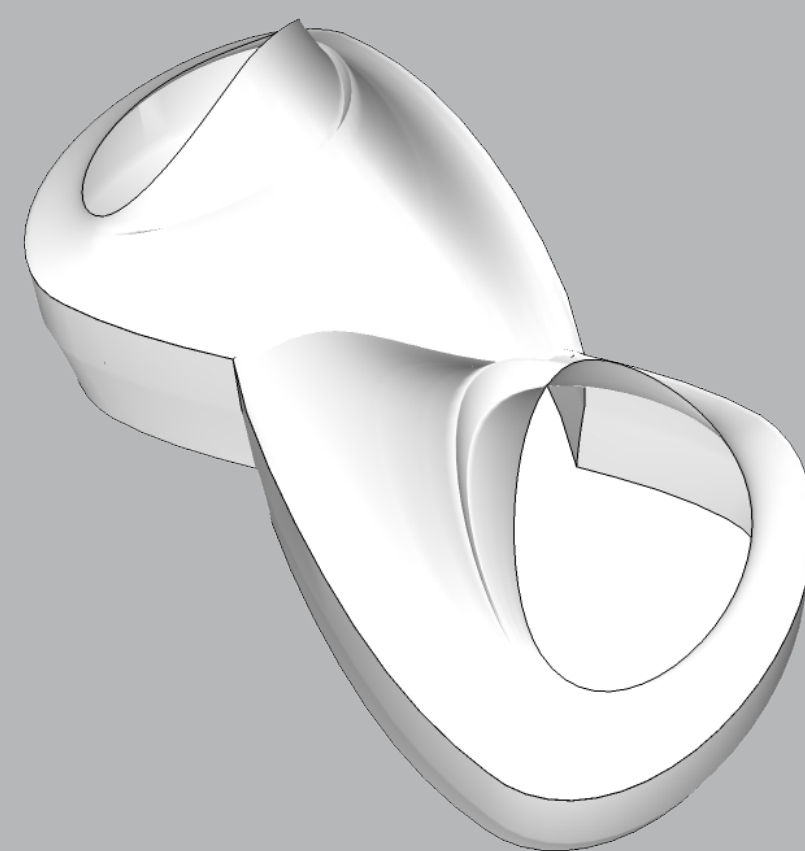

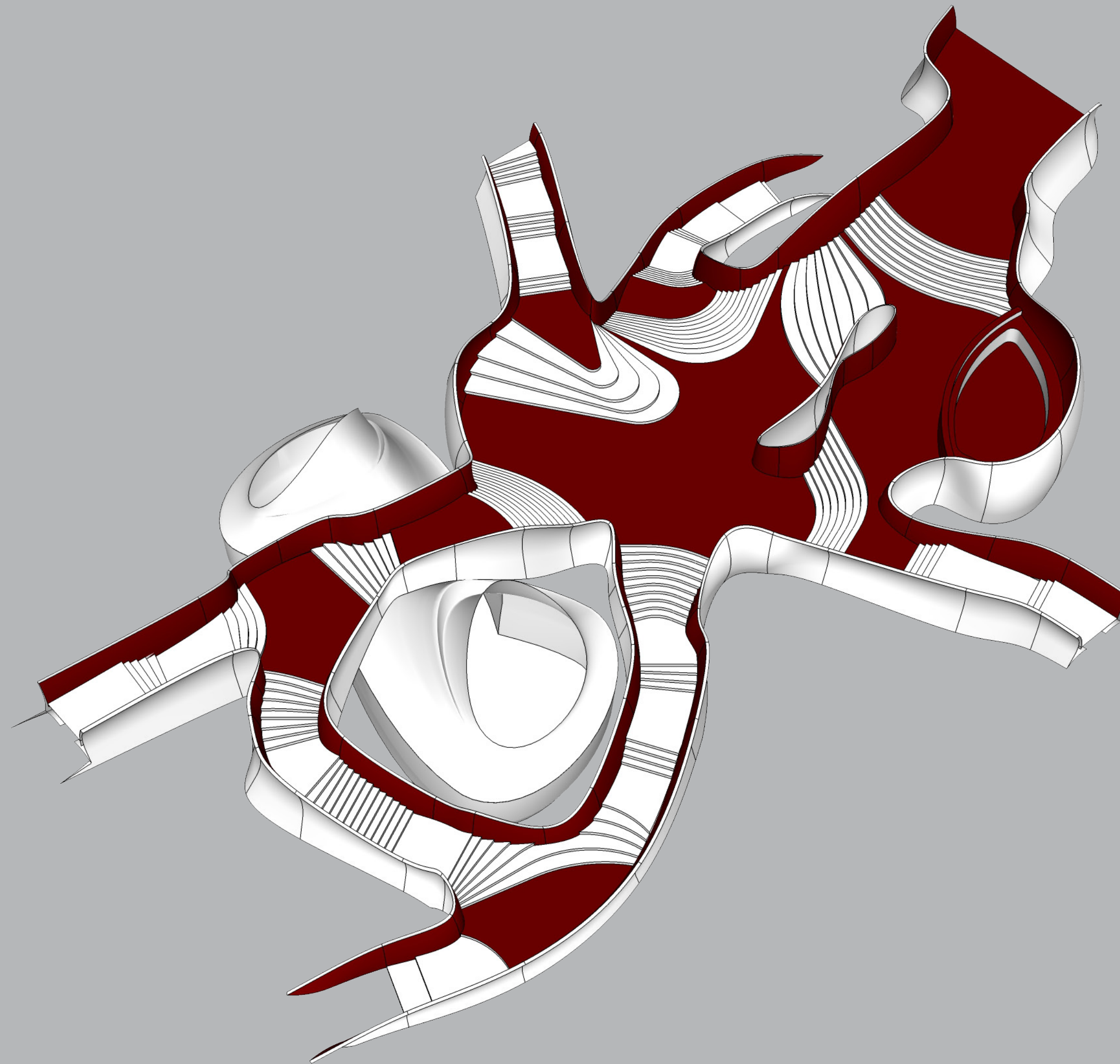

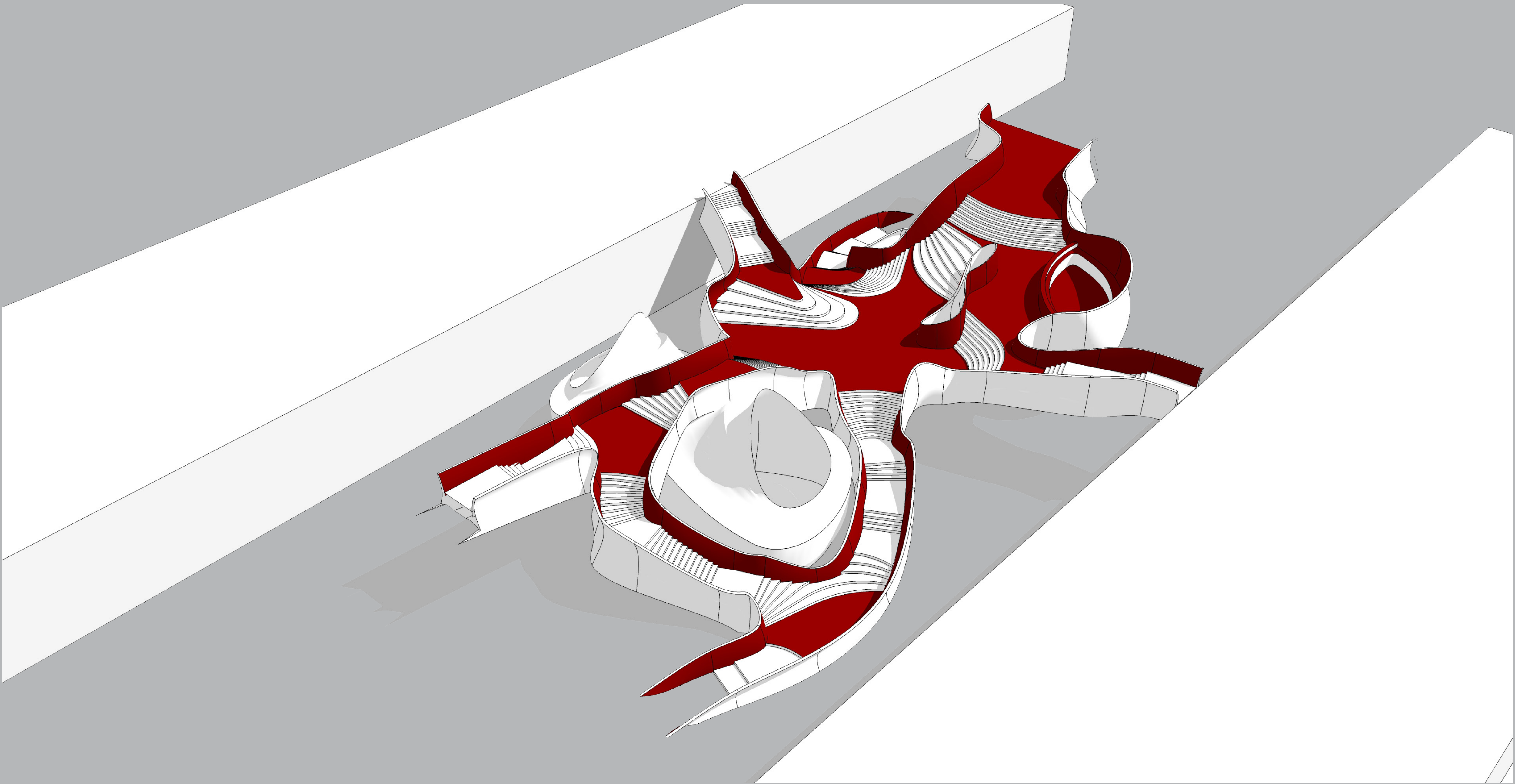



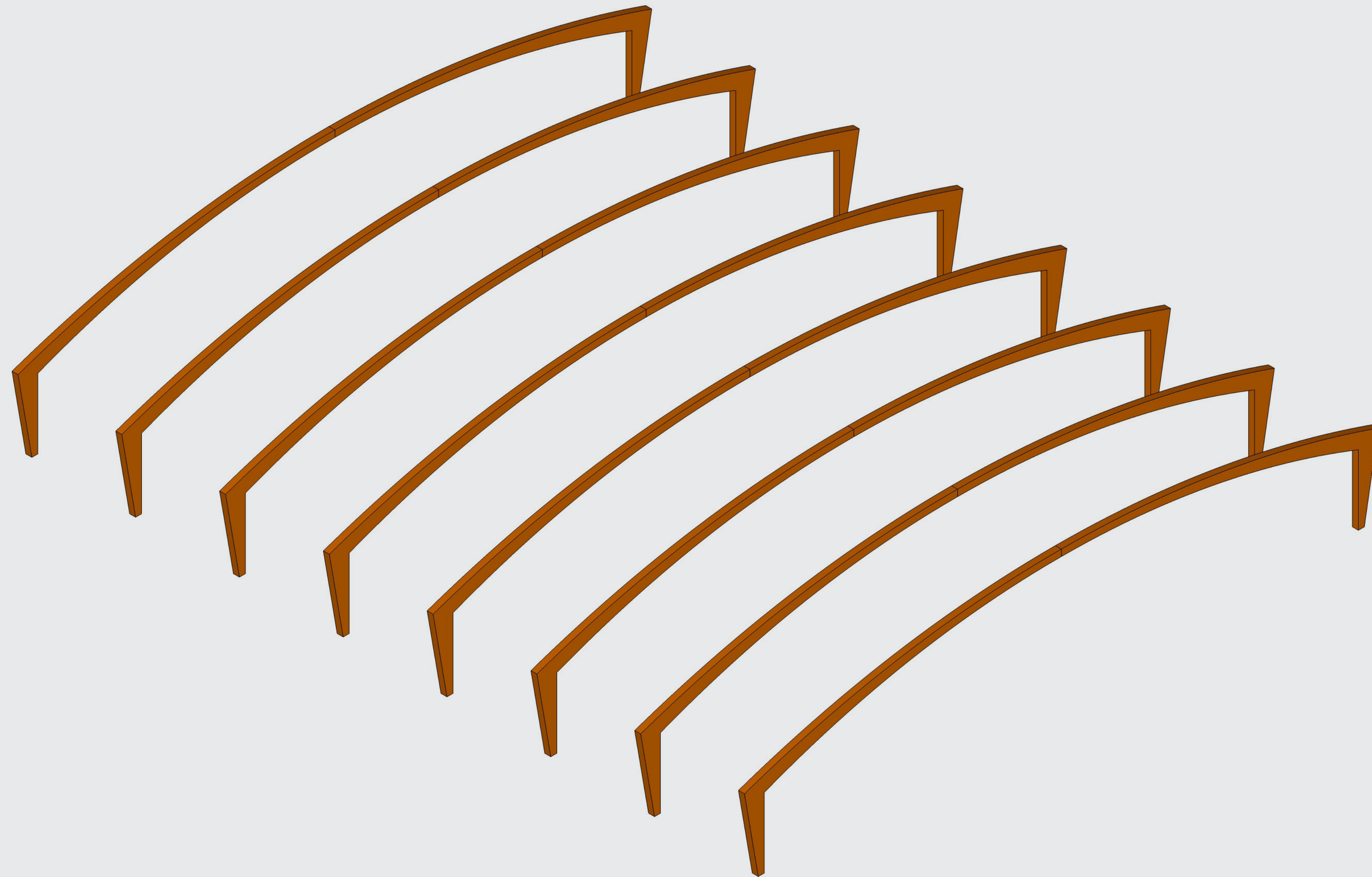

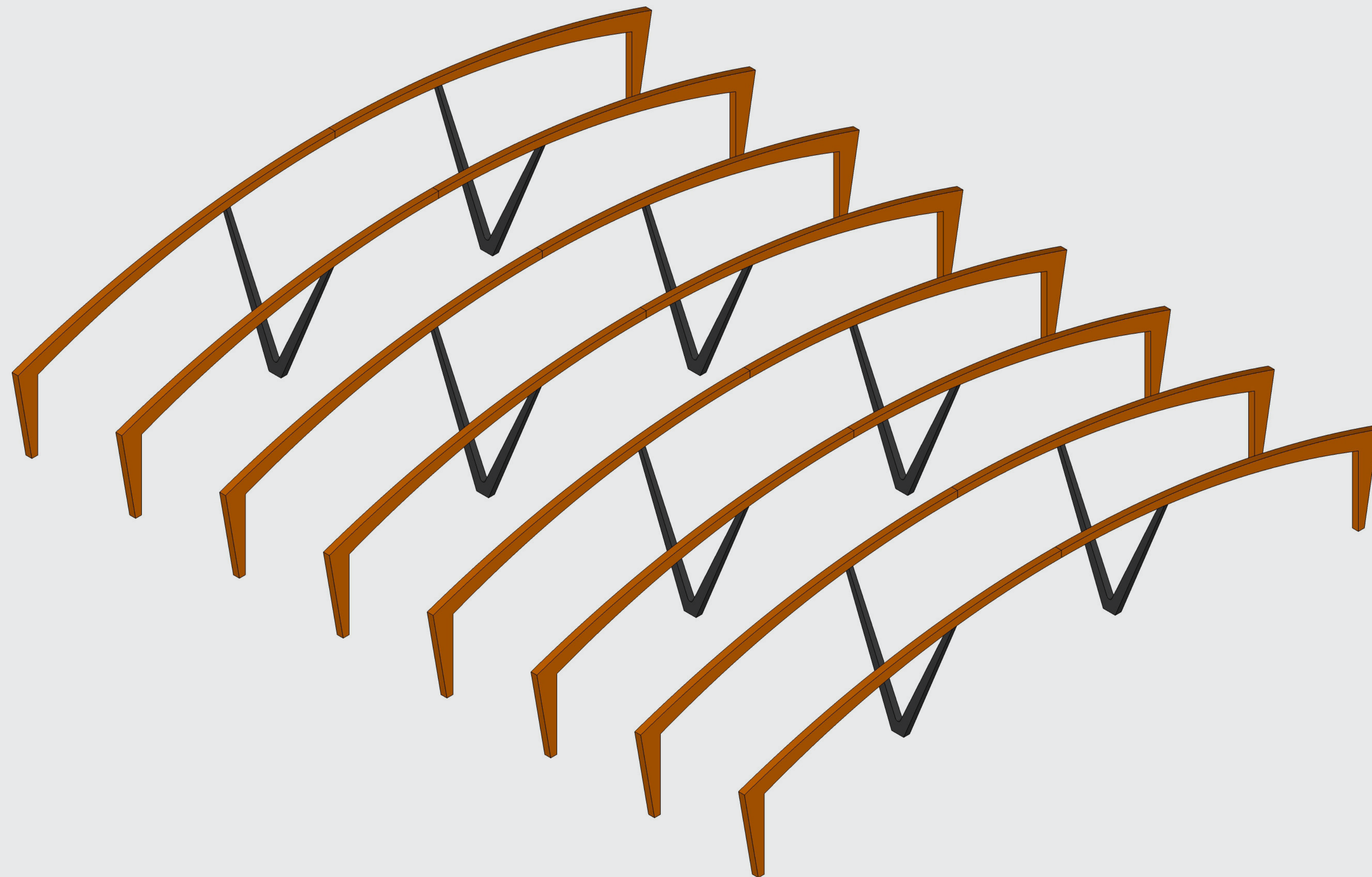

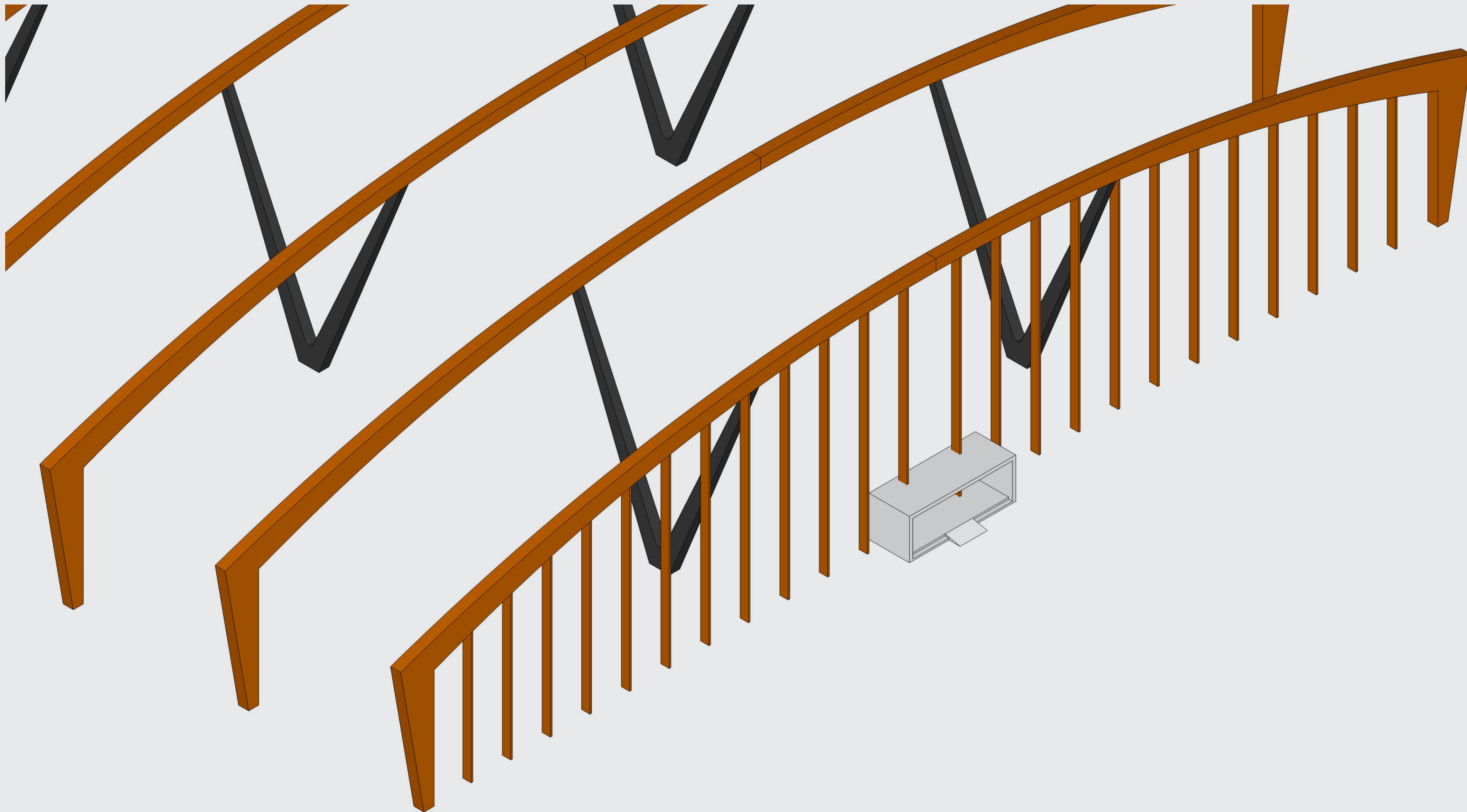

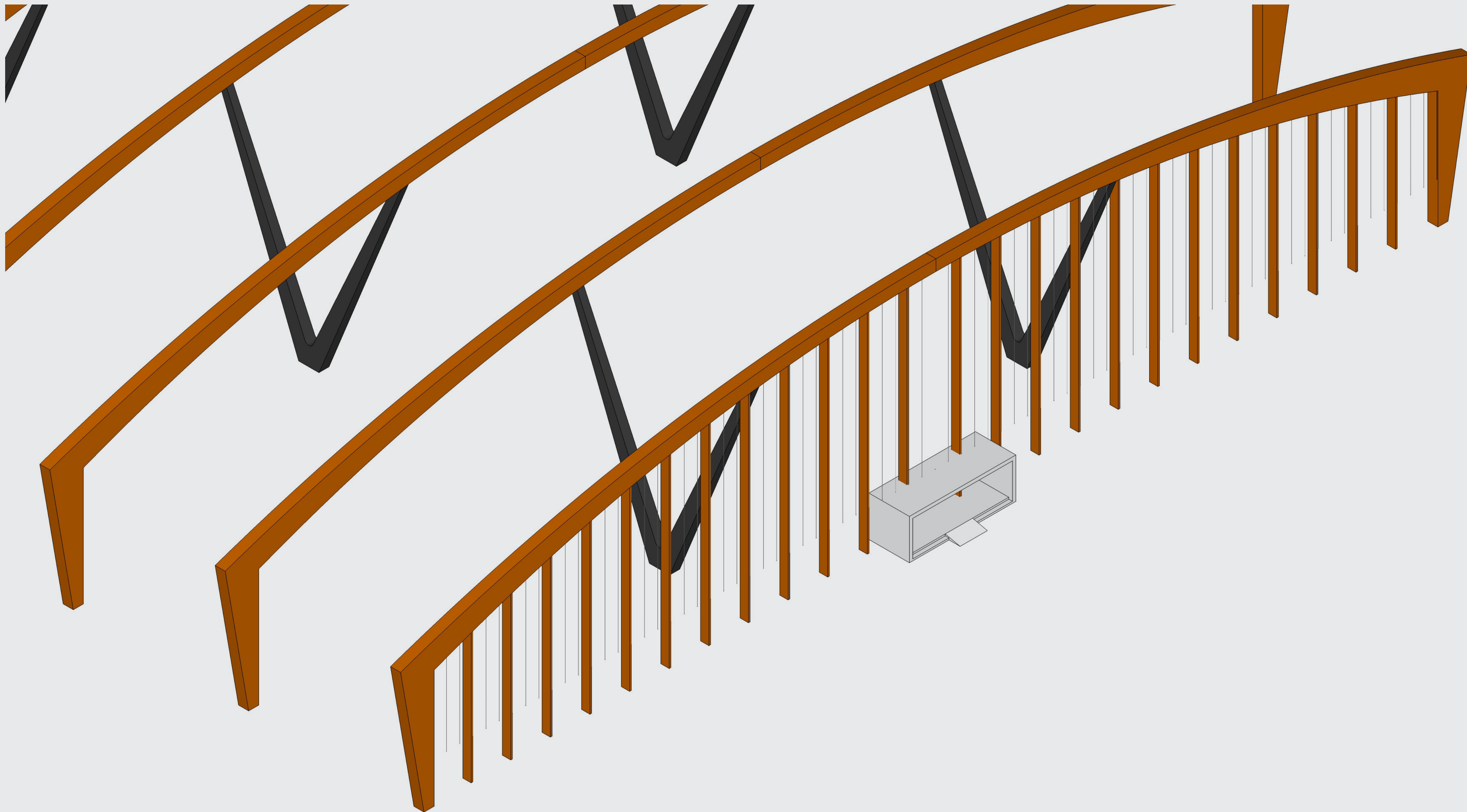

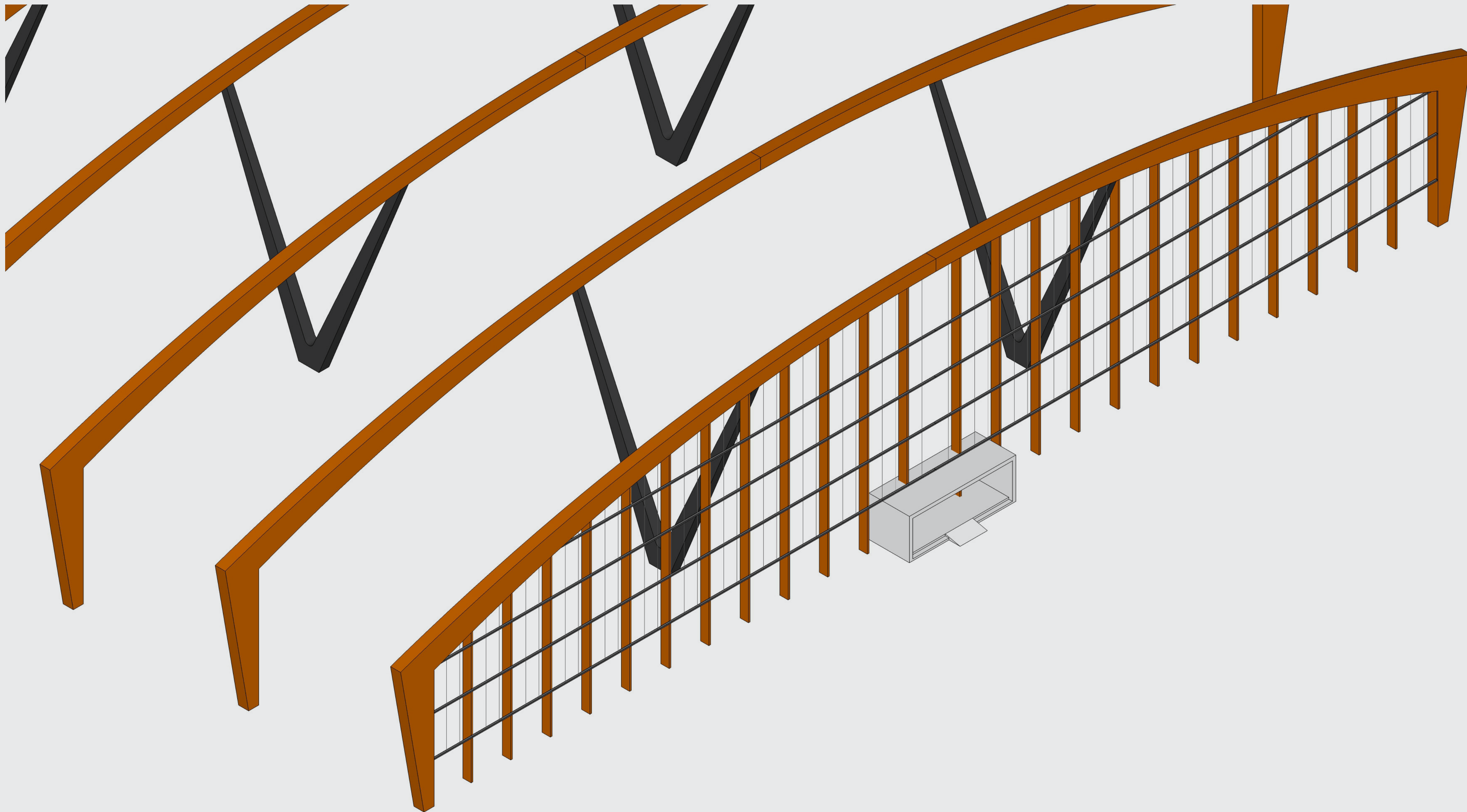

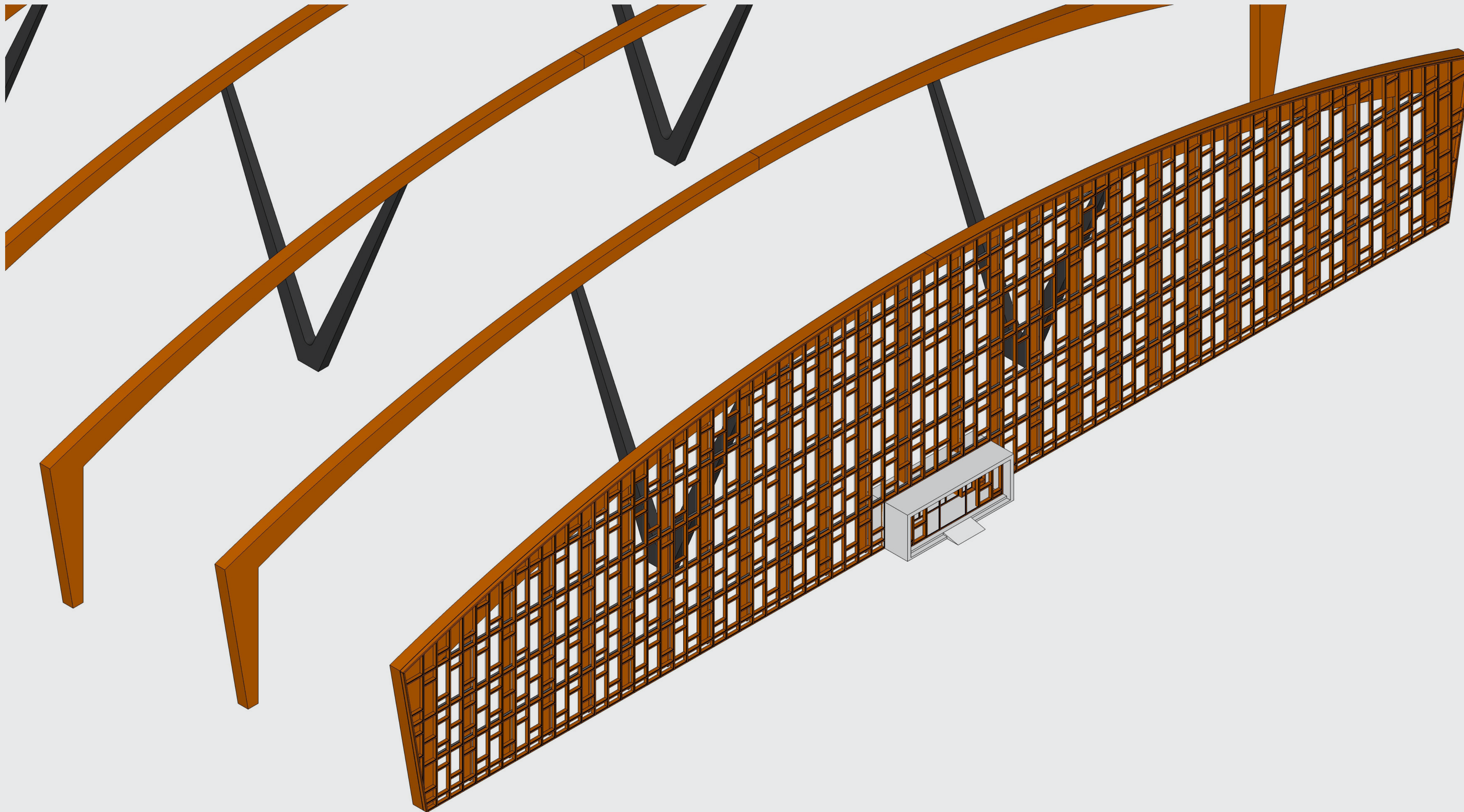

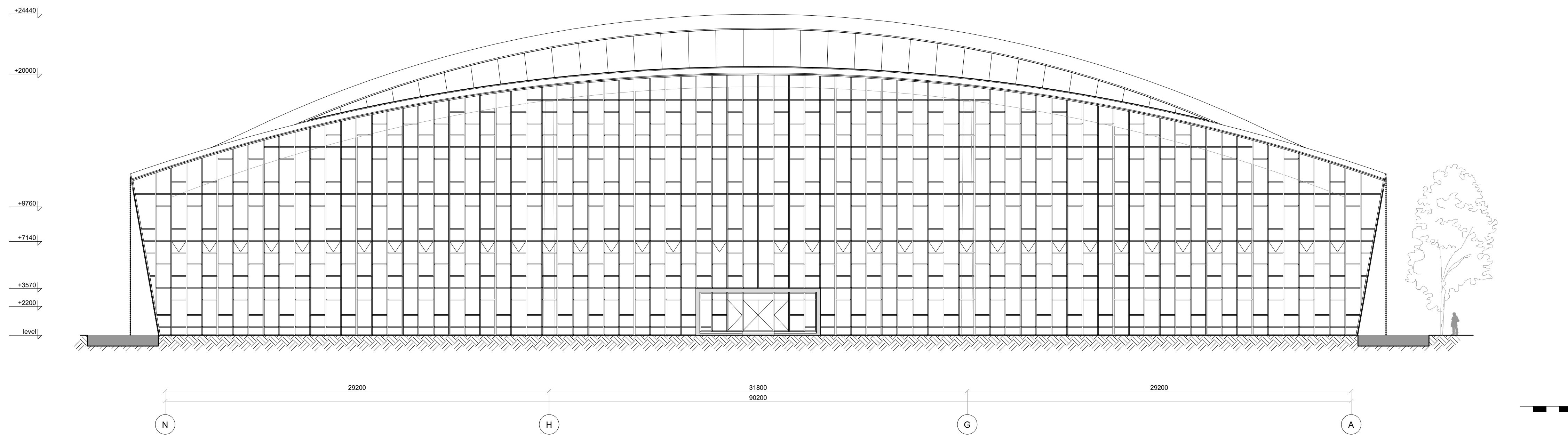

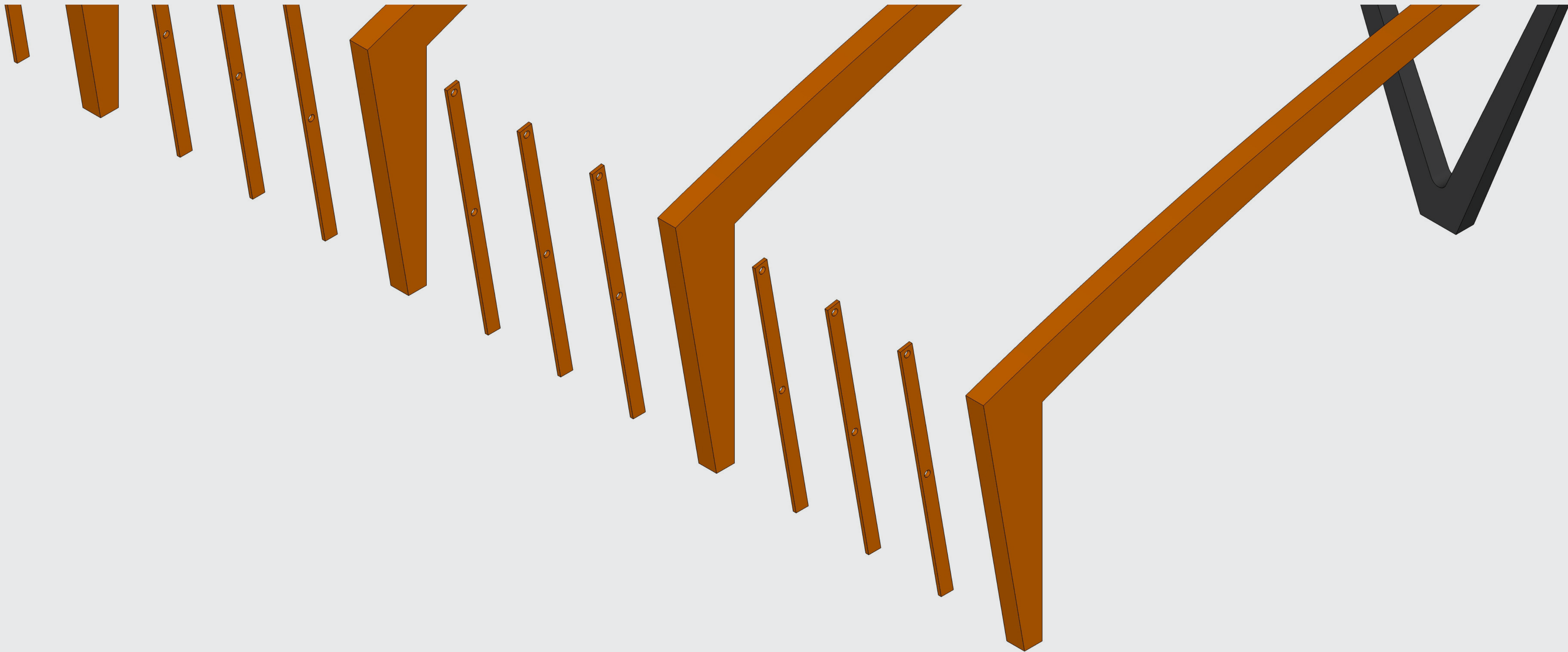



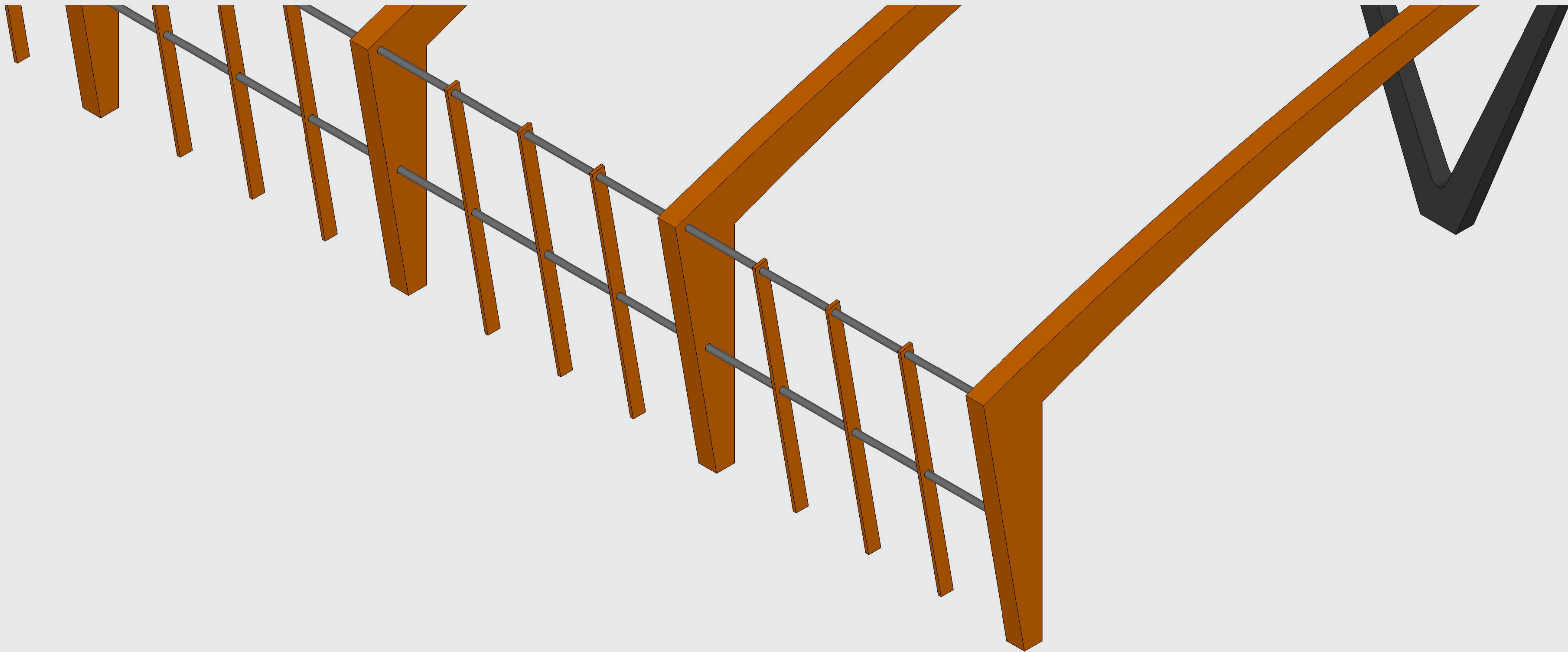

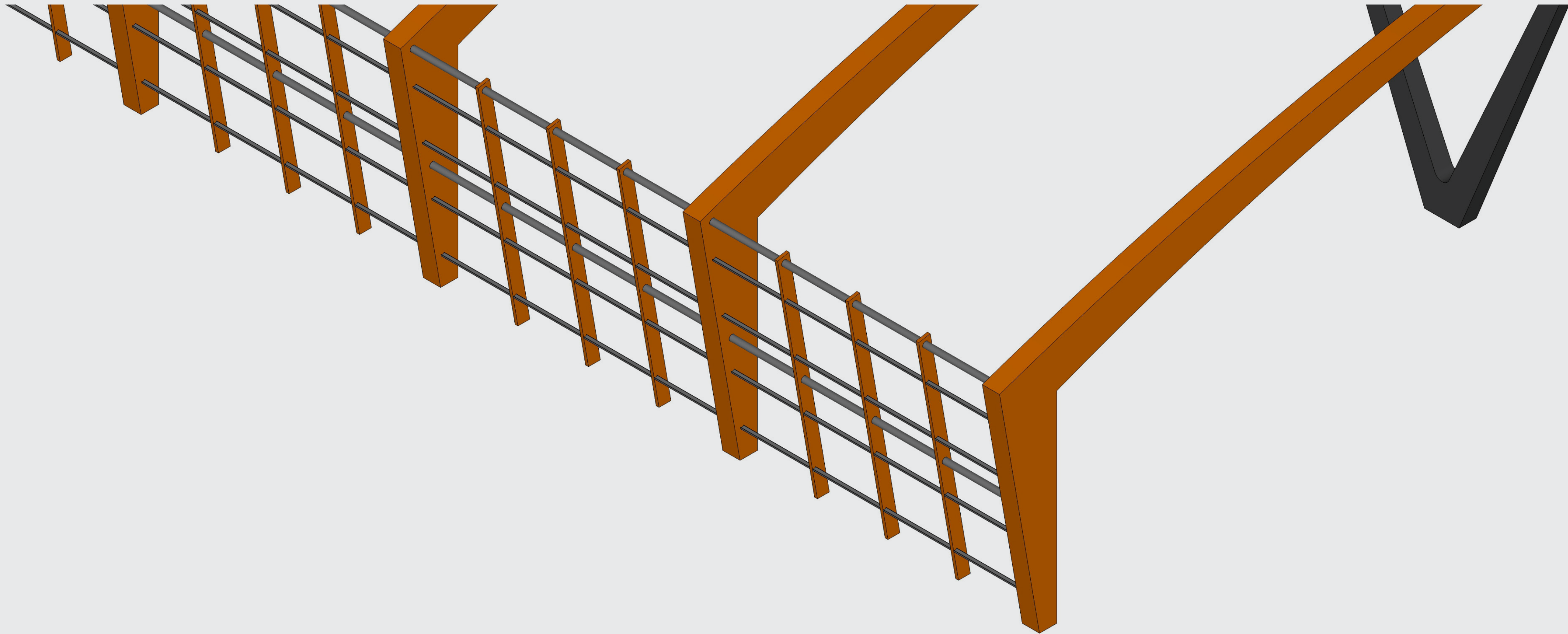

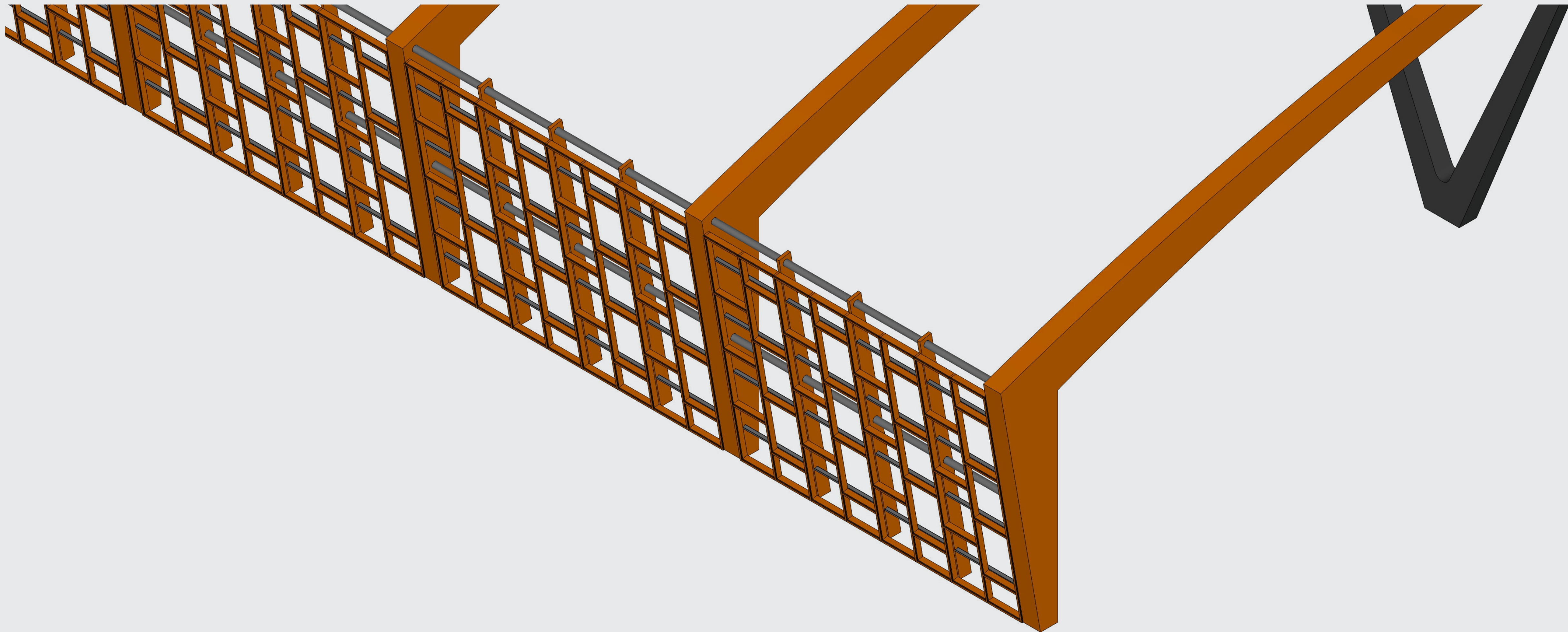

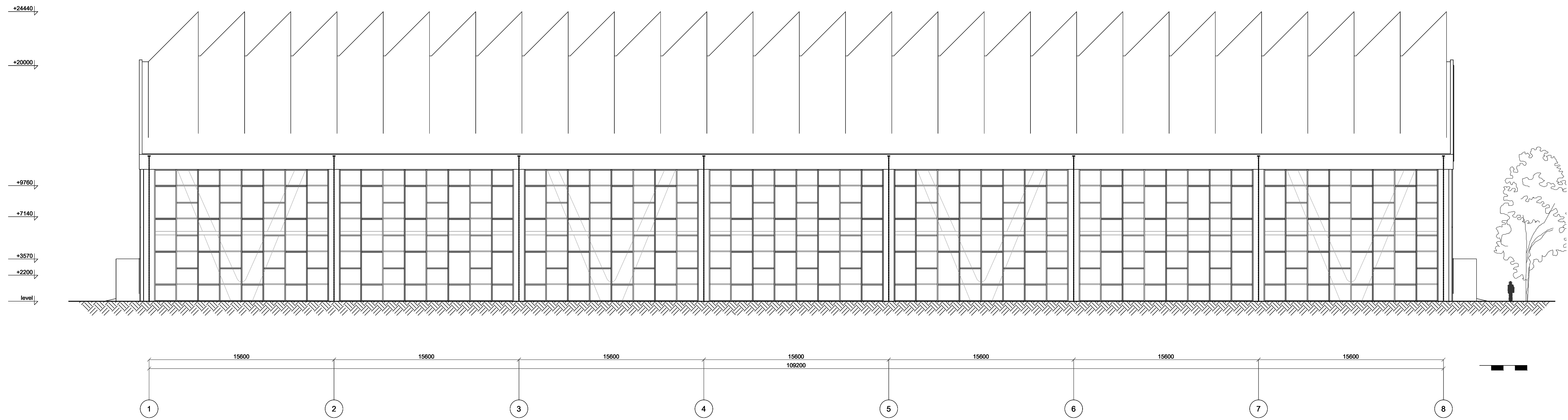

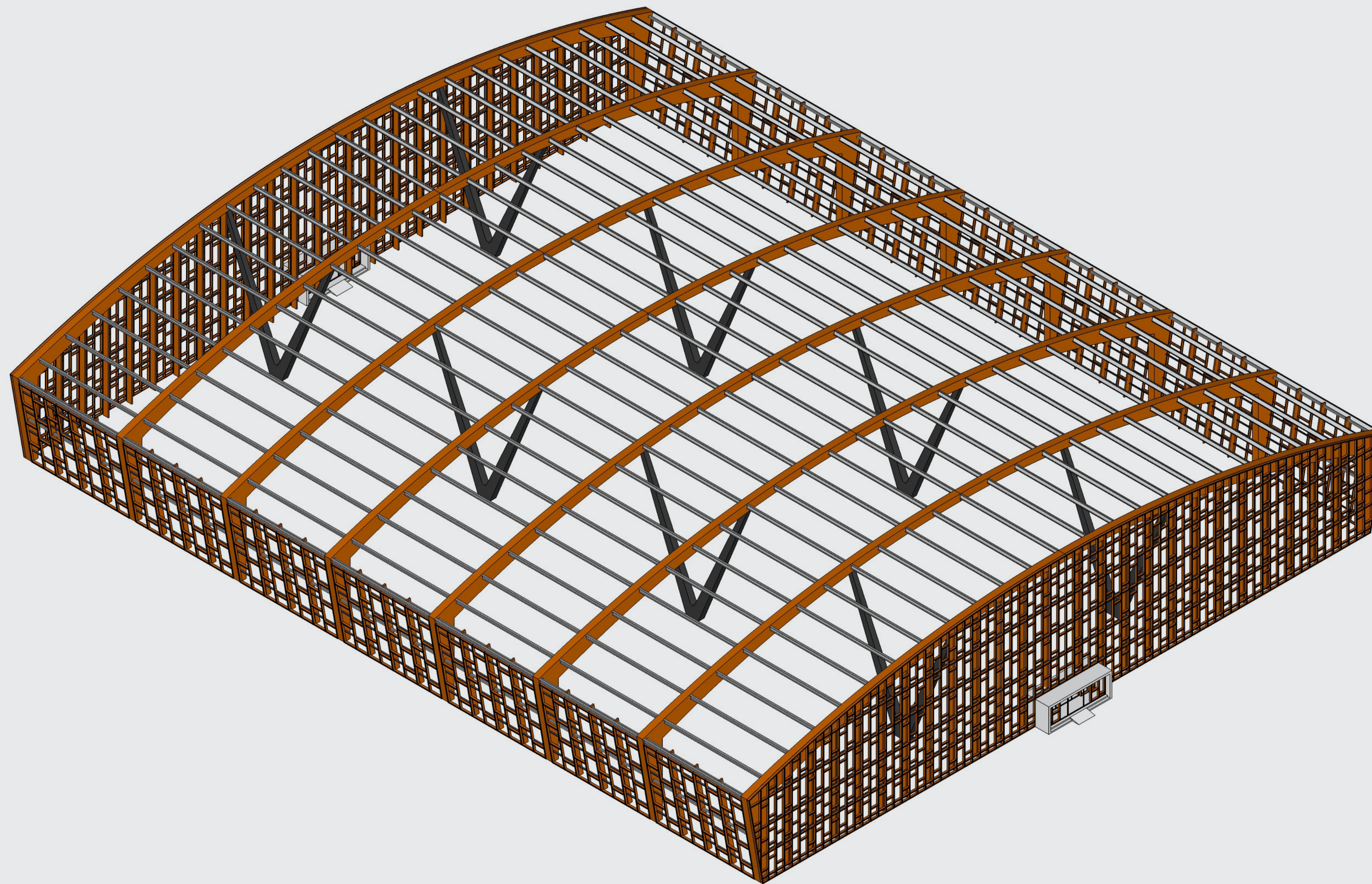

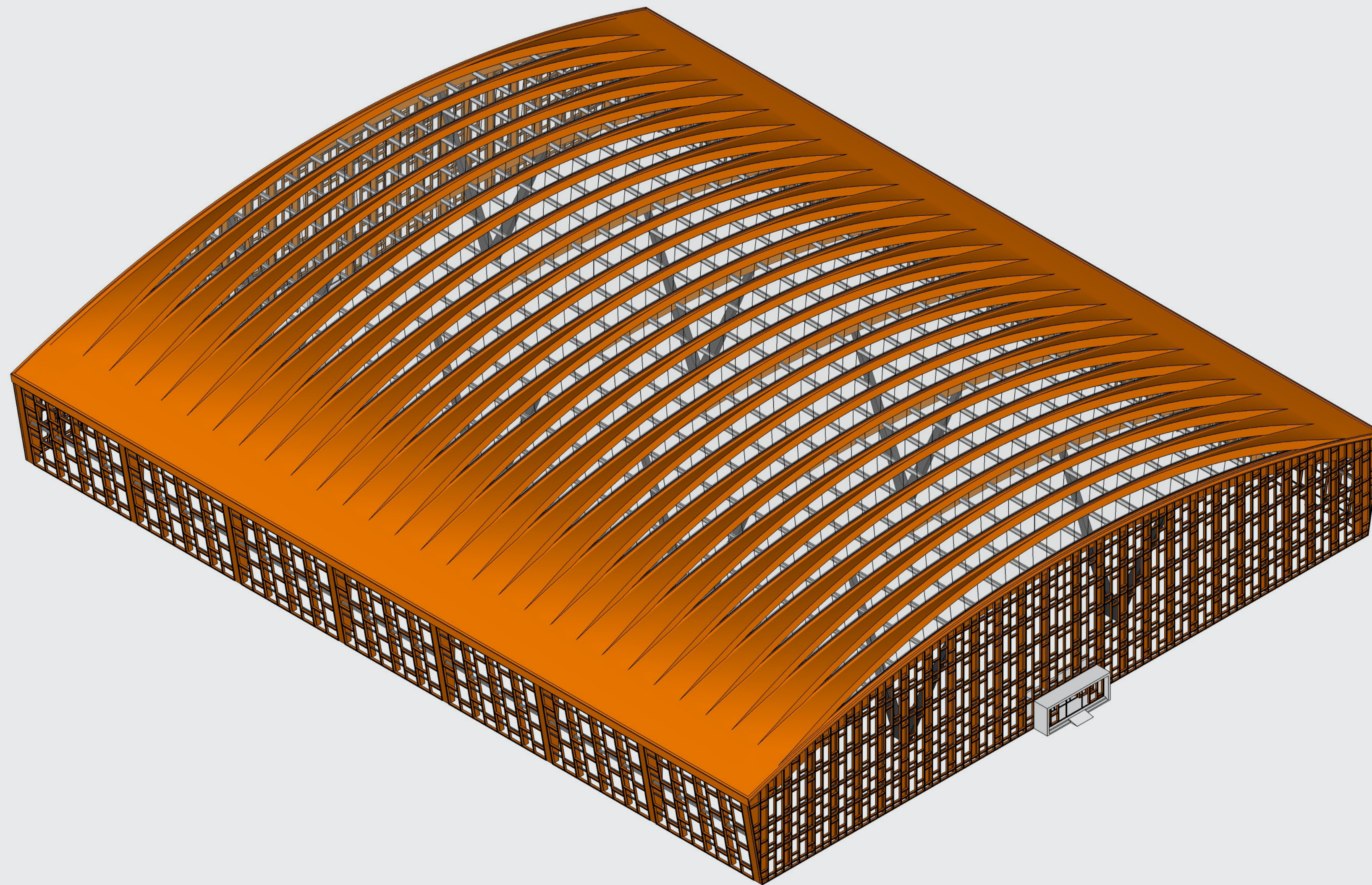

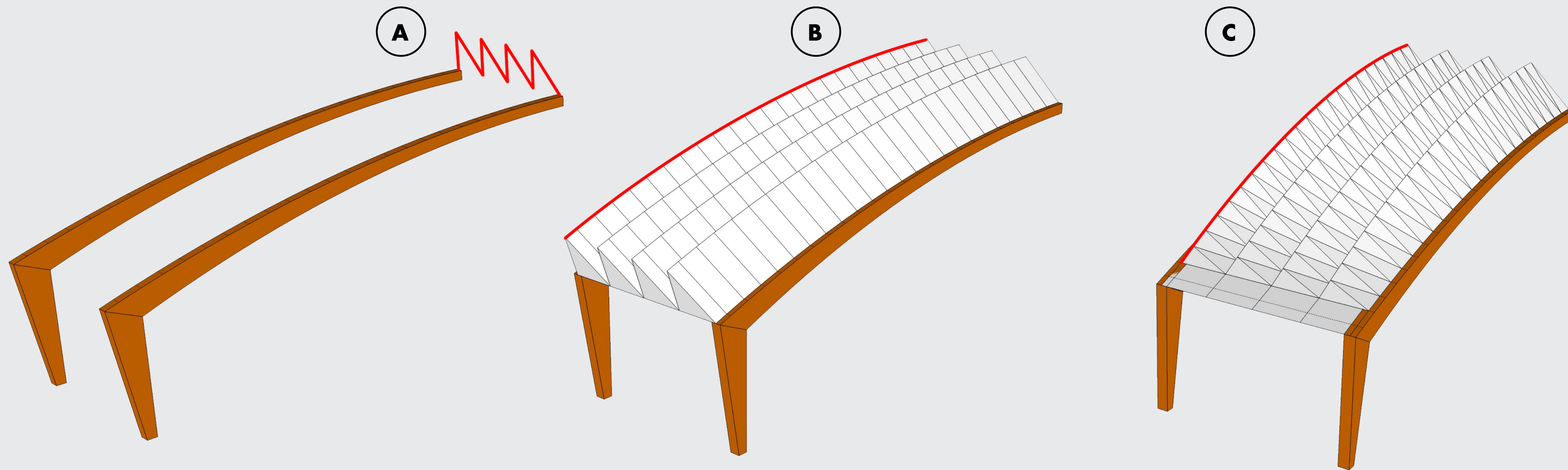

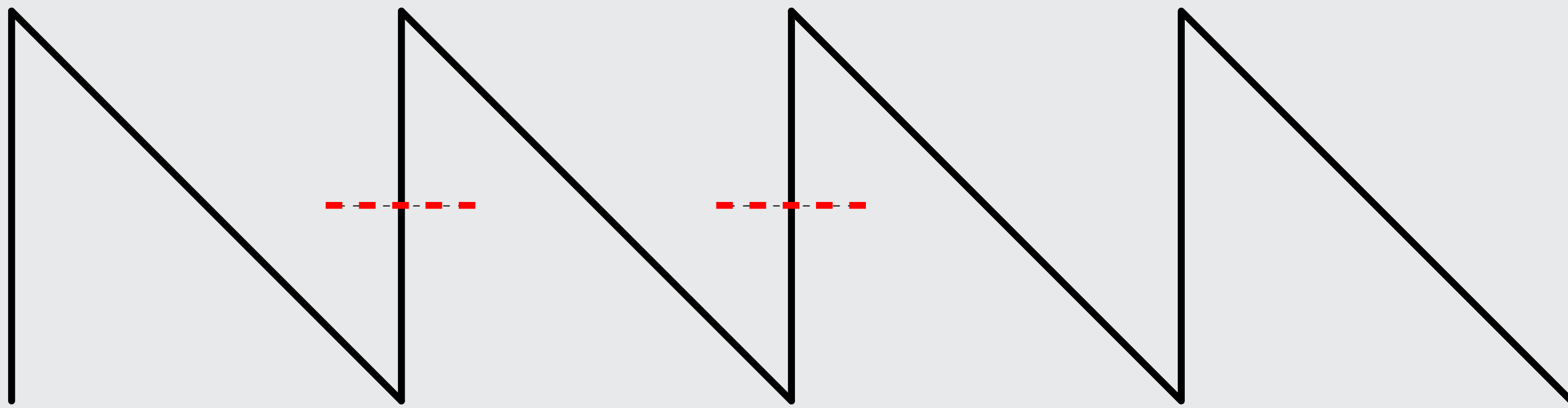



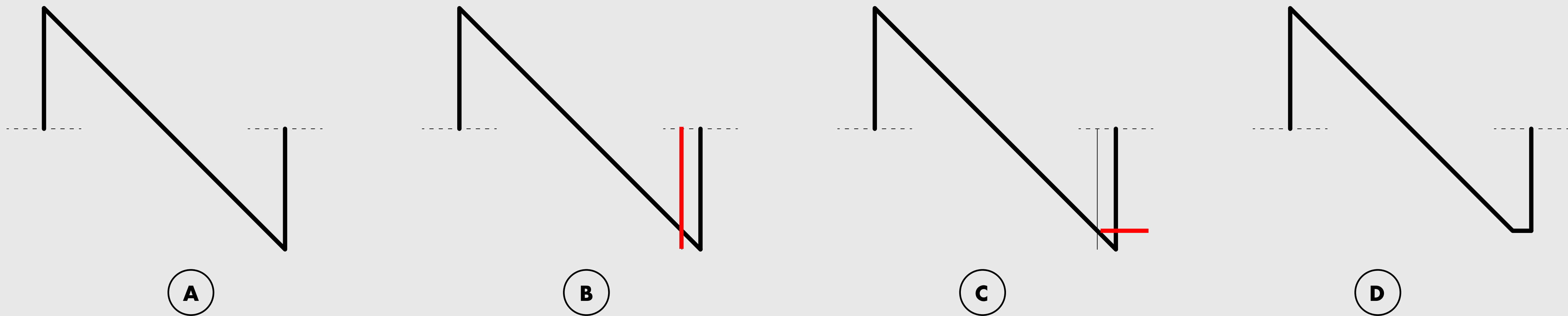

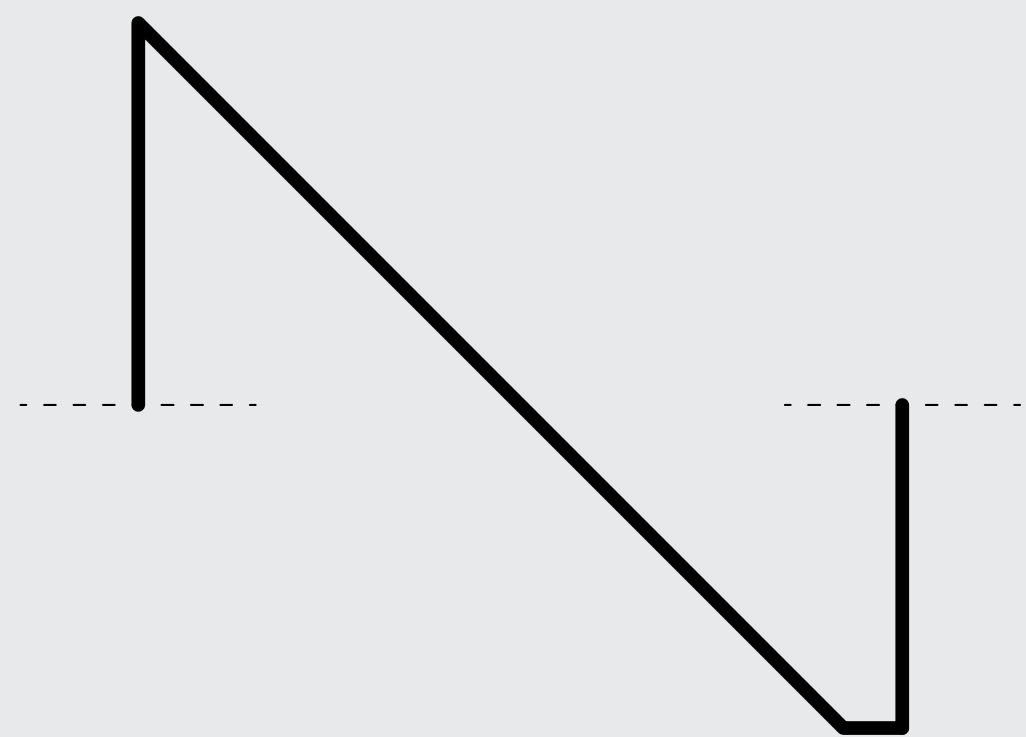

**A**

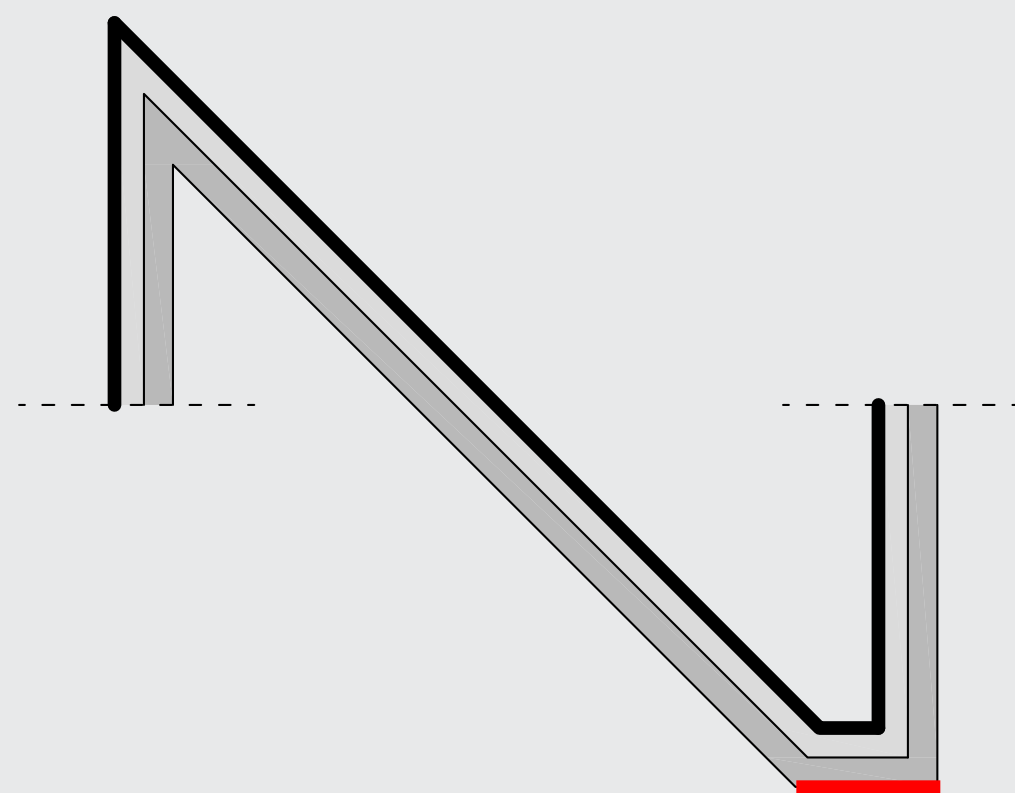

**B**

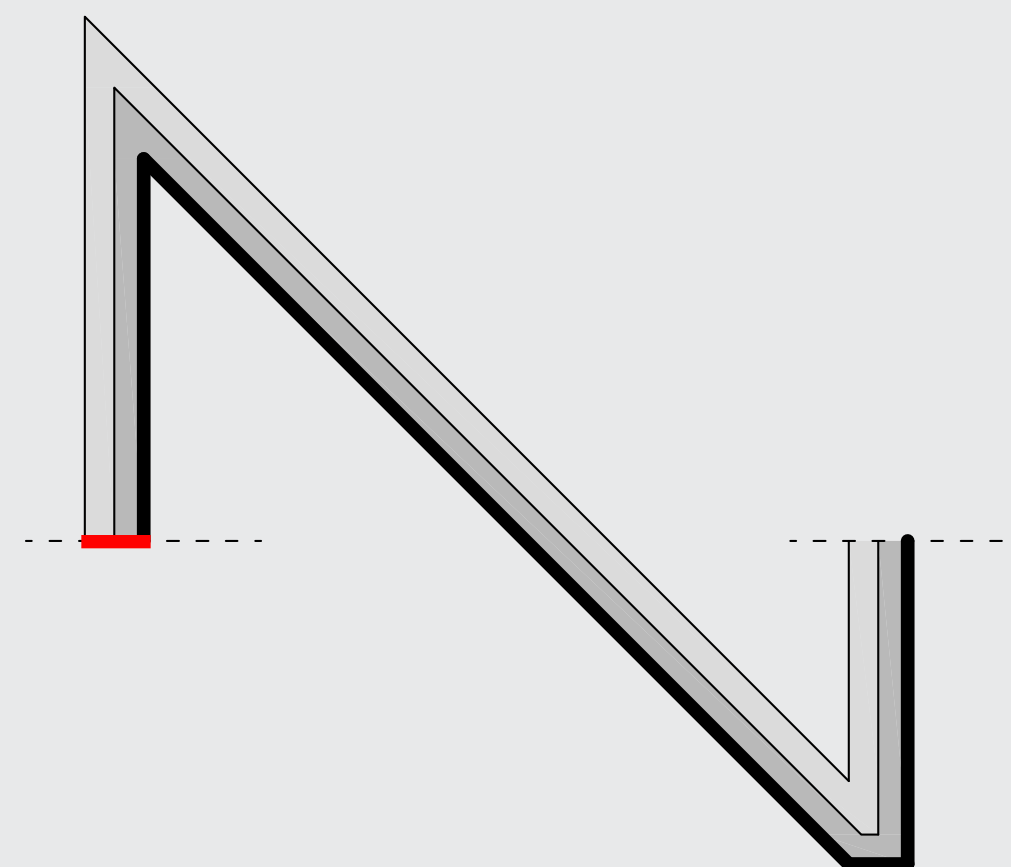

**C**

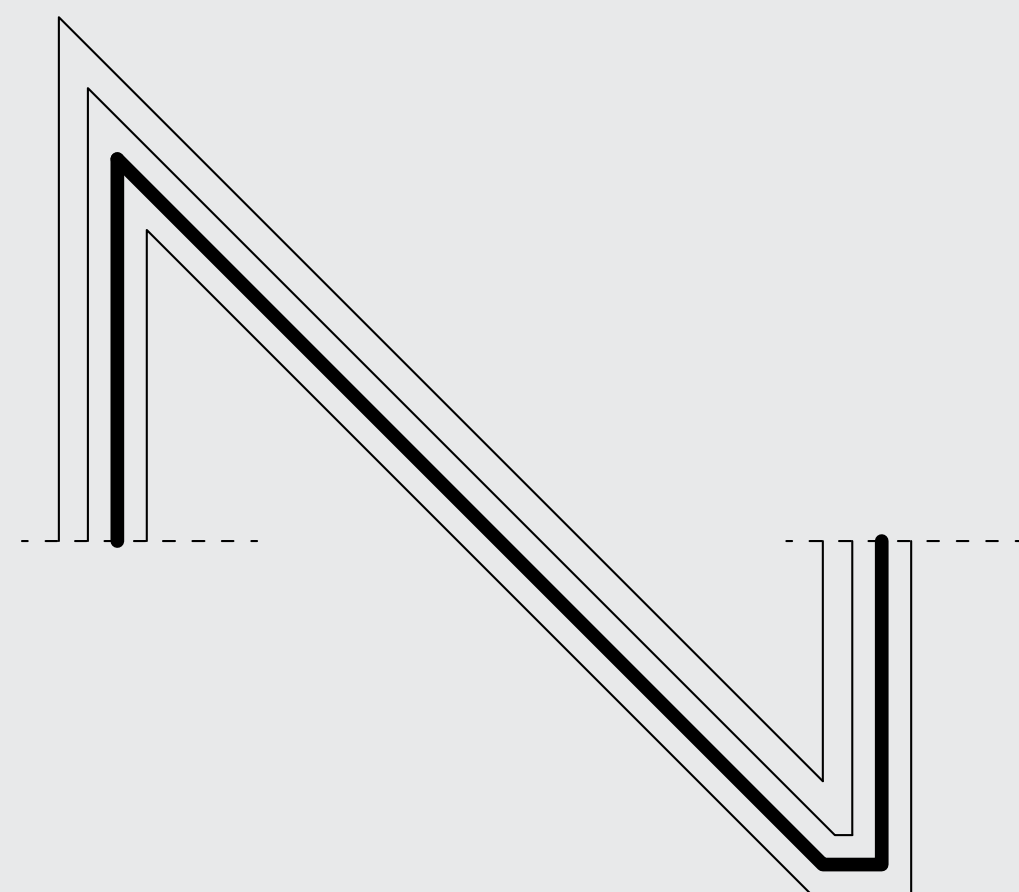

**A**

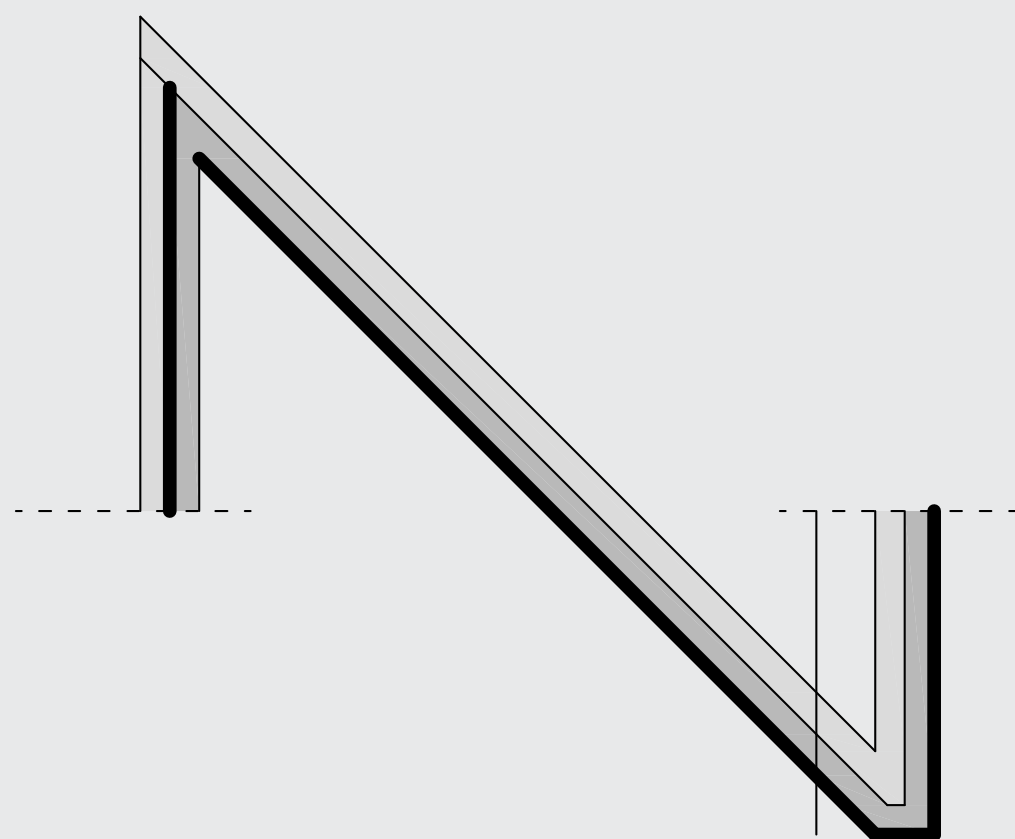

**B**

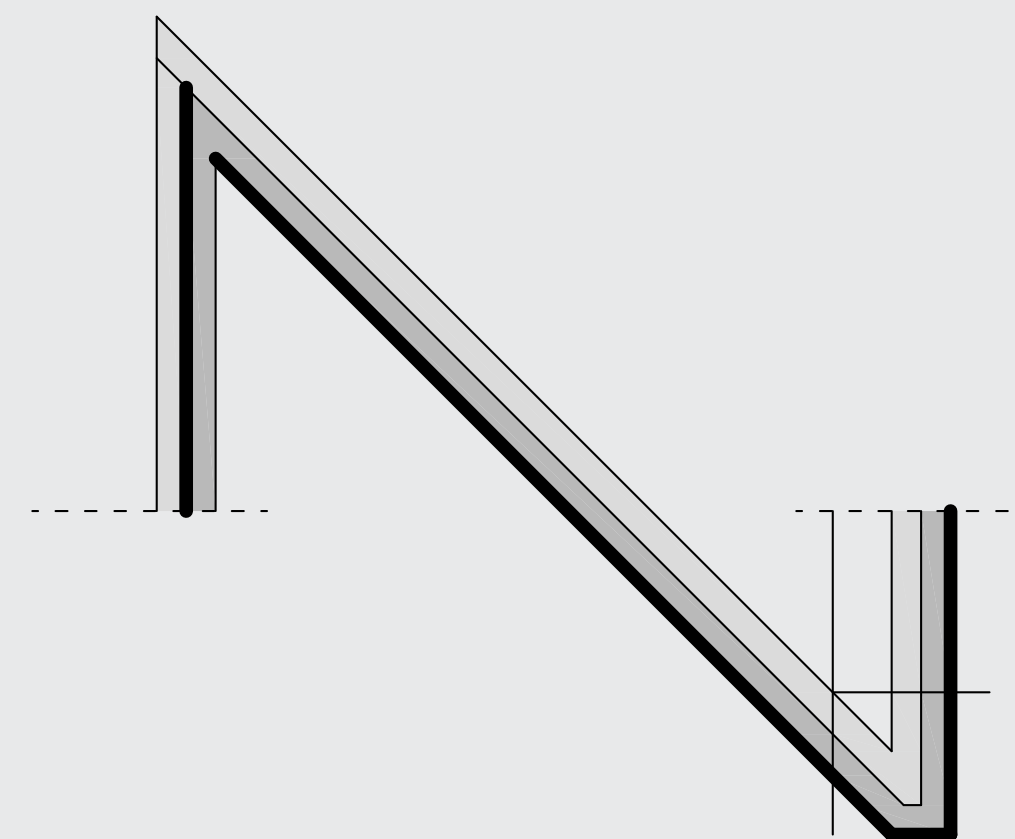

**C**

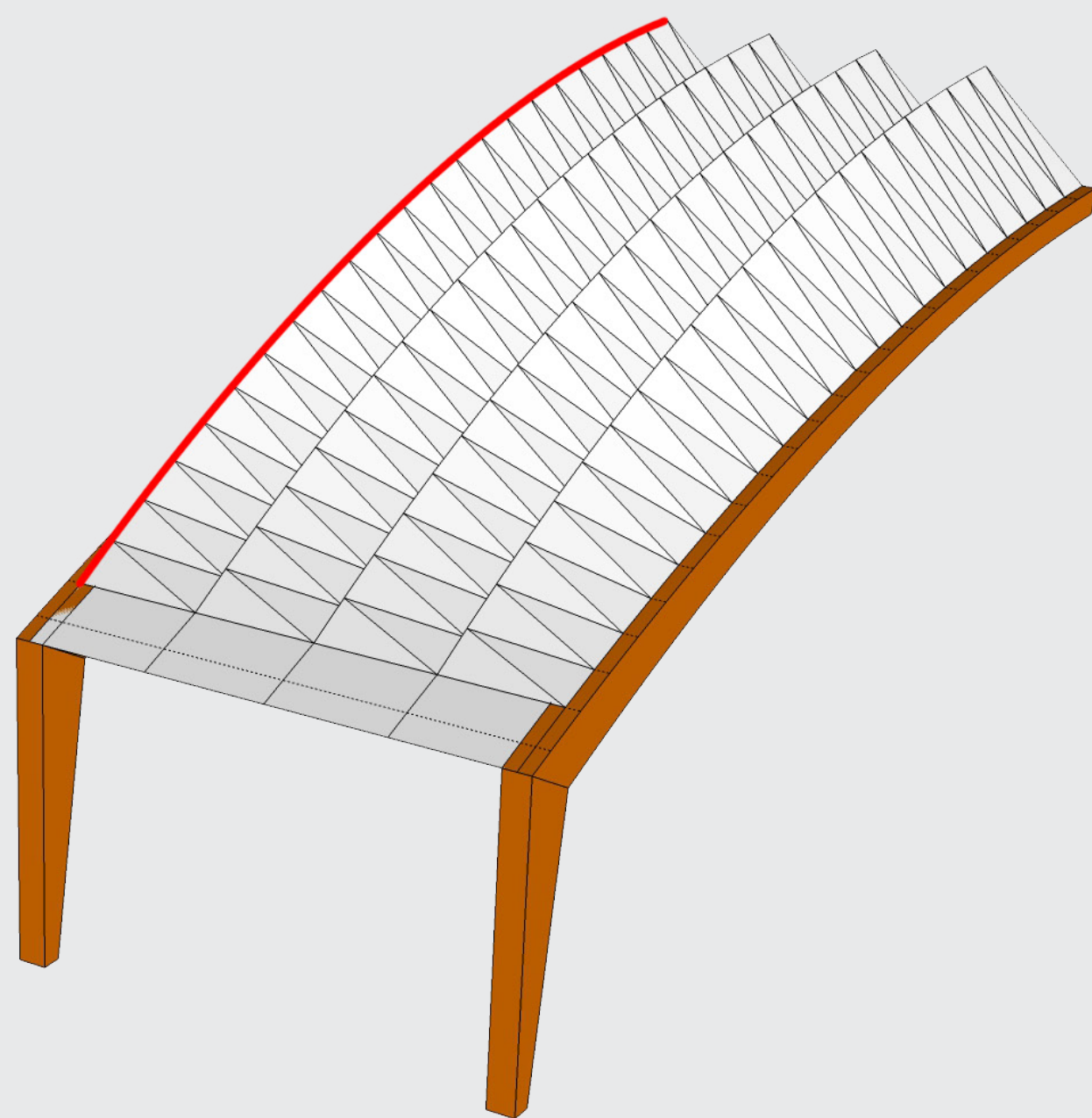

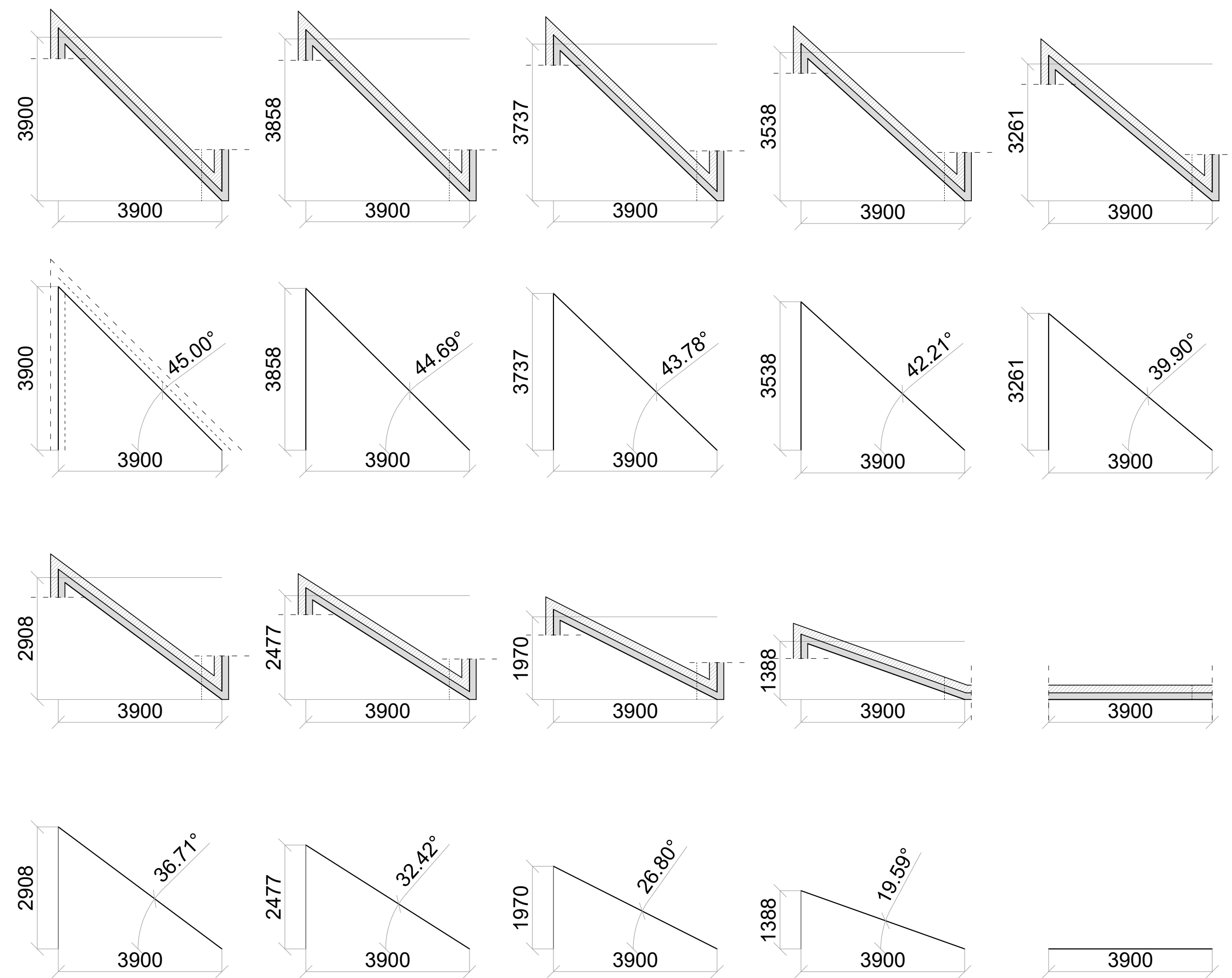

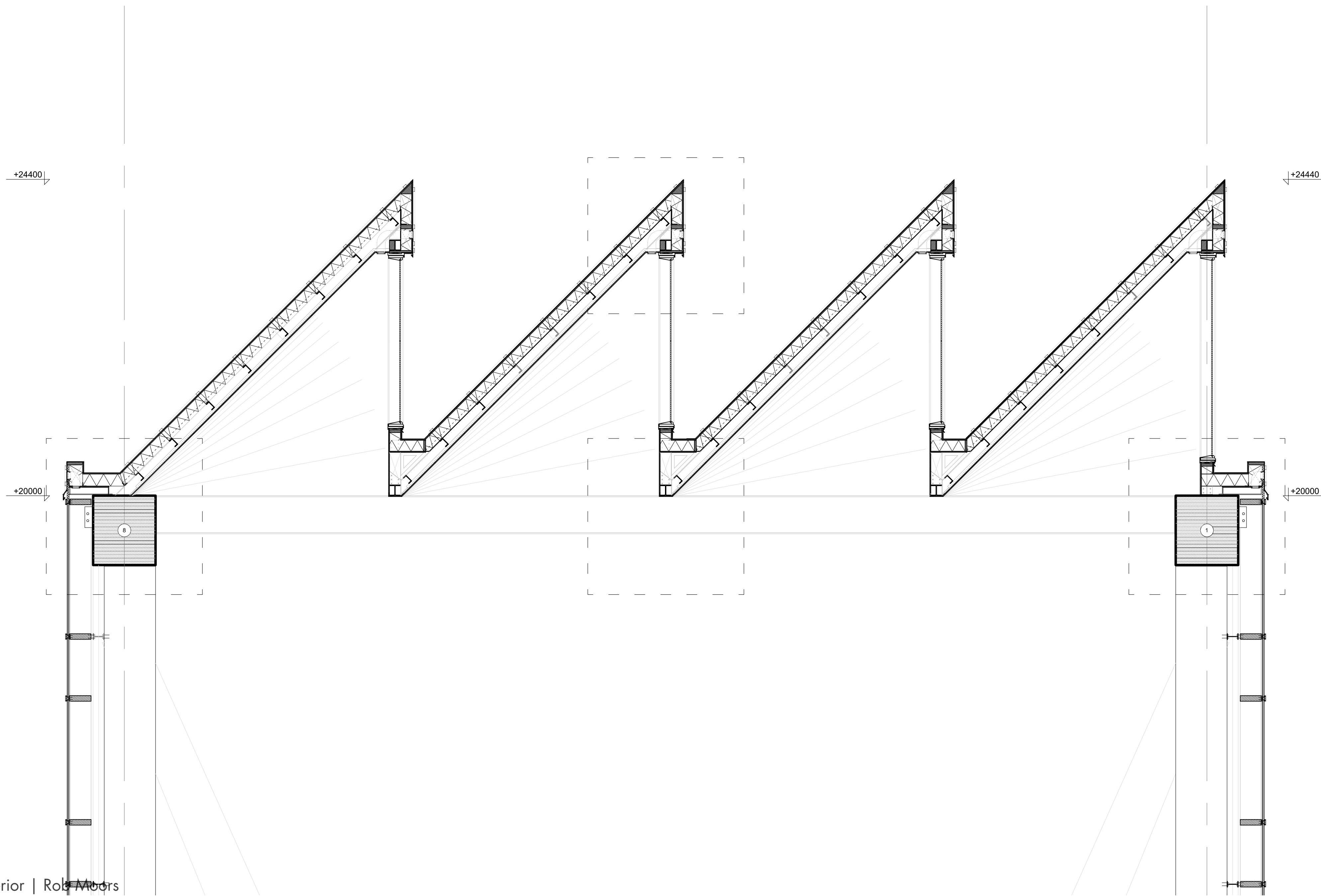

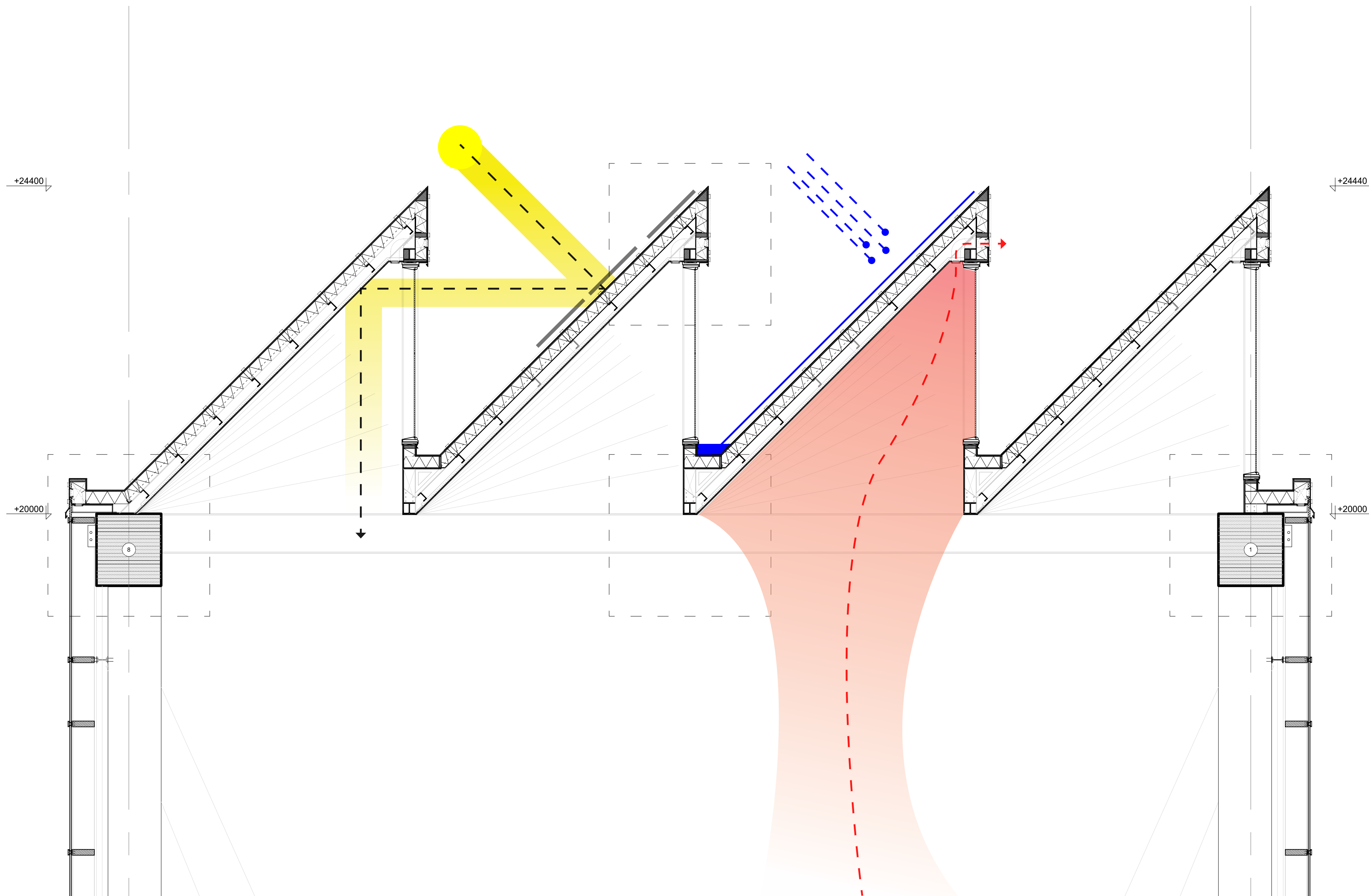

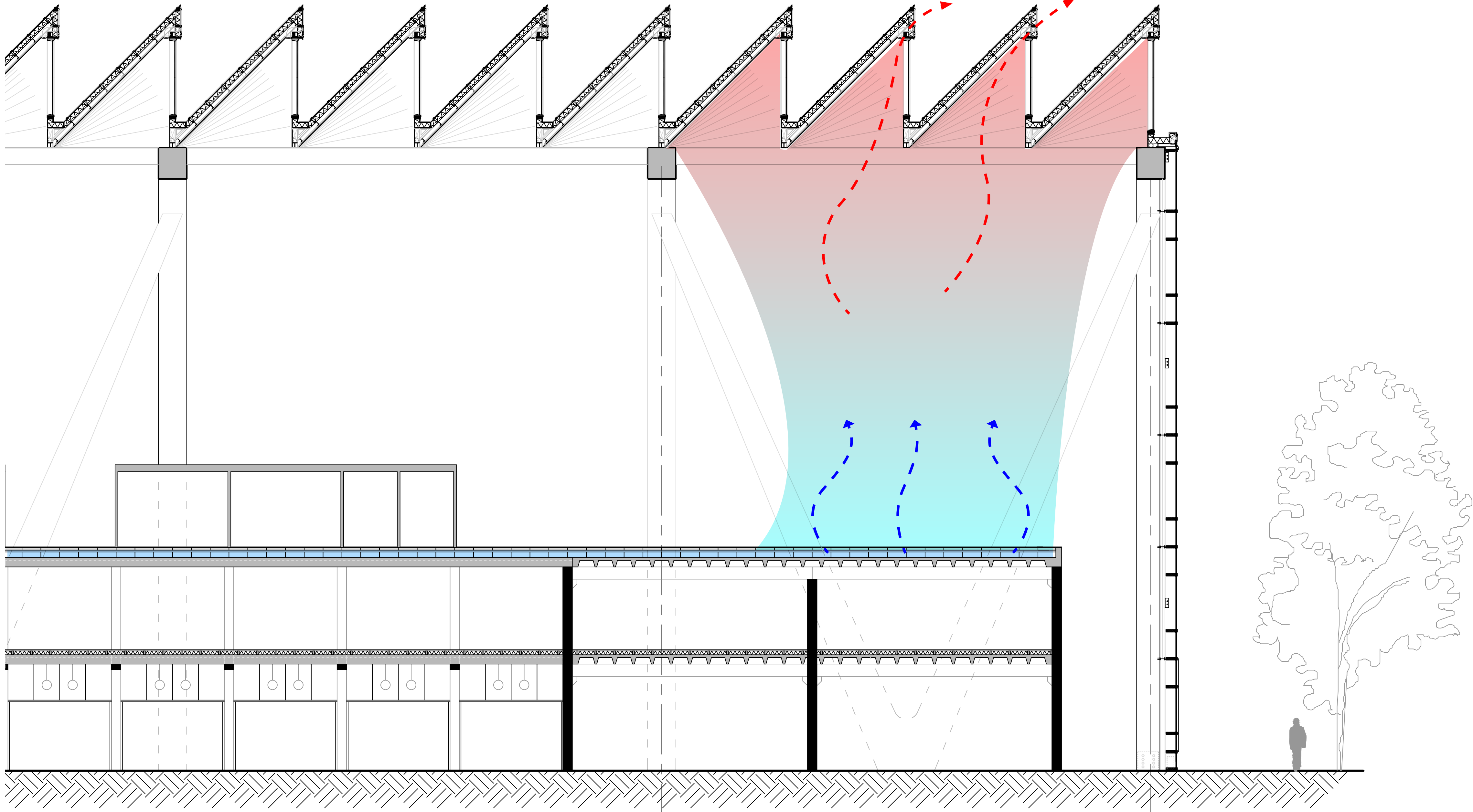



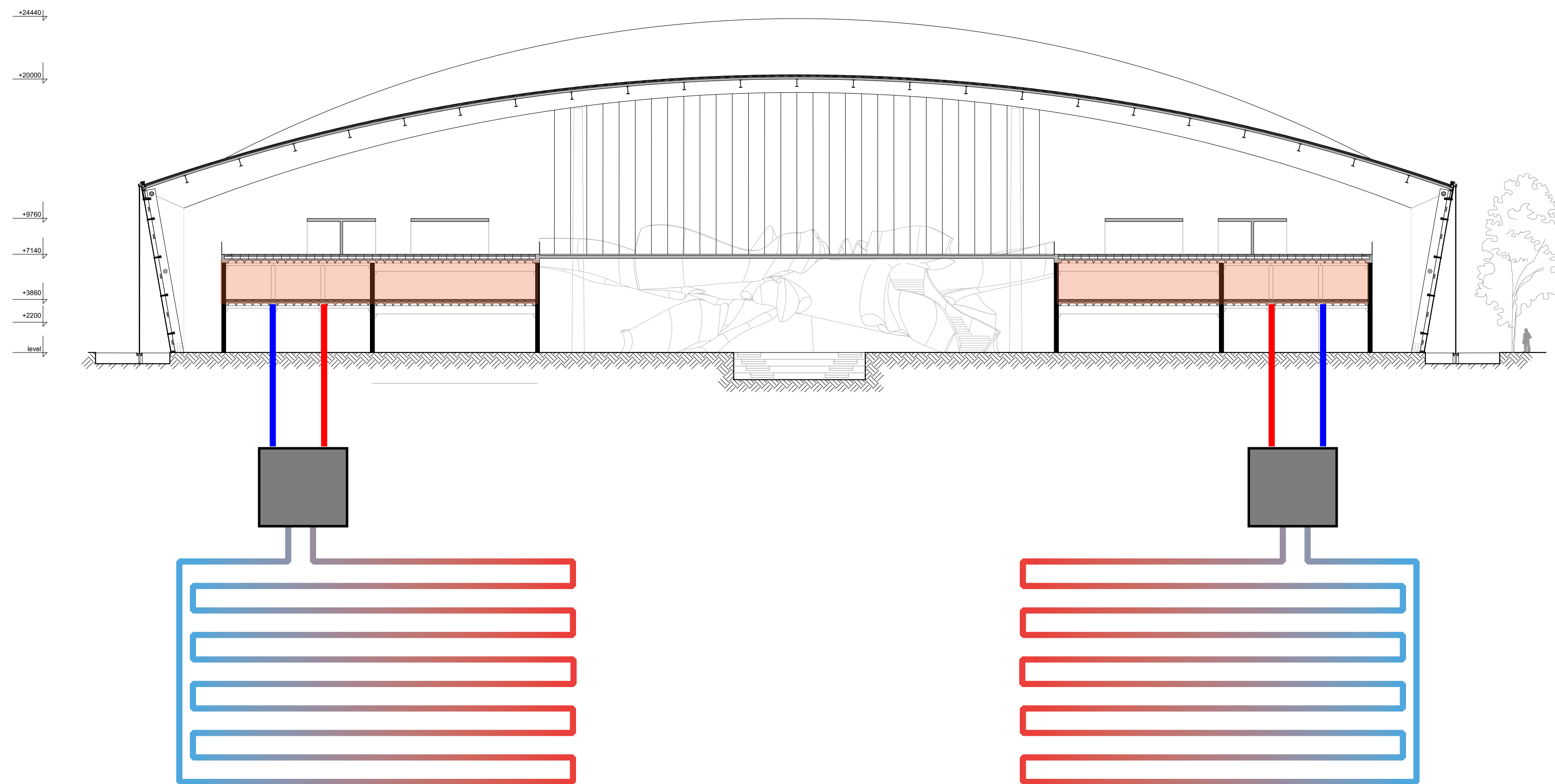

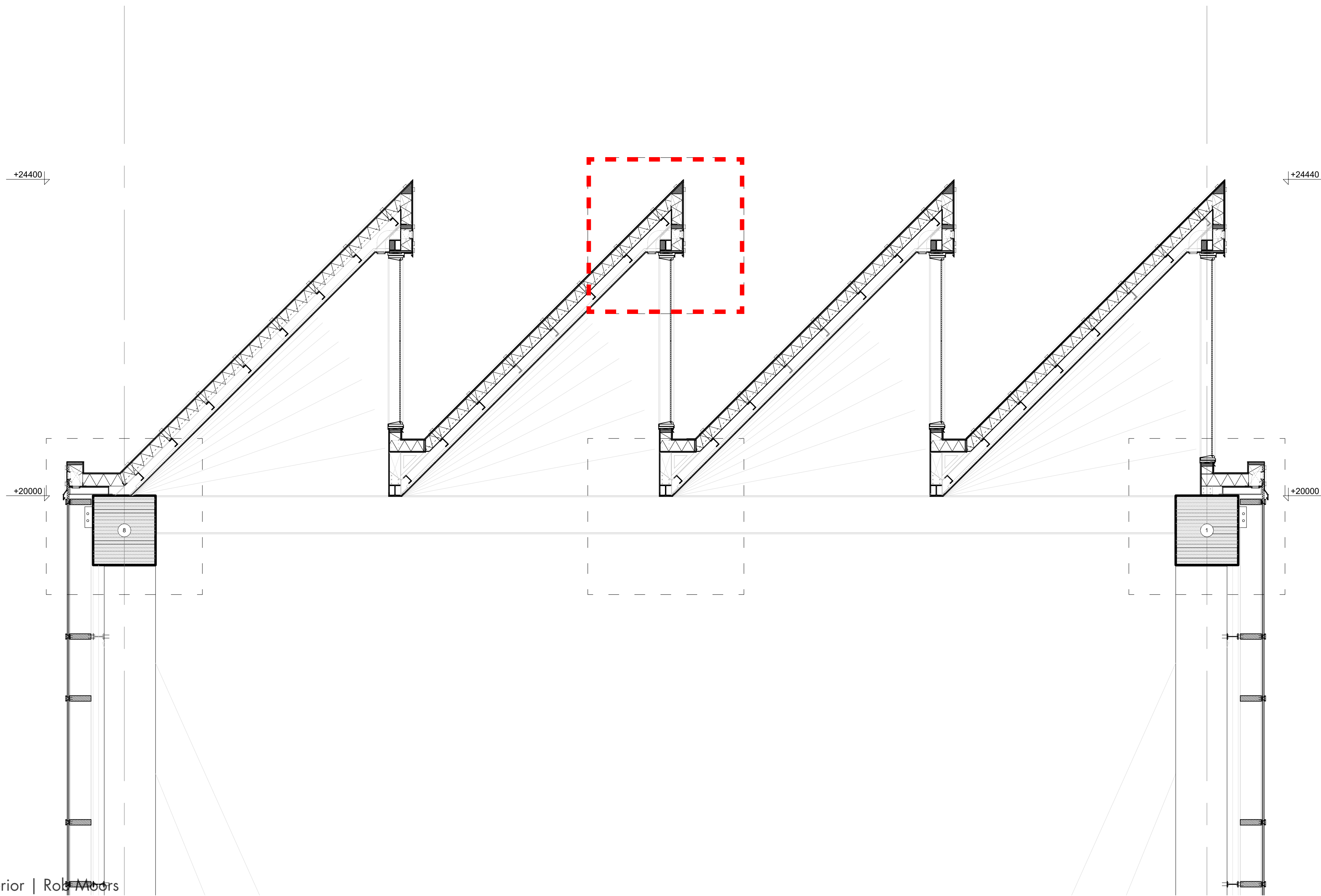

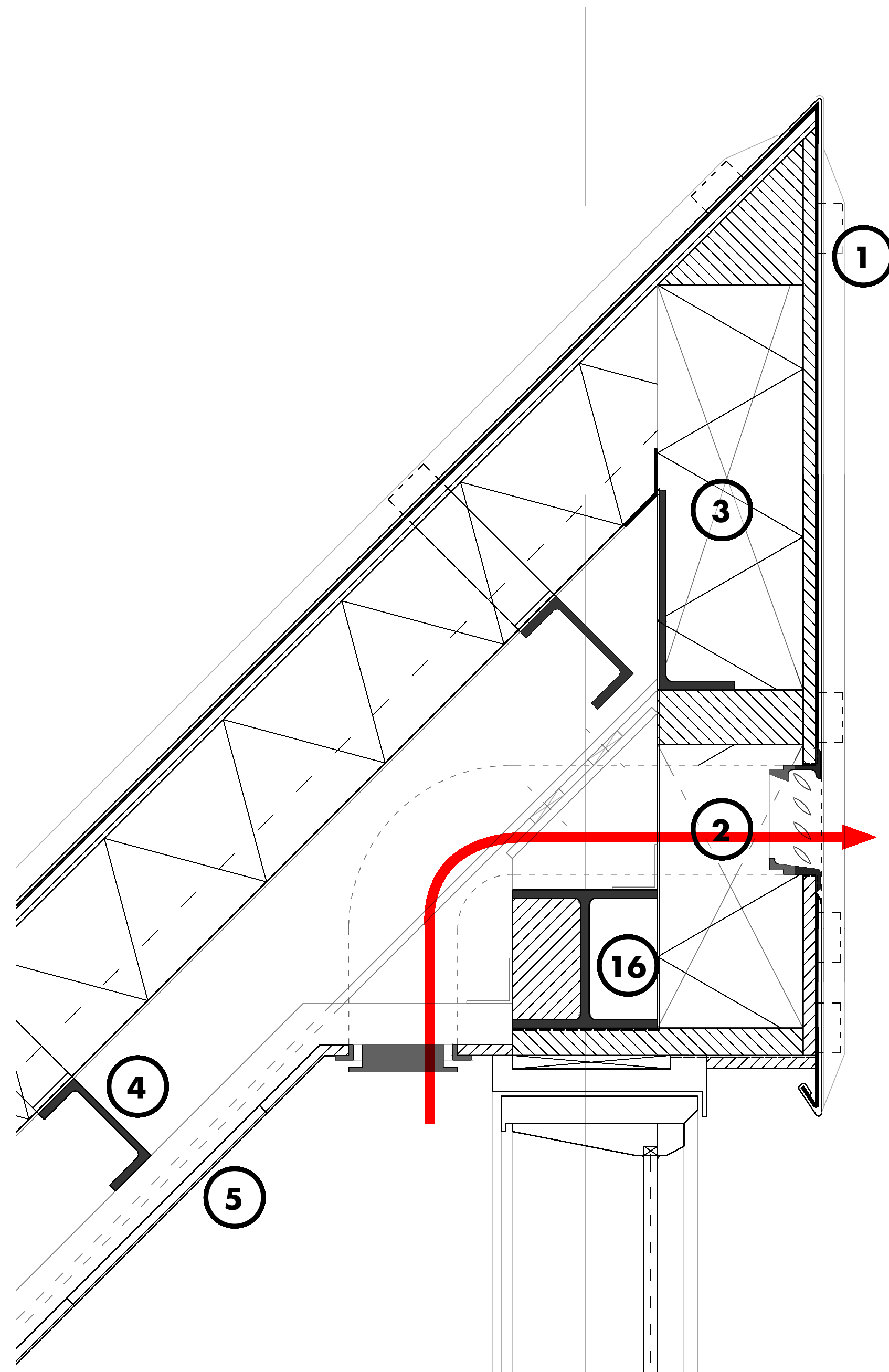

- 1.** Copper Cladding
- 2.** Ventilation Shaft
- 3.** Insulation 174mm
- 4.** UNP 120
- 5.** Fibre Reinforced Polymer Mesh
- 16.** HEA 150



Breda, Netherlands | Poppodium MeZZ | EEA | 2002



Bainbridge Island, WA, United States | Eagle Harbor Market Building | Coates Design Architects | 2010



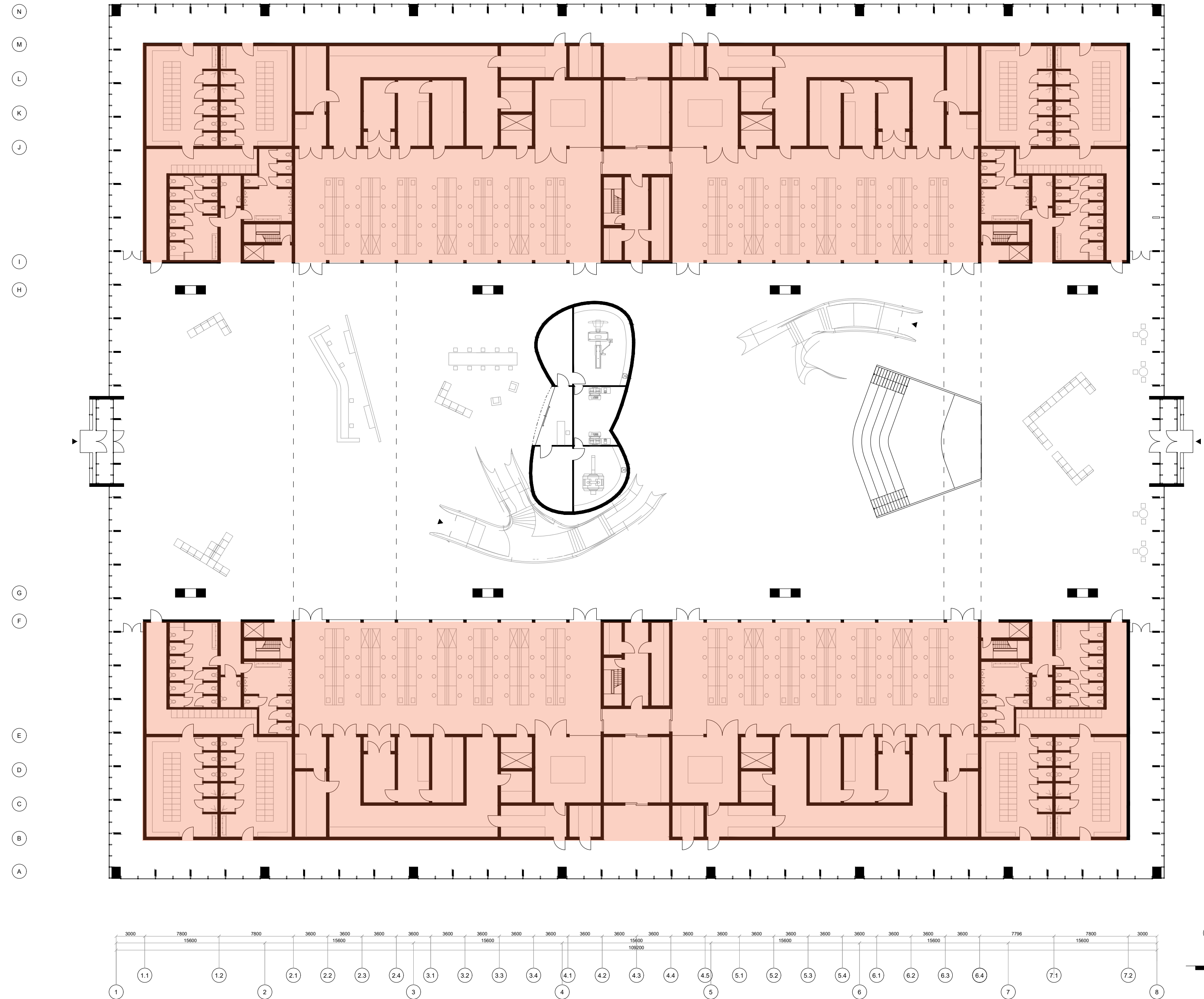

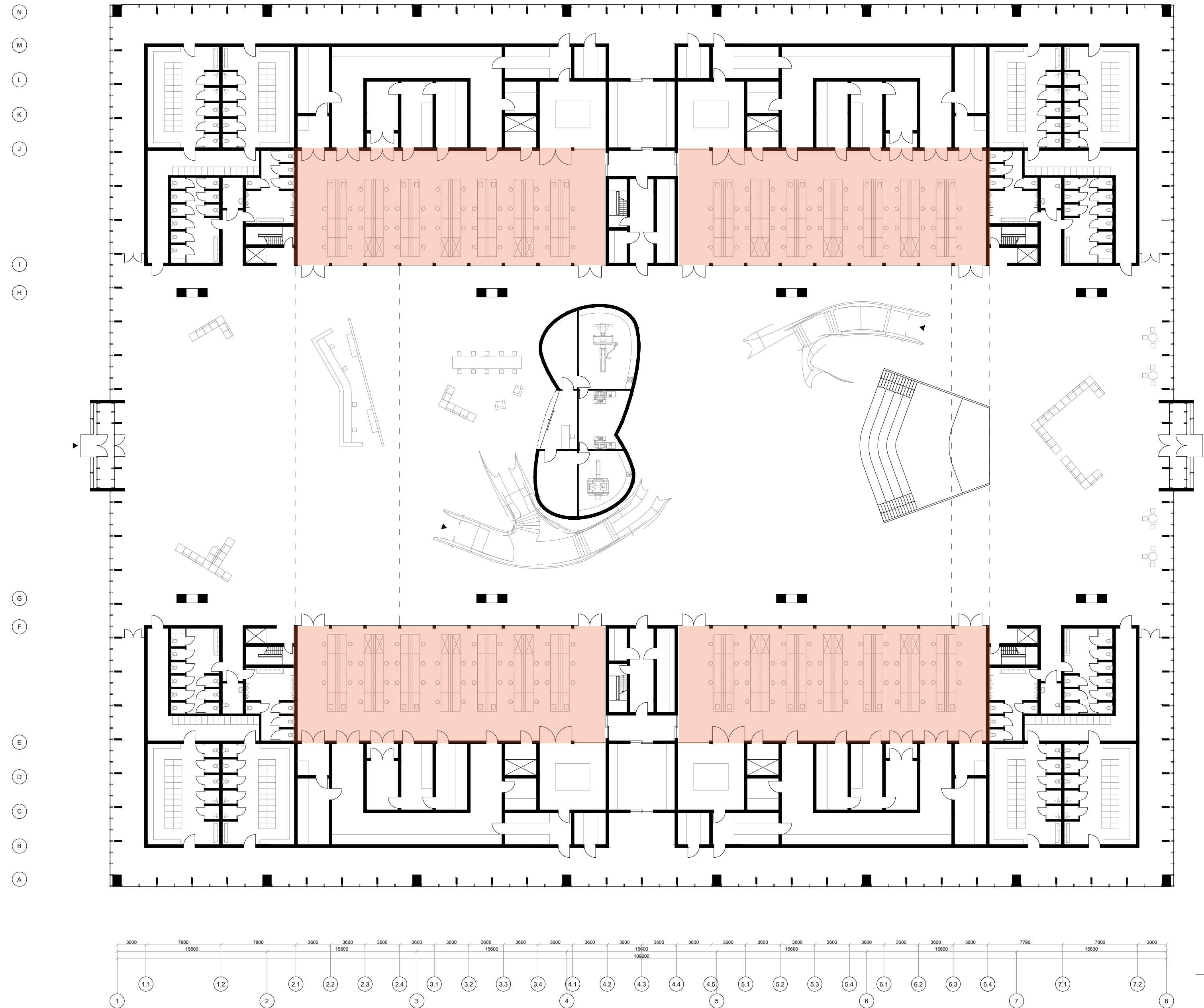

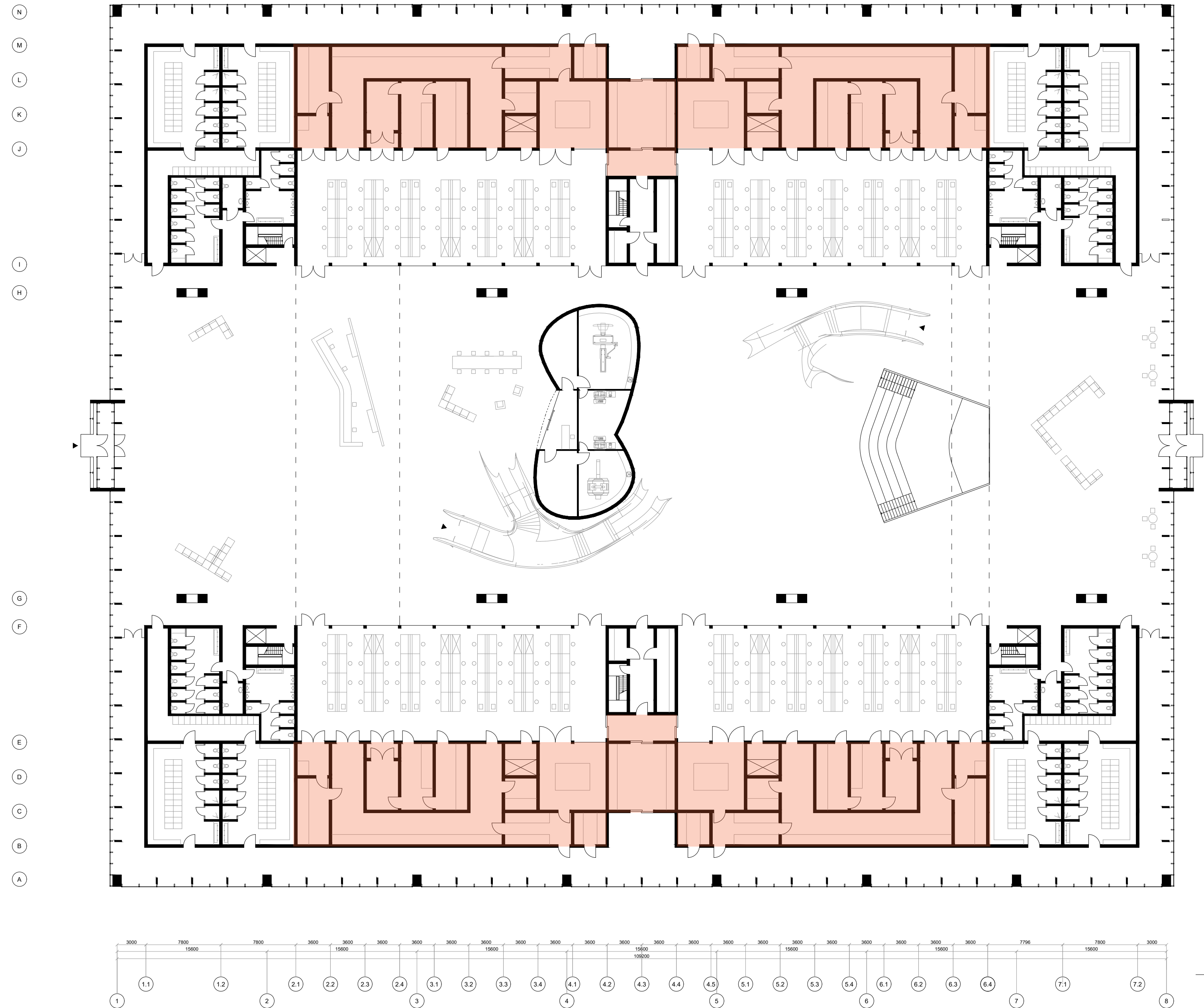



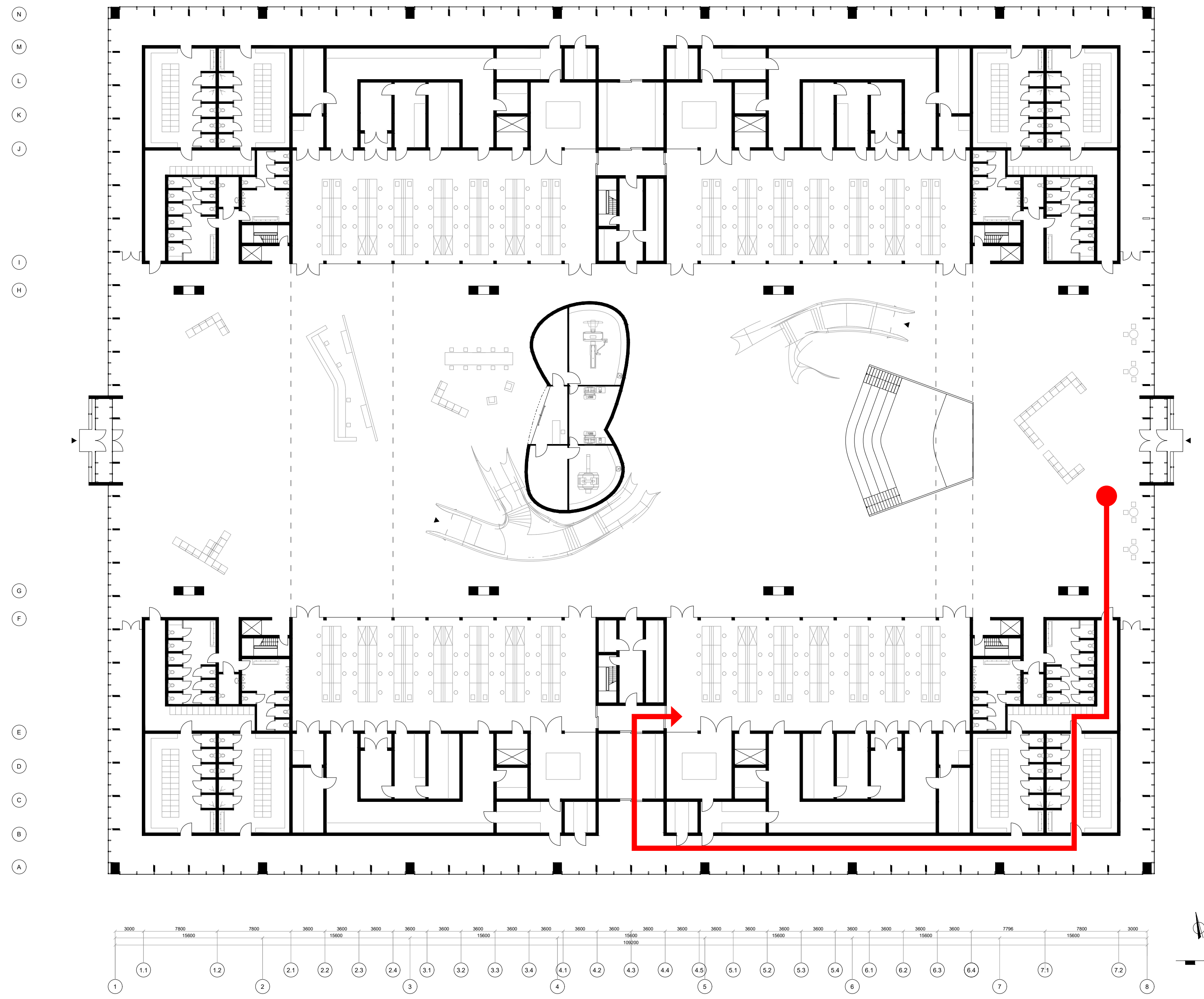

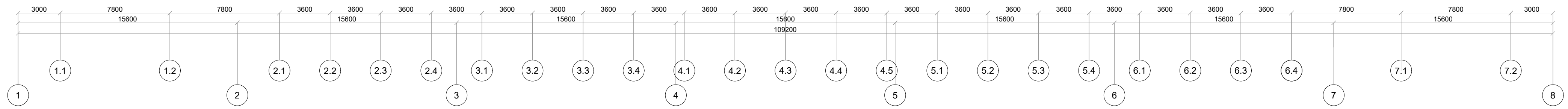
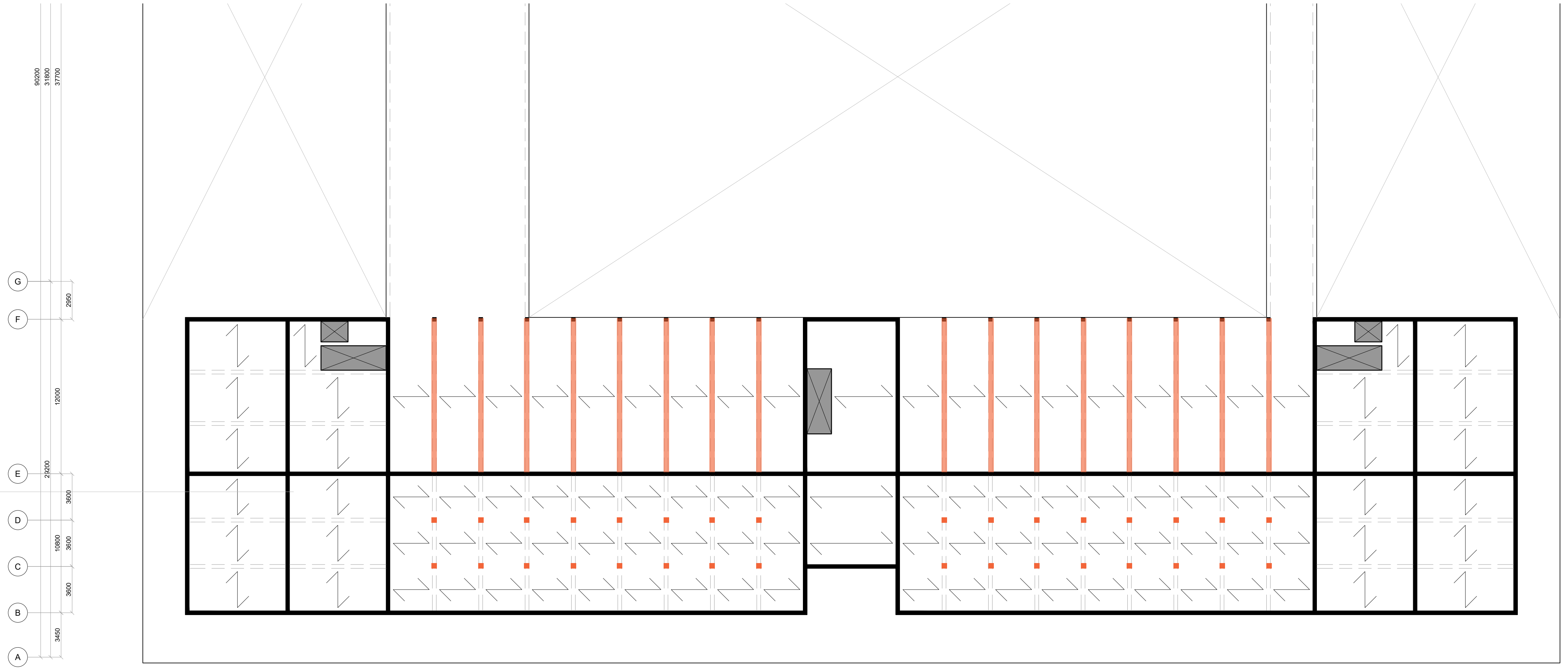

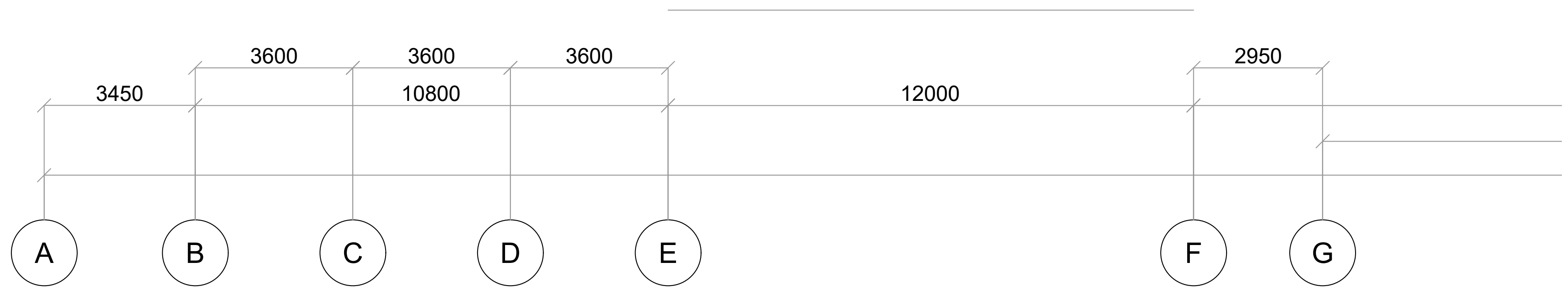
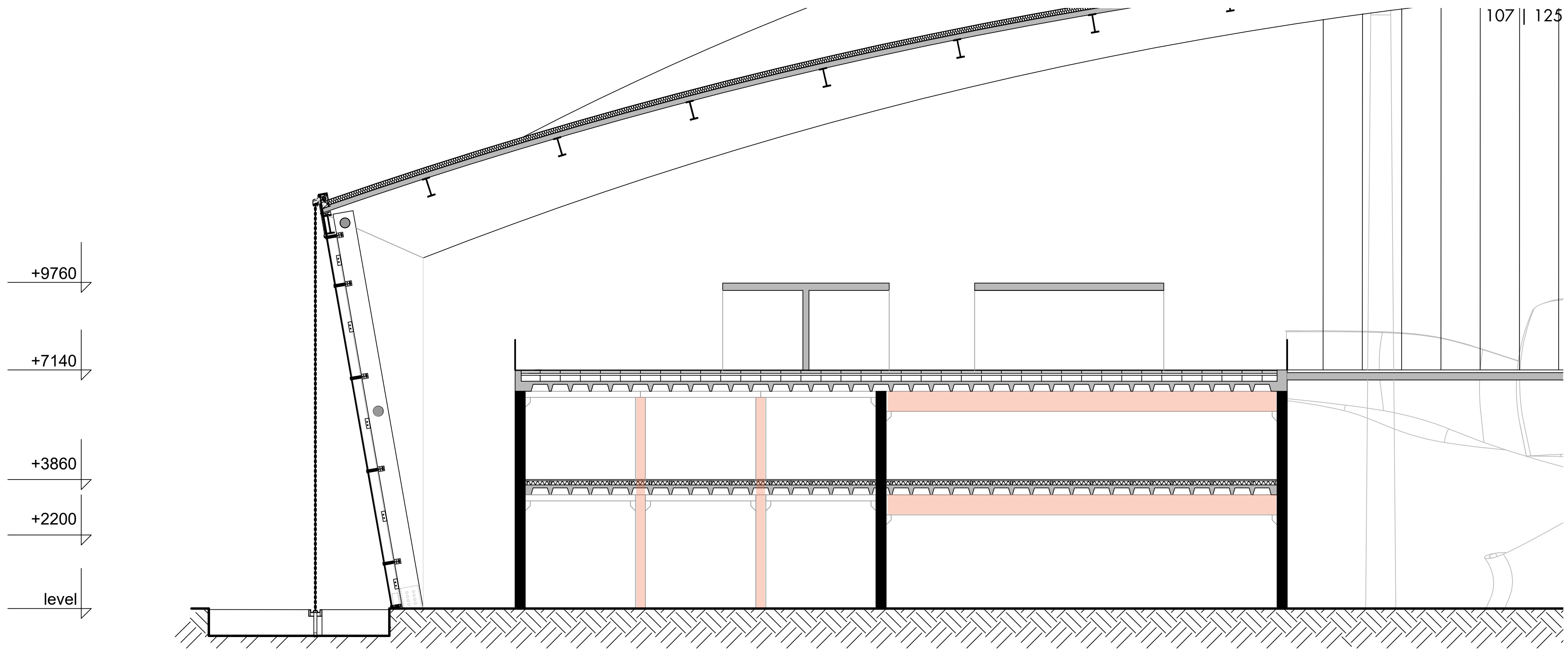

107 | 125

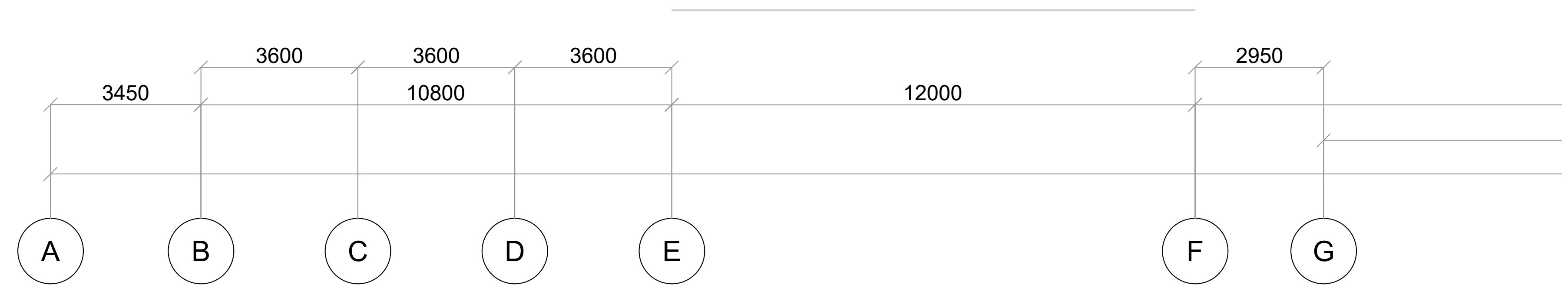
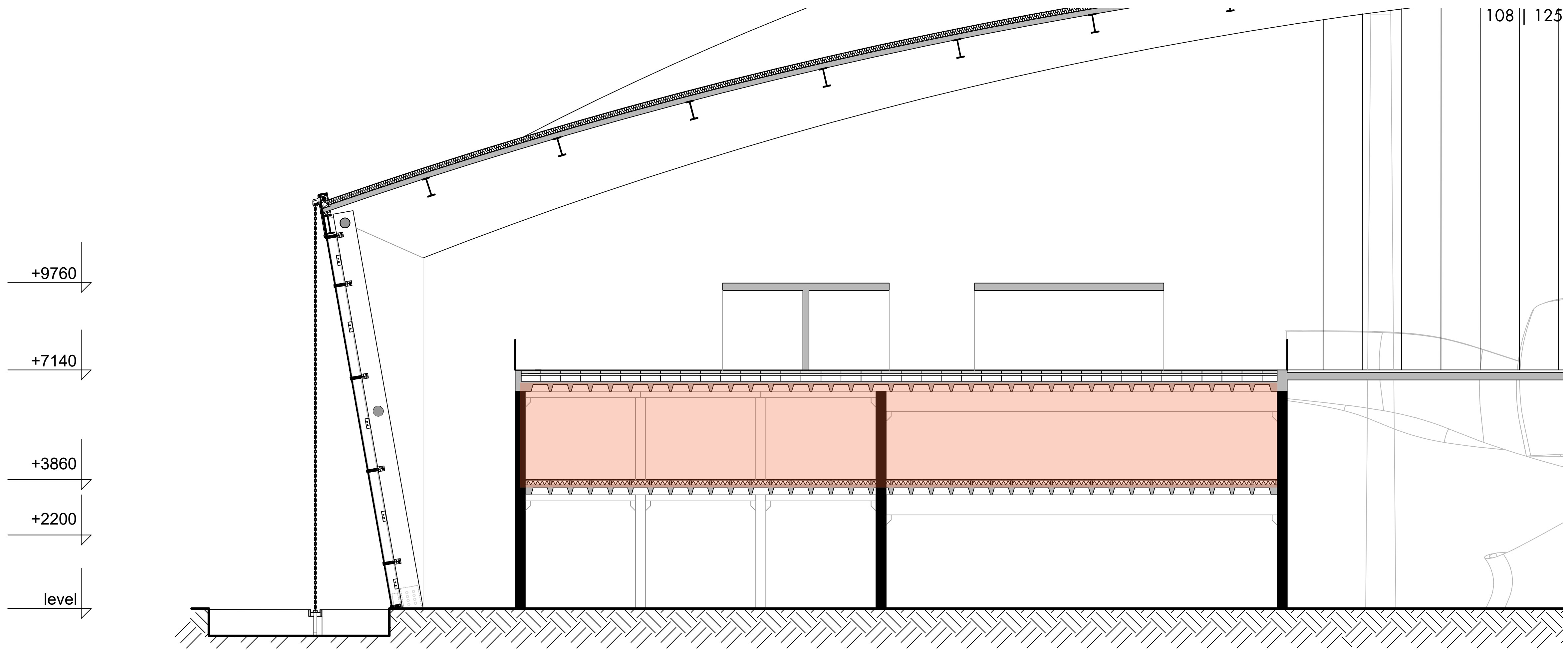

108 | 125

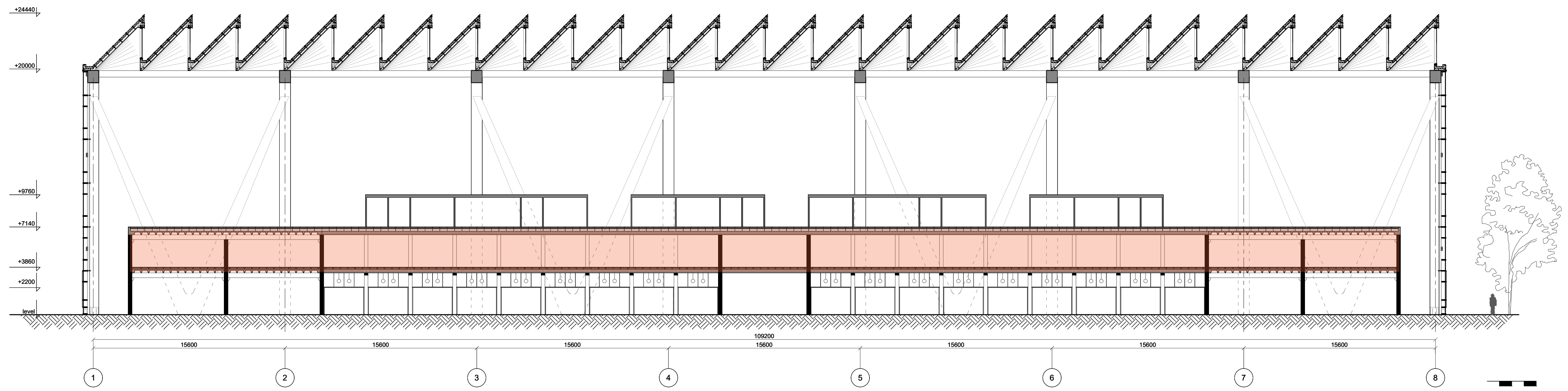

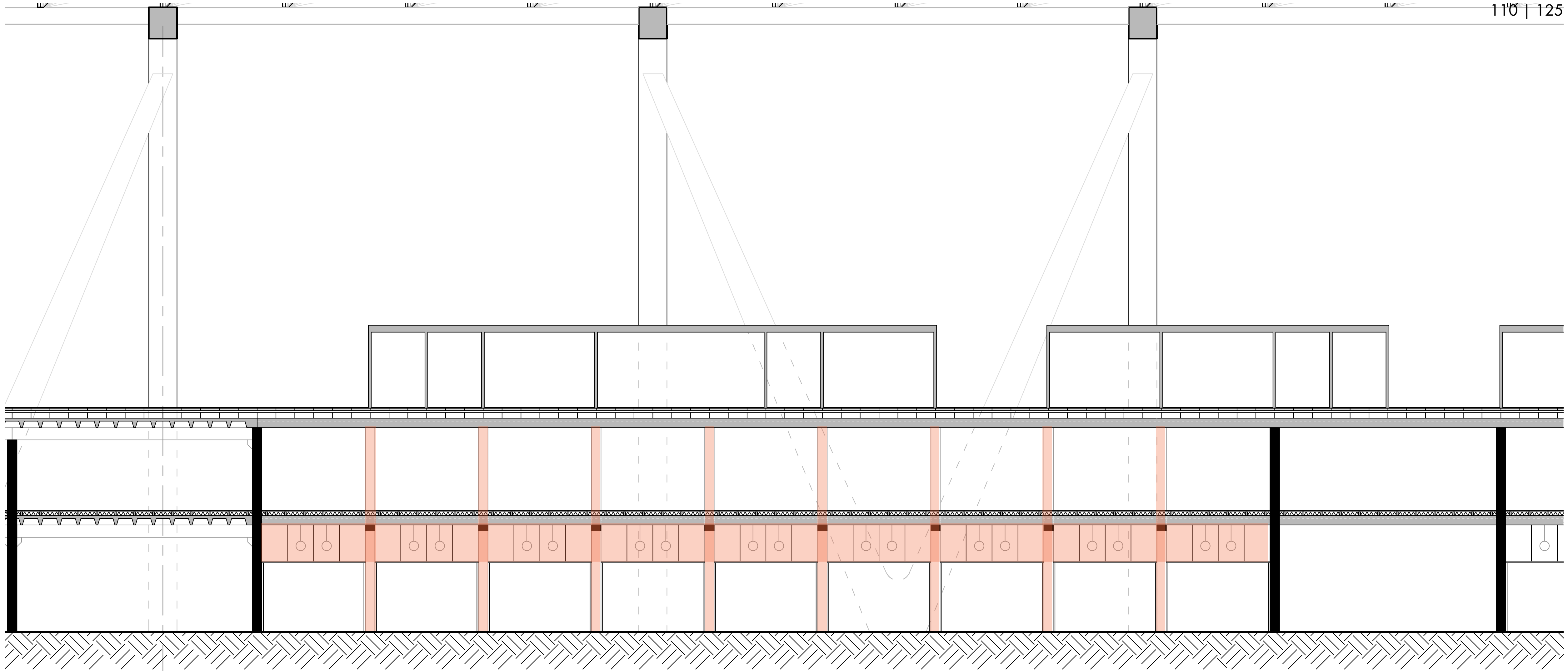

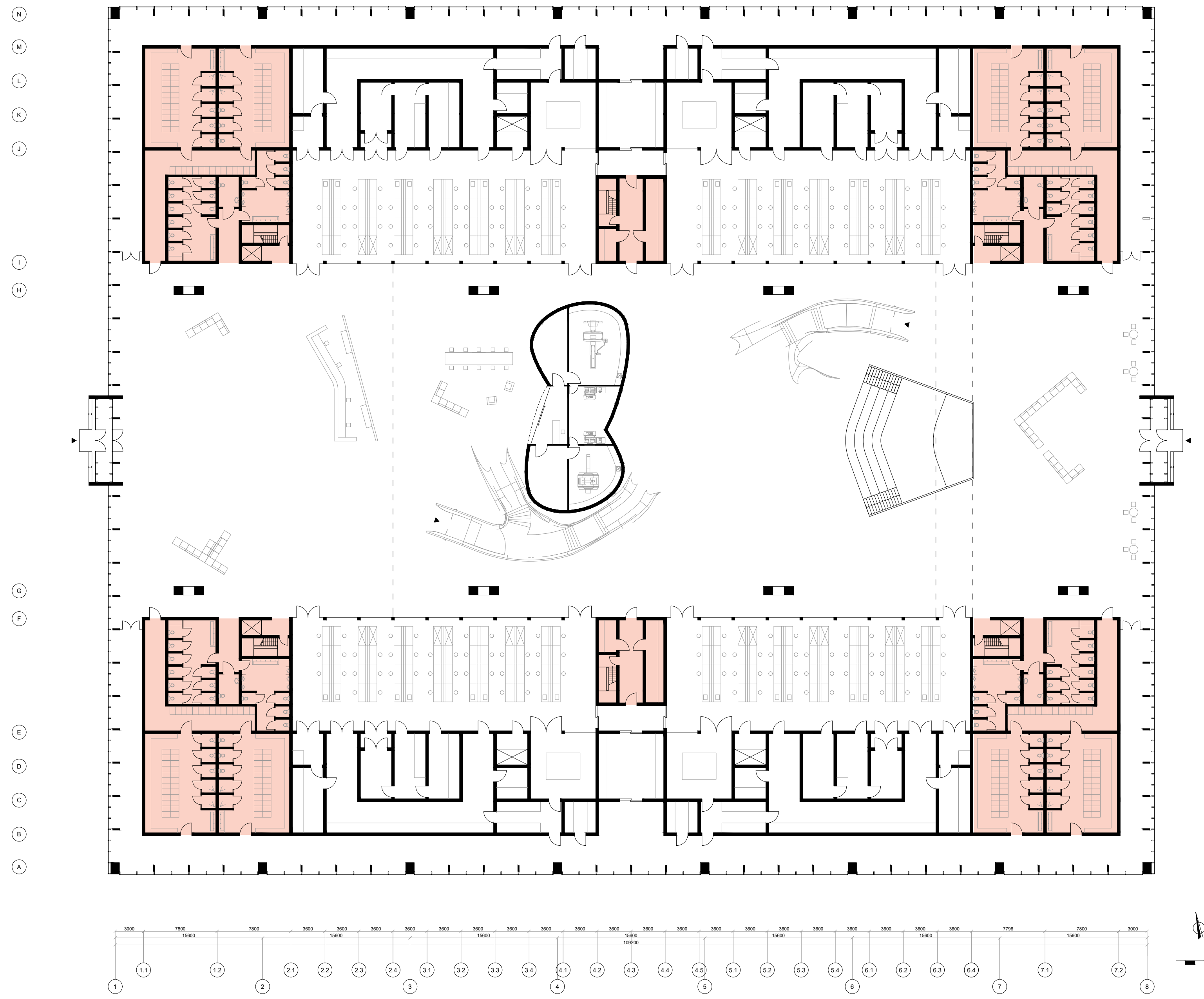

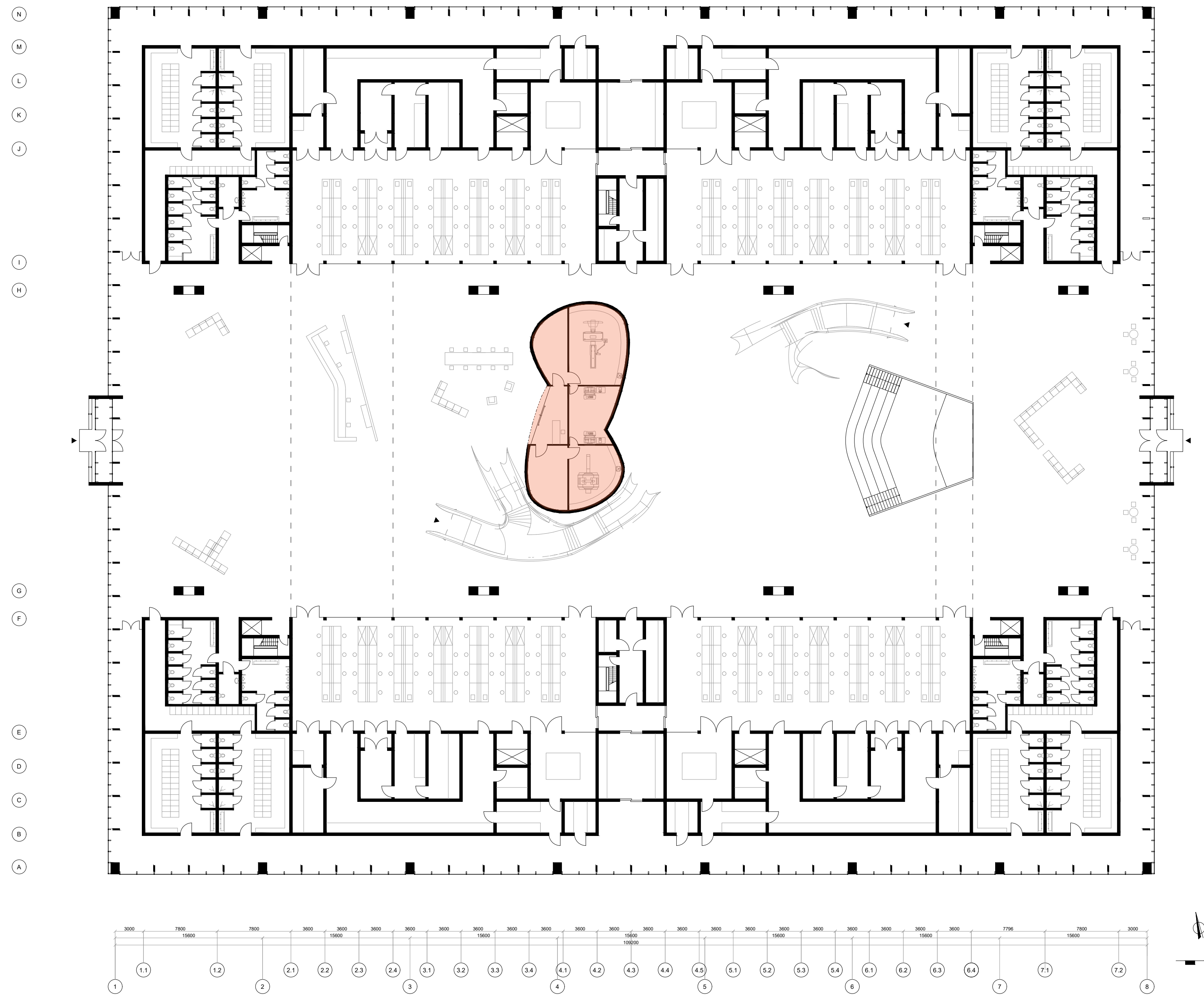



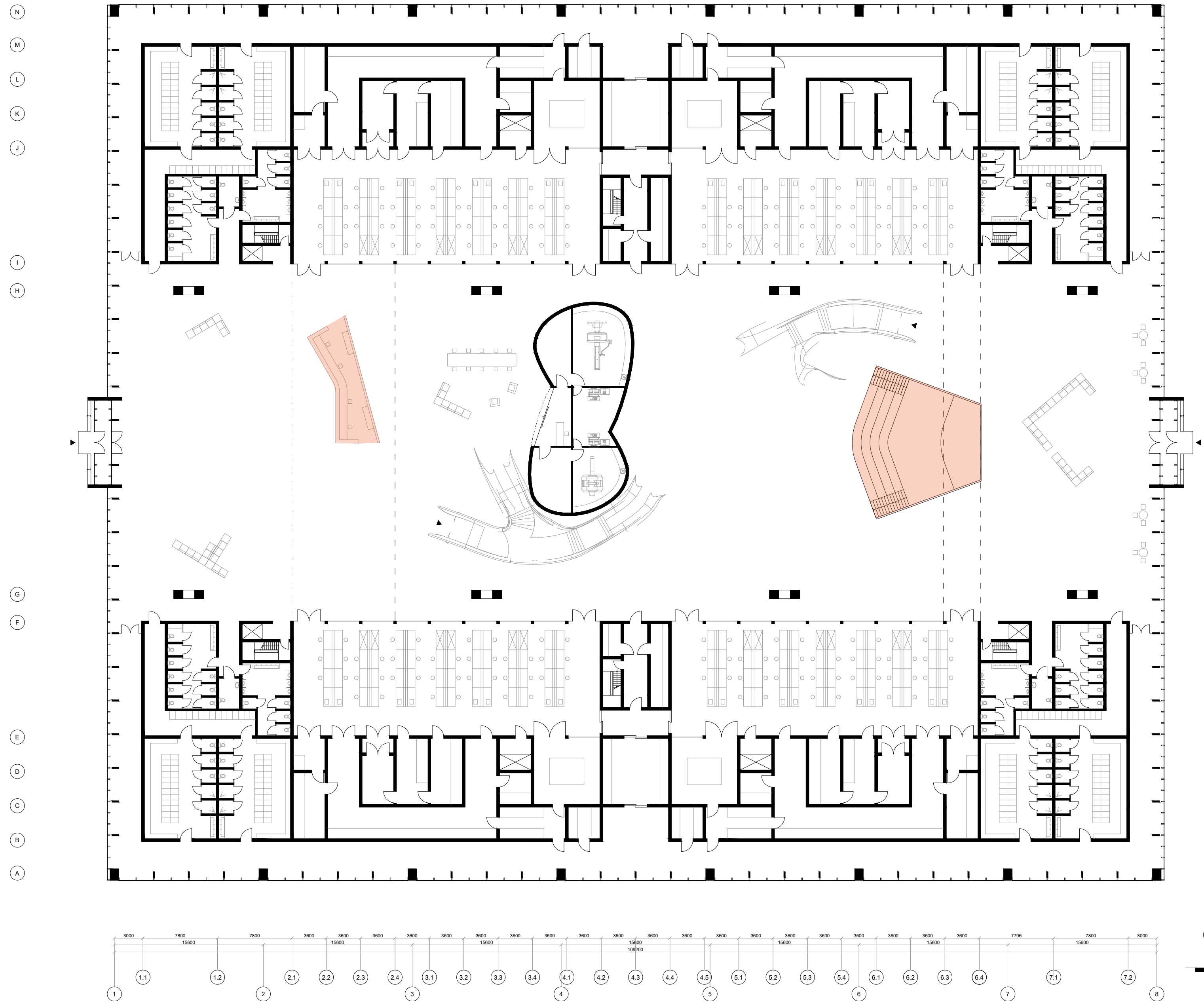

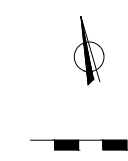
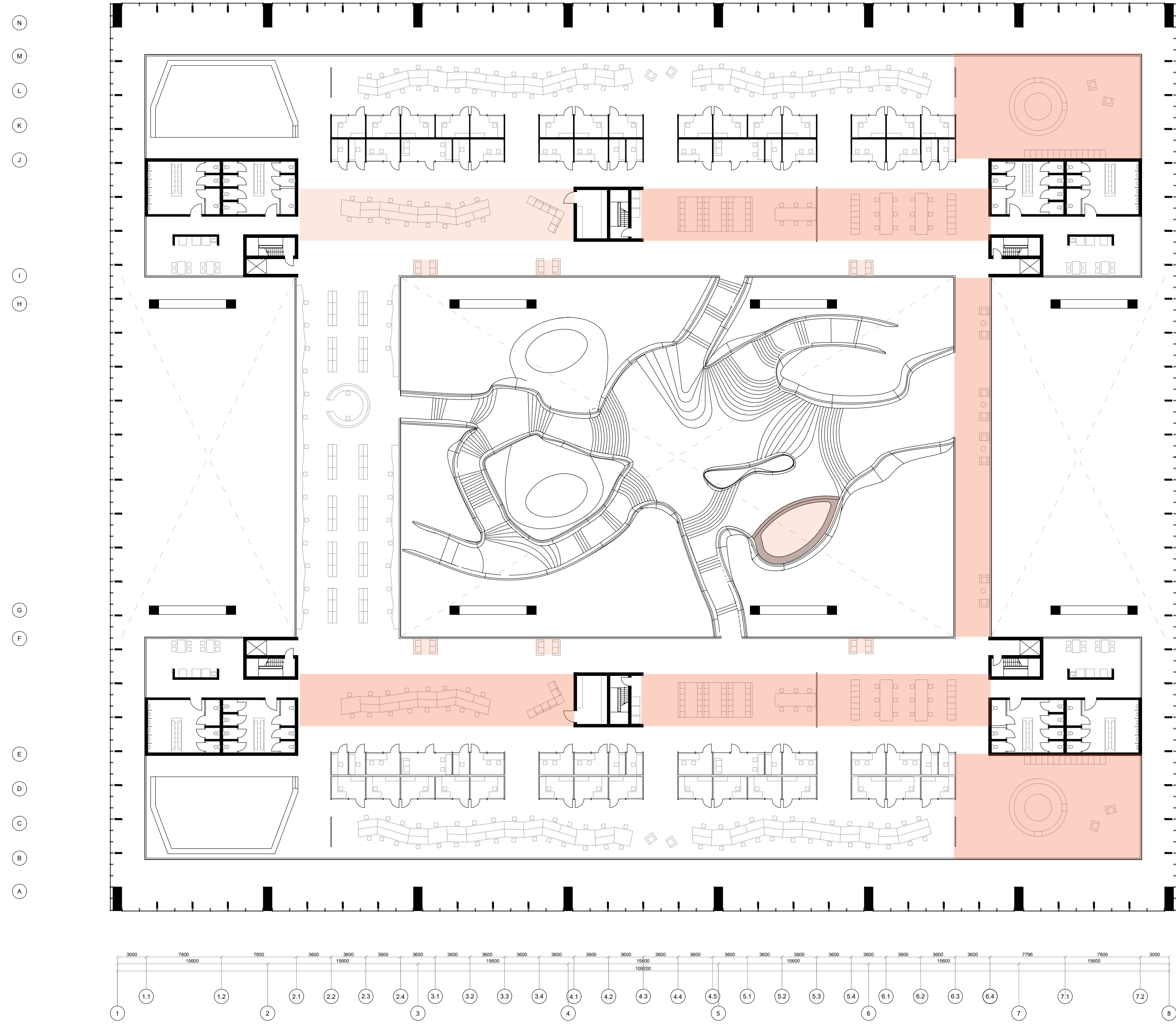

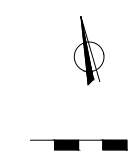
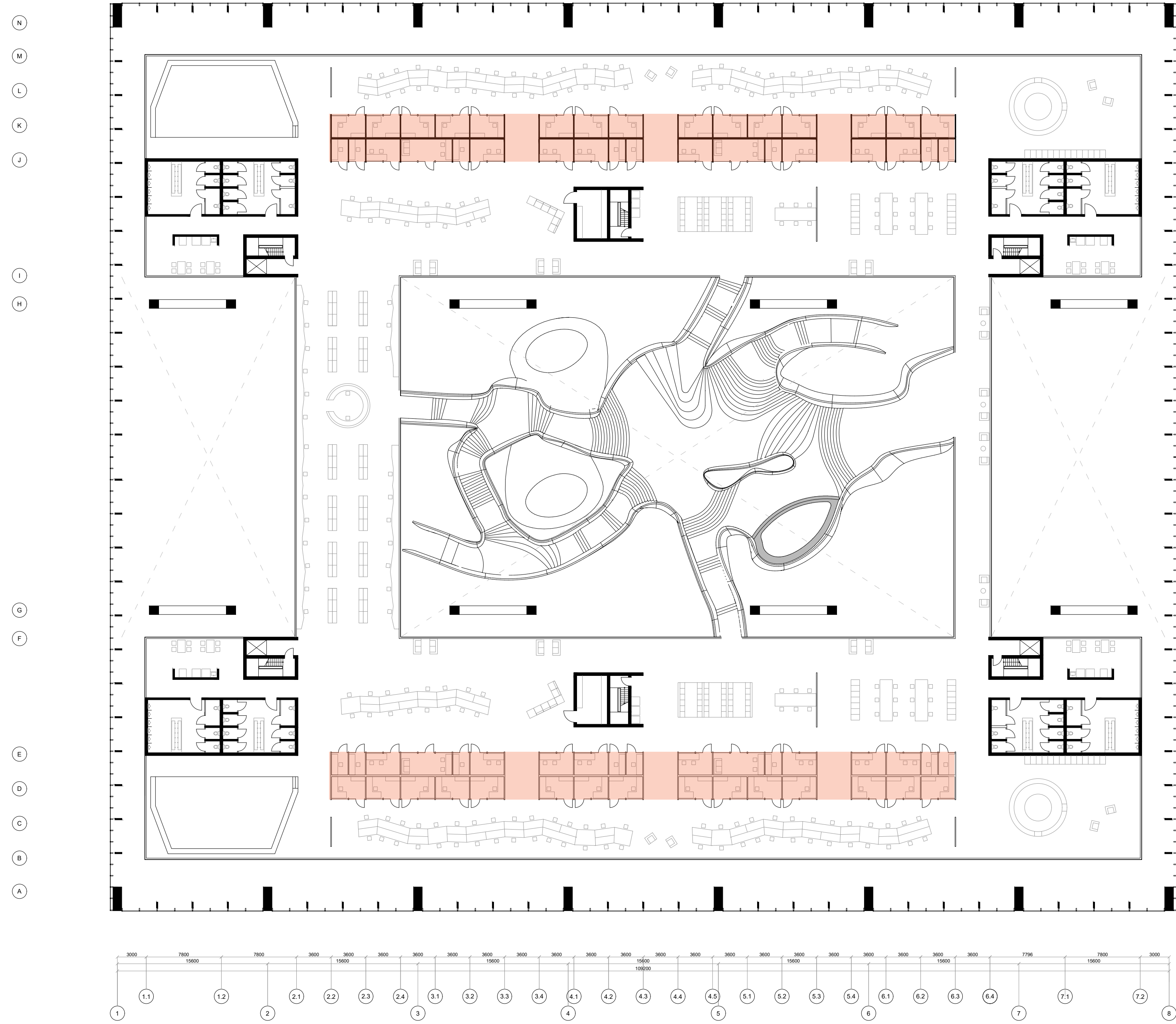

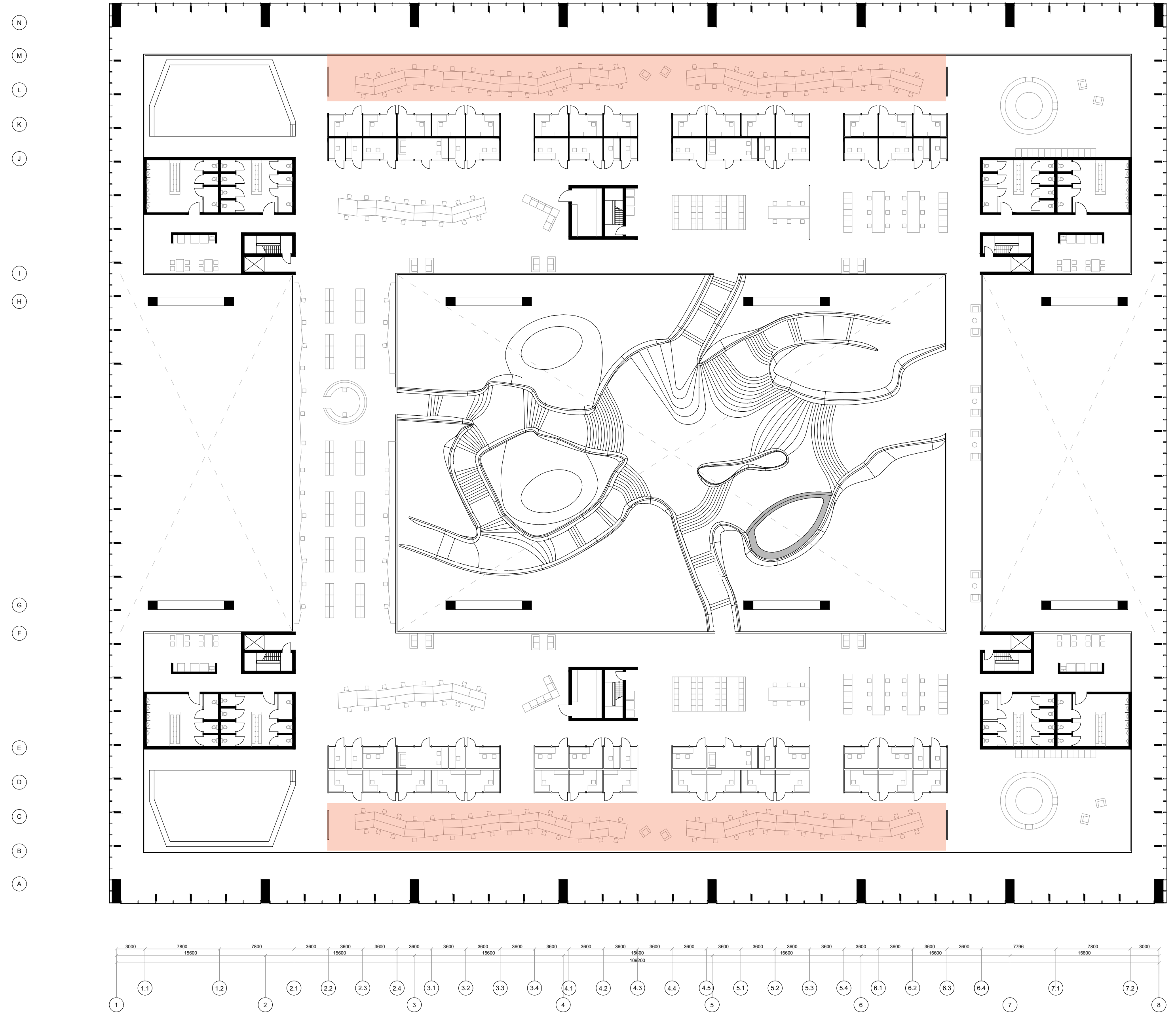

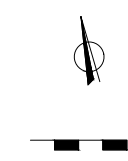
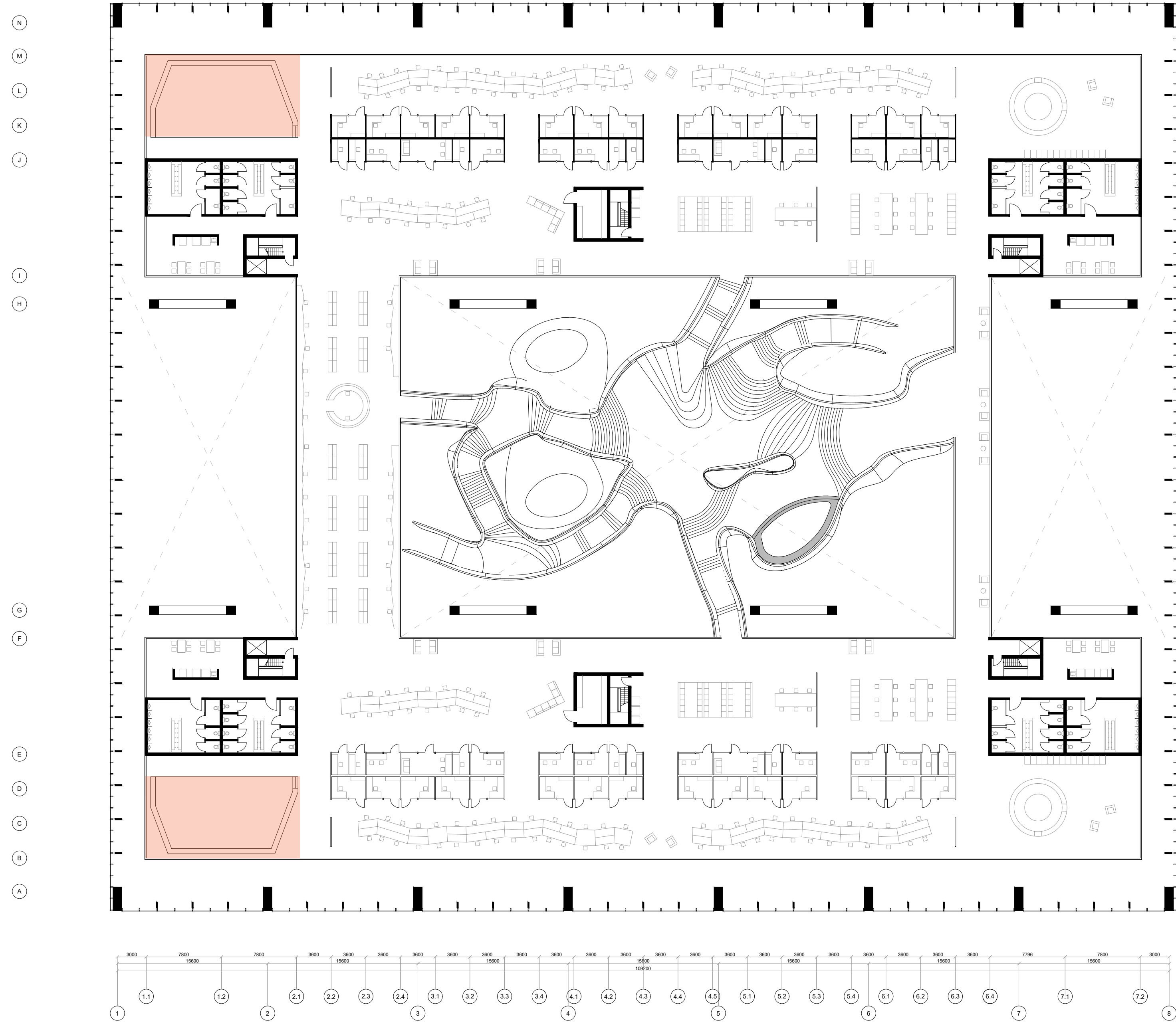

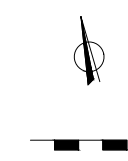
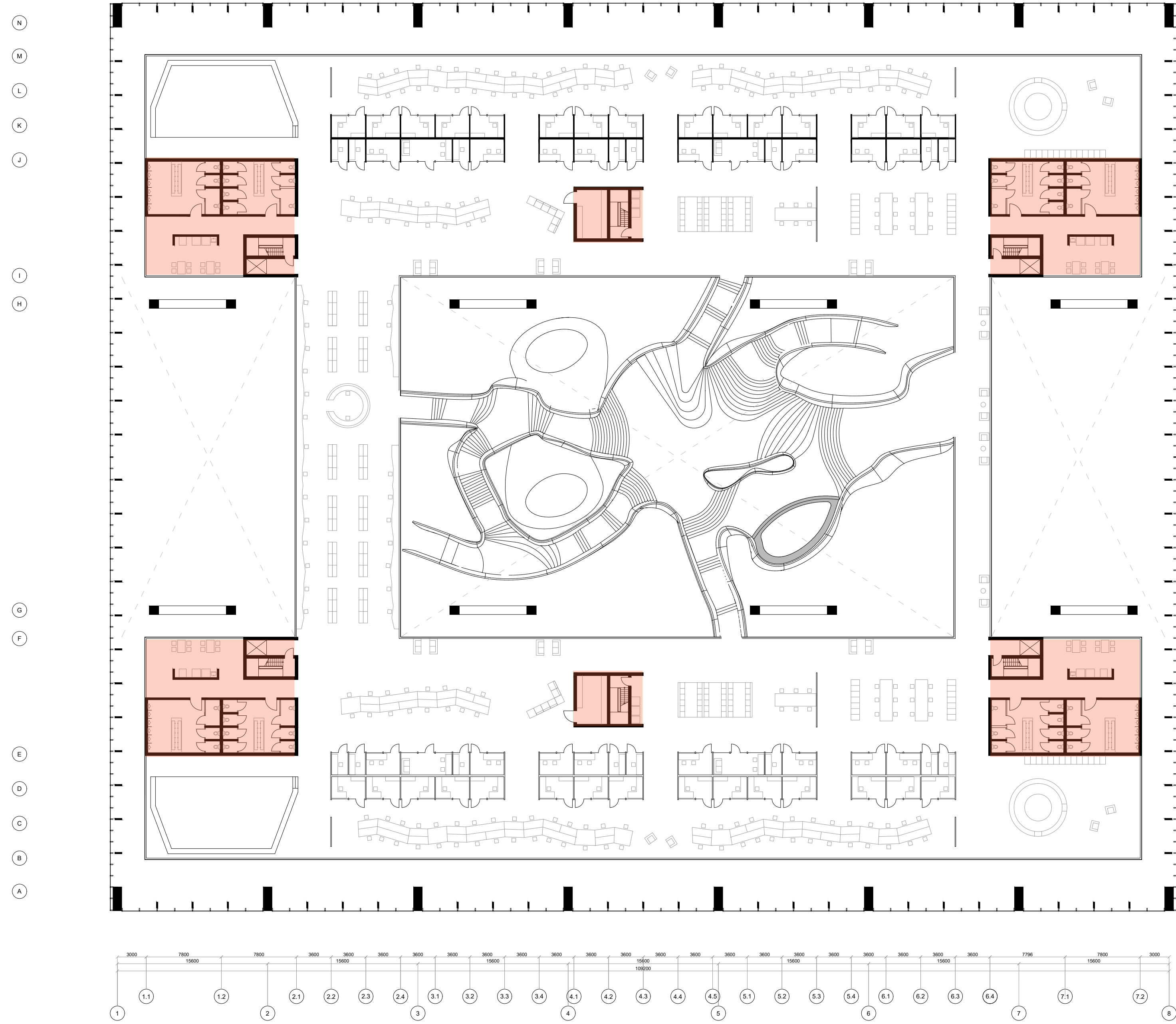

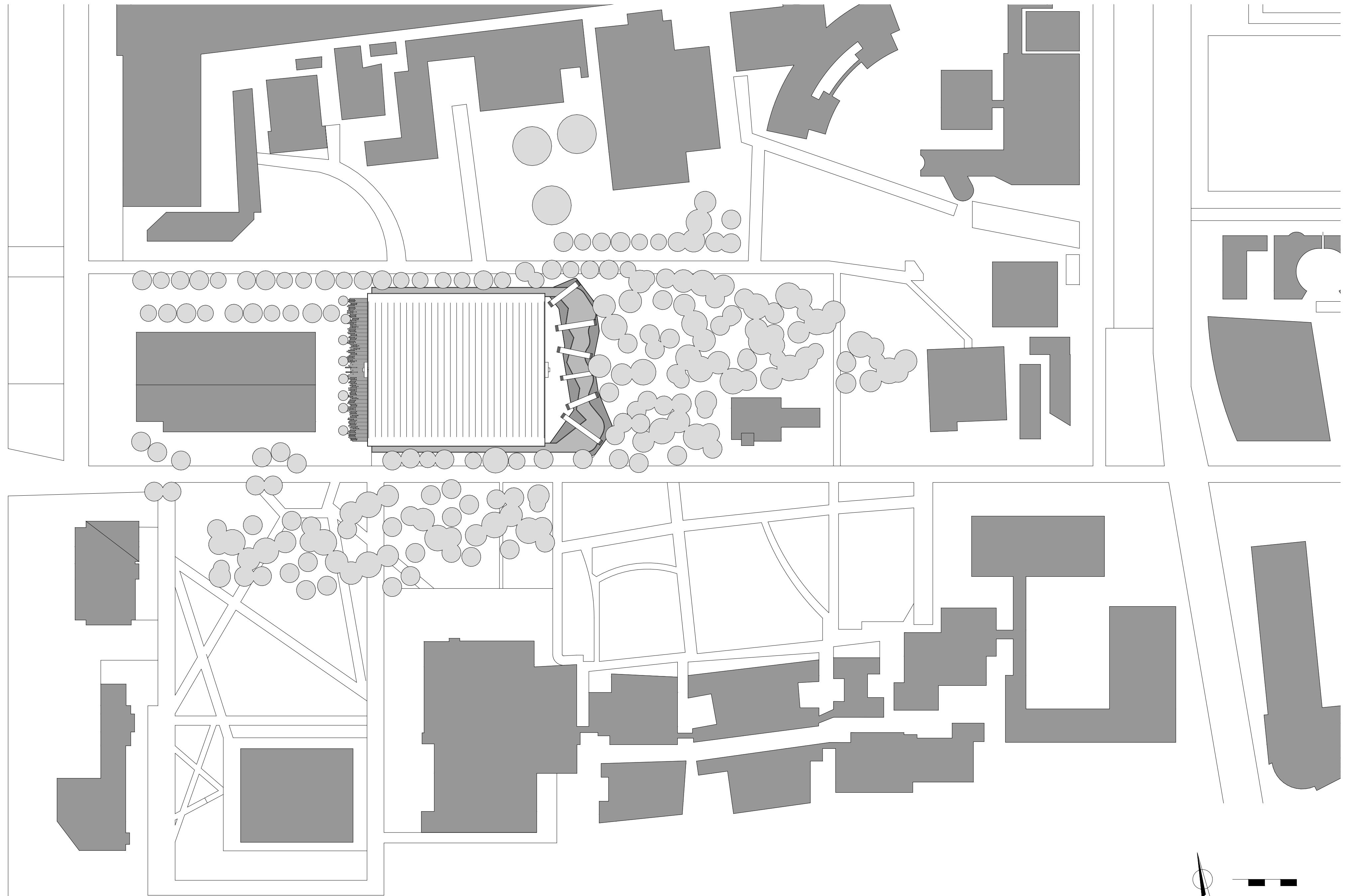

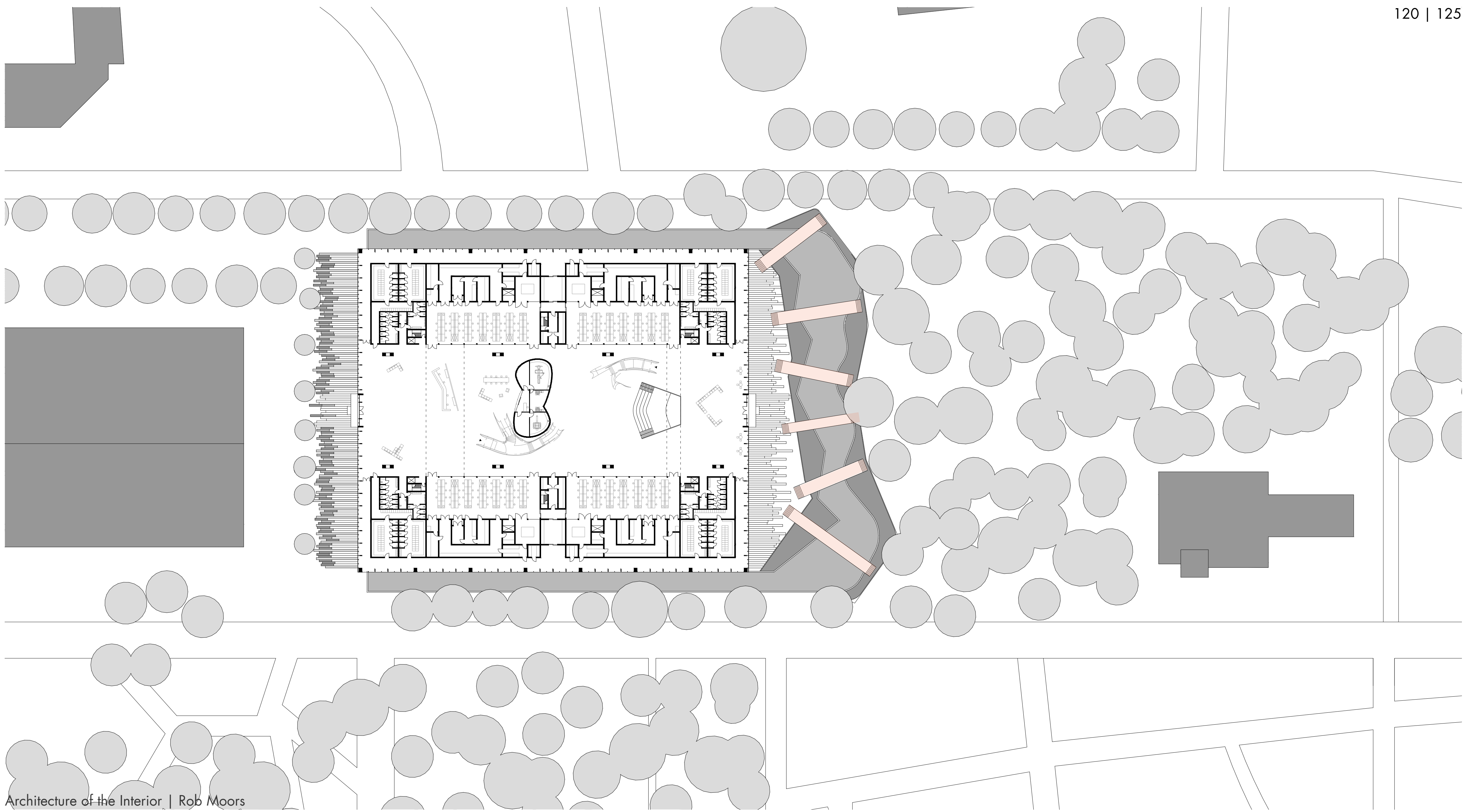



# Walkthrough

# Social

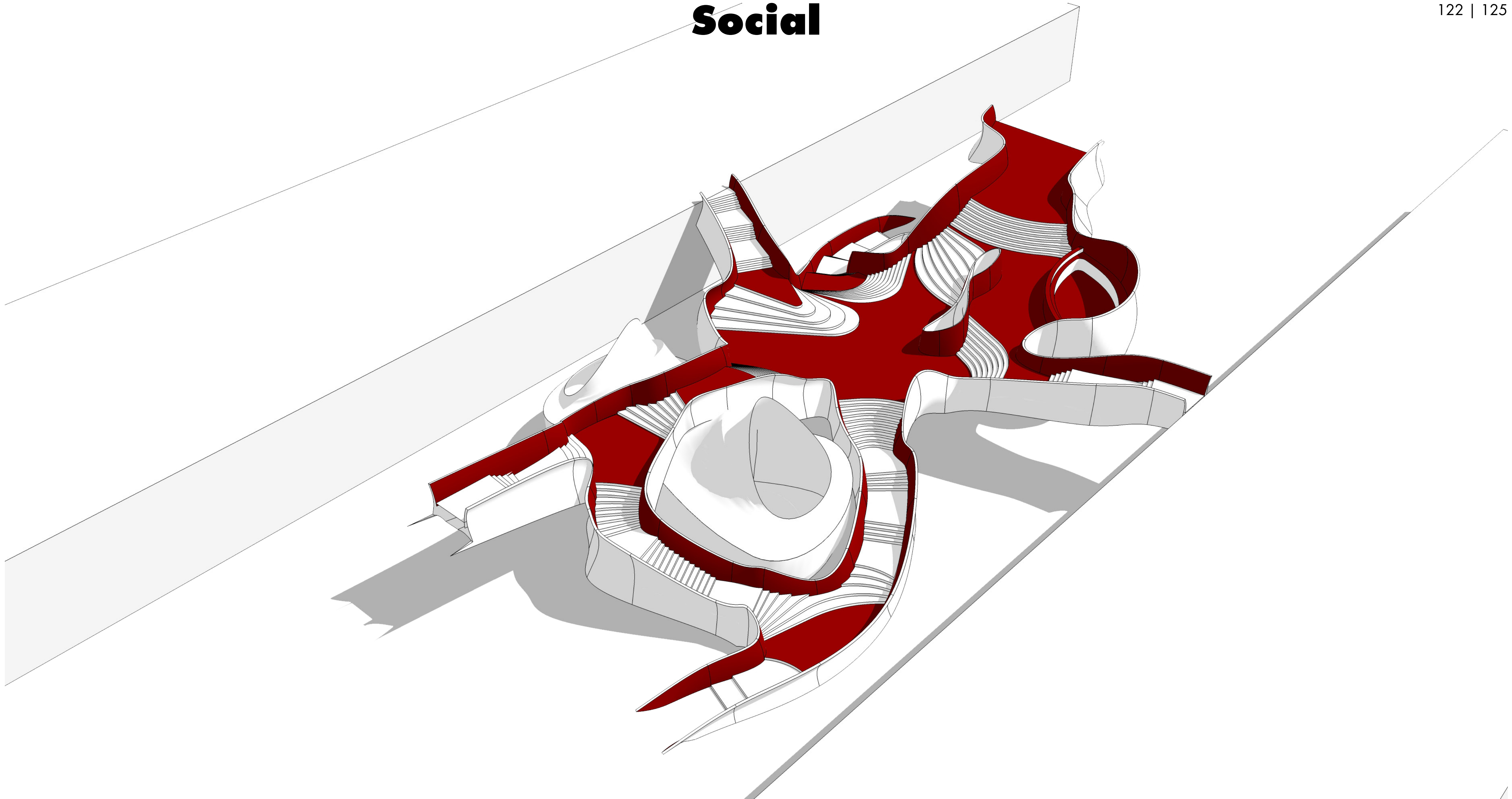

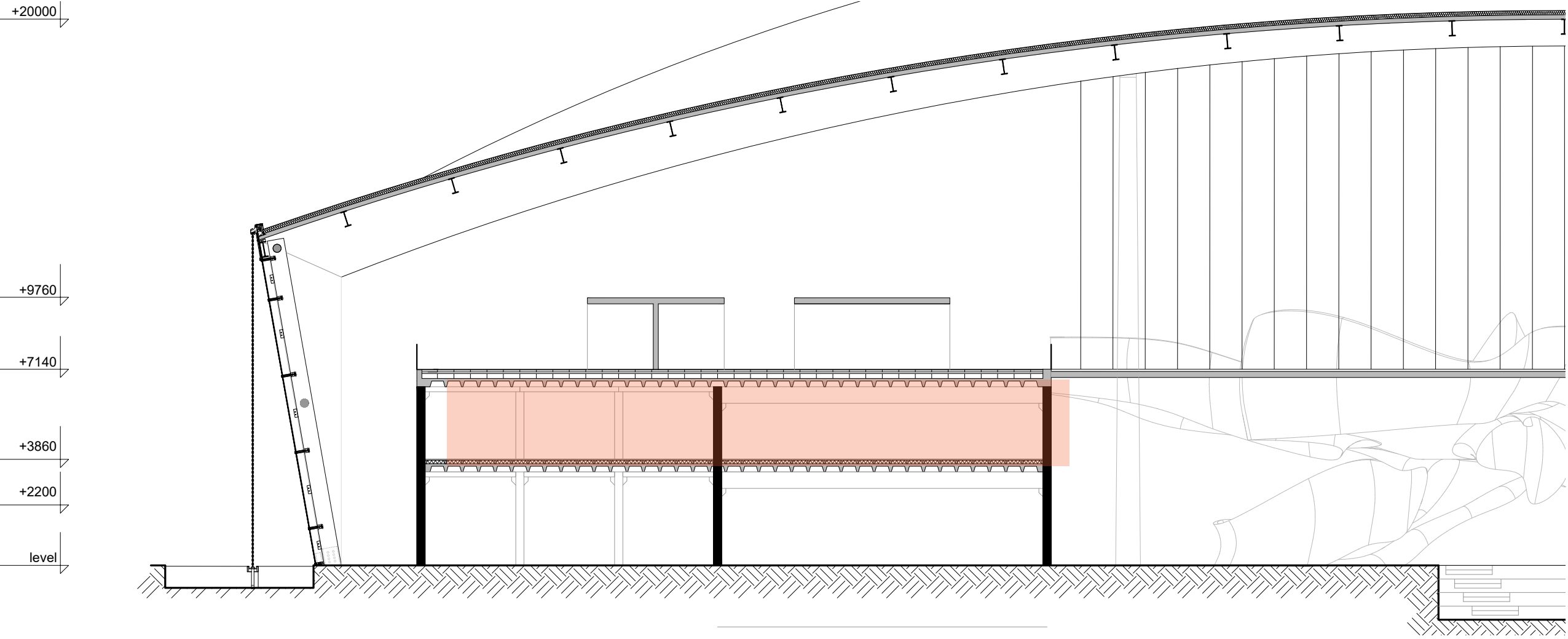
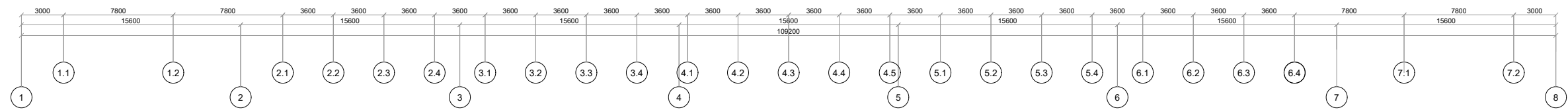
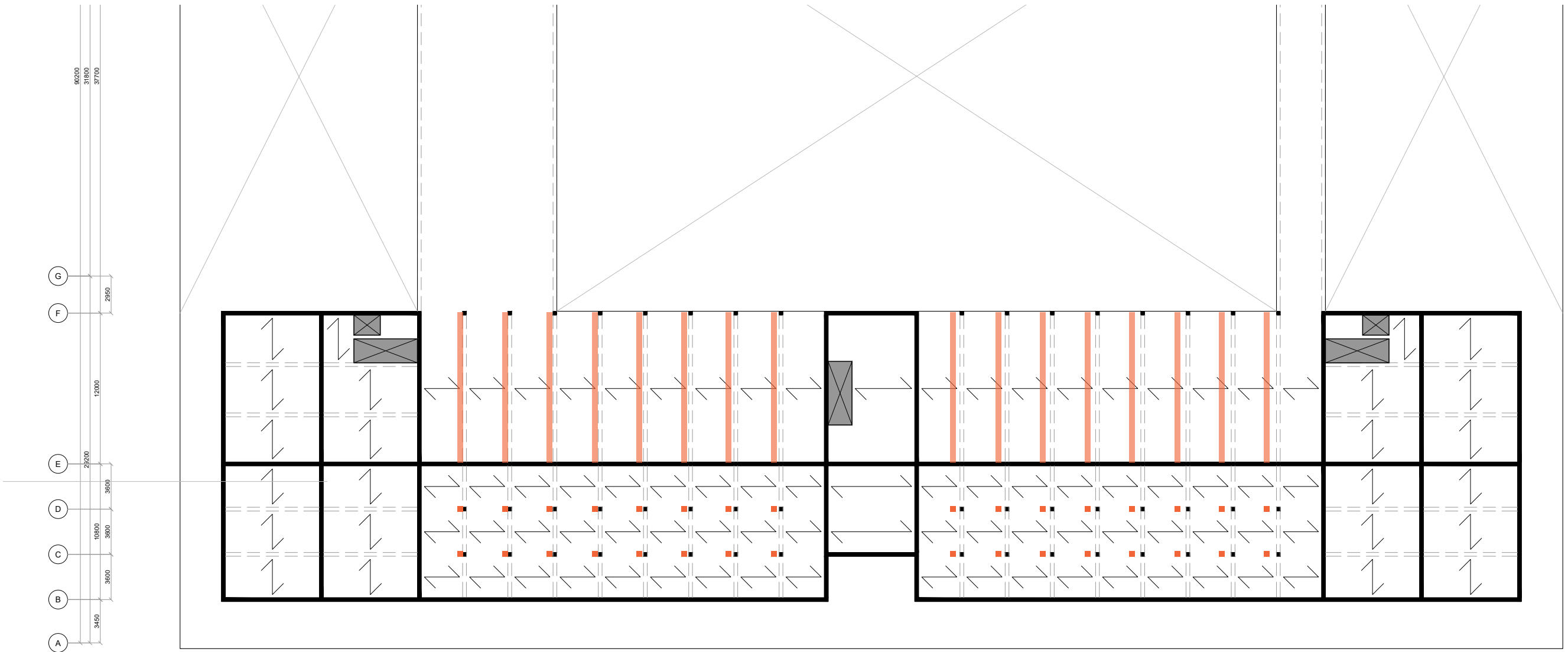
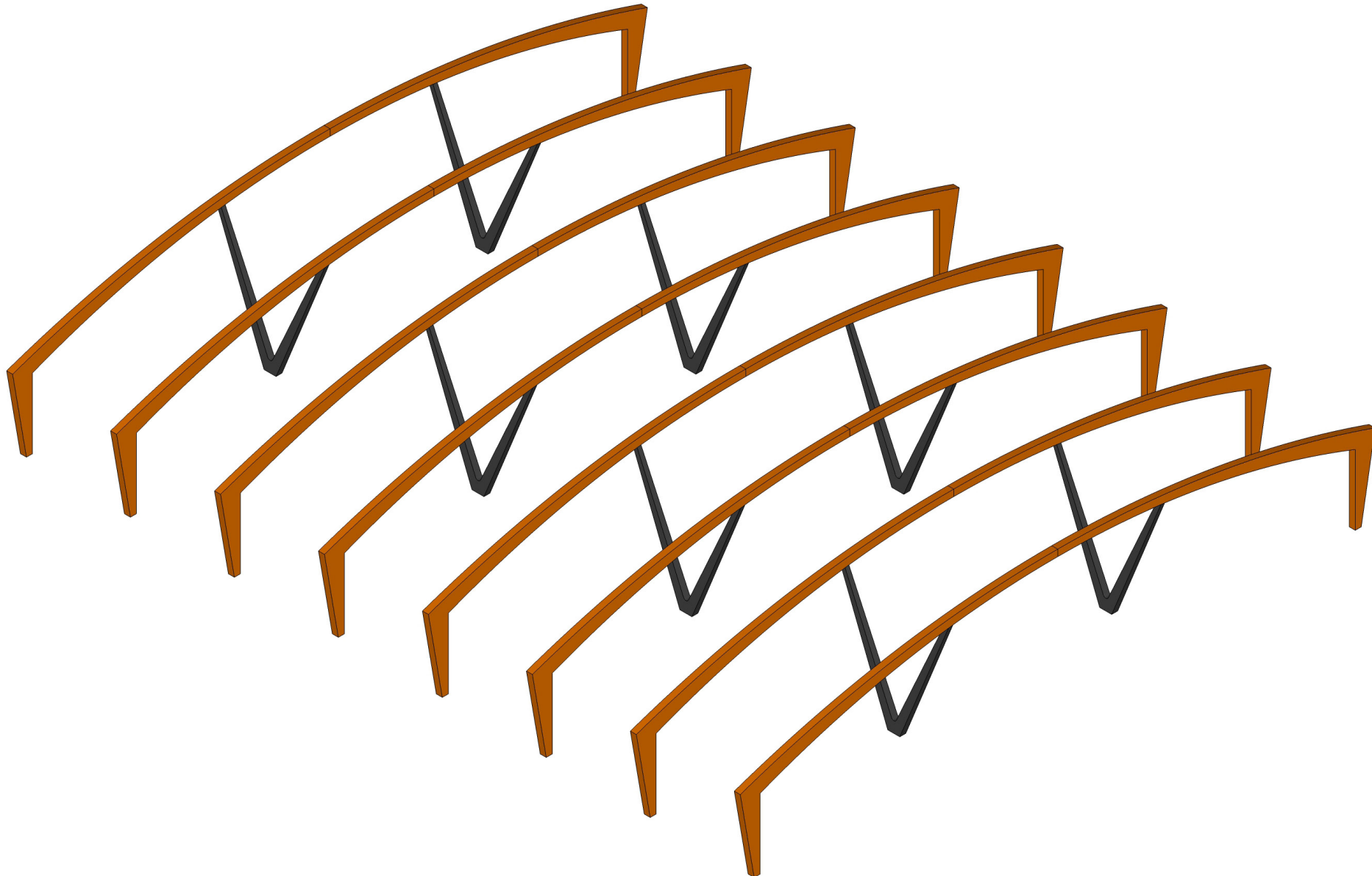

# Sustainable

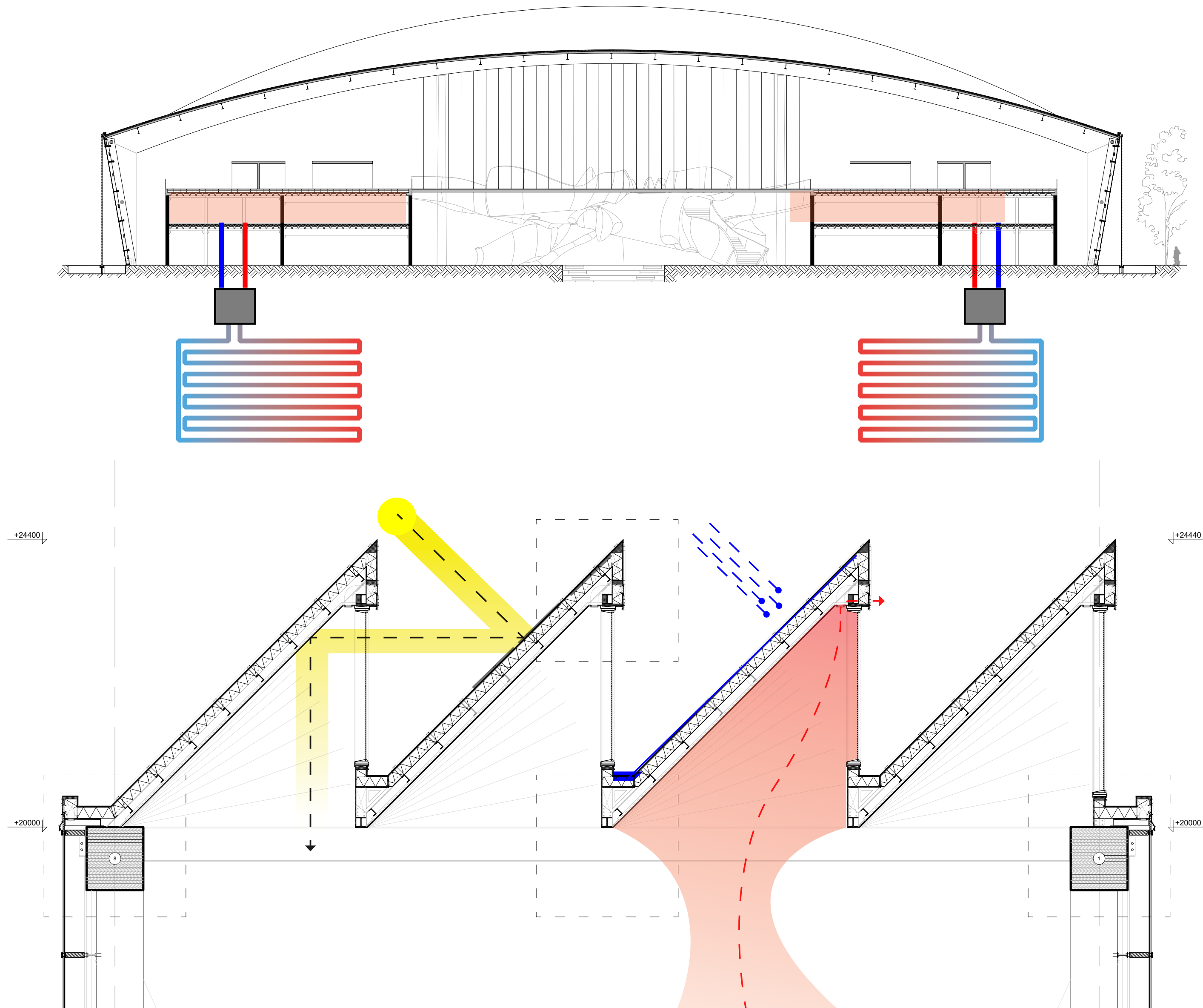

# Connected

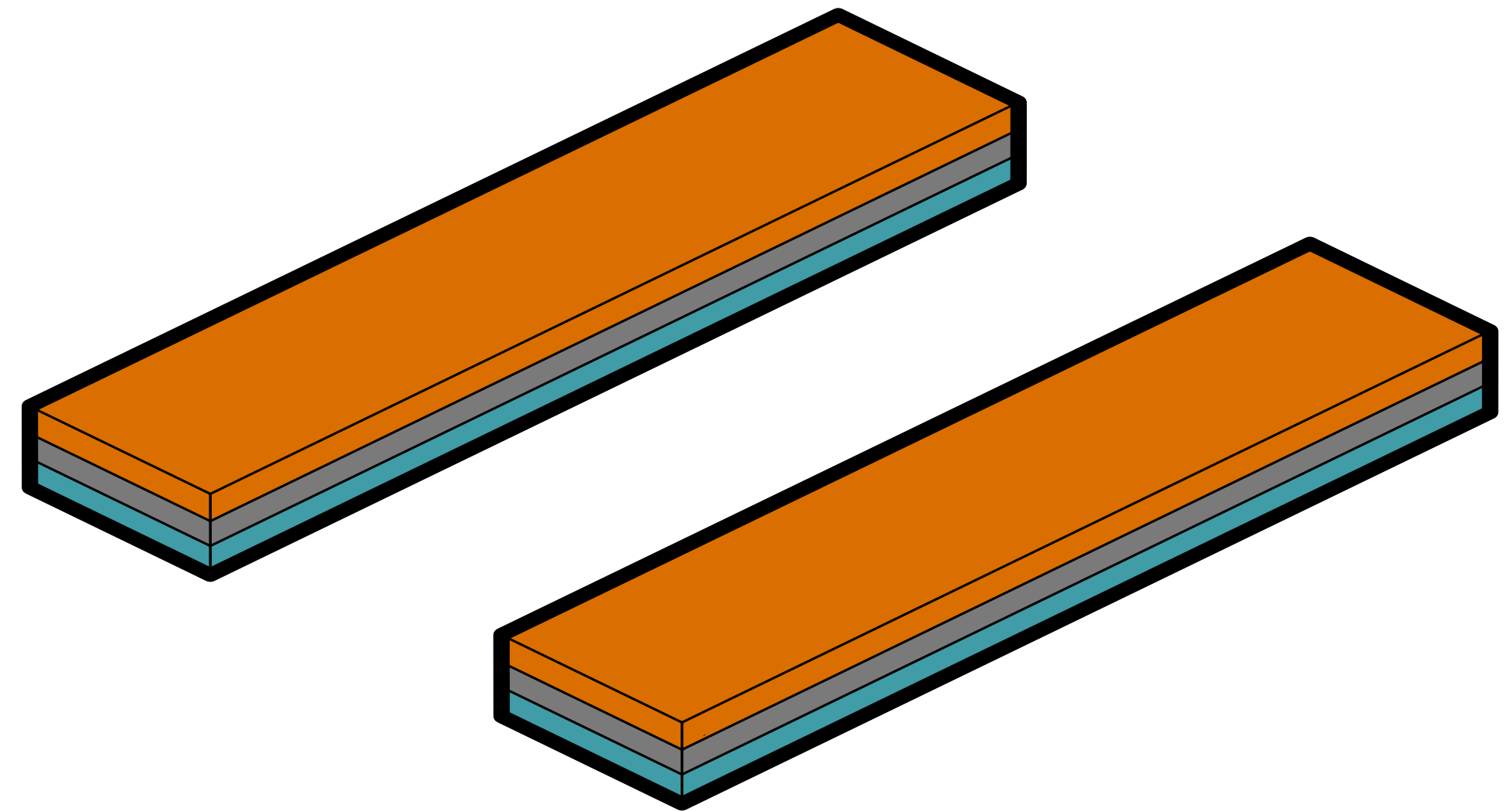

**THANK YOU FOR YOUR TIME**

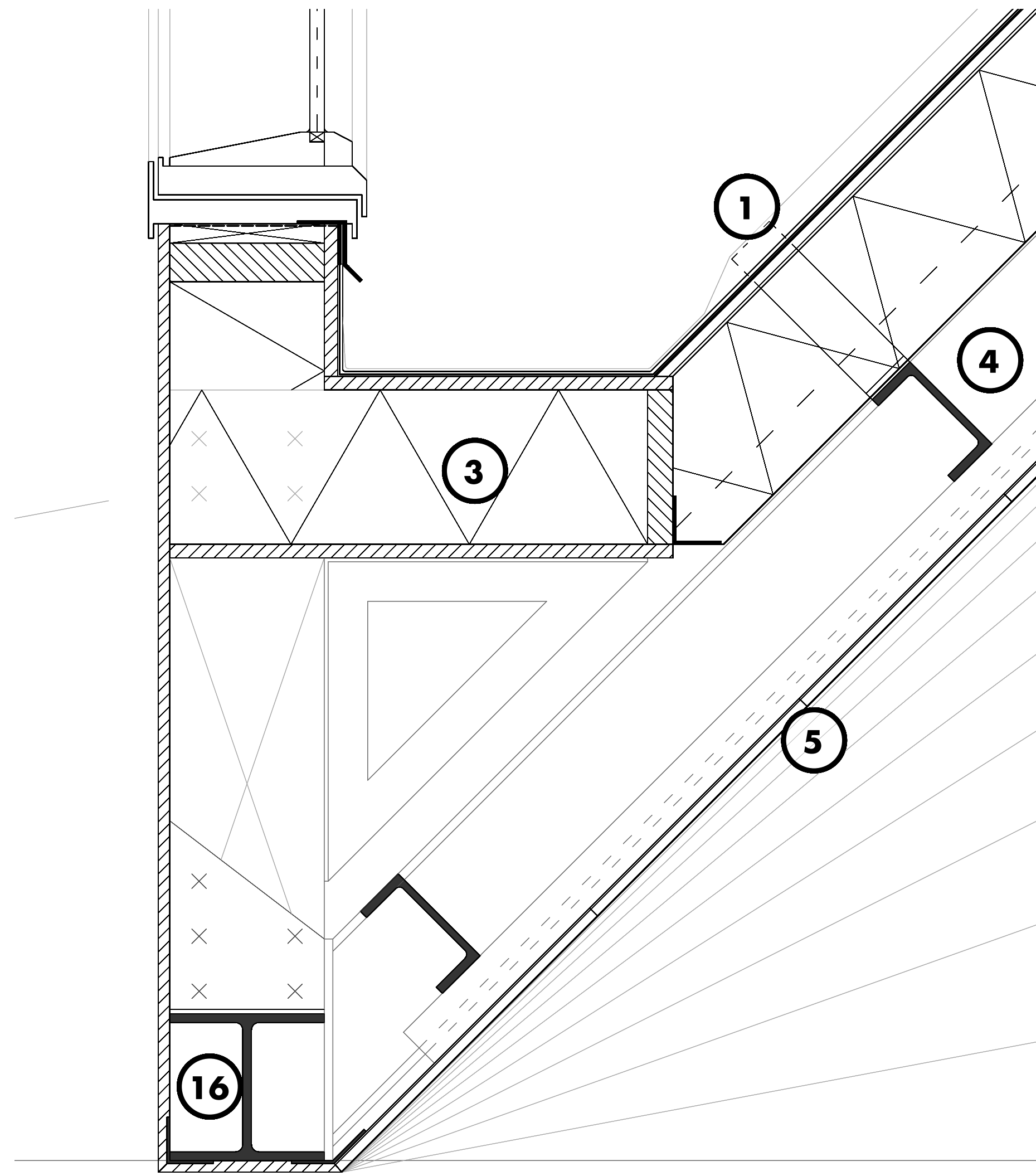

- 1.** Copper Cladding
- 2.** Ventilation Shaft
- 3.** Insulation 174mm
- 4.** UNP 120
- 5.** Fibre Reinforced Polymer Mesh
- 6.** Horizontal Window Frame 300 x 80
- 7.** Glue Laminated Timber Frame
- 8.** Vertical Window Frame 300 x 80
- 9.** IPE 550
- 10.** Facade Column 150 x 740
- 11.** Steel Cable attached to horizontal IPE160
- 12.** Perforated Corten Steel
- 13.** Cast Foundation
- 14.** Rainwater Slit Drain
- 15.** Screed Concrete Flooring
- 16.** HEA 150

9

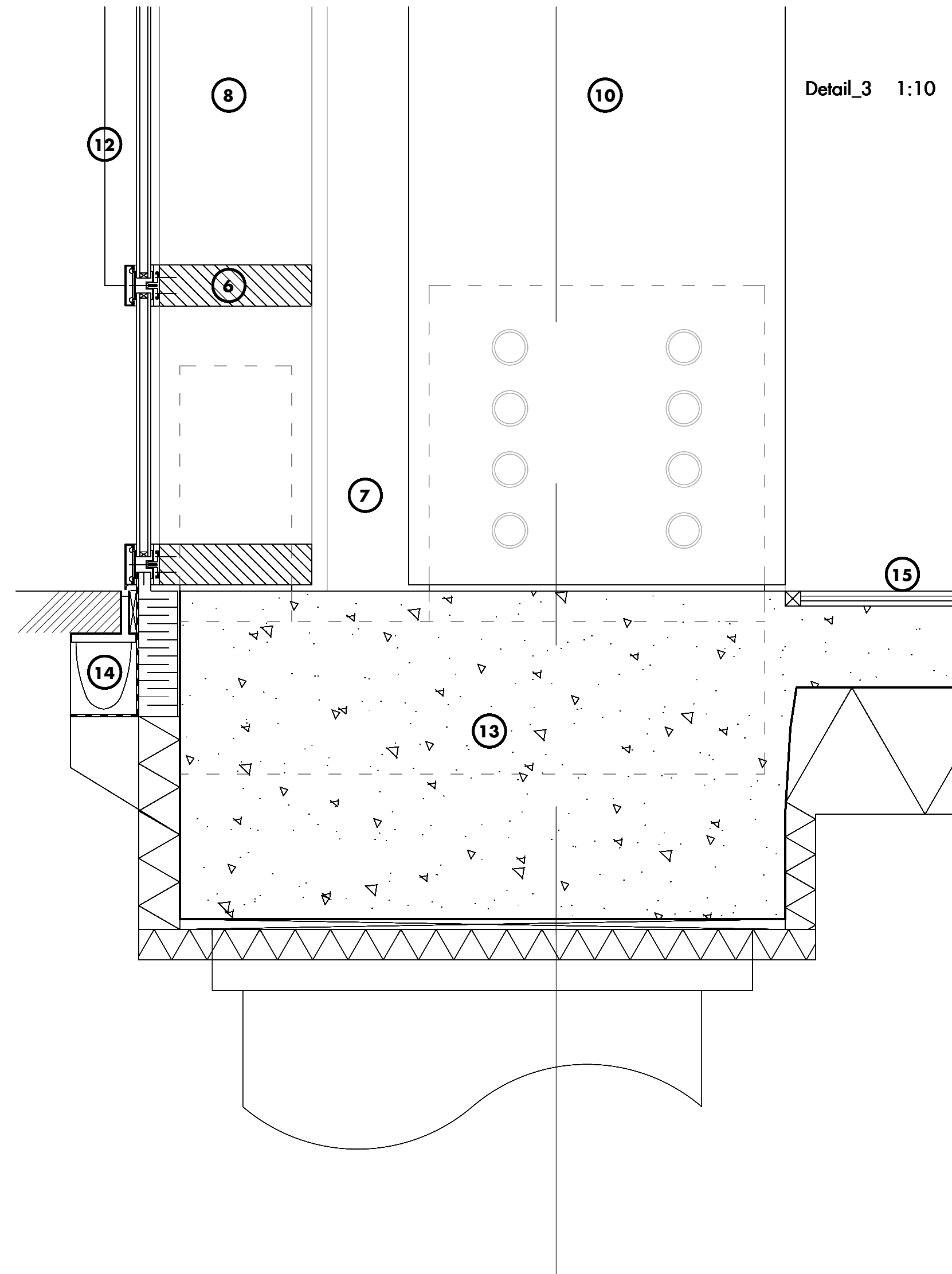

- 1.** Copper Cladding
- 2.** Ventilation Shaft
- 3.** Insulation 174mm
- 4.** UNP 120
- 5.** Fibre Reinforced Polymer Mesh
- 6.** Horizontal Window Frame 300 x 80
- 7.** Glue Laminated Timber Frame
- 8.** Vertical Window Frame 300 x 80
- 9.** IPE 550
- 10.** Facade Column 150 x 740
- 11.** Steel Cable attached to horizontal IPE160
- 12.** Perforated Corten Steel
- 13.** Cast Foundation
- 14.** Rainwater Slit Drain
- 15.** Screed Concrete Flooring
- 16.** HEA 150



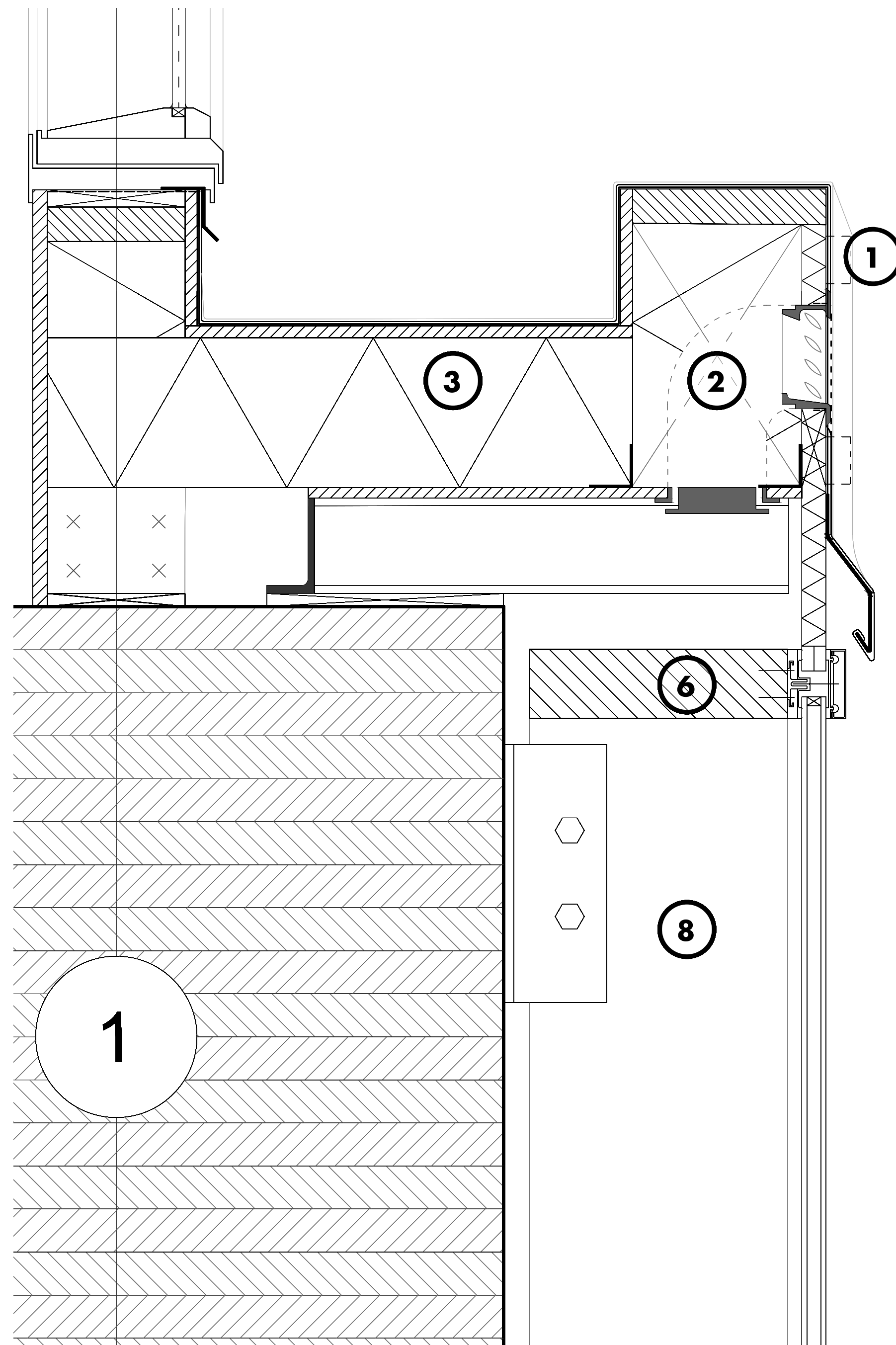

- 1.** Copper Cladding
- 2.** Ventilation Shaft
- 3.** Insulation 174mm
- 4.** UNP 120
- 5.** Fibre Reinforced Polymer Mesh
- 6.** Horizontal Window Frame 300 x 80
- 7.** Glue Laminated Timber Frame
- 8.** Vertical Window Frame 300 x 80
- 9.** IPE 550
- 10.** Facade Column 150 x 740
- 11.** Steel Cable attached to horizontal IPE160
- 12.** Perforated Corten Steel
- 13.** Cast Foundation
- 14.** Rainwater Slit Drain
- 15.** Screed Concrete Flooring
- 16.** HEA 150

- 10. Facade Column 150 x 740
- 11. Steel Cable attached to horizontal IPE160

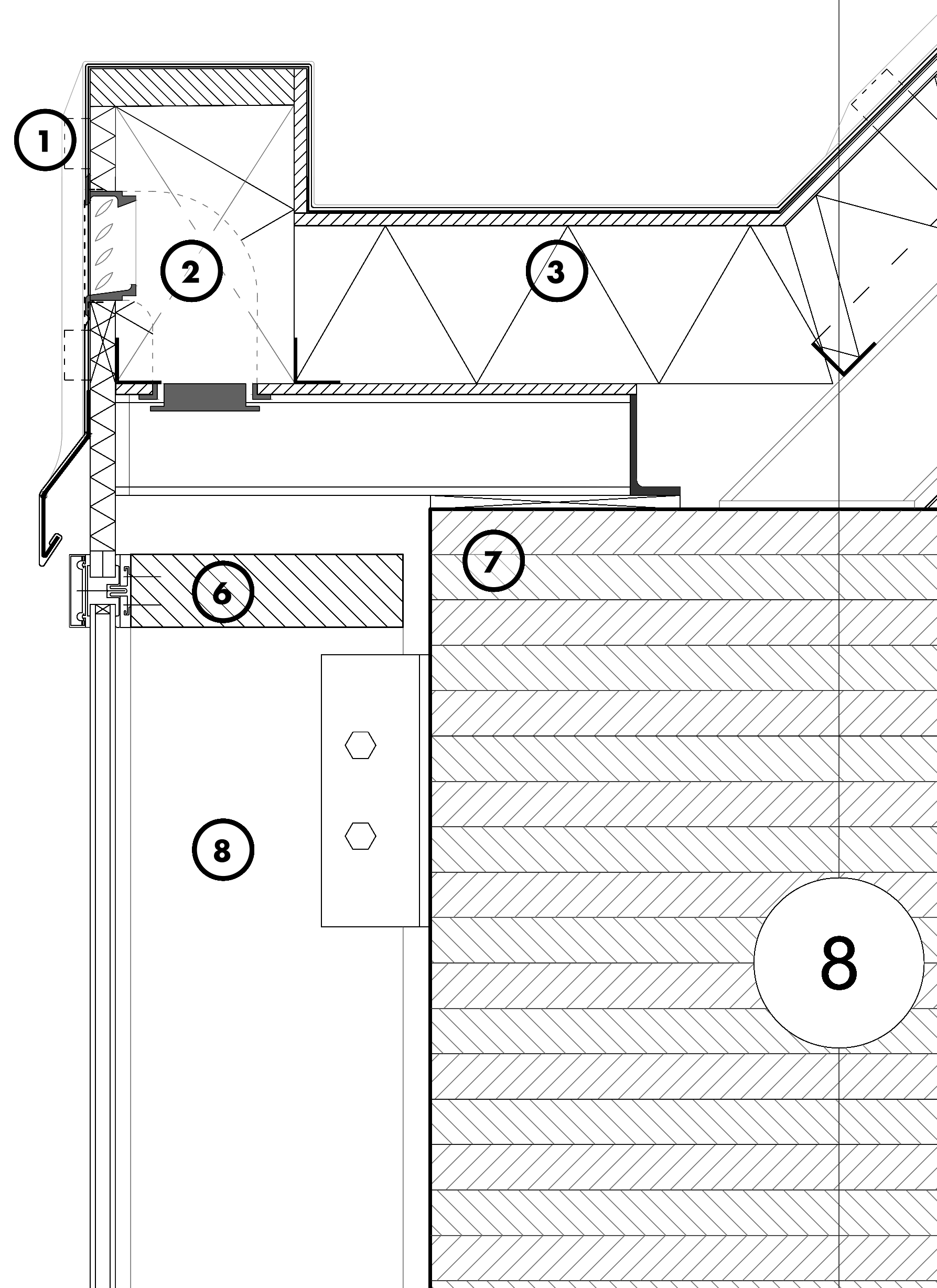

- 1. Copper Cladding
- 2. Ventilation Shaft
- 3. Insulation 174mm
- 4. UNP 120
- 5. Fibre Reinforced Polymer Mesh
- 6. Horizontal Window Frame 300 x 80
- 7. Glue Laminated Timber Frame
- 8. Vertical Window Frame 300 x 80
- 9. IPE 550
- 10. Facade Column 150 x 740
- 11. Steel Cable attached to horizontal IPE160
- 12. Perforated Corten Steel
- 13. Cast Foundation
- 14. Rainwater Slit Drain
- 15. Screed Concrete Flooring
- 16. HEA 150

