

Effect of Limited-Aeration in AnMBR Operation

Sasidhar KB

Technische Universiteit Delft

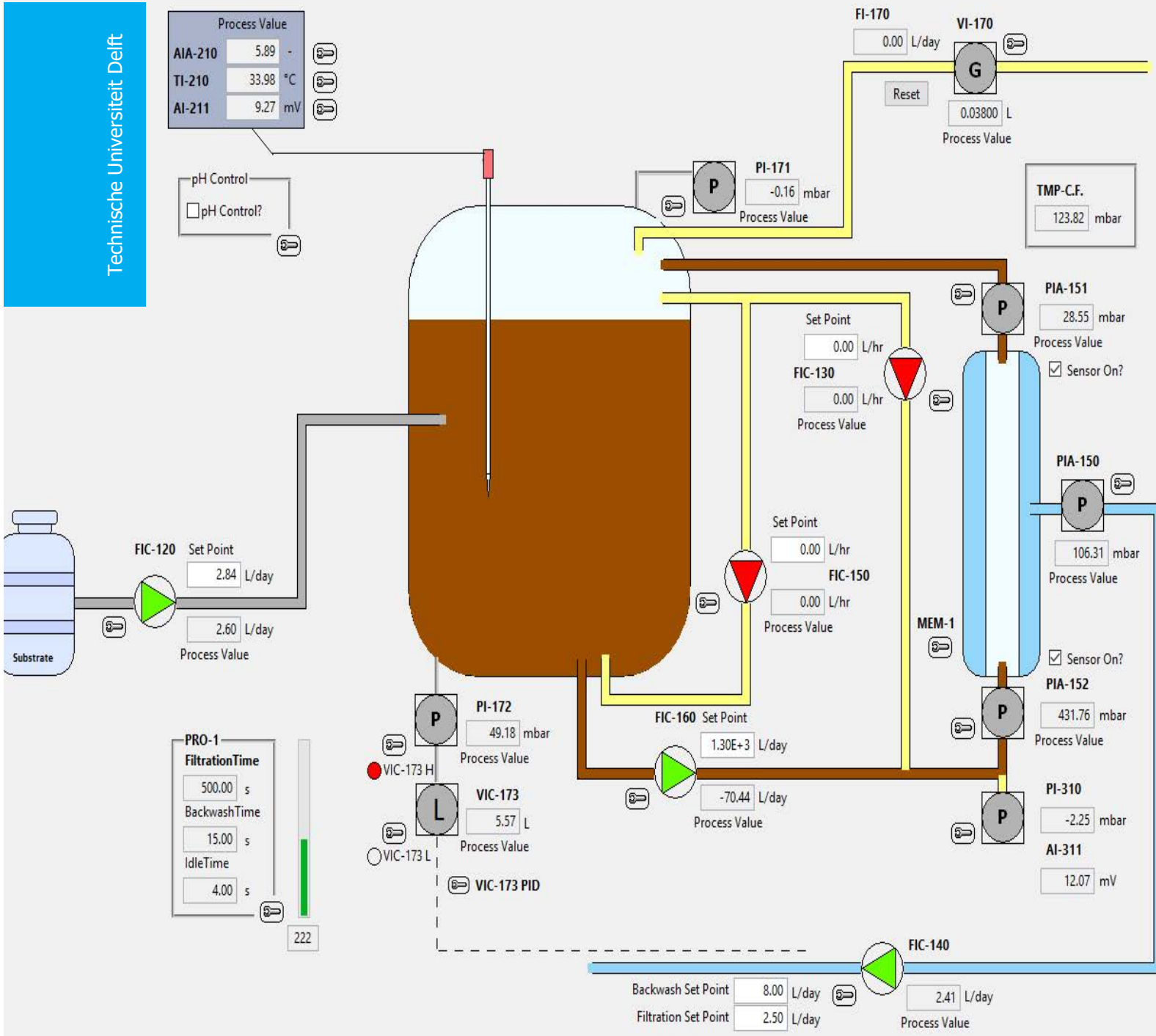

Effect of Limited-Aeration in AnMBR Operation

by

Sasidhar Koduvayur Balasubramanian

in partial fulfillment of the requirements for the degree of

Master of Science
in Civil Engineering

at the Delft University of Technology,
to be defended publicly on Tuesday July 2, 2020 at 10:30 AM.

Student number: 4703111

Supervisor: Dr. Ir. R.E.F. Lindeboom
Ir. Antonella Piaggio

Faculty Civil Engineering and Geosciences, TU Delft

Thesis committee: Dr. Ir. Ralph Lindeboom (Chair),

Prof. Dr. Ir. Merle De Kreuk,

Prof. Dr. Ir. Aravind Purushothaman Vellayani,

C.I.T.G, TU Delft

C.I.T.G, TU Delft

3ME, TU Delft

An electronic version of this thesis is available at

<http://repository.tudelft.nl/>.

Preface

This thesis work is done for the completion of the required number of credits to be received for the Master's degree in Civil Engineering program under the track 'Environmental Engineering and Technology' at the Delft University of Technology. The research was carried out in The Water Lab of the Faculty of Civil Engineering and Geosciences under the supervision of Dr. R.E.F. Lindeboom and Ir. A. Piaggio. The research conducted involves designing and setting up of an Anaerobic Membrane Bioreactor, to study the Effects of Limited-Aeration in AnMBR Operation. The AnMBR treating laboratory made synthetic blackwater is subjected to obtain the desired research objectives.

This report aims in providing detailed setup procedure, substrate preparation, experiments conducted and the results obtained thereof. The reader interested in the effects of aeration on the system operation, is directed to Chapter 1 and Chapter 4. The reader focused in setting up of a similar setup is directed to Chapter 3.

Constructive criticisms on the structure and presentation of the report are welcome. As the researcher and author, I take responsibility for any error or loss of clarity in the report. Comments on the concepts presented and criticisms on my approach to the subject is also welcome as I am eager to learn and relearn. ...

Sasidhar Koduvayur Balasubramanian
Delft, July 2020

Acknowledgement

I cannot imagine completing this research work without the help of many lovely people. I would take this opportunity to personally thank each and everyone who have been immensely supportive of me mentally and physically. I would begin this thanking spree from none other than my 'GURU' **Dr.Ralph**. Guru is a Sanskrit word for teacher, which literally translates to a person who removes the darkness and enlightens his disciples. I cannot think of another person who is more apt for this definition than Ralph. Right from the day of taking me as his student, from driving me personally to Wageningen, to numerous help offered in setting up the reactor, discussing with great patience, putting up with my shenanigans for more than a year in the lab. Thank you for being the best supervisor one could ever ask for. Thank you for being extremely approachable and motivating. Next I would like to thank **Ir.Antonella** for her massive contribution in shaping up my thesis to a better version. Thank you for teaching me to be better organised with the lab work, for brainstorming with me every week to identify and correct errors, for teaching me experiments and for supporting me through these days. My gratitude to **Dr. Merle** is again limitless. As course coordinator, as lecturer, as a mentor and as co-supervisor, the learning that I have obtained from her is countless. Your contagious enthusiasm had me going despite the ups and downs in the lab. Thank you for believing in me. I vividly remember meeting **Dr.Aravind** for the first time during the kick-off meeting. After the meeting, there he was telling me that I seemed very enthusiastic about the subject. Despite meeting for very few times, and me not able to take up the task of measuring siloxanes, he was still boosting my confidence by telling the committee that I am capable of doing the work put ahead of me. Thank you so much for backing me up and improving my morale.

I would like to extend my thanks to **Ir.Adrain, Ir.Victor, Ir.Sara, Ir.Hongxiao** and **Armand** for their immense help in the lab and making my lab work easy. I would like to thank my lovely classmates **Dhavissen, Daniel, Athira,** and **Magnolia** for their love and support in the course of my university life. Furthermore, I thank my lovely friends, **Sampath, Shravan, Sid, Prethvi, Yams, Sandy, Mrinal, Apoorva, Shreya and Rubayat** without whom my journey would have been hell. Thank you for making me laugh in the darkest of times, understanding my feelings and lending a wishful ear whenever I needed. I would also like to thank **Adithya, Prashanth, Krishna, Naveen, Sownder and Santosh** for their brotherly affection.

Finally, I would like to thank my mom **Sheela Devi**, dad **Balasubramanian**, brother **Sundhara Kumar**, and my entire **family and friends from India** for everything that I am today.

*Sasidhar Koduvayur Balasubramanian
Delft, July 2020*

Abstract

The scarcity of water is a major global concern in the modern times. Hence, the judicious use of water must be coupled with water reuse to counteract the water depletion. To reuse water, we eye on available treatment technologies which can guide us to circular use and reuse of water and nutrients. Anaerobic digestion, is known for producing better quality effluent with a possibility of energy generation through biogas. It can also be coupled with post-treatment techniques to extract nutrients.

Anaerobic membrane bioreactors have been used to treat high-strength wastewater to obtain higher particle and organic removal. Introducing limited aeration to such an anaerobic environments have been studied earlier to enhance the degradation process. Depending on the quantity of aeration added and the mechanism of aeration, studies have reported both positive and negative effects on the organic degradation. The existing studies only cover the effects of the applied aeration on the Anaerobic Digestion process. Little is talked about its effect on the sludge characteristics such as particle size and sludge rheology.

This research focuses on studying the effect of applied aeration on the AnMBR performance, based on the effect of aeration on substrate degradation and on sludge characteristics. To study this, an AnMBR is operated with laboratory-made synthetic blackwater treating 5gCOD/l. A 2% increase in oxygen with respect to the sludge VSS is introduced through added air. The effect of this added aeration to the system is studied. The organic removal was enhanced by 11% when compared to the observed removal during the non-aerated phase. Ammonium concentration increased by 24% and sulphate concentration reduced by 12% in the effluent. The size of the coarser fraction of sludge, D90 increased by 13% and that of the finer fraction D10 increased by 15%. The viscosity profile of the sludge after aeration also increased. Inhibition caused to the Methanogenic activity of the sludge reduced as the sludge started adapting to the applied aeration. Activity changes to higher sets of aeration matching that of a Dissolved Aeration and Flotation system was studied. The feasibility of such a system is still a work in progress for the future. The obtained results are for an adapting sludge, and has to be continued for a better adapted sludge. Recommendations based on this study to future works on the same line, is given.

Contents

List of Figures	xiii
List of Tables	xv
1 Introduction	1
1.1 Societal Challenge	1
1.2 Need for Anaerobic Wastewater Treatment	2
1.3 Problem Statement	3
1.4 Research Approach	4
1.5 Research Questions	5
1.6 Contribution/Result Summary	5
1.7 Project Workflow and Report Organization	6
2 Theoretical Background	7
2.1 Anaerobic Digestion - An Overview	7
2.1.1 Hydrolysis	9
2.1.2 Acidogenesis	9
2.1.3 Acetogenesis	10
2.1.4 Methanogenesis	10
2.1.5 Methane Production and COD Balance	12
2.2 Anaerobic Reactors - Basics and Related Works	13
2.2.1 Evolution of High-Rate Anaerobic Reactors	13
2.2.2 Brief Summary on Anaerobic Membrane Bioreactors	14
2.3 Limited Aeration in Anaerobic Digestion	15
2.3.1 Effect of Limited Aeration on Hydrolysis	15
2.3.2 Effect of Limited Aeration on Biogas Composition	15
2.3.3 Effect of Limited Aeration on Other Parameters	16
2.4 Short Run-Through on Sludge Characterization	16
2.4.1 Particle Size Distribution of Sludge	16
2.4.2 Sludge Rheology	17
3 Materials and Methodology	19
3.1 AnMBR: Setup and Operation	19
3.1.1 Bioreactor Design and Setup	19
3.1.2 Membrane Characteristics	20
3.1.3 Feed Preparation	21
3.1.4 AnMBR Operation	22
3.1.5 Limited Aeration	23
3.2 Analytical Tests	24
3.2.1 COD Analysis	24
3.2.2 Nutrients Analysis	25
3.2.3 Volatile Fatty Acids Analysis	25
3.2.4 Particle Size Distribution Analysis	26
3.2.5 Sludge Rheology Analysis	27

3.3	Biodegradability Tests	27
3.3.1	Biomethane Potential Tests	27
3.3.2	Specific Methanogenic Activity Tests	30
3.3.3	Proteins, Carbohydrates and Humic Acid Measurements	31
3.4	Feed Optimization	32
4	Results and Discussions	35
4.1	COD Removal in AnMBR	35
4.1.1	Variation and Stabilization of Influent COD	35
4.1.2	COD Removal in AnMBR	38
4.1.3	Effect of Limited-Aeration on COD Removal	38
4.2	Batch Biodegradability Tests	39
4.2.1	Bio-Methane Potential Tests	39
4.2.2	Fate of Protein in each Batch Assay	42
4.2.3	Fate of Humics in each Batch Assay	43
4.2.4	Fate of Carbohydrates in each Batch Assay	43
4.3	Specific Methanogenic Activity and Inhibition	44
4.3.1	SMA of Non-Aerated Sludge with No Retention of Added Aeration	45
4.3.2	SMA of Non-Aerated Sludge with Retention of Added Aeration	46
4.3.3	SMA of Aerated Sludge - Week 1	48
4.3.4	SMA of Aerated Sludge - Week 2	49
4.3.5	SMA of Aerated Sludge - Week 3	51
4.3.6	Determination of Inhibition	52
4.4	Fate of Nutrients in the AnMBR Before and After the Limited Aeration	54
4.4.1	Fate of Ammonia in the AnMBR	54
4.4.2	Fate of Nitrate in the AnMBR	56
4.4.3	Fate of Phosphate in the AnMBR	56
4.4.4	Fate of Sulphate in the AnMBR	57
4.5	Other Operational Parameters of Reactor	58
4.5.1	Observed Changes in the pH of Reactor	58
4.5.2	Observed Changes in the Oxygen Reduction Potential	59
4.5.3	Observed Changes in the VFA	60
4.5.4	Observed Changes in the Biogas Production	61
4.5.5	Changes in the Particle Size Distribution of Sludge Overtime	62
4.5.6	Changes in Sludge Rheology Overtime	64
4.6	Extended Discussions on The Reactor Performance	65
4.6.1	Batch 1 of Aeration	65
4.6.2	Batch 2 of Aeration	66
4.6.3	Batch 3 of Aeration	66
4.6.4	Discussion Highlights of SMA Test	66
5	Summary and Conclusions	69
6	Limitations and Future Work	73
6.1	Limitations	73
6.1.1	Operations Related	73
6.1.2	Dataset Related	73
6.2	Future Work	74

Bibliography	75
A Appendix-A	83
A.1 BMP Matrix	83
A.2 Influent Feed Optimization	85
B Appendix-B	87
B.1 ANOVA Results.	87

List of Figures

2.1	Carbon and energy comparison in aerobic (above) and anaerobic (below) waste water treatment [1]	7
2.2	Anaerobic Degradation of Polymeric Materials as classified by van Lier <i>et al.</i> , Gujer and Zehnder. Numbers indicate the bacterial groups: 1. Hydrolytic bacteria, 2. Fermentative bacteria, 3. Homo-acetogenic bacteria, 4. Hydrogenotropic methanogens and 5. Aceticlastic methanogens [1–3]	8
2.3	VFA accumulation and pH drop as a result of methanogenic overloading [1]	10
2.4	Change in Gibb’s free energy in terms of H ₂ partial pressure. Negative Gibbs energy change indicates occurrence of a reaction. [1]	11
2.5	COD balance in anaerobic system	12
3.1	Bio-reactor in the AnMBR	19
3.2	Helix PVDF Membrane [4]	20
3.3	Pipeline and Instrumentation Diagram of the Reactor	23
3.4	COD Digesting Oven	24
3.5	Gas Chromatography Machine; measuring Volatile Fatty Acids	25
3.6	Pictorial Representation of PSD Bluewave, depicting laser diffraction	26
3.7	Pictorial Representation of BMP Bottle	28
3.8	Limited Aeration in BMP assays	28
3.9	Pressure build-up managed by opening the headspace to atmosphere	30
3.10	Representation of AMPTS-II from <i>Bioprocess Control</i> [5]	31
3.11	Particles in Feed Tube Responsible for Clogging	32
4.1	COD Concentration in Influent	36
4.2	COD variation: Influent COD Concentration in Feed Bucket and Sampling Valve.	36
4.3	COD variation: Effluent COD Concentration	38
4.4	The Cumulative Methane Produced Over Time of Non-Aerated Sludge for Every Batch with Ovalbumin and Cellulose	40
4.5	The Average Effluent and Sludge Protein Concentration in Each Batch Assay	42
4.6	The Average Soluble and Total Humics Concentration in Each Batch Assay	43
4.7	The Average Soluble and Total Carbohydrates Concentration in Each Batch Assay	44
4.8	The Average SMA Values of Non-Aerated Sludge for Different Air Additions and Without Any Retention	45
4.9	The Cumulative Methane Produced Over Time of Non-Aerated Sludge for Different Air Additions and Without Any Retention	45
4.10	The Cumulative Methane Production of Non-Aerated Sludge for Different Air Additions and Retention of Air Pulses for 20 Minutes.	46

4.11 The Average SMA Values of Non-Aerated Sludge for Different Air Additions and Retention of Air Pulses for 20 Minutes.	47
4.12 The Cumulative Methane Produced for the First Batch of Aerated Sludge for Control and 40ml Added Air Pulse	48
4.13 The Average SMA Values of First Batch of Aerated Sludge for Control and 40ml Added Air Pulse	49
4.14 The Cumulative Methane Produced for the Second Batch of Aerated Sludge for Different Added Air Pulses	50
4.15 The Average SMA Values of Second Batch of Aerated Sludge for Batch with Added Air Pulses	50
4.16 The Cumulative Methane Produced for the Third Batch of Aerated Sludge for Different Added Air Pulse	51
4.17 The Average SMA Values of Third Batch of Aerated Sludge for Different Air Pulses	52
4.18 Comparison of Average SMA for various Aeration for Inoculum, Subjected to Different Aeration Over the Weeks	53
4.19 The Influent and Effluent Ammonium Concentration in the AnMBR	55
4.20 The Influent and Effluent Nitrate Concentration in the AnMBR	56
4.21 The Influent and Effluent Ortho-Phosphate Concentration in the AnMBR	57
4.22 The Influent and Effluent Sulphate Concentration in the AnMBR	58
4.23 pH Variations of the Influent, Effluent and Digester Liquid	59
4.24 ORP Variation in the Reactor	60
4.25 VFA Concentration in the Reactor Liquid	61
4.26 Biogas Composition Monitored Over Time	61
4.27 Reactor Liquid During the Process and When Re-circulation was Stopped	62
4.28 The D90, D50 and D10 PSD of the Reactor Sludge Overtime	63
4.29 Rheogram of Sludge Samples Exposed to Limited Aeration	65

List of Tables

2.1	Gibb’s free energy change for some acetogenic reactions assuming neutral pH and temperature of 25 ° [1].	11
3.1	Membrane Characteristics	20
3.2	Influent Macronutrient Chemical Composition	21
3.3	Micronutrient Chemical Composition [6]	21
3.4	AnMBR Operational Parameters	22
4.1	Average COD Values of Samples Extracted From the Valve	37
4.2	Average BMP of Control and Ovalbumin – Exposed to Different Aerations	41
4.3	Reduction in Activity with DAF Pulses	54
4.4	Percentage Increase of D90, D50 and D10 sizes of the Aerated Batches Corresponding to the Average D90, D50 and D10 Sizes of the Non-Aerated Batch.	64
4.5	Yield Stress of Sludge Samples Exposed to Different Aerations	65
4.6	Reduction of Activity with respect to the Individual Controls	67
A.1	BMP Matrix Providing The Quantity of Sludge and Substrate used, and the Calculated BMP	84
A.2	Influent Macronutrient Chemical Composition - Ozgun <i>et al.</i> ,2013	85
A.3	Micronutrient Chemical Composition [6]	85
A.4	Corrected Influent Composition - Ozgun <i>et al.</i> ,2013	86
B.1	ANOVA Test between the COD Removal Efficiencies in Non-Aerated Sludge and First Batch of Aerated Sludge	87
B.2	ANOVA Test between the COD Removal Efficiencies in Non-Aerated Sludge and Second Batch of Aerated Sludge	87
B.3	ANOVA Test between the COD Removal Efficiencies in Non-Aerated Sludge and Third Batch of Aerated Sludge	87
B.4	ANOVA Test of Cellulose and Ovalbumin with no Aeration	88
B.5	ANOVA Test of Ovalbumin without aeration and Ovalbumin with 0.35% Oxygen Addition	88
B.6	ANOVA Test of Ovalbumin with no Aeration and with 0.76% Oxygen Addition	88
B.7	ANOVA Test of Ovalbumin with no Aeration and with 2.02% Oxygen Addition	88
B.8	ANOVA Test: Control and 15ml Aeration for Non-Aerated Inoculum	88
B.9	ANOVA Test: Control and 40ml Aeration for Non-Aerated Inoculum	88
B.10	ANOVA Test: Control and 60ml Aeration for Non-Aerated Inoculum	89
B.11	ANOVA Test: Control and 40ml Aeration for First Batch of Aerated Inoculum	89
B.12	ANOVA Test: Control and 15ml Aeration for Second Batch of Aerated Inoculum	89

B.13ANOVA Test: Control and 40ml Aeration for Second Batch of Aerated Inoculum	89
B.14ANOVA Test: Control and 15ml Aeration for Third Batch of Aerated Inoculum	89
B.15ANOVA Test: Control and 40ml Aeration for Third Batch of Aerated Inoculum	89
B.16ANOVA Test: Control and 60ml Aeration for Third Batch of Aerated Inoculum	90
B.17ANOVA Test on $NH_4 - N$ Removal Efficiency of Non-aerated batch and Batch with First cycle of Aeration	90
B.18ANOVA Test on $NH_4 - N$ Removal Efficiency of Non-aerated batch and Batch with Second cycle of Aeration	90
B.19ANOVA Test on $NH_4 - N$ Removal Efficiency of Non-aerated batch and Batch with Third cycle of Aeration	90
B.20ANOVA Test on NO_3^- Removal Efficiency of Non-aerated sludge and Sludge with Final batch of Aeration	90
B.21ANOVA Test on $PO_4 - P$ Removal Efficiency of Non-aerated sludge and Sludge with Final batch of Aeration	91
B.22ANOVA Test on SO_4^{2-} Removal Efficiency of Non-aerated sludge and Sludge with Final batch of Aeration	91
B.23ANOVA Test Result Comparing the Methane Composition During the Non-Aerated Batch and Final Batch of Aeration	91

1

Introduction

1.1. Societal Challenge

The world population is constantly increasing with more migration and accumulation in urban centres, especially in developing countries. The United Nations expect the population to increase by 2.1 billion in the urban areas by 2030 [7]. With increase in population, access to clean water and sanitation will be a global concern. With demand for water being so much, we have to look into other alternate sources than polluting and depleting the available resources. The need for water management and water reuse emphasizes us to look into technologies for wastewater treatment. The world bank also insists in improving the access to clean water, sanitation and wastewater reuse through the rural-urban corridors in its Global Monitoring Report 2013 [8]. The reuse of wastewater can be linked to sustainable urban planings, green economies and is considered by various nations as an effort to adapt to climate change, increase food production and security, increase the availability of potable water and optimize industrial and recreational water reuse [9]. The Global Water Intelligence predicated in 2014 that by 2030, there would be an increase in planned reuse of treated municipal wastewater by 271% compared to the 2011 values [10]. According to [Raschid-Sally and Jayakody](#), one-third of globally used tertiary treated wastewater is used in agriculture [11]. [Raschid-Sally and Jayakody](#) studied the wastewater reuse practices in 53 cities of developing countries and summarized the drivers of wastewater use in agriculture as a combination of the following factors:

- Increase of water demand in urban areas and the related return flow of untreated or semi-treated wastewater which pollutes the environment and water bodies which are traditionally used for irrigation.
- Increased food demand in urban environment favouring cultivation in close city proximity where the sources of water are already polluted.
- Lack of alternative and safer water sources. [11].

Hence, we should look into treatment technologies to provide a safer and cheaper alternate to the conventional water sources and alleviate the pressure on resource scarcity and depletion.

1.2. Need for Anaerobic Wastewater Treatment

Municipal wastewater contains valuable resources such as natural organic matter, nutrients (such as nitrogen and phosphorus), and energy in terms of biogas. Municipal wastewater is generally a combination of one or more of the following:

- Domestic wastewater effluent consisting of black-water from toilets and grey-water from kitchen and shower drains.
- Water from commercial buildings such as schools, hospitals, and other institutions.
- Wastewater from industries.
- Storm-water and urban runoff. [12].

Wastewater contains a combination of suspended, dissolved and inert solids. Untreated water when accumulated may go septic and the organic matter in it will decompose causing nuisance. The wastewater also contains nutrients which can enhance the growth of aquatic plants. The pathogenic microorganisms in the water could affect the intestinal track in humans [13]. The wastewater also contains toxic compounds which could be mutagenic and carcinogenic. Hence, wastewater removal and nuisance free treatment has to be done before further reusing or dispersing it into the environment.

Wastewater treatment plants aiming water reclamation, operate with the following steps:

- Pre-treatment or preliminary treatment is done to remove grits and larger chunks of solids such as clothes, paper, plastics, etc.
- Primary treatment which involves sedimentation to remove suspended particles (organic and inorganic) using settling tanks, septic tanks, Imhoff tanks etc.
- Secondary treatment which involves degradation of organics through biological processes (using bacteria). These are either aerobic or anaerobic. Treatments such as aerated lagoons, constructed wetlands, activated sludge systems, trickling filters fall into this category.
- Tertiary treatment which involves effluent polishing and nutrient recovery before discharging the effluent. Tertiary treatment may include membrane filtration, activated carbon, disinfection.
- Advanced treatment may be done after the normal biological treatment for further removal of dissolved and suspended materials to meet the requirements depending on applications. [12, 13].

As we see that there is a higher usage for the treated water in the agricultural sector, it would be a better option to opt for technologies which not only provide good quality water but also nutrients to the soil. McCarty in 1964 stated that the anaerobic system is in many ways ideal for wastewater treatment [14]. Anaerobic biotechnology is considered to be a sustainable approach, since it combines waste management with recovery of renewable bio-energy and other useful bioproducts [15].

Anaerobic digestion is defined as the fermentation process where the organic material is degraded and biogas comprising of mostly methane and carbon dioxide is

produced [1]. Hence, the use of anaerobic treatment systems could help in alleviating environmental pollution, reducing the pressure on energy demands from fossil fuels, reduced exploitation of natural resources and decreasing the quantity of toxic greenhouse gas emission into the atmosphere [16]. Anaerobic method is desired over conventional aerobic methods because:

- Anaerobic methods can be executed at lower operation costs.
- They consume less energy and produce biogas which can be profitably used.
- They can be applied at any scale and have very little space constraint.
- The excess sludge produced is very much lesser when compared to the aerobic system and is well stabilized.
- The anaerobic microorganisms can be preserved for long periods without deterioration in their activity [17]; and
- Can be combined with post-treatment techniques to yield useful products such as ammonia and sulphur. [14, 17–19].

Anaerobic technology though having a good set of advantages, also has its disadvantages. [McCarty](#), lists a few such drawbacks

- Anaerobic treatment needs relatively higher temperatures (30° - 35°C).
- Treating dilute wastewater might not provide enough methane for waste heating.
- The rate of growth of methane-producing bacteria is very slow which increases the time period of starting the process. This in turn limits the adjustment to fluctuations in load, temperature and other conditions. [14].

The advantages of anaerobic systems overpower its disadvantages [14]. [Lettinga](#) also tells us that when juxtaposed to aerobic technologies, anaerobic treatment has nothing but advantages [18]. Therefore, this study will further discuss about the anaerobic digestion and related technologies.

1.3. Problem Statement

Anaerobic degradation pathway happens in four successive stages: hydrolysis, acidogenesis, acetogenesis and methanogenesis where organic matter is sequentially degraded by a varied range of micro-organisms [1–3, 14, 20–26]. Hydrolysis is usually considered as the rate-limiting step for the overall digestion process especially for wastewater with high suspended solids/COD ratio [1, 3, 14, 17, 24, 27–32]. Methanogenesis may also be considered as a rate-limiting step as the methane-producing bacteria have a very slow growth rate when compared to acidifying bacteria [1, 14]. The bacterial growth rates in acidifying reactions ($\mu_m = 2/d$) is ten to twenty times the bacterial growth rates of methanogens ($\mu_m = 0.12/d$) [1]. This results in longer time periods for starting the process [14], making biomass retention a key aspect to provide enough Solids Retention Time (SRT) for the methanogens [33].

Anaerobic Membrane Bioreactors (AnMBR) are the innovative solutions to deal with the long adaptation time and variable loading rates [34]. AnMBR is expected to retain slow-growing methanogenic organisms facilitating a higher organic loading rate [33, 35]. Organic loading rate is an important factor which affects the sludge parameters, microbial community, membrane fouling and overall system performance

[36]. SOLRs for low-strength wastewater are in the range of $0.05-0.4 \text{ gCOD/gMLSS.d}$ [34] and SOLRs of 0.9 gCOD/gMLSS.d and more have hardly been tested [36].

Anaerobic digestion (AD) process can be bettered if the rate-limiting steps are enhanced. Enhancement of hydrolysis has been made possible by adding limited amount of air or oxygen to the Anaerobic process. [Botheju and Bakke \[37\]](#), have reviewed published works on the effects of limited aeration in improvement of hydrolysis and biogas quality. In the same report, they have also discussed works which have reported inhibition of methanogenic activities and decreased methane production [37]. The studies involving limited aeration prior to AD, during AD and post AD give us an idea on the amount of oxygen or air that can safely be added to the system. In case of inadequate aeration or too much aeration, there might arise issues which may result in process inhibition or even be lethal to the micro-organisms. In addition to this, there is also a concern in maintaining effluent characteristics and sludge properties. There are very limited studies on aeration in AnMBR and approach to sludge properties in these studies are scarce too. It will be a major concern if there is flocculation in sludge as [Chu et al. \[38\]](#), mentions that with increase in floc size, the mass transfer resistance for reactants increases thus retarding the digestion rate [38]. Thus, the limited aeration could either assist in the enhancement of overall AD process or could be a lethal threat to the methane-producing organisms hindering the entire process depending on the amount of aeration, method of addition and operating parameters. This creates a window for us to study what happens to the AD process with air intrusion, understand the changes in physical properties of the sludge, the changes in the degradation of organics, changes in the effluent nutrient characteristics, shift in microbial community and other changes in the overall AD process.

The research scope for limited aeration in an AD process is wide, the concise problem statement addressed in this study is:

Assessing the impact of limited aeration in the sludge properties (particle size and viscosity) and overall reactor performance (in terms of organics and nutrient removal) of an AnMBR treating synthetic blackwater.

1.4. Research Approach

As stated earlier, this study tries to gain an insight on how the limited aeration impacts the sludge properties, effluent characteristics, biogas composition and overall performance of the AnMBR treating high-strength synthetic blackwater under well-defined experimental conditions. The scope of this study will involve operating an AnMBR with an ultra-filtration membrane with an inside-out flow. The reactor will be operated with laboratory-made synthetic wastewater and blackwater sludge collected from *Nederlands Instituut Voor Ecologie (NIOO-KNAW), Wageningen, The Netherlands*. The aeration values used in the AnMBR will be based on extensive literature. The sludge parameters will be tested based on the Particle Size Distribution analysis which will give us an idea on sludge growth and the rheology will be tested by a rheometer as a function of applied shear rate and responsive shear-stress offered by the sludge. Gas Chromatography analysis will be carried out to determine the biogas composition in the AnMBR and the changes in composition after introducing air. The overall performance of the AnMBR before and after aeration will be studied based on the effluent characteristics (organics and nutrient removal), sludge

rheology, and the biogas composition.

1.5. Research Questions

This report presents an experimental study to see if limited aeration helps in enhancing the overall AnMBR functioning. Hence, the main research question that we aim to answer in this research, as a reflection of the problem statement is:

RQ: How does limited aeration (corresponding to a 2% increase in Oxygen Concentration corresponding to the Sludge VSS), affect the operation of an Anaerobic Membrane Bioreactor Treating Synthetic Blackwater?

This question will be answered by a series of sub research questions

RQ1: What is the effect of the applied limited aeration on the Degradation of Organic Matter?

To know this, the question is further split into more sub-questions such as:

RQ1a: What is the impact of the applied limited aeration on COD removal and Nutrient Cycle?

RQ1b: How does the aeration cycle impact the methanogenic activity and substrate degradation?

RQ1c: What is the change in the Biogas composition due to the applied limited aeration?

RQ2: What is the effect of the applied aeration on the Particle Size of Sludge and the Sludge Rheology, and How does it affect the AnMBR Operation?

The scope of this project aims in understanding the effect of limited aeration in only the AnMBR operations treating synthetic blackwater. Thus, the microbial studies for pathogen removal, low strength wastewater treatment, specific nutrient or pollutant removal have been left as future work.

1.6. Contribution/Result Summary

- The applied aeration of $14.7 \text{ ml air}/L_r/d$ (corresponding to 2% increase of oxygen with respect to the VSS of the sludge), enhanced the COD removal in the AnMBR by 11% when compared to a strictly anaerobic condition.
- The methanogenesis was observed to be inhibited in the initial stages of aeration but the inhibition to the methanogenic activity decreased overtime after the reactor was aerated with $14.7 \text{ ml air}/L_r/d$, indicating adaptability and a better performance of methanogens to the applied aeration.
- Particle size distribution increased by 13% in D90 and 15% in D10.
- Shear stress profile and hence viscosity profile increased with provided aeration.

1.7. Project Workflow and Report Organization

Chapter 2 summarizes the literature that was studied in order to identify the research gap it also summarizes the research works that have been carried out in the field of Anaerobic Digestion and related technologies. Chapter 3 explains the materials and methods that were used in the laboratory, to carry out the experiments. Chapter 4 lists the collected data from the laboratory experiments and discusses the outcome based on the literature. The work is summarized and concluded in Chapter 5. Chapter 6 provides an insight on bottlenecks in the process and provides suggestions to overcome these bottlenecks and suggests scope for future work.

2

Theoretical Background

In this chapter, we brush upon the related theoretical knowledge which was needed to build this research. There is a wide variety of rich literature on wastewater treatment, anaerobic digestion, limited aeration in AD, and related technologies in AD, all of them based on various attributes. In this section of study, only those literature which are most relevant to the problem statement that we intend to address is briefed. In particular, we discuss the theory behind conventional Anaerobic Digestion (AD), works carried out on Anaerobic Membrane Bioreactors, Limited Aeration in AD, Change in Sludge Dynamics with Aeration.

2.1. Anaerobic Digestion - An Overview

Wastewater can be classified into four categories based on their composition as: 1. *High strength and high soluble wastewater*, 2. *High strength and high particulate wastewater*, 3. *Low strength and high particulate wastewater* and 4. *Low strength and high soluble wastewater* [27, 33]. [van Lier et al.](#), compares the fate of carbon and energy in aerobic and anaerobic systems. Figure. 2.1) [1].

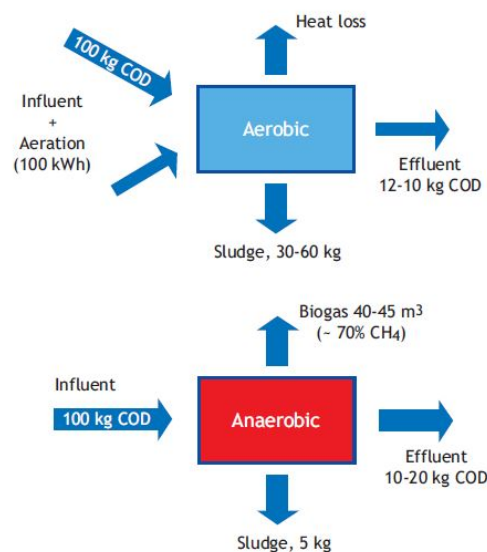

Figure 2.1: Carbon and energy comparison in aerobic (above) and anaerobic (below) waste water treatment [1]

It can be interpreted from figure 2.1 that for the same influent characteristics, anaerobic system does not need additional energy in terms of aeration and it also produces valuable biogas. The volume of sludge generated is also considerably less, making the main focus of this research in AD.

van Lier *et al.*, state that AD can be considered one of the oldest technologies used since the 19th century, for stabilizing waste and wastewater [39]. AD saw an increased usage after the energy crisis in 1970s and has matured in usage since then [39]. The AD process is a complex food-web where a variety of micro-organisms jointly convert and mineralize the complex organic polymeric matter into methane (CH_4), carbon dioxide (CO_2), ammonium (NH_3), hydrogen sulphide (H_2S) and water (H_2O) [1] as depicted in Figure. 2.2. The total organic degradation can be measured based on the Chemical Oxygen Demand(COD) (generally approximated by dichromate) [2]. COD gives an estimate of the organic concentration based on oxygen depletion from bacterial action [40]. van Lier *et al.*, mention that there is only COD conversion and no COD destruction [1]. The methane being highly water-insoluble, bubbles out contributing in COD removal [1, 2, 14, 41].

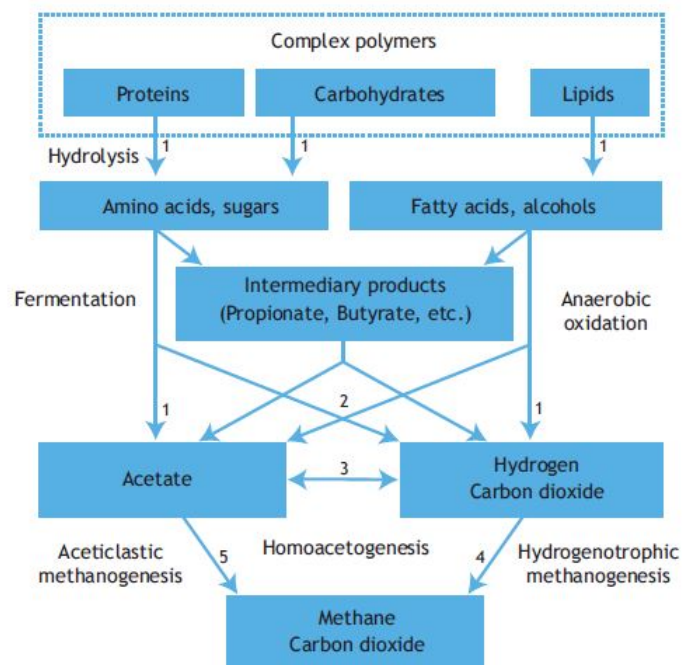

Figure 2.2: Anaerobic Degradation of Polymeric Materials as classified by van Lier *et al.*, Gujer and Zehnder. Numbers indicate the bacterial groups: 1. Hydrolytic bacteria, 2. Fermentative bacteria, 3. Homo-acetogenic bacteria, 4. Hydrogenotropic methanogens and 5. Aceticlastic methanogens [1–3]

The process happens in four successive stages 1. *Hydrolysis*, 2. *Acidogenesis*, 3. *Acetogenesis* and 4. *Methanogenesis* [1–3, 14, 20–26]. van Lier *et al.*, Gujer and Zehnder, classify the process further as:

1. Hydrolysis of bipolymers, which involves:
 - (a) Hydrolysis of Proteins
 - (b) Hydrolysis of Carbohydrates/Polysaccharides and
 - (c) Hydrolysis of lipids/fats

2. Acidogenesis involves:
 - (a) Fermentation of long chain fatty acids and alcohols
 - (b) Fermentation of sugars and amino acids
3. Acetogenesis involves:
 - (a) Anaerobic oxidation of intermediate volatile acids (particularly VFAs) into acetate and H_2 .
 - (b) Formation of acetic acid from CO_2 and H_2 .
4. Methanogenesis involves:
 - (a) Conversion of acetate to methane.
 - (b) Conversion of hydrogen and carbon dioxide to methane [1–3].

2.1.1. Hydrolysis

The bacterial community cannot take up the particulate organic materials as such. Thereby, it has to be broken down into soluble polymers or monomers for consumption [2, 3, 22, 25]. Hydrolysis is a surface phenomenon where the organic polymers are degraded through action of exo-enzymes [1, 23, 42, 43]. This degradation breaks down the particulate organic matter into smaller fragments which can cross the cell membranes to be consumed by micro-organisms [1, 2, 14]. During this enzymatic action, the proteins are hydrolyzed to amino acids, polysaccharides are degraded to simple sugars and the lipids are converted to long chain fatty acids (LCFA) [1, 3, 14, 22, 37, 43]. The products of hydrolysis are the substrates for acidogenic bacteria as the enzymatic action provides monomeric or dimeric compounds, which can be readily consumed by them [1, 2]. Hydrolysis is generally considered as the rate-limiting step in anaerobic digestion, especially with semi-solid substrates and high particle wastewater [1, 3, 14, 17, 24, 27–32]. It is also very sensitive to temperature and temperature fluctuations [1]. This rate limitation is not due to the lack of enzymatic activity but due to the lack of freely accessible surface area of the particles and substrate structure [1, 3]. The most important hydrolytic enzymes are cellulase, amylase, protease and lipase and these are produced by the acidogenic bacteria [43] and the main biopolymers converted are proteins, carbohydrates and lipids [1].

2.1.2. Acidogenesis

Hydrolysis and acidogenesis are the dominant processes in an anaerobic reactor [3]. Acidogenesis is a common reaction carried out by hydrolytic and non-hydrolytic organisms [1]. In this process, the dissolved compounds (the products of hydrolysis) present in the cell membranes of the fermentative bacteria, are further fermented or anaerobically oxidised to simpler products such as VFAs, alcohols, lactic acid, CO_2 , H_2 , NH_3 and H_2S . This also helps in formation of new cell material [1, 3, 29, 44]. Acidogenic biomass is assumed to build up on the soluble products from hydrolysis [1, 3, 44]. van Lier *et al.*, mention that the types of products formed from acidogenesis depends on the type of reactor medium [1]. It is also mentioned that with H_2 scavenging organisms such as methanogens, acetate will be the main end product. If methanogenesis is retarded, then more reduced products such as propionate, butyrate, lactate may be produced. [1]. Acidogenesis is the quickest of all conversion steps in the anaerobic digestion process [1]. They have better growth rate compared to methanogens [1, 14, 34] where the bacterial growth rate being twenty times that

of methanogens [1]. This fast growth rate results in souring, where the high acid production leads to a significant drop in pH. This increases the concentration of non-dissociated VFAs, which inhibit the methanogens, which in turn increases the VFA accumulation and thus resulting in a loop as depicted in Figure. 2.3. [1].

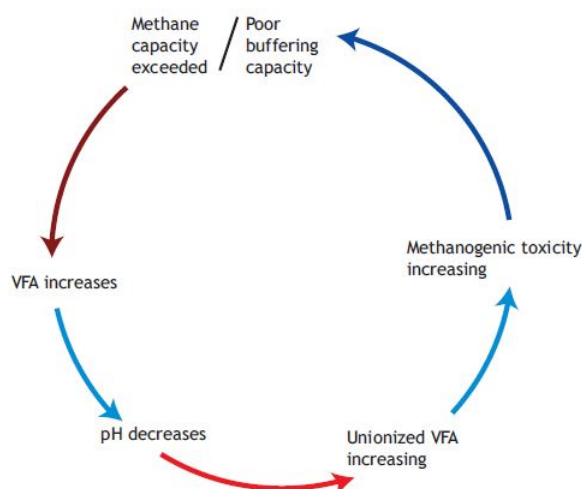

Figure 2.3: VFA accumulation and pH drop as a result of methanogenic overloading [1]

The acidifiers can function even at pH less than 4, meaning the souring can occur when the methanogenic capacity of the system is trespassed [1].

2.1.3. Acetogenesis

The now produced short chain fatty acids (SCFA), is converted to acetate, hydrogen gas and carbon dioxide by the acetogenic micro-organisms [1]. Butyrate, propionate, lactate, ethanol, methanol, H_2 and CO_2 are homogenitically converted to acetate as shown in Figure. 2.2. The main acetogenic substrates are butyrate and propionate. [1]. Acetogenic bacteria produce hydrogen and hence their metabolism is inhibited by hydrogen [1]. The hydrogen consuming methanogenic bacteria evens out the hydrogen balance in their environment creating syntropic associations [1]. Methanogens rapidly utilize molecular hydrogen resulting in a hydrogen partial pressure below 10^{-4} atm, which ensures the occurrence of acetogenic reactions (Figure.2.4) [1, 2].

2.1.4. Methanogenesis

The last step in the anaerobic food chain is methanogenesis [1–3]. In this process, the fatty acids are further broken down into biogas consisting methane and carbon dioxide [1, 14]. Acetoclastic methanogens convert acetate to biogas and hydrogenotrophic methanogens convert hydrogen and carbon dioxide to biogas [1, 2]. The methanogenic bacteria plays a vital role in the digestion process. The acetogenic reactions from ethanol, butyrate, propionate and palmitate is not feasible in normal conditions as the Gibb's free energy for such reactions is positive as shown in Table 2.1. In such cases, the methanogenic bacteria and sulphate reducing bacteria maintain a very low hydrogen partial pressure, in the order of 10^{-4} atm to 10^{-6} atm [1, 2]. This happens to due to the rapid uptake of hydrogen by these organisms. Under these conditions, a syntropic association happens between hydrogen producing acetogens and hydrogen scavenging methanogens yielding energy for acetogens as shown in Figure. 2.4 [1].

Table 2.1: Gibb's free energy change for some acetogenic reactions assuming neutral pH and temperature of 25 ° [1].

Compound	Reaction	ΔG° (kJ/mol)
Lactate	$\text{CH}_3\text{CHOHCOO}^- + 2 \text{H}_2\text{O} \longrightarrow \text{CH}_3\text{COO}^- + \text{HCO}_3^- + \text{H}^+ + 2 \text{H}_2$	-4.2
Ethanol	$\text{CH}_3\text{CH}_2\text{OH} + \text{H}_2\text{O} \longrightarrow \text{CH}_3\text{COO}^- + \text{H}^+ + 2 \text{H}_2$	+9.6
Butyrate	$\text{CH}_3\text{CH}_2\text{CH}_2\text{COO}^- + 2 \text{H}_2\text{O} \longrightarrow 2 \text{CH}_3\text{COO}^- + \text{H}^+ + 2 \text{H}_2$	+48.1
Propionate	$\text{CH}_3\text{CH}_2\text{COO}^- + 3 \text{H}_2\text{O} \longrightarrow \text{CH}_3\text{COO}^- + \text{HCO}_3^- + \text{H}^+ + 3 \text{H}_2$	+76.1
Methanol	$4 \text{CH}_3\text{OH} + 2 \text{CO}_2 \longrightarrow 3 \text{CH}_3\text{COO}^- + 2 \text{H}_2\text{O}$	-2.9
Hydrogen- CO_2	$2 \text{HCO}_3^- + 4 \text{H}_2 + \text{H}^+ \longrightarrow \text{CH}_3\text{COO}^- + 4 \text{H}_2\text{O}$	-70.3
Palmitate	$\text{CH}_3(\text{CH}_2)_{14}\text{COO}^- + 14 \text{H}_2\text{O} \longrightarrow 8 \text{CH}_3\text{COO}^- + 7 \text{H}^+ + 14 \text{H}_2$	+345.6

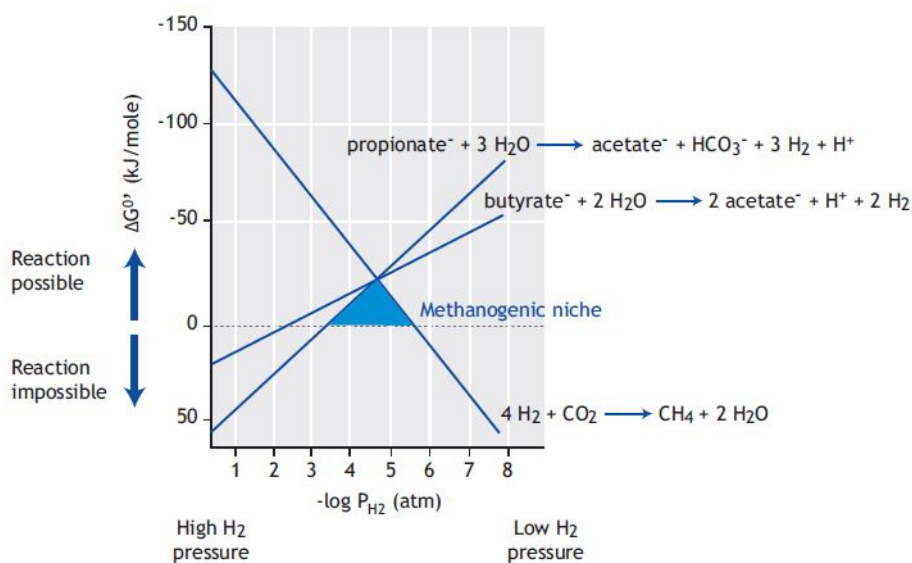
Figure 2.4: Change in Gibb's free energy in terms of H_2 partial pressure. Negative Gibbs energy change indicates occurrence of a reaction. [1]

Methanogens are said to have a very narrow range of substrate spectrum. Some can survive only with strict substrates such as acetate, methylamines, methanol, formate, hydrogen and carbon dioxide [1]. About 70% of the conversion processes happens through the acetoclastic methanogens and the rest by the hydrogenotropic methanogens [1, 2]. Buswell and Mueller also confirm this saying that the predominant methane producing mechanism is by simple decarboxylation of acetic acid [45]. As mentioned earlier, the growth rate of methanogens and especially the acetoclastic

methanogens is very low ($\mu_m = 0.12/d$), resulting in a doubling time of more than seven days [1]. This is one of the main reasons why starting up an anaerobic system is very slow [1, 2, 14]. The hydrogenotrophic bacteria on the other hand grow faster than acetoclastic bacteria and have a doubling time of 4-12 hours [1]. Due to this feature, the anaerobic system have very high stability under varying conditions [1].

2.1.5. Methane Production and COD Balance

Wastewater contains a variety of soluble and insoluble organic compounds which are impossible to be quantified individually. These organic pollutants in water can be classified based on solubility or biodegradability. Based on biodegradability by strong oxidizing agents, the organics can be tested by Biochemical Oxygen Demand (BOD) or Chemical Oxygen Demand (COD) tests. The BOD value is more closer to biodegradability since it represents the amount of oxygen required by aerobic organisms to oxidize the organic pollutants [1]. The COD also represents the amount of oxygen needed to oxidize the organics but it represents the quantity of chemicals that are added to oxidize the compounds [1]. Since not all organics are readily biodegradable and some organic substrates are needed for cell synthesis, BOD value is lower than the COD value [1]. COD is the most preferred method of quantifying organics, as almost all of the organics are degraded (to CO_2 and H_2O) [1]. The fate of organics (as COD) is represented in Figure. 2.5.

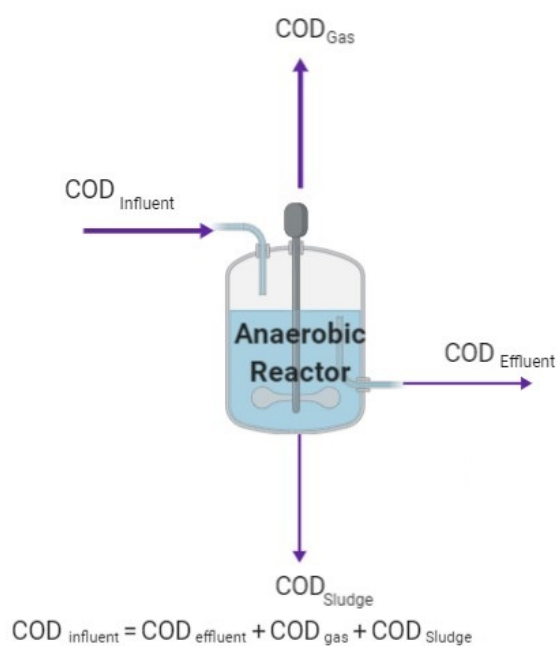

Figure 2.5: COD balance in anaerobic system

van Lier et al. state that unlike in the aerobic process, the COD is not destroyed but merely converted to different forms [1]. Some part of the organics are used up for cell synthesis and the treated effluent contains traces of COD, leaving the rest of the COD in biogas as (CH_4 and CO_2) [1]. Hence, the COD is balanced as shown in Figure. 2.5. As the anaerobic biomass growth is slow, only tender mercies of organics are used for cell synthesis and a larger fraction is used to produce biogas [14]. Methane from biogas can be extracted to produce energy for Combined Heat and Power (CHP) systems [1, 14, 41]. *van Lier et al.* mention that CO_2 is less in the

biogas because,

a) CO_2 is relatively more soluble in water; and

b) a part of CO_2 is chemically bound as organic compounds in the water phase [1].

Equation 1 by Buswell and Mueller, can be used to theoretically predict the methane in the gas phase, if the substrate composition is known [45].

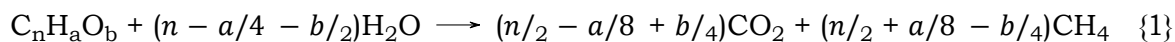

As mentioned earlier, if the chemical composition of the substrates are known, the amount of methane produced can be predicted. As we can see from Figure. 2.1, almost 70% of influent COD is converted to methane. But this value is not seen in practice because of the presence of alternate electron acceptors such as nitrate, sulphate, sulphide and iron [1].

2.2. Anaerobic Reactors - Basics and Related Works

After brushing on the Anaerobic Digestion process, this section of the chapter will briefly discuss the reactor technologies that are in the treatment process, and shed some light on the Anaerobic Membrane Bioreactors (AnMBR). Anaerobic reactors have lower nutrient requirements than the aerobic systems and the bio solids produced in an anaerobic system are much lesser and already stabilized for land application [46]. Hence, the size of the anaerobic reactors are smaller than the aerobic ones.

2.2.1. Evolution of High-Rate Anaerobic Reactors

Anaerobic systems were used as early as in the 19th century with the invention of Imhoff tank when Karl Imhoff stabilised solid sediments in a single tank [1]. In the same decade, other scientists such as Buswell, Hatfield, W.D. Scott Moncrieff, used anaerobic technology to treat industrial wastes and liquid wastes [1, 46]. van Lier *et al.*, refer to these systems as low rate anaerobic systems since they do not have any feature to highlight the catabolic capacity [1]. As mentioned by van Lier *et al.*, a high-rate reactor is the one in which the biomass retention and liquid retention are separate [1]. This enables high biomass concentration, high COD loading, long Sludge Retention Times (SRT) and relatively low Hydraulic Retention Times (HRT) [1]. G.J. Stander in 1950s was one of the responsible people behind the creation of hybrid reactors where he separated the anaerobic bacteria from the effluent stream and retained it in the reactor [46]. van Lier *et al.*, provides the following conditions for an anaerobic hybrid reactor to treat specific wastewater with high loading rates.

- Reactor should have a high retention of active biomass during operation.
- Sufficient contact between the active biomass and the wastewater such that all of the sludge gets sufficient substrate. The sludge which is deprived of substrates is of little value.
- Reaction rate and transport kinetics should be high. That is, the accessibility of organisms inside a biofilm should be high.
- Prevailing environmental conditions should be favourable for all organisms under all operational conditions. [1].

McCarty tells us that Taylor used the first large-scale anaerobic filter system in 1972, which used a biofilm to retain the micro-organisms uncoupling it from the

effluent stream [46]. Further application of the biofilm process was extended as expanded bed reactor by Switzenbaum and Jewell in 1980 [46]. This expanded bed was designed to be used in an upflow filter bed composed of small light-weight particles to treat low-strength wastewaters [47]. This system was suited well to treat low-strength waste waters because of larger retention of micro-organisms and little bio clogging. [46, 47]. McCarty also tells us that the Upflow Anaerobic Sludge Blanket (UASB) reactors by G. Lettinga was the most successful in terms of treating industrial and municipal wastewaters [46]. The sludge retention in these types of reactors have been designed based on having easily settling sludge aggregates and internal Gas-liquid-solids separation system (GLSS) [1]. The expanded granular sludge bed (EGSB) and fluidized bed (FB) reactors are said to be the second generation reactors to deal with high organic loading (exceeding $30\text{-}40\text{ kg/m}^3\cdot\text{d}$) [1]. EGSB and FB reactors have a higher range in treatment and can treat waters which cannot be treated by the UASB systems such as cold waters ($<10^\circ\text{C}$), water with high LCFA (Long Chained Fatty Acids) content and wastewater with foaming problems [1].

2.2.2. Brief Summary on Anaerobic Membrane Bioreactors

Anaerobic treatment being poor in substantial nutrient removal, is coupled with the membrane to remove and recover the nutrients, especially before discharging into nutrient sensitive watersheds [34, 48]. Every author has his/her own benefits listed when it comes to AnMBRs. Liao *et al.* tell us that AnMBRs are used to treat high particulate wastewaters [33]. Berube *et al.*, mentions that the AnMBRs can treat low-strength wastewaters in low cold temperatures [19]. van Lier *et al.*, points out that the AnMBRs are used in extreme conditions when the water is toxic, has high salinity or has high temperature, these conditions are generally found in industrial wastewaters [1]. Membrane bioreactors are said to be considered when the other established technologies fail [1]. Membrane bioreactors are also said to have high effluent quality, without any suspended solids and have a reduced footprint [34, 49]. In the recent years, Membrane Bioreactors have been successfully used to treat industrial and domestic wastewaters [34, 50]. AnMBRs are known to use lesser energy than their aerobic counterparts whilst providing the same benefits [34].

The purpose of using a membrane unit is to uncouple the SRT from the HRT and retain active biomass in the reactor [19, 33, 34, 49]. AnMBRs can be classified into three types based on the placement of membranes in the reactor; namely, external cross-flow reactor, internal submerged reactor and external submerged reactor [33]. The external cross-flow membrane reactor is driven by pressure where the permeate flows out of the membrane due to a cross-flow velocity, and the retentate is recirculated inside the reactor [33, 34]. The submerged membrane reactors are operated by vacuum where the permeate is sucked from a submerged membrane. The membrane can be submerged inside the main reactor or in an external chamber known as the internal and external submerged membrane reactors respectively [33, 34]. Studies done prior, have used membranes in form of flat-sheets, tubular and hollow fibres [34]. Despite the material of use or the operation of membrane, membrane fouling will control the usage of this technology.

Membrane treatments in wastewater treatment are subjected to fouling by cake formation, and can extract problem ions such as nitrate ions and ions associated with salinity and hardness, which could be the major limitation of membrane technology [34, 49, 51]. Optimal operation conditions must be determined for a specific membrane product and treatment method [19, 49]. Berube *et al.* tell us that the char-

acteristics of the wastewater sludge will also impact the operation of a membrane. Operating criteria such as specific organic loading rates, temperature, SRT and HRT can significantly affect the working of a membrane [19]. Hence while choosing the design parameters, one should consider both in-terms of biological component optimization and membrane flux optimization [19].

2.3. Limited Aeration in Anaerobic Digestion

Micro-Aeration has a broader meaning in the literature. One study refers this as an aerobic reactor with low oxygen concentration, whereas other study describes it as an anaerobic system with trace amounts of supplied oxygen. In terms of oxygen reduction potential (ORP), micro-aeration is defined as the condition where limited consumption of oxygen in a system causes a limited increase in the ORP [52]. In this study we refer to this as *limited aeration* to avoid any misunderstanding. The presence of limited amounts of oxygen in anaerobic environments is not always fatal for the anaerobic organisms. Positive effects of limited aeration in anaerobic digesters have been reported by various authors. *Kato et al.*, mention that even in the absence of facultative substrates, the methanogens had tolerance to the supplied oxygen [53]. Improvement of methanogenic activity for limited aeration conditions over strictly anaerobic conditions have also been observed by *Zitomer and ShROUT* [54]. This section of the chapter will focus on various similar studies conducted on the limited aeration of anaerobic reactors.

2.3.1. Effect of Limited Aeration on Hydrolysis

Limited Aeration is said to increase the rate of hydrolysis especially when the substrate is refractory organics [55]. When the limited aeration had been provided as a pre-treatment prior to the Anaerobic Digestion (AD) process, the hydrolysis of non-readily degradable substrates had been noticeably improved. *Fu et al.*, observed an improvement in hydrolysis and reduced lag-phase in fermentation in a thermophilic anaerobic treatment of corn-straw [25]. Similarly, *Nguyen et al.*, observed an enhancement of hydrolysis and acidification while treating municipal solid waste [56]. *Zhu et al.*, noticed in their study that hydrolysis was dependent on the limited-aeration provided [42]. They studied the enhancement of hydrolysis of vegetable and flower wastes and noticed that insufficient aeration led to a decreased hydrolysis. *Ahn et al.*, noticed that while treating domestic sewage, using limited aeration as pre-treatment resulted in higher hydrolysis [30]. *Mshandete et al.*, noticed that the highest hydraulic activity of enzymes at 9 hours of pre-aeration [57]. *Khongsumran et al.*, used a CSTR to treat Cassava residue in wastewater and noticed that there was 62.5% of hydrolysis improvement on adding a limited aeration of $3 \text{ mlO}_2/L_R/d$ [58]. *Diaz et al.*, observed no significant improvement in hydrolysis while applying $5 \text{ mlO}_2/L_R/d$ to a 19d batch assay degrading cellulose [59].

2.3.2. Effect of Limited Aeration on Biogas Composition

Some cases have reported an increase in methane yield whilst using limited aeration prior to the treatment. *Fu et al.*, reported an increase in the methane yield by 16.24% while treating corn-straw, when he used $5 \text{ mlO}_2/gVS$, under thermophilic conditions [25]. *Nguyen et al.*, reported that the biogas production were doubled on using limited aeration when treating municipal solid wastes [56]. *González-González and Cuadros*, experimented pre-aeration while treating olive mill wastewater and had reported that the limited aeration helped in the degradation of polyphenol compounds

and aided in doubling the biogas composition [61]. Zhou *et al.* observed instigation of sulphide oxidation and hydrogen sulphide removal thereby enhancing the biogas quality [62]. Ahn *et al.* observed 25% increase in methane yield while aerating the system treating sewage sludge with $0.05 L_{air}/L_R/\text{min}$ for 24 hours [30]. Ramos *et al.* observed increase in desulphurisation in the headspace of the reactor in all applied doses of oxygen [63]. Lim and Wang, reports and increase in methane yield of 21% in a batch test performed with pre-aerated inoculum [31].

And a few other cases have reported decrease in methane yield or no improvement in methane yield whilst using limited aeration prior to the treatment. Kusch *et al.*, observed that while treating horse dung with straw bedding, pre-aeration reduced the methane production by 18% [64]. Botheju *et al.* observed a proportional decrease in methane production with increase in introduced oxygen concentration [65]. Jenicek *et al.* noted that the methanogenic activity reduced in the reactors after providing aeration with low sulphide concentrations.

2.3.3. Effect of Limited Aeration on Other Parameters

In their study about oxygen effects in handling hydraulic instability of anaerobic reactors, Ramos and Fdz-Polanco, observed that oxygen increased the stability of the system and they managed to stabilize during hydraulically overloaded conditions [67]. Botheju *et al.* also observed that the reactor performance was stable and VFA concentration was less, when the reactor was aerated [65]. Jenicek *et al.*, conclude in their study that limited-aeration did not deteriorate the digestion in overloaded systems [52]. Ahn *et al.*, also observed that the siloxane concentrations in the sludge reduced by 40% [30]. Zhou *et al.* noted a removal of 80% COD after aeration, compared to 40% COD removal prior to aeration [62]. Jenicek *et al.* noted that the sulphide oxidizing organisms showed more activity in the reactor with limited aeration than the anaerobic reactor [66]. Lim and Wang reported that the provided limited aeration, enhanced the conversion of short-chain fatty acids (SCFAs), to acetic acid [31]. It is also reported in their study that the effect of limited aeration depends upon the nature of inoculum used [31].

2.4. Short Run-Through on Sludge Characterization

The physical properties of the sludge play an important role in sludge treatment and transportation. The physical properties examined in this study involves the total solids concentration, total suspended solids concentration, concentration of volatile solids and volatile suspended solids in the sludge, the particle size distribution of the inoculum and the rheological properties of the sludge.

2.4.1. Particle Size Distribution of Sludge

Particle size indicates the quality of effluent and influences other physical properties of the sludge such as the flow and compaction of the liquid. It is said that the higher and more defined the particle, the easier the flow and with a lesser particle size, the viscosity increases [68]. Irregularly shaped particles are better measured with image analysis as it provides a varied size distribution from smallest to biggest dimensions. An image analysis can provide results based on the number of particles detected, projected area using the smallest and longest diameters and an equivalent spherical diameter [68].

2.4.2. Sludge Rheology

Rheology can be described as the study of particle deformation under stress [69]. Rheology of a fluid is a physical property which can be analysed and used in design of treatment plants [70]. Rheological measurements are essential in designing pipelines and without having knowledge on rheology could lead to miscalculation of flow regimes and pressure drops across the pipeline [69, 71].

In case of Newtonian fluids, the shear stress τ is linearly proportional to the shear strain γ , hence a rheogram drawn would yield a straight line through the origin [69]. In case of non-newtonian fluids such as the sludge, the relationship between the shear stress and shear strain (or shear rate) is non-linear and can be represented by a number of equations as mentioned below.

$$\tau = K.\gamma^m \quad (2.1)$$

$$\tau = \eta_{\infty}.\gamma + K.\gamma^m \quad (2.2)$$

$$\tau = \eta_Y^b + \eta_B.\gamma \quad (2.3)$$

$$\tau = \eta_Y^{hb} + K.\gamma^m \quad (2.4)$$

$$\sqrt{\tau} = \sqrt{\tau_Y^c} + \sqrt{\eta_c.\gamma} \quad (2.5)$$

Equation 2.1 is known as the Ostwald equation or the Power law equation and Equation 2.2 is known as the Sisko equation. Both of them are operated with a consistency index (m) less than 1. Here, with increase in the shear strain, the viscosity decreases [69]. The Bingham equation (2.3), Herschel-Buckley equation (2.4) and the Casson equation (2.5), are used for plastic models. In such conditions, a well-defined yield stress τ_Y should be achieved before the flow begins [69]. The applied stress should be more than the yield stress to break the Van-der Waals force offered between the flocs themselves [69].

The rheology of a liquid is measured using rheometers. The most commonly used rheometers are classified into rotational rheometers and capillary rheometers [72]. The usage, advantages and disadvantages of each methods are explained by Seyssiecq *et al.* [69]. As mentioned by Radhakrishnan *et al.* [72], the rotational rheometer is more frequently used in current years for rheological measurements of sludge.

3

Materials and Methodology

This chapter will provide information on how the experiments were carried out. This chapter will thus describe the methods and the equipment used to carry out the experiments; so that the tests, if needed, may be reproduced.

3.1. AnMBR: Setup and Operation

In order to answer the research questions stated in Section 1.5, an AnMBR was set-up and operated under anaerobic conditions and limited aeration was later introduced. The following sections will describe about the setup and operation in detail.

3.1.1. Bioreactor Design and Setup

The AnMBR was designed as an external cross-flow membrane bio-reactor. The bioreactor, was designed with 7 litre capacity as represented in Figure 3.1. The reactor had been designed as a double-walled glass reactor where the outer cell acted as a water-bath to maintain the reactor temperature. The top portion in the reactor contained 7 ports, each with a diameter of 14mm and served a definite purpose.

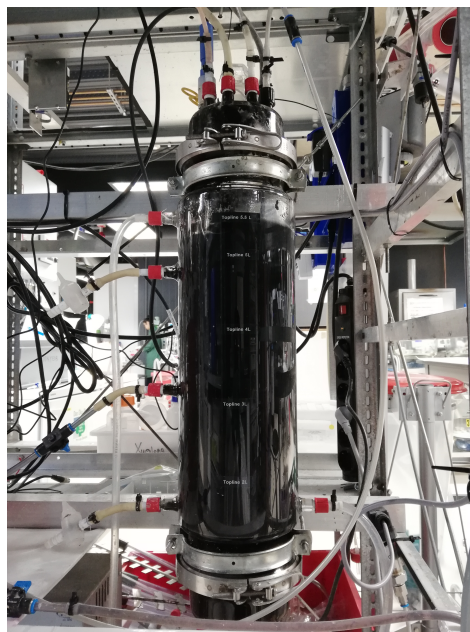

Figure 3.1: Bio-reactor in the AnMBR

Three sampling points on the side of the reactor, as seen in the Figure 3.1, were also made available. These openings were used to de-sludge the reactor and collect samples. All the ports and openings of the reactor were sealed air-tight using DOWEX silicon adhesive. Thus the setup was maintained anaerobic, without any air intrusion.

3.1.2. Membrane Characteristics

The membrane used in this study is a Reinforced PVDF membrane from *Pentair*. The hollow tubular helix membrane was operated with an inside out flow. The membrane used was ultra-filtration membrane, with an average pore size of 30nm. The membrane could handle maximum feed pressure of 800 kPa and a maximum permeate pressure of 450 kPa. The membrane could safely operate under a Trans-Membrane Pressure (TMP) of -100 to 500 kPa.



Figure 3.2: Helix PVDF Membrane [4]

The membrane depicted in Figure 3.2, was contained in a sealed glass tube with three openings. The top and bottom openings were connected to the bio-reactor and re-circulation pump respectively. The cross-flow through the membrane yielded the permeate, which was pumped out using a permeate pump through the third opening. The membrane unit was also made air-tight.

Table 3.1: Membrane Characteristics

Membrane Characteristics		
Parameter	Value	Unit
Pore Size	30	nm
Brand	Pentair	
Type	Tubular,	Inside-Out
Diameter	5.2	mm
Length	640	mm
Cross-Sectional Area	2.1e-5	m ²
Membrane Area	0.01	m ²
Cross-Flow Velocity	0.6	m/s

The membrane characteristics are tabulated in Table 3.1. The membrane unit by itself runs 1m long with 30mm connections for the feed and permeate outlets. The outlets were shortened to 8mm openings using *Festo* connections.

3.1.3. Feed Preparation

The influent feed used in this study was a laboratory made synthetic black water. The composition of the feed was altered slightly from [Ozgun *et al.*, 2013](#). The feed used depicted blackwater with an average COD of 5g/l. Table 3.2 and Table 3.3, show the chemical composition of the influent feed and corresponding micro-nutrient solution used respectively.

Table 3.2: Influent Macronutrient Chemical Composition

Macronutrient Solution		
Chemical	Unit	Amount
Urea	mg/l	1000
Ammonium Chloride	mg/l	800
Sodium Acetate Trihydrate	mg/l	2600
Potassium Phosphate Monobasic	mg/l	200
Calcium Chloride Dihydrate	mg/l	350
Cellulose	mg/l	1500
Milk Powder	mg/l	600
Yeast Extract	mg/l	500
Fulvic and Humic Acid	ml/l	0.2
Sunflower Oil	drops/l	2
Micronutrients	ml/l	10.64

Table 3.3: Micronutrient Chemical Composition [6]

Micro Nutrient Solution		
Chemical	Unit	Amount
Iron(III) Chloride Hexahydrate	mg/l	1000
Cobalt(II) Chloride Hexahydrate	mg/l	100
Manganese(II) Chloride Tetrahydrate	mg/l	250
Copper(II) Chloride Dihydrate	mg/l	15
Zinc Chloride	mg/l	25
Boric Acid	mg/l	25
Ammonium Molybdate Tetrahydrate	mg/l	45
Sodium Selenite	mg/l	50
Nickel(II) Chloride	mg/l	25
EDTA	mg/l	500
Hydrochloric Acid	ml/l	0.5
Resazurin Sodium Salt	mg/l	250
Yeast Extract	mg/l	1000

The components were added in 1 litre of water and blended in a hand-blender for 120 seconds to get a homogeneous mixture. This was diluted to 10 litres and then used as the feed. The dilution is done in order to obtain a feed of 10 litre volume with a COD of 5 g/l.

3.1.4. AnMBR Operation

As stated earlier, the anaerobic bio-reactor was connected to the external side-stream membrane unit through the re-circulation pump. The membrane unit was washed completely with water and the membrane was soaked in citric acid (500ppm) for 12 hours. After connecting the membrane unit and the reactor, the influent, effluent and re-circulation pumps were calibrated for obtaining the desired flow. The influent and effluent pumps were fitted with Marpene Tubings from *Watson Marlow* of 15mm diameter and 2.4mm wall thickness. The re-circulation pump was fitted with Marpene Tubings from *Watson Marlow* of 1.6mm wall thickness and 18mm diameter.

The influent marpene tube was connected to the feed bucket with a transparent *Festo* tube. This was to view the flow inside the tube. The other end of the marpene tube was connected to one of the reactor ports. A sampling point was added in between the pump and the reactor using *Festo* valves. The sampling point was used to measure the influent flow. The flow was monitored everyday and the pump rotations per minute (RPM) was changed when necessary, to maintain the flow at 2.5l/d.

Before adding the seed sludge, the reactor was run for 1 day with tap water to check for leakages. After this, the seed sludge which was got from *NIOO, KNAW, Wageningen* was added to the reactor. The sludge was obtained from a 1 cubic meter anaerobic reactor treating blackwater. The sludge used, had a COD of 8120 g/l with a measured total suspended solids (TSS) as 19.29 g/l and volatile suspended solids (VSS) of 16.87 g/l. The sludge was filled to a volume of 3.5 litres, to maintain an initial specific organic loading rate of 0.63 gCOD/gTSS/d.

Table 3.4: AnMBR Operational Parameters

Parameter	Value	Unit
Inflow	2.5	l/d
Outflow	2.3	l/d
Working Volume	5.5	l
HRT	2.2	days
SRT	27.5	days
COD	5	gCOD/l
vOLR	2.32	gCOD/l.d
sOLR	0.61	gCOD/gMLSS.d
Membrane Flux	9.2	LMH
Re-Circulation Flow	1100	l/d

The reactor operated at a working volume of 5.5 l/d. Initially, feed of 100 mgCOD/d was fed to the reactor and was eventually increased to 5gCOD/d. This was to ensure that the reactor did not suffer from VFA accumulation. A sludge volume of 200ml was collected everyday after the working volume was reached. This allowed to maintain a Sludge Retention time (SRT) of 27.5 days. The membrane was operated at a flux of 9 l/m².h (LMH). RPM of the permeate pump was adjusted to maintain the flow and hence the flux when necessary. Other operational parameters are tabulated in Table 3.4.

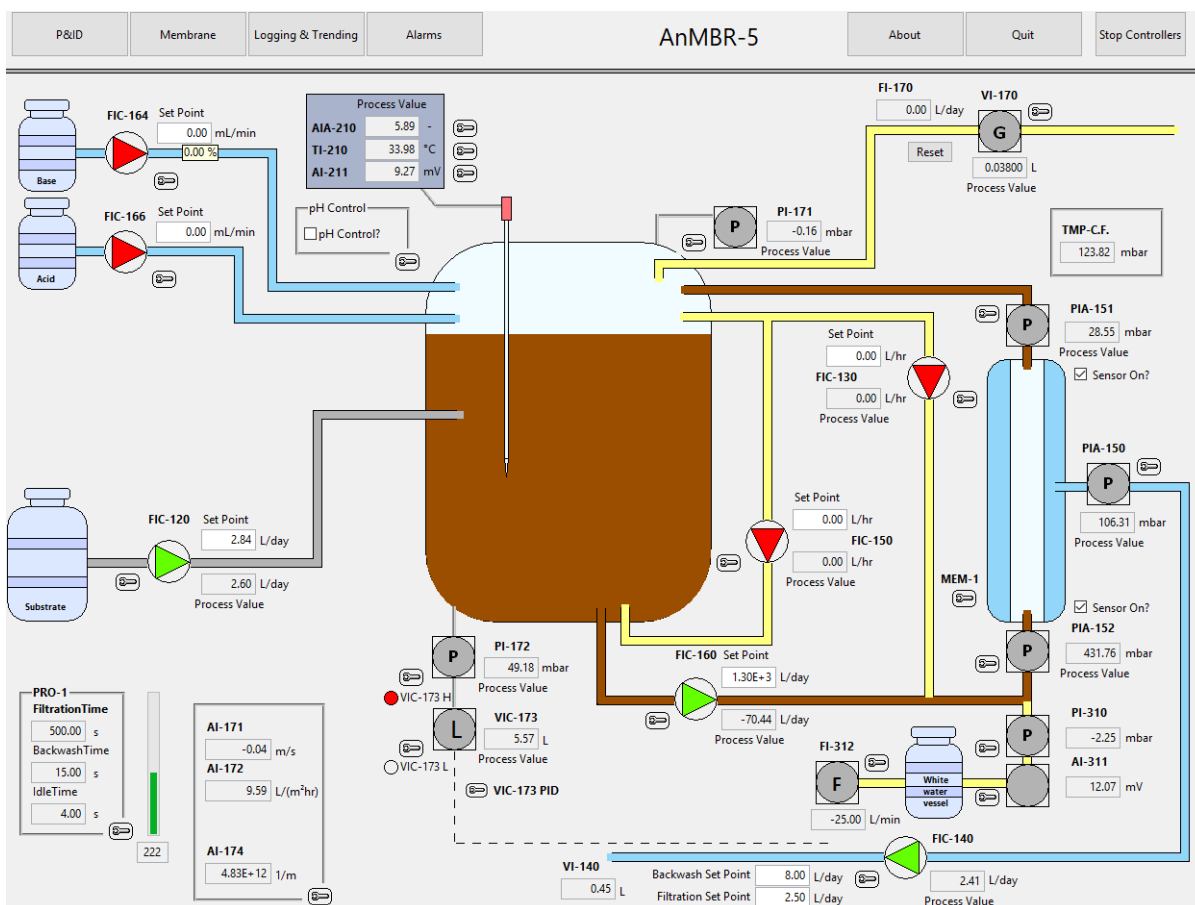

Figure 3.3: Pipeline and Instrumentation Diagram of the Reactor

The AnMBR in this study was operated and monitored for 7 months. The piping and instrumentation diagram (P&ID) of the reactor was made available on the software generated by *CARYA Automatisering, The Netherlands* as represented in Figure 3.3. The reactor operation could be monitored and the pumps could be controlled with the help of this software. The data obtained from the software was logged in the system for every 2 hours. The pH, temperature and ORP were measured by the pH probe and was recorded everyday. The biogas flow through the gas ritter was also recorded everyday. COD was monitored on a daily basis during the anaerobic run of the reactor and then monitored thrice a week after. Nutrients, ammonia, phosphate, nitrate and sulphate were monitored once every 2 weeks.

3.1.5. Limited Aeration

Aeration can be applied as a pre-treatment to the AD process, during AD process or as a post-treatment. In this study, we chose to aerate during the AD process. The AnMBR was run for 2 SRTs without altering the influent characteristics and conditions before the limited aeration was introduced. *Giroto et al.*, [55], studied and compared various scientific works and concluded that an oxygen concentration of $3 \text{ mL O}_2 / \text{L}_R / \text{d}$, was the optimum concentration to have a positive effect on methane production, when the aeration was applied during the AD phase.

An aeration of $14.7 \text{ mlair}/L_R/d$ was applied to represent $3.1 \text{ mlO}_2/L_R/d$. This would contribute to an addition of 2.02% increased oxygen concentration when compared to the VSS of the sludge. The aeration was done in gradual increments so as to not inhibit any process by causing a sudden change in the anaerobic environment.

Thus the aeration was split in a three-cycle increment with each cycle lasting for 3 HRTs. The initial cycles were started by introducing $4.9 \text{ mlair}/L_R/d$ on the first period, $9.8 \text{ mlair}/L_R/d$ on the second period and $14.7 \text{ mlair}/L_R/d$ from period 3 and then on till the end of study. The air was pumped from the atmosphere, to the bottom of the reactor through a diffuser stone, to reduce the size of bubbles. The aeration was done in 3 cycles per day with each cycle consisting 4 hour aeration followed by 4 hours resting time. The time intervals were set in a timer, which would turn the pump on and off for the set intervals.

3.2. Analytical Tests

The study done could be split into two phases. Phase-1 which was considered as the stabilization phase where the reactor was given proper time to stabilize. Phase-2 was the limited aeration phase where the limited aeration in the reactor were added gradually. In order to assess the reactor functioning in the two phases, certain parameters were analyzed. The methods in which they were analysed will be discussed in the following subsections.

3.2.1. COD Analysis

Chemical Oxygen Demand tests were carried out everyday for influent and effluent. The COD of sludge and soluble COD of the influent were also measured to check the COD balance in the system. The COD tests were performed for the influent and sludge with the help of *Hach Lange's LCK014* COD cuvettes for the range 1000-10000 mgCOD/l. For the effluent, *Hach Lange's LCK314* COD cuvettes for the range 15-150mgCOD/l were used. The methods as described in the COD kit were used and the samples were digested in *Hach Lange's LT200* oven for 2 hours at 148°C as shown in Figure 3.4.



Figure 3.4: COD Digesting Oven

Pipette tips were trimmed before sucking the influent and sludge samples so as to not miss particulate matter in the process. After the test procedure, the samples were analysed in spectrometer DR 3900 from *Hach Lange*.

3.2.2. Nutrients Analysis

The nutrients analysed for the study were $NH_4 - N$, $PO_4 - P$, $NO_3 - N$ and SO_4^{2-} . The analysis were done for the influent and effluent samples once in two weeks. The samples were tested using *Hach Lange's kits* and the methods were followed as instructed in the kits. $NH_4 - N$, $PO_4 - P$, $NO_3 - N$ and SO_4^{2-} were tested using LCK303, LCK350, LCK339 and LCK153 kits respectively. After the test procedure, the samples were analysed in spectrometer from *Hach Lange*.

3.2.3. Volatile Fatty Acids Analysis

The VFAs were analysed for sludge and effluent samples. The samples of sludge and effluent were collected everyday and stored at 4°C. The VFAs were tested once every week. The test involved sample preparation where the sludge and the effluent samples were filtered with a 0.45 μm syringe. The filtered samples were diluted to 1:2 ratio by volume with pentanol; 1.5ml of sample was prepared and 10 μl of formic acid was added to each sample in a 2ml glass vial. The dilution was discontinued as there was no VFAs found in either of the samples. A blank was prepared for every three samples. The blank was 1.5ml of demineralized water (DEMI water) and 10 μl of formic acid. The Gas Chromatography (GC) machine as shown in Figure 3.5 was filled with the sample vials. The first and the last sampling vials were blanks and as mentioned earlier, for every three samples there was one blank. This was to ensure that there were no residual VFAs carried over from the previous vials.

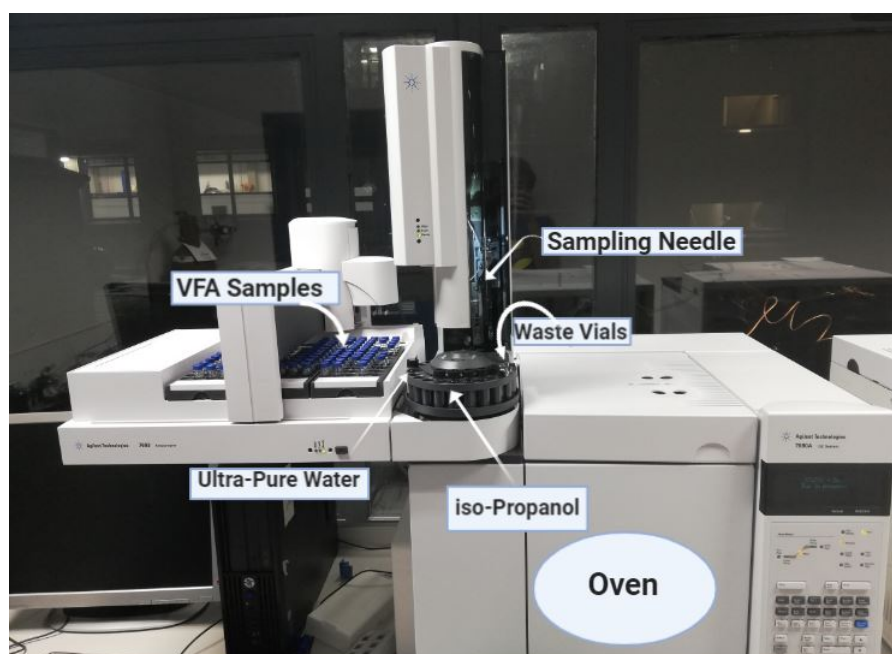

Figure 3.5: Gas Chromatography Machine; measuring Volatile Fatty Acids

The analysis was done using Gas-Liquid Chromatography method. The prepared test sample is injected into the system and is evaporated. The evaporated liquids interact with the walls of the columns coated with a stationary phase. The interactions between the samples and the adsorbents cause the compounds to elute at different retention times [73]. Based on the retention times, the acids are classified and peaks are displayed. The process was repeated for all the sample vials. The injector needle cleans with ultra-pure water and iso-propanol between each injection.

3.2.4. Particle Size Distribution Analysis

The particle size distribution (PSD) analysis was done for the sludge samples. The sludge samples were collected everyday from the reactor and stored in air-tight containers at 4°C. These samples were analysed once every two weeks from *Blue Wave* PSD. The *Blue Wave* system operates with a triple laser technique with one red and two blue lasers. The red laser operates at a wavelength of 780nm measuring diffraction from 0°-60°. The blue lasers operate at a wavelength of 405nm and collect the light from 60°-80° and 80°-165°. The system uses a refined algorithm from the Fraunhofer method to calculate the PSD. [74]. 3.6, shows a pictorial depiction of the *Blue-wave PSD* and how the particles are measured. As the image depicts, the blue laser produces 13 times more effective light source and is used to measure the smaller particles [74].

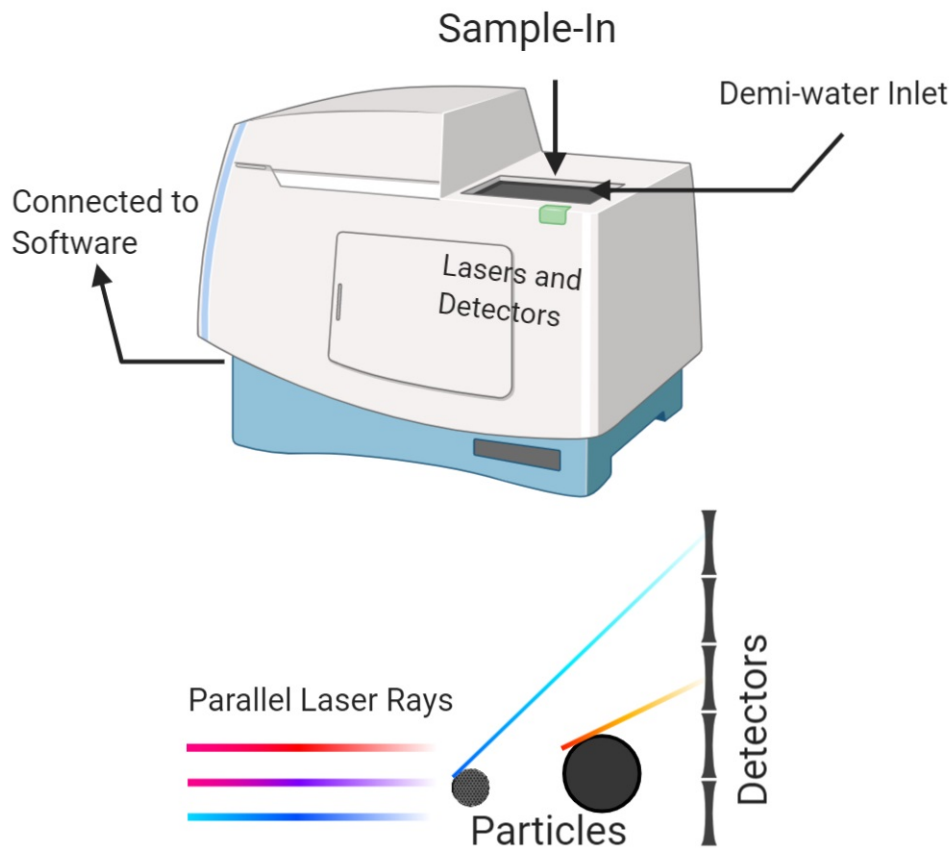

Figure 3.6: Pictorial Representation of PSD Bluewave, depicting laser diffraction

The sludge sample was added into the sampling point which contained demi-water. The sampling port was rinsed four times with demi-water before the addition of a new sample. The motor flow was set to 50% of the flow. A null set with just the demi-water was performed in every set before adding the sample so as to set a zero or blank value. The sludge samples were added by drops until the desired value reached. The sample analysis was then carried out in triplicates and the average value was obtained from the system.

3.2.5. Sludge Rheology Analysis

Rheological study can be carried out to liquids and soft-solids. It is defined as the study of a material which possesses the character of both solids and fluids. In case of measuring non-newtonian fluids, a single value of viscosity cannot be representative for the fluid. Hence, its behaviour to external forces such as shear stress, shear strain, torsional forces, etc. have to be determined.

The rheometer used was rotational rheometer. This analyses the behaviour of sludge to the applied forces. The rheometer used in the study was *Anton Paar (Graz, Austria): MCR302*. The instrument had a standard cup and bob of diameter 29.29mm and 27mm respectively. The bob had a span of 40.5mm and a smooth bob was used. The machine used a temperature control system and the temperature was set to 37°C, same as that inside the reactor. To avoid any evaporation, the top of the sample cup was covered with an insulated lid. The samples were run in three sets. The first set was to provide a pre-shear and erase the material memory of the sludge. This ensured that all the samples had a similar initial conditions. The final set involved the actual measurements by steadily increasing the shear rates. At the end of the test, the samples were discarded and the cylinder and bob were cleaned with ultra-pure water and dried before adding the next set of samples.

3.3. Biodegradability Tests

Today, the widely applied anaerobic technology is sold by stating the boon of bio-energy production. The energy produced is determined by the ultimate biogas production for any specific substrate. The biomethane potential (BMP) tests indicate the ultimate biogas production for any given substrate medium. Since the process involves the complete anaerobic digestion pathway as mentioned in section 2.1, the process stability will bank on the symbiotic association between the acid forming microbes and hydrogen forming microbes and methanogens [75]. Hence, a well defined test is necessary to obtain a robust result [75]. Likewise, the Specific Methanogenic Activity (SMA) tests provides us the maximum methane produced for a given inoculum while using acetate as substrate. In these tests, we can deduce the methane produced by methanogens.

3.3.1. Biomethane Potential Tests

The BMP tests were carried out in 180 ml serum bottles and sealed with a thick butyl rubber stopper and aluminium crimp. This was done to ensure that the bottles were completely sealed without any leakage as shown in Figure 3.7.

Holliger *et al.* [76], provides us a protocol for BMP tests. The protocol was developed by 40 international scientists working on optimising the BMP tests. The BMP tests done, were carried out from the stated protocol.

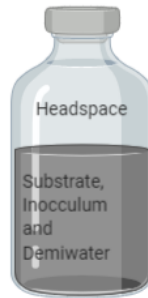

Figure 3.7: Pictorial Representation of BMP Bottle

The inoculum chosen for the test was from an Anaerobic digester running with synthetic black water for 140 days before the sludge samples were collected. A volume of 200ml of sludge everyday was collected from the reactor and accumulated over a period of 25 days such that there was enough sludge to run the tests. The COD, VS, TS, TSS and VFA of the mixed sludge were measured and a matrix was tabulated using these values of the mixed sludge. This matrix is provided in Table A.1, in Appendix A. As per the protocol, the inoculum used for the BMP tests were from an active reactor, treating a complex feed of synthetic blackwater. The test was run at a temperature of 37°C, the same temperature as the digester from which the sludge was extracted.

The protocol also states that there should be little endogeneous methane production from the inoculum [76]. Hence, the sludge sample extracted was incubated 8 days prior to beginning of the test. The sludge samples were distributed in 18 bottles and flushed with Nitrogen gas for two minutes per bottle, through the sludge sample. These bottles were incubated for 8 days before the actual test began.



Figure 3.8: Limited Aeration in BMP assays

Substrate chosen for the study was Ovalbumin (98% purity from Sigma-Aldrich). The test were carried in triplicates. The albumin substrate was exposed to 3 different aeration in addition to a non-aerated condition. The aeration chosen for the study corresponded to 0.7mlair/batch/d, 1.5mlair/batch/d and 4mlair/batch/d. The aeration was provided for the first 6 days after substrate addition. The total air corresponded to 0.35%, 0.76% and 2.02% increase in O_2 with respect to the VSS of inoculum in use. The calculated amount of air was injected into the liquid phase, through a syringe as shown in Figure 3.8.

The degradation of ovalbumin under these aerated conditions were related to two positive controls, one of which consisted of cellulose as substrate with no provided aeration and another control with Ovalbumin as substrate and no provided aeration. Both the used substrates were dried over-night in 105°C oven to eliminate residual moisture. The samples with substrates were subjected to an addition of micro-nutrients and macro-nutrients to aid the degradation. The volume of all the bottles were equalled by adding necessary amount of demineralized (demi) water. These calculations are provided in Table A.1 in Appendix A.

Gas samples were collected for the first 4 days after incubation and then once every week, using 1ml gas syringe and analysed in GC machine. The pressure build-up was manometrically measured 3 times for the first 5 days and reduced to twice everyday, in the later days of testing. This was converted to cumulative methane production (ml) per gram VS of the substrate normalized to standard pressure and temperature (273.15K and 101.33 kPa) as mentioned in the protocol [76].

$$V_{STP} = \frac{\Delta P \cdot V_h \cdot T_0 \cdot CH_4\%}{P_0 \cdot T} \quad (3.1)$$

Equation 3.1, sums up the standardization of the produced methane in standard temperature and pressure (STP) conditions. Where V_{STP} represents the volume of methane in STP conditions, ΔP is the pressure difference between two successive manometric measurements. V_h is the gas accumulated in the headspace. T_0 and T are the temperature at STP and temperature of incubation respectively. $CH_4\%$ is the methane composition in the measured sample of biogas from the headspace and P_0 is the measured atmospheric pressure at the time of manometric pressure measurement. [77]. The test was completed when the cumulative methane production had less than 1% difference in value between two consecutive days.

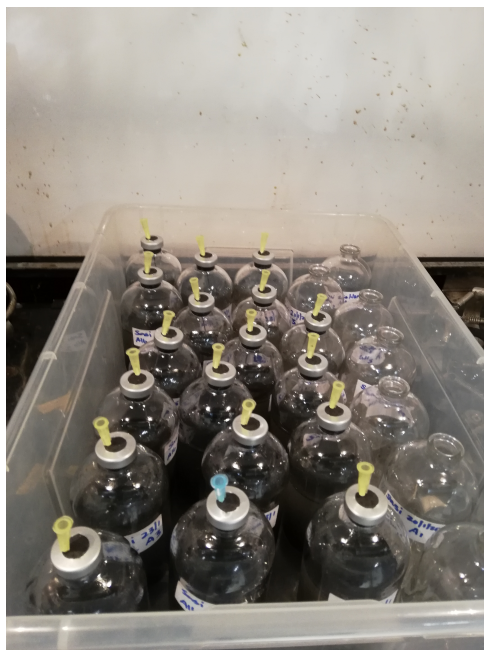

Figure 3.9: Pressure build-up managed by opening the headspace to atmosphere

The bottles were opened to atmospheric pressure twice during the first 5 days of measurement to avoid excess pressure build-up in the headspace. Figure 3.9 paints an idea on how the bottles were opened to atmospheric pressure. As mentioned earlier in the section, the test was carried out at 37°C and each time the pressure was measured, the atmospheric pressure was also noted down which was used in converting the pressure to cumulative methane production. The samples were still placed in the incubator at 37°C, when the pressure was measured. Care was taken so that the temperature remained between 35°C and 37°C, when the measurements were carried out.

3.3.2. Specific Methanogenic Activity Tests

Acetoclastic methanogenic organisms are found to be susceptible to changes in the working systems like pH, temperature, and presence of inhibitory compounds [78, 79]. Processes which cause negative impact on anaerobic organisms can be termed as inhibition or toxic. This inhibition or toxicity tests for methanogens, can be done by SMA tests.

The SMA tests were performed to analyse the effect of different aeration rates on the methane production. The inoculum for the tests were obtained from the AnMBR treating synthetic blackwater. The tests were carried out for four sludge samples extracted from the reactor. The first test was carried out for a completely non-aerated sludge. Second test was performed on a sludge aerated for 7 days with a concentration of 4.9 $\text{mlair}/L_R/d$ ($1\text{mlO}_2/L_R/d$). The third and fourth SMA tests were performed with aerated sludge of 9.8 $\text{mlair}/L_R/d$ ($1.5\text{mlO}_2/L_R/d$) and 14.7 $\text{mlair}/L_R/d$ ($3\text{mlO}_2/L_R/d$) respectively.



Figure 3.10: Representation of AMPTS-II from *Bioprocess Control* [5]

The tests were performed according to the *TU Delft* laboratory protocol [5]. The tests were done in triplicates. The test was carried out in 250ml bottles with 200ml of liquid. The amount of sludge, substrate, micro-nutrients, macro-nutrients and phosphate buffer required for the test was calculated and the volume was made to 200ml with demi-water. Sample bottles were prepared with acetate as substrate. The sludge incubation was done by spiking the samples with acetate. The actual acetate (as substrate) was added after complete consumption of acetate in the activation pulse. The bottles were flushed with nitrogen before placing them in the incubator at 37°C. The tests were carried out for zero aeration, aeration pulse of 7ml, 15ml and 40 ml. The aeration pulses represented the same air concentration followed in the BMP tests. The aeration pulse was added just after adding the substrate. The bottles were sealed air-tight for 20 minutes during aeration and was opened to the gas measuring device later.

The bottles were connected to an Automatic Methane Potential Test System (AMPTS II) from *Bioprocess Control*. The AMPTS II contains a CO_2 absorption unit where the produced biogas passes through 3M NaOH solution where the CO_2 gets absorbed as shown in Figure 3.10. The gas then passes on to the Gas-volume measuring system which measures the amount of methane produced by counting the number of clicks.

3.3.3. Proteins, Carbohydrates and Humic Acid Measurements

Proteins, Carbohydrates and Humics were measured in each of the batch assays after degradation. Samples were extracted from the BMP bottles for every condition, and for every condition, samples were made in triplicates.

Proteins and humics were measured by modified Lowry method as explained by *Frøuland et al.* [80]. The method involves preparing five reagents. Reagent A was prepared by adding 143 mM NaOH and 270 mM of Na_2CO_2 . Reagent B was 57 mM $CuSO_4$, Reagent C was 124 mM of sodium-tartat. Reagent D was the mixture of the reagents A,B and C in the ratio 100:1:1. Reagent E was a mixture of Folin-Ciocalteu reagent and Distilled water in 1:2 ratio. The reagents were freshly prepared every time the measurements had to be made.

The process involved mixing 1.5 ml of the sample with 2.1 ml of reagent D rapidly in a vortex mixer. The concoction was left for 10min in dark at room temperature. 0.3ml of reagent E was added rapidly and mixed with a vortex mixer in a dark place. It was left for 45 minutes in the dark in room temperature. Adsorption was measured at 750 nm against the blank. Calibration was done with protein standard bovine serum albumin (BSA).

Carbohydrates on the other hand was also similarly measured with different reagents. The process involved mixing 1 ml of the sample with 5% (w/w) phenol solution and was mixed thoroughly with a Vortex mixer. This was left at room temperature for 10 minutes before adding 5ml of 97% sulphuric acid rapidly (in stream). This was let to cool at room temperature for 5 minutes. The cooled sample was mixed well and allowed to rest for another 25 minutes at room temperature. Adsorption was measured at 490 nm against a blank. Calibration was done with a glucose standard (D-glucose monohydrate). The calculations were done as explained by [Dubois et al. \[81\]](#).

3.4. Feed Optimization

The AnMBR as mentioned earlier was fed with laboratory made synthetic wastewater. The wastewater preparation was done by adjusting the recipe from [Ozgun et al.](#). The original recipe of Halen Ozgun was for a COD of 27gCOD/l, and had to be toned down to 5gCOD/l. The feed was started with 100mgCOD/l, and was gradually increased over time to reach 5gCOD/l. This was to ensure that there were no VFA production due to excess substrate addition. The feed so made, contained substrates which were readily bio-degradable. The recipe from [Ozgun et al., 2013](#) can be found in Tables [A.2](#) & [A.3](#) in Appendix A.



Figure 3.11: Particles in Feed Tube Responsible for Clogging

To make the feed more complex, a few changes were made as found in Table A.4, the micro-nutrient solution remained the same. The newly prepared recipe was used after 28 days of reactor operation. This feed had a COD of 5 gCOD/l. The new recipe was continued for 27 days. It was changed again as variation in influent COD between consecutive days were observed. The oil concentration in the feed was reduced to 2 drops/l from 5g/l. The oil was dropped using a dropper.

Despite changing the feed, the influent COD varied a lot between consecutive days. Another correction in the feed was made after 38 days. Because of the presence of toilet paper, ferric chloride and bentonite clay, the particles accumulated in the feed tube (as shown in Figure 3.11) and did not travel into the reactor. To avoid this, a new recipe was prepared by omitting toilet paper, bentonite and ferric chloride. The COD was compensated by adding cellulose and acetate. A valve was added in the feed line to test if the COD in the feed bucket and the feed line were the same. In other words, the valve was used to test if enough particle transfer was there.

In the 38 days of operation with this feed, other mechanical corrections were done to avoid clogging and continue using the same feed. The head loss after the pump was prevented by placing the feed pump above the inlet point in the reactor. The feed vessel was changed to have a smaller circumference in the bottom and the magnetic stirrer was changed to operate the stirrer with maximum possible rpm. The variation in influent COD was avoided after following these steps. This feed mentioned in Table 3.2 was used as the new feed composition until the end of the study.

4

Results and Discussions

The performance of the AnMBR is summarised here. The obtained results from the AnMBR operation, PSD of sludge, rheology of the sludge and batch tests performed on biodegradability of substrate and activity of methanogens are discussed as subtopics. The obtained results are summarised to have an understanding of the effects of applied limited aeration on the AnMBR operation.

4.1. COD Removal in AnMBR

As mentioned in Section 2.1, the complex organic polymers are reduced to methane and carbon-dioxide through a sequential degradation as represented in Figure 2.2. As explained in Section 2.1.5, part of the COD in the complex organic polymers fed into the reactor, leaves the system as biogas, after being consumed for cell-synthesis. The rest of the COD still remains in the effluent. COD removal efficiency gives an idea on the biodegradability of the feed fed into the reactor.

4.1.1. Variation and Stabilization of Influent COD

The reactor was run with synthetic blackwater recipe by correcting the recipe by Ozgun *et al.* [6], as tabulated in Table 3.2 in Section 3.1.3. Figure 4.1, represents the monitored influent COD concentration in the AnMBR over a period of six months. It can be seen from Figure 4.1 that the COD varies a lot in the influent in the beginning and steadies to a shorter range after. This variation in COD values can be related to the stage before the influent conditions were normalized (as explicated in Section 3.4).

It can be observed that the variation in the influent COD concentration of the samples reduced after 27-11-2019; implying that the changed input conditions were effective in reducing the variation. The average deviation of the influent COD was noted to be 20% prior to this date and the variation reduced to 4% with the newly applied conditions. From this day on, the reactor was run with an average COD of 5gCOD/l for 2 SRTs before the aeration was started.

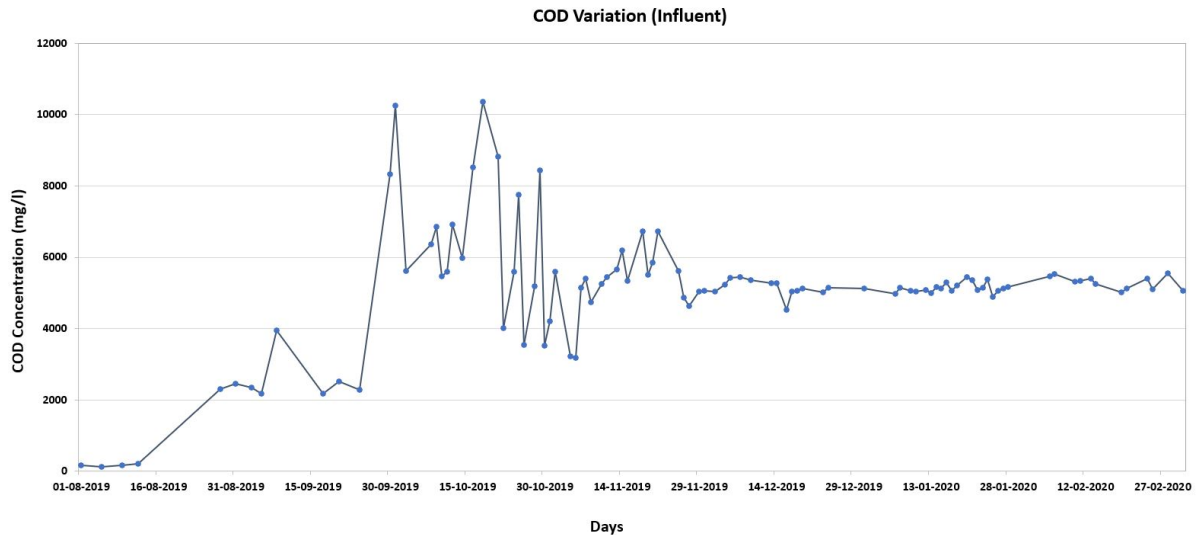

Figure 4.1: COD Concentration in Influent

The variation in the initial days of feeding created a doubt that if the COD in the bucket reached the reactor or not. To analyze this, the influent line from the feed bucket to the reactor was connected with a valve. This was used to determine the flow of feed into the reactor and the extracted sample was used to measure the COD in the feed line. This value was compared to the COD values of the sample taken from the feed bucket on the same day. The results of this COD difference between the sample taken from the bucket and the valve is represented in Figure 4.2.

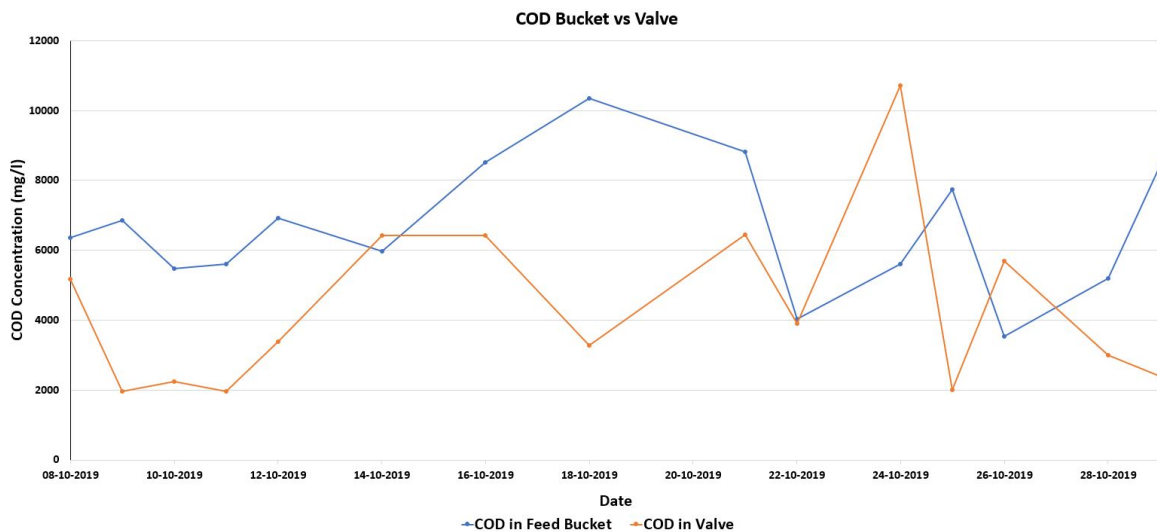

Figure 4.2: COD variation: Influent COD Concentration in Feed Bucket and Sampling Valve.

It can be interpreted from Figure 4.2 that there is no trend relation between the values of samples taken from the bucket and the valve. A sample from sampling valve was collected every three hours in a day for 5 days to see if there was any daily trend in COD variation in the samples taken from the valve. Table 4.1, represents the COD values measured over the three hour interval for 5 days.

The COD values were averaged for triplicates and over time. These values are represented against the COD of the sample extracted from the feed bucket on the

same day at 10:30 hours. It can be seen from Table 4.1 that there is no trend in the COD variation over time or over days. The COD values range from 1.10-12.32 gCOD/l with deviation as high as 75% in the feed line whereas the COD from the bucket corresponds to 5 gCOD/l over the days.

Table 4.1: Average COD Values of Samples Extracted From the Valve

Day	Time	COD Trial 1 (g/l)	COD Trial 2 (g/l)	COD Trial 3 (g/l)	Average COD Per Sample (g/l)	Average COD Over Time (g/l)	COD from Feed Bucket (g/l)
1	10:30	4.96	4.88	4.99	4.99	7.31 ± 3.26	5.07 ± 0.03
	13:30	11.76	11.90	12.06	11.90		
	16:30	5.06	5.08	4.99	5.02		
2	10:30	1.66	1.67	1.58	1.64	4.82 ± 4.45	5.04 ± 0.01
	13:30	12.33	12.55	12.08	12.32		
	16:30	5.00	4.97	5.01	4.99		
3	10:30	14.56	15.30	15.14	15.00	7.75 ± 5.69	5.02 ± 0.05
	13:30	7.25	7.00	7.17	7.14		
	16:30	1.10	1.09	1.09	1.1		
4	10:30	7.89	7.69	7.79	7.79	5.70 ± 1.55	5.21 ± 0.07
	13:30	4.00	4.13	4.11	4.08		
	16:30	5.18	5.23	5.27	5.23		
5	10:30	3.20	3.27	3.20	3.22	5.58 ± 1.99	5.22 ± 0.04
	13:30	8.01	8.12	8.16	8.10		
	16:30	5.39	5.42	5.47	5.42		

The samples from the valve were collected for a brief time of 2 minutes. This would yield a sample volume of 350ml. It was observed that at any given time of the day there were particles clubbed together on the sides of the feed tube getting into the reactor. Every time a new feed was prepared, the feed lines were cleaned and then the new feed was let through it to the reactor. The lower COD values from the valve can be related to the time when the feed was changed. As seen in Figure 3.11, there were particles from the substrate clubbing together. This was not observed on the same day as the feed was changed but rather observed a day later. These particles do not settle on the walls of the tube, they are transferred to the reactor with the rest of the feed. Higher values of COD from the valve samples can be related to having higher particles at that particular moment of extraction.

Despite having a wave of fluctuation in the COD values of the valve samples, it can be noted that the influent sample from the bucket yielded around 5 gCOD/l over days. This can be related to the fact that the influent in the bucket was constantly mixed and at any given sampling time, the extracted sample would be representative of the influent in the bucket. Whereas in the feed line, there was irregular particle transfer due to lower influent flow. Less flow could have resulted in temporary accumulation of particles and continuous flow would have transported the particles to the reactor in irregular intervals causing a high variation in the COD measured from the valve.

Since there was no variation in the influent source i.e., the bucket overtime, it was assumed that the influent getting into the reactor was also the same 5 gCOD/l/d.

It is also worth to note that the peristaltic pump delivers the liquid in pulses. It would be better to note the average COD values extracted from the valve for a longer period of time to observe any changes in trend. The particle settling alongside the walls of the tube could be prevented by using a higher flow of pump and having an intermittent feeding to the reactor.

4.1.2. COD Removal in AnMBR

As explained before, the variation in the influent COD fed to the reactor decreased over time as represented in Figure 4.1, and this feed condition was maintained for the rest of the study. Limited aeration to the AnMBR was introduced after 2 SRTs (57 days) of operating with this feed condition (on 23-01-2020).

The effluent COD concentrations after optimization of influent conditions are represented in Figure 4.3.

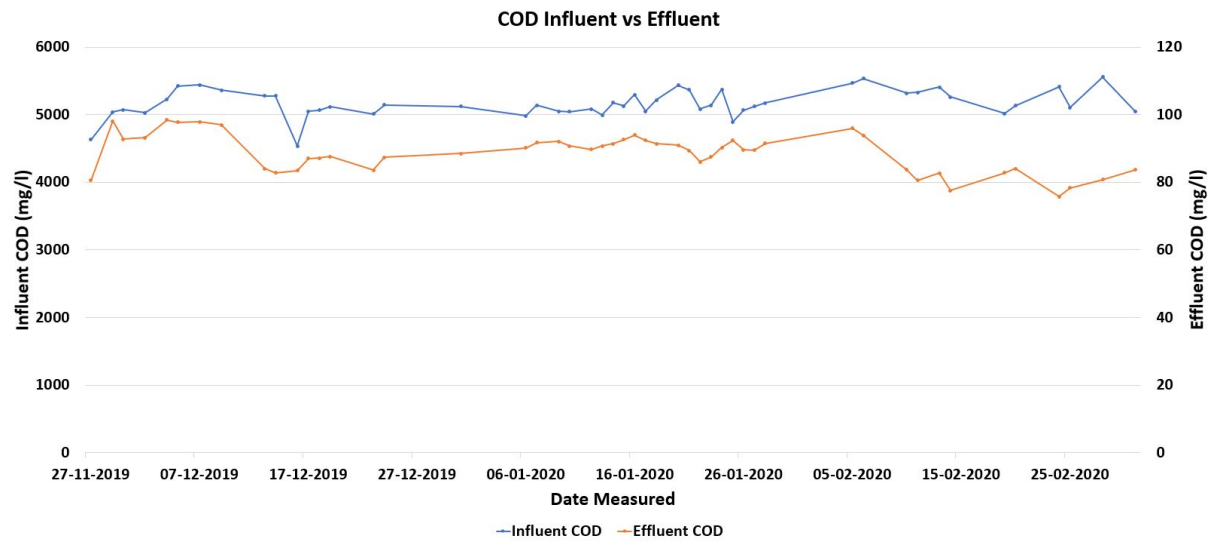

Figure 4.3: COD variation: Effluent COD Concentration

It can be seen that the COD is reduced from around 5000mg/l in the influent to around 80mg/l in the effluent. The removal efficiency in the effluent stabilized at 98% even when there was a higher variation in the influent COD. This shows that the organisms adapted well to the operating feed. It was also observed that the COD concentration of the effluent reduced further after introduction of the limited aeration (from 05-05=2020). The impact of limited aeration on COD removal is discussed in the section below.

4.1.3. Effect of Limited-Aeration on COD Removal

The limited aeration added in the reactor was gradually increased from 4.9 mlair/ L_R /d to 14.7 mlair/ L_R /d, as explained in Section 3.1.5. The significance of difference between the average removal efficiencies with each added aeration and the non-aerated batch, were identified by a single factor ANOVA test provided in Appendix B.

Table B.1, shows the ANOVA results between the removal efficiencies without aeration and when the reactor was aerated with 4.9 mlair/ L_r /d (corresponding to 0.68% increase in O_2). And it can be seen that the f value is less than f-critical value and p-value is greater than alpha value (0.05). Hence, the null hypothesis is accepted. There is no significant difference between the non-aerated sludge and

aeration of 4.9 mlair/ L_r/d (0.68% increase in O_2) in the reactor, in terms of COD removal.

Hence, it can be said that the added aeration of 4.9 mlair/ L_r/d didn't cause an increase in the removal efficiency. The observed COD removal is not significant enough to be considered as an increase in removal compared to the non-aerated condition.

Table B.2 shows the ANOVA results of the COD removal efficiencies in the non-aerated phase and in the second batch of aeration with 9.8 mlair/ L_r/d (corresponding to 1.35% increase in O_2). Here as well, the f value is lesser than the f-critical value and p-value is more than 0.05. There for the null hypothesis is accepted. There is no significant difference between the non-aerated sludge and aerated sludge with 9.8 mlair/ L_r/d (1.35% increase in O_2) in the reactor, in terms of COD removal.

Here as well it can be comment that the observed increase in removal value on adding 9.8 mlair/ L_r/d was not significant enough to be considered a betterment in COD removal. It can be concluded that the aeration added had no effect in increasing the COD removal efficiency of the system.

Table B.3 represents the ANOVA result run between the removal efficiencies from non-aerated sludge and third batch of aerated sludge with 14.7 mlair/ L_r/d (2.02% increase in O_2). In this test, we can see that the f value is higher than the f-critical value and the p value is less than 0.05. Hence, we reject the null hypothesis and conclude that there is a significant increase in the COD removal between the non-aerated sludge and third batch of aerated sludge (with 2.02% increase in O_2).

The average COD removal efficiency increased by 0.2% on adding 14.7 mlair/ L_r/d in the reactor. This increase of 0.20% in the COD removal corresponded to a 11% increase in the effluent COD removal compared to the non-aerated condition and was found to be a considerable increase in COD removal when compared to the week with no aeration. It can be said that the added aeration of 14.7 mlair/ L_r/d , caused a higher degradability of a the feed. Jenicek *et al.* [82], also had observed a 7% decrease of COD under limited-aeration conditions.

The provided aeration of 14.7 mlair/ L_r/d (corresponding to 2.02% increase in O_2) enhanced the overall degradation. The effect of aeration on the degradation of ovalbumin as substrate and the effect of the applied aeration on the methanogenic activities are discussed further.

4.2. Batch Biodegradability Tests

This section discusses the results obtained from the batch experiments on the degradability of ovalbumin under different conditions of introduced limited aeration. The degradation will be compared with a standard of cellulose degrading under non-aerobic conditions. The degradation of proteins, humics and carbohydrates in each of these batch assays are also discussed.

4.2.1. Bio-Methane Potential Tests

The cumulative methane produced in the serum bottles incubated at 37°C, were measured manometrically as mentioned in Section 3.3.1. The cumulative methane produced for Ovalbumin under different aeration conditions is compared to a control using cellulose (without aeration) and another control with Ovalbumin and no aeration. The values of cumulative methane produced for each batch are represented in Figure 4.4. Table A.1 in Appendix A, can be referred to gain more data on batch preparation, theoretical maximum methane production and theoretical BMP for the substrates.

The methane production over time was determined by measuring the pressure build-up and relating it to the Gas composition obtained from GC for biogas. Each conditions were performed as triplicates and the residual methane from the inoculum was subtracted before the BMP was calculated. The resulting cumulative methane production after correcting for the pressure increase due to air addition, and pressure decrease due to sampling, is represented in Figure 4.4.

It can be seen from Figure 4.4 that the methane production begins from day 1 in the case of ovalbumin batches and there is a lag phase in the BMP production of cellulose. It can be interpreted that ovalbumin used in the study is more readily biodegradable than the used cellulose. Filer *et al.* [83] says that if there is a lag phase in the curve, it could be stipulated that hydrolysis is the rate limiting step of the digestion process.

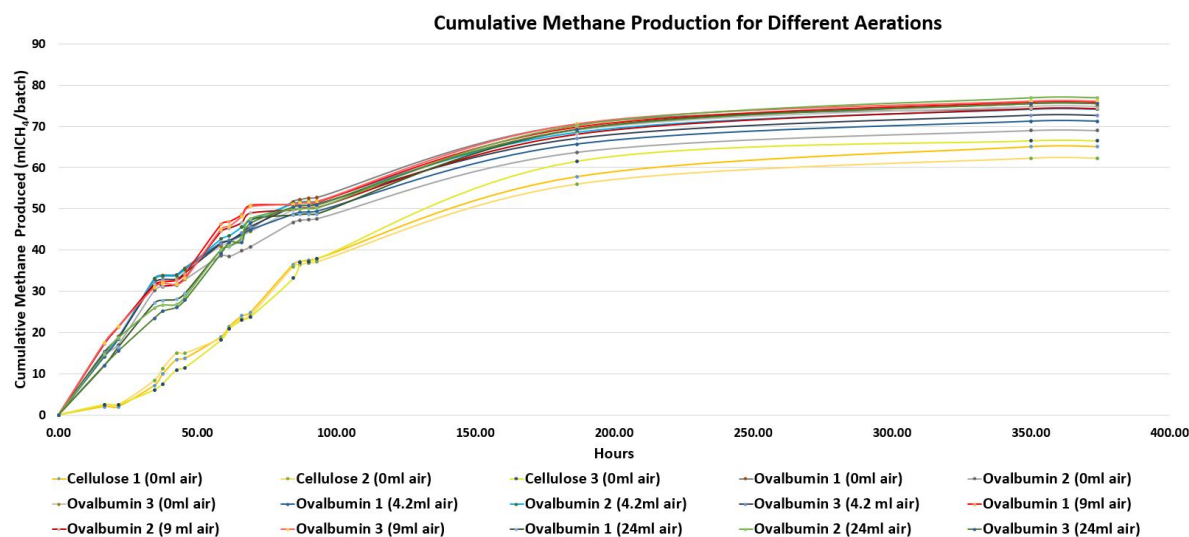

Figure 4.4: The Cumulative Methane Produced Over Time of Non-Aerated Sludge for Every Batch with Ovalbumin and Cellulose

Holliger *et al.*, 2016, mentions that the BMP should be expressed in terms of dry volumes of methane under standard conditions of temperature and pressure (of 273K and 101 kPa) per volume of VS added. Thus the calculated volume of methane per batch from Equation 3.1, was converted to maximum methane produced per gram VS of the used substrate to yield the BMP.

The measured average BMP of each batch is compared to its respective theoretical value and the values are summed up in Table 4.2. It can be seen that the relative standard deviation (RSD) of the control is less than 5% and the RSD of Ovalbumin is not greater than 5% in any case. Thereby according to the criteria suggested by Holliger *et al.* [76], the data is valid.

Table 4.2: Average BMP of Control and Ovalbumin – Exposed to Different Aerations

Sample	Aeration (% O_2 Increase)	Measured Value		Theoretical BMP ($mlCH_4/gVS$)	BD (%)
		Average BMP ($mlCH_4/gVS$)	RSD (%)		
Cellulose (0ml air)	0	402.413 ± 1.9609	4	417.363	95.666
Ovalbumin (0ml air)	0	465.43 ± 2.7220	5	482.743	95.475
Ovalbumin (0.7ml air)	0.35	461.111 ± 1.0965	2	485.772	94.923
Ovalbumin (1.5ml air)	0.76	483.754 ± 0.9230	2	489.234	98.598
Ovalbumin (4ml air)	2.02	486.056 ± 0.6712	1	500.054	97.201

It can be noted that the Table 4.2 also provides the biodegradability (BD) of the substrates under different conditions. The biodegradability of the substrates were calculated from Equation 4.1 [77]. Where BMP_{exp} is the experimentally determined BMP and BMP_0 is the theoretical BMP of the same substrate.

$$BD(\%) = \frac{BMP_{exp}}{BMP_0} 100 \quad (4.1)$$

It can be seen from Table 4.2 that the biodegradability is almost similar in all the cases with some variations. The significance of these variations are tested with individual ANOVA tests and the results are discussed below.

Table B.5, presents the results of the ANOVA test between the biodegradability of ovalbumin assay with no aeration and ovalbumin assay with 0.35% increase in oxygen. It can be seen here as well that the null hypothesis has been accepted owing to the f value being lower than f-critical value and p-value more than 0.05. Thus, there is no significant difference of average biodegradability of the aerated batch assay and the non-aerated assay.

Table B.6, gives the ANOVA test results of non-aerated ovalbumin batch assay and ovalbumin assay with 0.76% increase in oxygen. It can be seen here that the f value is lesser than the f-critical value and p value is higher than 0.05. Hence, there is no significant difference between non-aerated batch and batch with 0.76% oxygen addition.

Here as well, interpreting the data from Table B.7, we can conclude that the null hypothesis stands. Thus, there is no significant difference between the biodegradability values of non-aerated batch and batch with 2.02% additional oxygen using Ovalbumin as substrate.

It can be observed that in neither cases of aeration, the biodegradability varied significantly. Hence, it can be stated that the provided aeration did not affect the biodegradability of ovalbumin in the batch conditions. It can also be observed that the obtained biodegradability results is similar for cellulose and ovalbumin.

Ovalbumin was considered for the biodegradability test as it was assumed to have a lower biodegradability owing to the complex structure containing 386 amino acid chains as explained by Huntington and Stein [84]. However, in this study, it was found that the used product had a degradability of 95% prior aeration, and was not

improved further on introducing limited aeration. Despite this, it was observed that the COD removal in the AnMBR had been enhanced. Other factors responsible for this degradation are to be analysed and this effect will be discussed in concluding sections.

4.2.2. Fate of Protein in each Batch Assay

This section will discuss the effect of applied limited aeration on degradation of proteins in the batch assays. The samples tested were extracted from the BMP bottles after the BMP test was completed. The sludge fraction mentioned, corresponded to the mixed liquor extracted from the BMP bottle and the effluent corresponded to the mixed liquor after being filtered with a $0.45\ \mu\text{m}$ filter. The proteins were analysed according to the method provided by Frøuland *et al.* [80] as explained in Section 3.3.3. Each sample was analysed in triplicate and then averaged to provide the results. Figure 4.5 provides us the concentration of proteins in each batch assay.

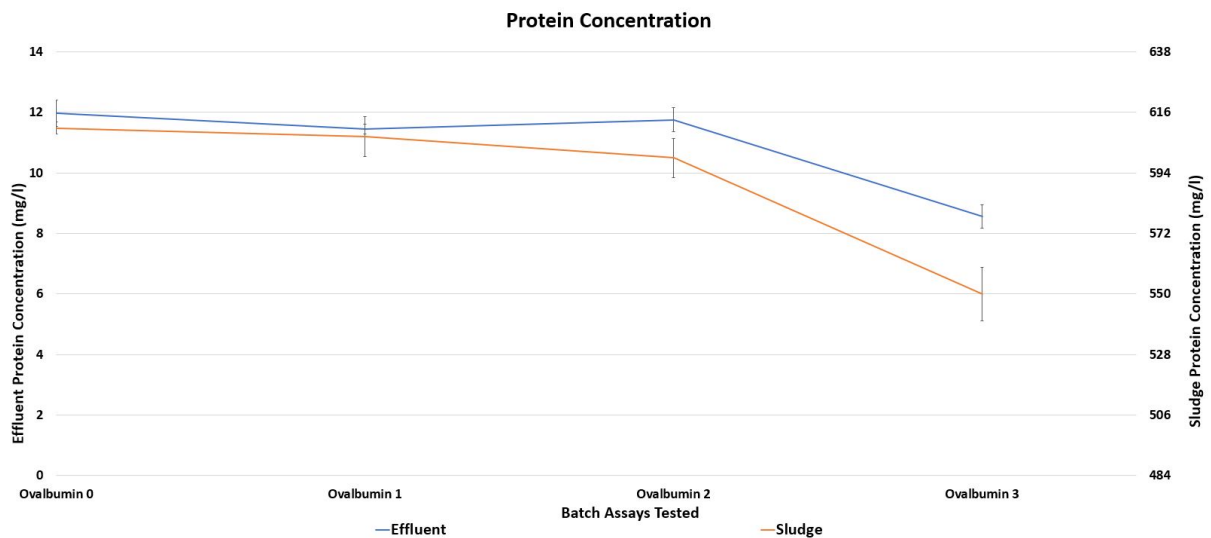

Figure 4.5: The Average Effluent and Sludge Protein Concentration in Each Batch Assay

As mentioned earlier, the effluent of the batch assay was the liquid obtained after filtering the mixed liquor in each batch assay with $0.45\ \mu\text{m}$ filter. This can also be considered as the soluble concentration of proteins in the batch assay. Ovalbumin 0, Ovalbumin 1, Ovalbumin 2 and Ovalbumin 3, correspond to the aerations 0ml, 0.7ml, 1.5ml and 4ml of air introduced respectively as explained in the previous section.

It can be seen from Figure 4.5 that the concentration of protein decreases in the mixed liquor of the batch assay with increase in provided aeration. It can be said that the provided aeration increased the degradation of proteins in the batch. It was also observed that in the effluent of the batches, the protein concentration were lesser than that of the non-aerated batch.

The protein concentration in the effluent reduced by 4% with 0.35% O_2 increase ($p = 0.0001$), 2% with 0.76% O_2 increase ($p = 4.7E-06$) and 28% with 2.02% O_2 increase ($p = 2.6E-06$). The removal in each cases were significant as the p value was less than 0.05 in all cases. The protein concentration in the sludge reduced by 1% with 0.35% O_2 increase ($p = 0.019$), 2% with 0.76% O_2 increase ($p = 1.08E-05$) and 10% with 2.02% O_2 increase ($p = 1.6E-06$). The protein degradation was enhanced with all the

introduced aeration.

4.2.3. Fate of Humics in each Batch Assay

The concentration of humics were also measured from the protein absorbance as mentioned by Frøuland *et al.* [80]. The concentration of humics from the protein absorbance were calculated from the method as used by Sophonsiri and Morgenroth [85]. The samples were tested in triplicates and the average value is provided in Figure 4.6

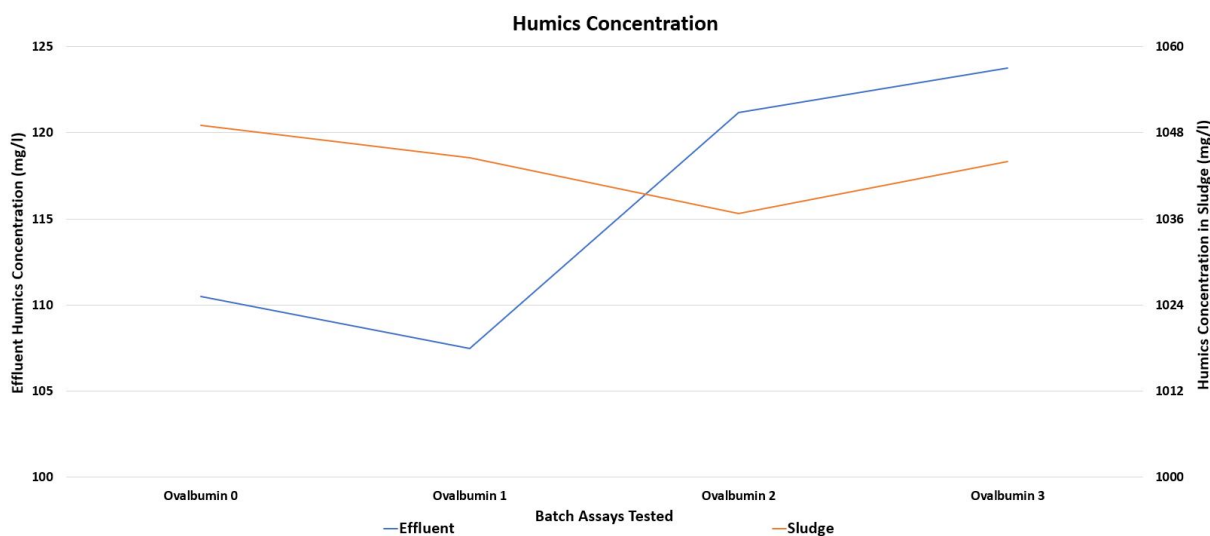

Figure 4.6: The Average Soluble and Total Humics Concentration in Each Batch Assay

Just as proteins, the effluent sample was obtained after filtering the liquid with 0.45 μm filter. Here as well the samples named Ovalbumin 0, Ovalbumin 1, Ovalbumin 2 and Ovalbumin 3 represent aerations of 0ml, 0.7ml, 1.5ml and 4ml of air introduced (everyday for 6 days) respectively.

It can be seen from Figure 4.6 that the concentration decreased in the effluent by 3% with 0.35% O_2 increase ($p = 0.0001$), it then increased by 10% with 0.76% O_2 increase ($p = 4.7E-06$) and increased by 12% with 2.02% O_2 increase ($p = 2.6E-06$) and there was not a notable change in the total humics fraction. Thus the provided aeration increased the concentration in the effluent (soluble fraction) and not in the sludge (total fraction) in the second and third batches, making it better available for digestion.

4.2.4. Fate of Carbohydrates in each Batch Assay

Carbohydrates in the samples were measured using the Dubois Carbohydrates method as mentioned by Dubois *et al.* [81] explained in Section 3.3.3. The samples were measured in triplicates and the average values are plotted in Figure 4.7.

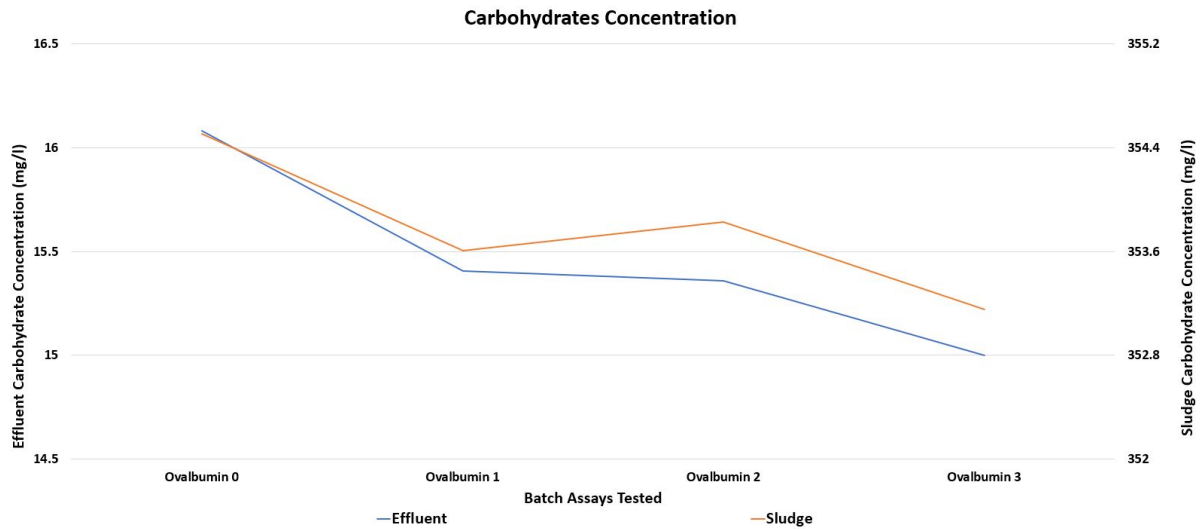

Figure 4.7: The Average Soluble and Total Carbohydrates Concentration in Each Batch Assay

The samples named Ovalbumin 0, Ovalbumin 1, Ovalbumin 2 and Ovalbumin 3 in Figure 4.7 also represent the same concentrations of aeration as described in previous sections. Here as well, the mentioned effluent of the batch assay is a filtered sample of the mixed liquor filtered using 0.45 μm filter.

Though the concentration of carbohydrates from Figure 4.7 seem to have reduced both in the total fraction and the soluble fraction, it was found that this difference in concentration was not significant as the p value was higher than 0.05 in all the three cases of provided aeration. Thus the Carbohydrate concentration was unaltered by introduction of limited aeration.

The batch assays subjected to different limited aeration with ovalbumin as the substrate, were used for testing the changes in the protein, carbohydrate and humic concentrations as well. It is to be noted that though the tested substrate was ovalbumin, the proteins, carbohydrates and humics in the batch assays could also be present as residual substances in the sludge as in the extracellular polymeric substances (EPS). Thus the concentration of humics, proteins and carbohydrates measured are a function of the ovalbumin as well as the residuals from the EPS. Though a reduction in proteins was observed, a better degradation of ovalbumin was not observed. It could be that the reduction in proteins would have been the reduction caused to the residual proteins in the EPS and not of the ovalbumin.

4.3. Specific Methanogenic Activity and Inhibition

The batch experiments were conducted to determine the effect of air introduction on the methane production of the blackwater sludge, and compare the obtained results with air supplied through Dissolved Air Flotation (DAF) systems. The sludge was collected from the AnMBR, the AnMBR was aerated with 4.9 $\text{mlair}/L_r/d$ and 9.8 $\text{mlair}/L_r/d$ each for 8 days and then increased to 14.7 $\text{mlair}/L_r/d$. The SMA was performed with the sludge from each week also with the non-aerated sludge. The methane production was evaluated from these four inoculum in triplicates. Angelidaki *et al.* 2009, state that the minimum specific activity on acetate should be 0.1 $\text{gCH}_4 - \text{COD}/\text{gVSS}\cdot\text{d}$ which was satisfied in all conditions.

4.3.1. SMA of Non-Aerated Sludge with No Retention of Added Aeration

The first set of experiments were performed for the non-aerated sludge. Figure 4.8 provides us with the average methanogenic activity of the non-aerated sludge with different aeration pulses.

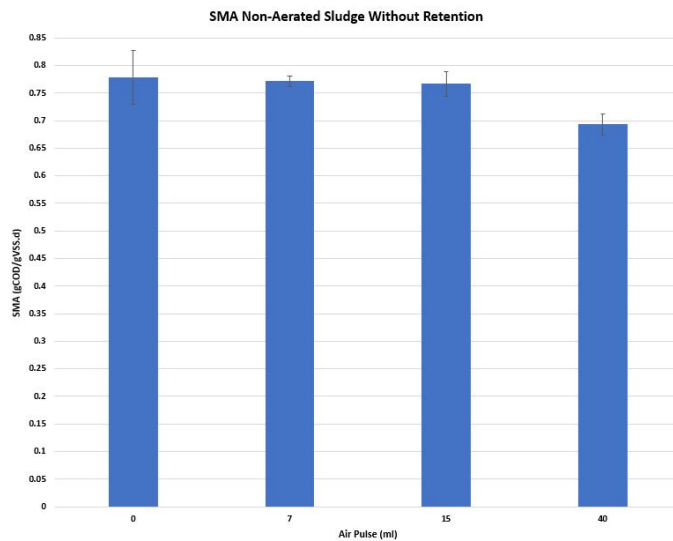

Figure 4.8: The Average SMA Values of Non-Aerated Sludge for Different Air Additions and Without Any Retention

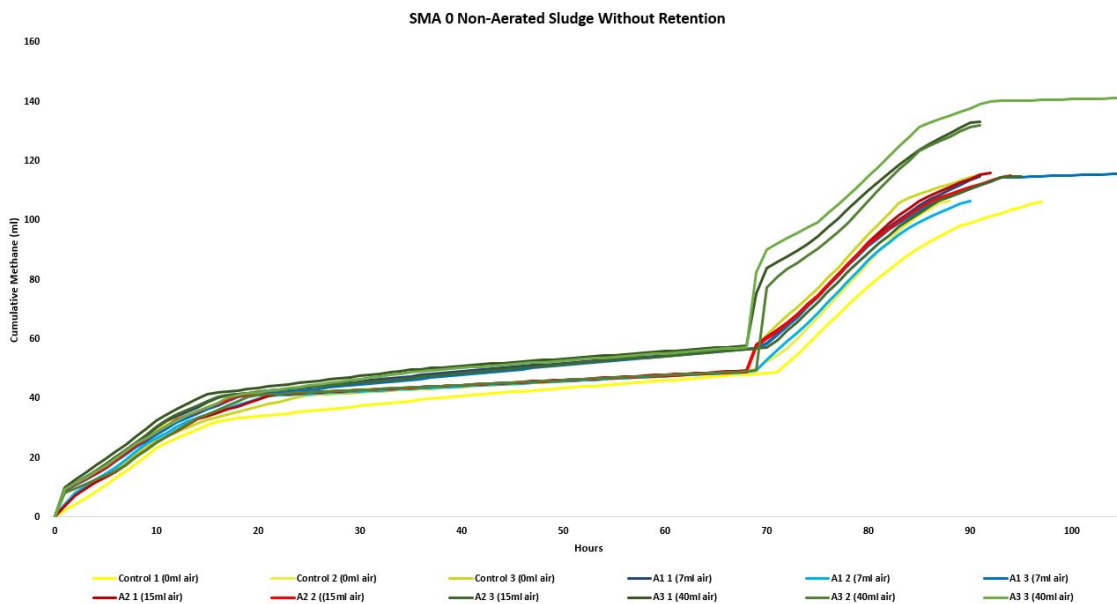

Figure 4.9: The Cumulative Methane Produced Over Time of Non-Aerated Sludge for Different Air Additions and Without Any Retention

The pulse added were allowed to pass through to the clickers of the AMPTS as soon as they were added. In other words, the added air pulses were not retained in the headspace of the bottles. It can be seen from Figure 4.8, that the activity of the sludge for a 7ml aeration pulse, 15ml aeration pulse are very similar to that of the control (with no aeration). The batch exposed to 7ml of air had an SMA difference of 0.98% and the batch exposed to 15ml air had an SMA difference of 1.57% with

respect to the control. An ANOVA test was run and it was ascertained that neither of the batch had any significant difference corresponding to the Control. Only the batch exposed to 40ml air pulse had a significant difference of 10.98% in its activity when compared to the control.

The SMA was performed with each bottles in incubation with the same initial conditions. The sludge was activated with a certain amount of acetate in the incubation period. The actual substrate and aeration were added to the sludge after the initially added acetate was consumed. It can be observed from the Figure 4.9 that around 70 hours, there is a sudden jump in the gas production. This can be corresponded to the addition of substrate and air in each bottles. Since there might be a possibility of over-estimation of the values, and loss of air pulses, this set of experiment is not used for comparison.

4.3.2. SMA of Non-Aerated Sludge with Retention of Added Aeration

The next set of experiments were carried out again for the non-aerated sludge, this time with a retention of the added aeration. The aeration added to the batch reactors were retained in the batch reactors for 20 minutes before opening them to the AMPTS clickers. The 20 minute retention was chosen based on retention used in DAF systems [86, 87].

The cumulative methane produced with each bottle is represented in Figure 4.10. Every case was performed in triplicates, the SMA of all the individual bottles were calculated and averaged to yield the average SMA for a particular case. The SMA of the negative control was subtracted from all the other bottles so that the methane production from the residual substrates in the sludge was not included.

Here as well, the initial incubation time is excluded from measurements, and the SMA values are validated after the bottles were opened to the AMPTS (around 65 hours of incubation).

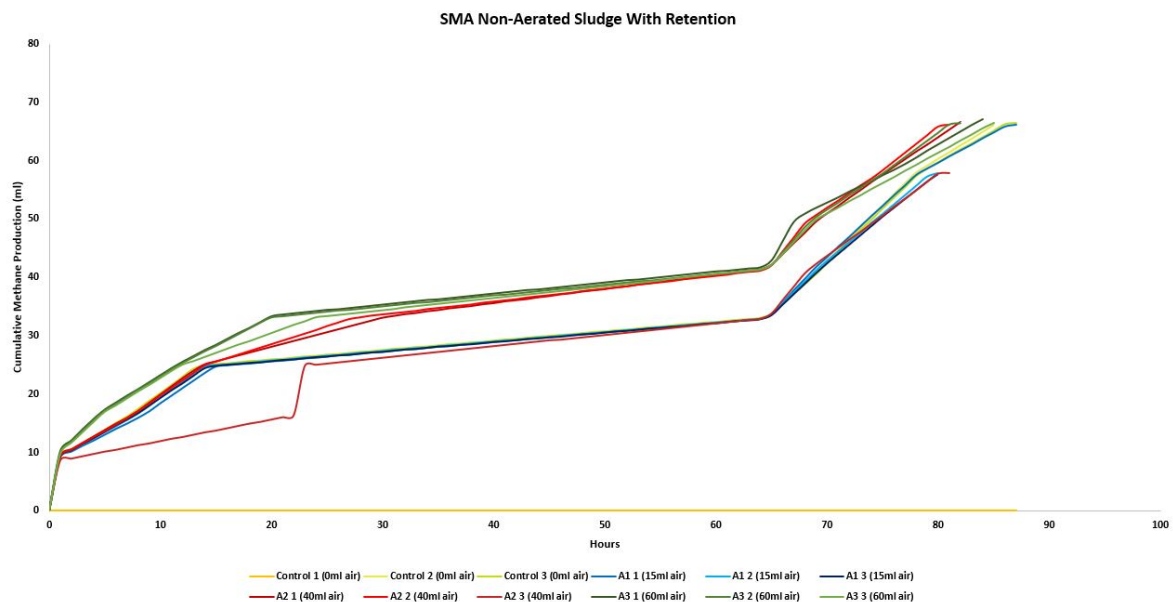

Figure 4.10: The Cumulative Methane Production of Non-Aerated Sludge for Different Air Additions and Retention of Air Pulses for 20 Minutes.

The batch test was performed with the non-aerated inoculum collected from the AnMBR. An aeration of 15ml, 40ml and 60ml were added in pulse through the liq-

uid phase and retained in the bottles for 20 minutes. The experiments were run in triplicates.

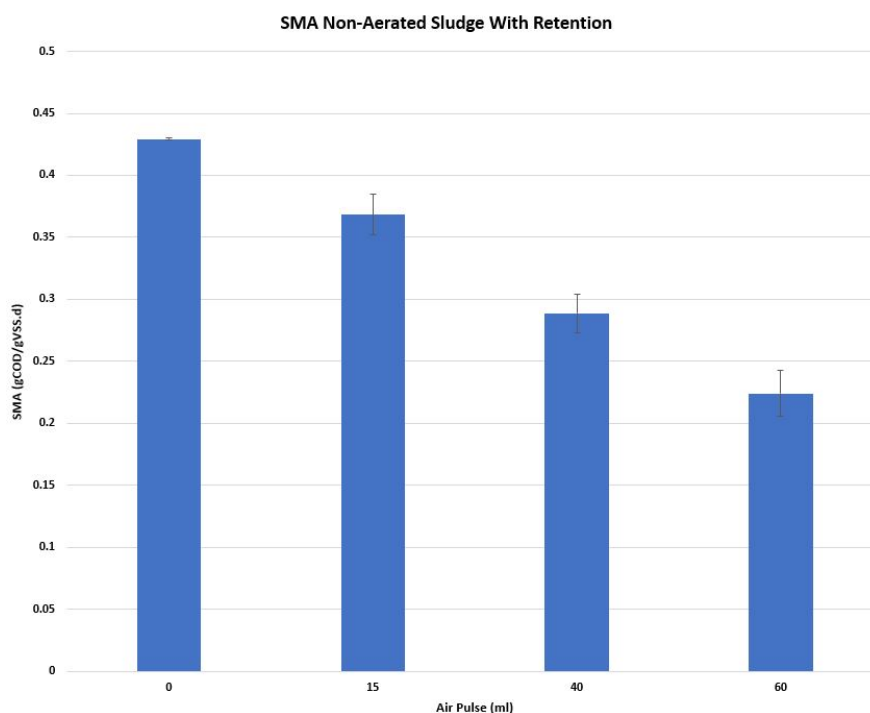

Figure 4.11: The Average SMA Values of Non-Aerated Sludge for Different Air Additions and Retention of Air Pulses for 20 Minutes.

The SMA of the non-aerated sludge, introduced with different aeration pulses are represented in Figure 4.11. It can be seen that the average SMA of the control is $0.43 \text{ gCH}_4 - \text{COD/gVSS.d}$. It can also be observed from the Figure 4.11 that the activities of sludge exposed to aeration pulses, have considerably reduced when compared to the control.

The first set of bottles were exposed to 15ml of air pulse and was retained for 20 minutes. The SMA of the 15 ml aerated batch reduced by 14.26% when compared to the control. The 40ml aeration batch had a decrease of 33.76% in the activity and the batch which was introduced with 60ml of air had a decreased in 47.78% in the activity.

The SMA of the first set of aeration (15ml air pulse), was compared to the SMA of control and the ANOVA results of the two groups are as shown in Table B.8. The p-value of the test (0.010656) was found to be lesser than the alpha value (0.05). This means that the null hypothesis (that the two groups are the same) is declined. Hence, there is a significant difference between the average SMA of the two groups.

Therefore, the added aeration pulse of 15ml, caused a significant reduction in the activity of the methanogens by 14.26%.

Similarly, the SMA of the second and third batch of aeration, corresponding to 40ml air pulse and 60ml air pulse respectively, were compared to the SMA of the control. The results of the ANOVA tests are provided in Table B.9 and Table B.10 respectively.

The Table B.9, provides us with information that the f value is greater than the f-critical value and the p-value is lesser than our alpha value. Hence, there is indeed a significant difference between the control and the 40ml aeration bottles. Therefore,

the added aeration pulse of 40ml, caused a significant reduction in the activity of the methanogens by 33.76%.

In the Table B.10, the f value is higher than the f -critical value and the p -value is less than 0.05. Hence, there is a significant difference between the control and the 60ml aeration bottles.

Thus it can be inferred that with the non-aerated sludge subjected to a 20 minute retention time, there is a significant reduction in the SMA with different aeration pulses. Therefore, the added aeration pulse of 60ml, caused a significant reduction in the activity of the methanogens by 47.78%.

It can be seen from the above results that the provided aeration inhibited the activity of methanogens in the non-aerated sludge. This inhibition could be related to the exposure to sudden changes in the environment. Kato *et al.* [88] reported that rapid aeration increases the risk of toxicity of methanogens. Hence, the sludge adaptability was studied with aerated sludge obtained from the reactor.

4.3.3. SMA of Aerated Sludge - Week 1

The AnMBR was planned to be aerated to $14.7 \text{ mlair}/L_r/d$. In order to reach this value, the aeration was added in batches, with each batch lasting for at-least 3 HRTs. The aeration was started with $4.9 \text{ mlair}/L_r/d$. The sludge was collected for a period of 3 HRTs and stored in the refrigerator at 4°C and batch tests were performed with this collected inoculum.

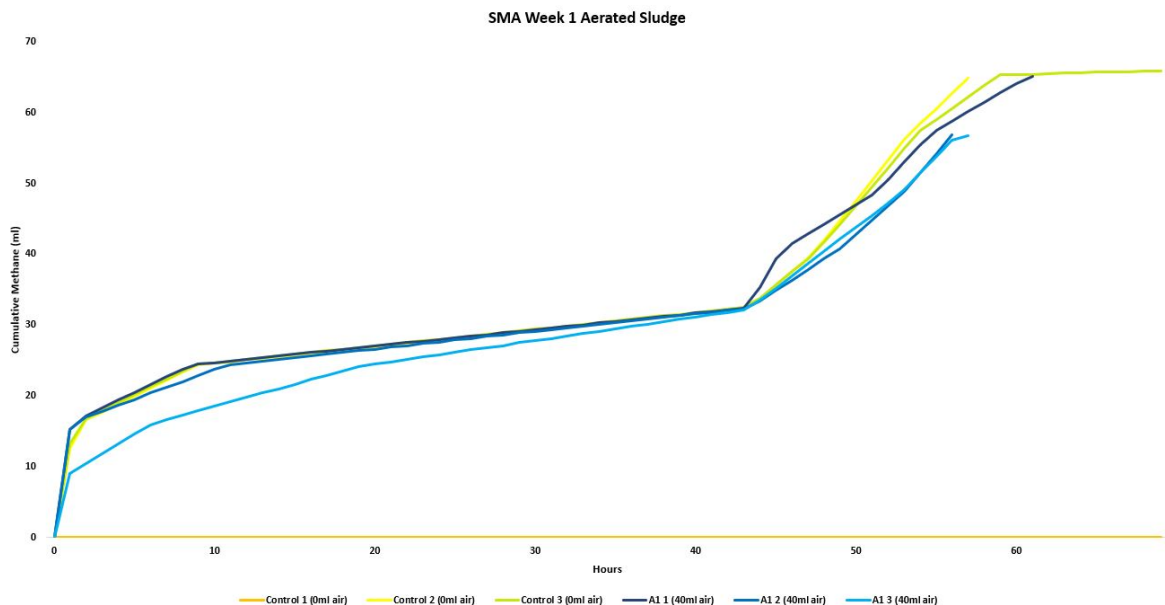

Figure 4.12: The Cumulative Methane Produced for the First Batch of Aerated Sludge for Control and 40ml Added Air Pulse

As there was not enough inoculum collected for the tests, an aeration of 40ml was done in addition to a set of negative control and positive control. This gives us just one data point to compare with the control. The SMA was calculated from the slopes of each bottles in Figure 4.12, after subtracting the methane from the blanks.

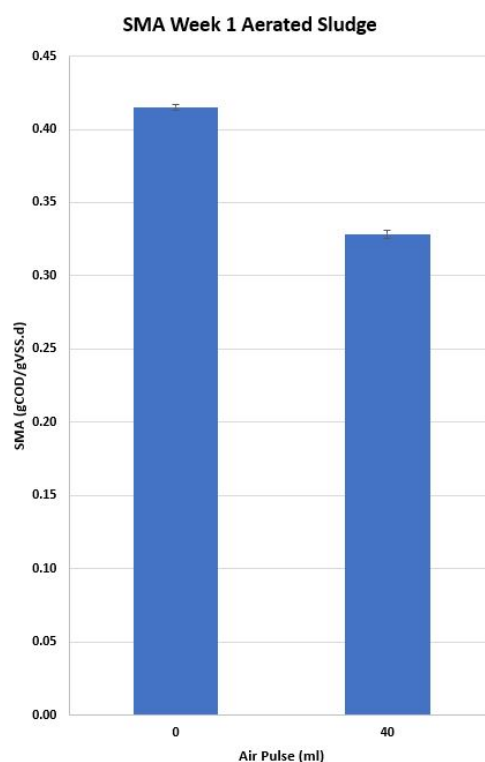

Figure 4.13: The Average SMA Values of First Batch of Aerated Sludge for Control and 40ml Added Air Pulse

The average SMAs of the control and inoculum added with 40ml aeration pulse is shown in Figure 4.13. It can be noticed that the SMA of the aerated bottle is less when compared to the control. Here, a difference of 20.92% in the activity was observed when compared to the control.

Similar to the previous section, the average SMA of the aerated batch was compared to the average SMA of the control with a single factor statistical ANOVA test. And the results are tabulated in Table B.11

It can be seen from Table B.11, that the p-value is less than 0.05 and the f is greater than f-critical, thereby rejecting our null hypothesis again. Once again, the added aeration caused a significant reduction in the activity of the methanogens by 20.92%. Though there is a significant reduction in the average SMA of the aerated bottle, it can be seen that the reduction in activity has decreased from 33.76% in the non-aerated sludge to 20.92% in the aerated sludge.

4.3.4. SMA of Aerated Sludge - Week 2

The next batch of sludge was collected from the AnMBR now being fed with 9.8 $ml\ air/L_r/d$. Similar to the previous batch, this was also collected and stored at 4°C. The SMA tests were performed in triplicates with this inoculum.

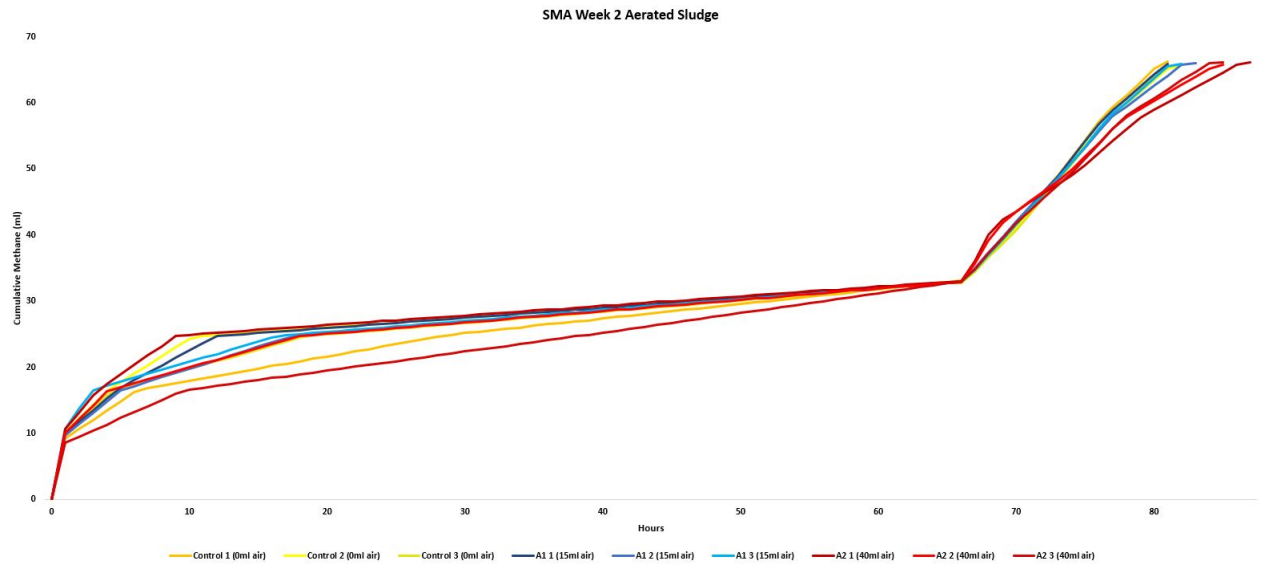

Figure 4.14: The Cumulative Methane Produced for the Second Batch of Aerated Sludge for Different Added Air Pulses

The cumulative methane production was calculated for each set of bottles in triplicates and the resulting graph is depicted in Figure 4.14. The batch involved a set of negative and positive control and a case with 15ml air pulse and another case with 40ml air pulse. The SMA was calculated for each set and averaged after subtracting the negative control.

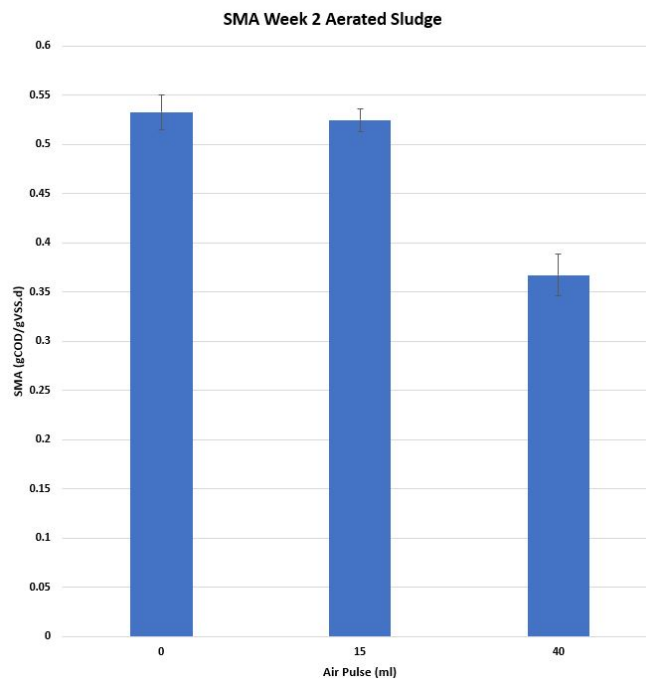

Figure 4.15: The Average SMA Values of Second Batch of Aerated Sludge for Batch with Added Air Pulses

It can be noted from Figure 4.15 that the difference between the SMA of the batch with 15ml aeration has a very small difference compared to the control. It has a difference of 1.55% when compared to the control. The reduction in the SMA of the

40ml aeration batch was found to be 31.05%. The SMA in the 40ml aeration batch was better than the SMA of the non-aerated sludge for similar conditions.

Similar to the previous cases, ANOVA tests were performed to know the significance between the SMA values. Table B.12, shows the ANOVA results of the activities of the control and the batch sample with 15ml aeration.

It can be inferred from Table B.12, that there is no significance between the control and the 15ml aerated batch. Hence, the activity of the non-aerated batch is similar to the activity of the batch aerated with 15ml of air pulse. Hence, it can be stated that the provided aeration pulse of 15ml did not repress the activity of methanogens.

There was a difference of 30.05% in the activity of the 40ml aerated batch when compared to the control. Table B.13, shows us that this difference is indeed significant. It can be seen that the f value is higher than the f-critical value and p-value lower than the alpha value of 0.05.

Even though there is a significant difference in the activity of the 40ml aerated batch, there seems to be an increase in activity when compared to the non-aerated sludge for the same amount of added air. The difference in activity of the 40ml batch, has reduced from 33.76% while using the non-aerated inoculum, to 30.05% in using the aerated inoculum. Hence it can be commented that the sludge is adapting to the aeration provided in the AnMBR.

4.3.5. SMA of Aerated Sludge - Week 3

The AnMBR had now been supplied with $14.7 \text{ mlair}/L_r/d$, which is the planned air addition in the AnMBR. The sludge was collected everyday and stored at 4°C for at-least 3 HRT and used for the batch test.

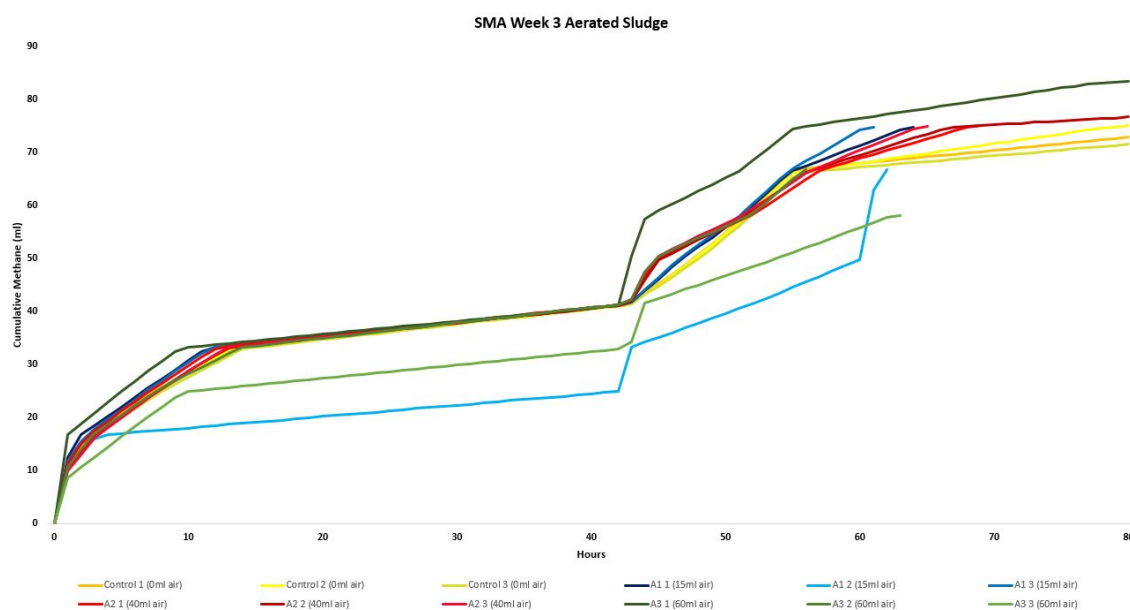

Figure 4.16: The Cumulative Methane Produced for the Third Batch of Aerated Sludge for Different Added Air Pulse

The cumulative methane produced for every bottle in each batch was measured and plotted as in Figure 4.16. The slope of the bottles were used to calculate the specific methanogenic activity of each bottle. The bottles (in triplicate) represented a negative control, a positive control, 15ml aerated batch, 40ml aerated batch and 60ml aerated batch.

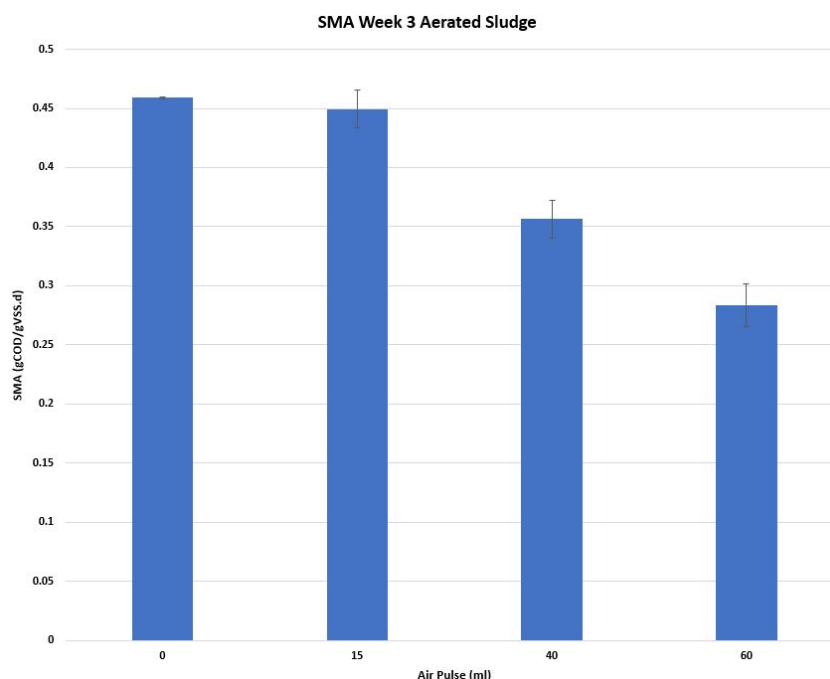

Figure 4.17: The Average SMA Values of Third Batch of Aerated Sludge for Different Air Pulses

The average SMA of the control and the different aeration conditions are presented in Figure 4.17.

As done in the previous sections, ANOVA test was performed to analyse if the obtained difference in the activity was significant. Table B.14 shows the ANOVA results for the control and 15ml aerated bottles.

It can be noticed that the f value is lesser than the f-critical and p-value is more than the alpha value of 0.05, confirming our null hypothesis. That is the difference of 2.08% between the SMA of the control and the 15ml aerated batch is not significant. Here as well, the activity of the methanogens are not reduced by the addition of 15ml air pulse in the batch.

Table B.15 shows the ANOVA results of control and 40ml aerated batch. It can be seen that there is a significant difference between the activities of the control and the 40ml aerated batch. The difference between the activity was found to be 22.38%. This was lesser than the differences observed in the SMA tests using non-aerated sludge and week 2 aerated sludge. Hence, it can be stated that the sludge is adapting to the provided aeration.

A difference in SMA of 38.17% was observed between the both. Table B.16 shows us that this difference is significant. It can be seen that the f value is higher than f-critical and p value is very much less than 0.05. Here as well, when compared to the SMA done with the non-aerated sludge, the difference between the activity of the control and the 60ml batch has reduced from 47.78% to 38.17%.

4.3.6. Determination of Inhibition

The Sections 4.3.2 - 4.3.5, gives us the average SMA values of different aeration, performed on non-aerated sludge and sludge adapting to the different aeration provided in the AnMBR. It can be seen that the activities unanimously reduce with the added aeration. Some of these are significant and some are not, as discussed earlier. These values of decreased activity can be used to determine the inhibitory concen-

tration (IC) of air pulse on the methanogens.

IC50 is a commonly used term in chemistry used to calculate the inhibitory concentration. It is defined as the concentration of an inhibitor when the response drops to 50% of the initial value. In this case, air/oxygen is the inhibitor. The response is the response of reduced methanogenic activity.

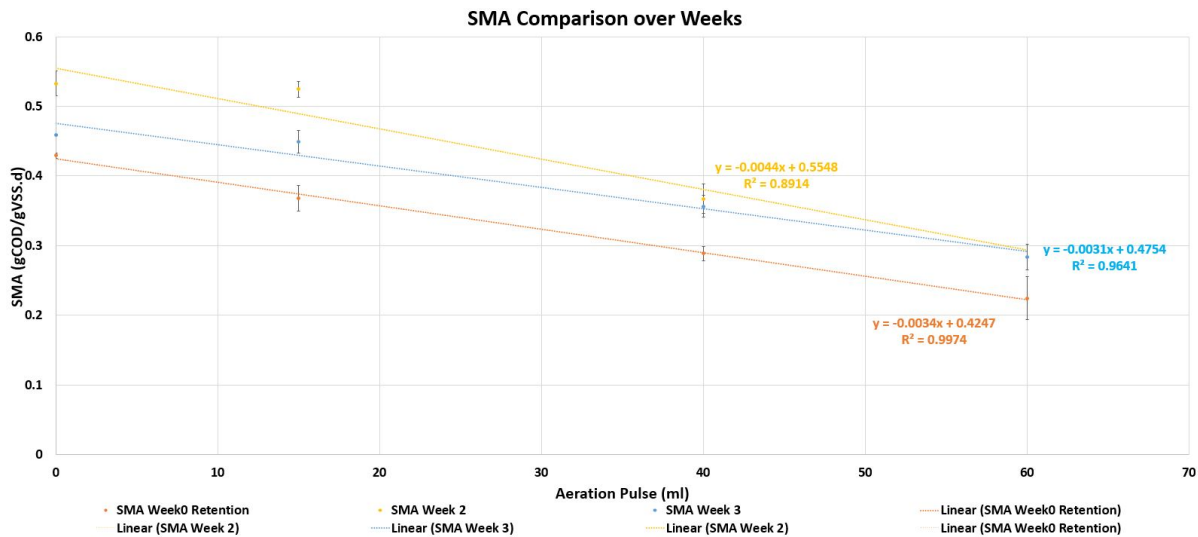

Figure 4.18: Comparison of Average SMA for various Aeration for Inoculums, Subjected to Different Aeration Over the Weeks

The average SMA of provided aeration with respect to their control, for all of the used inoculums are provided in Figure 4.18. The average SMA of week 1 is not featured in this graph owing to having only one data point outside the control. The plotted points were connected with a linear fit.

The non-aerated sludge, was fit with a linear trend with an R^2 value of 0.9974.

$$y = -0.0034x + 0.4247 \quad (4.2)$$

Using Equation 4.2, the IC50 was found to be 60.64 ml of air. Thus for the non-aerated sludge, a pulse of 62.85 ml air would have caused inhibition of 50%.

The SMA performed on the inoculum, collected in the second week of aerating the reactor (with 1.36% increase in O_2), and subjected to different aeration, is plotted in the Figure 4.18. The plots are fit with a linear trend with an R^2 value of 0.8914. The equation is as follows:

$$y = -0.0044x + 0.5548 \quad (4.3)$$

The Equation 4.3 was used to determine the IC50 for this inoculum. Considering a 50% drop in response, the IC50 was found as 63.05 ml of aeration.

The average SMA of different aeration provided for the third week of aerated sludge (with 2.02% increase in O_2), are plotted in Figure 4.18. These plots have been fit as a linear trend with R^2 being 0.9641.

$$y = -0.0031x + 0.4754 \quad (4.4)$$

Equation 4.4, gives us the function of this fit. The IC50 was calculated as 76.67ml air.

The minimum aeration that could have been provided from the DAF system was calculated as 320mlair/d. This value of aeration, corresponds to an 8% increase in O_2 corresponding to the VSS of AnMBR. This increase in oxygen was calculated with each batch and the inhibition caused by this amount of aeration is provided in Table 4.3.

Table 4.3: Reduction in Activity with DAF Pulses

Sample	DAF as Aeration Pulse (ml)	DAF as % Increase in O_2	Reduction in Activity (%)
Non-Aerated Sludge	115	8	91.48
Week 2 Batch	115	8	91.21
Week 3 Batch	115	8	74.98

It can be seen from Table 4.3 that the reduction in activity has improved from 91.48% in the non-aerated batch to 74.98% in the week 3 aerated batch. The lower reduction can be attributed to the adaptability of the methanogens overtime to the applied aeration. With more data points, a higher precision can be obtained in this data.

Though the aeration provided in the batch assays still cause a significant reduction in activities, it can be seen that with the aerated sludge of the third aeration, the inhibition is considerably lesser when compared to its previous batches. This says that the methanogens are adapting to the applied aeration. Better results in terms of reduced inhibition to higher aeration, can be expected with a better adapted sludge.

4.4. Fate of Nutrients in the AnMBR Before and After the Limited Aeration

The feed consisted of macro and micro-nutrients fed to the reactor along with the organic fraction. The fate of ammonia, phosphate, sulphate and nitrate in the AnMBR are discussed in this section of the chapter. These nutrients are considered, as they play a major role in reuse of water or when designing a post-treatment system. The nutrients were measured once every two weeks through the reactor operation.

4.4.1. Fate of Ammonia in the AnMBR

The concentration of ammonia increases under anaerobic conditions due to ammonification of organic nitrogen [34, 48]. The increase in ammonia concentration was observed in this study as well with the effluent values reaching thrice the influent values. The influent and effluent concentrations of ammonia are plotted in Figure 4.19.

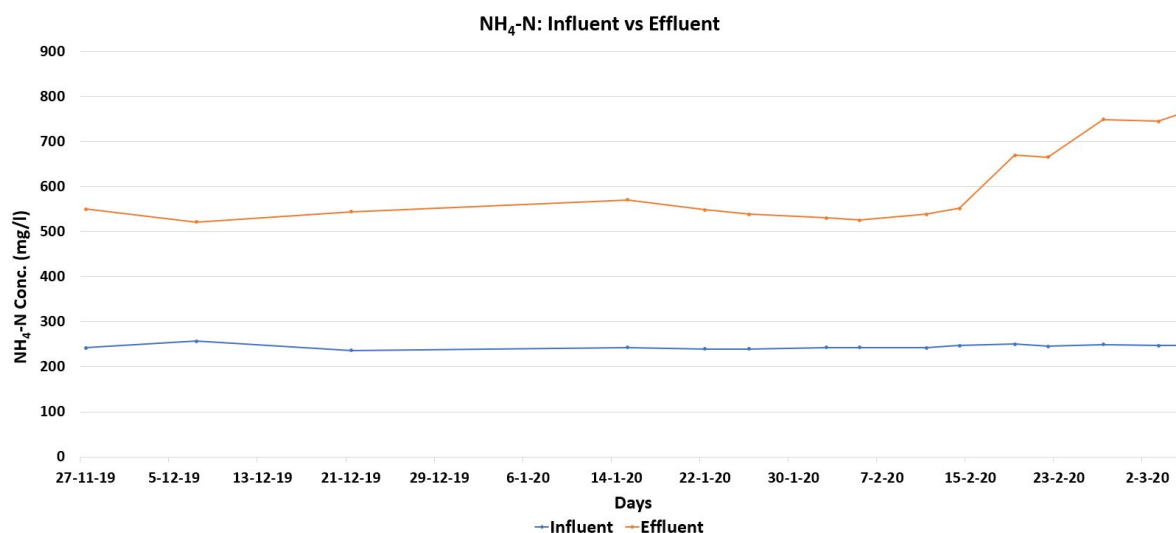

Figure 4.19: The Influent and Effluent Ammonium Concentration in the AnMBR

It can be seen from the Figure 4.19 that the influent values decreased from 680 mg/l to 250 mg/l. This variation can also be linked to the feed used before the stabilization period as explained in Section 3.4. Table A.4 from Appendix A, and Table 3.2 from Section 3.1.3 can be compared to see that there is a huge difference in the concentration of ammonium chloride and urea in the feed which is responsible for the variation of influent concentration.

The effluent ammonium concentration can be seen to have a steep increase at the end of Figure 4.19. The increase in the ammonium concentration happened after 21 days of aerating the AnMBR. By this time, two sets of aeration were already introduced and the third set of aeration was introduced. The difference in the ammonium concentrations were tested with every added aeration and the significance of variation between the aeration cycles were tested using Single Factor ANOVA tests.

Table B.17 shows that there is no significance in the observed average values of ammonium concentration in the non-aerated sludge and the sludge exposed to 4.9 mlair/ L_r/d (0.68% increase in O_2). It can also be seen from Table B.18 that there is no significant variation between the observed average removal of NH_4-N values between the non-aerated batch and the batch aerated with 9.8 mlair/ L_r/d (corresponding to 1.35% increase in O_2).

Table B.19 provides the ANOVA results of the variations between the average ammonium concentration in the effluent of the non-aerated batch and the batch exposed to third aeration cycle of 14.7 mlair/ L_r/d (2.02% increase in O_2). It can be seen that the p value is less than 0.05, hence there was a significant variation noted in the ammonium concentration in the effluent during this period. It was observed that the ammonium concentration in the effluent increased by 24% when compared to the non-aerated batch, as the average effluent concentration increased from 550mg/l to 720 mg/l.

The increase in the ammonium concentration could be related to a better degradation of nitrogen containing substrates such as proteins and urea. Stickland reaction states that ammonia is released during acidogenesis of amino acids [23]. Lim *et al.* [23] and Diak *et al.* [89], observed an increase in the effluent ammonium concentration whilst providing limited aeration from 27% without aeration, to 34% with aeration. Hence, the increase in the ammonium concentration after aeration could be

attributed to better degradability and ammonification of nitrogen rich organic compounds.

4.4.2. Fate of Nitrate in the AnMBR

Anaerobic environment causes dissimilatory reduction of nitrate to nitrite, which either gets converted to nitrogen or nitrous oxide or ammonia [90]. Hence, a reduction in nitrate concentration can be expected. Figure 4.20 plots the influent and effluent nitrate concentrations in the AnMBR.

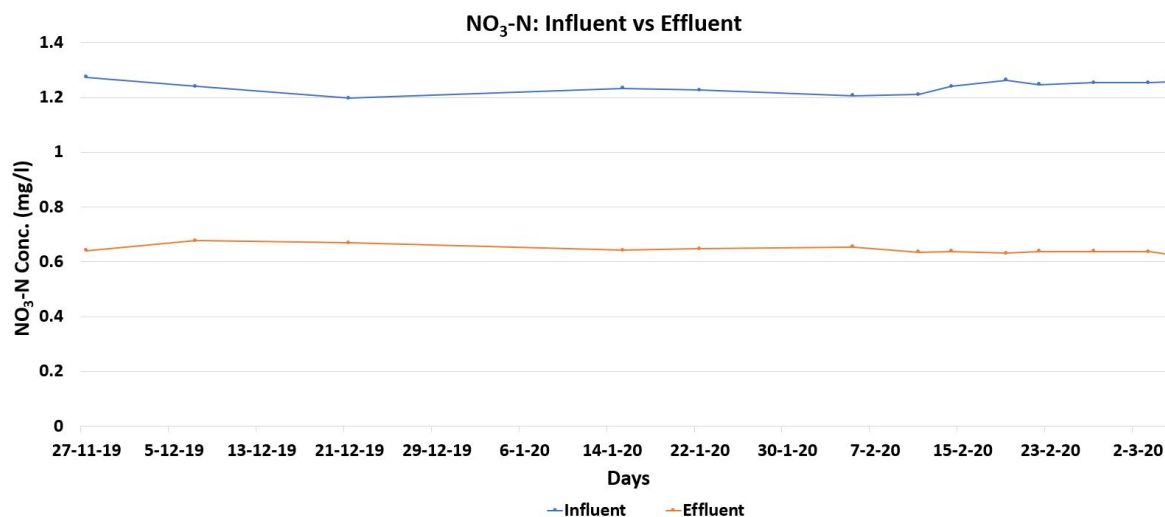

Figure 4.20: The Influent and Effluent Nitrate Concentration in the AnMBR

It can be seen from Figure 4.20 that the nitrate in the effluent is lesser than in the influent. An average removal of 50% was observed. An ANOVA test was performed to determine if there is any significant difference in the average nitrate values before and after introducing aeration.

The p-value is greater than 0.05 and f value is lesser than f-critical value in Table B.20. This says that the null hypothesis can be accepted and there is no significant difference between the two groups. Hence, the observed decrease in the average removal of nitrate upon addition of $14.7 \text{ ml air}/L_r/d$ in the reactor is insignificant. Therefore, the added aeration had no effect on the nitrate removal. It was also observed that there was no nitrite production and the value remained below detection limit. Thereby, it can be said that the nitrate in the reactor readily dissimilated to ammonia. It can also be related to the increase in ammonia concentration in the effluent.

4.4.3. Fate of Phosphate in the AnMBR

Since there is a release of Phosphate in anaerobic conditions, the concentration of phosphate also increases in the AnMBR [34, 48]. The fate of ortho-phosphate in the influent and effluent is depicted in Figure 4.21. Here as well, we can see that there is a difference in the influent value of the phosphate. This can be again related to the feed stabilization as explained in Section 3.4. The potassium phosphate used in the feed was reduced from 2.8g/l to 0.2g/l.

It can be noted from Figure 4.21, that the effluent phosphate concentrations were lesser than the influent concentration. An average removal of 18.5% was observed. Unlike $NH_4 - N$, the ortho-phosphate did not increase with time. It followed the same

trend as the influent. The total phosphor content is very small when compared to the influent COD with a P:COD ratio of 0.02:1. The phosphorous could be adsorbed to the sludge and not released as ortho-phosphorous.

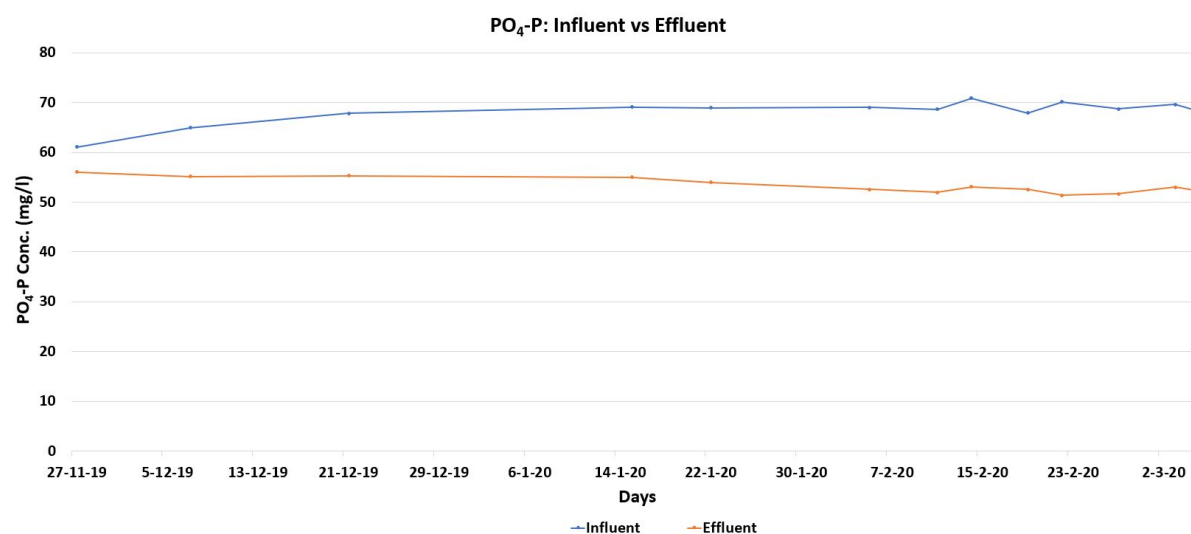

Figure 4.21: The Influent and Effluent Ortho-Phosphate Concentration in the AnMBR

It can also be seen from Figure 4.21 that the concentration of $PO_4 - P$ in the effluent changes in accordance with the change in the influent, even after the reactor is aerated. An average removal of 20% was observed in the ortho-phosphate concentration. A statistical single-factor ANOVA test was performed to identify if there was any significant difference in the removal values before and after aeration.

It can be seen from the Table B.21 that the f value is lesser than the f-critical value and p value is higher than the alpha value of 0.05. Hence, the null hypothesis can be accepted. Meaning, there is no significant difference between the removal efficiencies observed during the non-aerated phase and after aerating the reactor with the planned aeration of $14.7 \text{ ml air}/L_r/d$. Hence, we can conclude the added aeration did not play a role in increasing the ortho-phosphate removal efficiency. So, the phosphate in the effluent was not influenced by the provided aeration and followed the trend of the influent concentration.

4.4.4. Fate of Sulphate in the AnMBR

The sulphate present in the wastewater feed is reduced by Sulphate Reducing Bacteria (SRB) in anaerobic conditions. Sulphate is used as the electron acceptor of the SRBs in strictly anaerobic conditions. SRBs can yield H_2S and CO_2 when they completely oxidize the organic matter and an incomplete oxidation would yield acetate [91]. Hence a reduction in sulphate can be noted in anaerobic conditions.

The influent and effluent concentration of sulphate is plotted in Figure 4.22. Here as well, the variation in the influent concentration can be noted and can be related to the feed optimization as reported in Section 3.4. An average removal of 82% was observed.

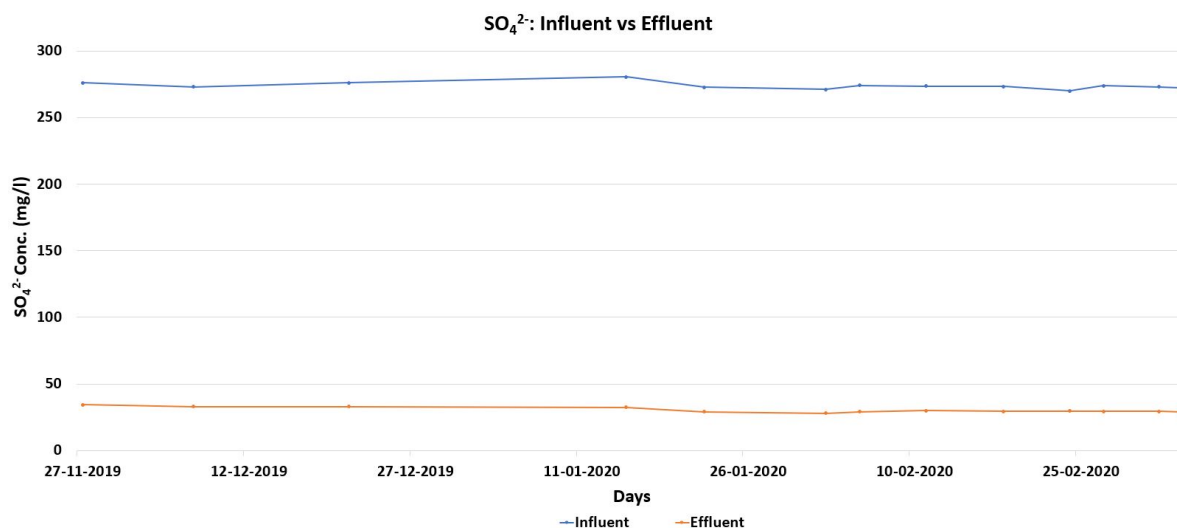

Figure 4.22: The Influent and Effluent Sulphate Concentration in the AnMBR

It can be seen that there is a decrease in the effluent sulphate concentrations by 88% caused by the action of the SRBs. SRBs use sulphate as the electron acceptor to carry out the degradation of organics. Providing an additional electron acceptor (oxygen) through limited aeration, should reduce the competition between the SRBs and methanogens.

Tang *et al.* [92], found that there was no reduction in the activity of SRBs under limited aeration conditions. Since the sulphide concentrations could not be measured, a direct comment cannot be made on sulphide oxidation by Sulphide oxidizing bacteria. But in case of oxidation of sulfide, the end product could have been elemental sulphur or thiosulfate and thereby not increasing the sulphate concentration in the effluent [93].

An ANOVA test was done to see if there was any difference in the removal before and after aeration. The removal of non-aerated sludge was compared with the removal obtained during the final added aeration and the values are tabulated in Table B.22. There is a significant difference between the two groups ($p = 0.0025$). Thus the provided aeration has enhanced the sulphate removal in the AnMBR by 12%.

4.5. Other Operational Parameters of Reactor

The reactor operated for 134 days was monitored for pH, ORP, Biogas production and composition and VFA almost on a daily basis. These parameters showed variations during the reactor operation and after introducing the limited aeration. This section will discuss the variation in each of these parameters in detail.

4.5.1. Observed Changes in the pH of Reactor

The pH of the influent, effluent and sludge were monitored over the operation period. The influent pH was observed to be in the range of 6-8 from when it was made to when it was consumed completely. At this point of time, the remaining feed was already discarded and a new set of feed was fed into the system. The pH of the effluent was slightly alkaline with a pH around 8 and the reactor was operated with a pH ranging from 7.3-7.7. Figure 4.23 represents the observed pH readings of the influent, effluent and the mixed liquor in the digester.

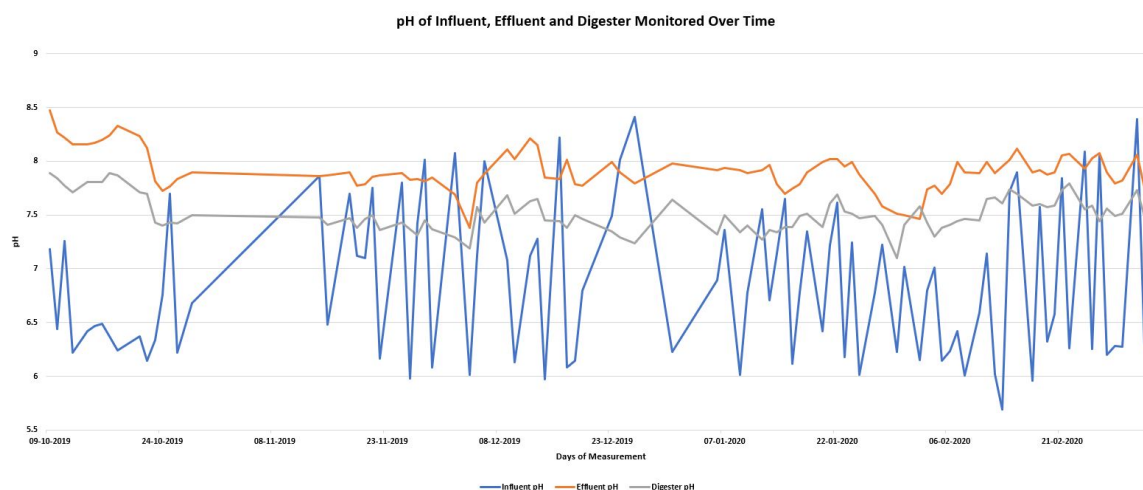

Figure 4.23: pH Variations of the Influent, Effluent and Digester Liquid

As stated earlier, we can see the influent pH varying from 6-8 over a period of three days. It was observed that the pH of the fresh feed was around 6 (as soon as it was prepared) and then a gradual increase in the pH was observed over the next days. The measured COD of the influent varies from 4.9gCOD/l to 5.4gCOD/l during this period and this can be seen in Figure 4.1.

It can be seen that the pH of the effluent and the sludge follow a similar trend and this value sees an increasing trend towards the end. This increase in the digester pH (from 7.3-7.8) can be related to the increase in the $NH_4 - N$ concentration. The released ammonia will partially combine with water forming hydroxyl ions, increasing the alkalinity [23]. Thus as observed, the limited aeration increased the pH of the reactor.

Increase in pH results in precipitation of phosphate ions as calcium and magnesium salts [94]. Möller and Müller [94] and Bouropoulos and Koutsoukos [95], state that at pH higher than 8.5, phosphate precipitates as struvite. The high pH in the effluent measured at an average value of 8, could also be related to a lower orthophosphate concentration in the effluent as the phosphate could have precipitated on to the digester sludge as calcium and magnesium salts [94].

4.5.2. Observed Changes in the Oxygen Reduction Potential

The ORP was monitored daily to know the concentration of oxidants in the reactor. It can be seen from Figure 4.24 that the ORP of the system reached to -500mV after 59 days of operation. The average ORP of the system was observed to range between -520mV to -540mV. This shows that the substrates provided are highly degradable. The ORP increased rapidly to values as high as -350mV during sludge extraction from the reactor. The ORP would gradually decrease to its initial value in a couple of hours. It was observed that after introducing aeration, this sudden shoot up of ORP reduced while sludge extraction. The ORP would gradually rise to -450 to -480mV and return to its original value gradually.

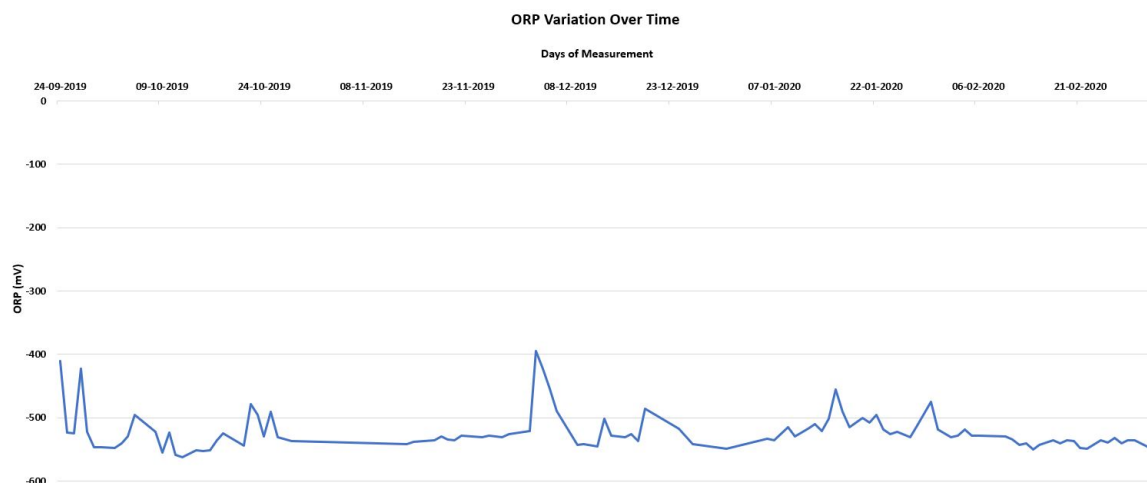

Figure 4.24: ORP Variation in the Reactor

It was observed that the average ORP increased to around -500mV during the first week of aeration. [Lim et al.\[23\]](#), observed a similar increase in ORP while introducing limited aeration and the ORP stabilized overtime. Raising ORP values indicates that the organisms did not yet adapt to the added quantities of aeration. But after 14 days of aeration, the ORP again dropped below -520mV indicating that the organisms could have adapted to the added aeration.

The aeration was intermittently applied to the reactor where the aeration was applied in 3 cycles with 4 hours aeration and 4 hours rest time. This was to ensure that there was no abrupt increase in oxygen concentration causing toxicity. The observed ORP indicates that the applied aeration did not cause any sudden increase in the value. The effect of aeration on the methanogenic activity of the sludge is studied and explained in later sections of this chapter.

4.5.3. Observed Changes in the VFA

As explained in Section 2.1.2, VFAs are bi-products of acidogenesis which are further digested to yield biogas. The concentration of intermediate non-dissociated VFAs such as propanoic acid, butanoic acid, caproic acid and other carboxylic acids present in the system, will act as inhibitory compounds to the methanogens. [van Lier et al. \[1\]](#), states that incomplete digestion is one of the major reasons for the production of intermediate acids.

Figure 4.25 represents the concentration of the VFA in the extracted sludge samples from the reactor. It can be observed that in most of the days of measurements, there is no VFA found in the reactor liquid. This again indicates that the substrates fed are readily consumed by the organisms and indicates that the feed provided is highly biodegradable. It can be seen that in the initial days of operation, there is a spike in the acetic acid and propionic acid concentration. The presence of acids can be seen can be related to the higher dosage of COD in the initial days and uneven mixing by re-circulation pump. The VFA was also monitored in the effluent and there were no VFAs found in the effluent.

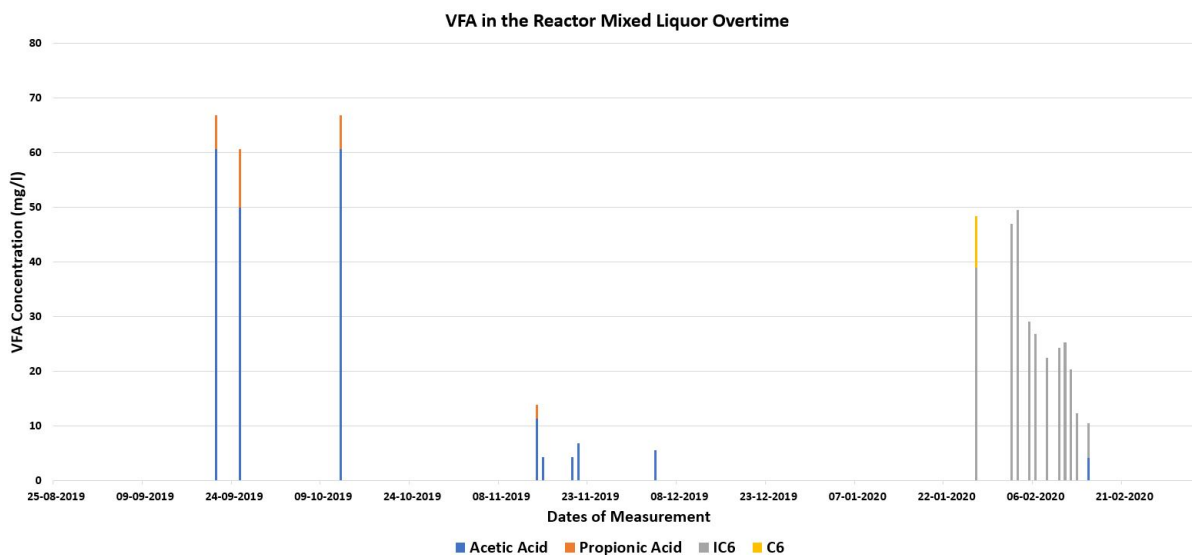

Figure 4.25: VFA Concentration in the Reactor Liquid

It can also be observed from Figure 4.25 that there is IC6 (iso-caproic acid) and C6 (Caproic Acid) in the sludge after the aeration was introduced into the system. Sudden change in the anaerobic environment due to the aeration could have triggered this fatty acid production. It was also observed that the VFA concentration reduced gradually to nil by the time the third batch of aeration was introduced. As it was observed from other results, the sludge adaptability to aeration could be a reason for this reduction of VFA.

4.5.4. Observed Changes in the Biogas Production

The biogas flow from the reactor was monitored on a daily basis. The average biogas production was observed to be in the range of 2.3-2.5 l/d. Variations in t=daily production of biogas production were observed due to operational constraints. Despite having variations, the COD of the system was balanced and the COD balance as explained in Section 2.1.5, was done and reported in Appendix A.

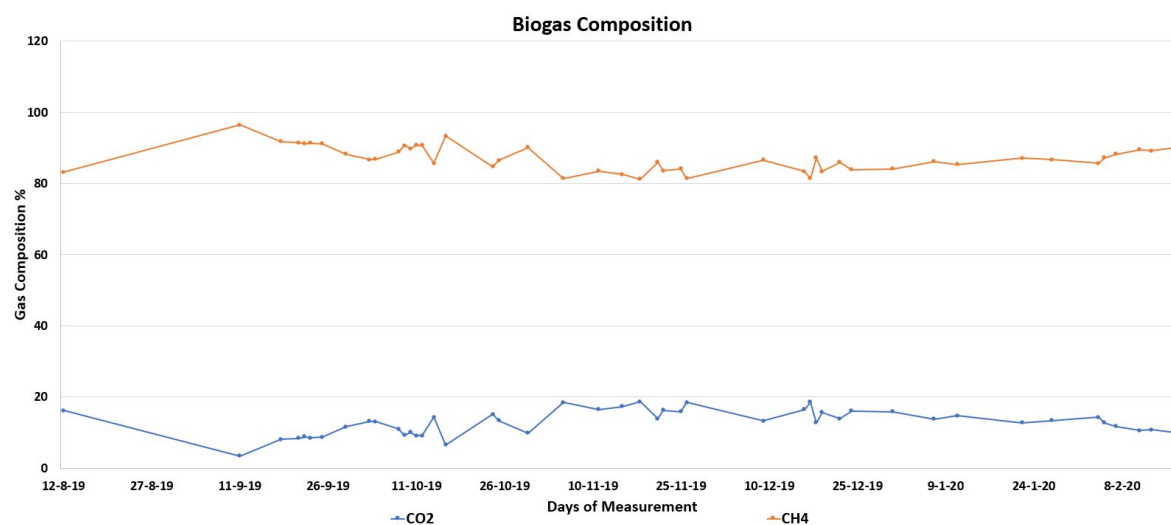

Figure 4.26: Biogas Composition Monitored Over Time

During the reactor operation, the biogas composition was also monitored. A biogas sample of 10ml was extracted from a sampling point fitted with a thick butyl stopper. The extracted sample was injected in the GC-Biogas machine and the resultant gas composition was obtained. The gas correction to eliminate carrier gas peaks were made and the composition was reported in percentages of CO_2 and CH_4 . The observed changes in the gas composition is represented in Figure 4.26.

It can be seen from Figure 4.26 that the percentage of the methane increases after 14 days of aeration. It was observed to increase after 6 HRTs after the aeration began. This depicts that the added aeration of $14.7 \text{ mlair}/L_r/d$ (corresponding to 2.02% increase in O_2), has increased the quality of biogas of the system by increasing the methane composition by 5%.

Table B.23 provides the ANOVA results of the biogas quality before and after the aeration was introduced. It can be seen that the observed increase in the methane quality is significantly higher ($p=9.39E-05$) in the aerated batch (with $14.7 \text{ mlair}/L_r/d$) than in the non-aerated batch. The reactor should be monitored under stable conditions with better mixing to comment more on the quantity of biogas generated overtime.

4.5.5. Changes in the Particle Size Distribution of Sludge Overtime

The particle size distribution (PSD) is said to be an important physical characteristic which influences other fluid parameters such as flow and compaction [68]. As explained in Section 3.2.4, the PSD of the sludge was determined using tri-laser technique. The PSD of the sludge was measured as a function of number of particles, area covered by the particles and volume occupied by the particles. Since the study aims to see the effect of particle growth, the representation is done as a function of number.

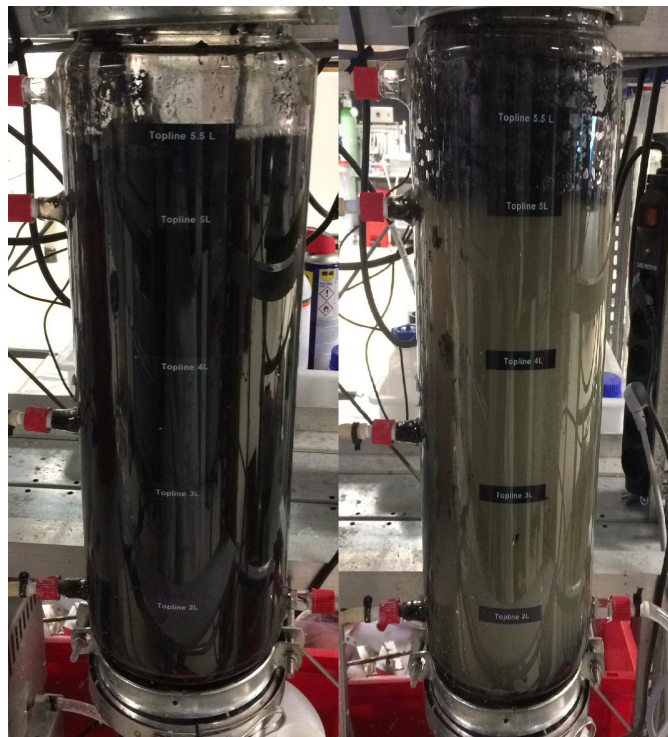

Figure 4.27: Reactor Liquid During the Process and When Re-circulation was Stopped

According to Stephenson *et al.* [96], sludge granules are formed when an equilibrium exists between the growth of bacteria and uncoupling of outer layer of organisms due to abrasion. They also found that the applied aeration aided growth of smaller particles. With provided aeration, the density of the sludge decreases as aerobic biofilm is formed over the anaerobic sludge particles [96]. Thaveesri *et al.* [97], also says that with COD : O_2 ratio < 0.5 , fluffy sludge is formed causing clubbing of sludge granules with each other.

The reactor sludge during the operation and when the recirculation was stopped, is shown in Figure 4.27. It can be observed that the some of the sludge particles float on top of the reactor when the re-circulation is stopped. This shows that the density of the sludge particle is lesser than that of the liquid. The study has to be prolonged to measure the effect of aeration on the density of the particles.

The particle sizes can be represented by D90, D50 and D10 sizes. D90 corresponds to the particle diameter of which the entire distribution will have 90% of its fraction below this value and the rest 10% will have a higher value. This represents the coarser fraction of the distribution. D50 corresponds to a mean size where 50% of the particle population will fall under this value and the rest 50% will be over this value. D10 corresponds to a finer population where 90% of particles will have diameter over this value and rest 10% will be below this value. In order to represent the particle size of the sludge particles, it is advised to represent all the three fractions together to gain an insight on how the particles are distributed [68].

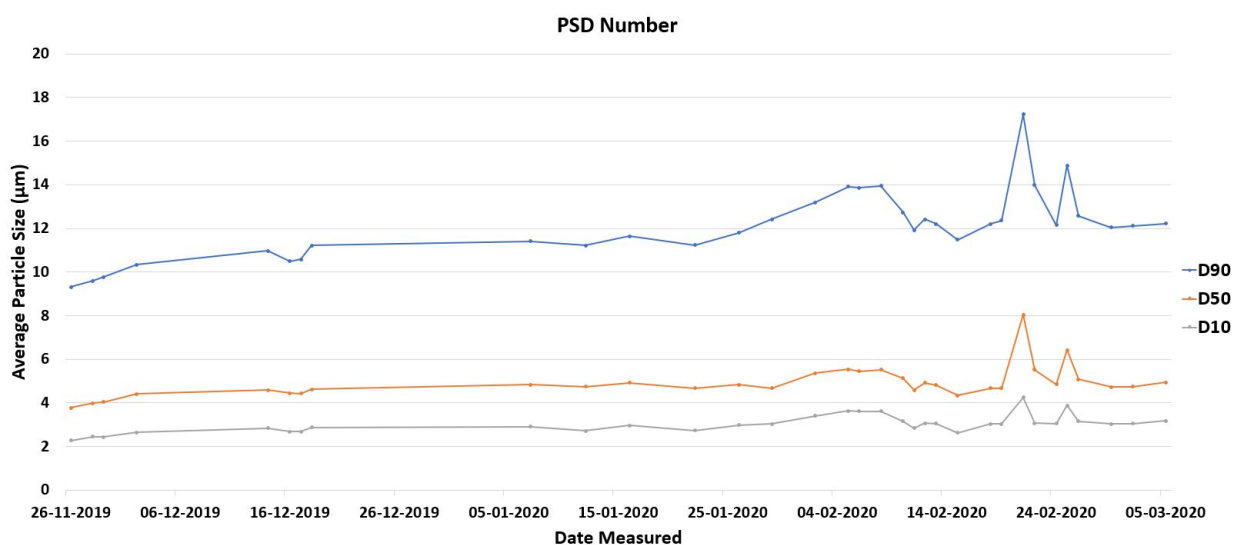

Figure 4.28: The D90, D50 and D10 PSD of the Reactor Sludge Overtime

The number distribution of the sludge particles according to their size are represented in Figure 4.28. As discussed earlier, the particle size plays a vital role in influencing other physical parameters such as the rheology and sludge compaction. It is also important to note the variation in particle size especially while using membrane technologies as there is a possibility of membrane fouling due to smaller particles.

The influence of applied limited aeration in the AnMBR on the sludge particles were monitored. ANOVA tests were performed to confirm the significance of the variation ($p < 0.05$). Then non-aerated sludge subjected to the ANOVA was from 07/01/2020 to 22/01/2020. Corresponding values for the three different aeration were between 23/01/2020 and 05/02/2020 for first batch of aeration, 08/02/2020

and 13/02/2020 for the second batch of aeration and 24/02/2020 and 02/03/2020 for the final batch of aeration.

Table 4.4: Percentage Increase of D90, D50 and D10 sizes of the Aerated Batches Corresponding to the Average D90, D50 and D10 Sizes of the Non-Aerated Batch.

Sample Name	D90 (% increase)	D50 (% increase)	D10 (% increase)
Sludge Exposed to 4.9 mlair/ L_r/d	10.3 (p = 0.043)	NIL (p = 0.163)	NIL (p= 0.093)
Sludge Exposed to 9.8 mlair/ L_r/d	11.5 (p = 0.030)	NIL (p = 0.152)	NIL (p = 0.056)
Sludge Exposed to 14.7 mlair/ L_r/d	12.6 (p = .007)	NIL (p = 0.187)	15 (0.034)

It was observed that the applied aeration caused an increase in the size of the D90 fraction in all applied aeration. This means that the applied aeration has increased the average size of the larger particles, making it more coarse. It was also observed that the D50 was unaltered upon aeration and only with the third batch of aeration, a 15% increase in the diameter of the finer fraction was observed. A conclusive result cannot be made about this type of distribution over the applied aeration as the sample size considered is less. The sludge is still adapting to the changing aeration conditions, further monitoring would help understanding if the aeration still increases the size of particles.

An increase in the size of particles could lead to less denser granules as suggested by Stephenson *et al.* [96]. Though Figure 4.27 depicts a similar visual, tests in the future has to be done to test the density change in the sludge. The provided aeration did increase the size of the coarser fraction of the particles by 12.6% and the finer fraction of particles by 15%.

4.5.6. Changes in Sludge Rheology Overtime

Rheology plays an important role in sludge compaction and transportation. The rheograms were plotted as functions of shear stress (Pa) against the provided the shear rates (s^{-1}). As discussed in the previous section, the size of particles affect the rheological parameters of the sludge to a great extent. Rounder and larger particles flow with the fluid whereas smaller particles in suspension contribute to increase in viscosity [68]. With increased number of particles, there is an increase in the particle interaction causing higher viscosity [71].

The sludge samples collected overtime were analysed in a rotating rheometer over an applied shear rates from 1-1000 s^{-1} . The corresponding shear stress were measured and averaged as batches exposed to different limited aeration. NA batch is the non-aerated batch where the reactor was operating in strictly anaerobic conditions. A1 batch corresponds to the sludge extracted when the reactor was exposed to 4.9 mlair/ L_r/d . A2 and A3 correspond to the samples collected when aerating the reactor with 9.8 and 14.7 mlair/ L_r/d respectively. The rheogram is shown in Figure 4.29.

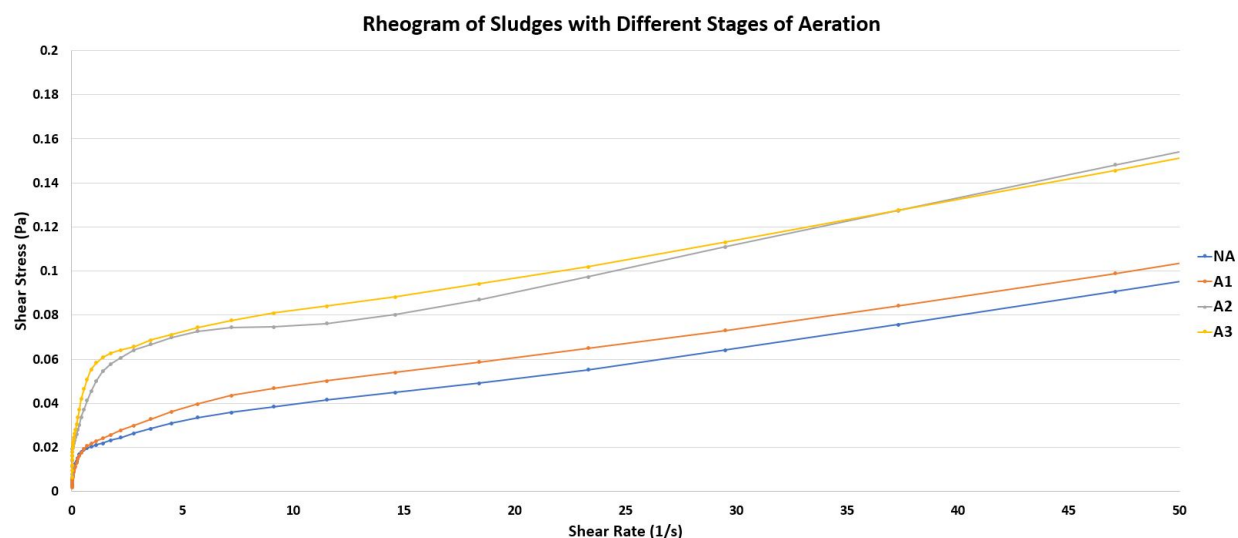

Figure 4.29: Rheogram of Sludge Samples Exposed to Limited Aeration

As it can be seen from Figure 4.29, the shear stress profile increases with each applied aeration, indicating that the viscosity increased with each applied aeration. The yield stress of each of the sample was determined using the Bingham's Equation (Equation 2.3) and is represented in Table 4.5.

Table 4.5: Yield Stress of Sludge Samples Exposed to Different Aerations

Sample Name	Yield Stress (Pa)
Non-Aerated Sludge	0.0021
Sludge Exposed to 4.9 mlair/ L_r/d	0.0017
Sludge Exposed to 9.8 mlair/ L_r/d	0.0079
Sludge Exposed to 14.7 mlair/ L_r/d	0.0064

The yield stress can be defined as the minimum applicable stress to a fluid that causes a deformation at a constant strain rate. Below this value, the fluid deformation does not occur [72]. It can also be defined as the minimum stress applied when the liquid starts to flow [98].

As it can be observed from Table 4.5, the yield stress of the sludge is the highest at the aeration batch corresponding to 9.8 mlair/ L_r/d , and reduces with the next batch. And considering the shear stress profile, the batch of A2 and A3 seem to be similar. Thus it was observed that with increase in particle size, the particle interaction increased, thus increasing the viscosity (shear-stress) profile.

4.6. Extended Discussions on The Reactor Performance

4.6.1. Batch 1 of Aeration

The applied aeration as discussed earlier, were applied in batches in the AnMBR and in the batch assays in order to relate the obtained results to each other. In retrospective, the first batch of aeration in the AnMBR corresponded to an increase in oxygen concentration of 0.68% this was comparable with the second batch of aeration in the BMP assay (0.76% increase in oxygen concentration). With this addition of

aeration, it was noted that there was no significant improvement in the degradation of organics in the AnMBR as no improvement in COD removal was observed. The biodegradability of ovalbumin did not vary upon aeration.

It was however noted that the proteins concentration decreased by 2% in the batch assays both in the effluent and sludge fraction; indicating degradation of proteins to fatty acids. It was also observed that there was a 10% increase in the effluent concentration of the humics. This would imply that there was inhibition of methanogens as there was protein degradation and humics formation but no humic uptake. The VFA observed during this phase of aeration, indicated that there was a spike in caproic acid (C6) and IC6 values (from 0 - 49.5 mg/l). Hence it is evident that there was indeed an inhibition of methanogens during this phase of aeration.

SMA of this batch was observed to be 3% ($p = 0.015$) lesser than the non-aerated batch. Hence, the introduction of 0.76% increased oxygen with respect to the sludge VSS, limited the rate of methanogenesis. The applied aeration had increased the solids fraction by 10% in D90 fraction. The yield stress of the sludge however reduced from 0.0021 Pa - 0.0017 Pa. The shear stress profile was observed to be higher than that of the non-aerated batch indicating that the viscosity was higher.

4.6.2. Batch 2 of Aeration

The second batch of aeration in the AnMBR corresponded to 1.35% increase in Oxygen with respect to the sludge VSS. In this case, there was no significant change observed in the COD removal of the AnMBR. The SMA however had improved by a significant 6% ($p = 0.0122$) when compared to the non-aerated batch indicating that the methanogens had adapted to the applied aeration. The VFA reduced from 49.5 mg/l - 10.5 mg/l, again indicating that the methanogens were adapting to the applied aeration. The particle size was higher by 11.5% in D90 in comparison with the non-aerated batch. The yield stress increased from 0.0017 Pa (in the previous batch) to 0.0076 Pa and the shear stress profile was notably higher than the previous batch.

4.6.3. Batch 3 of Aeration

The third batch of aeration was the planned added aeration corresponding to 2.02% oxygen increase when compared to the sludge VSS. There was a significant 11% COD removal ($p = 0.012$) in the AnMBR when compared to the non-aerated batch. This further confirms that the microbial community adapted to the applied aeration. It was also observed that the protein degradation increased by 28% ($p = 2.6E-6$) in the effluent and 10% ($p = 1.6E-6$) in the sludge. Humics fraction in the effluent also increased by 12% ($p = 2.6E-6$). The SMA of the sludge improved by 24% ($p = 0.0013$) in comparison with the non-aerated batch. Thereby it can be stated that the applied aeration enhanced the degradation of black water.

4.6.4. Discussion Highlights of SMA Test

The SMA was determined for inoculum undergoing different phases of aeration, before the required concentration (2.02% increase in O_2) was reached in the reactor. The inoculum obtained had a lesser methanogenic activity than the minimum required activity suggested by [Angelidaki et al., 2009](#). Hence, it can be said that the inoculum had a poorer methanogenic quality than the inoculum from a conventional treatment plant.

It can be seen that the reduction in the methanogenic activities of the inoculum,

improved on time. That is with addition of oxygen to the AnMBR, the percentage decrease in the activities also reduced considerably. The decrease in activities with respect to their controls are tabulated in Table 4.6.

Table 4.6: Reduction of Activity with respect to the Individual Controls

Inoculum Tested	VSS of Sludge (g/l)	Added Aeration (ml)	Added Aeration (Increased O_2)	Reduction in Activity
Non-Aerated Sludge	3.51	15	1.05%	14.26%
Week 2 Aerated Sludge (1.35% O_2 Increase)	2.75	15	1.05%	1.55%
Week 3 Aerated Sludge (2.03% O_2 Increase)	3.34	15	1.05%	2.08%
Non-Aerated Sludge	3.51	40	2.79%	33.76%
Week 1 Aerated Sludge (0.68% O_2 Increase)	2.48	40	2.79%	20.92%
Week 2 Aerated Sludge (1.35% O_2 Increase)	2.75	40	2.79%	31.05%
Week 3 Aerated Sludge (2.03% O_2 Increase)	3.34	40	2.79%	22.38%
Non-Aerated Sludge	3.51	60	4.18%	47.78%
Week 3 Aerated Sludge (2.03% O_2 Increase)	3.34	60	4.18%	38.17%

This improved activity can be related to the adaptability of methanogens to prolonged exposure of oxygen. Methanogens are said to adapt to different oxygen levels provided their habitat is exposed to varying oxygen concentration over a prolonged time [53].

It can also be seen that the SMA of the control are also getting better after aerating the reactor. The activities of aerated cultures have been reported to be higher than or equal to the activities of strictly anaerobic culture [54].

The reactor was planned to be aerated with $14.7 \text{ ml air}/L_r/d$. The aeration was reached in batches with each batch lasting for 3 HRTs. The aeration values corresponded to 0.67% increase 1.35% and 2.02% increase in oxygen corresponding to VSS of the sludge. The SMA was performed for aeration mostly similar to the ones to be added in the reactor.

A calculation was made to know the maximum aeration that can be introduced via a Dissolved Air Flotation (DAF) method in the system. It was found that at 5 atm pressure, and 20°C , the minimum aeration was 316.7 ml/day . This corresponded to 8% of oxygen increase when compared to the VSS of the reactor. Hence, the batch tests were also tested with this value to find out the feasibility of using DAF with AnMBR. It was however observed that with the current conditions, application of aeration similar to this DAF condition would still result in an activity reduction of 75%. The study can be conducted once the sludge completely adapts to the applied aeration conditions and for reduced DAF pressures to consider using both the technologies together.

5

Summary and Conclusions

A number of literature is available on the effects of aeration being applied as pre-treatment and post-treatment to the AD process, and a few handful on aeration applied in an AnMBR. The main focus of this study was to identify the effects of applied aeration on the operational parameters of the AnMBR treating synthetic blackwater. The tests performed to identify the effects and their results are in discussed in Chapter 4. This chapter concludes the obtained results in accordance with the framed research question.

To identify the effects, this study involved:

- Setting up and Operating an AnMBR treating synthetic blackwater.
- Assessing the performance of the reactor in the AD phase.
- Proposing intermittent aeration with equal hours of aeration and non-aeration cycle.
- Analyzing the effects of the applied aeration on substrate degradation, nutrient cycle, particle size and sludge rheology.

The research questions posed in Section 1.5, are stated below:

RQ1: What is the effect of the applied limited aeration on the Degradation of Organic Matter?

This was answered in parts with the follow up sub-questions:

RQ1a: What is the impact of the applied limited aeration on COD removal and Nutrient Cycle in the AnMBR?

The COD removal in the AnMBR was not altered on the first two initial stages of aeration. It was noted that only after the introduction of the third batch of aeration, there was an increased removal in the COD of the system. Upon aeration with $14.7 \text{ mlair}/L_r/d$, (2.02% increase in oxygen with respect to the sludge VSS), there was a 0.2% increase between the observed removal efficiencies of the non-aerated and aerated batch, which contributed to 11% increase in the overall removal of effluent COD.

The ammonium concentration increased by 24% in the third batch of aeration and did not vary significantly during the first two batches of aeration. This increase in the ammonium concentration could also be related to better degradation of organic nitrogen compounds such as urea, proteins or humic acids [31, 89, 99]. There was no significant variation in the concentration of ortho-phosphate upon aeration. Though it has to be verified with experiments, it could be attributed to precipitation of calcium or magnesium phosphate salts adsorbing on to the sludge, since the observed effluent pH was close to 8 irrespective of the applied aeration [94, 95].

VFA concentrations were predominantly nil in the AD phase with rare occasion of acetic acid concentration being noted when faced an operational glitch. The concentration of C6 and IC6 combined, increased from 0 - 49.5 mg/l during the first phase of aeration with 4.9 mlair/ L_r /d (0.68% increase in oxygen with respect to the sludge VSS). This value reduced to 10.5 mg/l during the next phase of aeration and went back to nil during the third phase of aeration.

Since changes in the enhancement of COD removal and ammonium increase were observed in the third phase of aeration, it can be said that the rate of hydrolysis or methanogenesis or both were compensated during the first two weeks of aeration. It could also be related to the VFA production during the first batch of aeration and then it being reduced. Hence, the batch studies were analysed to identify the effects on the substrate degradability and specific methanogenic activity of the sludge.

RQ1b: How does the aeration cycle impact the methanogenic activity and substrate degradation?

In the batch studies, ovalbumin was chosen as the substrate of choice to study the effect of aeration on its degradability. Ovalbumin forms the major protein source in the formation of egg whites [84]. The used albumin from egg-white (62-88% of agarose electrophoresis ovalbmin), was assumed to be a hardly biodegradable substrate of the feed, owing to the high protein content and the complex structure consisting 386 amino acids [84]. As the batch tests reveal, the used ovalbumin exhibited a very high degradability of 95% equivalent to that of cellulose. The applied aeration did not aid to get a better degradation. Once again confirming that either hydrolysis or methanogenesis or both were limited.

The SMA tests results indicated that there was a reduction in the methanogenic activity of the sludge as the activity reduced by 14% when compared to the control. As only acetate was used as substrate for this batch, it is conclusive that the methanogenesis was one of the rate limiting steps in the initial phases of aeration. When comparing the activities of the controls (bottles without additional aeration) in each SMA, it was observed that the activity of the sludge corresponding to the first phase of reactor aeration (corresponding to 4.9 mlair/ L_r /d) reduced by 3% whereas the the sludge samples belonging to the second and third phase of reactor aeration (corresponding to 9.8 mlair/ L_r /d and 14.7 mlair/ L_r /d), had an increase in the activity by 6% and 24% respectively. This suggests that the sludge samples have adapted to the applied aeration overtime. The AnMBR sludge tested, is by itself an adapting sludge and it needs more time to adapt better to the changed conditions and it could even adapt better in the future. More data points are necessary before using higher amounts of aeration in the reactor.

The degradability tests were also used to test the fate of proteins, humics and carbohydrates in the batch assays with each applied aerations. It was observed that the proteins concentration decreased by 28% in the effluent and 10% in the

sludge with an aeration corresponding to 2.02% O_2 increase (wrt VSS). The humics in the effluent increased to 12%. There was no notable change in the carbohydrates concentration. It was evident from the SMA tests that the applied aeration did affect the methanogenesis. But it is still unclear on whether the hydrolysis was affected. With better degradation of proteins, and the Biodegradability still not improved, it can be stated that the hydrolysis was not affected but the methanogenesis was affected. Since, there are very few data points to make a conclusive remark, it would have been better to actually measure the hydrolysis change as done by [Johansen and Bakke \[100\]](#).

RQ1c: What is the change in the Biogas composition due to the applied limited aeration?

The methane content in the biogas did not improve with the first to batches of aeration, but increased by 4% on the third batch of aeration (corresponding to 2.02% O_2 increase with respect to sludge VSS). This could again be related to the better adaptability of the sludge causing a better degradation of the organics and hence a higher quality of biogas. It was also observed that the applied aeration caused an increase in sulphate degradation by 12%. The effect of sulphate reduction on the presence and removal of H_2S from the biogas needs to be studied.

RQ2: What is the effect of the applied aeration on the Particle Size of Sludge and the Sludge Rheology, and How does it affect the AnMBR Operation?

The applied aeration increased the sizes of particles. The composition of the PSD with respect to the applied aeration is provided in Table 4.4. It can be seen that with the introduction of $14.7 \text{ mlair}/L_r/d$, the particle sizes have been increased by around 13% in the D90 and 15% in the D10 fraction. Indicating that the provided aeration has caused the particles to grow. The corresponding shear stress profiles also indicate that the shear stress and in turn the viscosity profile increased with aeration.

The applied aeration is said to aid the growth of smaller organisms [96]. Increasing the size of the finer fragments will not only increase the viscosity but also increase the chances of membrane fouling. The increase in viscosity will cause a reduction in flux which will have to be compensated by providing additional energy to maintain the flux. And the increased size of the fragments will increase the chances of organic deposits on the sides of the membrane causing fouling by cake formation. Cake layer fouling is considered as the most important type of fouling process for the AnMBR [34, 49, 51]. Cake layer fouling would further result in reduction of flux causing additional energy requirement for flux maintenance as stated above. The membranes also would need frequent cleaning thus increasing the operational and maintenance costs.

To conclude the study, the main research question has to be answered:

RQ: How does limited aeration corresponding to a 2% increase in Oxygen Concentration corresponding to the Sludge VSS, affect the operation of an Anaerobic Membrane Bioreactor Treating Synthetic Blackwater?

It can be concluded that the applied aeration though causing inhibition to methanogens in the initial stages of aeration, was overcome after the sludge started adapting to the applied aeration conditions. The system operated with a better organic removal of 11%, and the biogas quality was also bettered by obtaining 4% higher methane in the gas composition. The adaptability of the sludge to the applied cycles of aeration was reflected well on the degradability tests, as the rate of inhibition significantly reduced overtime. Better degradation of nitrogen containing organics were observed as the ammonium concentration in the effluent increased by 24%. Sulphate reduction increased by 12%, the effect of this on biogas quality can be studied in the future works. The additional SMA tests showed that the methanogens were still adapting to the applied aeration, and with further testing, higher quantities of aeration could be analysed. The aeration increased the PSD of the sludge by 13% in the D90 and 15% in the D10 fractions and in-turn increased the viscosity. The density variation of sludge, viscosity change in sludge can be further explored to aid better system operation and sludge disposal. The obtained results merely mark a trend to notify how the system is starting to behave to the applied aeration. More time has to be given for the sludge to adapt completely in order to give conclusive average values for the performed analysis and to observe any variation from the current trend.

6

Limitations and Future Work

6.1. Limitations

A few operational and measurement related limitations were encountered in the study. With careful planning and design, this could have been avoided and more robust results could have been generated. These limitations are stated in this Chapter along with a few suggestions that could help to improve the research done on the same lines of this study.

6.1.1. Operations Related

- As mentioned in Section 3.4, there were umpteen steps undertaken to lower the variations in the influent COD. Though the error percent in the feed was reduced to 4%, it can be still a problem when too much particles agglomerate on the tubes. The tubings were replaced once every two weeks to avoid clogging from the particles. The pH increase in the influent bucket could also be a reason causing particles to precipitate. Therefore, it is suggested that the feeding is done in intermediate steps with increased inflow velocity. This will ensure that there is higher particle transfer and lower particle settling.
- The re-circulation pump head was malfunctioning since the beginning of the study. A new head was changed twice to cope up with the required re-circulation. When working with sludge particles, it is better to use a new pump with a bigger head. In case if the system shuts down due to pressure sensors, it will be easier to identify if the problem was caused by the pump or by clogging.
- Bigger inlet nozzles would have helped in better recirculation.

6.1.2. Dataset Related

Though the study answered the research questions posed, could have been made robust by analysing more set of data points with better operational precision. Thus said, the obtained results especially in the batch degradability tests, could have contained more data points for observation than what was taken.

- It can be seen from Figure 4.12 and Figure 4.14 that there were lesser data points to study compared to other tests. A better result for these two weeks could have been represented had there been more sludge sample.
- It can be seen from Figure 4.16 that the activities are not as well defined as the other batch studies. It could be linked to lesser incubation time given before adding the substrates.
- The AnMBR though fed with the planned aeration, has not stabilized for the current condition. A stable sludge could have better adaptability to the applied aeration and better results can be generated.

6.2. Future Work

- BMP test was performed only with the non-aerated sludge. Tests involving more aerations to the adapted sludge can be done to identify the sludge adaptation better.
- Hydrolysis measurement could be made by measuring the change in soluble COD, and the effect of aeration on hydrolysis can be made.
- Additional SMA were performed with higher aerations that corresponded to conditions similar to introducing white water from DAF. A better adapted sludge can be used to identify if it is feasible to use a DAF concentration.
- Sludge particles were found to be less dense than the liquid. Density tests, and sludge volume index can be performed to identify the density difference which would be helpful in case of combining with DAF.
- The feed though was altered to be more complex than the blackwater recipe suggested by Ozgun *et al.* [6], the degradation was still around 98%. More inert compounds and complex organic substrates can be introduced so as to make the feed more complex.
- Though there was a higher reduction of sulphate observed in the study, H_2S measurement in the biogas could not be made. It would be interesting to see a removal if any in the H_2S concentration.

Bibliography

- [1] J. van Lier, N. Mahmoud, and G. Zeeman, *Anaerobic wastewater treatment*, in *Biological wastewater treatment*, edited by M. Henze, M. C. van Loosdrecht, G. A. Ekama, and D. Brdjanovic (IWA Publishing, London, 2008) Chap. 16, pp. 415–456.
- [2] W. Gujer and A. J. Zehnder, *Conversion processes in anaerobic digestion*, *Water science and technology* **15**, 127 (1983).
- [3] M. Myint, N. Nirmalakhandan, and R. Speece, *Anaerobic fermentation of cattle manure: Modeling of hydrolysis and acidogenesis*, *Water Research* **41**, 323 (2007).
- [4] Pentair, *Designed for high solids applications*, (25-02-2020).
- [5] M. de Kreuk, N. Marti, Y. Tao, and H. Wang, *CIE4485 Laboratory Experiment: SMA Test*, Technische Universiteit Delft (2012).
- [6] H. Ozgun, M. E. Ersahin, Y. Tao, H. Spanjers, and J. B. van Lier, *Effect of upflow velocity on the effluent membrane fouling potential in membrane coupled upflow anaerobic sludge blanket reactors*, *Bioresource technology* **147**, 285 (2013).
- [7] DeSA, UN, *et al.*, *World population prospects: the 2012 revision*, *Population division of the department of economic and social affairs of the United Nations Secretariat*, New York **18** (2013).
- [8] The World Bank, *Global monitoring report 2013: rural–urban dynamics and the millennium development goals*, (2013).
- [9] Lazarova and Valentina, in *Global milestones in water reuse: keys to success and trends in development* (IWA Publishing, London, 2013).
- [10] Global Water Intelligence (GWI), *Global water market 2014, volume 1. introduction and the americas*, (2014).
- [11] L. Raschid-Sally and P. Jayakody, *Drivers and characteristics of wastewater agriculture in developing countries: Results from a global assessment*, Vol. 127 (IWMI, 2009).
- [12] P. Drechsel, M. Qadir, and D. Wichelns, *Wastewater: economic asset in an urbanizing world* (Springer, 2015).
- [13] W. Metcalf, *Metcalf and eddy wastewater engineering: treatment and reuse*, in *Wastewater Engineering: Treatment and Reuse* (McGraw Hill, New York, NY, 2003).
- [14] P. L. McCarty, *Anaerobic waste treatment fundamentals - part one*, *Public Works* **95**, 107 (1964).

- [15] C. Chen, W. Guo, and H. H. Ngo, *Advances in granular growth anaerobic membrane bioreactor (g-anmbr) for low strength wastewater treatment*, *J. Energy Environ. Sustain.* **1**, 77 (2016).
- [16] Khanal and S. Kumar, *Anaerobic biotechnology for bioenergy production: principles and applications* (John Wiley & Sons, Oxford, UK, 2011).
- [17] S. J. Lim and T.-H. Kim, *Applicability and trends of anaerobic granular sludge treatment processes*, *Biomass and bioenergy* **60**, 189 (2014).
- [18] G. Lettinga, *Anaerobic digestion and wastewater treatment systems*, *Antonie van Leeuwenhoek* **67**, 3 (1995).
- [19] P. Berube, E. Hall, and P. Sutton, *Parameters governing permeate flux in an anaerobic membrane bioreactor treating low-strength municipal wastewaters: a literature review*, *Water environment research* **78**, 887 (2006).
- [20] J. Ariunbaatar, A. Panico, G. Esposito, F. Pirozzi, and P. N. Lens, *Pretreatment methods to enhance anaerobic digestion of organic solid waste*, *Applied energy* **123**, 143 (2014).
- [21] H. Yuan and N. Zhu, *Progress in inhibition mechanisms and process control of intermediates and by-products in sewage sludge anaerobic digestion*, *Renewable and Sustainable Energy Reviews* **58**, 429 (2016).
- [22] L. Appels, J. Baeyens, J. Degève, and R. Dewil, *Principles and potential of the anaerobic digestion of waste-activated sludge*, *Progress in energy and combustion science* **34**, 755 (2008).
- [23] J. W. Lim, J. A. Chiam, and J.-Y. Wang, *Microbial community structure reveals how microaeration improves fermentation during anaerobic co-digestion of brown water and food waste*, *Bioresource technology* **171**, 132 (2014).
- [24] S. Montalvo, C. Huiliñir, F. Ojeda, A. Castillo, L. Lillo, and L. Guerrero, *Microaerobic pretreatment of sewage sludge: Effect of air flow rate, pretreatment time and temperature on the aerobic process and methane generation*, *International Biodeterioration & Biodegradation* **110**, 1 (2016).
- [25] S.-F. Fu, F. Wang, X.-S. Shi, and R.-B. Guo, *Impacts of microaeration on the anaerobic digestion of corn straw and the microbial community structure*, *Chemical Engineering Journal* **287**, 523 (2016).
- [26] K. Luo, Q. Yang, X.-m. Li, G.-j. Yang, Y. Liu, D.-b. Wang, W. Zheng, and G.-m. Zeng, *Hydrolysis kinetics in anaerobic digestion of waste activated sludge enhanced by α -amylase*, *Biochemical engineering journal* **62**, 17 (2012).
- [27] C. Visvanathan and A. Abeynayaka, *Developments and future potentials of anaerobic membrane bioreactors (anmbrs)*, *Membrane Water Treatment* **3**, 1 (2012).
- [28] J. Mata-Alvarez, S. Mace, and P. Llabres, *Anaerobic digestion of organic solid wastes. an overview of research achievements and perspectives*, *Bioresource technology* **74**, 3 (2000).

- [29] R. Ferrara, R. Barberis, R. Jodice, E. Vicenzino, and A. Vanni, *Influence of kinetics of hydrolysis, acidogenesis and methanogenesis on enhancement of the production of biogas from animal excreta*, *Agricultural wastes* **11**, 79 (1984).
- [30] Y.-M. Ahn, J. Wi, J.-K. Park, S. Higuchi, and N.-H. Lee, *Effects of pre-aeration on the anaerobic digestion of sewage sludge*, *Environmental Engineering Research* **19**, 59 (2014).
- [31] J. W. Lim and J.-Y. Wang, *Enhanced hydrolysis and methane yield by applying microaeration pretreatment to the anaerobic co-digestion of brown water and food waste*, *Waste Management* **33**, 813 (2013).
- [32] K. Bialek, D. Cysneiros, and V. O'Flaherty, *Hydrolysis, acidification and methanogenesis during low-temperature anaerobic digestion of dilute dairy wastewater in an inverted fluidised bioreactor*, *Applied microbiology and biotechnology* **98**, 8737 (2014).
- [33] B.-Q. Liao, J. T. Kraemer, and D. M. Bagley, *Anaerobic membrane bioreactors: applications and research directions*, *Critical Reviews in Environmental Science and Technology* **36**, 489 (2006).
- [34] A. L. Smith, L. B. Stadler, N. G. Love, S. J. Skerlos, and L. Raskin, *Perspectives on anaerobic membrane bioreactor treatment of domestic wastewater: a critical review*, *Bioresource technology* **122**, 149 (2012).
- [35] B. Lew, S. Tarre, M. Beliaevski, C. Dosoretz, and M. Green, *Anaerobic membrane bioreactor (anmbr) for domestic wastewater treatment*, *Desalination* **243**, 251 (2009).
- [36] Y. Liu, K. Zhang, R. Bakke, C. Li, and H. Liu, *Membrane installation for enhanced up-flow anaerobic sludge blanket (uasb) performance*, *Journal of bio-science and bioengineering* **116**, 357 (2013).
- [37] D. Botheju and R. Bakke, *Oxygen effects in anaerobic digestion-a review*, *The Open Waste Management Journal* **4** (2011).
- [38] C. Chu, D. Tsai, D. Lee, and J. Tay, *Size-dependent anaerobic digestion rates of flocculated activated sludge: role of intrafloc mass transfer resistance*, *Journal of environmental management* **76**, 239 (2005).
- [39] J. van Lier, A. Tilche, B. K. Ahring, H. Macarie, R. Moletta, M. Dohanyos, L. Hulshoff Pol, P. Lens, and W. Verstraete, *New perspectives in anaerobic digestion*, *Water Science and Technology* **43**, 1 (2001).
- [40] F. Woodard, *Waste characterization*, in *Industrial Waste Treatment Handbook (Second Edition)* (Elsevier, 2006).
- [41] D. Goulding and N. Power, *Which is the preferable biogas utilisation technology for anaerobic digestion of agricultural crops in ireland: Biogas to chp or biomethane as a transport fuel?* *Renewable Energy* **53**, 121 (2013).
- [42] M. Zhu, F. Lü, L.-P. Hao, P.-J. He, and L.-M. Shao, *Regulating the hydrolysis of organic wastes by micro-aeration and effluent recirculation*, *Waste Management* **29**, 2042 (2009).

- [43] A. Hendriks, J. Van Lier, and M. De Kreuk, *Growth media in anaerobic fermentative processes: the underestimated potential of thermophilic fermentation and anaerobic digestion*, *Biotechnology advances* **36**, 1 (2018).
- [44] A. Tembhurkar and V. Mhaisalkar, *Studies on hydrolysis and acidogenesis of kitchen waste in two phase anaerobic digestion*, *Journal of the IPHE, India* **2**, 10 (2007).
- [45] A. Buswell and H. Mueller, *Mechanism of methane fermentation*, *Industrial & Engineering Chemistry* **44**, 550 (1952).
- [46] P. McCarty, *The development of anaerobic treatment and its future*, *Water Science and Technology* **44**, 149 (2001).
- [47] M. S. Switzenbaum and W. J. Jewell, *Anaerobic attached-film expanded-bed reactor treatment*, *Journal (Water Pollution Control Federation)* , 1953 (1980).
- [48] C. d. Chernicharo, *Post-treatment options for the anaerobic treatment of domestic wastewater*, *Reviews in Environmental Science and Bio/Technology* **5**, 73 (2006).
- [49] S. Judd, *Fundamentals*, in *The MBR book: Principles and Applications of Membrane Bioreactors for Water and Wastewater Treatment* (Elsevier, 2010).
- [50] N. Basset, E. Santos, J. Dosta, and J. Mata-Álvarez, *Start-up and operation of an anmbr for winery wastewater treatment*, *Ecological engineering* **86**, 279 (2016).
- [51] R. K. Dereli, M. E. Ersahin, H. Ozgun, I. Ozturk, D. Jeison, F. van der Zee, and J. B. van Lier, *Potentials of anaerobic membrane bioreactors to overcome treatment limitations induced by industrial wastewaters*, *Bioresource Technology* **122**, 160 (2012).
- [52] P. Jenicek, J. Koubova, J. Bindzar, and J. Zabranska, *Advantages of anaerobic digestion of sludge in microaerobic conditions*, *Water Science and Technology* **62**, 427 (2010).
- [53] M. T. Kato, J. A. Field, and G. Lettinga, *High tolerance of methanogens in granular sludge to oxygen*, *Biotechnology and bioengineering* **42**, 1360 (1993).
- [54] D. Zitomer and J. Shrouf, *Feasibility and benefits of methanogenesis under oxygen-limited conditions*, *Waste Management* **18**, 107 (1998).
- [55] F. Giroto, W. Peng, R. Rafieenia, and R. Cossu, *Effect of aeration applied during different phases of anaerobic digestion*, *Waste and biomass valorization* **9**, 161 (2018).
- [56] P. Nguyen, P. Kuruparan, and C. Visvanathan, *Anaerobic digestion of municipal solid waste as a treatment prior to landfill*, *Bioresource Technology* **98**, 380 (2007).
- [57] A. Mshandete, L. Björnsson, A. K. Kivaisi, S. Rubindamayugi, and B. Mattiasson, *Enhancement of anaerobic batch digestion of sisal pulp waste by mesophilic aerobic pre-treatment*, *Water Research* **39**, 1569 (2005).

- [58] O. Khongsumran, P. Intanoo, P. Rangsunvigit, S. Chavadej, and M. Leethochawalit, *Enhancement of anaerobic digestion of cellulosic fraction in cassava production wastewater by microaeration*, [CHEMICAL ENGINEERING](#) **39** (2014).
- [59] I. Diaz, A. Donoso-Bravo, and M. Fdz-Polanco, *Effect of microaerobic conditions on the degradation kinetics of cellulose*, [Bioresource technology](#) **102**, 10139 (2011).
- [60] S.-F. Fu, F. Wang, X.-Z. Yuan, Z.-M. Yang, S.-J. Luo, C.-S. Wang, and R.-B. Guo, *The thermophilic (55 c) microaerobic pretreatment of corn straw for anaerobic digestion*, [Bioresource technology](#) **175**, 203 (2015).
- [61] A. González-González and F. Cuadros, *Effect of aerobic pretreatment on anaerobic digestion of olive mill wastewater (omww): An ecoefficient treatment*, [Food and bioproducts processing](#) **95**, 339 (2015).
- [62] W. Zhou, T. Imai, M. Ukita, F. Li, and A. Yuasa, *Effect of limited aeration on the anaerobic treatment of evaporator condensate from a sulfite pulp mill*, [Chemosphere](#) **66**, 924 (2007).
- [63] I. Ramos, R. Pérez, M. Reinoso, R. Torio, and M. Fdz-Polanco, *Microaerobic digestion of sewage sludge on an industrial-pilot scale: the efficiency of biogas desulphurisation under different configurations and the impact of o₂ on the microbial communities*, [Bioresource technology](#) **164**, 338 (2014).
- [64] S. Kusch, H. Oechsner, and T. Jungbluth, *Biogas production with horse dung in solid-phase digestion systems*, [Bioresource technology](#) **99**, 1280 (2008).
- [65] D. Botheju, G. Samarakoon, C. Chen, and R. Bakke, *An experimental study on the effects of oxygen in bio-gasification; part 1*, in [proceedings of the International Conference on Renewable Energies and Power Quality \(ICRE PQ 10\)](#), Granada, Spain (2010).
- [66] P. Jenicek, C. Celis, J. Koubova, and D. Pokorna, *Comparison of microbial activity in anaerobic and microaerobic digesters*, [Water Science and Technology](#) **63**, 2244 (2011).
- [67] I. Ramos and M. Fdz-Polanco, *The potential of oxygen to improve the stability of anaerobic reactors during unbalanced conditions: results from a pilot-scale digester treating sewage sludge*, [Bioresource technology](#) **140**, 80 (2013).
- [68] H. Instruments, *A guidebook to particle size analysis*, [PSA_Guidebook.pdf](#) [Accessed: 14 Nov 2012] (2012).
- [69] I. Seyssiecq, J.-H. Ferrasse, and N. Roche, *State-of-the-art: rheological characterisation of wastewater treatment sludge*, [Biochemical Engineering Journal](#) **16**, 41 (2003).
- [70] N. Ratkovich, W. Horn, F. Helmus, S. Rosenberger, W. Naessens, I. Nopens, and T. R. Bentzen, *Activated sludge rheology: a critical review on data collection and modelling*, [Water research](#) **47**, 463 (2013).
- [71] A. Thota Radhakrishnan, *Domestic Slurry Hydraulics in Transport*, [Ph.D. thesis](#), Delft University of Technology (2019).

- [72] A. T. Radhakrishnan, J. Van Lier, and F. Clemens, *Rheological characterisation of concentrated domestic slurry*, [Water research](#) **141**, 235 (2018).
- [73] TUDelft, [Tu delft→ civil engineering and geosciences→ waterlab→ research→ gas chromatography](#), (28-02-2020).
- [74] TUDelft, [Tu delft→ civil engineering and geosciences→ waterlab→ research→ particle size distribution](#), (28-02-2020).
- [75] I. Angelidaki, M. Alves, D. Bolzonella, L. Borzacconi, J. Campos, A. Guwy, S. Kalyuzhnyi, P. Jenicek, and J. Van Lier, *Defining the biomethane potential (bmp) of solid organic wastes and energy crops: a proposed protocol for batch assays*, [Water science and technology](#) **59**, 927 (2009).
- [76] C. Holliger, M. Alves, D. Andrade, I. Angelidaki, S. Astals, U. Baier, C. Bougrier, P. Buffière, M. Carballa, V. De Wilde, *et al.*, *Towards a standardization of biomethane potential tests*, [Water Science and Technology](#) **74**, 2515 (2016).
- [77] B. Wang, I. A. Nges, M. Nistor, and J. Liu, *Determination of methane yield of cellulose using different experimental setups*, [Water science and technology](#) **70**, 599 (2014).
- [78] S. Astals, D. Batstone, S. Tait, and P. Jensen, *Development and validation of a rapid test for anaerobic inhibition and toxicity*, [Water research](#) **81**, 208 (2015).
- [79] Y. Chen, J. J. Cheng, and K. S. Creamer, *Inhibition of anaerobic digestion process: a review*, [Bioresource technology](#) **99**, 4044 (2008).
- [80] B. Frøuland, T. Griebe, P. Nielsen, *et al.*, *Enzymatic activity in the activated-sludge floc matrix*, [Applied microbiology and biotechnology](#) **43**, 755 (1995).
- [81] M. Dubois, K. A. Gilles, J. K. Hamilton, P. t. Rebers, and F. Smith, *Colorimetric method for determination of sugars and related substances*, [Analytical chemistry](#) **28**, 350 (1956).
- [82] P. Jenicek, F. Keclik, J. Maca, and J. Bindzar, *Use of microaerobic conditions for the improvement of anaerobic digestion of solid wastes*, [Water Science and Technology](#) **58**, 1491 (2008).
- [83] J. Filer, H. H. Ding, and S. Chang, *Biochemical methane potential (bmp) assay method for anaerobic digestion research*, [Water](#) **11**, 921 (2019).
- [84] J. A. Huntington and P. E. Stein, *Structure and properties of ovalbumin*, [Journal of Chromatography B: Biomedical Sciences and Applications](#) **756**, 189 (2001).
- [85] C. Sophonsiri and E. Morgenroth, *Chemical composition associated with different particle size fractions in municipal, industrial, and agricultural wastewaters*, [Chemosphere](#) **55**, 691 (2004).
- [86] A. Al-Shamrani, A. James, and H. Xiao, *Destabilisation of oil–water emulsions and separation by dissolved air flotation*, [Water research](#) **36**, 1503 (2002).
- [87] L. K. Wang, E. M. Fahey, and Z. Wu, *Dissolved air flotation*, in [Physicochemical treatment processes](#) (Springer, 2005) pp. 431–500.

- [88] M. Kato, J. A. Field, and G. Lettinga, *Anaerobe tolerance to oxygen and the potentials of anaerobic and aerobic cocultures for wastewater treatment*, *Brazilian Journal of Chemical Engineering* **14** (1997).
- [89] J. Diak, B. Örmeci, and K. J. Kennedy, *Effect of micro-aeration on anaerobic digestion of primary sludge under septic tank conditions*, *Bioprocess and biosystems engineering* **36**, 417 (2013).
- [90] J. C. Akunna, C. Bizeau, and R. Moletta, *Denitrification in anaerobic digesters: Possibilities and influence of wastewater cod/n-nox ratio*, *Environmental Technology* **13**, 825 (1992).
- [91] V. O'Flaherty, P. Lens, B. Leahy, and E. Colleran, *Long-term competition between sulphate-reducing and methane-producing bacteria during full-scale anaerobic treatment of citric acid production wastewater*, *Water Research* **32**, 815 (1998).
- [92] Y. Tang, T. Shigematsu, S. Morimura, K. Kida, et al., *The effects of micro-aeration on the phylogenetic diversity of microorganisms in a thermophilic anaerobic municipal solid-waste digester*, *Water Research* **38**, 2537 (2004).
- [93] L. Krayzelova, J. Bartacek, I. Díaz, D. Jeison, E. I. Volcke, and P. Jenicek, *Microaeration for hydrogen sulfide removal during anaerobic treatment: a review*, *Reviews in Environmental Science and Bio/Technology* **14**, 703 (2015).
- [94] K. Möller and T. Müller, *Effects of anaerobic digestion on digestate nutrient availability and crop growth: a review*, *Engineering in Life Sciences* **12**, 242 (2012).
- [95] N. C. Bouropoulos and P. G. Koutsoukos, *Spontaneous precipitation of struvite from aqueous solutions*, *Journal of Crystal Growth* **213**, 381 (2000).
- [96] R. J. Stephenson, A. Patoine, and S. R. Guiot, *Effects of oxygenation and upflow liquid velocity on a coupled anaerobic/aerobic reactor system*, *Water Research* **33**, 2855 (1999).
- [97] J. Thaveesri, K. Gernaey, B. Kaonga, G. Boucneau, and W. Verstraete, *Organic and ammonium nitrogen and oxygen in relation to granular sludge growth in lab-scale uasb reactors*, *Water Science and Technology* **30**, 43 (1994).
- [98] E. Hong, A. M. Yeneneh, A. Kayaalp, T. K. Sen, H. M. Ang, and M. Kayaalp, *Rheological characteristics of municipal thickened excess activated sludge (teas): impacts of ph, temperature, solid concentration and polymer dose*, *Research on Chemical Intermediates* **42**, 6567 (2016).
- [99] A. Stefanakis, C. Akrotos, and V. Tsihrintzis, *Chapter 5—treatment processes in vfcws*, *Vertical Flow Constructed Wetlands* , 57 (2014).
- [100] J.-E. Johansen and R. Bakke, *Enhancing hydrolysis with microaeration*, *Water science and Technology* **53**, 43 (2006).

A

Appendix-A

A.1. BMP Matrix

Table A.1, represents the inoculum VS, substrate VS, COD added, aeration applied to each BMP assay bottle and the theoretically calculated methane production and BMP. These calculations were made according to the protocol from [Holliger *et al.*, 2016](#) to suit the available conditions [76].

Each of the bottles were of 180ml volume and had a working volume of 99ml. The inoculum was determined as two-thirds of the total volume. Micro-nutrients and Macro-nutrients of 1.5ml/gCOD were added to each of the bottles. Rest of the volume was matched by adding distilled water. Aeration pulse of 0.7, 1.5 and 4 ml were added through a syringe in the liquid phase for 6 days representing 0.35, 0.76 and 2.02% O_2 increase with respect to the VSS of the sludge used.

Table A.1: BMP Matrix Providing The Quantity of Sludge and Substrate used, and the Calculated BMP

Sample	Aeration (% O_2 Increase)	Sludge VS (g/batch)	Substrate VS (g/batch)	Substrate Added (g/batch)	COD Added (g)	Expected Methane (mCH_4 /batch)	Theoretical BMP (mCH_4 /gVS of Substrate)
Negative Control 1	0	0.230	0	0	0	0	0
Negative Control 2	0	0.230	0	0	0	0	0
Negative Control 3	0	0.230	0	0	0	0	0
Cellulose 1	0	0.230	0.115	0.122	0.137	48.114	417.363
Cellulose 2	0	0.230	0.115	0.122	0.137	48.114	417.363
Cellulose 3	0	0.230	0.115	0.122	0.137	48.114	417.363
Ovalbumin A0 1	0	0.230	0.115	0.130	0.159	55.651	482.743
Ovalbumin A0 2	0	0.230	0.115	0.130	0.159	55.651	482.743
Ovalbumin A0 3	0	0.230	0.115	0.130	0.159	55.651	482.743
Ovalbumin A1 1	0.35	0.230	0.115	0.130	0.160	56.000	485.772
Ovalbumin A1 2	0.35	0.230	0.115	0.130	0.160	56.000	485.772
Ovalbumin A1 3	0.35	0.230	0.115	0.130	0.160	56.000	485.772
Ovalbumin A2 1	0.76	0.230	0.115	0.130	0.161	56.400	489.234
Ovalbumin A2 2	0.76	0.230	0.115	0.130	0.161	56.400	489.234
Ovalbumin A2 3	0.76	0.230	0.115	0.130	0.161	56.400	489.234
Ovalbumin A3 1	2.02	0.230	0.115	0.130	0.165	57.646	500.054
Ovalbumin A3 2	2.02	0.230	0.115	0.130	0.165	57.646	500.054
Ovalbumin A3 3	2.02	0.230	0.115	0.130	0.165	57.646	500.054

A.2. Influent Feed Optimization

This section provides information on the feed compositions done for optimizing a the feed for the AnMBR.

Table A.2: Influent Macronutrient Chemical Composition - [Ozgun et al.,2013](#)

Macronutrient Solution		
Chemical	Unit	Amount
Urea	mg/l	1200
Ammonium Chloride	mg/l	2000
Sodium Acetate Trihydrate	mg/l	7400
Magnesium Sulphate Heptahydrate	mg/l	180
Potassium Phosphate Monobasic	mg/l	1400
Calcium Chloride Dihydrate	mg/l	264.9
Ovalbumin	mg/l	450
Starch	mg/l	6400
Milk Powder	mg/l	1500
Yeast Extract	mg/l	600
Sunflower Oil	mg/l	5000
Micronutrients	ml/l	26.6

Table A.3: Micronutrient Chemical Composition [6]

Micro Nutrient Solution		
Chemical	Unit	Amount
Iron(III) Chloride Hexahydrate	mg/l	1000
Cobalt(II) Chloride Hexahydrate	mg/l	100
Manganese(II) Chloride Tetrahydrate	mg/l	250
Copper(II) Chloride Dihydrate	mg/l	15
Zinc Chloride	mg/l	25
Boric Acid	mg/l	25
Ammonium Molybdate Tetrahydrate	mg/l	45
Sodium Selenite	mg/l	50
Nickel(II) Chloride	mg/l	25
EDTA	mg/l	500
Hydrochloric Acid	ml/l	0.5
Resazurin Sodium Salt	mg/l	250
Yeast Extract	mg/l	1000

Tables [A.2](#) and [A.3](#), provides the composition obtained from Halen Ozgun the feed corresponded to 27 gCOD/l. A complex feed of wastewater influent was needed, the earlier recipe is altered to obtain a new one.

Table A.4: Corrected Influent Composition - *Ozgun et al.,2013*

Macronutrient Solution		
Chemical	Unit	Amount
Urea	mg/l	2400
Ammonium Chloride	mg/l	4000
Sodium Aceetate Trihydrate	mg/l	14800
Magnesium Sulphate Heptahydrate	mg/l	360
Toilet Paper	mg/l	100
Calcium Hydroxide	mg/l	1360
Ferric Choride	mg/l	400
Fulvic & Humic Acid	mg/l	0.5
Bentonite Clay	mg/l	100
Potassium Phosphate Monobasic	mg/l	2800
Calcium Chloride Dihydrate	mg/l	600
Ovalbumin	mg/l	600
Cellulose	mg/l	300
Milk Powder	mg/l	1200
Yeast Extract	mg/l	100
Sunflower Oil	drops/l	2
Micronutrients	ml/l	40

This new recipe yielded a COD of 5.2 gCOD/l.

B

Appendix-B

B.1. ANOVA Results

A single factor ANOVA test provides us information on the sum of squares (ss), degrees of freedoms considered (df), means square (MS), f value, f-critical value and the p-value. The ANOVA tests are run with an initial or null-hypothesis that there is no significance between the groups tested.

Table B.1: ANOVA Test between the COD Removal Efficiencies in Non-Aerated Sludge and First Batch of Aerated Sludge

Source of Variation	SS	df	MS	F	p-value	F crit
Between Groups	0.0031	1	0.0031	0.5401	0.4831	5.3177
Within Groups	0.0456	8	0.0057			
Total	0.0487	9				

Table B.2: ANOVA Test between the COD Removal Efficiencies in Non-Aerated Sludge and Second Batch of Aerated Sludge

Source of Variation	SS	df	MS	F	p-value	F crit
Between Groups	0.0252	1	0.0252	3.3991	0.1025	5.3177
Within Groups	0.05934	8	0.00742			
Total	0.0846	9				

Table B.3: ANOVA Test between the COD Removal Efficiencies in Non-Aerated Sludge and Third Batch of Aerated Sludge

Source of Variation	SS	df	MS	F	p-value	F crit
Between Groups	0.0848	1	0.0848	10.4126	0.0121	5.3177
Within Groups	0.0651	8	0.0081			
Total	0.1499	9				

Table B.4: ANOVA Test of Cellulose and Ovalbumin with no Aeration

Source of Variation	SS	df	MS	F	p-value	F crit
Between Groups	0.0543	1	0.0543	0.0026	0.9620	7.708647
Within Groups	84.5535	4	21.1384			
Total	84.60774	5				

Table B.5: ANOVA Test of Ovalbumin without aeration and Ovalbumin with 0.35% Oxygen Addition

Source of Variation	SS	df	MS	F	p-value	F crit
Between Groups	0.4570	1	0.4570	0.0289	0.8732	7.708647
Within Groups	63.2176	4	15.8044			
Total	63.6746	5				

Table B.6: ANOVA Test of Ovalbumin with no Aeration and with 0.76% Oxygen Addition

Source of Variation	SS	df	MS	F	p-value	F crit
Between Groups	14.6311	1	14.6311	1.0193	0.3698	7.708647
Within Groups	57.4136	4	14.3534			
Total	72.0447	5				

Table B.7: ANOVA Test of Ovalbumin with no Aeration and with 2.02% Oxygen Addition

Source of Variation	SS	df	MS	F	p-value	F crit
Between Groups	4.4651	1	4.4651	0.3199	0.6019	7.708647
Within Groups	55.8223	4	13.9556			
Total	60.2874	5				

A statistical single factor ANOVA test was run between the control and different aerations. The results of the ANOVA tests are tabulated and briefed.

Table B.8: ANOVA Test: Control and 15ml Aeration for Non-Aerated Inoculum

Source of Variation	SS	df	MS	F	p-value	F crit
Between Groups	0.000192	1	0.000192	20.432836	0.010656	7.708647
Within Groups	0.000038	4	0.000009			
Total	0.000229					

Table B.9: ANOVA Test: Control and 40ml Aeration for Non-Aerated Inoculum

Source of Variation	SS	df	MS	F	p-value	F crit
Between Groups	0.001011	1	0.001011	328.409091	0.000055	7.708647
Within Groups	0.000012	4	0.000003			
Total	0.001024					

Table B.10: ANOVA Test: Control and 60ml Aeration for Non-Aerated Inoculum

Source of Variation	SS	df	MS	F	p-value	F crit
Between Groups	0.002152	1	0.002152	86.382022	0.000746	7.708647
Within Groups	0.000099	4	0.000025			
Total	0.002252					

Table B.11: ANOVA Test: Control and 40ml Aeration for First Batch of Aerated Inoculum

Source of Variation	SS	df	MS	F	p-value	F crit
Between Groups	0.000453	1	0.000453	42.531076	0.002855	7.708647
Within Groups	0.000043	4	0.000011			
Total	0.000495					

Table B.12: ANOVA Test: Control and 15ml Aeration for Second Batch of Aerated Inoculum

Source of Variation	SS	df	MS	F	p-value	F crit
Between Groups	0.000003	1	0.000003	0.3	0.613011	7.708647
Within Groups	0.000047	4	0.000012			
Total	0.000050					

Table B.13: ANOVA Test: Control and 40ml Aeration for Second Batch of Aerated Inoculum

Source of Variation	SS	df	MS	F	p-value	F crit
Between Groups	0.001643	1	0.001643	109.090909	0.000475	7.708647
Within Groups	0.000060	4	0.000015			
Total	0.001703					

Table B.14: ANOVA Test: Control and 15ml Aeration for Third Batch of Aerated Inoculum

Source of Variation	SS	df	MS	F	p-value	F crit
Between Groups	0.000005	1	0.000005	0.910011	0.394131	7.708647
Within Groups	0.000024	4	0.000006			
Total	0.000029					

Table B.15: ANOVA Test: Control and 40ml Aeration for Third Batch of Aerated Inoculum

Source of Variation	SS	df	MS	F	p-value	F crit
Between Groups	0.001016	1	0.001016	119.1053833	0.000400	7.708647
Within Groups	0.000034	4	0.000009			
Total	0.001050					

Table B.16: ANOVA Test: Control and 60ml Aeration for Third Batch of Aerated Inoculum

Source of Variation	SS	df	MS	F	p-value	F crit
Between Groups	0.002330	1	0.002330	216.856106	0.000124	7.708647
Within Groups	0.000043	4	0.000011			
Total	0.002373					

The ANOVA results of the ammonium concentration in the non-aerated batch and the batch introduced with 4.9 mlair/ L_r/d is represented in Table B.17.

Table B.17: ANOVA Test on $NH_4 - N$ Removal Efficiency of Non-aerated batch and Batch with First cycle of Aeration

Source of Variation	SS	df	MS	F	P-value	F crit
Between Groups	52.0185	1	52.0185	0.1482	0.7198	7.7086
Within Groups	1403.8520	4	350.9630			
Total	1455.8700	5				

The ANOVA results of the ammonium concentration in the non-aerated batch and the batch introduced with 9.8 mlair/ L_r/d is represented in Table B.18.

Table B.18: ANOVA Test on $NH_4 - N$ Removal Efficiency of Non-aerated batch and Batch with Second cycle of Aeration

Source of Variation	SS	df	MS	F	P-value	F crit
Between Groups	68.9074	1	68.9074	0.1751	0.6971	7.7086
Within Groups	1573.7040	4	393.4259			
Total	1642.6110	5				

Table B.19: ANOVA Test on $NH_4 - N$ Removal Efficiency of Non-aerated batch and Batch with Third cycle of Aeration

Source of Variation	SS	df	MS	F	P-value	F crit
Between Groups	74246.94	1	74246.94	59.0188	5.84E-05	5.3177
Within Groups	10064.18	8	1258.022			
Total	84311.12	9				

Table B.20: ANOVA Test on NO_3^- Removal Efficiency of Non-aerated sludge and Sludge with Final batch of Aeration

Source of Variation	ss	df	MS	F	p-value	F crit
Between Groups	13.0139	1	13.0139	3.9013	0.0957	5.9874
Within Groups	20.0149	6	3.3358			
Total	33.0288	7				

Table B.21: ANOVA Test on $PO_4 - P$ Removal Efficiency of Non-aerated sludge and Sludge with Final batch of Aeration

Source of Variation	ss	df	MS	F	p-value	F crit
Between Groups	3.2271	1	3.2271	1.0239	0.3688	7.7086
Within Groups	12.6077	4	3.1519			
Total	15.8348	5				

Table B.22: ANOVA Test on SO_4^{2-} Removal Efficiency of Non-aerated sludge and Sludge with Final batch of Aeration

Source of Variation	ss	df	MS	F	p-value	F crit
Between Groups	5.6123	1	5.6123	24.8310	0.0025	5.9874
Within Groups	1.3561	6	0.2260			
Total	6.9684	7				

Table B.23: ANOVA Test Result Comparing the Methane Composition During the Non-Aerated Batch and Final Batch of Aeration

Source of Variation	SS	df	MS	F	P-value	F crit
Between Groups	41.7383	1	41.7383	51.6161	9.39E-05	5.3177
Within Groups	6.4690	8	0.8086			
Total	48.2073	9				