

# Dutch social housing sector reforms: Exploring the effects on low income households

André de Groen (TU Delft)

Erik Pruyt (TU Delft - TBM)

Harry Boumeester (TU Delft - OTB)

**Abstract:** *Social rental housing ought to function as safety net for the lower income groups in the housing system. However, the Dutch housing system has a relatively large social housing stock in relation to other housing systems in Europe – larger than would be required for a safety net for lower income groups. Hence, households which are financially able to purchase market housing occupy social dwellings. The Dutch government proposed four policy changes to improve the accessibility of the social housing market for low income families. The effects of these policy changes are uncertain due to unpredictable housing move behaviour of households (which is also influenced by economic and demographic uncertainty). A system dynamics model, taking this unpredictability to some extent into account, was created to explore the effects of the policy changes until 2020. Latin Hypercube simulations suggest that these measures improve the allocation of low income households to the social housing sector, while the uncertainty ranges of the absolute number of low income households of in the social housing sector do not differ among scenarios.*

**Keywords:** Housing Move Behaviour, Netherlands, Randstad, Social Housing, System Dynamics

## 1. Introduction

A social rental housing market in a housing system mainly functions as safety net for the lower income groups. The Dutch housing system has a relatively large social housing stock in relation to other housing systems in Europe (Elsinga and Wassenberg, 2007). Also households which are financially able to purchase market housing occupy social dwellings, because of the size of the Dutch social housing system is much larger than the number of households in the social housing target group. Recently, the Dutch Cabinet proposed four policy changes to reform the social housing market (CDA and VVD, 2010):

1. Rent increase of 5 % per year for high income households (gross annual income >€43.000) in the social housing sector.
2. Higher maximum rent based on living environment.
3. Buy-option for renters.
4. Implementation of EC Directive: 90% of free social housing stock should be allocated to low income households.

A goal of these measures is to transform the current social housing stock to a safety net for low income households. However, the effects of the policy changes are uncertain. The success rate of the policy changes depends on uncertain housing move behaviour. The following question is therefore relevant:

*What are possible effects of policy changes concerning the Dutch housing market on the position of low income groups in the social rental housing market in the North Wing of the Randstad?*

The Randstad is a high-density area in the Netherlands, wherein economical activities are concentrated around four big cities: Amsterdam, Rotterdam, The Hague and Utrecht. Modelling the whole Randstad would result in working with meaningless averages (by summing up housing stocks of Amsterdam and Rotterdam). Therefore, the geographical delineation is specified to the North Wing of the Randstad (Figure 1).

A system dynamics model was developed to answer the research question. The model contains



a housing move structure and the four policy changes are modelled. The goal of the model is to explore the effects of policy changes on several performance indicators till 2020.

Before the model structure is described, the theory, methodology, and data used are explained. Then, the influences of the policy changes on the model are written down. The effects are measured using three performance indicators and seven scenarios. These elements and the results are described in the section analysis. The article ends with recommendations and limitations / opportunities of the model.

## 2. Theory on Housing Move Behaviour

Several actors are active on the housing market. Besides housing associations, private landlords, banks, provinces and municipalities, households or persons have an important role on the housing market. A constant flow of housing moves in the market is indispensable. A free dwelling activates a moving chain which is ended when a starter enters a dwelling. Past half century several theories were published about the incentives of housing moves. Rossi (1955) described in his book 'Why families move' how changes in household composition affect housing moves. For example a single which started in a small house in the social housing sector is inclined to move after a marriage. So, households are continually replacing their current housing situation for a desired housing situation. Brown and Moore (1970) introduced a threshold model, wherein changes in household composition

and the living environment are summed up till a certain point at when the household gets propensity to move to another place, sector or both. Other reasons for moving are also mentioned in literature, for example divorces and job employment (Mulder, 1996). Clark and Dieleman (1996) link life cycles of age, household structure, job career and housing career to move behaviour.

Besides motives to move, also resources are needed to move, for example income and capital. These are influenced by economic cycles (Mulder and Hooimeijer, 1999). How society perceives the effects of these economic cycles affects their confidence in the economy and the housing market. This is shown by the 'Eigen Huis Marktindicator' (Boumeester and Lamain, 2010).

Resources are also influenced by institutions (Haffner and Boumeester, 2010). Accessibility and affordability are influenced by the housing subsidy system. Accessibility is also influenced by the allocation mechanism of social housing associations, which gives priority to lower income households. Mortgage interest deduction is an instrument meant to increase the affordability of houses in the home ownership sector. The relationship between regulation and income can be summarized as follows: the less income, the more housing subsidy (housing allowance in social housing sector); the more income, the more housing subsidy (mortgage interest deduction in the home ownership sector) (Priemus, 2010).

There are different types of households searching for a suitable house. Regular movers are households which already possess a house and want to move to another house in the same or in another sector. Their housing move is less urgent than the housing move of starters, because movers have also another option: stay in the current dwelling. Meanwhile, starters have no house yet and search more actively; therefore, starters have a higher moving success than regular movers (Planbureau voor de Leefomgeving, 2008). A market under pressure of high demand is less attractive for starters, because of the perceived competition of other starters/movers (Planbureau voor de Leefomgeving, 2008). When starters are not able to find a suitable dwelling, two options

are left: substitution of demand or postponement of entrance in the market (Priemus, 1984). Substitution is possible on several aspects of housing: location, sector type or housing type.

### **3. Methodology: System Dynamics**

The application of system dynamics in the field of urban research was initiated by Forrester, by publishing *Urban Dynamics* (Forrester, 1969).

An important principle of System Dynamics is that the structure of a system is responsible for the behaviour of a system. A structure of a system consists of institutions, actors, relation among actors and strategic behaviour of all these actors. The studied system is translated to a system dynamics model. Four important building blocks of System Dynamics are feedback loops, stock-flow structures, delays and graph functions.

Recently, two students from the faculty Technology Policy and Management (TU Delft) developed a housing market model (Varga, 2010, Huisman, 2009). Varga studied the influence of government policies on population composition in 'Aandachtswijken' (neighbourhoods which needs extra attention of the government). Huisman emphasized also low scale developments, by examining policies against deterioration of neighbourhoods.

In the Netherlands, various projects are known wherein System Dynamics Methodology (also in combination with Group Model Building) is applied to the Dutch Housing Market. Eskinasi, Rouwette and Vennix (Eskinasi et al., 2009) did this for a regional social housing market, focusing on the aspects of urban renewal. One of these writers, Eskinasi, is working on simulating the Dutch Housing Market; His model, Houdini, concentrates on the influences of different actors on the housing stock development.

### **4. Data**

Mental data is gathered during project meetings with the supervisors. Also the input of the policy maker, an employee of the Ministry of Intern Affairs, department Housing, Neighbourhoods and Integration, is used in the model. This information is, together with written data from articles and books, used to build the structure of the model and for making the assumptions in the model.

Two sources are used for retrieving numerical data of the housing market: WoON 2009 (current housing allocation, propensities to move) and CBS (demographic variables). The main goal of WoON 2009 is to collect statistical information about the current, previous and desired housing situation of households. More than 800 variables are measured for almost 70.000 respondents. The model uses this data as starting point for 2011. CBS Databank is used for the demographic variables like marriages and divorces per year. WoON data is free accessible for non-profit research organisations. CBS data can be accessed at <http://statline.cbs.nl/statweb/?LA=en>.

## 5. Housing Model

The model is briefly discussed in this section. A full account is available in Appendix A.

The model consists of 100 specific groups (aggregates): 4 income groups \* 5 household types \* 5 sectors. The income groups are based on the policy changes. The lowest income group represents the target group for the social housing sector. Household types are made to create distinction between moving behaviour of different household types, according to the theory of household life cycles. Each separate group has its own propensities to move and sector preferences. Movements are possible to another household type (for example by marriage), to another income type and to another house (sector). The five sectors are: home ownership sector, market rent sector and social sector (divided in three segments).

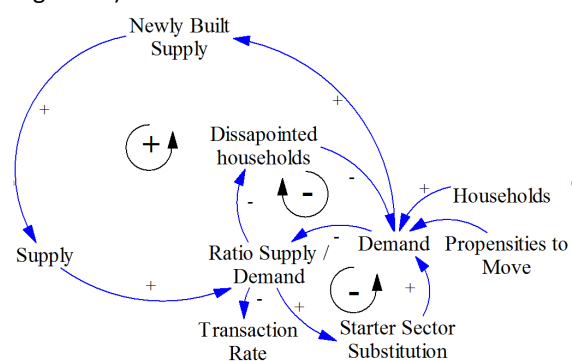

FIGURE 1: GENERAL STRUCTURE OF THE MODEL

The conceptualization of the housing move structure is given in Figure 1 by a feedback loop scheme. This feedback loop scheme is used twenty times in the model structure. For each sector,

*Supply* is divided in four segments, representing the affordability of the supply for four income groups. *Demand* is divided in demand of different household types and income types; demands of the same income groups to a specific sector are summed up to calculate the supply/demand ratio. This results in 20 different supply/demand ratios: demands of four income groups in five sectors. Dynamics in the housing market are caused by differences among sectors. There are differences between *Transactions Rates* and *Disappointment Rates*. Moreover, Ratio Supply / Demand differs for each sector and income group.

*Ratio Supply / Demand* is the centre of the feedback loop scheme. This ratio is calculated by dividing the total *Supply* of an income group to a sector by the total *Demand* of an income group to a sector. The start value of the *Supply* is based on a friction percentage (1,5-2%) which is needed to keep housing move dynamics in a housing market. The *Demand* of households is calculated from data of WoON 2009, both qualitative (to which sector) and quantitative (percentage). Three feedback loops are present in the model.

Firstly, when a specific sector has a relatively low ratio supply/demand in relation with other sectors, starters substitute their first choice sector for the more accessible sector. This feedback loop is negative and decrease the demand of a housing sector.

Secondly, when the *Demand* increases, the *Newly Built Supply* becomes higher (delayed because of building time). More supply results in a higher *Supply/Demand Ratio*, which attracts more switching starters, and causes an increasing demand. However, the extra supply causes also more housing moves which decreases the demand. Ceteris paribus, this feedback loop is positive.

Last, *ratio supply/demand* influences the number of *dissatisfied households* which influences the total *demand*. In a low-pressure market (high ratio supply/demand), no potential movers will stop searching, having trust to find the right dwelling. In a high-pressure market (low ratio supply/demand), potential movers are more quickly disappointed and discouraged by high competition of other potential movers.

## 6. Influences of Policy Changes on the Social Housing Sector

Figure 2 shows to what extent the policy changes influence the social housing sector.

The rent increase for high incomes affects the expenditure for housing of high income households in the social housing sector. The measure tries to fill up the gap between the social renting sector and market sectors by increasing the rents for social housing. When the financial advantage of subsidized housing decreases, high income households will move more quickly to market sectors.

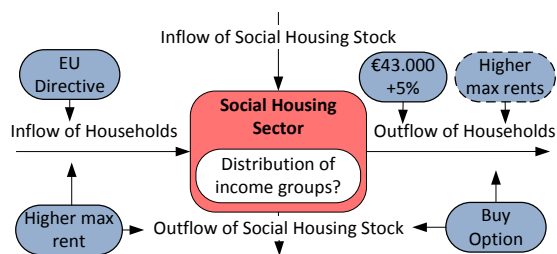

**FIGURE 2: POLICY CHANGES INFLUENCING THE SOCIAL HOUSING SECTOR**

Higher maximum rents gives the housing associations the possibility to generate more income. In combination with the first measure this could worsen the position of high income households: a higher maximum price gives the housing associations the opportunity to continue the rent increase for some more years, till the maximum rent is attained. The effect for households which do not receive housing allowance becomes noticeable when they move from one to another house in the social housing sector, due to the harmonisation effect: changing rent price after mutation. This discourages moves from one to another house within the social rent sector. For starters, the effect is immediately noticeable. An increasing harmonisation effect brings rent levels to a higher segment. When a house is already close to the liberalisation border, it is possible that the house will go to the market rent sector after mutation. So, this measure influences the inflow of the housing stock (starters), internal moving in the social housing stock, outflow of the social housing stock (to

market rent), outflow of households (because the measure intensifies the effect of the 5% a year rent increase for high income households).

Implementing the buy-option influences the size of the housing stock: household and house move to the home ownership sector. A possible propensity to move to the home ownership can be fulfilled by this measure.

The last measure is imposed by the European Commission. Several financial privileges of social housing associations are brought up for discussion: according to the EC these privileges contain state aid because social landlords also perform commercial activities supported by the government (Priemus, 2006). In 2005, the European Commission asked the Netherlands to ensure that only services of general economic interest were supported by the government. This resulted in the directive which came into force 1 January 2011: among other measures, social landlords are obliged to allocate 90% of the free social housing stock to households having a gross annual income lower than €33.000. This affects the accessibility of the social housing stock, which especially hits the households having a gross annual income just above the limit of €33.000.

## 7. Analysis

Three performance indicators are used to measure the effect of the policy changes. As Figure 3 indicates, the amount of low incomes household will be calculated as share of the total social housing stock ( $LI[SR]/SR$ ) and as share of all low incomes ( $LI[SR]/LI$ ). To put the first indicator in perspective, the average income of the social housing stock is also a performance indicator. The average income is computed by giving the lowest income group 1 point, the second lowest group 2 points, and so on. The number of points is divided by the total number of households. A low average income approaches 1, a high average income approaches 4 (maximum amount of points which can be given to a household).

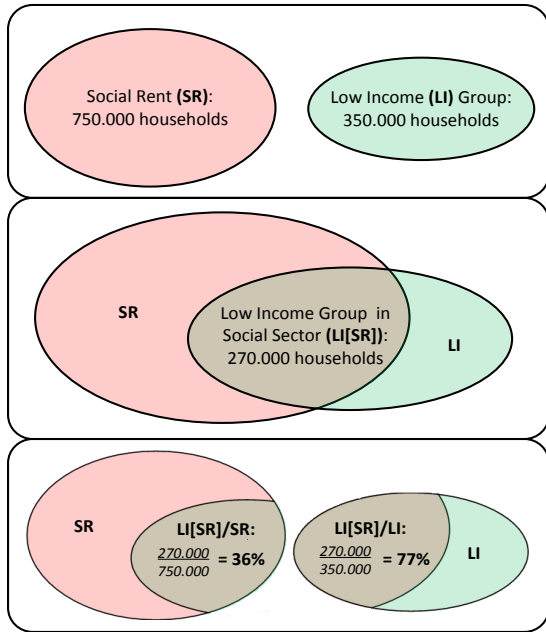

FIGURE 3: PERFORMANCE INDICATORS

Table 1 describes the scenarios. Effects of policy changes are assessed separately and combined.

TABLE 1: SCENARIOS

Scenario	Explanation
<b>0</b>	No new policy changes are implemented. Initial propensities to move determine system behaviour.
<b>EU</b>	EU directive is implemented: SR only accessible for low income households
<b>Buy</b>	Buy option: social sector shrinks by tenants which buy their house.
<b>43k</b>	HI households are stimulated to leave the social sector by rent increase.
<b>WWS</b>	Higher maximum rents: rent levels increase, social sector shrinks by harmonization effect. (WWS is the abbreviation used for the system which calculates the maximum rent)
<b>43k/WWS</b>	Rent levels increase, social sector shrinks, by harmonization effect and by HI households which get rent increase.
<b>All</b>	Combined effect of above policy changes: social housing sector shrinks, accessibility only for LI/MLI. This scenario shows situation when all policy changes are implemented.

The model is run from 2011-2020. Not all results can be discussed; despite the emphasis on low income groups, still the analysis delivered 702 numbers. LI[SR]/SR is the first performance

indicator examined; the uncertainty ranges for LI[SR]/SR in 2020 are shown in Figure 4. The lines in the figure shows the minimum, average and maximum of the uncertainty range, which is constructed of the results of 250 runs.

The European Directive and the Buy-option have the highest value on this performance indicator, however the uncertainty range of the buy-option is larger. Higher maximum rents seem to have no effect on this performance indicator. Higher scores are realized when this measure is combined with the 43k scenario. This behaviour is caused by the harmonization effect: rent levels go to a higher segment due to this effect. High incomes which rent initially in the low segment move on to the high segment. Simultaneously the total amount of social housing stock decreases because of rents which transcend the liberalization limit. An important characteristic of this combination is that the percentage of low income households in the high segment (rent >€550/month) decreases and in the low segment (rent <€550/month) increases. An attractive scenario, because the government has in this scenario lower expenses on housing allowance.

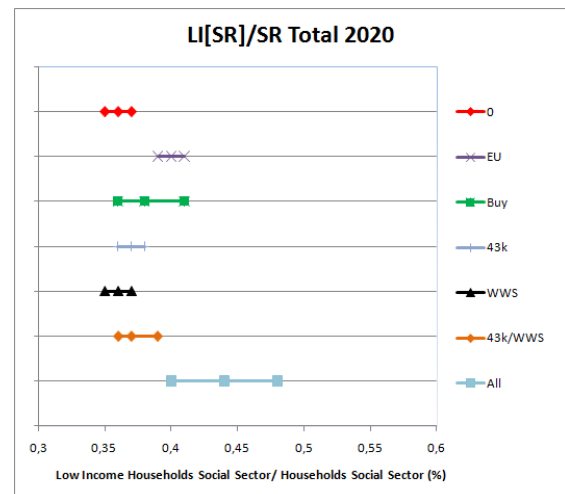
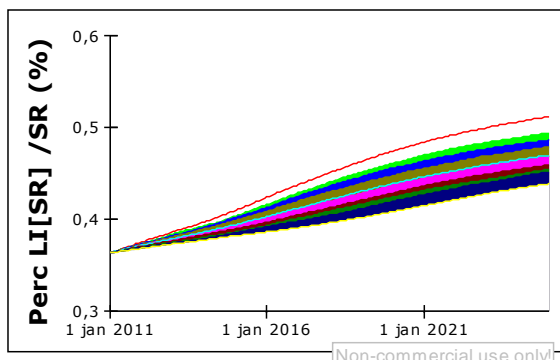

FIGURE 4: SHARE OF LOW INCOME HOUSEHOLDS IN SOCIAL HOUSING SECTOR

How the uncertainty ranges in Figure 4 are realized is depicted by Figure 5.

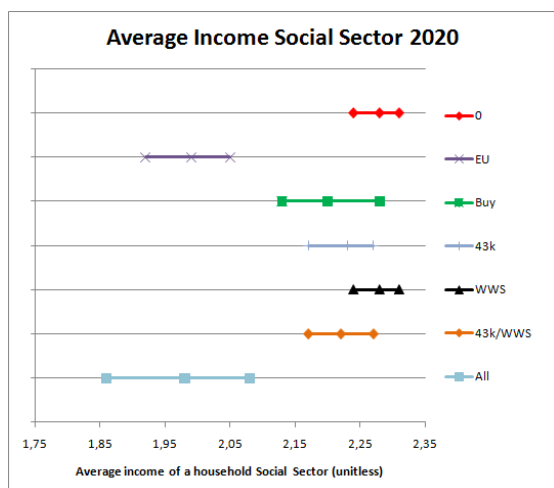

**FIGURE 5: UNCERTAINTY RANGE OF SCENARIO 'ALL' FOR PERFORMANCE INDICATOR LI[SR]/SR.**

The transition (effect of policy changes) takes some time, because the Dutch housing market is an inert market. In any case the increase of LI[SR]/SR is still significant in 2025, however the speed of the transition decreases over time.

The uncertainty range becomes larger over time: the uncertainty range of 2012 is smaller than the uncertainty range of 2020. This is caused by the slow response of the housing market on the policy changes. Also values become more uncertain when the simulation is further into the future.

The percentage of low income households in the social housing sector can be placed in the context by showing the average income of all households in the social housing sector. These are given in Figure 6.



**FIGURE 6: AVERAGE INCOME OF HOUSEHOLDS IN THE SOCIAL HOUSING SECTOR**

The scenarios including the influence of the European Directive (EU and All) score positively (the lower the average income, the better). These

policy changes are at the same time rigorous, by closing the door for a lot of households. Other measures give households the possibility to react and to make their own decisions.

To complete the picture of the low income households in the social housing sector, it is necessary to examine LI[SR]/LI. Lower average income and positive scores for LI[SR]/SR are good results. However LI[SR]/LI is important because this performance indicator shows the accessibility of the social housing sector for low income groups, and to what extent these households make use of all opportunities provided by the government. Figure 7 gives the percentages for 2020.

None of all uncertainty ranges of the scenarios is able to avoid overlap with the uncertainty range of the 0-scenario. Despite the positive results on the first two performance indicators no policy change or combination of policy changes is able to distinguish from 'doing nothing' for this performance indicator. This is caused by the shrinking social housing sector by the buy-option and by rent levels transcending the liberalisation limit.

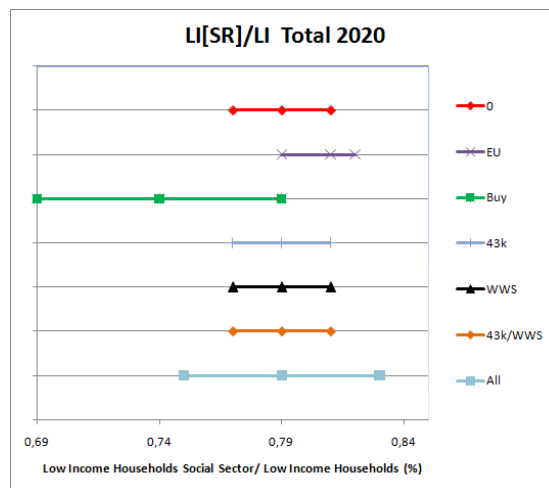

**FIGURE 7: PERCENTAGE OF LOW INCOME HOUSEHOLDS IN SOCIAL HOUSING SECTOR OF TOTAL LOW INCOME HOUSEHOLDS**

Another reason could be that low income households do not want to make use of the social housing sector. The social housing sector is more than two times bigger than the amount of low income households at the start of the simulation. So, keeping the same amount of low income

households in a smaller social housing stock results in a more efficient allocation of social housing, which is already expressed by the first two performance indicators. However, this does not automatically increase the accessibility of the social housing sector for low income households.

## 8. Conclusions and Further Research

The analysis showed that the policy changes support the transition of the current social sector composition to a social sector more focused on lower income households.  $LI[SR]/SR$  increases, while  $LI[SR]/LI$  decreases. The diagrams indicated that the transition takes some time, because the Dutch housing market is an inert market. In any case the increase of  $LI[SR]/SR$  is still significant in 2025, however the speed of the transition decreases over time. Because the policy changes also decrease the size of the social sector,  $LI[SR]/LI$  does not change heavily over time.

The model has some limitations, which is mainly caused by the underlying objective of the model and because of the model being a sub model of a larger housing market model.

Firstly, only the influences of the policy changes in the social housing sector are modelled. Other government regulation is assumed to be embedded in the model.

The second limitation is that actor behaviour in the housing market is translated to housing move percentages. There is no underlying feed back loop structure of housing move motives. Changes of housing motives are not modelled (besides the effects of uncertainties).

Third, the model only shows the effects of uncertainties on allocation of households across the sectors. It is not possible to formulate a policy advice based on the model about issues like costs, practicability and feasibility of measurements; these can only be reasoned.

Besides the mentioned limitations, the model has still a lot of potential on other aspects. Right now

only the effects of current policy changes in the social housing sector are assessed, however it is also possible to examine other policies. Some examples and proposals to execute these opportunities follow now point by point.

In this research the position of low incomes is emphasized, however it is also possible to examine the position of the other income groups or the position of several household types, or a combination between those, for example singles having a middle high income. Effects on, and changes in actor behaviour can be modelled specified to income group, household type and sector. The effects of policy changes are in the current model general of nature, however it is possible to couple research about the effects of policy changes to the model.

‘Huur op Maat’ is a type of renting whereby the rents depend on the income of a household. This will have effect on the housing move behaviour of income groups. The model contains right now already four income groups. These can be used to model the effects of ‘Huur op Maat’ on their propensities to move. This can be supported by an extra questionnaire among households in the social housing stock about their opinion of ‘Huur op Maat’.

The model can be improved by adding a detailed owner occupied market to the model, to provide a more complete overview of the effects of the policy changes. The model simulates the effects for the North Wing of the Randstad. It is also possible to simulate the same policy effects for other areas, for example a low- and high-demand pressure housing market. Then it is possible to examine the policy changes for two different type of housing markets, which can be used to make some statements about the efficiency of the policy changes on the overall Dutch housing market. It is also possible to implement data from previous WoON/WBO researches, or from future WoON research.



## References

- BOUMEESTER, H. J. F. M. & LAMAIN, C. 2010. Eigen Huis Marktindicator, 2e kwartaal 2010. Delft: TUDelft, OTB.
- BROWN, L. A. & MOORE, E. G. 1970. The intra-urban migration process. A perspective. *Geografiska Annaler*, 52, 1-13.
- CDA & VVD 2010. Vrijheid en verantwoordelijkheid, Concept Regeerakkoord VVD-CDA. Den Haag.
- CLARK, W. A. V. & DIELEMAN, F. M. 1996. Households and Housing, choice and outcomes in the housing market. . *Center for Urban Policy Reserach* [Online].
- ELSINGA, M. & WASSENBERG, F. 2007. Social Housing in the Netherlands. In: WHITEHEAD, C. & SCANLON, K. (eds.) *Social Housing in Europe*. London: London School of Economics and Political Science.
- ESKINASI, M., ROUWETTE, E. & VENNIX, J. 2009. Simulating urban transformation in Haaglanden, the Netherlands. *System Dynamics Review*, 25, 182-206.
- FORRESTER, J. W. 1969. *Urban Dynamics*, Cambridge MA, Productivity Press.
- HAFFNER, M. E. A. & BOUMEESTER, H. J. F. M. 2010. The affordability of housing in the Netherlands: An increasing income gap between renting and owning? *Housing Studies*, 25, 799-820.
- HUISMAN, F. 2009. *Fighting Neighbourhood Deterioration. Exploring problems and policies for a Den Haag Zuid-West case study from a systems perspective*. TU Delft.
- MULDER, C. H. 1996. Housing choice. Assumpations and approaches. *Journal of Housing and the Built Environment*, 11, 209-232.
- MULDER, C. H. & HOOIMEIJER, P. 1999. Residential relocations in the life course. In: WISSEN, L. J. G. & DYKSTRA, P. A. (eds.) *Residential relocations in the life course*. New York: Kluwer Academic/Plenum Publishers.
- PLANBUREAU VOOR DE LEEFOMGEVING 2008. Verhuiswensen en verhuisgedrag in Nederland. Een landsdekkend onderzoek.
- PRIEMUS, H. 1984. Verhuistheorieën en de verdeling van de woningvoorraad. Delft.
- PRIEMUS, H. 2006. European policy and national housing systems. *Journal of Housing and the Built Environment*, 21, 271-280.
- PRIEMUS, H. 2010. Housing finance reform in the making: The case of the Netherlands. *Housing Studies*, 25, 755-764.
- ROSSI, P. H. 1955. *Why families move: A study in the social psychology of urban residential mobility*., Illinois, Glencoe, Free Press.
- VARGA, K. 2010. *Aandachtswijken. Een kwantitatief onderzoek*., TU Delft.

## Appendix A. Model Description

The model description is divided in three parts. First, the modelling choices are explained. Then, different types of moving and the corresponding general elements in the model are discussed. This is followed by the general structure (conceptualisation of the housing market) of the system dynamics model. Furthermore, the uncertainty structures and their effects on the model are described in detail. The chapter ends with a description of the start situation of the model.

### A.1 Modelling Choices

Chapter 2 (The Dutch Housing System) provides enough elements to choose from for constructing a model:

- Persons (education level, gender, age,...)
- Households (single, senior single, single and child(ren), Pair,...)
- Incomes (low, high, modal,...)
- Sectors (owner occupied, private rent, social rent, below liberalisation limit, above....)
- Housing environments (urban, rural)
- Housing markets (regional)
- Housing moves (Leavers, starters, movers, students, urgent, not-urgent...)

During the project, the model gradually evolved to the current state. The first model contained three sectors (social rent, market rent and home-ownership), wherefrom only social rent was specified into four income groups. The second model contained four household types, four income groups and three sectors, the final model added one household type and two sectors.

Housing moves are caused by a fixed percentage (which can be influenced by uncertainties), but is not generated by factors like housing satisfaction, job career, household development, etcetera. This is done indirectly, by making a snapshot of WoON 2009 concerning housing move wishes specified to household type, income and sector. When a household changes in composition or in income level, it receives a housing move propensity corresponding to the new characteristics of the household.

### A.2 General Elements of the Model

Three ingredients were chosen from the list above: Household types (5), Sectors (5) and Income groups (4). The classification in household, income and sector gives the possibility to specify the effects of several uncertainties to a sector or income group in a sector. There are in total  $5*4*5 = 100$  household stocks. Among these stocks, all kind of flows continuously reallocate households. Households are reallocated by changes in household composition, by income development of a household and by housing moves from one to another sector. These three type of moving in the model are discussed in the next three sections.

#### A.2.1 Moving by Change in Household Composition

Household types are chosen because of the influence of the household life cycle on housing move wishes. Households are favoured above persons, because households are exchangeable with houses (a household lives in a house, a house is occupied by a household). Also household development can be used to specify the effects of demographic uncertainty. Table 2 shows the five different household types which are present in the model.

TABLE 2: MODEL NAMES OF HOUSEHOLD TYPES AND DESCRIPTION

Household Type	Description
<b>T1 (Type 1)</b>	Singles age <65 year old, also singles with children are included in this group
<b>T2</b>	Pair without children, age head resident < 65 year
<b>T3</b>	Pair with children, age head resident < 65 year
<b>T4</b>	Single >65 year
<b>T5</b>	Senior pair, head resident > 65 year

Only the most important household transformations are modelled, these are shown in Figure 8.

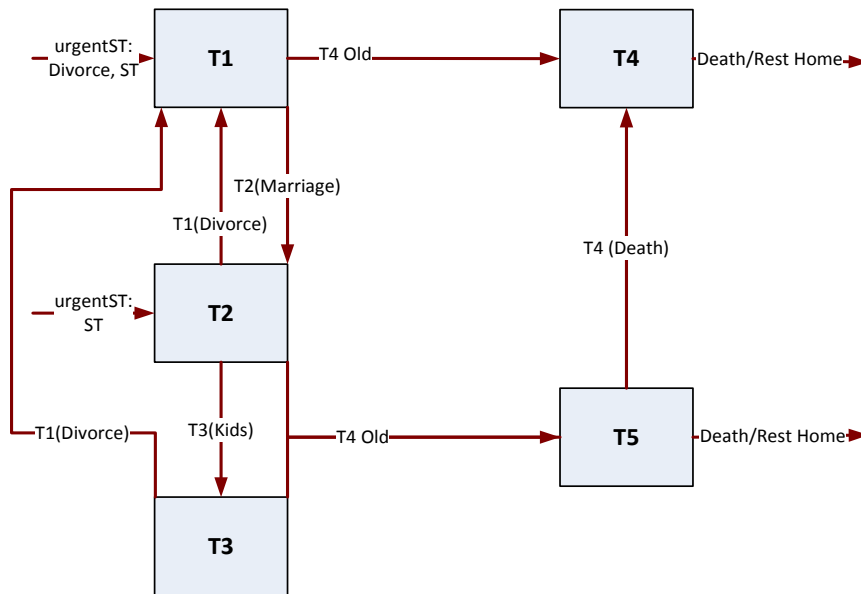

FIGURE 8: MOVING BY CHANGE IN HOUSEHOLD DEVELOPMENT

Several life cycle assumptions are made *to simplify* the life cycle of households:

- Seniors (T4 and T5) do not marry or divorce.
- 'Young' households (T1, T2 and T3) do not die.
- Only singles with the same income and from the same sector marry.
- After a divorce, the person with the highest income stays in the house.
- There is no movement from T3 to T2: It is assumed that when all kids are gone, the parents are more or less senior.
- After a certain time-period a young household become a senior household. For T1 this period amounts to 45 years, for T2 40 years and for T3 35 years.

More detailed information about household transformations is given in Appendix C.

Starters form a special group in the model, because they do not belong to a sector before entering the housing market. After their first housing move they belong to household type T1 or T2.

### A.1.2 Moving by Change in Income

Income groups are chosen because the current and the expected regulation clearly focus on income groups: the EU-Directive provides a €33.000 limit, the Cabinet rule to stimulate high incomes to leave the social housing market gives a €43.000 limit, and current housing allowance regulation delivers limits dependent on household type. Income groups are indispensable because the research question emphasizes the distribution of incomes in the social housing sector.

There are four classes of income which are explained in Table3. The values assigned to the limits of the income groups seem to be not familiar to the values from policy changes. This is because of a correction from taxable income 2011 to gross income 2009 (the dataset is from 2009).

TABLE 3: MODEL NAMES OF INCOME TYPES AND DESCRIPTION

Income Type	Description
<b>LI</b>	Low income, from negative to housing allowance limit(0-20.000/27.000). T1/T4 (singles) have 20.000 as limit, other household types have 27.000 as limit.
<b>MLI</b>	Middle Low income, from housing allowance limit to EC Directive limit (20.000/27.000-30000)
<b>MHI</b>	Middle High income, from inflow frontier till Cabinet rule frontier (30000-40000).
<b>HI</b>	High income, from Cabinet rule frontier till end (40000 - ∞).

Assumed is that households earn more money over time. Otherwise, the income of households should become after a long time period equally to the income distribution of starters. It is assumed that 1% of LI goes to MLI, 1% of MLI to MHI and 1% of MHI to HI each year for all household types and sectors, excluding senior households.

Incomes are also redistributed by household development, which is clarified in Appendix B. The income of a household determines the number of houses financially feasible for the household. The following assumptions for affordability are made, after consulting several internet calculators: a household receives a mortgage of maximum 4,5 \* its yearly gross income<sup>1</sup> and a household can rent a dwelling when its monthly income is 4 times the monthly rent of a dwelling<sup>2</sup>. To compute the affordability, each time the upper limit of the income group is chosen. This results in the following affordability limits: €70.000 (singles)/€121.500 (pairs), €135.000 and €180.000 (Home Ownership sector), and €650, €833 (market rent sector). Table4 shows the affordable range of housing for each type of income, for both the home ownership and the market rent sector..

TABLE 4: HOUSEHOLD INCOMES AND AFFORDABLE HOUSING STOCK

Income group/Sector	Home Ownership	Market Rent
<b>LI (Low income)</b>	€0-€70.000/€121.500	-
<b>MLI (Middle low income)</b>	€70.00/€121.500-€135.000	-
<b>MHI (Middle high income)</b>	€135.000-€180.000	€650-€833
<b>HI (High income)</b>	€180.000+	€833+

### A.1.3 Moving by Change in Housing Sector

The last element, sector, is indispensable in a housing market model: the social housing sector is researched, so it should be possible to analyse this sector within the model. The different sectors also contain different dynamics. Market sectors are more sensitive for economic changes than social rental housing. Table 5 describes the different sectors which are present in the model.

<sup>1</sup> Examples of mortgage calculators: <http://www.berekenhet.nl/hypotheek/maximale-hypotheek-berekenen.html>; [http://www.rabobank.nl/particulieren/producten/hypotheek/bereken\\_uw\\_maximale\\_hypotheekbedrag](http://www.rabobank.nl/particulieren/producten/hypotheek/bereken_uw_maximale_hypotheekbedrag)

<sup>2</sup> Example of maximum rent calculators: <http://www.vesteda.com/nl/particuliere-verhuur/goed-om-te-weten/bereken-maximale-huur.aspx>.  
[https://www.rabowoonlastencalculator.nl/pages.php/woonlasten\\_huur.html?pid=238&fid=61](https://www.rabowoonlastencalculator.nl/pages.php/woonlasten_huur.html?pid=238&fid=61)

TABLE 5: MODEL NAMES OF SECTORS AND DESCRIPTION

Sector	Description
SRL	Social Rent Liberalisation limit, all rental houses with a gross rent above the top limit and below the liberalisation limit (€550-€650 a year).
SRT	Social Rent Top-limit, all rental houses with a gross rent above the quality limit and below the top limit (€350-€550 a year).
SRQ	Social Rent Quality limit, all rental houses with a gross rent above the minimum rent level and below the quality limit (€200-€350 a year).
MR	Market Rent Sector, all rental houses with a gross rent above the liberalisation limit.
HO	Home Ownership Sector.

Distinction in the rental housing market is made based on rent price and not based on landlord (social housing association or private), because this is exactly the same limit for application of rent regulation. Also, private tenants are bound to municipal arrangements which rule that housing below the liberalisation limit should be allocated to lower income groups.

The model simulates movements among sectors. These movements are indicated by the blue arrows in Figure 5. ‘Lux’ means that the movement is a luxury movement instead of an urgent movement (movers versus starters). This movement can be from the research area to outside the research area, vice versa, and within the research area. Tenants are able to buy the house of their landlord (Buy HO).

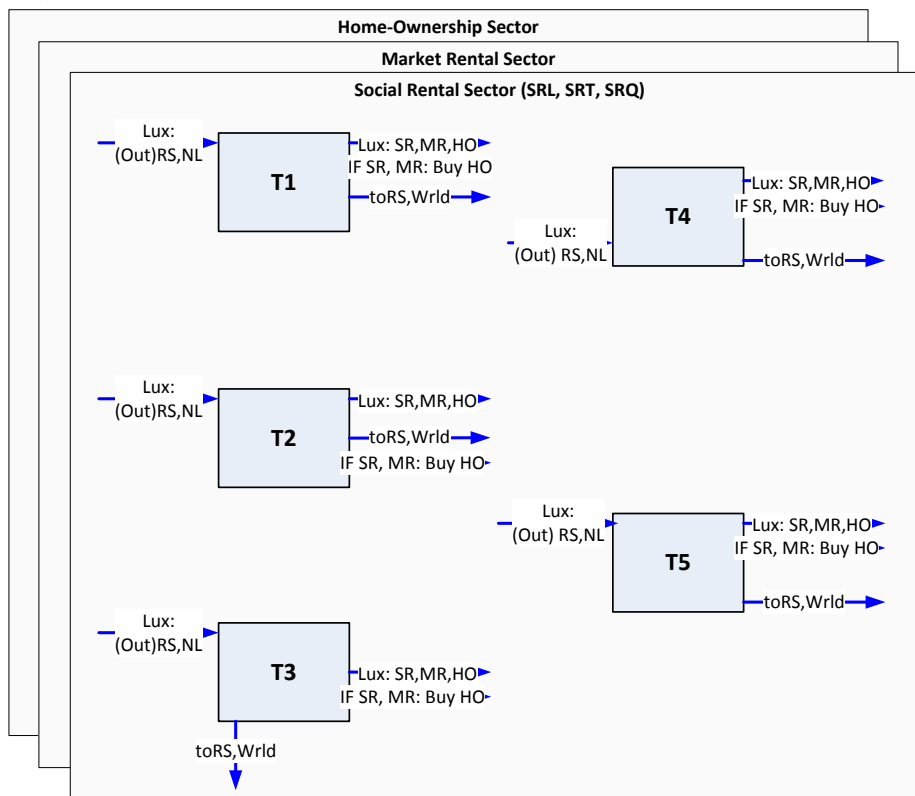

FIGURE 9: HOUSING MOVES TO ANOTHER SECTOR/REGION

Section A.2 is summarized in Figure 10. This figure shows moves by changes in household composition (red links), by income development (green links), and by housing move to another sector (blue links).

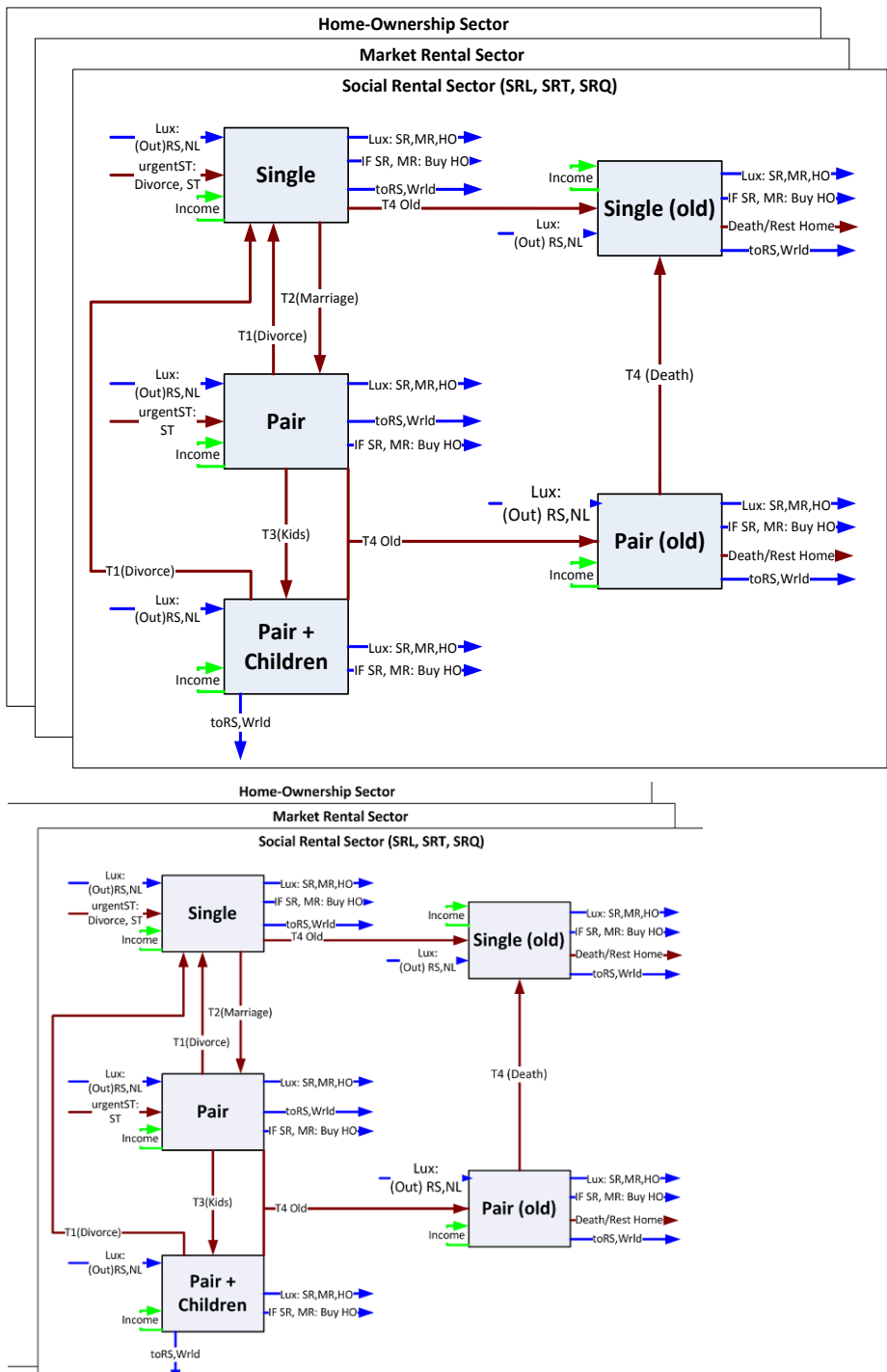

FIGURE 10: ALL MOVEMENTS OF HOUSEHOLDS IN THE MODEL

### A.3 General Structure of the Model

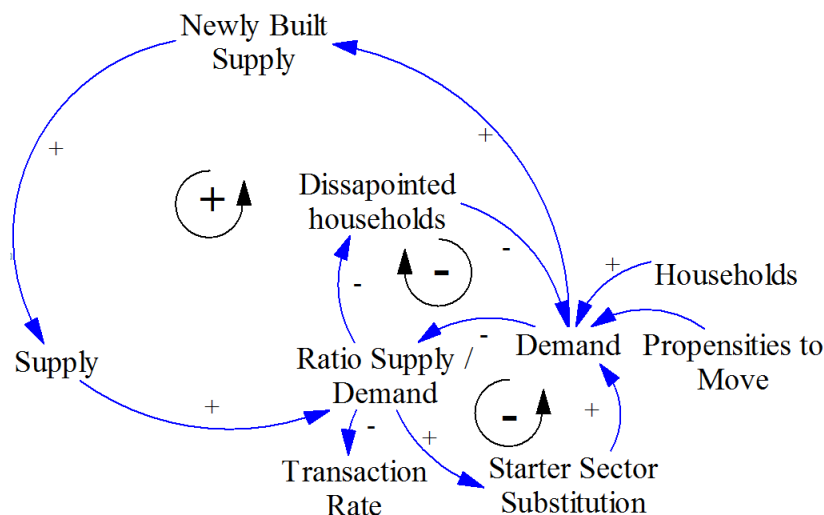

FIGURE 11: GENERAL STRUCTURE OF THE MODEL

The conceptualization of transactions in the model is given in Figure 11, in a feedback loop scheme. This feedback loop scheme is used twenty times in the model structure. For each sector, *Supply* is divided in four segments, representing the affordability of the supply for four income groups. *Demand* is divided in demand of different household types and income types; demands of the same income groups to a specific sector are summed up to calculate the supply/demand ratio. This results in 20 different supply/demand ratios: demands of four income groups in five sectors. Some elements in the feedback loop structure are followed by [...]. '[E]' means 'influenced by economic uncertainty', '[I]' means 'influenced by institutional uncertainty' and '[D]' means 'influenced by demographic uncertainty'.

Dynamics in the housing market is caused by differences among sectors. There are differences between *Transactions Rates* and *Disappointment Rates*. Also the ratio supply/demand differs for each sector and income group.

Several elements of this scheme will be discussed subsequently: demand, supply and feedback loop new built supply, feedback loop starter substitution, transaction rate, feedback Loop dissatisfied households, and the influences of uncertainties.

### A.3.1 Demand

The model uses aggregates to simulate the housing moves on the housing market. It is not possible to trace back the activity of a particular household. All households are divided into 100 groups: 5 household types, 4 income groups and 5 housing sector. Each possible combination has its own propensity to move. These 100 possible combinations represent households owning a house in the North Wing of the Randstad. Other household groups acting on the housing market of the North Wing of the Randstad are movers from outside the North Wing of the Randstad and starters. The *Propensities to Move* of all these groups is calculated from data of WoON 2009, both qualitative (to which sector) and quantitative (percentage). Households which want to move, flow into the demand stock of their desired sector. The start values of all these demand stocks is calculated from WoON, by analysing the households which answered the question 'do you want to move within 2 years?' positively. The absolute start values are translated to a percentage and multiplied with 0,5 (from 2 years to 1 year) to calculate the yearly inflows of the demand stocks. These propensities to move are limited by the accessibility of sectors for income groups. For example, the European Directive causes an accessibility of 0% of the social housing sector for high income groups.

### A.3.2 Supply and Feedback Loop Newly Built Houses

The start values of the supplies are based on a friction percentage (1,5-2%), which is needed to keep housing move dynamics in a housing market. It is assumed that each year 30.000 houses are added to the housing stocks in the North Wing. The amount of demands for a sector determines in which sector the building activities concentrate. All demands to all sectors are summed up, then demands to one sector is divided by this summation. This delivers a percentage which is multiplied by the 30.000 houses a year. The result of this calculation is added to the concerning housing stock in one year. So, when the *Demand* increases, the *New Built Supply* increases (delayed because of building time). More supply results in a higher *Supply/Demand Ratio*, which attract more switching starters which causes increasing demand. However, the extra supply causes also more housing moves which decreases the demand. *Ceteris paribus*, this feedback loop is positive.

When a household buys the house of the landlord, it moves to another sector while keeping the same house. This movement occurs simultaneously in the housing stock model, because the household *and* the house switch from sector.

### A.3.3 Feedback Loop Starter Substitution

*Ratio Supply / Demand* is the centre of the feedback loop scheme. This ratio is calculated by dividing the total *Supply* of a sector, affordable for a specific income group, by the total *Demand* of all income groups to this supply. When a specific sector has a relatively (in relation with other sectors) low ratio supply/demand, starters substitute their first choice sector for the more accessible sector. This is because starters are urgent movers on the housing market. Contrary to movers, they are less bound to a specific sector. Moreover, starters are entrants on the housing market, and are therefore more flexible. The substitution is delayed, because it takes time for starters to experience the difference in pressures among sectors. So, a higher *Ratio supply/demand* results in more *Starter Sector Substitution*, which increases the *Demand to the original sector*, which decreases the *Ratio Supply / Demand*.

The comparison between sectors is modelled as follows: Ratios are divided by each other, as in the formula below.

$$\frac{\frac{Supply\_Sector\_i}{Demand\_Sector\_i}}{\sum_{i=2}^5 \frac{Supply\_Sector\_1}{Demand\_Sector\_1}} = \frac{\sum_{i=2}^5 \frac{Ratio\_Sector\_i}{Ratio\_Sector\_1}}{\sum_{i=2}^5 \frac{Ratio\_Sector\_1}{Ratio\_Sector\_1}}$$

From the perspective of for example Sector 1, the ratio supply/demand should be compared with the ratios of sector 2-5. Dependent of the outcome of the divisions, a graph function determines the amount of starters that switch. The formula below shows how the amount of switching starters for sector 1 is calculated.

$$\frac{\sum_{i=2}^5 Ratio\_Sector\_i}{Ratio\_Sector\_1} * GraphFunction [\%] * Demand\_Sector\_1 [houses] * SwitchDelay [yr] * SwitchPercentage [\%]$$

When the outcome of the division of ratios is equal or smaller than 1, no substitution occurs. The graph function can be logarithmic or exponential, the switch delay and switch percentage is also



uncertain. These two types of graph functions are chosen because the relation between availability of housing in a sector and substitution behaviour is uncertain.

### **A.3.3 Transaction Rate**

The model uses aggregates, so it is not possible to simulate moving chains. Instead, a transaction rate determines the size of the share of the total supply which is allocated to households in the demand stocks. When in a specific month *Supply* equals 50.000 houses and the *Transaction Rate* amounts to 10%, then 5000 transactions are made in that month. The transaction rate is influenced, dependent of which sector, by the economic situation and by the ratio supply/demand. When the ratio is high, i.e. there is more choice for households, the transaction rate is lower: households become more selective waiting for finding their dream house. In another situation, when the ratio is low, households are more willing to accept a dwelling, also when the dwelling does not meet all requirements. For urgent movers, for example starters or just divorced households, the transaction rate is higher: higher urgency results in higher acceptance. Also the transaction rates of market sectors are lower than the transaction rates of the social sector, because of the allocation mechanism of the social sector.

### **A.3.4 Feedback Loop Disappointed Households**

Demand decreases by the total demand divided by a disappointment time each year. When in a specific year the total demand is 40.000 houses, and the disappointment time amounts to 4 years, then 10.000 ( $=40.000/4$ ) houses leave the demand stock that year. For starters and social dwelling demand this is the only way of decreasing demand besides housing moves. For market sectors, (market rent and home ownership), the amount of potential movers also decreases by  $(1 - \text{Transaction Rate}) * \text{Supply} * \text{'Effect of Ratio'}$ . This is modelled to represent the disappointed movers due to few supply (not in the right region, sector, etc.). This amount of extra disappointed movers is influenced by the ratio supply/demand. In a low-pressure market (high ratio), no potential movers will stop searching, having trust to find the right dwelling. In a high-pressure market (low ratio), potential movers are earlier disappointed and discouraged by high competition of other potential movers.

### **A.3.5 Influence of Uncertainties**

Economical, demographic and institutional uncertainties influence several variables of the housing move structure.

Institutional uncertainties are caused by the policy changes described in section 2.4. First, the European Directive causes a shift in demand by limiting the accessibility of the social housing sector: (middle) high income households cannot move to the social housing sector anymore. It is unknown which percentage of the original demand to social housing will switch to market rent. Second, the rent increase for high income households has an uncertain influence on the propensity to move of high income households in the social sector towards the market sector (market rent or owner occupied). Third, adding WWS points influence the intern social housing moves in an uncertain way. Due to harmonization effects (rent increase after mutation), a significant price difference causes a financial threshold to move within the social housing sector. Also rent levels will flow to a higher segment due to the harmonization effects. Last, a buy-option for tenants will increase the number of successful housing sales to renters.

Demographic uncertainties are modelled as an exponential function having a varying direction (positive or negative). The demographic development follows the trend capriciously. Demographic

uncertainties influence the number of households (by divorces, marriages, births, deaths etc.) and thereby the demand to different sectors.

Economy is modelled by totalling up two sinuses, which represent two economic waves (Kondratieff and Juglar) and a trend of 2-3% growth. It is also assumed, as simplification, that the variables housing price, interest, inflation and income follow the economy with different delays, delay types and amplitudes. These variables are used to calculate effects on among others affordability, propensities to move, attractiveness of sectors and number of houses added to the housing stocks.

#### A.4 Detailed Description of Uncertainty Structures

Uncertainties are modelled for three themes: Institutions, Economics and Demographics. How these uncertainties are modelled, i.e. how the uncertainty is represented in the model, and in which way these uncertainties influence model variables is described in the next three sections.

##### A.4.1 Institutional Uncertainties

The policy changes described in Section 2.4 are implemented in the model. These are described subsequently.

###### A.4.1.1 Rent Increase High Incomes

The *Rent Level* is expressed as a percentage of the maximum rent level. According to the data of WoON 2009, the *Start Rent Level* of high income households in the North Wing of the Randstad amounts to circa 71.5% of the maximum rent price. Each year, the *Rent Level* increase is equal to the *Price Increase* multiplied by the current *Rent Level*. So the absolute increase is higher in 2014 than in 2013. This inflow remains till the *Maximum Rent Level* is achieved. The *Rent Level* is input for the graph function *Effect Rent Level on propensities to move*. The relationship between the *Rent Level* and propensities to move of high income households is assumed to be exponential. The strength of this relationship is uncertain. The first 5% rent increases delivers an effect of  $1+(1^{Uncertainty Strength Rent Level})/100$ . The second 5% delivers an effect of  $1+(2^{Uncertainty Strength})/100$ , and so on. *Uncertainty Strength Rent Level* varies from 1 to 2,5. Figure 12 shows the range of possible effects (space between red and green line).

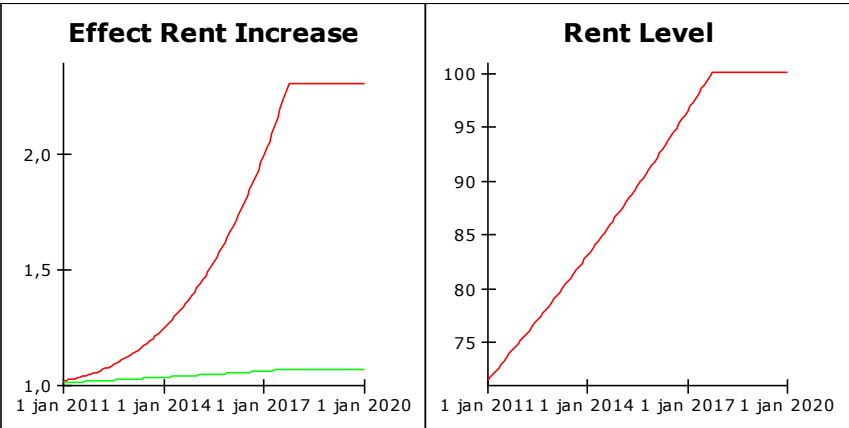

FIGURE 12: UNCERTAINTY BANDWITH EFFECT RENT INCREASE (LEFT) AND RENT INCREASE (RIGHT)

It is expected that the maximum rent price is obtained after 2017. A couple of simplifications were made: the rent increase affects the households in the social sector (below the liberalization limit). Also households who rent their house from a private landlord below liberalization limit experience

the rent increase (while the rules are only obliged for social housing associations). Also, households having already a harmonized rent level and labelled as HI household by income development receive also a higher propensity to move, while their rent level is not in accordance with the rent level where the effect is based on. These simplifications are inevitable because the model uses aggregates.

When this measure is executed simultaneously with the addition of extra WWS points, the maximum rent level will increase from for example 100% to 115% (percentage of the maximum rent level 2011). This gives the social housing association the possibility to increase the rent of high income households for a longer period.

**A.4.1.1 Extra WWS points**

The maximum effect of adding extra WWS points is a rent increase of €120 after mutation. It is assumed that the addition of points results in a higher harmonization effect, i.e. a larger difference between rent level after- and before mutation. Internal moving in the social housing sector becomes from financial perspective less attractive. The propensities to move of households in the social sector towards another house in the social sector are multiplied by factor below 1. This factor differs for the four income groups: it is assumed that MLI households are more influenced by financial measures than HI households, because the total money spent on housing of MLI households is relatively higher. Low income households are not influenced because they receive rent allowance. The uncertainty ranges of the effects for LI, MLI, MHI and HI are respectively (1-1), (0,75-0,90), (0,90-0,95), (0,95-1). These effects become smaller over time, in an uncertain manner: Figure 13 shows two possible groups of effects.

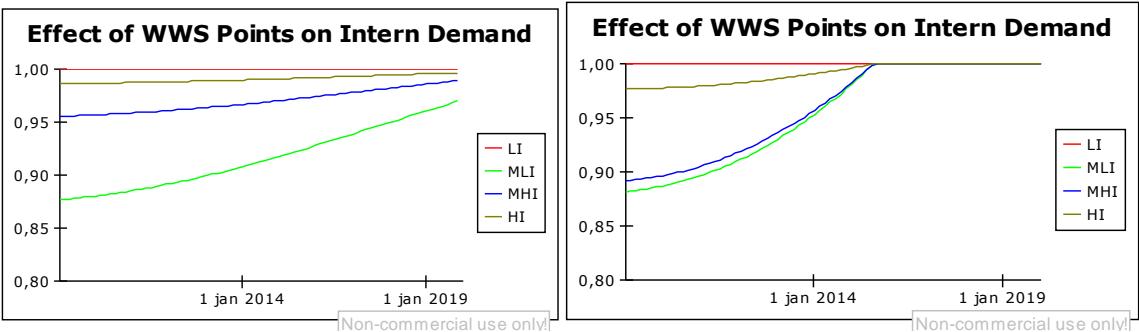

**FIGURE 13: TWO POSSIBLE OUTCOMES OF EFFECT OF ADDITION OF 25 WWS POINTS ON INTERN SR DEMAND**

Another consequence of this measure is that houses move from one to another rental sector. For example, a dwelling of €600/month receives after mutation €100 extra rent and goes from the social sector (SRL) to market rent. This will not happen at once, but slowly and in an uncertain manner. In the model this rate is assumed to be 1% a year for each segment without policy changes. Addition of WWS points increases this percentage by 5-15 % a year.

**A.4.1.3 Buy Option**

Whether a household buys a house is modelled in a simple way. Propensities to buy are imported from WoON 2009, specified to household type, income, and sector. It is assumed that at the moment not all households are successful in their buy-attempt. The buy success is influenced by the income of a household. The uncertainty ranges of buy success of LI, MLI, MHI and HI households are respectively (0.7,0.8,0.9,1\*[15-25%]) at the start of the simulation. These percentages increase with

uncertain speed to an uncertain maximum (50-100%). Figure 14 shows two possible effects on Buy success.

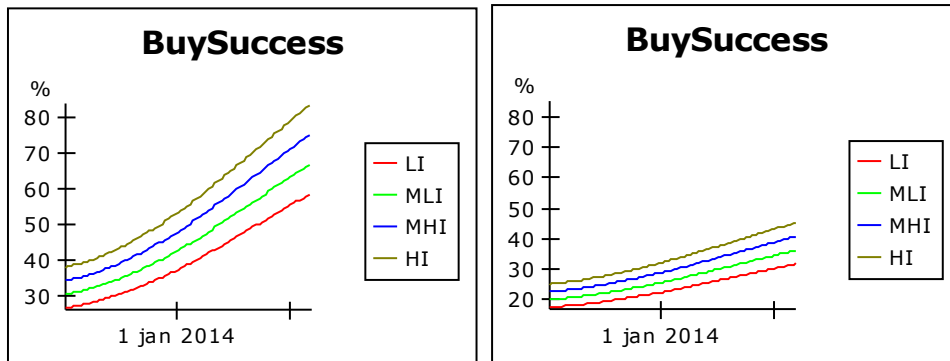

FIGURE 14: TWO POSSIBLE EFFECTS OF POLICY CHANGE BUY OPTION ON BUY SUCCESS HOUSEHOLDS

Two dynamic developments are ignored. First, the measure could maybe increase the propensities to buy of households. Second, propensities to buy do not become saturated. This does not heavily influence the quality of the model because the simulation time is around 10 years.

#### A.4.1.4 European Directive

The European Directive orders that 90% of the inflow consists of low income households, the model assumes 100%, because of the high demand of LI households in the North Wing of the Randstad. This has a clear effect on the specific housing move wishes of several income groups. First, it is important to mention that during the creation of WoON 2009, households were not bound to this Directive already. So, it is possible that a high income household wants to move to the social sector, while in practice this is not possible anymore due to the European Directive. Therefore, all housing move percentages to the social sector of HI and MHI households are multiplied with zero. All start values of demand stocks are also cleaned. Next, an uncertain percentage transform the original demand to the social rental sector to the market rental sector. This is modelled in such a way that it is possible to execute these calculations by turning a switch on or off.

#### A.4.2 Demographic Uncertainty

All demographic developments are assumed to increase or decrease exponentially. The strength of this exponential development is uncertain. In year one, the demographic variable is multiplied with  $(1+(1^{\text{Uncertainty Strength}})/100)$ . The second year results in a multiplication with  $(1+(2^{\text{Uncertainty Strength}})/100)$ , and so on. This trend is multiplied with a random randomizer: A random value between a random lowest value and random highest value.

This is applied to percentages concerning divorces, marriages, first births, deaths, seniors to rest home, delay of transitions of households (T1, T2, T3 to T4, T5). Also a non-demographic variable, attractiveness of North Wing has the same uncertainty function. Figure 15 shows a possible combination of different developments.

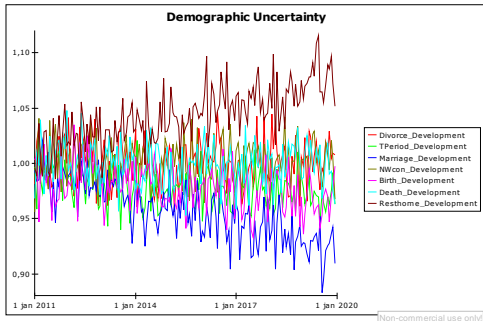

FIGURE 15: RESULT OF EIGHT RANDOM EXPONENTIAL DEVELOPMENTS COMBINED WITH RANDOM RANDOMIZER

### A.4.3 Economic Uncertainty

Economic growth is represented by the summation of two sinuses and a trend. One sinus is the Kondratieff cycle: duration of 45-60 years. The other is the Juglar Cycle which has a duration of 7-11 years. Start values of amplitude, period and starting point are chosen from an uncertainty range. All uncertainty ranges are listed in Appendix C. Each ¼ period the amplitude of the Juglar Cycle is changed with an uncertain value between -0,25 and + 0,25 and the period is changed with an uncertain value between -0,75 and 0,75.

In this very simple representation of economic development, four other economic variables, interest, inflation, income and housing prices follow economic growth with uncertain delay lengths and uncertain delay types. Figure 16 shows two possible economic situations and the corresponding effects, which are described next.

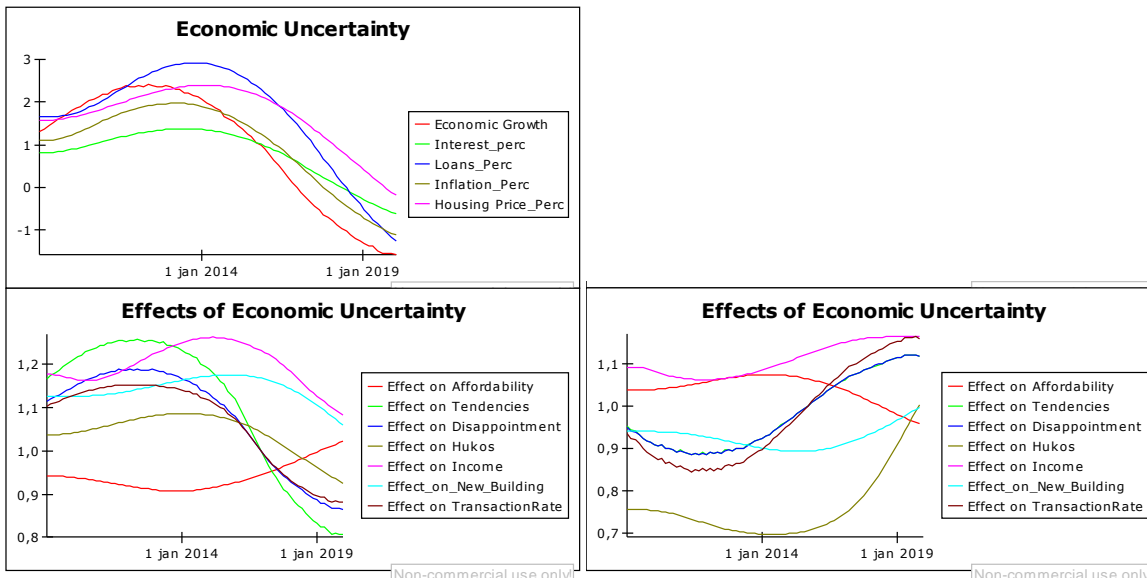

FIGURE 16: TWO POSSIBLE ECONOMIC SITUATION (ABOVE) AND CORRESPONDING EFFECTS (BELOW)

The differences between the sinuses cause the dynamics. It is chosen to model the effects as S-Shapes, which are varied using the techniques described in section 3.3.2. This construction is used to determine the effect of economic growth on new buildings (including delay), propensities to move, transaction rates (for market sectors) and disappointment rates.

The assumptions behind the relations are: Economic growth results in more dwellings (more investments), higher propensities to move (more confidence), longer search times (or lower

disappointment rate), and higher transaction rates for market sectors (more confidence in economy). Because of the expected return on investment, higher housing prices boost the percentage of households which want to move to the homeownership sector. The effect on income (income/inflation) and affordability (Housing Price \* Interest) is determined by a graph function. The effect on income is multiplied with the start value of income development, which is described in section 5.1.2 (1% a year). The effect on affordability is multiplied by the affordability percentages of the home ownership sector. An overview of all the effects is provided by Figure 17.

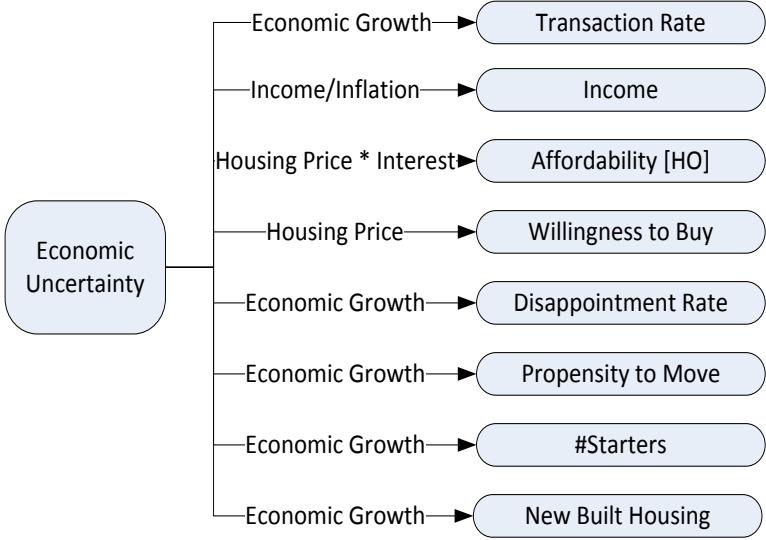

FIGURE 17: EFFECTS OF ECONOMIC UNCERTAINTY

A.5 Initial Settings of the Model

The start situation of the model is determined by the input of WoON 2009. Table gives an overview of the number of households present in North Wing of the Randstad , specified to income groups and sector.

TABLE 6: OCCUPANCE OF HOUSING STOCK, SPECIFIED TO INCOME GROUPS AND SECTOR

Income/Sector	SRQ	SRT	SRL	MR	HO	Total
LI	107.211	126.406	34.371	13.687	62.110	343.790
MLI	48.145	95.600	26.954	7.293	66.563	244.555
MHI	28.237	63.101	28.722	12.519	122.334	254.923
HI	28.410	99.455	50.955	40.609	673.048	892.477
<b>Total</b>	<b>212.003</b>	<b>384.562</b>	<b>141.007</b>	<b>74.108</b>	<b>924.065</b>	<b>1.735.745</b>

The market rent sector is small compared to the social housing sector. Low income household are most strongly represented in the cheapest segments of the social sector (SRQ and SRT). Almost 20% of the market rent sector is occupied by low income households, while in the model it is not possible to move to the market rent sector if one has a low income. It can be argued that low income households entered the market rent sector in a better economic situation, when private landlords were willing to take more risk. Negative income development could be another reason. Also a shortage of social housing can be a cause of low income households moving to another sectors than the social sector. The home ownership sector is by far the largest sector in the North Wing of the

Randstad; this sector is dominated by high income households. Start values of other variables are taken from an uncertainty range. These ranges are given in Table7.

TABLE 7: DIFFERENT START VALUES BY SECTOR

Variable/Sector	SRQ	SRT	SRL	MR	HO
<b>Friction</b>	1-1,5%	1-1,5%	1-1,5%	1-1,5%	1-1,5%
<b>Transaction Rate</b>	20-30 %/mo	20-30 %/mo	20-30 %/mo	10-20 %/mo	10-20 %/mo
<b>Buy-success</b>	15-25% * factor dependent on income of household				n.a.
<b>New Houses</b>	20.000-30.000 houses/year				

The friction percentage determines the amount of supply at the start of the simulation. Supply is equal to  $1/(1-\text{Friction Percentage sector}) * \text{total households sector} - \text{total households sector}$ . For example, the friction percentage of HO sector =1%, the supply amounts to  $(1/0,99)*924.065-924065 = 9334$  houses. The transaction rates are chosen in such a way that the amount of supply stays realistic. When the transaction rates are high, the supply is allocated quickly to households which results in a drop of supply from 1,5% to less than 0,5% in 2 years. The start values of household demands are shown in Table8. These are also specified to income and sector.

TABLE 8: DEMANDS SPECIFIED TO INCOME GROUPS AND SECTOR

Income/ Sector	SRQ	SRT	SRL	MR	HO	Total
<b>LI</b>	8.240	24.269	15.061	0	12.650	60.220
<b>MLI</b>	4.538	17.217	6.946	0	10.641	39.342
<b>MHI</b>	3.519	5.694	7.268	3.437	23.902	43.820
<b>HI</b>	5.363	8.166	10.819	9.722	68.725	102.795
<b>Total</b>	21.660	55.346	40.094	13.159	115.918	246.177
<b>Perc of Stock</b>	10,2%	14,4%	28,4%	17,8%	12,5%	14,2%
<b>Perc of Stock ( European Directive)</b>	6,0%	10,7%	15,6%	71,7%	12,5%	14,2%

In 2009, it was still possible for high income households to move to the social housing sector. The European Directive prohibit these housing moves. Therefore, each run an uncertain percentage of the MHI and HI demand to the social rental sector is added to the demands to the market rent sector. When this percentage amounts to 100%, the demand/total households by sector is as displayed in the last row of Table. This delivers a high pressure on the market rent sector. By starter substitution also the home ownership market receives extra demand of MHI and HI incomes.