



Delft University of Technology

## Adaptive Urban Transformation. Urban Landscape Dynamics, Regional Design and Territorial Governance in the Pearl River Delta, China

Nijhuis, S.; Sun, Yimin; Lange, Eckart

### DOI

[10.1007/978-3-030-89828-1](https://doi.org/10.1007/978-3-030-89828-1)

### Publication date

2023

### Document Version

Final published version

### Citation (APA)

Nijhuis, S., Sun, Y., & Lange, E. (Eds.) (2023). *Adaptive Urban Transformation. Urban Landscape Dynamics, Regional Design and Territorial Governance in the Pearl River Delta, China*. (1 ed.) (The Urban Book Series). Springer Nature. <https://doi.org/10.1007/978-3-030-89828-1>

### Important note

To cite this publication, please use the final published version (if applicable). Please check the document version above.

### Copyright

Other than for strictly personal use, it is not permitted to download, forward or distribute the text or part of it, without the consent of the author(s) and/or copyright holder(s), unless the work is under an open content license such as Creative Commons.

### Takedown policy

Please contact us and provide details if you believe this document breaches copyrights. We will remove access to the work immediately and investigate your claim.

*This work is downloaded from Delft University of Technology.  
For technical reasons the number of authors shown on this cover page is limited to a maximum of 10.*

The Urban Book Series

Steffen Nijhuis  
Yimin Sun  
Eckart Lange *Editors*

# Adaptive Urban Transformation

Urban Landscape Dynamics,  
Regional Design and Territorial  
Governance in the Pearl  
River Delta, China

OPEN ACCESS

 Springer

# The Urban Book Series

## Editorial Board

Margarita Angelidou, Aristotle University of Thessaloniki, Thessaloniki, Greece


Fatemeh Farnaz Arefian, The Bartlett Development Planning Unit, UCL, Silk Cities, London, UK

Michael Batty, Centre for Advanced Spatial Analysis, UCL, London, UK

Simin Davoudi, Planning & Landscape Department GURU, Newcastle University, Newcastle, UK

Geoffrey DeVerteuil, School of Planning and Geography, Cardiff University, Cardiff, UK

Jesús M. González Pérez, Department of Geography, University of the Balearic Islands, Palma (Mallorca), Spain

Daniel B. Hess , Department of Urban and Regional Planning, University at Buffalo, State University, Buffalo, NY, USA

Paul Jones, School of Architecture, Design and Planning, University of Sydney, Sydney, NSW, Australia

Andrew Karvonen, Division of Urban and Regional Studies, KTH Royal Institute of Technology, Stockholm, Stockholms Län, Sweden

Andrew Kirby, New College, Arizona State University, Phoenix, AZ, USA

Karl Kropf, Department of Planning, Headington Campus, Oxford Brookes University, Oxford, UK

Karen Lucas, Institute for Transport Studies, University of Leeds, Leeds, UK

Marco Maretto, DICATeA, Department of Civil and Environmental Engineering, University of Parma, Parma, Italy

Ali Modarres, Tacoma Urban Studies, University of Washington Tacoma, Tacoma, WA, USA

Fabian Neuhaus, Faculty of Environmental Design, University of Calgary, Calgary, AB, Canada

Steffen Nijhuis, Architecture and the Built Environment, Delft University of Technology, Delft, The Netherlands

Vitor Manuel Araújo de Oliveira , Porto University, Porto, Portugal

Christopher Silver, College of Design, University of Florida, Gainesville, FL, USA

Giuseppe Strappa, Facoltà di Architettura, Sapienza University of Rome, Rome, Roma, Italy

Igor Vojnovic, Department of Geography, Michigan State University, East Lansing, MI, USA

Claudia Yamu, Department of Built Environment, Oslo Metropolitan University, Oslo, Norway

Qunshan Zhao, School of Social and Political Sciences, University of Glasgow, Glasgow, UK

The Urban Book Series is a resource for urban studies and geography research worldwide. It provides a unique and innovative resource for the latest developments in the field, nurturing a comprehensive and encompassing publication venue for urban studies, urban geography, planning and regional development.

The series publishes peer-reviewed volumes related to urbanization, sustainability, urban environments, sustainable urbanism, governance, globalization, urban and sustainable development, spatial and area studies, urban management, transport systems, urban infrastructure, urban dynamics, green cities and urban landscapes. It also invites research which documents urbanization processes and urban dynamics on a national, regional and local level, welcoming case studies, as well as comparative and applied research.

The series will appeal to urbanists, geographers, planners, engineers, architects, policy makers, and to all of those interested in a wide-ranging overview of contemporary urban studies and innovations in the field. It accepts monographs, edited volumes and textbooks.

**Indexed by Scopus.**

Steffen Nijhuis · Yimin Sun · Eckart Lange  
Editors

# Adaptive Urban Transformation

Urban Landscape Dynamics, Regional Design  
and Territorial Governance in the Pearl River  
Delta, China

 Springer

### *Editors*

Steffen Nijhuis  
Faculty of Architecture and the Built  
Environment  
Delft University of Technology  
Delft, Zuid-Holland, The Netherlands

Yimin Sun  
School of Architecture  
South China University of Technology  
Guangzhou, Guangdong, China

Eckart Lange  
Department of Landscape Architecture  
The University of Sheffield  
Sheffield, South Yorkshire, UK



ISSN 2365-757X

ISSN 2365-7588 (electronic)

The Urban Book Series

ISBN 978-3-030-89827-4

ISBN 978-3-030-89828-1 (eBook)

<https://doi.org/10.1007/978-3-030-89828-1>

© The Editor(s) (if applicable) and The Author(s) 2023. This book is an open access publication.

**Open Access** This book is licensed under the terms of the Creative Commons Attribution-NonCommercial 4.0 International License (<http://creativecommons.org/licenses/by-nc/4.0/>), which permits any noncommercial use, sharing, adaptation, distribution and reproduction in any medium or format, as long as you give appropriate credit to the original author(s) and the source, provide a link to the Creative Commons license and indicate if changes were made.

The images or other third party material in this book are included in the book's Creative Commons license, unless indicated otherwise in a credit line to the material. If material is not included in the book's Creative Commons license and your intended use is not permitted by statutory regulation or exceeds the permitted use, you will need to obtain permission directly from the copyright holder.

This work is subject to copyright. All commercial rights are reserved by the author(s), whether the whole or part of the material is concerned, specifically the rights of translation, reprinting, reuse of illustrations, recitation, broadcasting, reproduction on microfilms or in any other physical way, and transmission or information storage and retrieval, electronic adaptation, computer software, or by similar or dissimilar methodology now known or hereafter developed. Regarding these commercial rights a non-exclusive license has been granted to the publisher.

The use of general descriptive names, registered names, trademarks, service marks, etc. in this publication does not imply, even in the absence of a specific statement, that such names are exempt from the relevant protective laws and regulations and therefore free for general use.

The publisher, the authors, and the editors are safe to assume that the advice and information in this book are believed to be true and accurate at the date of publication. Neither the publisher nor the authors or the editors give a warranty, expressed or implied, with respect to the material contained herein or for any errors or omissions that may have been made. The publisher remains neutral with regard to jurisdictional claims in published maps and institutional affiliations.

This Springer imprint is published by the registered company Springer Nature Switzerland AG  
The registered company address is: Gewerbestrasse 11, 6330 Cham, Switzerland

# Preface

This publication presents the results of the joint research project ‘Adaptive Urban Transformation (AUT): Urban Landscape Dynamics, Regional Design and Territorial Governance in the Pearl River Delta, China’, a collaboration between Delft University of Technology, Department of Urbanism (TUD, the Netherlands), South China University of Technology, School of Architecture (SCUT, China) and The University of Sheffield, Department of Landscape Architecture (UoS, United Kingdom) that took place from 2017 until 2022. The research was funded by the Dutch Science Foundation (NWO grant no. ALWSD 2016.013 Sustainable Delta Program), the National Science Foundation China (NSFC grant no. 5161101690) and the Engineering and Physical Sciences Research Council (EPSRC grant no. EP/R024979/1).

The overall aim of the research was to develop an integrative and multiscale design and planning approach for adaptive urban transformation in fast urbanising delta landscapes using the PRD as a case study. To achieve this, the research seeks to better understand the relations between urban landscape dynamics, regional design and territorial governance by: (1) developing a portfolio of integrated adaptation measures based on an assessment of ecological capacity and transformation of urban districts and regions; (2) identifying the potential of planning and design approaches for territorial governance and policies that facilitate the implementation of integrated and adaptation measures; and (3) developing and testing innovative visualisation techniques that facilitate participatory, multistakeholder planning approaches. In order to address these aspects, the project involved three interrelated work packages (WPs):

- WP1 focussed on understanding dynamics of transformation and principles of adaptation (TUD). This provided input for WP3 regarding theoretical backgrounds, mapping and identification of planning and design strategies and principles for adaptive urban development. Research questions included: What dynamics of change and transformational cycles at the building, district and urban landscape level offer opportunities for implementing adaptation measures? What (regional) design principles may increase adaptive capacity and mitigate flood risk in the urban landscape at multiple scales?

- WP2 focussed on stakeholder involvement and visualisation (UoS). This WP provides methodical and technical input for WP3 regarding state-of-the-art technology to involve stakeholders and to provide the basis for communication among experts and lay people. Research questions included: How can planning and design interventions be visualised both off-site and on-site (remote laboratory or office and/or mobile devices)? How can the developed visualisation methods help to communicate planning and design interventions to local citizens, stakeholders and among experts? How are the planning and design interventions perceived by local and non-local experts and lay people?
- WP3 focussed on the application of AUT in urban design, planning and governance in the Pearl River Delta (SCUT). Research questions included: What are the current governance approaches, strategies and projects to mitigate flood risk in the PRD and how are they perceived in terms of utility and effectiveness? How could a new territorial governance model with mutual support between economic development and protection of ecological landscape be facilitated under the Chinese governance system? What is the potential of open space for adaptive transformation, to cope with flood risks and ecological recovery?

Each WP had a responsible principal investigator (PI) for coordinating and conducting the research. TUD was responsible for the overall project, and the management team was formed by the three PI's, also the editors of this publication. Regular joint workshops with the involved researchers and local stakeholders safeguarded exchange and synthesis of knowledge.

The chapters in this volume reflect the outcomes of the research conducted within the WPs. As exemplified by the chapters, there are many lessons to be learned for developing sustainable and social-ecological inclusive deltas. The quality, impact and societal relevance of our research in the AUT project are also exemplified by a large number of articles in peer-reviewed journals, more than 30 Ph.D. and M.Sc. theses and several invited keynote addresses at major conferences, such as the prestigious Annual National Planning Conference China 2019 with 10,000 plus visitors and 15,000 plus streamings. Also, online/offline media coverage displays the societal interest in the research, exemplified by interviews and items in (inter)national newspapers and television. Next to policy guidelines and adaptive design principles, the project also led to practical applications and implementation through design projects in which we led the design team responsible for urban development plans in, for example, Guangzhou and Shantou (China).

It is important to keep in mind that the views expressed in this publication are those of the authors and do not necessarily reflect the views of their employers, funders or affiliated institutions.

During the project, the COVID-19 pandemic severely impacted academic and social life and sometimes caused personal tragedy within the research team. Despite the complications, the entire AUT research community showed true resilience and a tremendous capacity for adaptation in maintaining high levels of societally relevant research output.



We would like to thank all the team members, authors and participants for their contributions to the project and this publication. Aaron Bogart is acknowledged for his proofreading. We are also grateful to Juliana Pitanguy and Sanjievkumar Mathiyazhagan from Springer for their patience and their professional guidance and help. We would like to thank the NWO, NSFC and EPSRC for their generous financial support, and NWO for their additional financial support for enabling this open-access publication.

Delft, The Netherlands  
Guangzhou, China  
Sheffield, UK

Steffen Nijhuis  
Yimin Sun  
Eckart Lange

# Contents

## Part I Introduction

<b>1 Introduction: Adaptive Urban Transformation in the Pearl River Delta, China</b> .....	3
Steffen Nijhuis, Yimin Sun, and Eckart Lange	
<b>2 Multi-level Regional Governance and Spatial Development in the Pearl River Delta</b> .....	21
Dongjin Qi and Jinghuan He	
<b>3 Spatial Dynamics in the Pearl River Delta and Development Strategies</b> .....	37
Dai Wei, Han Meyer, and Taneha Kuzniecowa Bacchin	

## Part II Spatial Strategy and Design

<b>4 Territorial Governance and Spatial Planning in Europe: The Relevance for Flood Risk Management in the Chinese Pearl River Delta</b> .....	63
Vincent Nadin and Meng Meng	
<b>5 A Landscape-Based Regional Design Approach for Sustainable Urban Development in the Pearl River Delta, China</b> .....	81
Steffen Nijhuis, Yimin Sun, Daniele Cannatella, and Guangyuan Xie	
<b>6 Design Studios as Method for Exploring Complex Challenges in the Pearl River Delta</b> .....	115
Daniele Cannatella and Steffen Nijhuis	
<b>7 Unrelenting Change</b> .....	133
Peter Bosselmann, Mathias Kondolf, and Jiang Feng	

**Part III Stakeholder Participation and Visualization**

**8 Stakeholder Participation and Visualisation in Sustainable Urban Transformation** ..... 159  
Xi Lu and Eckart Lange

**9 Bridging the Analogue–digital Divide in Stakeholder Engagement** ..... 175  
Adam Tomkins and Eckart Lange

**10 Urban Planning Exhibition Halls in the Pearl River Delta for Planning Communication and Public Participation** ..... 195  
Xi Lu, Sigrid Hehl-Lange, and Eckart Lange

**Part IV Socio-ecological Perspectives**

**11 Industrial Transformation and Sustainable Urban Planning in the Pearl River Delta: A Landscape-based Approach** ..... 209  
Daniele Cannatella

**12 Historical Canals as Urban Landscape Infrastructure in Guangzhou: Reactivating Public Life Through Water** ..... 233  
Yu Zheng, Steffen Nijhuis, and Gregory Bracken

**13 From Modelling and Analysis of Accessibility of Urban Green Space to Green Infrastructure Planning: Guangzhou as a Case Study** ..... 249  
Yueshan Ma, Paul Brindley, and Eckart Lange

**14 Inclusive Urban Transformation: Embracing the Values of Urban Villages in the PRD Region** ..... 267  
Lei Qu

**15 Wetland Parks in Guangzhou: Ecosystem Services and Perception** ..... 285  
Xuezhu Zhai, Ross Cameron, and Eckart Lange

**16 Community Supported Agriculture in the Pearl River Delta** ..... 301  
Ziyi Liu, Nicola Dempsey, and Eckart Lange

# Contributors

**Taneha Kuzniecowa Bacchin** Faculty of Architecture and the Built Environment, Delft University of Technology, Delft, The Netherlands

**Peter Bosselmann** College of Environmental Design, University of California at Berkeley, Berkeley, CA, USA

**Gregory Bracken** Faculty of Architecture and the Built Environment, Delft University of Technology, Delft, The Netherlands

**Paul Brindley** Department of Landscape Architecture, The University of Sheffield, Sheffield, UK

**Ross Cameron** Department of Landscape Architecture, The University of Sheffield, Sheffield, UK

**Daniele Cannatella** Faculty of Architecture and the Built Environment, Delft University of Technology, Delft, The Netherlands

**Nicola Dempsey** Department of Landscape Architecture, The University of Sheffield, Sheffield, UK

**Jiang Feng** School of Architecture, South China University of Technology, TianheGuangzhou, Guangdong, China

**Jinghuan He** School of Architecture, South China University of Technology, Guangzhou, Guangdong, China

**Sigrid Hehl-Lange** Department of Landscape Architecture, The University of Sheffield, Sheffield, UK

**Mathias Kondolf** College of Environmental Design, University of California at Berkeley, Berkeley, CA, USA

**Eckart Lange** Department of Landscape Architecture, The University of Sheffield, Sheffield, UK

**Ziyi Liu** Department of Landscape Architecture, The University of Sheffield, Sheffield, UK

**Xi Lu** College of Landscape Architecture, Nanjing Forestry University, Nanjing, China

**Yueshan Ma** Department of Landscape Architecture, The University of Sheffield, Sheffield, UK

**Meng Meng** Department of Urban Planning, Faculty of Architecture, South China University of Technology, Guangzhou, Guangdong, China

**Han Meyer** Faculty of Architecture and the Built Environment, Delft University of Technology, Delft, The Netherlands

**Vincent Nadin** Department of Urbanism, Faculty of Architecture and the Built Environment, Delft University of Technology, Delft, The Netherlands

**Steffen Nijhuis** Faculty of Architecture and the Built Environment, Delft University of Technology, Delft, The Netherlands

**Dongjin Qi** School of Architecture, South China University of Technology, Guangzhou, Guangdong, China

**Lei Qu** Faculty of Architecture and the Built Environment, Delft University of Technology, Delft, The Netherlands

**Yimin Sun** School of Architecture, South China University of Technology, Guangzhou, Guangdong, China

**Adam Tomkins** Department of Landscape Architecture, The University of Sheffield, Sheffield, UK

**Dai Wei** School of Spatial Planning and Design, Hangzhou City University, Hangzhou, Zhejiang, China

**Guangyuan Xie** School of Architecture, South China University of Technology, Guangzhou, Guangdong, China

**Xue Zhu Zhai** Department of Landscape Architecture, The University of Sheffield, Sheffield, UK

**Yu Zheng** Guangzhou, Guangdong, China;  
Faculty of Architecture and the Built Environment, Delft University of Technology, Delft, The Netherlands

**Part I**  
**Introduction**

# Chapter 1

## Introduction: Adaptive Urban Transformation in the Pearl River Delta, China



Steffen Nijhuis, Yimin Sun, and Eckart Lange

**Abstract** Deltaic areas are amidst the most favourable territories around the globe. Their strategic location and superior quality of their soils are core factors supporting both human development and the rise of these regions as global economic hubs. At the same time, deltas are extremely vulnerable to multiple threats from both climate change and the rush to urbanisation. These include an increased flood risk combined with the loss of ecological and social–cultural values. To ensure a more sustainable future for urbanising deltas, spatial strategies are needed to strengthen resilience, i.e. help the systems to cope with their vulnerabilities as well as enhance their capacity to overcome natural and anthropogenic threats. In this chapter, we outline the basic concepts and backgrounds of a joint research project with academic and societal partners called adaptive urban transformation. The objective of this research is to develop and test an integrative and multiscale design and planning approach for the adaptive urban transformation of urbanising deltas, in which the Pearl River Delta serves as a case study. In this approach, landscape-based regional design plays a key role in adaptive urban transformation, as well as innovative participation and visualisation techniques. Applications in urban design, planning, and governance in the PRD are also introduced. This chapter is foundational for the rest of the research presented in the chapters in this volume.

**Keywords** Resilient urban planning and management · Landscape-based regional design · Adaptive urban planning · Visualisation · Stakeholder participation · Chief urban designer system · Territorial governance

---

S. Nijhuis (✉)

Faculty of Architecture and the Built Environment, Delft University of Technology, Julianalaan 134, 2628 BL Delft, The Netherlands

e-mail: [s.nijhuis@tudelft.nl](mailto:s.nijhuis@tudelft.nl)

Y. Sun

School of Architecture, South China University of Technology, Tianhe, 381 Wushang Road, Guangzhou 510640, Guangdong, China

e-mail: [arymsun@scut.edu.cn](mailto:arymsun@scut.edu.cn)

E. Lange

Department of Landscape Architecture, The University of Sheffield, Sheffield S10 2TN, UK

e-mail: [e.lange@sheffield.ac.uk](mailto:e.lange@sheffield.ac.uk)

© The Author(s) 2023

S. Nijhuis et al. (eds.), *Adaptive Urban Transformation*, The Urban Book Series,  
[https://doi.org/10.1007/978-3-030-89828-1\\_1](https://doi.org/10.1007/978-3-030-89828-1_1)

## 1.1 Introduction

Urbanising deltas are among the most promising and dynamic regions of the world.<sup>1</sup> As well as contributing greatly to the global economy, they are also valuable ecosystems (Meyer et al. 2016; Costanza et al. 1997). Deltas frequently accommodate large populations in particularly sensitive environments that are dominated by water systems. As a result, urbanising deltas are extremely vulnerable to multiple threats (Nicholls and Cazenave 2010; Ericson et al. 2006). Due to difficulties in steering the intensification of urban land use and economic activity within a sensitive water environment, compounded by the absence of effective governance, the outcomes of delta management are often a combination of ecosystem damage and the loss of sociocultural values. This weakens the capacity of deltas to resist natural hazards as well as the risks associated with climate change, thereby negatively impacting the environment, the local economy as well as the health and prosperity of citizens that live around these water systems (Nijhuis et al. 2017).

Urbanising deltas can be understood as a set of complex social–ecological systems and subsystems, each with their own dynamics and speed of change (Fig. 1.1). To ensure a more sustainable future, spatial strategies are needed to strengthen resilience, assist systems to cope with their vulnerabilities, and strengthen their capacity to face natural and human-made threats. These strategies have to consider the complex interrelation of systems in order to avoid damaging ripple effects, such as when urban development increases the risk of flooding. Strategies like these can highlight the potential of ecologically sensitive urban development that ensures economic and social growth, while also providing opportunities to strengthen natural systems and lower the risk of flooding (Nijhuis et al. 2017). At the same time, such spatial strategies must involve a wide range of social and economic actors, while also supporting the social, economic, and cultural conditions of local people. These strategies should be communicated in persuasive ways in order to gain wide understanding, support, and influence (Albrechts 2010; Healey 2006).

Of course, dedicated spatial strategies should not merely improve the living conditions within urban deltas but also promote adaptive measures to climate change in order to decrease the level of risk. Urban planning and management must display a certain degree of adaptive capacity in order to successfully create more resilient deltas. Strategies must also identify eco-dynamic design options that not only enable the integration of nature alongside urban development processes, but also implement adaptive design principles that ensure low flood risk. Additionally, it is necessary to integrate transformative processes in governance combining spatial planning, design, and disaster management in order to optimise land use, institutions, and mechanisms for an efficient, sustainable, and inclusive urbanisation (Nijhuis et al. 2017).

In this chapter, we outline an integrative and multiscale design and planning approach for the adaptive urban transformation of urbanising deltas, taking the Pearl River Delta (PRD) as a case study. In this approach, landscape-based regional design

---

<sup>1</sup> This chapter is based on Nijhuis et al. (2017). Parts of this chapter have been published in adapted form in Nijhuis et al. (2019, Chinese, 2020, English).





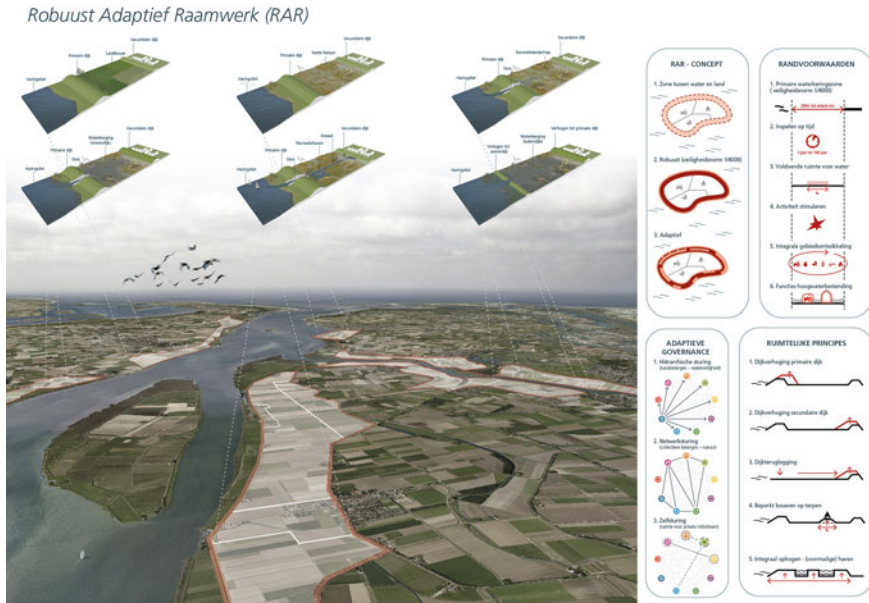
**Fig. 1.1** Fast urbanisation process within the PRD leads to confrontations between incremental long-term urban developments and fast short-term developments. Typical fishing villages and new urban developments in Pazhou, Guangzhou. *Photo* Guangyuan Xie, TU Delft

plays a key role, as well as innovative participation and visualisation techniques. Applications in urban design, planning, and governance in the PRD are also introduced. This chapter is foundational for the research presented in the chapters in this volume.

## 1.2 Adaptive Urban Transformation

From the 2000s onwards, there have been serious attempts to develop an adaptive systems approach to the planning and designing of urbanising deltas. Examples of such attempts include the Rhine–Meuse–Scheldt (RMS) Delta in the Netherlands (Meyer et al. 2015; Rhee 2012), the Mississippi River Delta in the USA (Wagonner et al. 2014; Campanella 2010), and the Mekong Delta in Vietnam (Marchand et al. 2014; Shannon and De Meulder 2013). The research as presented here suggests a much greater potential benefit in using urban landscape dynamics in territorial governance than more traditional planning strategies (Meyer and Nijhuis 2013, 2014, 2016; Van Veelen et al. 2015) (Fig. 1.2).

The main assumption is that urban dynamics, such as processes of urban transformation, regional development, and renovation cycles of individual buildings and assets, offer significant ‘windows of opportunity’ for incorporating adaptation measures at relatively low costs. For example, when buildings are being adapted as part of the normal development cycle, there are opportunities to include flood safety



**Fig. 1.2** Adaptive planning in the south-western delta of the Netherlands. Design explorations for the application of Robust Adaptive Frameworks for the Embankments of the Haringvliet. *Source* Meyer and Nijhuis (2014)

measures. When larger-scale urban transformation is underway, there is an opportunity to make fundamental adaptations to the urban structure through ecosystem design. On a regional scale, changes in port infrastructure, transformation of agricultural landscapes, or patterns of urbanisation create (or prevent) opportunities for creating adaptive capacity. The windows of opportunity in cycles of urban transformation can be used to develop a resilient socio-ecological urban system over the longer term and in a regional context. It requires an integrative approach towards planning and design of urban landscapes that can be channelled through effective territorial governance. Territorial governance can be understood as a process of spatial strategy making which integrates public policies, programmes, and projects for the development of a place/territory (Schmitt and Van Well 2015; Faludi 2012). It coordinates public and private actors that have responsibility or influence over social and ecological systems over large territories. Territorial governance is particularly concerned with integrating policy sectors such as land, water, environment, and transport so as to achieve social cohesion alongside prosperity and sustainability. Territorial governance offers potential to consider the interrelations of systems and avoid the damaging consequences of non-coordination that undermine the resilience of deltas—that is their capacity to absorb shocks while maintaining essential functions (Nijhuis et al. 2017).

At the same time, it is necessary to improve the living conditions in urban deltas and to adapt to climate change in order to decrease their risk level. Urban planning and

management for more resilient deltas necessitate adaptive capacity. That is strategies must identify eco-dynamic design options that could provide opportunities for nature alongside urban development processes and apply adaptive design principles that ensure water safety. In addition, there is also the need to make use of transformative processes in governance that combine spatial planning and disaster management by optimising land use, institutions, and mechanisms for efficient, sustainable, and inclusive urbanisation (Nijhuis et al. 2017). In policy, natural and urban dynamics must set the pace and nature of adaptation that is adaptive urban transformation (AUT).

This volume discussed joint research project with academic and societal partners that addresses AUT and, in particular, adaptive socio-ecological inclusive design strategies and principles that employ natural and urban dynamics to address increasing flood risk and loss of biodiversity in fast urbanising deltas. The research consisted of three interrelated research strands. The first strand focused on understanding dynamics of transformation and principles of adaptation, but also elaborated theoretical backgrounds and identified planning and design strategies and principles for adaptive urban development. The second research strand centred on stakeholder involvement and visualisation and provided methodical and technical input regarding state-of-the-art technology to involve stakeholders and to provide the basis for communication among experts and lay people. The third research strand concentrated on the application of AUT in urban design, planning, and governance in the Pearl River Delta. But before we elaborate on these three research strands, we briefly introduce the Pearl River Delta as a case study (Fig. 1.3).



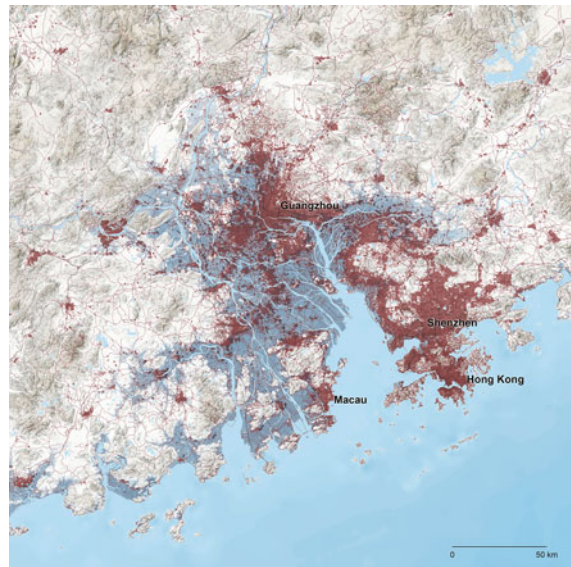
**Fig. 1.3** In the space of forty years, the delta area in the Pearl River has been transformed from a predominantly agricultural landscape into one of the world's largest metropolitan areas of water. *Photo* Guangyuan Xie, TU Delft

### 1.3 Pearl River Delta as a Case Study

For the past four decades, the world's fastest developing delta has been the Pearl River Delta (PRD) in the province of Guangdong in southern China. The delta area in the Pearl River has been transformed from a predominantly agricultural landscape into one of the world's largest metropolitan areas, encompassing such megacities as Guangzhou, Dongguan, Shenzhen, Zhuhai, and Hong Kong (Fig. 1.4). Residential and industrial complexes are being built at breakneck speed. Already in 2014, the PRD replaced Tokyo as the largest and most populated urbanised area on the planet (World Bank 2015). Since the 1980s, the PRD has been at the vanguard of China's groundbreaking spatial planning and socio-economic thinking (Yeh and Li 1999). At the same time, this rapid development is causing such problems as reduced biodiversity and flooding made worse by excessive rainfall and rising sea levels. There are also looming social problems because generic urbanisation alienates people from their environment, offering no space for them to have any significant interaction with nature. In other words, the PRD now faces immense challenges regarding its long-term economic development because of threats posed by climate change and environmental degradation. These challenges include issues such as the disappearance of mangroves (Zhao 2010), the loss of farmland (Hu and He 2003), air and water pollution (Li et al. 2008), water shortages (Wang et al. 2006), and a decrease in social security (Xiong 2016).

On the one hand, the region is exposed to increasing flood risks due to urbanisation in flood-prone areas as well as rising sea levels and extreme typhoons/storms in summer, placing stress on the regions infrastructural systems. On the other hand, the

**Fig. 1.4** The Pearl River Delta in the province of Guangdong in southern China is one of the most rapidly urbanising deltas in the world. More than sixty million people now live in the flood-prone lowland (+10 m zone, here indicated in dark blue), thereby increasing the flood risk. *Map* Steffen Nijhuis



deltaic ecosystem is becoming increasingly fragmented and vulnerable (Gao et al. 2012), resulting in a decline in both ecological services (Ye and Dong 2010) and environmental carrying capacity (Huang 2003). Standardisation of solutions (e.g. infrastructure, buildings) also lead to loss of spatial, cultural, and ecological diversity (Figs. 1.5 and 1.6). For instance, at the local level, large-scale interventions have replaced the historically diverse environmental and cultural heritage of the PRD with more uniform, featureless topographies (Guo and Situ 2010). While local and national authorities are showing increasing awareness of the value of more integrated planning and design approaches, these have not yet been widely introduced (Xiong and Nijhuis 2018). For example, the implementation of the so-called national Sponge City policy—a concept of integrated urban water management—has met with delays in the elaboration of both multiple and separate sectoral plans (Che 2016). In general, sectoral and disciplinary silos cause friction between the much-needed integral solutions and the demand for specialisation of knowledge and governance. To overcome these knowledge and institutional barriers, the development multi-, inter-, and transdisciplinary ways of working is a necessity (Epstein 2021). The alignment of regional ambitions and local projects is also needed to prevent fragmented solutions and spatial conflict, as well as the friction between long-term objectives and short-term needs needs to be resolved (Krzynaric 2020).

In order to guide the PRD towards a more sustainable future, there is an urgent need for new ways of planning and design in the practice of its urban development. The application of the emerging concept and practice of landscape-based regional design offers a way of resolving the conflicts and threats that arise between economic development and environmental recovery, as well as reducing the negative repercussions of climate change. Landscape-based regional design is also an inter- and transdisciplinary approach that combines long-term perspectives with short-term actions and works throughout the scales. The high speed at which the PRD has developed makes it a particularly valuable case study to explore and test the potential of more adaptive integrated planning approaches, such as landscape-based regional design and the

**Fig. 1.5** Mai Po Nature Reserve and the surrounding area—consisting of Gei wai, freshwater ponds, inter-tidal mudflats, mangroves, and reed beds—are recognised as a Wetland of International Importance under the prestigious Ramsar Convention. *Photo* Eckart Lange





**Fig. 1.6** The region has a unique cultural history that reflects a strong connection to the landscape.  
*Photo Steffen Nijhuis*

chief urban designer system. In that regard, the PRD can serve as a practical learning case for other urbanising deltas across the globe.

#### **1.4 AUT Through Landscape-Based Regional Design in the PRD (Research Strand 1)**

AUT employed landscape-based regional design as an integrative and multiscale design and planning approach (Nijhuis 2022). Landscape-based regional design relates to a form of territorial governance that takes the natural and urban landscape as the basis to steer urban–rural transformative processes through a combination of sector activities towards more coordinated sustainable outcomes. In that regard, landscape-based regional design is considered an important strategy that shapes the physical form of regions using landscape as the basic condition to generate sustainable urbanised deltas (Nijhuis 2022). In AUT, we employed spatial planning and design to open up pathways to long-term sustainable urban landscape development and at the same time set conditions for short-term interventions. In that regard, regional design is an inter- and transdisciplinary effort that not only safeguards sustainable and coherent development, but also guides and shapes changes that are brought about by socio-economic and environmental processes, while establishing local identity in a region through tangible relationships (Nijhuis 2022). Regional design offers a mode for urban transformation, preservation of biodiversity, management of water resources, leisure, community building, cultural identity, and economic

development (Neumann 2000). Such a strategy needs to be persuasive and to influence the actions of others and public opinion as the final aim is to implement ideas via projects.

Therefore, landscape-based regional design also means striking a new balance in the relation between experts, citizens, governments, and other stakeholders and seeks for their active involvement. The idea is that the participation of all relevant stakeholders in strategic planning, design, and decision-making will enhance the resilience and adaptability, and the resilience and adaptive capacity of urban landscapes will be increased, not only in physical terms but certainly also in socio-economic terms (Ahern 2011). Resilience is defined as a system's ability to react to change or disruption without any alteration to the primary condition (Walker and Salt 2006). Adaptability is the degree to which certain practices, processes, or structures can be modified to suit changing social, economic, or ecological circumstances (Folke 2016). Modifications can be spontaneous or pre-planned, carried out in response to, or in anticipation of such changes (Folke 2016). This implies a shared understanding of how the landscape system works on the part of all participants. It also requires a forward-looking, proactive approach in which the interaction between all stakeholders is pivotal. Communication is a central issue, and it is crucial to develop and utilise innovative visualisation methods and tools that permit involvement of local stakeholders and decision-makers (Gill and Lange 2015; Lange and Hehl-lange 2010).

Landscape-based regional design is thus also a design process that entails four key phases: (1) diagnosis, (2) strategy making, (3) design explorations, and (4) action perspective. This process is supported by a combination of research and design, meaningful stakeholder involvement, and imagination (Nijhuis 2022) (Fig. 1.7). These phases as well as their application in de PRD are elaborated in Chap. 5 of this volume. Furthermore, more details on territorial governance can be found in Chaps. 2 and 4 of this volume, on spatial dynamics in Chaps. 3 and 11, and Chaps. 6, 7, 12, and 14 for design explorations in the PRD.

**Fig. 1.7** Research through design to explore possible and desirable spatial developments for a future-proof delta. *Photo Steffen Nijhuis*



## 1.5 AUT Through Stakeholder Involvement and Visualisation in the PRD (Research Strand 2)

Visualisation for communication of planning and design contents is key to integration of stakeholders on multiple scales in planning and design processes. It allows to represent and communicate past, existing, and proposed natural and urban environments. Globally rather unique in this domain, in China, there are altogether over 1000 Urban Planning Exhibition Halls (UPEHs). These are large, dedicated facilities equipped with sophisticated technology and providing opportunities for the wider public to be informed about planning and design (Lu et al. 2020). Typically, in planning and design practice, and also in UPEHs, analogue and digital visualisations are used as an endpoint to communicate the results of a process, rather than as an integrated tool in planning and design. In contrast to this, we aim for visualisation and modelling to be used in a more interactive and iterative way thus offering the potential to facilitate dialogue between experts and the wider public in order to develop solutions to problems in planning and design.

The research centred on developing new techniques and approaches to better inform decision-makers and stakeholders in participatory processes on the potential of integrated adaptation measures and potential of adaptation planning. The focus was on stakeholder involvement and visualisation enabling a multiscale systemic understanding of urban landscape dynamics and transformations through ex-post evaluation of existing urban planning strategies and projects and ex-ante evaluation of scenarios of potential adaptation strategies. Visualisations as stimuli are integrated into the feedback mechanisms either through a paper-based format and/or via digital means. In this context, 3D visualisations are developed for off-site use as well as for on-site use for stakeholder involvement. The visualisation approaches build on recently developed innovations and state-of-the-art immersive visualisations, e.g. for display in a virtual reality laboratory or for devices such as the Oculus Rift as well as innovative onsite visualisations for use on mobile devices (Tomkins and Lange 2020). Mixed qualitative semi-structured interview approaches are employed as well as quantitative methods (e.g. semantic differential, contingent valuation) investigating the views of planning and design experts and lay persons as well as considering off-site (laboratory based) versus on-site (mobile devices) feedback and assessment.

As part of our research, we implemented immersive virtual reality (VR) representations using head mounted displays for testing stakeholder behaviour and perception of different scenarios for large-scale urban developments (Lu et al. 2021) (Fig. 1.8). We developed a novel augmented reality (AR) interface that allows enriching GIS maps with overlays of design alternatives while running a dynamic multi-criteria analysis (Fig. 1.9). Bridging the classic analogue–digital divide in representation, we visually enrich physical models with mobile tablet-based AR by implementing 3D model recognition and tracking with superimposed designs of blue and green infrastructure as well as providing opportunities for object occlusion allowing, for example, a virtual replacement of existing buildings with alternative designs (Fig. 1.10). Using



a mixed reality toolkit, on-site visualisation approaches permit to enrich the reality, for example with visualised procedural vegetation models.

In a broader context, we explored several research strands. This includes studying how the wider public perceives wetland parks in terms of providing a range of ecosystem services (Zhai and Lange 2021), how stakeholders as consumers can be integrated in novel agricultural production systems such as community supported agriculture and investigating how park users are provided with the opportunity to access urban green space by developing GIS-based models as well as stakeholder surveys to look into specific demands, usage patterns, and perceptions of different user groups, thereby aiming to deliver input to green infrastructure planning (Ma et al. 2022).

In Chaps. 8, 9, and 10, one can find elaborations on stakeholder participation and visualisation, as well as applications in the PRD from the social–ecological perspective in Chaps. 13, 14, and 16 in this volume.

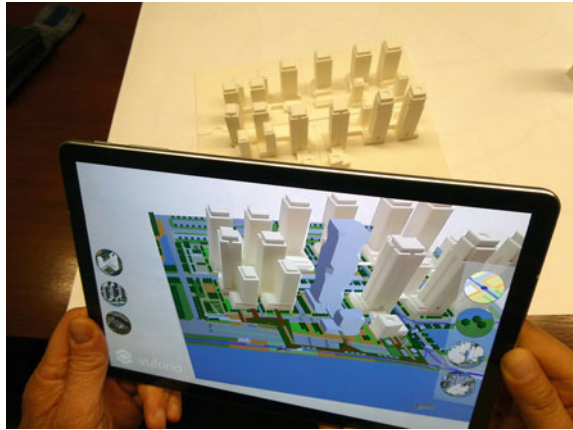
**Fig. 1.8** Immersive virtual reality (VR) representations using head mounted displays for testing stakeholder behaviour and perceptions of different planning scenarios for large-scale urban developments. *Photo Eckart Lange*



**Fig. 1.9** Augmented reality (AR) interface that allows for enriching GIS maps with overlays of design alternatives while running a dynamic multi-criteria analysis. *Photo Eckart Lange*



**Fig. 1.10** Mobile tablet-based AR by implementing with 3D model recognition and tracking with for superimposing designs of blue and green infrastructure and virtual replacement of buildings in the physical model. *Photo Eckart Lange*



## 1.6 AUT Through Applications in Urban Design, Planning, and Governance in the PRD (Research Strand 3)

In order to implement AUT in urban design, planning, and territorial governance in the PRD, the planning system was evaluated for its potential to adopt integrative approaches to design, planning, and flood risk management for more sustainable and inclusive urbanisation. Through literature review and interviews with different local stakeholders, constraints in the current territorial planning and policies are identified that block integrated adaptation measures. Urban design projects and related research are trapped in the concept of single-construction engineering and lack a ‘helicopter view’ that relates the development to the bigger context, such as the city or the overall thinking of the city, the whole bay area. Therefore, we proposed and implemented the ‘chief designer system’ to transcend the professional boundaries of architecture, urban design, landscape architecture, and project development, to develop an inclusive platform for negotiation and communication, and to implement adaptive design principles in urban projects.

Urban design implementation is at the core of the chief urban designer system. It can optimise and correct the detailed control plans, explore and design adaptive urban open spaces, and establish a balance between economic development, the integration of cultural heritage, the creation of a green–blue environment (water and ecology), and lively public spaces (Fig. 1.11). On the basis of that, the urban design guidelines are therefore incorporated into the legal control, i.e. into the general contract documents of land transactions, legally secured the contractual binding of the fundamental application of the guidelines, and avoided various possible negative impacts. Thus, the urban design guidelines would become the starting point for negotiation and coordination among multiple parties, and the ‘chief design team’ can seek win–win results through negotiation under the premise of safeguarding public interest and environmental benefits. Because of this procedure, landscape-based regional design has a strong platform on which to implement the fundamental idea of ‘proposing the best solution and challenging the limitations of urban development’.

**Fig. 1.11** Lively public space with water as a play feature and for a pleasant microclimate. *Photo Steffen Nijhuis*

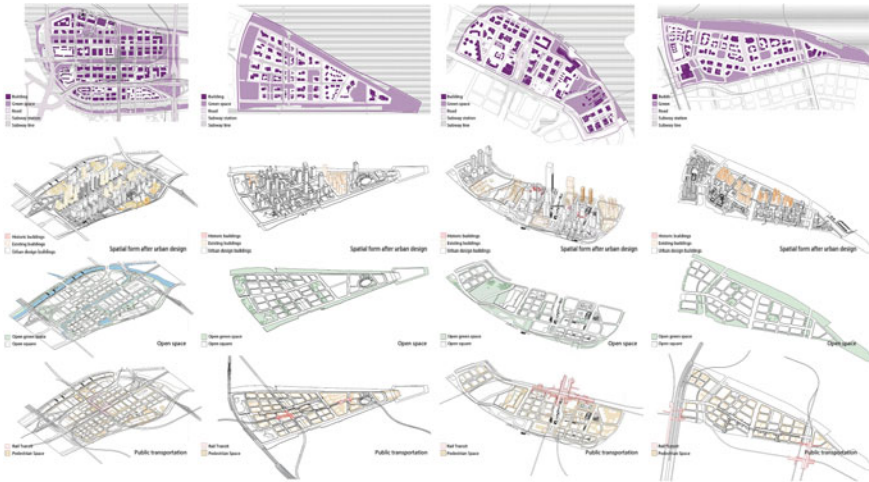


The chief urban designer system evolves around ‘grand urban projects’ (Fig. 1.12). These types of project are developed and constructed at a mesoscale (measured by kilometres) of the city and are intensively built to meet the multi-objective needs of urban development such as accelerated growth in the number of buildings and the speed of construction, as well as the limited land resources and the pressure of population density. For a long time, in the Chinese context, urban construction and architecture were based on a single block, and the basic purpose of planning management was also based on the individual plot. So, there are many bottlenecks in the engineering science and technology research on the concept of urban mesoscale. Therefore, based on our practice of grand urban projects, we break through the traditional architectural boundaries and combine the urban design concept of ‘smart construction’ and the chief urban designer system to realise the territorial governance and regulate the overall built environment in the PRD so as to adapt to the future flood risks and create social–ecological inclusive public spaces with identity.

In Chap. 5, two urban projects in Nansha Lingshan Island and Pazhou West District (Guangzhou) testify how the chief designer system helped to implement AUT successfully and showcase the benefits of this approach (Fig. 1.13). In Chaps. 5, 6, 7, 11, 12, and 14 in this volume, one can find more background and elaboration regarding AUT in urban design, planning, and governance.

## 1.7 Conclusion

Adaptive urban transformation addresses socio-ecological inclusive design strategies and principles that employ natural and urban dynamics to address increasing flood risk and loss of biodiversity in fast urbanising deltas. The PRD served as a learning case for exploring the potential of AUT through landscape-based regional design, novel forms of stakeholder involvement and visualisation, and applications in urban design, planning, and governance.



**Fig. 1.12** Some urban grand projects were developed and managed by chief urban designer system in PRD, from left to right Pazhou West District, Nansha Lingshan Island, Hengli Island North District, and CBD Baietan. *Images* Yimin Sun



**Fig. 1.13** Pazhou West District as a successful application of the chief urban designer system; left the situation in 2012, right the situation in 2022. *Photos* Yimin Sun

Landscape-based regional design proved to provide a new operational power for spatial design—as an integrative, creative activity—and recognises the regional urban landscape as a significant field of inquiry that is context-driven, solution-focused, and transdisciplinary. As will be exemplified by the other chapters in this volume, this approach offered alternative ways of understanding the urban landscape, as well as provided a spatial design process that served as a vehicle for collaboration and co-creation of knowledge and ideas.

In the case of the PRD, this process facilitated mutual learning across disciplines, stakeholders, and cultures. In addition, as a spatial design approach it helped to establish relationships between ecology and cultural aspects, process and form, long-term and short-term developments, and regional strategies and local interventions. As such, landscape-based regional design turned out to be a powerful vehicle for guiding

territorial transformations in the PRD through a process of creating local identity and safeguarding regional relationships and at the same time linking ecological and social processes and urban forms. The newly developed visualisation and modelling approaches proved to be highly effective in visualising a range of data and scenarios in interactive ways while integrating stakeholders at multiple stages and on multiple planning and design levels in the decision-making process.

In terms of applications in urban design, planning and governance in the PRD AUT turned out to be very effective, especially through the implementation of the chief urban designer system. This approach operated as coordination and communication platform for government, architects, and other stakeholders. The grand urban project at the mesoscale proved to be an effective instrument for the chief urban designer to connect the regional landscape with building blocks and individual buildings and align sustainable long-term perspectives and short-term urban projects. In this respect, AUT helped to break through individual building plot borders to establish comprehensive territorial administration and save money by coordinated and joint action.

The case of AUT in the PRD showcases that understanding and employing the relations between urban landscape dynamics, landscape-based regional design, and territorial governance help the urban landscape to cope with its vulnerabilities as well as to enhance its capacity to overcome natural and artificial threats. Next to strengthening resiliency, such an integrative and multiscale design and planning approach provides powerful means for adaptive urban transformation that leads to more sustainable futures of urban deltas in which social–ecological inclusive communities and economy thrive.

## References

- Ahern J (2011) From fail-safe to safe-to-fail: Sustainability and resilience in the new urban world. *Landsc Urban Plan* 100:341–343
- Albrechts L (2010) More of the same is not enough! How could strategic spatial planning be instrumental in dealing with the challenges ahead? *Environ Plann B Plann Des* 37:1115–1127
- Campanella R (2010) Delta urbanism: New Orleans. American Planning Association, Chicago
- Che W (2016) Difficulties and keys of sponge city construction. In: The twelfth international conference on green and energy-efficient building new technologies and products expo. Beijing. <http://www.archcy.com/point/benzdj/1217cc289876a436>
- Costanza R et al (1997) The value of the world's ecosystem services and natural capital. *Nature* 387:253–260
- Epstein D (2021) Range. Why generalists triumph in a specialized world. Penguin Putnam Inc., London
- Ericson JP et al (2006) Effective sea-level rise and deltas: causes of change and human dimension implications. *Glob Planet Change* 50(1–2):63–82
- Faludi A (2012) Multi-level (territorial) governance: three criticisms. *Plan Theory Pract* 13(2):197–211
- Folke C (2016) Resilience. *Ecol Soc* 21(4):44. <https://doi.org/10.5751/ES-09088-210444>
- Gao Y et al (2012) Landscape ecological security assessment based on projection pursuit in Pearl River Delta. *Environ Monit Assess* 184(4):2307–2319

- Gill L, Lange E (2015) Getting virtual 3D landscapes out of the lab. *Comput Environ Urban Syst* 54:356–362. <https://doi.org/10.1016/j.compenvurbsys>
- Guo S, Situ S (2010) The value and utilization of mulberry-dike-fish-pond in the Pearl River Delta in perspective of the agricultural heritage. *Trop Geogr* 30(4):452–458
- Healey P (2006) Relational complexity and the imaginative power of strategic spatial planning. *Eur Plan Stud* 14:525–546
- Hu W, He J (2003) Built-up land-cover change monitoring by remote sensing of urban area in the Pearl River Delta based on GIS. *J Remote Sens* 7(3):201–207
- Huang X (2003) Discussion on population issue in sustainable development of social-economy in the Pearl River Delta. *Geogr Geo-Information Sci* 19(5):109–112
- Krznicaric R (2020) *The good ancestor. How to think long term in a short-term world.* Penguin Putnam Inc., London
- Lange E, Hehl-Lange S (2010) Citizen participation in the conservation and use of rural landscapes in Britain—the Alport Valley case study. *Landscape Ecol Eng* 7:223–230. <https://doi.org/10.1007/s11355-010-0115-2>
- Li Y et al (2008) Impact of land use patterns on eco-environment in Pearl River Estuary. *Prog Geogr* 27(3):55–59
- Lu X, Tomkins A, Hehl-Lange S, Lange E (2021) Finding the difference: Spatial perception of planning phases of high-rise urban developments. *Comput Environ Urban Syst* 90:101685. <https://doi.org/10.1016/j.compenvurbsys.2021.101685>
- Lu X, Hehl-Lange S, Lange E (2020) Landscape visualisation and visitor perception in the Guangzhou urban planning exhibition hall. *J Digit Landsc Arch* 5:330–338. <https://doi.org/10.14627/537690034>
- Ma Y, Brindley P, Lange E (2022) The influence of socio-demographic factors on preference and park usage in Guangzhou. *China Land* 11:1219. <https://doi.org/10.3390/land11081219>
- Marchand M, Pham DQ, Le T (2014) Mekong Delta: living with water, but for how Long? *Built Environ* 40(2):230–243
- Meyer H, Nijhuis S (eds) (2014) *Urbanized deltas in transition.* Techne Press, Amsterdam
- Meyer H, Nijhuis S (2013) Delta urbanism: planning and design in urbanized deltas—comparing the Dutch delta with the Mississippi River delta. *J Urban* 6(2):160–191
- Meyer H et al (eds) (2015) *New perspectives on urbanizing deltas: a complex adaptive systems approach to planning and design.* MUST Publishers, Amsterdam
- Meyer H, Nijhuis S (2016) Designing for different dynamics: the search for a new practice of planning and design in the Dutch delta. In: Portugali J, Stolk E (eds) *Complexity, cognition, urban planning and design*, Springer proceedings in complexity. Springer, Heidelberg, pp 293–312. [https://doi.org/10.1007/978-3-319-32653-5\\_16](https://doi.org/10.1007/978-3-319-32653-5_16)
- Meyer H et al (2016) A plea for putting the issue of urbanizing deltas on the new urban agenda, UN Habitat III. Delta Alliance, TU Delft & Ministry of Foreign Affairs, Delft & The Hague
- Neuman M (2000) Regional design: recovering a great landscape architecture and urban planning tradition. *Landsc Urban Plan* 47:115–128
- Nicholls RJ, Cazenave A (2010) Sea-level rise and its impact on coastal zones. *Science* 328:1517. <https://doi.org/10.1126/science.1185782>
- Nijhuis S, Sun Y, Lange E (2017) Adaptive urban transformation (AUT)—Territorial governance, spatial strategy and urban landscape dynamics in the Pearl River Delta. Delft University of Technology, Department of Urbanism (NL); South China University of Technology, School of Architecture (SCUT) (China); The University of Sheffield, Department of Landscape
- Nijhuis S, Xiong L, Cannatella D (2019) Towards a landscape-based regional design approach for adaptive transformation in urbanizing deltas. *Landsc Arch 风景园林* 170(9):8–22. <https://doi.org/10.14085/j.fjyl.2019.09.0008.15> (Chinese)
- Nijhuis S, Xiong L, Cannatella D (2020) Towards a landscape-based regional design approach for adaptive transformation in urbanizing deltas. *Res Urban Ser* 6:55–80. <https://doi.org/10.7480/rius.6.94>

- Nijhuis S (2022) Landscape-based urbanism: cultivating urban landscapes through design. In: Roggema R (ed) *Design for regenerative cities and landscapes. Contemporary urban design thinking*. Springer Nature, pp 249–77. [https://doi.org/10.1007/978-3-030-97023-9\\_11](https://doi.org/10.1007/978-3-030-97023-9_11)
- Rhee G (2012) *Handreiking Adaptief Delta management*. Leiden
- Schmitt P, Van Well L (2015) *Territorial governance across Europe: pathways, practices and prospects*. Routledge, London
- Shannon K, Meulder B (2013) *Water urbanisms: east*. UFO, Amsterdam
- Tomkins A, Lange E (2020) Bridging the analog-digital divide: enhancing urban models with augmented reality. *J Digit Landsc Arch* 5:366–373. <https://doi.org/10.14627/537690037>
- Van Veelen PC, Stone K, Jeuken A (2015) Planning resilient urban waterfronts using adaptive pathways. *Proc Inst Civ Eng Water Manage* 168(2):49–56
- Waggonner D et al (2014) New Orleans after Katrina: Building America’s water city. *Built Environ* 40(2):281–299
- Walker B, Salt D (2006) *Resilience thinking: sustaining ecosystems and people in a changing world*. Island Press, Washington, DC
- Wang S, Hu D, Li C (2006) The recent evolution of Modaomen Estuary and its effect on flood drainage. *Mar Sci Bull* 25(2):21–26
- World Bank (2015) *East Asia’s changing urban landscape: measuring a decade of spatial growth*. World Bank, Washington, DC
- Xiong H (2016) *Urban crime and social disorganization in China: a case study of three communities in Guangzhou*. Springer, Singapore
- Xiong L, Nijhuis S (2018) Exploring spatial relationships in the Pearl River Delta. In: Ye X, Liu X (eds) *Cities as spatial and social networks*. Springer, Heidelberg
- Ye C, Dong Y (2010) Effects of land use change on ecosystem service value of the Pearl River Delta. *Trop Geogr* 30(6):603–608
- Yeh A, Li X (1999) Economic development and agricultural land loss in the Pearl River Delta, China. *Habitat Int* 23:373–390
- Zhai X, Lange E (2021) The influence of covid-19 on perceived health effects of wetland parks in China. *Wetlands* 41:101. <https://doi.org/10.1007/s13157-021-01505-7>
- Zhao Y (2010) The remote sensing dynamic monitoring of the evolution of shoreline and mangrove wetlands in the Zhujiang River Estuary in the past 30 years. *Remote Sens Land Resour* 86(Suppl):178–184

**Open Access** This chapter is licensed under the terms of the Creative Commons Attribution-NonCommercial 4.0 International License (<http://creativecommons.org/licenses/by-nc/4.0/>), which permits any noncommercial use, sharing, adaptation, distribution and reproduction in any medium or format, as long as you give appropriate credit to the original author(s) and the source, provide a link to the Creative Commons license and indicate if changes were made.

The images or other third party material in this chapter are included in the chapter’s Creative Commons license, unless indicated otherwise in a credit line to the material. If material is not included in the chapter’s Creative Commons license and your intended use is not permitted by statutory regulation or exceeds the permitted use, you will need to obtain permission directly from the copyright holder.



# Chapter 2

## Multi-level Regional Governance and Spatial Development in the Pearl River Delta



Dongjin Qi and Jinghuan He

**Abstract** In the deepening process of globalisation, reactions to socio-economic activities and resolutions of urban problems have to move from the urban scale to the regional scale. Coordinated development of urban agglomerations becomes a vital strategy for China to respond to the challenges and opportunities brought by globalisation. Urban agglomeration in the Pearl River Delta (PRD) has accumulated rich experience in regional coordinated development, including regional planning practice and cooperation of infrastructure development. In this chapter, various versions of PRD regional plans are reviewed, including the Plan for the Urban System in the PRD (1991) and the Planning Framework for the Development of the Guangdong-Hong Kong-Macau Greater Bay Area (China Central and State Council (2019) Planning framework for the development of the Guangdong-Hong Kong-Macau Greater Bay Area (2019–2035). China Central and State Council Printing Office, Beijing). Practice of coordinated development in the PRD is reviewed at four levels: cooperation at ministry-province level, cooperation at province-municipality level, integrative development at municipal level and coordination at town/district level. It is shown that regional coordinated development in the PRD has gradually deepened from the regional level to the municipality and the town/district level. The transformation and adjustment of their roles, the construction of common interests and the innovation of ‘incentive regulation’ mechanisms are not only the basis of coordinated development, but also key elements to promoting the planning process.

**Keywords** Pearl River Delta · Urban agglomeration · Regional coordinated development · Multi-level governance · Cross-boundary cooperation · Spatial planning

---

D. Qi (✉) · J. He  
School of Architecture, South China University of Technology, Tianhe, 381 Wushang Road,  
Guangzhou 510640, Guangdong, China  
e-mail: [djqi@scut.edu.cn](mailto:djqj@scut.edu.cn)

J. He  
e-mail: [arhjh@scut.edu.cn](mailto:arhjh@scut.edu.cn)



## 2.1 Introduction

After the Opening Up Reform (1978), the central government improved the investment environment and promoted local development through administrative decentralisation and inter-city competition. However, excessive local competition has led to waste of resources, environmental damage and inefficient investment in areas of environment, industry and infrastructure. The interrelationship between global companies, the central government and local governments has become more complex. A city-region, instead of a single city, has become the main entity of global competition, while the improvement of regional competitiveness has become an important engine for national economic development. In the absence of regional governments, China has begun to seek new paths for coordinated development between cities and regional governance.

In the EU, the main obstacle to coordinated development is the difference of administrative system and urban planning system between participating entities, more specifically, the competences of the corresponding levels of governments. Diffusing the difference becomes a key step to promote horizontal cooperation. China's administrative structure has top-down characteristics. Thus, the difficulties and solutions encountered in the coordinated development process differ considerably from those of the EU (Huang 2020).

In China, fragmented governance systems (different powers in equivalent levels of governments) constrain the flow of economies and the circulation of capital (Zhang et al. 2020a, b). Powers in rescaling provide a proper tool to interpret regional governance. Power rescaling is the process of power moving between different geographical scales. The EU has built a new spatial platform through power rescaling to adapt to new socio-economic activities, to promote the accumulation of capital and flow of production factors, and to solve changing spatial problems. It mainly occurs at supranational scale and at region scale (Hall and Jones, 2002). However, power rescaling in China influences multiple levels of the country: province, municipality, town and district.

The objective of this chapter is to review the regional coordinated development experience of the PRD, which is a border region in China. This chapter consists of three parts. Firstly, 14 regional plans of this region and their evolved targets are reviewed. Secondly, coordinated developments of the PRD are illustrated from the regional governance perspective at ministry-province, province-municipality, municipality and town-district levels, respectively. We conclude with a discussion on matches between successful projects and levels of governance.

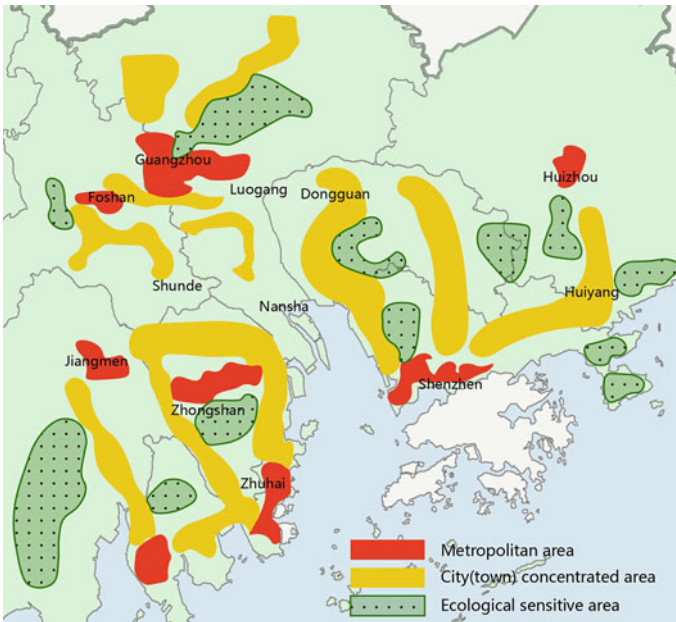
## 2.2 Regional Plans in the PRD

In the past 30 years, the central government and the provincial government have respectively enacted 14 regional plans to promote the coordinated development in

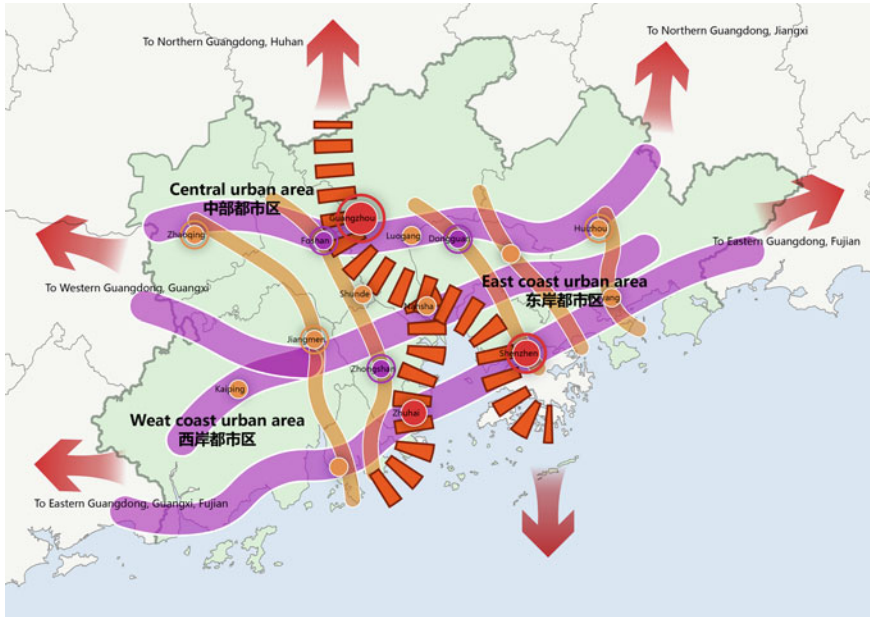
the PRD, and thereby to enhance the competitiveness of the region. Before the return of Hong Kong and Macau, the Canton Provincial Government issued two versions of regional plans: the Plan for the Urban System in the PRD (1991–2010) and the Plan for Urban Agglomeration in the PRD (1994). The former proposed the concept of the PRD for the first time. In that plan, the PRD includes only nine cities, not counties outside Zhaoqing. The latter initiated a polycentric urban structure in the PRD. Guangzhou, Shenzhen, Zhuhai and Huizhou are the four centres, and the complementary functions of each city (Fig. 2.1).

In the 2000s, the Plan for Coordinated Development in the PRD (2004–2020) was the first version of the regional plan updated after the return of Hong Kong and Macau. The main urban structure transformed from polycentric to multi-axes, i.e. ‘Guangzhou-Shenzhen’ axis and ‘Guangzhou-Zhuhai’ axis (Fig. 2.2). Construction of regional transportation infrastructures, regional ecological structures and green spaces is the three most important issues in this plan. The Intercity Rail Transit Network Plan in the PRD (2001), the Medium and Long-term Plan for Railway Network (2004) and the Intercity Rail Transit Network Plan in the PRD (2005–2020) were all issued during this period in response to the Plan for Coordinated Development in the PRD (2004–2020).

The Planning Framework for Reform and Development in the PRD (2008–2020; hereinafter referred to as Planning Framework 2008) was endowed with strategic significance by the central government. In this plan, the PRD is defined as playing



**Fig. 2.1** Polycentric structure of the PRD. Redrawn by author based on plan for urban agglomeration in the PRD 1994 (Canton Provincial Construction Commission, 1996)

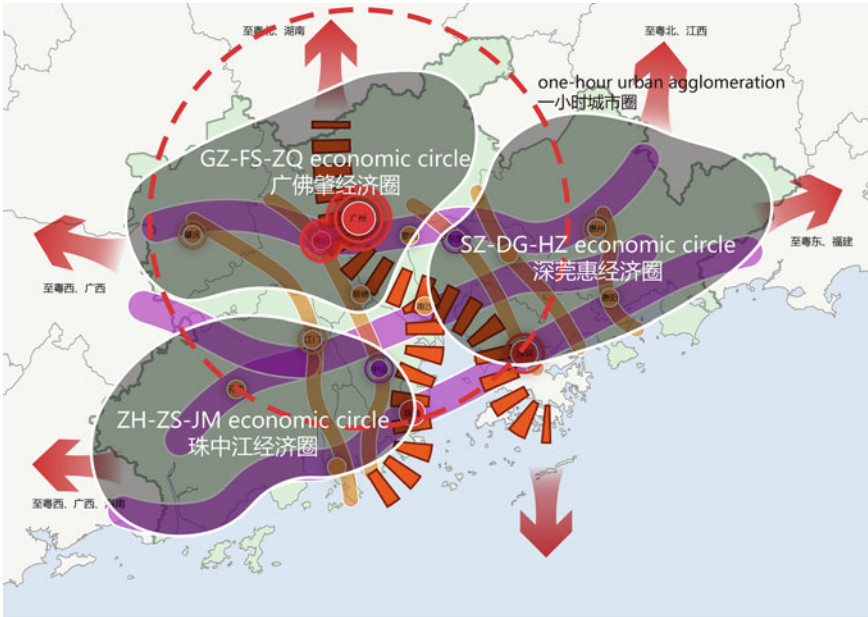


**Fig. 2.2** Two-axes structure of the PRD. Redrawn by author based on coordinated development in the PRD 2004–2020 (Editorial Board of Plan for Coordinated Development of the Pearl River Delta, 2007)

a leading role in promoting and radiating the coordinated development of the whole country. Hong Kong and Macau are included in coordinated development for the first time. The regional structure was changed from two-axes to a multilevel and multi-centre spatial development model based on three nodes: Guangzhou-Foshan, Shenzhen-Hong Kong and Zhuhai-Macau (Fig. 2.3). In May 2010, five sectoral plans in domains of infrastructure development, industrial development, public service, environmental protection and urban–rural planning were enacted.

Under the pressure of the central government, Hong Kong and Macau were involved in the coordinated development in the PRD. They promulgated the Agreement on Canton-Hong Kong Cooperation Framework (2010) and the Agreement on Canton-Macau Cooperation Framework (2011), respectively. And the three governments (Guangdong Provincial Ministry of Housing and Urban–Rural Development, Hong Kong Planning Department and Department of Transport and Public Works of Macau) jointly prepared the Study on the Key Action Plan for the Construction of a Livable Bay Area around the Pearl River Estuary (2012).

With the gradual deepening of cooperation between the three governments, the National Development and Reform Commission and the Canton Provincial Government, Hong Kong and Macau signed the Agreement on Deepening Canton-Hong Kong-Macau Cooperation and Promoting Development of the Greater Bay Area (2016) in July 2017. Coordinated development has moved to an era of the Greater



**Fig. 2.3** Multi-node, multi-centre network structure of the PRD. Redrawn by author based on planning framework for reform and development in the PRD 2008–2020 (2009)

Bay Area. Subsequently, the Planning Framework for development of the Greater Bay Area (2019–2–35; hereinafter referred to as Planning Framework 2019) was issued by the State Council. This plan continued the multilevel, multi-centred spatial structure, proposed a technology innovation corridor crossing Guangzhou-Shenzhen-Hong Kong-Macau, promoted integration of regional infrastructure and carried forward the improvement of ecological environment (China Central and State Council, 2019).

Since the 27 years the PRD was initiated, spatial objectives and structures for the coordinated development have evolved in various versions of regional plans. The focal topics include the construction of regional transportation and balance of municipal infrastructure, integrated development of industrial space, regional balance of ecological environment and construction of a high-quality life circle suitable for business, daily life and tourism. All the above objectives and spatial structures have impacts on the spatial development and regional governance in the PRD to varying degrees.

## 2.3 Regional Governance of Coordinated Development in the PRD

The practice of regional coordinated development in the PRD, which has been influenced by those regional plans, can be roughly divided into four stages according to the main entities of cooperation: cooperation at ministry-province level, cooperation at province-municipality level, integrative development at municipal level and coordination at town/district level. In each stage, the entities, cooperation mechanisms, planning tools and implementation projects are different.

### 2.3.1 Cooperation at Ministry-Province Level

Each version of the regional plans focuses on the development of regional transportation infrastructure, of which intercity rails are typical projects. Canton Provincial Railway Construction Investment Group Co., Ltd., the Fourth China Railway Survey and Design Group Co. Ltd, and the Department of Housing and Urban-Rural Development of Canton Province started the Feasibility Study on the PRD Intercity Rail in 2000. Based on the results of the feasibility study, the Intercity Rail Transit Network Plan in the PRD (2001), the Medium and Long-term Plan for Railway Network (2004) and the Intercity Rail Transit Network Plan in the PRD (2005–2020) are successively circulated. Two main transit axes were identified: the Guangzhou-Zhuhai Line and the Guangzhou-Dongguan-Shenzhen Line. This marked the beginning of cooperation between ministries and provinces.

Until 2010, the construction and operation of inter-city railroads had adopted a mode of cooperation between ministries and provinces. The Ministry of Railways and the Guangdong Provincial Government are responsible for the construction and operation process in accordance with 50% of each. The land acquisition and demolition costs along the railway line are undertaken by municipal governments. Construction of the Guangzhou-Zhuhai Line (2005–2012) was completed and put into operation under the mode of ministry-province cooperation (Table 2.1). In the process of cooperation with the Canton Provincial Government, the Ministry of Railways has played a dominant role due to three main reasons: (1) control of finance and funds; (2) control of administrative powers, such as competence of policy making and planning approval; (3) technology and information. The provincial government has always been in a subsidiary position due to a lack of technology and resources (Pang 2019). However, this cooperation mode doesn't last long. Since December 2011, the investment ratio of Canton Province and the Ministry of Railways has changed from 5:5 to 6:4. The Ministry of Railways faded out due to two reasons: one is due to the Wenzhou high-speed rail incident in July 2011; the other is financial burden. The provincial government took charge of the construction of intercity railroads thereafter. At ministry-province level, construction of regional transportation infrastructure like intercity rails is major projects.

**Table 2.1** Division of powers and cost allocation of entities at different levels in different periods, around 2008

Scale	Entities	Role		Competences		Cost sharing	
		dominant	/	Construction, operation, burden of loss, technical consulting	Technical consulting	50% construction fee	/
national	Ministry of Railways						
Regional	Canton Provincial Gov. (Provincial Railway Investment Co.)	Subsidiary	Dominant	Construction, operation, burden of loss	Construction, operation, burden of loss	50% construction fee	100% construction fee
Local	Municipal Gov	Subsidiary	Subsidiary	Land requisition, demolition	Land requisition, demolition	100% demolition cost	100% demolition cost

### 2.3.2 *Cooperation at Province-Municipality Level*

The progress of the intercity rail network was seriously delayed because of lack of funds. In addition, deficit of operation reached 820,000,000 and 1,070,000,000 yuan, respectively, in 2011 and 2012 after the Guangzhou-Zhuhai Line was put into operation (Zhang et al. 2020a, b). The provincial government is undoubtedly facing tremendous pressure, and it must find a new partner. Municipal governments became the main partner because they have the authority of land development and the motivation to reap huge dividends from it.

However, the provincial governments and municipal governments have different interests. The former concerns regional balance, while the latter focuses on profit from land development. In the early stage of cooperation, municipal governments played the dominant role. First, they are able to integrate the resources of various ministries. Second, they benefit from land development. This relationship is reflected in the locations of intercity railway stations, which are usually in periphery and suburbs. This result reflects the municipal governments' intention to increase development profits through reducing land acquisition and demolition costs.

Later, the provincial government adjusted its cooperative relationship with the city government through horizontal adjustment and vertical reconstruction of power. Regarding the horizontal adjustment of power, the provincial government initiated a new institution in July 2010, the Comprehensive Land Development Task Force for Provincial Intercity Railways. The Task Force constitutes leaders from various departments of the provincial government, including the Development and Reform Commission, the Urban and Rural Planning Bureau, the Bureau of Land and Resources and the Provincial Railway Investment Co. Ltd. Integration of different departments enables the provincial government to overcome information and technical shortcomings. Regarding the vertical restructuring, the provincial government took advantage of a series of tools to rework its planning competences and financial rights, such as freezing the land development indicators around a station; redistributing the responsibility for compensation and loss; releasing additional urban construction land indicators; and retrieving land use planning rights and approval authorities (Zhang et al. 2020a, b). As a result, the provincial government takes the lead in plan making and releasing land indicators, and a joint venture development company (provincial gov. and municipal gov.) carries out land development (Lin and Yang 2015). For the land within the red line of rail transit, the provincial government bears 100% of the project cost, and municipal governments bear 100% of the land demolition cost. For the land outside the red line of rail transit, a joint venture development company bears the project cost, of which the proportion is negotiable (municipal governments' investment ratio is generally less than 50%) (Table 2.1).

Aside from rail transit construction, greenways and water networks are also main fields of province-municipality cooperation. 'Providing overall guidance by provincial government, construction by local governments' is applied as a strategy for the construction of greenway networks. Providing overall guidance includes project establishment, planning, bidding, land supply and construction permits. The

provincial government successively promulgated regulations for the construction and management of Canton greenway networks, including Guidance for the Building of Canton Regional Greenways, the Guidelines for Designation and Control of Canton Greenway Control Areas, the Planning Guidelines of Canton Urban Greenways, the Functional Development Guidelines of Canton Greenway Networks and the Public Participation Handbook of Canton Greenway Networks. They help formulate implementation rules and management systems. In terms of funding arrangements, the provincial government is responsible for plan making of greenway projects, which are mainly concentrated in economically developed areas. Municipal governments are responsible for the construction of greenway projects according to the guidance of the Planning Framework of Canton Greenway Networks. The provincial government has also established a system of ‘construction information updated bi-monthly’ for the greenway networks. In terms of cooperation mechanisms, a three-level greenway network is proposed: provincial level, municipal level and community level. Its implementation depends on the ‘provincial and municipal counterparty working mechanism’, including greenways that connect both Hong Kong and Macau, and accordingly financial/subsidies arrangements. The provincial government also carries out inspections, evaluations and assessments on the construction of the greenway networks from time to time.

Coordinated development in the PRD originates from the division and cooperation of industries between cities, while the industrial cooperation space has undergone tremendous changes and scale reconstruction in the process of coordinated development in the PRD. As China’s first special cooperation zones, Shenzhen-Shantou Special Cooperation Zone (Shenzhen-Shantou SCZ in short) was established in February 2011. This project, which was initiated by the Canton Provincial Party Committee and Canton provincial government, aims to solve the problem of Shanwei’s economic backwardness and the shortage of land indicators in Shenzhen. It belongs to a leapfrog-style cooperation zone in geographic terms and a support-type cooperation zone in management terms. The plan for the Shenzhen-Shantou SCZ met difficulties in implementation, mainly due to the lack of well-documented cooperation mechanism between cities, such as land supply mechanism, a legal and reasonable mechanism for housing development and a personnel recruitment system (Zhang et al. 2020a, b). The provincial government distributes powers to local governments through two regulations: the Management Regulations of Shenzhen-Shantou SCZ and the Regulation for Canton Annual Land Use Plan. The municipal governments have gained more power to explore the innovation of administrative organisation and cooperation mechanism. As a result, the Shenzhen-Shantou SCZ was empowered with sufficient funds and independent rights of personnel recruitment. After 2018, the Shenzhen-Shantou SCZ will be jointly built by Shanwei and Shenzhen and will be fully managed by Shenzhen. Administrative power and financial power were decentralised to local governments, which aim to realise regional cooperation and boost economic growth.



### 2.3.3 *Integrative Development at the Municipal Level*

Coordinated Development in the PRD also benefits from local-level cooperation between cities, aside from the cooperation of ministry-province and province-municipality. The Planning Framework 2008 clarified a multilevel and multi-centre spatial structure surrounding three development nodes, which are Guangzhou-Foshan, Shenzhen-Hong Kong and Zhuhai-Macau (Fig. 2.1c). These three development poles show that the cooperation between cities will inevitably become the key level of the coordinated development in the PRD. The Guangzhou-Foshan integrative development is undoubtedly elevated to a national strategy.

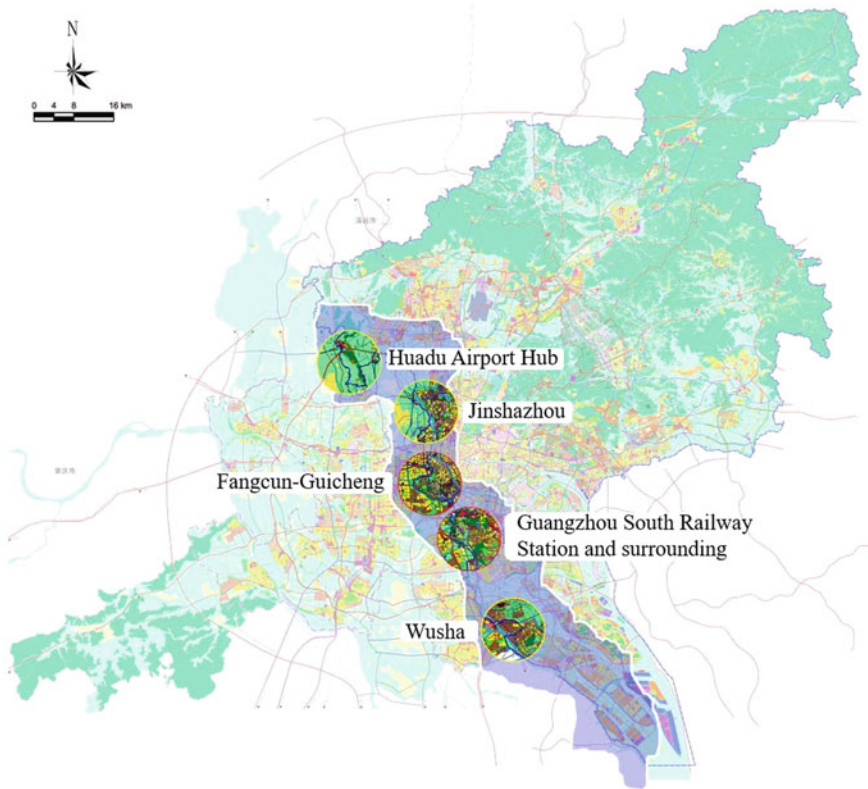
Guangzhou-Foshan integrative development is driven by the central government, and in fact also depends on the efforts of the local governments. As early as 2003 municipal governments of these two cities organised a symposium on 'Guangzhou-Foshan Regional Cooperation and Coordinated Development', and then conducted planning research aiming at promoting integrative development. The research developed into the Research on the Coordinated Planning of the Guangzhou-Foshan Metropolitan Area, the Coordinated Development Plan in the PRD, the Guangzhou-Foshan Road System Connection Plan and the Guangzhou-Foshan Inter-city Regional Transportation Integration Plan.

Based on the top-down thrust and bottom-up assistance, Guangzhou and Foshan formulated the Guangzhou-Foshan Integrative Development Plan (2009–2020) and four sectoral plans for urban planning, transportation, industry and environmental protection. The Guangzhou-Foshan Integrative Development Plan clarifies five joint development areas, including Wusha, Guangzhou South Railway Station and its surroundings, Fangcun-Guicheng, Jinshazhou and Huadu Airport Hub (Fig. 2.4); and integrated the related planning of each.

A list of projects for the integrative development is shown in the plan (Canton Provincial Government, 2008). Wei et al. (2016) tracked the implementation progress and found that the majority of infrastructure and transportation facilities in the two places were fulfilled, and environmental protection projects made certain progress. In 2015, medical insurance of the two cities was networked.

Although the development of Guangzhou and Foshan has become a model of integrative development across the country, they encountered many obstacles in the process. Their administrative structures are quite different. Since 1998, Guangzhou has followed a four-level administrative structure, city-district-street (town)-neighbourhood (village) committee, which is of top-down character. Guangzhou municipal government has the power to make decisions on major projects, although it has claimed that it is actively delegating powers. Foshan's administrative structure is relatively flat and of a bottom-up nature. Several economically developed counties (Shunde, Nanhai, Gaoming and Sanshui) have always retained authority over their own economic development, which is attributed to the policy of strengthening county power.

So it was difficult for the two cities to reach an agreement on implementing integrative development projects due to a mismatch of the governance hierarchy in the



**Fig. 2.4** Joint development areas of Foshan-Guangzhou. *Source* Guangzhou-Foshan Integrative Development Plan 2009–2020 (2009)

first few years (2003–2008). In Foshan, district and town governments have the power to initiate new projects, which are usually not in accordance with of interests from Guangzhou. Guangzhou municipal government holds the leadership for important projects. Later, these two cities established the Coordination Mechanism of Joint Mayors Meeting and formed an interactive platform for communication between different administrative levels. This mechanism is higher than the level of the two municipal governments. When mayors and secretaries of the two cities (a group of four) reached consensus on general strategy of integrative development through the ‘joint meeting’, the strategy will be translated into plans and policies in domains of finance, information, industry, transportation, environment and urban planning. A task force of ministers of the above-mentioned sectors is then responsible for implementing the plans and policies (Fig. 2.5).

Guangzhou-Foshan integrative development is not entirely driven by the Planning Framework (2008) or the Guangzhou-Foshan Integrative Development Plan (2009–2020). The preparation process of the Guangzhou-Foshan Integrative Development Plan is also a process in which different stakeholders express their interests and seek

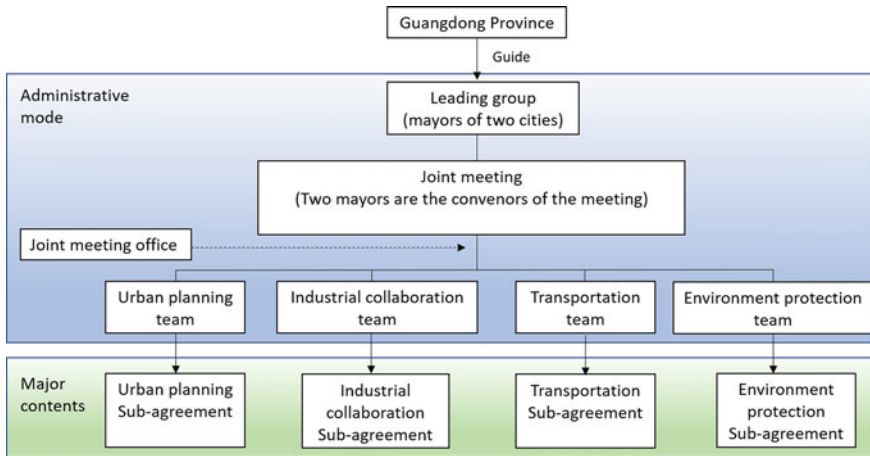


Fig. 2.5 Governance framework of Guangzhou-Foshan co-urbanization

consensus. The Joint Mayors Meeting and a series of planning research organised since 2003 have been ways to reach consensus. In addition, the integrative development cannot be achieved by municipal levels at a single level, but cooperation among different levels of governments; for instance, Canton provincial government and the central government played key roles of facilitating the West River water diversion project between the two cities (Wei et al. 2019).

### 2.3.4 Coordination at the Town/District Level

Guangzhou and Foshan signed the Memorandum on Joint Construction of Guangzhou-Foshan High-Quality Development and Integration Pilot Zone (Memorandum 2019 in short) in May 2019, under the impetus of the Planning Framework 2019. Five development poles are identified along the 197-km border of Guangzhou-Foshan: the area surrounding Guangzhounan South Railway Station, Huadu-Sanshui, Baiyun-Lishui, Liwan-Guicheng and Nansha-Daliang Ronggui. Integrative development of the two cities became more specific and could be implemented at the town and district levels.

Districts and towns have also sought opportunities for coordination based on the Memorandum 2019. As an old district in Guangzhou, Liwan District encountered a series of problems, such as insufficient public facilities, sanitation issues, low-end industry and so on. Nanhai District of Foshan, located on the edge of the two cities, developed well in the 1990s. However, its development lagged after Huangqi and Yanbu were merged into Dali Town (2005). They did not receive sufficient investment and planning; industries became low-end; infrastructure was lacking; the environment became further damaged. Facing similar development bottlenecks, the

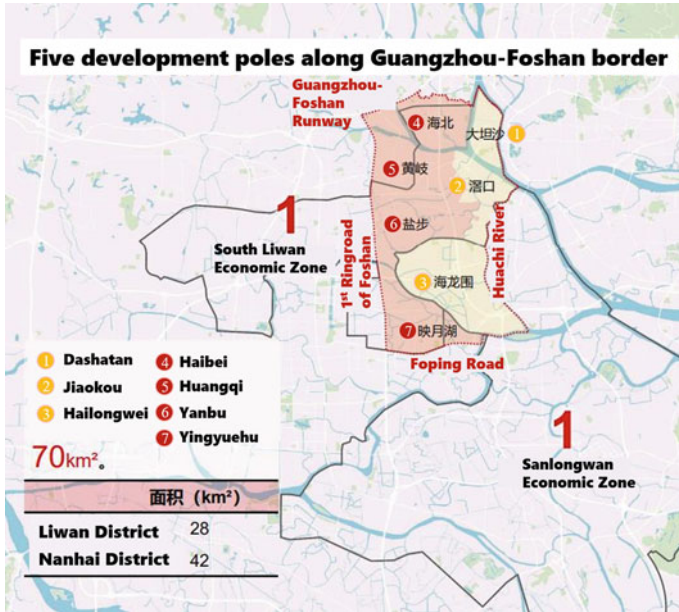


Fig. 2.6 Schematic diagram of the planning scope of Guangzhou-Foshan New Town. Source [https://www.sohu.com/a/421456188\\_689966](https://www.sohu.com/a/421456188_689966)

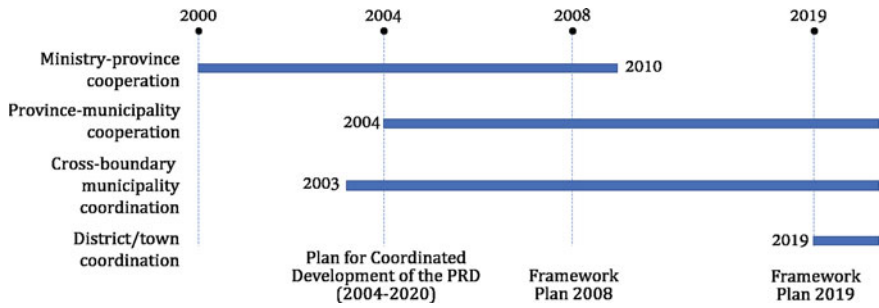
two districts have common needs for a better platform for industrial redevelopment, to help restore the environment and to improve services.

In September 2020, the Liwan District of Guangzhou and the Nanhai District of Foshan jointly held a symposium on establishing an innovative new town and signed a memorandum. The new town is called Guangzhou-Foshan New Town Technology Innovation and Intelligence Valley. It occupies area of 70 km<sup>2</sup> (42 km<sup>2</sup> in Foshan and 28 km<sup>2</sup> in Guangzhou) and accommodates a million people (Fig. 2.6).

So far, Guangzhou and Foshan have gradually extended their coordination/integration from municipality level to district/town and street level. The carrier of coordinated development has also moved from a series of projects to economic cooperation zones/new towns. Areas of coordination have been extended from transportation/municipal infrastructure to industry development, public service, daily life and many other aspects.

## 2.4 Discussion and Conclusion

Coordinated development in the PRD is inevitable under the background of new regionalism. Regional planning is an important tool to promote regional coordinated development. As a formal platform for cooperation, regional planning needs



**Fig. 2.7** Different modes of regional governance: ministry-province cooperation, province-municipality cooperation and cross-boundary municipality coordination to district/town coordination

consensus in the early stage, and then to be supplemented with incentive mechanisms in the later stage to ensure the progress of regional coordinated development. But regional plans in the 1990s were not well implemented, mainly because consensus was not reached.

In the absence of a formal regional government, regional governance in the PRD has gradually extended from ministry-province cooperation, province-municipality cooperation and cross-boundary municipality coordination to district/town coordination. Different levels have their areas of expertise in coordination (Fig. 2.7). In the initial stage of coordinated development in the PRD, the central government played a crucial role in finance and policy terms, and the cooperation between ministries and provinces became the main mode of cooperation. Construction of regional transportation infrastructure such as intercity rails are leading projects.

The Ministry of Railways gradually ceased cooperation with the provincial government around 2010. Ministry-province cooperation moved to province-municipality cooperation. The role of the provincial government evolved from a traditional subcontractor and coordinator to a major participant in the development process. At the province-municipality level, infrastructure for people’s livelihood such as cross-boundary subways, Pearl River drinking water projects, power stations and greenway construction were leading projects. The relationship between provinces and cities has undergone a rough patch in the past 17 years. The provincial government adjusted its relationship with the municipal government through administrative recruitment and land quotas. As a result, some powers were decentralised to municipal governments. The role of municipal governments has changed from a relatively independent competitor to a cooperative regional actor. Province-municipality cooperation is also the broadest and deepest level of cooperation.

Integrative development at the municipal level happens simultaneously. At this level, infrastructure construction, such as regional transportation facilities and municipal facilities, industrial integration zones, ecological space renovation and public services, is still the focal areas for cooperation. However, there is a heterogeneity in the degree of economic development and administrative structures of various cities.

Under the current system, it is not realistic to push a project only at the municipal level. Thus, regional governance and coordinated development often require the joint participation of multiple levels of entities. Implementation of either construction of the Guangzhou-Foshan Metro or the development of Shenzhen-Shantou Cooperation Zone depends on the impetus of high-level administrative departments (i.e. the Ministry of Railways, the Provincial Party Committee and the provincial government).

The cooperation at district/towns level started in 2019. This level of collaboration is based on economic cooperation zones and cross-boundary projects. It also requires the assistance and support of higher-level administrative departments. In short, the regional coordinated development in the PRD relies on the integration of different levels including ministry-province cooperation, province-municipality cooperation, integrative development at the municipal level and coordination at the district/town level. Each level of coordination has its area of expertise. Thus, a set of conventional cooperation mechanisms and ‘incentive-regulatory’ means need to be established; common interests need to be reached; roles of government at all levels have to be adjusted in the cooperation process.

## References

- Canton Provincial Construction Commission (1996) Plan for urban agglomeration of the Pearl River Delta. China Construction Industry Press, Beijing
- Canton Provincial Government (2008) Planning framework for reform and development of the Pearl River Delta (2008–2020). Canton Provincial Government Printing Office, Guangzhou
- China Central and State Council (2019) Planning framework for the development of the Guangdong-Hong Kong-Macao Greater Bay Area (2019–2035). China Central and State Council Printing Office, Beijing
- Editorial Board of Plan for Coordinated Development of the Pearl River Delta (2007) Plan for coordinated development of the Pearl River Delta (2004–2020). China Construction Industry Press, Beijing
- Hall P, Jones M (2002) Urban and regional planning. Routledge, London/New York
- Huang Y (2020) Beyond boundaries: Spatial evolution and governance mechanism of cross-boundary regions in rescaling: research on Guangdong-Hong Kong-Macao Greater Bay Area. *Urban Rural Plan* 1:9–19
- Lin X, Yang J (2015) Multi-level governance and inter-city spatial planning under the context of new regionalism: drawing lessons from the Pearl River Delta. *Chin Public Policy Rev* 1(1):131–149
- Pang Q (2019) The strategy research of urban agglomeration spatial collaboration on the Greater Bay Area: based on the interaction between Zhuhai and Hong Kong-Zhuhai-Macao Bay Area. *Urban Dev Stud* 26(7):50–58
- Wei Z, Chen T, Liu Y (2019) Coordinative Development Model of Cross-boundary Areas in Guangdong-Hong Kong-Macao Greater Bay Area – A case study of Guangzhou-Foshan. *Urban Rural Plan*. 43(01):31–38
- Wei Z, Chen T, Li X, Xie S (2016) Research on cross-border regional cooperation model from the perspective of multi-level governance: A case study of Guangzhou and Foshan. *Sci Geogr Sin*. 36(09):1418–1425
- Zhang X, Luan X, Li Z (2020a) The restructuring of regional governance under the city regionalism of China: a case study of the Pearl River Delta intercity railway. *Geogr Res* 39(3):483–494

Zhang X, Yang Y, Shan X, Lin X, Niu F (2020b) Rescaling of global city-regional governance in the Pearl River Delta: a comparative study on industrial project and transportation infrastructure project. *Geogr Res* 39(9):2095–2108

**Open Access** This chapter is licensed under the terms of the Creative Commons Attribution-NonCommercial 4.0 International License (<http://creativecommons.org/licenses/by-nc/4.0/>), which permits any noncommercial use, sharing, adaptation, distribution and reproduction in any medium or format, as long as you give appropriate credit to the original author(s) and the source, provide a link to the Creative Commons license and indicate if changes were made.

The images or other third party material in this chapter are included in the chapter's Creative Commons license, unless indicated otherwise in a credit line to the material. If material is not included in the chapter's Creative Commons license and your intended use is not permitted by statutory regulation or exceeds the permitted use, you will need to obtain permission directly from the copyright holder.



# Chapter 3

## Spatial Dynamics in the Pearl River Delta and Development Strategies



Dai Wei, Han Meyer, and Taneha Kuzniecowa Bacchin

**Abstract** The transformation of Pearl River Delta (PRD) is characterized by a complex layering, spatial and temporal differentiation. Its complexity is not only caused by interactions between multiple layers like blue-green spatial structure and urban spatial structure, but also caused by the interactions of several large sub-regions that are mutually interrelated. This paper aims to characterise the spatial structure and its evolution as a basis for the development of spatial strategies for future development. In this research, the combination of multiple spatial-temporal approaches and multiple layer approaches for its spatial structure analysis is employed. Firstly, after mapping the evolution process of the PRD, several important sub-regions are analysed. Secondly, evolution mechanism and driving forces are studied in detail. Thirdly, main existing problems are exposed and the causes of these problems are analysed. Finally, several possible strategies for future land-use schemes of PRD are outlined. It is proposed that the land use of future PRD regions should be divided into three spatial zones and four categories of land use. The goals and measures of development for each land-use category are highlighted in order to make contributions to future planning and design.

**Keywords** Spatial structure · Pearl River Delta · Evolution mechanism · Correlation; Spatial development strategy

---

D. Wei (✉)

School of Spatial Planning and Design, Hangzhou City University, Gongshu, 51 Huzhou Road, Hangzhou 310015, Zhejiang, China  
e-mail: [daiwei910325@126.com](mailto:daiwei910325@126.com)

H. Meyer · T. K. Bacchin

Faculty of Architecture and the Built Environment, Delft University of Technology, Julianalaan 134, 2628 BL Delft, The Netherlands  
e-mail: [V.J.Meyer@tudelft.nl](mailto:V.J.Meyer@tudelft.nl)

© The Author(s) 2023

S. Nijhuis et al. (eds.), *Adaptive Urban Transformation*, The Urban Book Series,  
[https://doi.org/10.1007/978-3-030-89828-1\\_3](https://doi.org/10.1007/978-3-030-89828-1_3)



### 3.1 Introduction

Spatial structure research has been applied to regional and urban areas by geographers since the nineteenth century. It aims to explore the influence of social, economic, ecological and other attributes on the distribution of spatial structure and is the basis of regional and urban planning (Wang 2018). The analysis of the spatial structure is helpful in discovering the problems of previous planning and design, and to explore the improvement methods of different spatial elements.

The research of spatial structure has experienced the development process from spatial aesthetics, socio-economic ecology and complex spatial networks. The research methods have gradually shifted from static analysis to dynamic analysis, and then to multidimensional spatial-temporal analysis. The study of classical spatial structure takes spatial aesthetics as the core and uses geometric composition rules to guide the process of spatial planning and design (Portugali and Egbert 2016). After the industrial revolution, the spatial structure gradually became relative to the social, economic, ecological and other multidimensional values (Wang et al. 2018). Since the end of the twentieth century, with the progress of global networking, the research of spatial structure to deal with the global social and economic crisis and global climate change has been increasing (Castells 1989). Hot topics such as mobility models and resilience frequently appear in international forums. Looking at the above, although the focus and conclusions of the research on spatial structure is different at different stages, they all rely on the coupling basis of the structured system in the multiple dimensions of element, time and location.

The spatial dynamics of the PRD are the result of the action and interaction of different spatial layers that together form a complex system. The lower basement formed by the erosion and deposition of rivers and oceans and the superstructure formed by the collection and distribution of industries and cities makes it more complex than the general spatial structure system and have more diverse evolution characteristics. For this reason, the issue of the spatial structure of the PRD has triggered a large number of scholars to research, and their understanding of its evolutionary identification and development strategies is also different (Lai et al. 2015; Zhang 2013; Ye 2006; Li and Fu 2014; Li et al. 2005). The formation of the spatial structure of the PRD is not only the result of the mutual feedback of the blue-green spatial structure and the urban spatial structure, but also the result of the interaction of the interconnected, interdependent and mutually coupled large areas. It has the characteristics of time-period dynamics, element stratification and location differentiation. This paper combines the two methods of horizontal division and layer approaches in spatial structure analysis. Through the overlay of different spatial elements, the evolution process and characteristics of the urban spatial structure and the blue-green spatial structure of the whole PRD region, the west upstream sub-region, the west downside sub-region, the east sub-region and the geometric central sub-region are analysed in detail. It studies the evolution mechanism and the driving force behind it, expounds the existing problems of the current spatial structure and puts forward several ideas for the future land-use scheme of the PRD.

## 3.2 Materials and Methods

### 3.2.1 Research Scope

The research scope of this paper is the narrow PRD region around the Pearl River estuary, including the main areas of Guangzhou city, Shenzhen city, Zhuhai city, Foshan city, Dongguan city, Zhongshan city, Hong Kong and Macau, as well as parts of Huizhou city and Zhaoqing city. The whole area is surrounded by hilly terrain in the north, east and west side, and the South China Sea on the south side. The hinterland of the whole region is rich of its water systems. There are 102 main rivers and waterways with a total length of about 1700 km. There are eight estuaries including the Ya estuary, the Hutiao estuary, the Jichao estuary, the Modao estuary, the Heng estuary, the Hongqi estuary, the Jiao estuary and the Hu estuary at the boundary of land and sea. The annual rainfall is 1600–2000 mm, the annual average temperature is 21.9 °C and the terrain slope is 0.1‰–0.2‰.

### 3.2.2 Research Methods and Data Sources

Based on the layer approach, the PRD region can regard its spatial structure as a ‘multilayer structure’ based on the attributes of its elements. The first layer is the blue-green spatial structure, which is composed of rivers, reservoirs, wetlands, woodlands, gardens, grasslands, oceans, agricultural and fishery land, etc. (Meyer et al. 2015). It is the continuity ecological background which provides the underlying foundation. The second layer is the urban spatial structure, which is composed of the transportation network, residential land, industrial land, commercial land and reserved land for building. It is the lifeblood of social and economic development. Based on a horizontal division, the PRD can regard its spatial structure as a ‘multi-area structure’ according to its azimuth characteristics (Dai et al. 2017). The first area is composed of Guangzhou city, Foshan city, Zhaoqing city and surrounding areas, which is located in the upper reaches of the west bank. The second area is composed of Zhongshan city, Zhuhai city, Macau, Jiangmen city and surrounding areas, which is located in the middle and lower reaches of the west bank. The third area is composed of Shenzhen city, Dongguan city, Huizhou city, Hong Kong and surrounding areas, which is located on the east bank. The fourth area is composed of Nansha district, the Pearl River Estuary area and surrounding areas, which is located in the central area.

At the same time, spatial samples were collected with the time sampling points of 1980, 1995, 2005 and 2018. In terms of data, the corresponding spatial structure data comes from Landsat remote sensing imagery, Google Earth digital images, Baidu digital images, OpenStreetMap digital images, statistical yearbook (Guangdong Province Bureau of Statistics 2019), official planning and design data (Guangdong Institute of Urban and Rural Planning and Design 1994, 2004, 2008, 2015) and

international journals (Xiong and Nijhuis 2019; Wu et al. 2018; Liu et al. 2015; Gao et al. 2008; Zhao et al. 2017; Li et al. 2018), master and doctoral dissertations, etc. (Chen 2015; Cen 2014). In the study of this paper, the urban spatial structure includes residential land, industrial land, commercial land and reserved land for building. Blue spatial structures include rivers, reservoirs, paddy fields and oceans. Green spatial structures include forest land, garden land, grassland and wetlands.

### **3.3 Spatial Structure of the PRD Region and Its Evolution**

#### ***3.3.1 Spatial Structure of the Whole Region***

The blue-green spatial structure of the whole region was shaped by the geological faults and magma invasion that occurred during the Yanshan Movement (Lai et al. 2015). Controlled by erosion and siltation, the four basic ecological corridors—West River, North River, East River and Pearl Rivers—have gradually taken shape, providing the main ecological functions for the whole region. The marine spatial structure differs between the east and west banks of the Pearl River Estuary. The west bank is formed by delta tidal dynamics, and its section can be divided into west beach, west channel, middle beach, east channel and east beach from west to east. The east bank is formed by the accumulation of sediment and the sea tide advances and retreats, and its spatial structure is simpler than that of the west bank.

After urban development, the urban spatial structure of the whole region has formed a spatial pattern of ‘three zones and four axes’ (Li et al. 2018). The ‘Three Pieces’ refer to the three major urban clusters centred on ‘Guangzhou-Foshan-Zhaoqing’ metropolitan, ‘Shenzhen-Dongguan-Huizhou’ metropolitan and ‘Zhuhai-Zhongshan-Jiangmen’ metropolitan areas. ‘Four axes’ refer to the east development axis with Guangzhou-Shenzhen Expressway and Guangzhou-Shenzhen Coastal Expressway, and west axis with the Pearl River Delta Ring Express, Xintai Expressway, Guangzhou-Zhuhai Expressway, Guangao Expressway, and north axis of Pearl River Delta Ring, Guangzhou-Foshan-Zhaoqing Expressway, and Guanghui Expressway, and south axis of Western Coastal Expressway, Guangdong-Hong Kong-Macao Bridge, Shenzhen-Huizhou Binhai Expressway and Shenzhong Tunnel. Large-scale public service facilities are mainly concentrated in Guangzhou city and Shenzhen city.

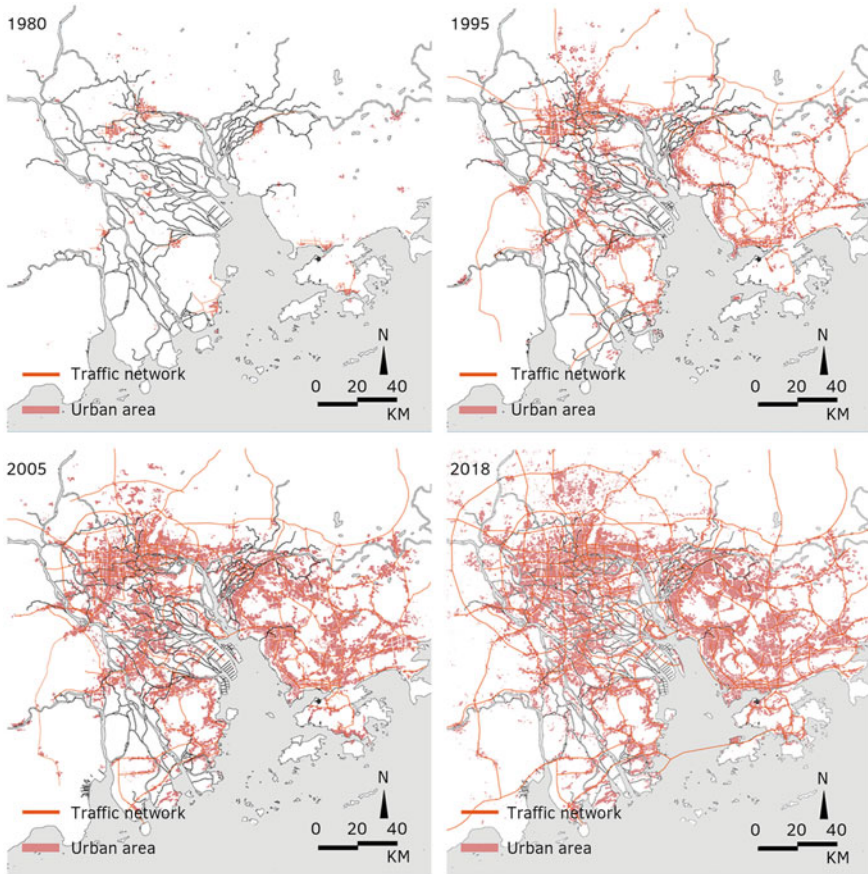
#### ***3.3.2 Evolution of the Spatial Structure***

Since the reform and opening up in 1978, policies, industries and transportation have greatly changed the evolution process of the spatial structure of the whole region (Gao et al. 2008). In the early period of reform and opening up (1980–1995), the whole

region took advantage of its geographical position and fully absorbed the capital and technology of Hong Kong and Macau. The rapid development of township enterprises, export-oriented processing industries and special economic zones has led to the rise of a number of small and medium-sized cities. In the middle period of reform and opening up (1995–2005), the whole region entered into a stage of rapid urbanisation, with the rapid changing of the industrial structure (Zhao et al. 2017). The phenomenon of export-oriented process of manufacturing industry, increased investment in infrastructure and overall improvement in the indicators of the secondary and tertiary industries have greatly promoted the process of urbanisation. After 2005, driven by factors such as moderate industrialisation, high technology, transportation network and urban spatial integration, the level of urbanisation has shown both quantitative growth and quality improvement. During this period, changes of the spatial structure of the whole region developed from the hinterland to the coast, which promotes the formation of the cross-sea pattern.

The urban spatial structure has undergone an evolution process from ‘point axis’ to ‘network extension’ (Liu et al. 2015). The gravity of development of the whole region shifts from the west to the east bank (Fig. 3.1). The ‘Guangzhou-Foshan’ urban circle and the ‘Shenzhen-Dongguan-Huizhou’ urban circle constitute the urban development framework. After the reform and opening up, the whole region has shifted from the ‘mulberry fishpond’-oriented agricultural production model to manufacturing production model. The whole region takes Guangzhou city, Shenzhen city and Zhuhai city as the regional centre, driving the development of important nodes and forming many growth points.

The blue-green spatial structure has undergone an evolution process of the separation of ‘inner circle’ and ‘outer circle’. The blue-green spatial structure has changed from the ‘interdependence’ before the reform and opening up to the ‘relative restraint’ after that period (Fig. 3.2). Before the reform and opening up, the outer blue-green spatial structure provided stable water sources and fertile land, rivers, farmland and green space for the development of the inner blue-green spatial structure and the newly developed city. Four main rivers have also become the basic framework that guides the blue-green spatial structure for an organic whole. After the reform and opening up, with the development of the urban area, the blue-green spatial structure of the inner and outer circles began to separate gradually, and the large blue-green patches connecting the inner and outer circles gradually became less. In recent years, the imbalance of the natural order within the blue-green spatial structure of the inner circle has aroused people’s reflection, and they have begun to pay attention to the restoration of local scales.



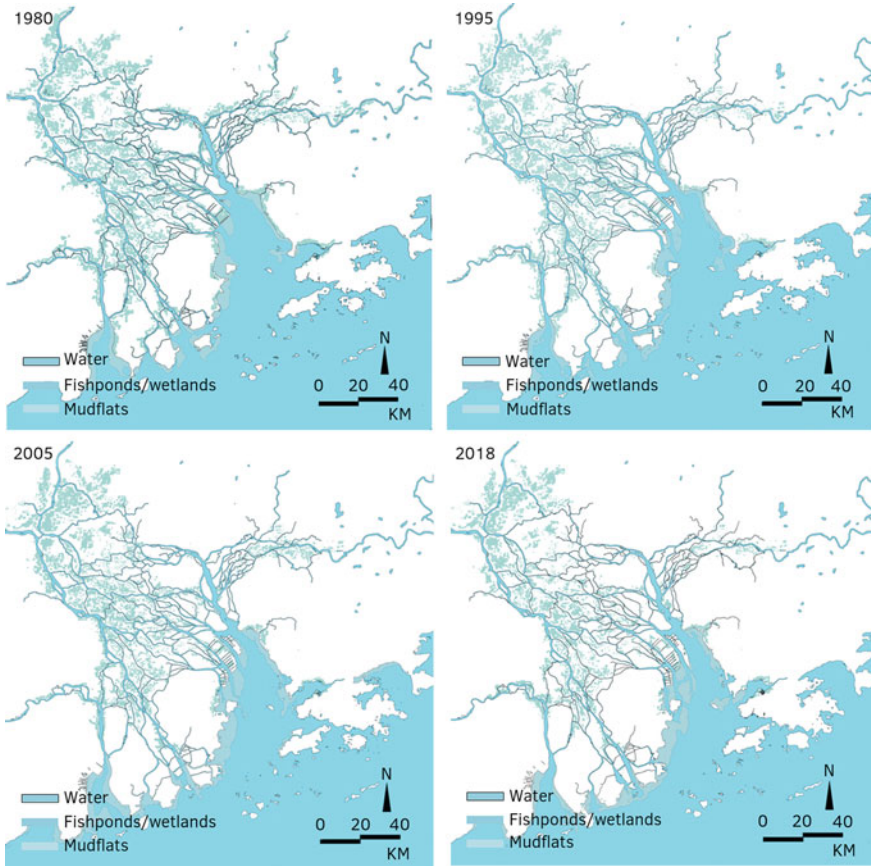
**Fig. 3.1** Development of the urban structure in the PRD. *Image* Dai Wei

### ***3.3.3 The Evolution of the Spatial Structure of the Sub-regions***

Due to the differences in the history, resources, environment and other factors of the spatial structure, the starting point, path and results of development of each sub-region are different. Therefore, the spatial evolutions of different sub-regions in the whole region are also quite different.

#### **3.3.3.1 West Upstream Sub-region**

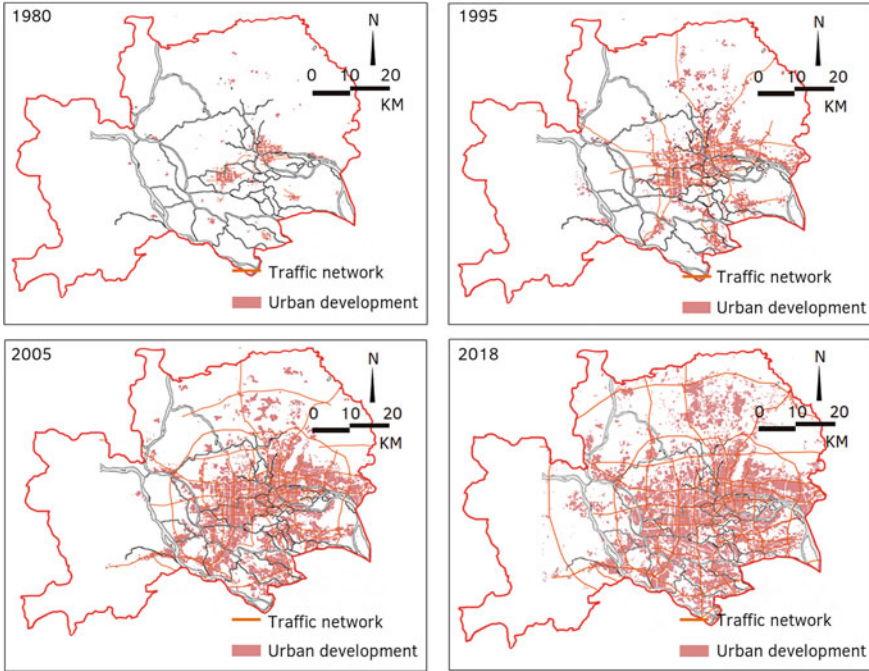
The west upstream sub-region has the best terrain and good infrastructure (Fig. 3.3). The formation of the delta in this sub-region is the earliest, with high terrain, flat



**Fig. 3.2** Development of the blue-green spatial structure. *Image Dai Wei*

terrain, large soil porosity and good water permeability. These characteristics are conducive to the development of the city by the form of concentric circles. At the same time, Guangzhou city, Foshan city and Zhaoqing city are all historical cities. Many satellite towns have been formed in the long-term development history. They have a solid historical background and have the ability to develop rapidly in terms of population conditions, industries and infrastructure. The main features of the urban spatial structure in this sub-region are the ‘circle spread’ and the ‘cross radiation network’.

From the perspective of the blue-green network structure, the natural environment in the sub-region has less restriction on urban development (Fig. 3.4). In Nanhai, Shunde, Panyu and other districts, orchards, green spaces, ecological bases, etc., have all been reduced in large areas. Affected by the expansion of the construction scope, they have shown a trend of irregular transformation. Due to the impact of regional projects such as riverbed sand mining and dam construction, the diversion

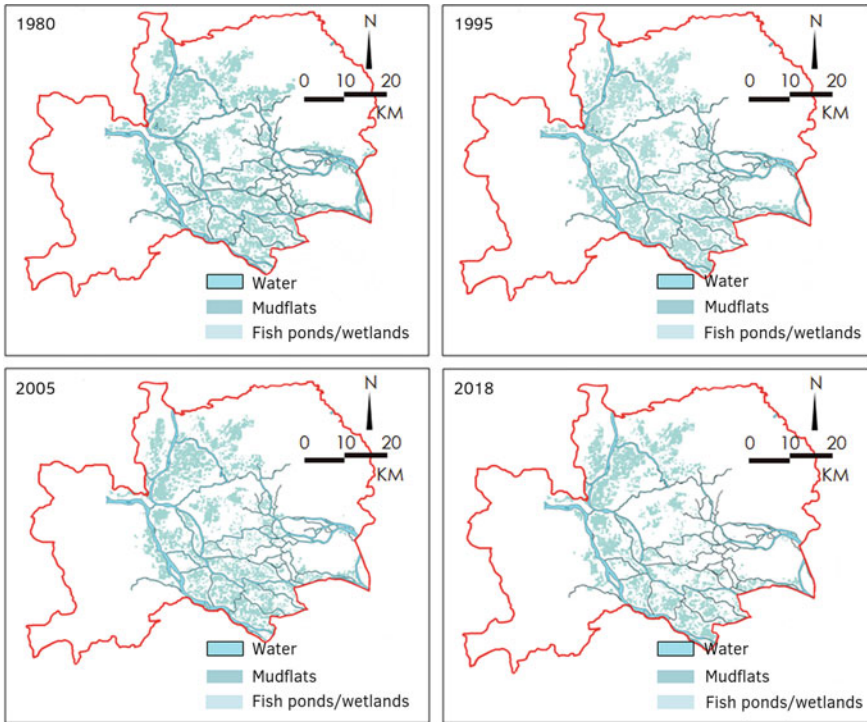


**Fig. 3.3** Evolution of urban spatial structure in the west upstream sub-region. *Image Dai Wei*

and sand distribution ratios in the upper reaches of the North River and the West River have changed, further increasing the risk of regional soil erosion. From Baiyun Mountain, Maofeng Mountain, Danan Mountain and other western mountains to the Pearl River and North River, the original large-scale ecological hydrological corridors are all fragmented.

### 3.3.3.2 West Downstream Sub-region

The rate of urban expansion in the west downstream sub-region has always been lower than that of the other sub-regions (Fig. 3.5). As Zhuhai city’s leading industries have undergone many changes in commerce, tourism, real estate and industry, though their development momentum has not been strong in some periods. In Zhongshan city, Foshan city, Dongguan city and other cities, although township and village enterprises have developed rapidly, the urban spatial structure mainly revolves around the construction of industrial plants. Zhongshan city and Zhuhai city are guided by the bottom-up development model of township industries, and a large number of clustered and dispersed forms based on specialised towns have been formed. Because this kind of form is not guided by the main axis, the development pattern is often random. The urban spatial structure of this area is generally ‘multi-point scattered’.



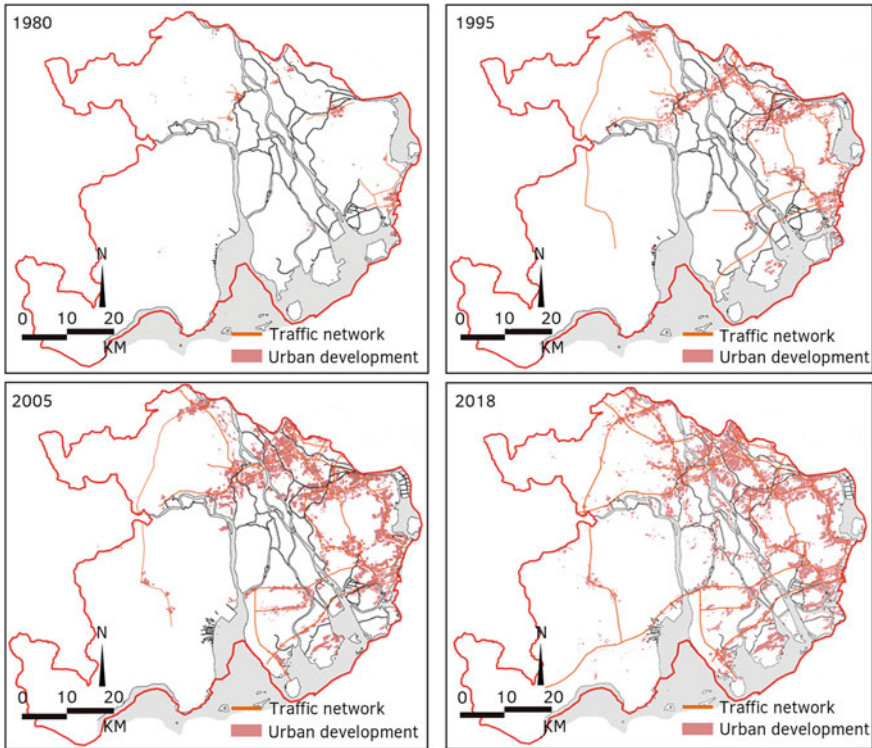
**Fig. 3.4** Evolution of the blue-green spatial structure in the west upstream sub-region. *Image* Dai Wei

Different from other sub-regions, this sub-region has many water corridors, densely tributaries and remarkable tidal currents (Fig. 3.6). Therefore, the evolution process of the blue-green spatial structure is more complicated. The urban-rural stretch area is an area where the blue-green network structure is severely broken, and the blue-green patches at the centre and the edge locations are severely broken off. The south-western coastline is reclaimed from the sea and the coastal pattern is relatively fragmented, which affects the dynamics of runoff and tidal currents and marine habitats.

### 3.3.3.3 East Sub-region

In the early stage of reform and opening up, the infrastructure of the east sub-region was weak (Fig. 3.7). Therefore, planning and regulation play an important role in the spatial development of this sub-region. The border area between Shenzhen city and Hong Kong quickly became the centre of regional development. Dongguan city has taken advantage of the radiant influence of the ‘Shenzhen-Hong Kong’ development centre. The rise of a large number of industries and manufacturing





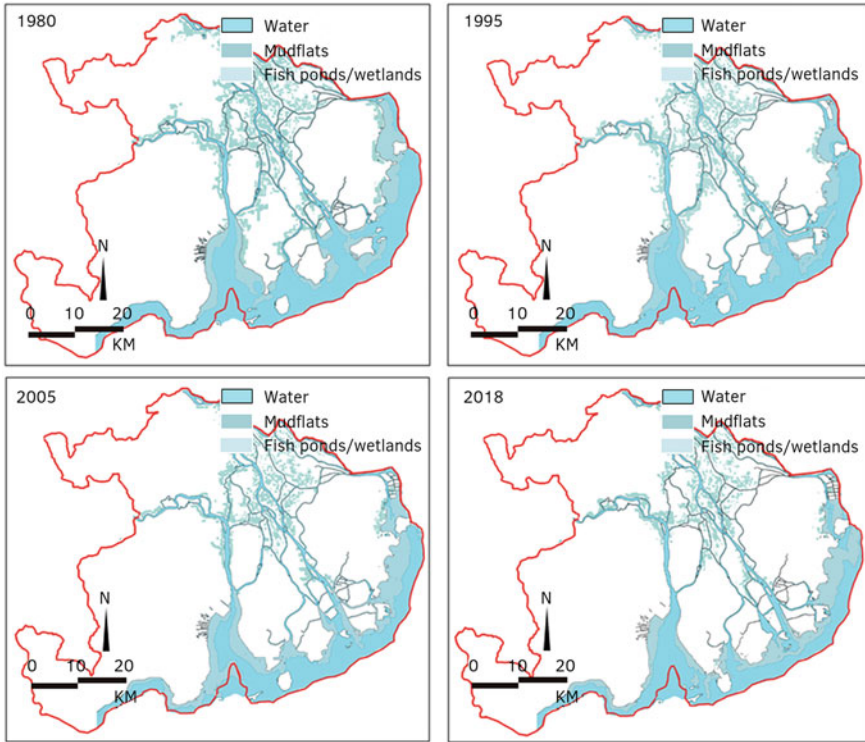
**Fig. 3.5** Evolution of urban spatial structure in the west downstream sub-region. *Image* Dai Wei

industries has caused the centre of entire region's social and economic circle to continuously shift from west to the east coast. The urban spatial structure of this sub-region is generally based on the development model of 'belt radiation' and 'spreading and filling', forming a linear finger-shaped spatial development pattern.

From the perspective of the blue-green spatial structure, the natural topographical conditions of the mountainous terrain in the sub-region have a great restrictive effect on the urban spatial development (Fig. 3.8). Compared with other sub-regions, there is a significant increase in green patches from large to small, which mainly occur in important ecological corridors such as mountain edges. At the same time, due to the excavation, dredging and reclamation, the mangroves were destroyed and the shallows expanded.

### 3.3.3.4 Centre Sub-region

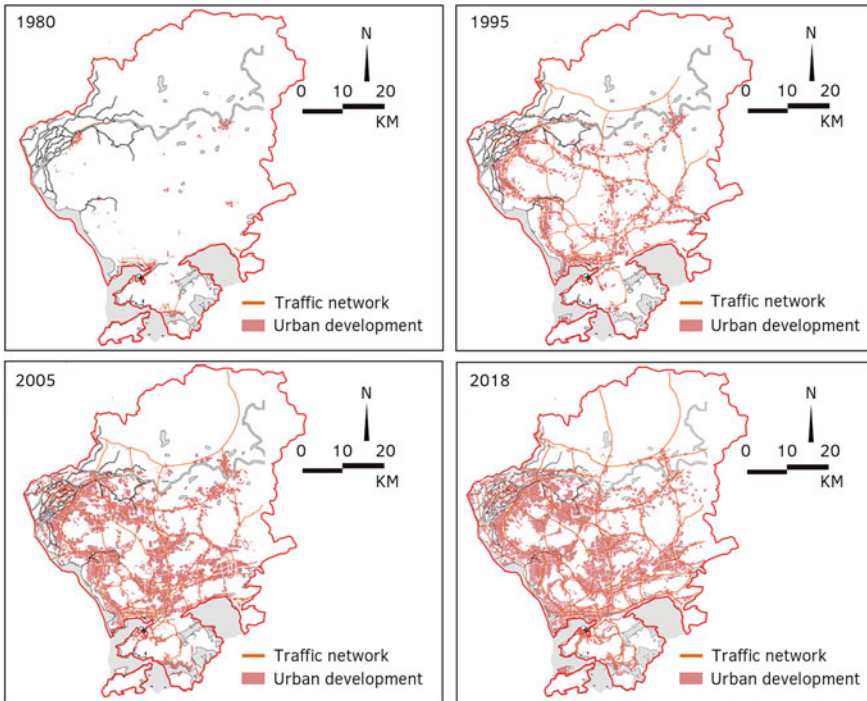
Taking advantage of the port, the geometric central sub-region determined the development orientation of key industries with the port as the core element and the marine industry as the backbone at the early stage of development (Fig. 3.9). After 2010,



**Fig. 3.6** Evolution of the blue-green spatial structure in the west downstream sub-region. *Image* Dai Wei

combined with Nansha Port and Guangzhou Metro Line 4, a sea-land-rail transportation network was formed. Since then, Nansha district has built a series of important transportation infrastructure on a large scale. The ‘staggered’ space formed by Nansha Port Expressway, Humen Bridge and other roads has become the spatial framework of Nansha district’s development.

Since most of the land in the sub-region has not yet been developed, the blue and green spatial texture of the ‘mesh-pattern’ is still reserved (Fig. 3.10). The scattered pattern of the original green space, the culture of the people living along the water and the complex and intertwined delta trail trends constitute the characteristics of the geometric centre sub-region. Due to the progress of reclamation projects on Wanqingsha Island and Longxue Island, the original blue-green spatial structure has gradually been occupied.

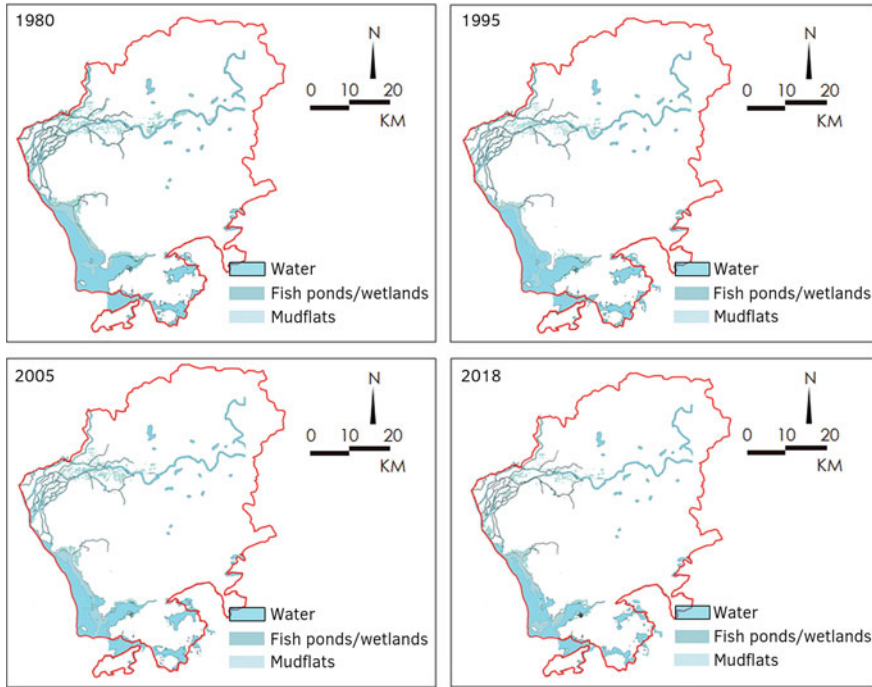


**Fig. 3.7** Evolution of the urban spatial structure in the east sub-region. *Image* Dai Wei

### 3.4 Drivers of Spatial Change

Based on the research of the evolution of spatial structure, the following three points are identified as the main drivers of spatial changes.

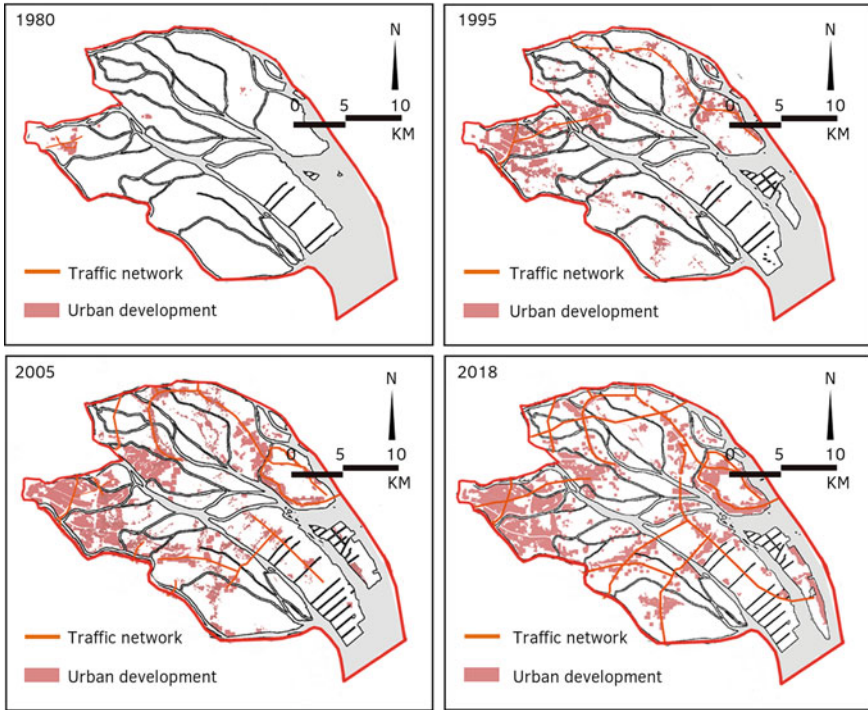
First, the polarisation and diffusion effects are the driving force for the development of space from homogenisation to heterogeneity. The combination of social and economic forces, natural conditions, industrial agglomeration and proliferation, transportation networks, infrastructure and local factors has accelerated the generation of spatial heterogeneity, which has continued to evolve from single to multiple and simple to complex. The research shows that the spontaneous dynamics of the evolution of the blue-green spatial structure of the whole region conforms to the circle layer effect of landscape evolution. Under the mutual feedback of natural order and artificial order, through the process of polarisation and diffusion, the inner and outer circles are separated from each other and the situation of ecological hydrological resources are unevenly distributed. The spontaneous driving force of the evolution of the urban spatial structure in the whole region is in line with the block effect of urban evolution. Under the mutual feedback of natural order and artificial order and through the process of polarisation and diffusion, a situation where the centre-periphery constraints are mutually restrained and the social and economic public



**Fig. 3.8** Evolution of the blue-green network structure in the east sub-region. *Image* Dai Wei

resources are unevenly distributed occurs. The overall spatial structure embodies the evolution of complex systems from a single-core model to a dual-core model, and then to a multi-core network model.

Second, geographical conditions, transportation infrastructure, industrial agglomeration and ecological hydrological resources are the engines that affect the evolution process of the spatial structure. In different historical stages and different geographical spatial locations, these geographical conditions have great differences in the displacement of spatial elements in the whole region. When the whole region enters a stage of rapid development, the role of physical geography in the evolution of spatial structure will be reduced with the construction of infrastructure such as transportation, dams and power networks. Among them, the improvement of the transportation network promotes the development of the spatial structure of the whole region from point axis to network, and breaks the original homogeneous spatial pattern, replacing it with a new form. Under the combined influence of geographical conditions and infrastructure, a belt-like extension of the spatial structure of Zhuhai city and Shenzhen city in coastal areas, a scattered extension of the spatial structure of Zhongshan city, Dongguan city and Jiangmen city in mountainous areas, and a concentric extension of the spatial structure of Guangzhou city and Foshan city in plain areas have been created. The distribution of industrial structure and ecological resources will also drive the reorganisation of the spatial structure.

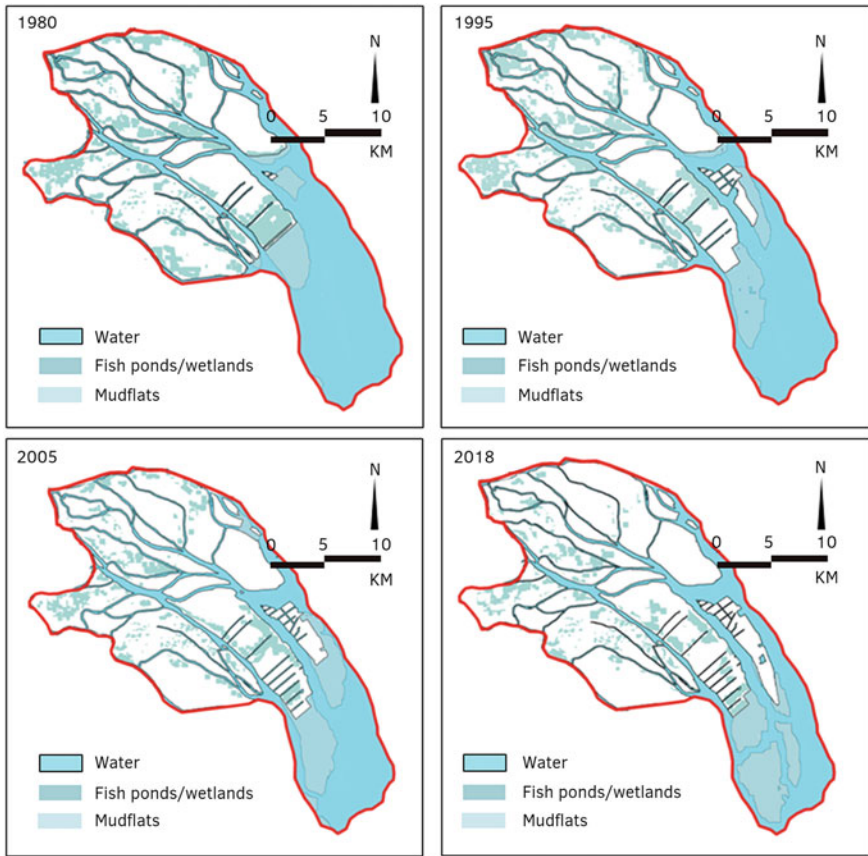


**Fig. 3.9** Evolution of the urban spatial structure in the geometric centre sub-region. *Image* Dai Wei

Third, top-down and bottom-up development models exist. In the top-down development model, the changes in the spatial structure are mainly manifested in the infill pattern formed by the centralised large-scale infrastructure and projects. Therefore, both the evolution of urban spatial structure and the blue-green spatial structure are relatively concentrated and compact. In the bottom-up development model, the location of spatial evolution is relatively loose, which objectively affects the difficulty of social-economic development and comprehensive management of the environment. Throughout the whole region, Guangzhou city, Shenzhen city and Zhuhai city belong to the core radial type. They have a concentrated and compact spatial development pattern and have strong spatial vitality. Foshan city, Dongguan city, Zhongshan city and Nansha district are part of the continuous belt-axis, which has a continuous and relatively loose cluster form.

### 3.5 Problems of Existing Spatial Structure

Based on the research results, the current spatial structure of the whole region has the following problems. First, the development of urban spatial structure is insufficient,



**Fig. 3.10** Evolution of the blue-green spatial structure of the geometric centre sub-region. *Image Dai Wei*

and there is a lack of coordination between sectors. The main manifestations are: (1) uneven distribution of traffic network. The west upstream sub-region has the highest internal traffic connection degree, and a highly integrated ‘cross’ axis topological network has been formed. The east sub-region is the second connected sub-region, with a highly integrated ‘linear’ axis topological network. The geometric centre sub-region is highly integrated, but the peripheral area often has only one main arterial road without forming a networked traffic structure. (2) There is a situation where the development of various sub-regions is not coordinated. Looking at the overall situation, most of the population and public service facilities are only distributed in Guangzhou city, Foshan city, Shenzhen city and other cities, which results in excessive pressure on the current land resources. (3) The production, life and hydro-ecological functions of the marginal areas are mixed. Due to differences in land development mechanisms and management, many specialized towns have appeared

in many fringe areas, but the spatial polarization effect is not strong, the land use is relatively extensive and the industrial layout is relatively scattered.

Second, the evolution of the blue-green spatial structure tends to deteriorate, affecting the stability of the hydro-ecological background of the whole region. The main manifestations are as follows: (1) the depth, width and length of the riverbed change. Excessive sand mining in the upstream riverbed has caused irregular changes in the depth of different sections of the river channel, changing the diversion and sand distribution ratio of important forks. The construction of large-scale dams, river-crossing bridges and wading projects reduces the effective width of the river channel and reduces the capacity of the river channel to regulate and store water. The effect of water recuperation in large-scale dam projects may cause the natural erosion and siltation characteristics of some rivers to be reversed. The wading project causes the sediment to be deposited in advance, reduces the amount of sedimentation at the entrance and increases the possibility that the water and soil structure of the entrance will be eroded by tidal dynamics. (2) The high-value wetland system in the inner circle has been changed, and the connected ecological confluence path is missing. A large number of mulberry fishponds along the line of Foshan city, Zhongshan city and Shunde city have been used as urban construction land, and high-value wetlands have been cut and split, which results in the decline of hydro-ecological functions. The structure of mangrove vegetation in the middle and lower reaches was destroyed, and the biodiversity and tide resistance of the shoreline declined. The agricultural expansion of the hills, the development and utilisation of the mountains and the compaction of the soil due to construction have changed the original flood control vegetation and soil structure of the mountains, increasing the probability of soil erosion by heavy rain, and easily causing the outbreak of mountain torrents and mudslides. (3) The nature of the estuary changed dramatically and siltation is serious. The Lingdingyang west beach was squeezed to the south-east by sedimentation, causing the axis of the west channel to move to eastward. The mudflats on both sides of Modaomen Port and Hengqin Port have been reclaimed as land, and the wide sea area has been narrowed into artificial navigation channels. The Jiti estuary to the sea was separated from the Huangmao Sea, causing serious siltation on the east side.

## **3.6 Strategies for Spatial Development**

### ***3.6.1 Construct a Unified, Integrated and Related Compound Regional Corridor***

At present, the bottleneck for the future development of the entire Pearl River Delta remains due to the problem of insufficient and uncoordinated spatial connection. The coordination and establishment of complex, three-dimensional, networked transportation and hydro-ecological corridors should be the focus, and the existing infrastructure should be optimised and used as an important support for spatial adjustment

to enhance the radiation effect from the coastline to the hinterland. A connective corridor is the foundation of global linking, and it is also the coordinated guide in the evolution of the structure and function of the region. The future development should be based on important corridors, relying on the axis of construction in different periods, such as the Western Guangzhou Expressway, the Southwest Coastal Expressway, the Northern Guanghui Expressway, the Southern Guangdong-Hong Kong-Macao Bridge and the Eastern Guangshen Coastal Expressway. By encrypting traffic network construction and public service systems in weak areas, central-peripheral point aggregation and diffusion effect can be optimised. This is necessary to help the ecological and hydrological regulation of spatial elements, such as mountains, water, sea, forests, gardens and fields, to optimise the basement pattern, to maintain existing ecological hydrological corridors, protect important rivers, foundation ponds and other high-value ecological elements and to reshape the ocean surroundings. The riverbed restoration and tidal flat reconstruction of the four main water corridors of the North River, West River, East River and Pearl Rivers should be coordinated to keep the diversion and sand distribution ratios of key bifurcations within a reasonable range.

### ***3.6.2 Coordinating Three Spatial Zones***

New land-use schemes need to consider both natural and urban spatial resources. The development of the PRD is influenced by the difference of natural resources and has formed results in three-circle spatial differentiation characteristics. Therefore, a new land-use scheme is suggested with the consideration of three-circle spatial differences. The first circle is the coastal circle. It is necessary to make full use of the advantages of sustainable ports to construct the coastal protection belt. The biodiversity, coastal protection and brackish water interaction should be well considered. The second circle is metropolitan development circle, which is located between the coastal circle and the natural protection circle in the mountainous area. This circle provides the most mutual feeding between the urban development space and the blue-green space. Land-use regulation should focus on the construction and restoration of urban internal ecological corridors and opening green space. It is necessary to conform to the blue-green spatial texture and control the urban disorderly sprawl rate. The third circle is the natural protection circle of large and high-valued reservoirs and mountainous regions, which are important for water storage and soil conservation.

The socio-economic and cultural resources in the PRD have resulted in the differentiation characteristics between urban and rural space. The ‘Guangzhou-Foshan-Zhaoqing’ metropolitan area and the ‘Shenzhen-Dongguan-Huizhou-Hong Kong’ metropolitan area have many large urban resources, well-developed infrastructures and well-developed urban functions, but they lack land resources. These areas should consider the strategy of urban-rural renovation and avoid continuous actions of urban sprawl. Attention should be paid to the construction of hydro-ecological corridors inside the city, and the implementation of the restoration of small river corridors



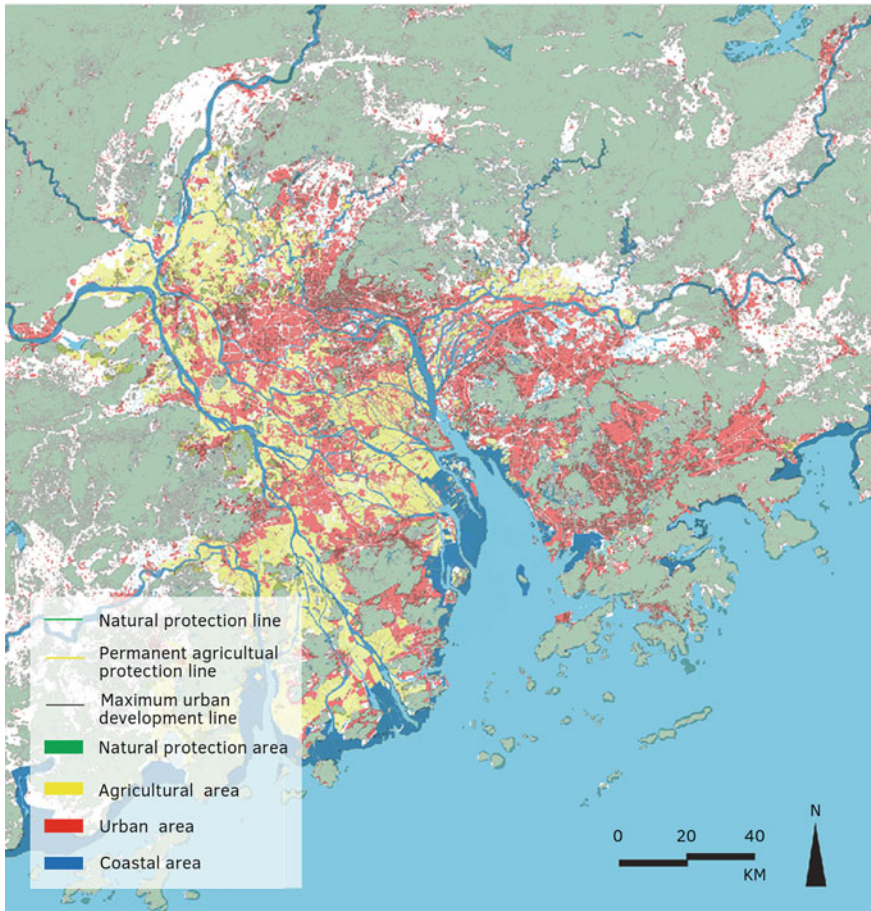
and the construction of green open space in the city. There are many current ecological hydrological corridors in the ‘Zhuhai-Zhongshan-Jiangmen’ metropolitan area, especially the West River and the North River which have many capillary corridors that can provide important regulation effects. Therefore, while increasing the service density of public facilities, it is necessary to focus on building blue-green structures with self-organisation capabilities.

### ***3.6.3 Zoning Categories for Regional Land Use***

The land-use scheme suggests dividing the land use of the whole PRD region into four categories, with different land-use strategies based on the understanding of terrain condition, land characteristics, collaborative effects between sub-deltas and long-term protection and development process. These four categories are natural protection areas, agricultural development areas, urban development areas and coastline areas (Fig. 3.11).

#### **3.6.3.1 Natural Protection Areas**

The land-use scheme suggests that natural protection areas should be concentrated along the West River and the North River, coastline, estuaries, as well as the outer circle mountains. Several measurements need to be taken for long term, natural, bottom-line operation. It is necessary to take natural geographic boundaries as research units, take large blue-green patches as the core elements and formulate corresponding construction regulation according to environmental capacity, resource carrying capacity. It is important not only to restore the natural shape of the river and green space, but also to solve the problem of disordered texture caused by urban squeezing. Natural protection areas should play their roles in ecological conservation, biological maintenance and hydrological regulation. It is wise to pay attention to nature-based solutions and advocate the conversion from dyke engineering to work with nature. It is necessary to strengthen the protection of coastal landscapes, take into account the diversion ratio of natural coastlines and artificial coastlines by controlling the length of the building that can occupy the coastline. It is important to strengthen protection measures for the eco-environmental area near the coastline and to make compensations for excessive reclamations in order to increase the capacity of the tidal storage by estuaries. As an inside natural protection area, the Pearl River Estuary is the first barrier to be protected. The land-use scheme suggests focusing on the sea-land transition environment, protecting the existing wetlands, building a coastline protection belt and promoting the biodiversity of the bay area.



**Fig. 3.11** Potential spatial development strategies for the PRD. *Image* Dai Wei

### 3.6.3.2 Agricultural Development Areas

The land-use scheme suggests that agricultural development area should be distributed in between natural protection areas and urban development areas, which cannot only function as a buffering area for further utilisation, but also provide the traditional cultural landscape of mulberry fishponds. From the evaluation results of agricultural land-use suitability, Foshan city, Dongguan city, Zhongshan city and Nansha are suitable for agricultural development. According to land-use suitability assessment, different kinds of crops should be cultivated in order to ensure food provision service for the PRD.

Specifically, the suitable agricultural areas in the west side upstream region are dominated by the current inter-city wasteland. The soil and water condition are suitable for Foshan city, Shunde and other places to strengthen the development of

fishpond agriculture and advocate for a ‘fish-mulberry’ circular agricultural economy near the fringe agricultural land of Guangzhou and Foshan towns. It is important to improve farmland infrastructure conditions and raise farmland standards. The suitable agricultural land in the west side downstream region dominates in large areas of undeveloped fishponds, which can be used as the core lands for cultivating and fishing. It is important to strengthen the protection of fishponds along the Doumen, Xinhui, Qijiang and Zhongshan city areas, and form a modern standard agricultural concentration area with concentrated splicing, completed infrastructure and valuable travelling place. The suitable agriculture land in the east region is mainly located along the East River. It is necessary to ensure that the farmlands in the basic protection areas should not be decreased for promoting the cultivation of wastelands. The suitable agriculture lands in the central region are located in Nansha and Wangqingsha. Some low-lying areas should be reserved as useful supplements to agricultural land and urban landscape in future.

### 3.6.3.3 Urban Development Areas

The land-use scheme suggests that urban development areas can be concentrated in high-valued lands along the existing large cities like Guangzhou city, Shenzhen city and Zhuhai city. It is important to properly increase the density of traffic network and provide as many types of public facilities as possible, and rely on the advantages of public services, infrastructure and facilities to increase the proportion of commercial finance, trade fairs and corresponding businesses. It is necessary to coordinate urban development areas with the natural protection areas, to scientifically insert parks and lakes to the existing urban lands in order to create attractive landscape for future residence. Based on factors such as topographical conditions and environmental capacity, it is necessary to change the development model from ‘extensive’ to ‘intensive’. For port areas, the south side of offshore areas should focus on coordinating the construction of ports and reclamation of islands. The outline of ports, as well as their related logistics layout, should be coordinated with the dynamics of sedimentation and erosion of the sea.

The suitable urban lands in the westside upstream region rely on the existing cities of Guangzhou, Foshan city and Zhaoqing city and combine with the existing road network. The suitable urban lands in the westside downstream region are centred on Wugui Mountain, along the Zhongshan–Xiaolan–Shunde axis and along the Zhuhai coastline on the eastern side of Wugui Mountain. The suitable urban lands in the east region are dominated by the corridors along the main rivers in Dongguan city and Shenzhen city, as well as on both sides of Yangtai Mountain and Yinping Mountain. In future, new construction lands should be strictly controlled due to limited land resources. The suitable urban land in the central region is mainly concentrated in the north of Nansha. Relying on the port and navigation of the Pearl River Estuary, it is important to coordinate the development of port, industry and city. The urban structure in the future should transform from scattered to networked, which can create

a modern service industry basement and an advanced manufacturing basement with inland backing.

#### 3.6.3.4 Coastline Areas

The land-use scheme suggests that coastline area should be mainly distributed at the estuaries and coastline areas in cities, which are important spaces for fluvial-tidal interactions in the PRD. Because of its specific condition, several measurements need to be taken for long-term operation. It is important to address the relationship between construction, industrial development and natural protection and pay attention to the repair and maintenance of offshore mangroves. It is furthermore important to protect marine islands and improve marine resources, reasonably control the proportion of various types of shorelines and scientifically allocate the use of productive, living and ecological water. According to the differences of water depth, deeper water can be used for production-oriented shoreline function, while the shallower water can be used for life and hydro-ecological shoreline functions.

### 3.7 Conclusion

The PRD has a particularly important strategic position and plays a decisive role in China's social and economic development. In the process of long-term spatial competition and cooperation in the past 40 years, the PRD has formed a distinct pattern caused by clusters and differentiated model. The formation of the spatial structure of the PRD is the result of the mutual feedback of the blue-green network and the urban space. It has the characteristics of time-period dynamics, element stratification and location differentiation. The interaction between social, economic and ecological development and factors, energies and information in the long-term evolution has created the development background, opportunities and challenges of the entire region. This paper gathers research results and proposes that the future spatial evolution of the PRD should first strengthen its strategic position from national scale, improving overall synergy and achieving win-win cooperation across the globe. Secondly, based on the evolution background and current conditions, composite three-dimensional regional corridors are constructed to create a circle and block global structure. Finally, it focuses on the model of three-circle spatial coordination and four categories of regional land use, namely natural protection areas, agricultural development areas, urban development areas and coastline areas. The strategy utilises key projects through composite corridors to make the entire Pearl River region prosperous.

**Acknowledgements** This research was partly funded by the NSFC, NWO and EPSRC Joint Research Project Adaptive Urban Transformation (AUT)—Territorial Governance, Spatial Strategy

and urban Landscape Dynamics in the Pearl River Delta (grant no. ALWSD 2016.013, sustainable delta programme), and also funded by the Science Foundation of Zhejiang Province, China (LQ22E080016), China Scholarship Council (No. 201606150035).

## References

- Castells M (1989) *The informational city: Information technology, economic restructuring and the urban-regional process*. Wiley-Blackwell, Oxford
- Chen D (2014) Regional spatial structure study of Pearl River Delta from 'space of flow' viewpoint. South China University of Technology
- Chen M (2015) Optimization pathway for urban metropolitan area based on ecosystem perspective: Pearl River Delta as an example. Graduate School of Chinese Academy of Social Sciences
- Dai W, Sun Y, Meyer H et al (2017) Resilient planning of delta cities under climate change. *City Plan Rev* 41(12):26–34
- Gao Y, Wu Z, Liu X et al (2008) An analysis of landscape spatial pattern in the Pearl River Delta. *Trop Geogr* 28(1):26–31
- Guangdong Institute of Urban and Rural Planning and Design (1994) 1994\_2020 Urban planning for economic zone and city cluster. Guangdong
- Guangdong Institute of Urban and Rural Planning and Design (2008) 2008\_2020 Outline of the reform. Guangdong
- Guangdong Institute of Urban and Rural Planning and Design (2015) 2015–2020 Global spatial planning of PRD. Guangdong
- Guangdong Institute of Urban and Rural Planning and Design (2004) 2004\_2020 Coordinated development planning of city cluster in PRD. Guangdong
- Guangdong Provincial Bureau of Statistics (2019) Guangdong statistical yearbook 2019. China Statistics Press
- Lai S, Yan Y, Liu G, Pang X et al (2015) A review, evaluation and reflection of the Pearl River Delta regional plan. *Urban Plan Forum* 264(4):12–19
- Li T, Fu W (2014) Inter-city comparative study of urban morphology and mechanisms in the Pearl River Delta. *Prog Geogr* 33(5):678–688
- Li H, Wang J, Peng T et al (2005) The history and trend of the urban-region in the Pearl River Delta. *Urban Plan Forum* 254(4):22–27
- Li G, Sun S, Fang C (2018) The varying driving forces of urban expansion in China: insights from a spatial-temporal analysis. *Landsc Urban Plan* 174:63–77
- Liu T, Tong D, Li G (2015) City linkage based on city functional network: taking Zhujiang River Delta as an example. *Sci Geogr Sin* 35(3):306–313
- Meyer H, Bregt A, Dammers E et al (2015) *New perspectives on urbanizing deltas*. MUST Publishers
- Portugali J, Egbert S (2016) *Complexity, cognition, urban planning and design*. Springer, Berlin
- Wang J (2018) Four generations of urban design paradigm from a rational perspective. *City Plan Rev* 42(1):9–19
- Wang Z, Chen J, Zheng W et al (2018) Dynamics of land use efficiency with ecological intercorrelation in regional development. *Landsc Urban Plan* 177:303–316
- Wu Z, Milliman JD, Zhao D et al (2018) Geomorphologic changes in the lower Pearl River Delta, 1850–2015, largely due to human activity. *Geomorphology* 314:42–54
- Xiong L, Nijhuis S (2019) Exploring spatial relationships in the Pearl River Delta: cities as spatial and social networks. Springer, pp 147–163

- Ye Y (2006) Spatial evolution mechanism of urban conglomeration: a case study of the Pearl River Delta. *City Plan Rev* 30(1):61–66
- Zhang R (2013) Zhujiang delta spatial reorganization for new urbanization development. *Planner* 29(4):27–31
- Zhao M, Derudder B, Huang J (2017) Examining the transition processes in the Pearl River Delta polycentric mega-city region through the lens of corporate networks. *Cities* 60:147–155

**Open Access** This chapter is licensed under the terms of the Creative Commons Attribution-NonCommercial 4.0 International License (<http://creativecommons.org/licenses/by-nc/4.0/>), which permits any noncommercial use, sharing, adaptation, distribution and reproduction in any medium or format, as long as you give appropriate credit to the original author(s) and the source, provide a link to the Creative Commons license and indicate if changes were made.

The images or other third party material in this chapter are included in the chapter's Creative Commons license, unless indicated otherwise in a credit line to the material. If material is not included in the chapter's Creative Commons license and your intended use is not permitted by statutory regulation or exceeds the permitted use, you will need to obtain permission directly from the copyright holder.



**Part II**  
**Spatial Strategy and Design**

# Chapter 4

## Territorial Governance and Spatial Planning in Europe: The Relevance for Flood Risk Management in the Chinese Pearl River Delta



Vincent Nadin and Meng Meng

**Abstract** China and Europe have the common problem of mitigating flood risk, a problem partly created from poor management of the urban transition now compounded by the effects of climate change on sea level and extreme weather events. Adaptation to these effects requires extensive cooperation between administrative jurisdictions and policy sectors to strengthen shared land resource management. Governments generally look to urban planning to resolve potential damaging competition between sectoral policies, but it is often not well-equipped for this task. In Europe, there has long been recognition of the need to improve territorial governance, in part through a spatial planning approach that coordinates the place-based impacts of sectoral policies and helps in the cross-fertilisation of policy making across policy silos. How can this experience inform the urban transition in the Pearl River Delta? Experience in Europe points to new institutions that are needed to reduce the costs arising from non-coordination. Spatial planning must engage a wide range of stakeholders to build trust and ownership of a shared strategy. Plans need to be adaptive in the face of great uncertainty. These prerequisites for more effective territorial governance present a huge challenge for both Chinese and European policy makers.

**Keywords** Territorial governance · Spatial planning · Cross-fertilisation · Adaptation

---

V. Nadin (✉)

Department of Urbanism, Faculty of Architecture and the Built Environment, Delft University of Technology, Julianalaan 134, 2628 BL Delft, The Netherlands  
e-mail: [v.nadin@tudelft.nl](mailto:v.nadin@tudelft.nl)

M. Meng

Department of Urban Planning, Faculty of Architecture, South China University of Technology, Tianhe, 381 Wushang Road, Guangzhou 510640, Guangdong, China  
e-mail: [mmeng@scut.edu.cn](mailto:mmeng@scut.edu.cn)

© The Author(s) 2023

S. Nijhuis et al. (eds.), *Adaptive Urban Transformation*, The Urban Book Series,  
[https://doi.org/10.1007/978-3-030-89828-1\\_4](https://doi.org/10.1007/978-3-030-89828-1_4)



## 4.1 Introduction

All countries face the challenge of managing the transformation of their territories in the face of competing demands for land use. The overwhelming trend of that transformation has been the conversion of natural open land and agricultural land to urban uses. The drivers are the demands of economic and demographic growth, fuelled by government policies that supply land for development and the infrastructure that facilitates it (Nuissl and Siedentop 2021). This pattern of land-use change is described as land consumption, or the urban transition. It is partly a product of urbanisation (the shift of people from rural to urban settlement and lifestyles) but equally significant is decreasing settlement densities driven by location preferences for more space and infrastructure provision (McGranahan and Satterthwaite 2014).

The urban transition has both positive and negative effects on sustainable development. The classical argument is that urban agglomeration, or the growth of cities, is necessary for growing a productive industrial economy, and in developed countries, to facilitate the knowledge economy. But land consumption comes with significant costs, and these can be acute where urban uses are fragmented and do not respect the value of natural environmental systems. Critical natural resources are wasted, and new environmental risks are created, including flood risk. The balance of urban and non-urban land use is crucial to the sustainability and long-term viability of cities, since ‘without natural capital the very life systems of the planet will close down’ (Helm 2016, p. 241). Natural capital includes the drainage system of rivers, estuaries and floodplains. Urban development has depleted and damaged these and other natural resources at an alarming rate, with evident consequences for the number of cities exposed to damaging floods or much increased risk.

Governments claim to manage the negative externality effects of urban development through urban planning and other land policy tools. However, there are few examples of where this has been done well. Instead, widespread damaging effects of urban development are the norm. Reasons include the overriding policy priority of economic growth, competition between landowners and municipalities, professional incompetence and corruption. And in most places, the shortcomings of a weak urban planning system also play a part, lacking the tools and political backing that can anticipate, identify and measure risks and mitigate or compensate for them. Weakness is built into urban planning because of the silo mentality of government that separates sector policies such as urban planning, economic investment, water management, agriculture and transport. Each is insulated from its wider externality effects, or to put it another way, there is little cross-fertilisation of policies and actions. This adds up to poor governance of the urban transition, and whether now or later, huge costs of non-coordination in the destruction of damaged natural capital and increased risks (Robert et al. 2001).

The costs of weak management of the urban transition, and more broadly ‘the territory’, become more visible as the loss of the natural systems that support it cross critical thresholds. Examples are the point at which clean drinking water becomes scarce, when air pollution keeps people in their homes, or where surface

water drainage and flood protection systems fail. Climate change has accelerated the path to these thresholds, especially in relation to flood risk in the face of sea level rise and extreme weather events. The World Meteorological Organisation has warned that the worst is yet to come: ‘the last time the Earth experienced a comparable concentration of CO<sub>2</sub> ... the temperature was 2–3 °C warmer, [and the] sea level was 10–20 m higher than now’ (WMO 2019). It is self-evident that the potentially catastrophic consequences of the threats of climate change partly created by poor urban development practice demand more effective governance of the urban transition. It requires extensive cooperation between administrative jurisdictions and policy sectors to strengthen shared land resource and water management. In Europe, the term ‘territorial governance’ is used to describe the coordination of all sectoral policy making and implementation that has a spatial or territorial impact, that is, it influences land-use change and the spatial distribution of activities and opportunities (ESPON 2013). Good territorial governance involves the pursuit of active convergence of the territorial impacts of sectoral policies.

More effective territorial governance is a central aim of the EU, reflected in its explicit high-level goal of ‘territorial cohesion’, the integrated development of the European territory to ensure all citizens have equal access to opportunities. Territorial cohesion can be delivered in part through a spatial planning approach that coordinates the place-based impacts of sectoral policies and helps in the cross-fertilisation of policy making across sectors. This a very difficult and long-standing challenge for both Chinese and European policy makers. Shifting to a spatial planning approach and strengthening the cross-fertilisation of policy demands reformed institutions, engagement of many stakeholders to build trust and ownership of a shared strategy and reformed tools that offer discretion in complex decision environments. The objective of this chapter is to explain how territorial governance and the spatial planning approach have evolved in Europe and to explore what relevance they have for China and particularly, flood risk management in the Pearl River Delta.

In territorial governance, the cross-fertilisation of sectoral policies is crucial. It is ‘the interaction between sectoral policy decision-makers that creates complementarity, increases efficiency through synergy and avoids the costs of non-coordination’ (Nadin et al. 2021, p. 3). Cross-fertilisation is central to the integrative and multiscale design and planning approach that is needed for the adaptive urban transformation of urbanising deltas introduced in Chap. 1.

There are strong similarities in the land and water resource management challenges in China and Europe that suggest there is potential benefit from mutual learning about how best to tackle them, despite fundamental differences in government, culture and urban geography. In China, the drive for economic growth since 1986 under a system of state capitalism has delivered an incredibly rapid urban transition, the conversion of vast swathes of open land to urban uses, alongside high urbanisation rates. Economic growth has brought prosperity and a new middle class and taken many millions out of poverty. It has also entailed huge costs, not least in the Pearl River Delta (PRD), one of the great urban agglomerations in Asia, but also one of the most vulnerable locations to increased flood risk in the context of climate change (Nicholls et al. 2007).

In Europe, there has been a similar expansion of urban land uses although over a much longer period. The major agglomerations are in north-west Europe where the industrial revolution fuelled urban growth from the eighteenth century. Although from the 1950s, there have been relatively modest rises in economic activity and shifts in population, increasing prosperity, mobility and consumer demand has continued to drive a demand for land conversion. North-west Europe's economy continues to strengthen relative to most of the rest of Europe. Thus, population and wealth generating economic activity will remain in this economic powerhouse, yet it sits on a delta that is highly vulnerable to flood risk, with sea level rises forecast to be between 0.8 m during the twenty-first century (EEA 2021).

It is not surprising therefore to see similar regional spatial strategies adopted in both North-west Europe and the Pearl River Delta, as shown in Fig. 4.1. There is thus sufficient in common to justify the objective of this chapter to outline the potential value of experiences in Europe in territorial governance for China, especially in relation to flood risk management. EU institutions have made great efforts since the 1980s to encourage more effective territorial governance that addresses competing objectives for economic growth, environmental sustainability and social cohesion, in the context of the risks of climate change. The same considerations have also come to the forefront in China. We argue here that effective territorial governance calls for a 'spatial planning approach' that facilitates cross-fertilisation of sector policies. In the next section, we explain the general meaning in Europe of the notions of territorial governance and the spatial planning approach. We then give a brief history of their evolution with reference to flood risk management and the incentives provided by the EU to stimulate more policy coordination. We end this section with a summary of the latest recommendations on the steps that European governments can take to improve cross-fertilisation. We end with a discussion of the relevance of the European experience for the Pearl River Delta, and tentatively point to three aspects that will be of particular interest in China.

## 4.2 The Challenge of Territorial Governance

Managing the territory and the urban transition is a multidimensional, multisectoral exercise. It involves all 'sectoral policies' of government. Economic investment, environment, agriculture, water management and transport are the first to come to mind, but other sectors can be equally important: social, health, education, research and development and others. The successful implementation of one sectoral policy is interdependent with others. Sometimes, these connections are obvious: the development of a new urban extension demands transport infrastructure, economic investment, housing, environmental services and the education and health facilities essential for residents. Others may be less obvious, e.g. the way that research and education investment may shape demand for housing. It may seem surprising that the interconnectedness is not always thought through in policy making, but this is the norm. It is accepted that government makes policy in sectoral silos which,



**Fig. 4.1** Strategic planning documents in Europe and the Pearl River Delta. Clockwise from top left, outline development plan for the Guangdong-Hong Kong-Macao Greater Bay Area (Chinese version and courtesy translation into English; Greater Bay Area development office, 2019); Territorial agenda 2030 (European Commission 2021a, b); A Spatial Vision for North-west Europe (NWMA 2000); and the European Spatial Development Perspective (CSD 1999) (German edition)

despite various coordinating mechanisms, often pays scant attention to other sectors. Sub-national and local governments also make policy within their jurisdictional compartments—the geographical scope of their power. Their policies will often reflect competition with their neighbouring authorities rather than complementarity. This are a long-standing barrier to effective governance of the territory (European Commission 1998). Policy making in discrete sectors has advantages, it is certainly less costly than seeking coordination, and integration with other sector policies may dilute central objectives (Peters 2018; Candel 2021). It is inevitable that the complex

task of government must be compartmentalised by sector, and within administrative boundaries. But independent sectoral policy can lead to uncoordinated implementation, contradictory actions, waste of resources and missed opportunities for synergy.

Examples of the ‘costs of non-coordination’ abound. In Europe, there are the great white elephants of infrastructure investment in air and rail facilities that are redundant or underused because of lack of attention to the wider policy environment in their planning. Other examples are more common in many countries: policies that encourage more intensive agriculture that contradict pollution reduction targets; investment in transport in infrastructure that encourages fragmented urban development lacking basic services and destroying critical natural capital; and renewable energy subsidies that undermine local food production. Of many other examples, we should mention the way that contradictory actions of different parts of government can increase flood risk. There is a long history of human intervention in water systems going back centuries, but it is from the twentieth century that technology has allowed for large-scale interventions in transport, agriculture and construction that, whilst well-intentioned, have left a legacy of huge vulnerability as evidenced in the catastrophic flood events in, e.g. Bangkok (Marks 2015) and Houston (Ersoy et al. 2023). And the damage continues; it is not unusual in the 2020s to see sectoral policies promoting investment in the most vulnerable places, putting people and capital in harm’s way, damaging natural systems and increasing flood risk.

The common threat is that the contradictions become very apparent in specific localities or places. The goals of government to reduce the risks of climate change, to husband natural resources and to share prosperity are spatial challenges—they involve interventions in particular places. Similarly, every sectoral policy has a territorial impact, whether explicitly expressed in policy or not. Whilst measures may be expressed in aspatial terms, relating, e.g. to a particular social group or activity for investment, they will affect the distribution of urban and rural development. Where such impacts and interconnections are not anticipated, the effect of the investment on a city or region can be sub-optimal or inefficient, and in the worst cases can even be counterproductive.

Why is it that there is too often insufficient attention to the spatial or territorial impacts of policy, or the contradictory effects of different sectoral policies as they combine or clash in particular places? It is undoubted that a policy silo ‘mindset’ is common in government in many countries. Governments may welcome competition between sectors, professional boundaries of interest may be rigid, and the relative power of sectors are important factors. Governments may set short-term goals and often make economic growth and ‘prosperity’ the priority, giving power to sectoral departments to implement policy and require other departments to simply facilitate the implementation of priority goals. In the countries of the EU that are lagging in prosperity, the priority to invest in infrastructure has run counter to sustainable development goals but continues in places because the power of infrastructure investment departments has grown with the receipt of EU regional policy funding (Nadin et al. 2021). These departments often lack the professional competences and evidence base to understand the wider strategic and longer-term effects of policy. The procedural

safeguards and civil society institutions that can provide a check on government actions are often weak.

Governments are very aware of the potentially damaging costs of non-coordination. They generally understand that the great challenges facing governments crosscut many sectoral policies. They will understand generally that the success of efforts made for more a sustainable and resilient urban development or transition depend on sectors of government working in concert, but there is a tension between cooperation and competition. Governments at all levels have created new institutions to foster cross-fertilisation of sector policies such as coordination tools, organisations and practices to tackle national and global commitments for more sustainable and resilient development (Asarpota and Nadin 2020; Seto et al. 2014). However, in many countries, there is a continuing expectation that the established tools of the ‘urban and regional planning and design system’ will coordinate the effects of sectoral policies on places, but often, the planning system is not well-equipped to perform this role. The challenge for north-west Europe and the Pearl River Delta is to design and strengthen their territorial governance institutions to facilitate cross-fertilisation of sectoral policies—between the sectoral silos of government and across municipal boundaries.

Why are urban and regional planning systems not well prepared to foster cross-fertilisation? In all countries there is, to a greater or lesser extent, a discrete collection of interconnected institutions (laws, tools and practices) that have been created to plan, design and regulate urban development—the transformation of cities and countryside. Part of this task involves mediating the many competing interests involved. There is great variation in the mechanisms, but in most countries, there is something that can be described as a ‘system’ of urban and regional planning (or city and regional planning, town and country planning or other variants). The system will involve designs and strategies at different scales, procedures for regulating development through plans and the allocation of development rights, land policy tools that impose development taxes, recoup betterment (value capture) or provide for compensation and tools for engaging stakeholders and citizens in decision-making. Planning systems are powerful tools if backed up with political will and good governance. However, they are in effect, one sector policy and they are likely to be a relatively small and weak part of government policy that shapes the territory, particularly the urban transition. Planning systems tend to be in the position of servicing the needs of other priority government policies.

As we explained above, other sectoral policies can have a strong influence on the territory that may range in effect from complementary to dominating. Water management or coastal zone policy may assist planning tools in preventing urban development in flood risk zones. Economic and infrastructure investment may help to divert development interests away from vulnerable locations and ensure efficient use of the land resources. However, powerful sectoral policy can dominate the path of urban development. An important example in the EU is regional policy funding (Cohesion Policy) supporting the growth of lagging regions, which can dominate decision-making and become a ‘de facto’ urban planning, in competition with the approved plans and undermining planning goals. There is also the crucial role of

market actors whether these are major real estate developers or the aggregate demand of many small consumer decisions. The relationships between sector policies and market actors will vary, in some cases government policy will align with market demands, others may be in opposition.

The messy multisectoral environment that shapes urban development cannot be resolved by mandate that the urban planning system be followed absolutely. Competing objectives and policies in government are the norm, across different sectors and among the levels of government administration—national to municipal. Each will have its own source of legitimacy. Clashing sectoral policies is a problem of ‘governance’.

We can explain the significance of the notion of governance for planning with reference to three interrelated points (for a more thorough review see Schmitt and Wiechmann 2018; Schmitt and Well 2016). First, in Western countries, the power of a centralised government has become more fragmented and dispersed. This includes power within the government machinery where traditionally dominant departments are now sharing power with others that focus on key global challenges, notably in natural environmental matters. Government is also sharing decision-making with interests in the market and civil society sectors, in response to increasing private involvement in public services and the growing strength of non-governmental organisations. This dispersal of power in the making and implementation of policy can have advantages in the feasibility, robustness and acceptability of policy, but it requires much more interaction among stakeholders. Second, the idea of urban planning as simply an expert-led technical or scientific process of finding the most appropriate means to achieve ends given by the political process is long gone. Planning’s core work is in mediating the competing value positions of many stakeholders. It is a process of deliberation among many interests considering the evidence and seeking a shared way forward. And we recognise that planning itself is not a neutral objective practice but involves values. The idea of a value-free technical planning was never an accurate explanation of actual practice; the value judgements were hidden. Third, the recognition of dispersed power and the mediation role of planning renders the traditional, plan, design and control approach redundant. Again, it was probably never an accurate explanation of practice, but the notion of ‘control’, especially in a top-down way is certainly no longer appropriate when government relies so much on other actors to achieve its objectives. Furthermore, the rigid planning tools used to try to control urban development have proved inflexible in the face of uncertainty and complexity in decision-making (Zandvoort et al. 2018). There is a shift towards a more ‘adaptive rationale’ in planning (Skrimizea et al. 2019) that offers discretion to decision-makers to respond to fast-changing technological and socio-economic circumstances in response to the position of stakeholders, and to encourage innovative solutions (Nadin et al. 2020; Nadin et al. 2021; Rauws et al. 2014). Increasing use of strategic spatial plans is part of the recognition of the ‘governance landscape’ of which planning is a part (Healey 2007). In the strategy making process regional design where the spatial effect of combined decisions can be visualised and shared is also invaluable (Balz 2018).

With these points in mind, planning is conceived as the ‘governance of place’ or ‘place governance with a planning orientation’ (Healey 2010). In this place governance, there is a shift in structures that channel or command policies on business and stakeholders through a hierarchy of government levels to more complex relationships in a multi-level and multisectoral governance system of shared interest and power. It recognises that the efficiency and effectiveness of policy and interventions are enhanced if they are designed for specific places with local interests involved (Barca 2009). In Europe, this ambition has been summed up in the notion of territorial governance, ‘a place-based, territorially sensitive and integrated approach to policies’ (ESPON 2013; Schmitt and Van Well 2016).

We argue that the place-based ‘territorial governance’ approach to planning is vital for the future of deltaic regions. Planning in such places is ‘a messy back and forth process with multiple layers of contestation and struggle’ (Healey 2007, p. 182). The complex mix of ecological and urban systems can only be managed by bringing together a scientific assessment of conditions and opportunities into a discursive and deliberative process engaging with the many government sectors and stakeholders who have experience to bring forward into the planning process. The problem is not one of ensuring conformity with a rigid plan but of encouraging sectoral policy makers and stakeholders to make a collective effort to solve problems within a robust framework of policies. Adaptive urban transformation stimulates a redesign of planning mechanisms that can safeguard critical natural assets whilst giving discretion to decision-makers to adapt proposals to achieve shared objectives. A central component will be regional design processes and visual outcomes that can persuade and inspire stakeholders to follow a common path.

We now turn to experience in Europe, where the notion of ‘territorial governance’ is employed to boost regional cooperation and to inject a spatial or territorial dimension into sectoral policy.

### 4.3 European Experience

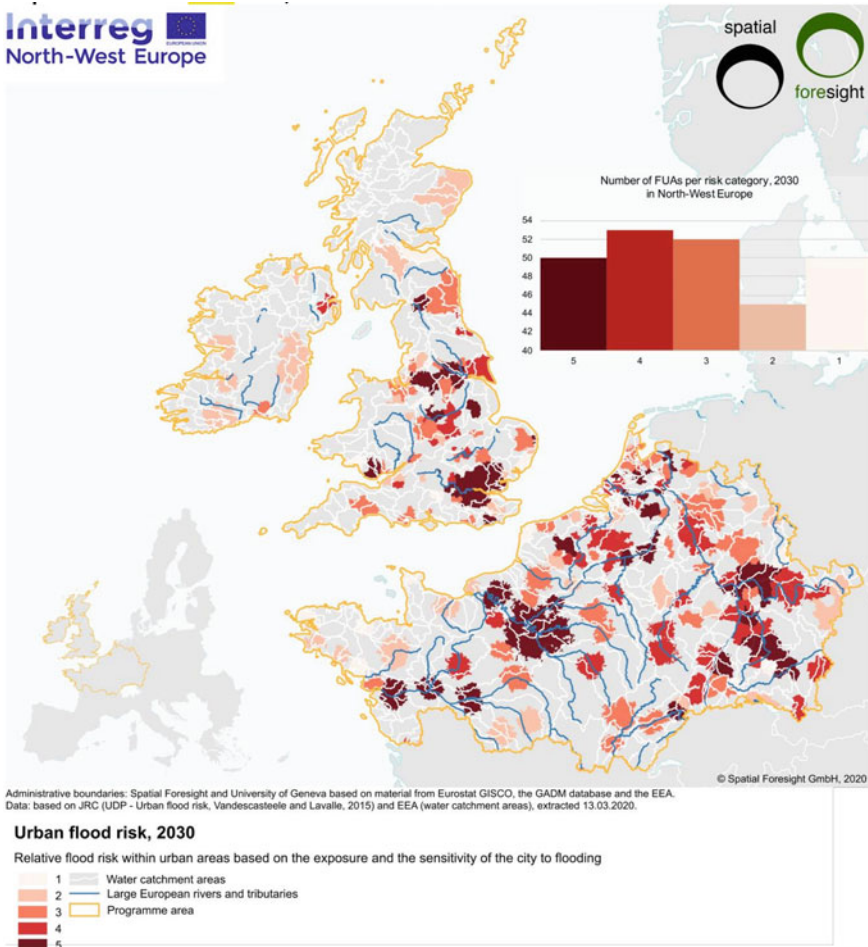
Europe urgently needs to build its resilience to the consequences of climate change, including flood risk. More than 40% of the EU’s population lives within 50 km of the sea and 100,000 people are faced with coastal flooding annually (EEA 2016, 2019). Coastal and river flooding together caused 4300 deaths between 1980 and 2017 and displaced half a million people, whilst in 2021 alone, the losses through more frequent climate-related extreme events was costing an estimated 12 billion euros per year. Governments are strengthening their response to flood risk. In 2021, the EU adopted its vision to become a climate-resilient society, the main pillars of which are more systematic and faster adaptation (European Commission 2021a, b). Part of the adaptation process has required, since 2007, that member states prepare flood risk management plans and to report annually on progress. All member states have prepared risk maps and action plans, but with intensification of the hydrological cycle the outlook is grave.



The European Environment Agency points out that one in five European cities over 100,000 population are very vulnerable to flooding. It emphasises the multisectoral nature of flood risk in saying that increases in the costs of flooding are ‘mainly due to land-use change, increases in population, economic wealth and human activities in hazard prone areas’ (EEA 2016, p. 1). The causes vary. Land resource management in some European countries is weak with informal or unregulated development in the ‘uncontrolled spread of towns and villages into undeveloped areas’ (EEA 2016, p. 1). In north-west Europe, officially sanctioned development plays a part, consuming valuable open land, often flood plains, and concentrating in the economic heartland which is already subject to high environmental stresses and flood risk. Figure 4.2 shows the urban areas expected to be at highest risk of flooding in north-west Europe by 2030, ‘based on the exposure and the sensitivity of the city to flooding’ (Spatial Foresight 2020, p. 57). Europe’s biggest cities, London and Paris are among 50 functional urban areas (FUAs) in the highest category of risk. Despite the widespread incidence of flood events, not all governments have joined up policy responses in different sectors (Fig. 4.3). For example, one in ten of all new homes in England from 2013 to 2020 have been built on land at the highest risk of flooding (Environment Agency 2021). This is just one of many examples of the costs of non-coordination.

Since the 1960s, steps have been taken to strengthen territorial governance in areas of flood risk, at first by countries especially vulnerable, notably the Netherlands and Belgium (Dühr et al. 2010). Awareness of the potential for better coordination spread across Europe following publication the *European Spatial Development Perspective* (CSD 1999). This was and continues to be an influential document in the 2020s. It advocates a ‘spatial planning approach’, a form of planning that takes sectoral policy cross-fertilisation as its main task, injects an explicit spatial dimension into sectoral policies and adopts common spatial objectives for all development projects. This integrated spatial development requires vertical cooperation between administrative levels, horizontal cooperation between sectoral policies and geographical cooperation across jurisdictions. The *Compendium of European Spatial Planning Systems and Policies* had anticipated these developments by defining ‘spatial planning’ in Europe as measures to coordinate the spatial impacts of other sectoral policies, ... and to regulate the conversion of land and property uses’ (CEC 1997, p. 24).

The 2000s were marked by intense debate across Europe about the role of the planning system in facilitating the spatial planning approach. Subsequently, some countries made substantial reforms to planning systems, though not always lasting (Nadin, 2006). The reforms put less emphasis on outputs in terms of volume of development and more on outcomes such as the quality of places. They called for indicative strategies to foster cooperation among stakeholders as well as imperative regulation of land use. Efforts have been made to understand the combined effect of sectoral policies on the qualities of those places, including flood risk, first, through environmental impact assessments and later, more encompassing territorial impact assessments (ESPO 2013). From the 1990s and following successful cooperation on flood risk between Germany and the Netherlands, the EU has encouraged cross-border working through the Interreg Programmes, which in the period from 2021 to 27 provides more than 2 billion euro per year for cooperation projects. National reforms recognised the need



**Fig. 4.2** Urban flood risk in north-west Europe, 2030. *Source* Spatial Foresight GmbH (2020, p. 57), courtesy of Kai Böhme and Sebastian Hans

for wide engagement with stakeholders in a process of mutual learning, but urban planning, the regulation of land use, was by no means abandoned. It predominates and is in any case essential in giving legal effect to strategic agreements.

Adoption of a spatial planning approach—strong cross-fertilisation—means that sectoral policy departments must relinquish some power, responsibilities and accountability must be adjusted, systems require new tools and professions must rethink their culture. Governments have a major challenge in encouraging such changes in behaviour, and it is not surprising therefore, that performance on cross-fertilisation in policymaking is patchy. There was a flurry of planning reforms in a number of countries in the 2000s, but there was much less interest after the 2008

**Fig. 4.3** Flood warnings in England



recession. There has also been resistance where there is a strong urbanist or architectural tradition in planning, and where more neo-liberal attitudes prevail. Nevertheless, there is evidence that the notion of 'the spatial planning approach' has been influential. By the late 2010s, cross-fertilisation was more intensive, not just information sharing among sectors, but involving active cooperation and sometimes coordination of policy (Nadin et al. 2018). Improvements have been gained by bolting on ad hoc tools to the planning process, such as impact assessments of policy, requirements for conformity among plans, joint working on data and analysis and ad hoc cooperation platforms. In some countries, the scope of plans and strategies has been widened.

Whilst there is evidence of a gradual reorientation of planning from the 1980s, there is no common path. Much depends on local conditions, especially the social model, itself a product of history, local conditions and challenges (Nadin and Stead 2008). Different facets of the spatial planning approach are in evidence as governments incrementally reform planning systems to the task of territorial governance. Some indications can be given from a survey of planning reforms in 32 European countries (Nadin et al. 2018). They include more emphasis on the outcomes of policy and intervention, e.g. by asking not so much how much dyke is built but how much flooding occurs. Whilst elements of binding regulation remain important, e.g. for the protection of critical natural assets, there is more attention to planning tools that seek to shape the attention and actions of other policy sectors and stakeholders. Thus, planning documents are more likely to include a strategic element at national and local scales, and the measure of success is as much about the influence on other sectoral plans as on direct implementation of the plan.

The adoption of spatial planning principles in their entirety is perhaps unrealistic, but many countries are on a slow trajectory towards the spatial planning approach, and thus, it is argued, more efficient and effective interventions that may reduce flood risk. However, the idea has been discussed for 30 years with only partial take up. The reason is the 'stickiness' of deeply embedded institutions—the ways things are done. There is a lack of trust between sectors, limited learning capacity in sectors and professions, a proliferation of tools that are designed for control and not collaboration, and increasingly neo-liberal political attitudes. Therefore, we should emphasise that

cross-fertilisation through the spatial planning approach is not possible without a rethink of professional and departmental cultures.

In 2021, an extensive dialogue was conducted among European experts in 32 countries, together with a case study in the Czech Republic, on the extent and further potential for cross-fertilisation of sectoral policy and the role that spatial planning can play (Nadin et al. 2021, pp. 16–17). The dialogue explored many examples of good practice in cross-fertilisation that may be useful for other settings, and not only in Europe. The findings, agreed with the body of experts, are presented in a policy brief for governments which provides an overview of the mechanisms that are available to government to improve cross-fertilisation and thus the efficiency and effectiveness of sectoral policies (Box 4.1). There are seven practical steps that may be taken to improve cross-fertilisation, all of which are relevant to flood risk management. We would highlight here the importance of the first point which stresses the need to create ‘favourable conditions’ particularly by addressing the professional and cultural dimension of departmental, municipal and professional groupings that can hold back innovation in policy making.

**Box 4.1: Seven practical steps towards better territorial governance through cross-fertilisation**

- **Resolve unfavourable conditions** that will hinder measures to strengthen cross-fertilisation, ensuring inclusive good governance practices and challenging the dominant ‘policy silo’ mindset through institutional and individual capacity building.
- **Know the territorial impacts of sectoral policy** by making use of territorial impact assessment (TIA) and consultation with stakeholders to evaluate and monitor the combined impacts of policies.
- **Test the complementarity** of investments made by cohesion policy and other sectoral policies with spatial planning strategies, identifying and mapping inconsistencies and proposing actions to foster more consistency.
- **Lift communication barriers** that stifle joint working, by promoting the use of the same key terms, territorial units, indicators and data sets in policymaking, and set out priorities and responsibilities for action on harmonisation
- **Champion joint working** in territories where it is a priority to strengthen the efficiency of investment, at first through voluntary cooperation, and, if needed, through statutory ad hoc agencies that can take on a leading role in joining up policies and actions.
- **Promote place-sensitivity in cohesion policy** by ensuring that the territorial dimension is given more priority by the managing authorities, including the spatial effects of investment and its relationship to existing spatial planning objectives.

- **Customise spatial planning tools for cross-fertilisation** to create more responsive spatial strategies and plans that get to grips with investment opportunities, and align the rhythm of strategy and plan reviews.

*(Nadin 2021, pp. 16–17).*

#### 4.4 Discussion and Conclusion

Europe has experienced dramatic changes in land use since the industrial revolution which have accelerated from the 1950s. Much conversion of open land to built-up land is in vulnerable coastal zones, often where there is long-standing flood risk. In common with the rest of the world Europe faces increased flood risk and threats to life and property arising from climate change. EU institutions and domestic governments have taken decisive action to better manage the conversion of land use and thus reduce the growth in risk, including binding requirements for flood risk assessment, management plans, impact assessments and monitoring of land-use change in the coastal and riparian zones. There have been repeated calls for more effective cross-fertilisation of sectoral policies to ensure complementarity and seize opportunities for win–win solutions by adopting a spatial planning approach that is more adaptable, integrative and inclusive. Considerable EU funding has been made available for encouraging cooperation across municipal, regional and national borders. These initiatives have certainly had an impact on practices, though with variation across Europe. Governments are rethinking planning to promote stronger cross-fertilisation with other sector policies, to engage more fully with stakeholders and citizens, but traditional professional cultures around the technical top-down rigid approach to planning, and the silo mentality, are difficult to shift.

Is this experience of any value to China and in particular, flood risk management in the Great Bay Area? We must take great care in making comparisons, or in transposing solutions to places where conditions and cultures are very different and when ‘when concepts do not travel well across national boundaries’ (Nadin 2012, p. 3). There are similarities, particularly between the delta area of north-west Europe and the PRD. The experience of rapid urbanisation in the PRD is exceptional, but the characteristics of the two delta regions are similar. The challenges in the PRD are expressed in similar ways to those explained above for Europe. The goals of the Outline Development Plan for the Guangdong-Hong Kong-Macao Greater Bay Area 2019, have strong parallels with experience in Europe. The common challenges are to balance the economies and diseconomies of agglomeration, to reduce friction caused by border effects, to replace competition with complementarity and to overcome constitutional, legal and cultural differences in promoting development and planning holistically. Underlying these objectives is the tension between the great prosperity that agglomerations can deliver, whilst putting right the damage that has been done to natural environmental

systems and creating more adaptive environments to current and future challenges of flood risk.

We suggest there are three areas of European experience that will be of interest to China (Meng et al. 2021). First, there is clearly a role for a form of spatial planning with the core task of cross-fertilising sectoral policies that have some impact on flood risk alongside the common engineering approaches in the water management sector. This would include ensuring that economic investments, land-use regulation, transport infrastructure, environmental and agricultural and marine policies, among others, work in concert to support flood risk reduction. Second, all decision-making in sectoral departments would benefit from being informed by a common source of data, analysis and forecasting on flood hazards and the implications for urban and rural development. As noted above, it would also be advantageous if there was a common set of technical terminology across sectors. Third, there are many examples in Europe of the sorts of mechanisms that provide a platform for debate and joint deliberation in the policy and decision-making process, and which would promote more coherence between water management, spatial planning and other sector actions. This would need to be supported with measures to soften the hard boundaries of professional and departmental knowledge systems.

We raise these points in a modest way, and with a strong caveat. There is an acceptance in European governments that more cross-fertilisation is needed to tackle complexity, uncertainty and the potential long-term damage that can be done to vulnerable natural environmental systems by poor urban development, that in turn puts assets and people at risk. However, this point has been made many times over decades. It has taken a long time to see signs of change. Considerable encouragement and funding for inter-sectoral and cross-border collaboration may not reap substantial benefits when the underlying conditions that encourage competition are not changed. Also, sectoral policy makers in water management and economic development are powerful actors who are focused on the achievement of specific narrow objectives. They may have little incentive to collaborate and compromise. Above all, the dominant rational planning culture can put a break on efforts for reform. It is not enough to reform tools or procedures to encourage cooperation between those responsible for water management, urban planning and other sectors, without shifting the mindset of the practitioners and politicians. There needs to be an institutional and professional learning process that encourages effective dialogue in the interests of a more adaptive urban transformation.

Nevertheless, the challenge must be addressed. We have explained that whilst making and implementing policy in departmental silos has some advantages, there are significant costs especially in the way that sectoral policies play out in certain locations. This is especially true for flood risk management which obviously relies on a committed and coordinated response from many sectoral policies—water management and hydrological engineering, marine planning, economic development, transport and infrastructure development, agriculture and more. We have pointed to examples of the costs of non-coordination in north-west Europe. Vulnerability to flood risk and the need for better cross-fertilisation among policy sectors in the interests of good territorial governance are equally relevant in the Pearl River Delta.

Experience in Europe has demonstrated that progress can be made but that there are deep seated barriers, not least sectoral and professional cultures, and the rigidity of existing planning and design tools. The seven steps summarized above offer a starting point for debate about effective cross-fertilisation and stronger territorial governance in the interests of flood risk management.

### Funding

This research was funded by the National Youth Science Fund Project of the National Natural Science Foundation of China (52108050), the Guangzhou Science and Technology Program (202201010503), and the Guangdong Basic and Applied Basic Research Foundation (2023A1515011653).

## References

- Asarpota K, Nadin V (2020) Energy strategies, the urban dimension, and spatial planning. *Energies* 13(14):3642. <https://doi.org/10.3390/en13143642>
- Balz V (2018) Regional design: discretionary approaches to regional planning in the Netherlands. *Plan Theory* 17(3):332–354. <https://doi.org/10.1177/1473095217721280>
- Barca F (2009) An agenda for a reformed cohesion policy: a place-based approach to meeting European Union challenges and expectations. European Commission, Brussels. [http://ec.europa.eu/regional\\_policy/policy/future/pdf/report\\_barca\\_v0306.pdf](http://ec.europa.eu/regional_policy/policy/future/pdf/report_barca_v0306.pdf)
- Candel JLL (2021) The expediency of policy integration. *Policy Stud* 42(4):346–361. <https://doi.org/10.1080/01442872.2019.1634191>
- Commission of the European Communities (CEC) (1997) The EU compendium of spatial planning systems and policies. Office for Official Publications of the European Communities, Luxembourg
- Committee on Spatial Development (CSD) (1999) European spatial development perspective: towards balanced and sustainable development of the territory of the European Union. European Commission, Brussels
- Dühr S, Colomb C, Nadin V (2010) European spatial planning and territorial cooperation. Routledge, London and New York
- Environment Agency (England) (2021) Long-term investment scenarios 2019, updated 2021. Environment Agency, Bristol. <https://www.gov.uk/government/publications/flood-and-coastal-risk-management-in-england-long-term-investment/long-term-investment-scenarios-ltis-2019>
- Ersoy A, Brand N, van Bueren E (2023) Adapting a systems perspective for cross-sector coordination: approaching flood resilience in Houston and Accra. *Planning Practice and Research*
- ESPON (2013) Territorial impact assessment of policies and EU directives. ESPON, Luxembourg. [https://www.espon.eu/sites/default/files/attachments/TIA\\_Printed\\_version.pdf](https://www.espon.eu/sites/default/files/attachments/TIA_Printed_version.pdf)
- European Commission (1998) Report on community policies and spatial planning: Working document of the commission services. CEC, Brussels
- European Commission (2021a) Territorial agenda 2030: a future for all places. Federal Ministry of the Interior, Building and Community, Germany. [https://ec.europa.eu/regional\\_policy/sources/docgener/brochure/territorial\\_agenda\\_2030\\_en.pdf](https://ec.europa.eu/regional_policy/sources/docgener/brochure/territorial_agenda_2030_en.pdf)
- European Commission (2021b) Forging a climate-resilient Europe: The new EU strategy on adaptation to climate change. Communication from the Commission, Brussels

- European Environment Agency (EEA) (2016) Flood risk in Europe: the long-term outlook. <https://www.eea.europa.eu/highlights/flood-risk-in-europe-2013>. Accessed 15 Dec 2021
- European Environment Agency (EEA) (2019) Copernicus land monitoring service. Thematic hotspot monitoring in coastal zones factsheet. EEA, Copenhagen
- European Environment Agency (EEA) (2021) Global and European sea level rise. EEA, Copenhagen. <https://www.eea.europa.eu/ims/global-and-european-sea-level-rise>
- European Observation Network for Territorial Development and Cohesion (ESPON) (2013) ESPON TANGO: Territorial approaches for new governance. Final report. ESPON
- Greater Bay Area Development Office (2019) Outline development plan for the Guangdong-Hong Kong-Macao greater bay area (Chinese Version and Courtesy Translation into English). GBAD, Hong Kong
- Healey P (2007) Urban complexity and spatial strategies: towards a relational planning for our times. Routledge, London
- Healey P (2010) Making better places: the planning project in the twenty-first century. Palgrave Macmillan, London
- Helm D (2016) Natural capital: valuing the planet. Yale University Press, New Haven
- Marks D (2015) The urban political ecology of the 2011 floods in Bangkok: the creation of uneven vulnerabilities. *Pac Aff* 88(3):623–651
- McGranahan G, Satterthwaite D (2014) Urbanisation concepts and trends. International Institute for Environment and Development Working Paper. IIED, London
- Meng M, Li W, Yan J, Nadin V (2021) Governing climate adaptation planning: integration between water management and spatial planning in the Netherlands. *Urban planning international* (in Chinese)
- Nadin V, Stead D (2008) European spatial planning systems, social models and learning. *Plan Rev* 44(172):35–47. <https://doi.org/10.1080/02513625.2008.10557001>
- Nadin V, Stead D, Dabrowski M, Fernández Maldonado AM (2020) Integrated, adaptive and participatory spatial planning: trends across Europe. *Reg Stud*. <https://doi.org/10.1080/00343404.2020.1817363>
- Nadin V, Fernández Maldonado AM, Zonneveld WAM, Stead D, Dąbrowski M, Piskorek K, Sarkar A, Schmitt P, Smas L, Cotella G, Janin Rivolin U, Solly A, Berisha E, Pede E, Seardo BM, Komornicki T, Goch K, Bednarek-Szczepańska M, Degórska B, Münter A (2018) COMPASS: comparative analysis of territorial governance and spatial planning systems in Europe. ESPON EGTC, Luxembourg
- Nadin V, Piskorek K, Balz VE, Zonneveld W, Muñoz Unceta P, Georgieva N, den Hoed W, Hermansons Z, Daly G (2021) ESPON policy brief: cross-fertilisation of cohesion policy and spatial planning. ESPON EGTC, Luxembourg
- Nadin V (2006) The role and scope of spatial planning: spatial plans in practice: literature review summary. Communities and Local Government, London. <http://www.communities.gov.uk/index.asp?id=1504896>
- Nadin V (2012) International Comparative Planning Methodology: Introduction to the Theme Issue *Planning Practice and Research* 27(1):1–5. <https://doi.org/10.1080/02697459.2012.669928>
- Nicholls RJ, Hanson S, Herweijer C, Patmore N, Hallegatte S, Corfee-Morlot J, Chateau J, Muir-Wood R (2007) Ranking of the world's cities most exposed to coastal flooding today and in the future. OECD, Paris
- North-west Metropolitan Area Spatial Vision Group (NWMA) (2000) A spatial vision for north-west Europe. VROM, The Hague
- Nuissl H, Siedentop S (2021) Urbanisation and land use change. In: Weith T, Barkmann T, Gaasch N, Rogga S, Strauss C, Zscheischler J (eds) Sustainable land management in a European context: human-environment interactions, vol 8. Springer. [https://doi.org/10.1007/978-3-030-50841-8\\_5](https://doi.org/10.1007/978-3-030-50841-8_5)
- Peters BG (2018) The challenge of policy coordination. *Policy Des Pract* 1(1):1–11. <https://doi.org/10.1080/25741292.2018.1437946>
- Rauws WS, Cook M, Van Dijk T (2014) How to make development plans suitable for volatile contexts. *Plan Pract Res* 29(2):133–151. <https://doi.org/10.1080/02697459.2013.872902>



- Robert J, Stumm T, De Vet JM, Reincke GJ, Hollanders M, Figueiredo MA (2001) Spatial impacts of community policies and the costs of non-coordination: study carried out at the request of the directorate-general 'regional policy' European commission. European Commission, Brussels. [https://ec.europa.eu/regional\\_policy/sources/docgener/studies/pdf/spatial\\_en.pdf](https://ec.europa.eu/regional_policy/sources/docgener/studies/pdf/spatial_en.pdf)
- Schmitt P, Van Well L (2016) Territorial governance across Europe: pathways, practices and prospects. Routledge, Abingdon
- Schmitt P, Wiechmann T (2018) Unpacking spatial planning as the governance of place. *Disp* 54(4):21–33
- Seto KC, Dhakal S, Bigio A, Blanco H, Delgado GC, Dewar D, McMahon J (2014) Human settlements, infrastructure and spatial planning: in mitigation of climate change. Contribution of working group III to the fifth assessment report of the intergovernmental panel on climate change. Cambridge University Press
- Skrimizea E, Haniotou H, Parra C (2019) On the 'complexity turn' in planning: an adaptive rationale to navigate spaces and times of uncertainty. *Plan Theor* 18(1):122–142. <https://doi.org/10.1177/1473095218780515>
- Spatial Foresight (2020) The Territorial Analysis of the NWE Cooperation Area, Thematic Analysis. Interreg North-west Managing Authority, Lille, France
- Stead D, Nadin V (2008) Spatial planning: key instrument for development and effective governance. United Nations Economic Commission for Europe (with Dominic Stead), Geneva. [http://www.unece.org/hlm/prgm/urbanenvperf/Publications/spatial\\_planning.pdf](http://www.unece.org/hlm/prgm/urbanenvperf/Publications/spatial_planning.pdf)
- World Meteorological Society (WMO) (2019) Greenhouse gas bulletin. <https://public.wmo.int/en/media/press-release/greenhouse-gas-concentrations-atmosphere-reach-yet-another-high>
- Zandvoort M, Van der Vlist MJ, Klijn F, Van den Brink A (2018) Navigating amid uncertainty in spatial planning. *Plan Theor* 17(1):96–116. <https://doi.org/10.1177/1473095216684530>

**Open Access** This chapter is licensed under the terms of the Creative Commons Attribution-NonCommercial 4.0 International License (<http://creativecommons.org/licenses/by-nc/4.0/>), which permits any noncommercial use, sharing, adaptation, distribution and reproduction in any medium or format, as long as you give appropriate credit to the original author(s) and the source, provide a link to the Creative Commons license and indicate if changes were made.

The images or other third party material in this chapter are included in the chapter's Creative Commons license, unless indicated otherwise in a credit line to the material. If material is not included in the chapter's Creative Commons license and your intended use is not permitted by statutory regulation or exceeds the permitted use, you will need to obtain permission directly from the copyright holder.



# Chapter 5

## A Landscape-Based Regional Design Approach for Sustainable Urban Development in the Pearl River Delta, China



Steffen Nijhuis, Yimin Sun, Daniele Cannatella, and Guangyuan Xie

**Abstract** Adaptive urban transformations employ landscape-based regional design as an integrative and multiscale design and planning approach for sustainable urban development. In this approach, natural and urban dynamics as derived from systems analysis set the pace and nature of adaptation. This chapter presents an initial strategy for adaptive urban transformation in the Pearl River Delta to illustrate the potential of landscape-based regional design as form of territorial governance that takes the natural and urban landscape as the basis to steer urban–rural transformative processes through a combination of sector activities towards more coordinated sustainable outcomes. The strategic spatial plan and subsequent implementation by means of pilot projects will focus on the potential of interlinked economic and ecological development at multiple scales. Together with the assessment of urban landscape growth over time and the evaluation of current spatial development projects in the region, several significant factors of future development have been identified, leading to an initial strategic vision and transformation perspectives for the PRD. This vision is based on the idea that the PRD will develop into China’s Silicon Valley, with strongly developed and well-connected urban qualities, robust green–blue frameworks, cultural-historical assets connected to the region and water-sensitive socio-ecological inclusive urbanism.

**Keywords** Adaptive urban transformation · Landscape-based regional design · Vision Pearl River Delta · Transformation perspectives · Adaptive design principles

---

S. Nijhuis (✉) · D. Cannatella  
Faculty of Architecture and the Built Environment, Delft University of Technology, Julianalaan  
134, 2628 BL Delft, The Netherlands  
e-mail: [s.nijhuis@tudelft.nl](mailto:s.nijhuis@tudelft.nl)

D. Cannatella  
e-mail: [d.cannatella@tudelft.nl](mailto:d.cannatella@tudelft.nl)

Y. Sun · G. Xie  
School of Architecture, South China University of Technology, Tianhe, 381 Wushang Road,  
Guangzhou 510640, Guangdong, China  
e-mail: [arymsun@scut.edu.cn](mailto:arymsun@scut.edu.cn)



**Fig. 5.1** In some parts of the PRD, there is barely any room left for the water. *Photo* Guangyuan Xie

## 5.1 Introduction

Adaptive urban transformation requires planning and design strategies and principles that take the (natural) landscape as the basis for working with natural processes for the benefit of socially and ecologically inclusive and thriving urban landscapes. Such an approach takes the landscape first and considers the biosphere the context for social and economic development (Nijhuis 2022). The assumption is that through a design-oriented multiscale and transdisciplinary approach resiliency and adaptive capacity can be built up in terms of the development of spatial structures, but also in terms of people, business, knowledge and governance. Landscape-based regional design is considered an essential strategy for developing resiliency and adaptive capacity by providing ways to deal with uncertainty, finding ways to safeguard resources and cope with vulnerabilities (Nijhuis 2022).

This chapter presents an initial strategy for adaptive urban transformation in the Pearl River Delta (PRD) to illustrate the potential of landscape-based regional design as form of territorial governance that takes the natural and urban landscape as the basis to steer urban–rural transformative processes through a combination of sector activities towards more coordinated sustainable outcomes (Fig. 5.1).<sup>1</sup> The strategic spatial plan and subsequent implementation by means of pilot projects will focus on the potential of interlinked economic and ecological development at multiple scales. But first, we will elaborate the concept of landscape-based regional design, as well as the four key phases of the process it constitutes.

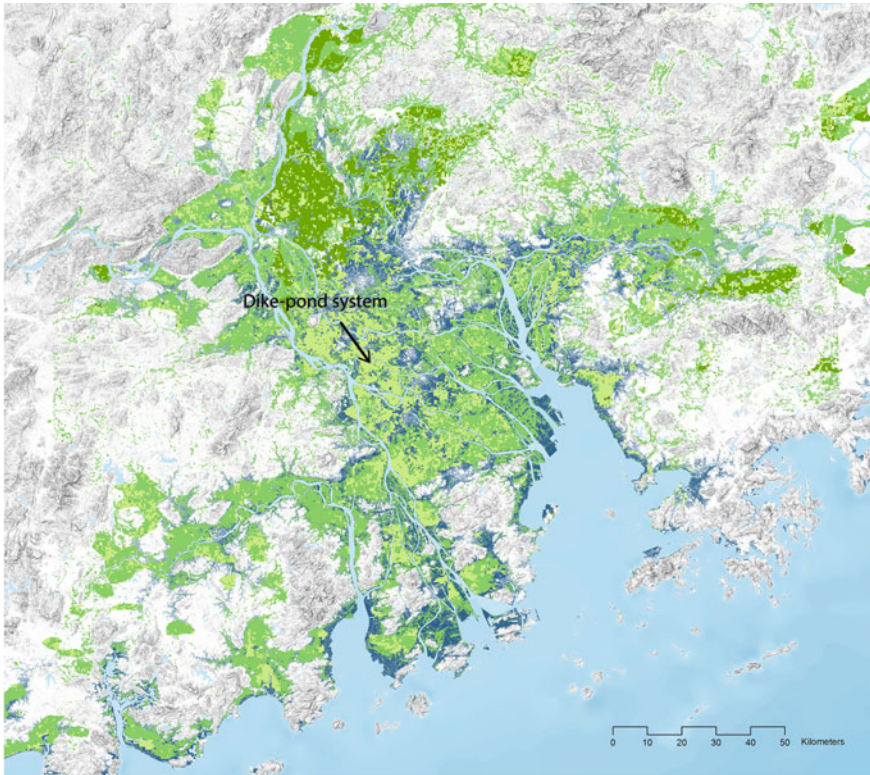
<sup>1</sup> Parts of this chapter have been published in adapted form in Nijhuis (2022) and Nijhuis et al. (2019, Chinese, 2020, English).

## 5.2 Landscape-Based Regional Design

Landscape-based regional design is a form of design and planning that applies principles from landscape architecture, urban design and planning, landscape ecology and geography to spatially oriented research, design and planning (Nijhuis 2022). It also utilises knowledge from systems thinking and complexity theory to promote a more comprehensive regional planning and design form that addresses the complex web of relationships making up the urban landscape (Nijhuis and Jauslin 2015). In landscape-based regional design, the physical landscape structure and associated natural processes are taken as a foundation to generate favourable conditions for future development and to guide and shape spatial transformations. Therefore, this approach offers a model for urban development and transformation, the preservation of biodiversity, water resource management, improved leisure facilities, community building, stronger cultural identity and economic development (cf. Neuman 2000) while taking the landscape as the basis.

Landscape-based regional design identifies and guides urban development towards the most advantageous places, functions, scales and inter-relationships through the development of robust landscape structures. These resilient and adaptive spatial frameworks ensure the coherent development of the region (long-term strategy) and, at the same time, create conditions and flexibility for local projects (short-term intervention). Research through design is an essential means to explore the possibilities of and contextualise adaptive design principles, such as nature-based solutions, water-sensitive design, social-ecological inclusive design or design with heritage (Figs. 5.2, 5.3 and 5.4). This implies landscape-based regional design operates at different scales, from regional to local, and accommodating both general and more specific measures. In this process, the utilisation of knowledge of physical, biological and cultural aspects of the landscape is inevitable. Enabling digital technologies, such as Geographic Information Systems (GISs), is a powerful tool in landscape-based urbanism for pre-processing, modelling, analysing and representing data to gain new insights and augment the design process with tremendous calculating and visualisation capacities (Nijhuis 2015).

Balancing the relationship between experts, citizens and authorities is also necessary to make landscape-based regional design work. This calls for a process that is not limited to the domain of landscape and urban planners and designers but that also actively involves other knowledge domains, such as data scientists, environmental technology and urban studies. It also affects people who live in the area, the business community, administrators and other stakeholders. The idea is that through meaningful participation of all stakeholders in envisioning, design and policy decisions, the resilience and adaptive capacity of urban landscapes will be increased, not only in physical terms but certainly also in socio-economic terms (Ahern 2011). This implies a shared understanding and also indicates a future-oriented, proactive approach in which the interaction between citizens, businesses, experts and the government is central.



**Fig. 5.2** The PRD is throughout the centuries shaped by the interaction of humans with the deltaic lowland and resulted in an intricate system of land reclamation, water management and agri-aquaculture such as the dike-pond system, here indicated in green. How can this landscape facilitate sustainable urban development? *Image* Steffen Nijhuis

Visualisation for communication of planning and design contents is key to integration of stakeholders on multiple scales in planning and design processes (Gill and Lange 2015; Lange and Hehl-Lange 2010). Recently developed innovations and state-of-the-art immersive visualisations proved to be very useful, e.g. immersive virtual reality (VR) representations using head-mounted displays for testing perceptions of different planning scenarios (Lu et al. 2021), Augmented reality (AR) interfaces for enriching GIS maps with overlays of design alternatives while running a dynamic multi-criteria analysis and mobile tablet-based AR with 3D model recognition and tracking for superimposing designs of blue and green infrastructure and virtual replacement of buildings in the physical model (Tomkins and Lange 2020; see also Chaps. 8, 9 and 10 of this volume).

In landscape-based regional design, content is thus linked to a process of promoting social-ecological inclusiveness, diversity and flexibility. Through landscape-based regional design, we can create conditions, as it were, for change,



**Fig. 5.3** Adaptation of urban patterns in the agri-aquacultural landscape of the PRD. *Photo* Lixing Zhao, TU Delft

**Fig. 5.4** Public space as a social infrastructure with water as a play feature and for a pleasant microclimate. *Photo* Steffen Nijhuis



and guide transformations through the development of robust landscape structures that connect spatial scales while at the same time offering space for individual interpretation at the local level (Nijhuis 2022). Spatial quality is the leading factor in finding a new balance between experience, use and future values. In addition, multi-functionality, accessibility, heritage and biodiversity are some of the ecological, economic, social and cultural interests that need to be addressed. In this way, specialised knowledge and local expertise can contribute to an integrated approach of sectoral activities and lead to coordinated, sustainable results that benefit everyone.

To summarise, landscape-based regional design (Nijhuis 2022):

- Takes the regional landscape structure and associated processes as the foundation to guide and shape spatial developments and transformation;
- Learns from landscape history and vernacular practice and makes use of the accumulation of Indigenous and local knowledge (or traditional ecological knowledge);
- Employs knowledge-based spatial design as an integrative, multiscale and transdisciplinary approach and exploits the power of enabling digital technologies;
- Develops resilient and adaptive spatial frameworks: robust landscape structures for the coherent development of the region (long-term strategy) and at the same time setting the scene for local projects (short-term intervention);
- Creates and regenerates living systems in which (bio)diversity, cultural history and multi-functionality lead to sociologically and ecologically inclusive and water-sensitive urban landscapes.

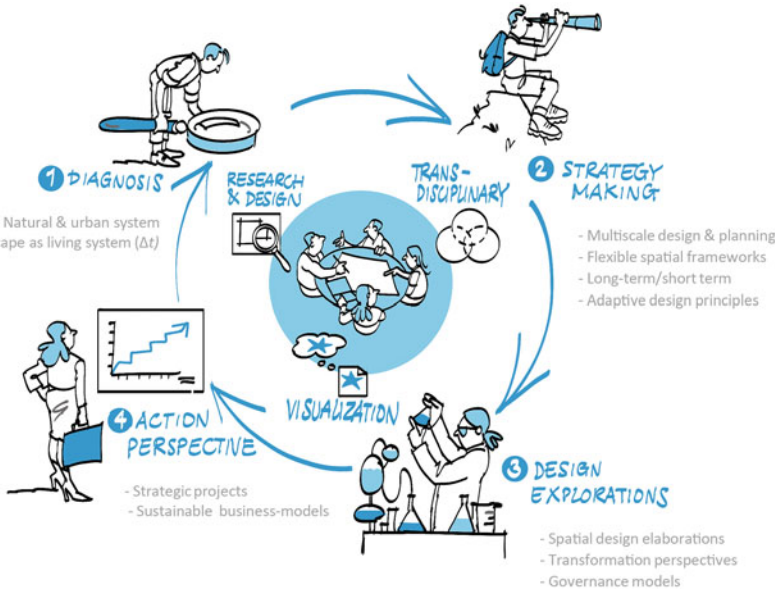
### 5.3 Four Key Phases of Landscape-Based Regional Design

Landscape-based regional design is a co-creative process that entails four key phases: (1) diagnosis, (2) strategy making, (3) design explorations and (4) action perspective. This process is supported by a combination of research and design, meaningful stakeholder involvement and imagination (Nijhuis 2022) (Fig. 5.5). In the following, these phases are further substantiated with backgrounds and applications in the PRD.

#### 5.3.1 *Diagnosis: Understanding Urban Landscape Systems and Their Dynamics*

In the diagnosis phase, stakeholders co-create knowledge and understanding on how the urban landscape system operates and what challenges and opportunities can be identified.

An urban landscape can be viewed as a complex system consisting of subsystems, each within its own dynamics and velocity of change (Meyer and Nijhuis 2013). Maps of landscape systems reveal the spatial conditions that inform adaptive

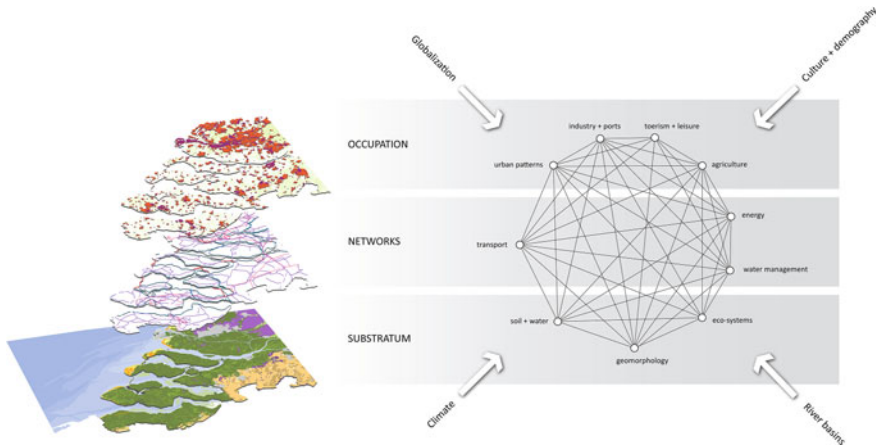


**Fig. 5.5** Landscape-based regional design as a process that entails four key phases: (1) diagnosis, (2) strategy making, (3) design explorations and (4) action perspective. This process is supported by a combination of research and design, meaningful stakeholder involvement and imagination. *Image* Steffen Nijhuis, *illustrator* Shirley Warlich

planning strategies and design principles. Decomposing the urban landscape into layers according to the dynamic of change is a proven method to help understand the urban landscape system (Nijhuis and Pouderoijen 2014). Layers with a low dynamic of change are the substratum (e.g. topography, hydrology, soil) and climate (e.g. precipitation patterns, temperature, wind). These environmental factors, regarded as the most influential conditions for land use, are known as *first-tier conditions*. Infrastructural networks for transportation, water management and energy supply are grouped in another layer, termed *second-tier conditions*. Displaying quicker growth and change than the first-tier environmental conditions, these are also significant conditional variables for land use. Together, these first- and second-tier conditions together pave the way for the development of agricultural land use and urban settlements, resulting in the layer with the highest change and transformation dynamics (Nijhuis and Pouderoijen 2014) (Fig. 5.6).

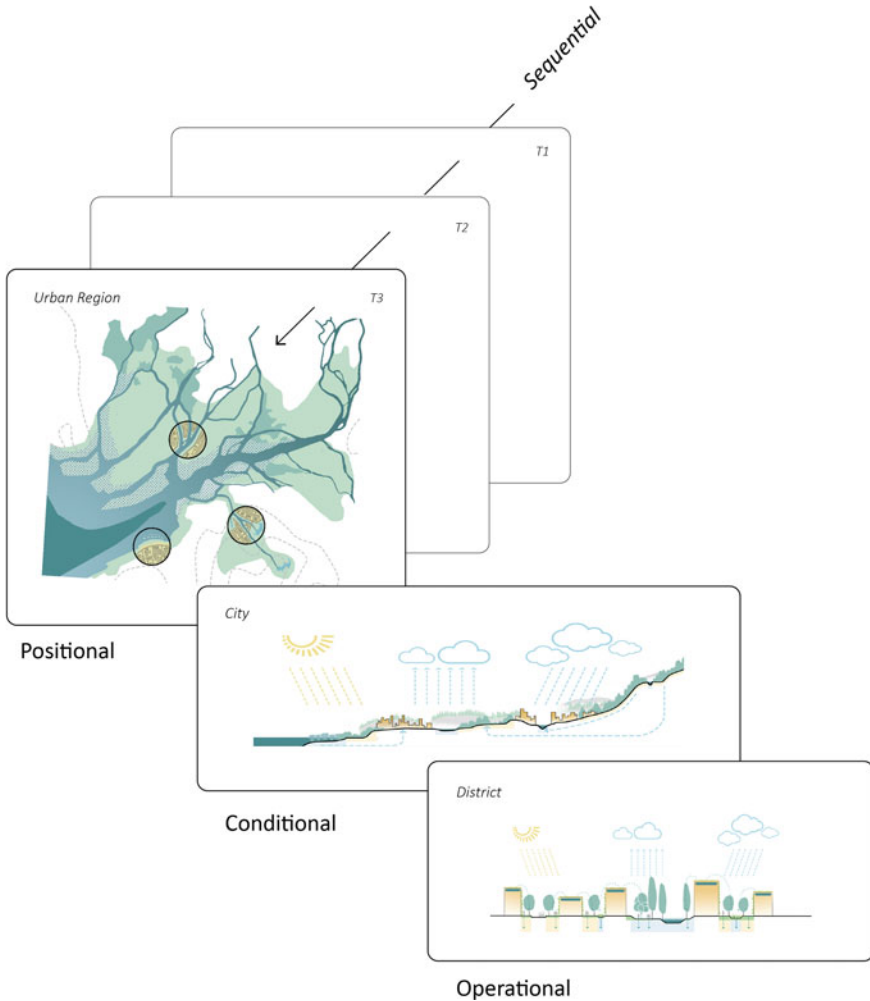
An understanding of the urban landscapes is thus inherent to the concept of the layers and their relationships that constitute the landscape system. The urban landscape as such is a relational structure that connects and influences scales and spatial, ecological, functional and social entities. The urban landscape is a holistic system and a scale continuum that we can only understand by looking at different spatial scales and their relationships. Thus, the earlier mentioned entities are part of a scale continuum in which relationships are shaped via the attachment, connection and





**Fig. 5.6** Understanding the urban landscape as a layered and complex system. *Image* Steffen Nijhuis

embedment of a specific site or location into the broader landscape context at different scale levels. We can analyse these relationships at different scales by looking at positional, conditional and operational factors and their interactions (Fig. 5.7). *Positional relationships* refer to the regional scale and is about the location of spatial entities in the natural and urban system. These types of relationships determine the possibilities for land use, such as housing, industry, farming, forestry and leisure. The adjacency to cities, accessibility, value and availability of (new) land and strategic positions in terms of geopolitics and demographics are also important allocation factors. *Conditional relationships* refer to accessibility by road, rail and waterway, as well favourable soil conditions and access to sufficient fresh water, along with natural watercourses such as rivers and streams. The available land and its possibilities for the agriculture, and so on, are also important conditional factors. *Operational relationships* refer to the site conditions that affect the site directly. The availability of water, moisture and nutrients in the soil and microclimatic aspects such as light, precipitation, wind and temperature are important factors, but also accessibility by train, car and boat. At the operational level, the interventions and constructions to enhance the site conditions by roads, highway exits, train stations, irrigation and drainage, fertilisation of poor soils, plantations, grazing, etc., are also of crucial importance. *Sequential relationships* are important to understand the development of the systems and their relationships through time (Nijhuis et al. 2023).



**Fig. 5.7** Exploring urban systems at different scale levels and their positional, conditional and operational relationships. Sequential relationships are also important to understand the development through time. *Image Steffen Nijhuis*

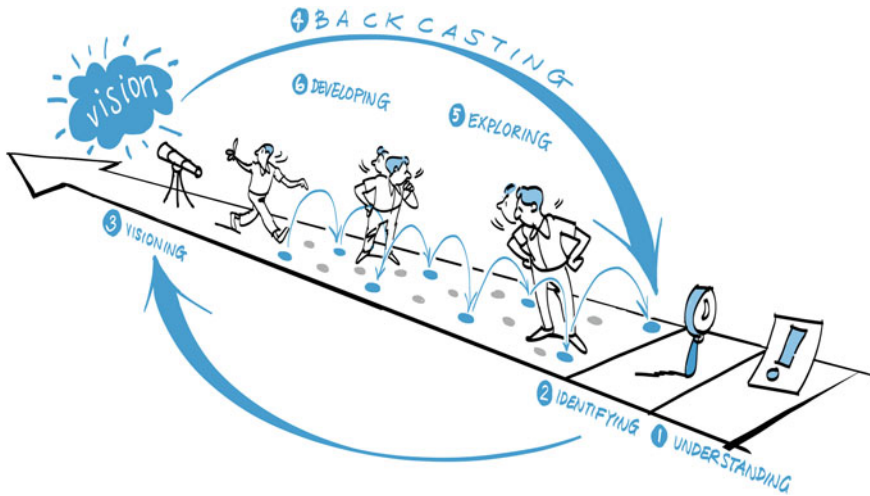
### 5.3.2 Strategy Formation: Envisioning, Backcasting, Adaptive Design Principles

Based on a proper shared understanding of how the natural and urban system functions and the challenges and potentials that need to be addressed, the process of strategy formation and design explorations can start. Strategy formation is about making plans that direct or guide courses of action in the long term into the future (Mintzberg 1994). One could say it is about outlining a path to get from here to there.

Often, these outlines are broadly defined while details are allowed to emerge with them, providing flexibility. Strategy formation is in this regard a planning procedure to help guide design explorations and making plans (cf. Mintzberg 1994).

Strategy formation in landscape-based urbanism entails creating a long-term regional vision or perspective that utilises knowledge of the natural and urban systems to address the identified challenges and potentials. Usually, a regional design is used to envision a desirable future expressing what the urban landscape should or can look like. The regional design provides strength and direction and gives meaning to what stakeholders want to achieve together. It provides a sense of focus and belonging when a vision is shared. Long-term perspectives also should address ways to deal with uncertainty, as we cannot gaze into a crystal ball to see the future. A common way to get a grip on uncertainty in spatial planning and design is scenario study (Veeneklaas and Van den Berg 1994; Schoonenboom 1994; Lindgren and Bandhold 2009). Scenario study combines realism, prediction and imagination to identify robust developments and the ‘no regret measures’ (Dammers et al. 2013). So, in scenario study, the emphasis is not so much on the differences (expressing the uncertainty), but on the commonalities (most likely to happen), the structures, locations and developments that pop up in every scenario. Based on this understanding, the long-term regional vision can be shaped and spatialized by developing adaptive regional design models, e.g. spatial arrangements that express the desired spatial structure of an area.

When the long-term regional vision in the form of a regional design is established, the next question is ‘what do we need to do today to reach this vision and how can we adapt to changing circumstances?’ This question can be answered by a process of backwards reasoning—called backcasting (Fig. 5.8). Backcasting allows planners and designers to determine design strategies and principles and to consider what is realistic, but not necessarily what is realistic today (Robèrt et al. 2012). The focus is on the long-term regional vision, not just the current situation, charting the best possible way in the right direction (Robèrt et al. 2012). Adaptive design principles are powerful means in this regard. A design principle refers to a basic idea or rule that explains or controls how something happens or works. These principles represent generalised design knowledge that is detached from a certain context and is applicable to other contexts (Nijhuis and Bobbink 2012). It offers, as it were, a ‘toolbox’, providing an overview of available design principles with essentials and leaving out particularities (Steenbergen et al. 2008). In that regard, principles are adaptive as they need to be contextualised as well, so they can be adjusted given changing circumstances, while maintaining the focus on the overall objective. So, adaptive design principles can be adjusted according to the context and needs. Design principles can be identified by studying relevant and successful (international) cases. To summarise: the long-term vision in the form of the regional design and the related adaptive principles does not provide a blueprint for the future, but rather guides a more or less open-ended design process in which strategic projects and design explorations play a key role in the achievement of sustainable urban landscapes.



**Fig. 5.8** Process of strategy formation and design explorations while utilising knowledge of the natural and urban landscape, developing a vision, backcasting and identifying adaptive design principles. *Image* Steffen Nijhuis, *illustrator* Shirley Warlich

### 5.3.3 Design Explorations

Design aims towards invention, that is, finding spatial solutions and ‘making them possible’. Spatial design as such translates abstract strategic notions into physical structures and layouts addressing several scale levels. Spatial design is a synthesising activity and is about putting things together rather than taking them apart; integration rather than reduction; it is about relations between things and not the things alone (Meyer 1997; Sijmons 2012). In this respect, design explorations are used as a vehicle to make spatial problems visual, to generate solutions, explore possibilities and to express cultural values by means of spatial form. Design is thus regarded as a process or action that is geared towards exploring and producing. In this process, knowledge from other disciplines, such as ecology, urban planning, cultural history and water management, is spatially translated and integrated (Fig. 5.9). Designing, therefore, plays a role as a thinking/technical tool with which one thinks and acts in a structured way to generate ideas and explore possible solutions. This method is called ‘research through design’ (Nijhuis and De Vries 2019). In research through design, goal-oriented searching is central in a process where thinking and producing go hand in hand. Mechanisms of research and design are combined with imagination, creativity and innovation (Nijhuis and De Vries 2019). During this process, a conscious or unconscious synthesis takes place that in some way precipitates into a visual form, by drawing, mapping or modelling with analogue or digital media.

Design explorations are therefore a powerful research method with which complex spatial challenges can be approached integrally and creatively. A structured design process will be used in which important aspects are clearly revealed and the tasks

**Fig. 5.9** Co-creation of knowledge and ideas for the development of the PRD using a digital map table.  
*Photo Steffen Nijhuis*



are further translated and concretised in spatial terms. The adaptive design principles as formulated in the strategy formation phase are adapted and applied in the local context. Through these design experiments, knowledge is acquired by studying the effects of actively and systematically varying design solutions in a specific context. Spatial design as such helps to identify challenges and potentials of the urban landscape and to suggest possible solutions. This is done by making matters explicit with drawings and sketching the context in which they can be realised. In this sense, the design explorations can also help to identify how stakeholders think about future developments at different scales. By visualising ideas and programmes of requirements and positioning them in the space, one can identify possibilities and limitations and formulate questions that require further investigation. Design results provide a context for conversations and observations about the importance of landscape structures and elements and allow for the discussion of solutions and measures with their spatial qualities. In the context of landscape-based regional design, design explorations are used as a systematic search for possible solutions to a spatial problem. At the same time, the design exploration makes clear which landscape structures and elements, for example from an ecological or cultural-historical point of view, should be preserved too.

### **5.3.4 Action Perspective: Strategic Pilot Projects**

The identification of strategic pilot projects is crucial to realise the ambitions as formulated and mapped in the long-term regional design. In this perspective, a pilot project is an initial and relatively small-scale implementation to prove the viability of the approach, principle or idea, which can be a construction project, an urban or landscape development project or a research project. The regional design usually entails many potential projects varying in scale and focus but are needed to translate

ambitions into reality. The pilot projects can be defined based on local ‘bottom up’ initiatives, usually building on existing initiatives and networks, such as a neighbourhood park, community gardens, a housing project or as ‘top down’ projects that transcend the locality and need regional coordination, such as river regeneration projects and green–blue infrastructure. What the pilot projects have in common is that they contribute to the realisation of the long-term perspective by short-term actions and implementation. The purpose is to think together, contextualise the adaptive design principles through design and implement the ideas in practice. Through the pilot project designers, policy-makers, citizens, academia and industry are, as it were, united in a ‘Community of Practice’ (or ‘Living Lab’) to experiment, co-create and test in a real-life environment, delimited by geographical and institutional boundaries (Maas et al. 2017; Schliwa and McCormick 2017). Experimenting together in a responsible way, monitoring and learning from mistakes, creates an informal space in which innovation is key and everyone is equal (Ahern 2011). This fits well with the social and political conditions needed to arrive at solutions on a policy and practical level. The strategic nature of the pilot projects is expressed by the fact that it should contribute to the realisation of the bigger ambitions in tangible ways, but also in intangible ways by building alliances of stakeholders, to develop governance models that guide and facilitate implementation and leverage innovative business models that are needed for a realistic action perspective.

## **5.4 Towards Adaptive Urban Transformation in the Pearl River Delta**

To achieve a more sustainable urban development in the Pearl River Delta, we implemented the landscape-based regional design approach as described previously. Together with academic and societal partners, such as regional and local governments, international and local planning and design offices, multidisciplinary experts, PhD and MSc students from the involved universities, NGOs and so on, we went through the four key phases of landscape-based regional design in iterative ways. In a collaborative effort, we explored the potential of adaptive urban transformation in the PRD through applying this integrative and multiscale design and planning approach.

### ***5.4.1 Mapping the PRD’s Natural and Urban System***

In order to understand the natural and urban system of the PRD, three maps were constructed based on available knowledge and input from experts and stakeholders. Drawn up in a participatory process, these maps show the core physical structures and characteristic patterns of the PRD to illustrate the dynamic of the territory, the

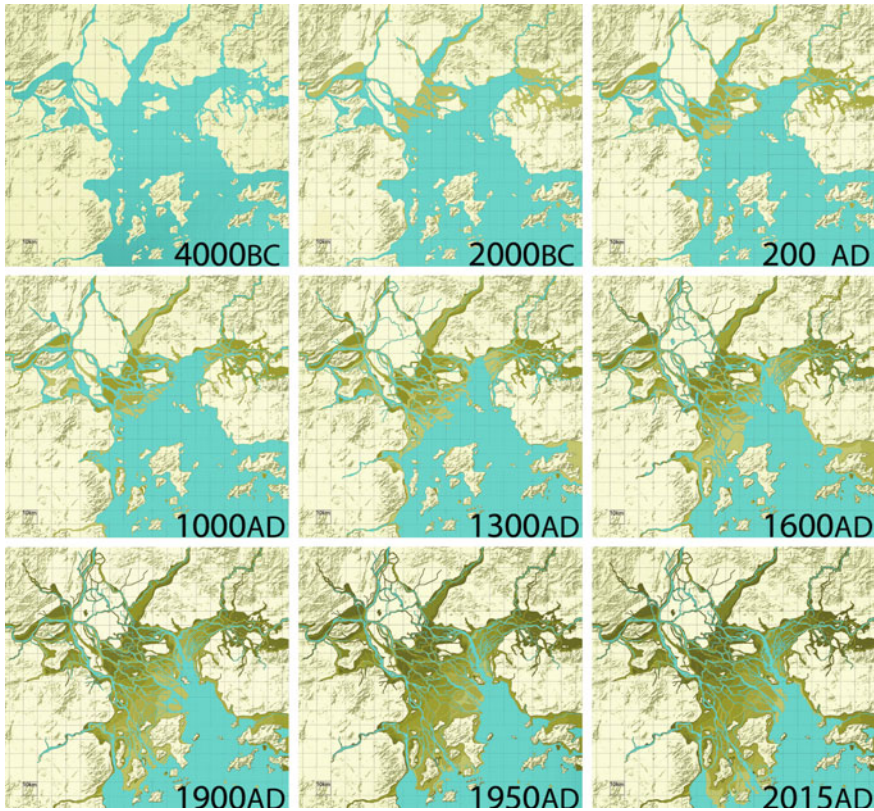
natural and urban system and their interactions. Specifically, they show the eco-agricultural system, the urban system, the infrastructure networks and urban tissue and their relationships.

The basic components of the natural system are the climate, landforms, water and rock type. These drive the formation of soils, determine hydrology as well as the distribution of ecosystems, agricultural land use and historical settlements or cities. The PRD can be divided into two geomorphological types. The western part of the delta is a river-dominated plain formed over the course of the past millennia by natural processes such as siltation and deposition. The estuary to the east is tide-dominated (Xiong and Nijhuis 2018) (Fig. 5.10). Almost 90% of the land in the PRD is flat terrain, with the remaining 10% made up of 160 hills and 187 islands spread around the coast (Huang and Zhang 2004). The deltaic lowland is characterised by two sub-deltas and a tidal estuary. The rivers that dominate the PRD are the West River, the North River and the East River. Together, they form a drainage basin of 453,690 km<sup>2</sup> and have a total length of 2200 kms (Zhang et al. 2008). The most important river in terms of discharge and sediment load is the West River (80% of total water discharge, 90% of total sediment load). Seasonal flooding is a common characteristic in the West and North River sub-deltas, primarily in the period from April to September. The estuary also suffers from extreme tides induced by typhoons or storm surges, mainly occurring in the typhoon season from July to September.

The wet and flat topographical features of the PRD provide favourable conditions for wetland ecology as well as urban development and agriculture, confirmed by the long history of extensive agricultural activities stretching back more than 4000 years. This has proven to be a sustainable human–environment relationship in the ever-changing wetland environment that has arisen through frequent flooding and the continual seaward expansion of the land (Weng 2002; Zhao 2010). Due to the wet and flat conditions of the terrain, the local population developed over many years sophisticated multiscale, water-sensitive farming methods in the warm hot plains known as agri-aquaculture. For centuries, this formed the basis of the local economy. One of the most notable of these methods, developed from the fourteenth century onwards in the sub-deltas, is the dyke-pond system in which fishponds are constructed between dykes bearing fruit trees (Ruddle and Zhong 1988). By the early seventeenth century, the fruit trees were replaced by mulberry trees to facilitate silk production while four species of fish were farmed in the ponds. Subsequently, this type of agri-aquaculture pattern continued to grow and prosper until it hit a peak around the 1920s (Ruddle and Zhong 1988). Today, most of these areas still feature fishponds alongside industrial plots and urban settlements, but almost without silk production.

Reflecting the area's large bays and riparian zones, the natural vegetation in the PRD is largely mangrove forest, wetland and wet forest. While individual mountains and ridges have traditionally hosted dry forests, large swathes of woodland were cut down in previous decades; today, the process of replanting the trees has started. At the foot of the slopes, basins have been established for the supply of fresh water as well as for irrigation (Fig. 5.11).

In the pre-industrial period, the region relied heavily on water-borne transportation. From the 1950s, however, the shift from private to public ownership of land

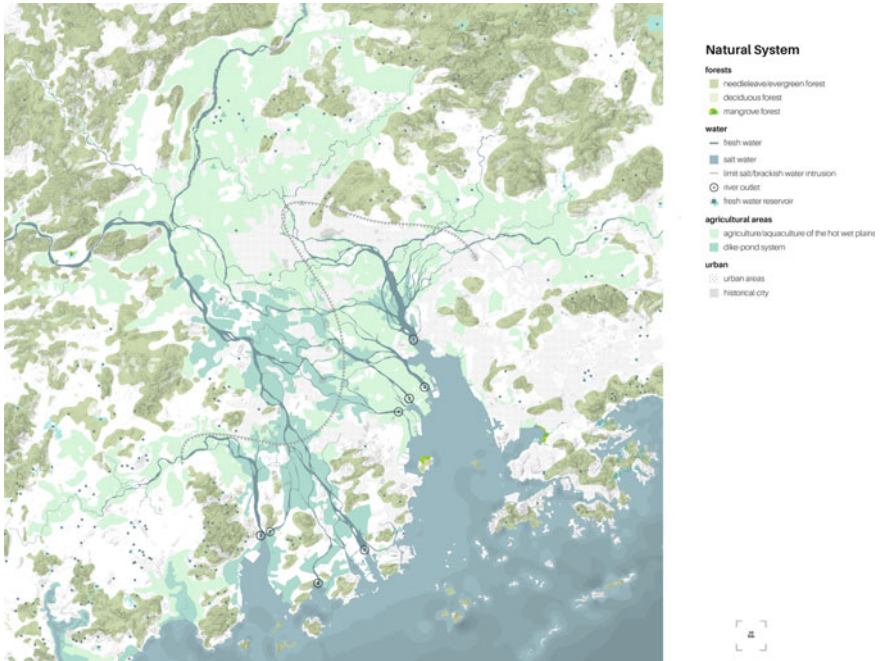


**Fig. 5.10** Landscape formation of the PRD from 4000 BC to 2015 AD. *Source* Xiong and Nijhuis (2018)

enabled major infrastructural developments in the PRD. Large-scale dyke reconstructions (Xiong and Nijhuis 2018), the development of a vast network of (high-speed) train connections and an expansion in road infrastructure all helped to foster the region's rapid urban expansion. Well-developed road and train infrastructure can be found in the corridors from Guangzhou-Shenzhen/Hong Kong and Guangzhou-Zhuhai/Macau. The ports of Hong Kong and Nansha are important transportation hubs, as are the international airports of Hong Kong and Guangzhou (Fig. 5.12).

The histories of ancient cities such as Guangzhou, Foshan and Macau can be traced back more than 2000 years. In Guangzhou, for instance, archaeologists discovered the remains of a large royal garden and palace from around 203 BC, showcasing the rich culture of the Nanyue kingdom (Wu and Chen 2010). It is interesting to note that the historic Lingnan gardens in the Guangdong province, with their traditional architecture, were clearly adapted to the specific climatic conditions regarding site selection, orientation, layout and construction materials, all of which had a positive impact on the microclimate. In general, the cores of these historical cities are all



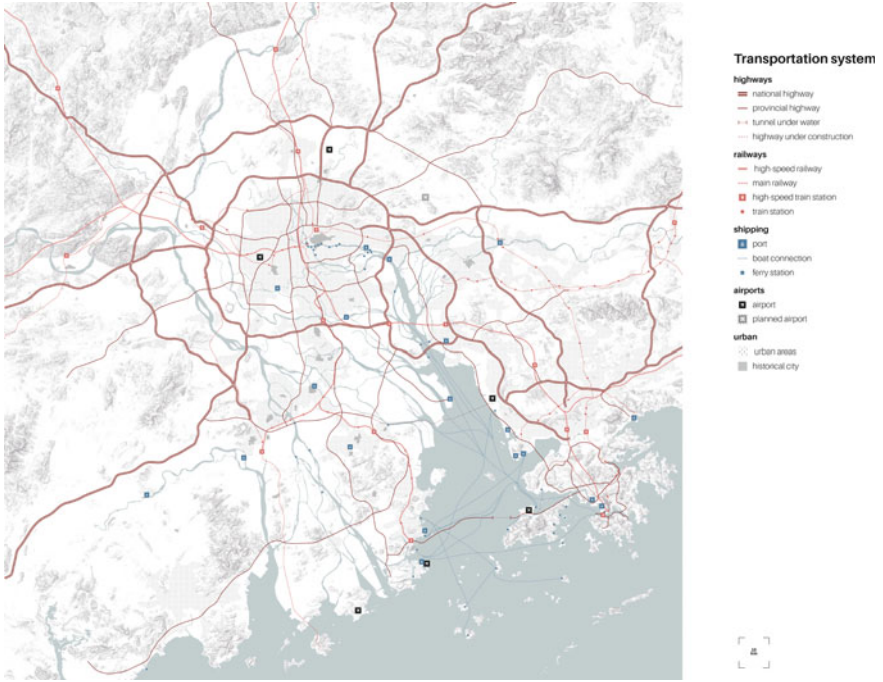


**Fig. 5.11** Eco-agricultural system of the PRD. *Image* Steffen Nijhuis, Daniele Cannatella and Liang Xiong, TU Delft

oriented towards rivers and the coast for strategic reasons as well as to facilitate transportation.

From the 1950s onwards, the historical cities have benefited from infrastructural investment. In the 1980s, China created the PRD Special Economic Zone to attract foreign investment, turning the area into the world’s fastest urbanising delta (Fig. 5.13). This gave the Pearl River Delta a certain degree of autonomy in terms of customs, finance and taxes. Manufacturing companies opened numerous factories, creating a thriving economy. During the process of urbanisation, large areas inside the polders were transformed from farmland into urban settlement. According to the Guangdong Statistical Yearbook of 2016, there are now 60 million inhabitants in the PRD, a figure expected to rise to 80 million by 2030.

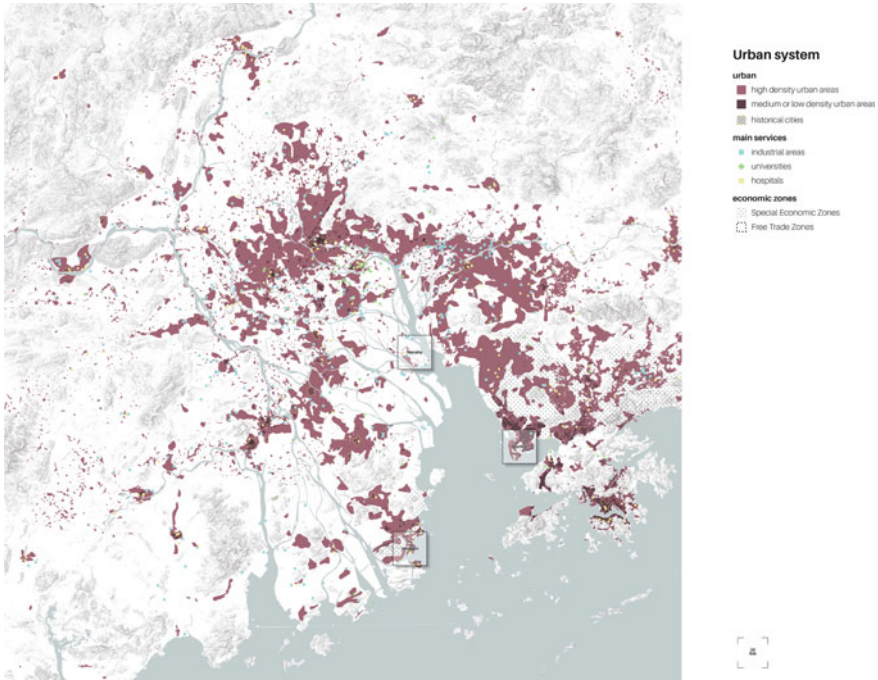
Within this wide-ranging urban development, different spatial patterns can be discerned: in the north, fairly concentric patterns of development are found around the historical town cores; in the east, urbanisation has followed a more linear pattern along the coastline, where new settlement areas are hemmed in by mountain ridges; finally, in the west, we can observe more dispersed patterns, reflecting the traditional polder fields of this area. Today, the epicentre of urbanisation is the urban corridor Guangzhou-Shenzhen, with an important role for Nansha as a connection hub (Fig. 5.14).



**Fig. 5.12** PRD's infrastructural system. *Image* Steffen Nijhuis, Daniele Cannatella and Liang Xiong, TU Delft

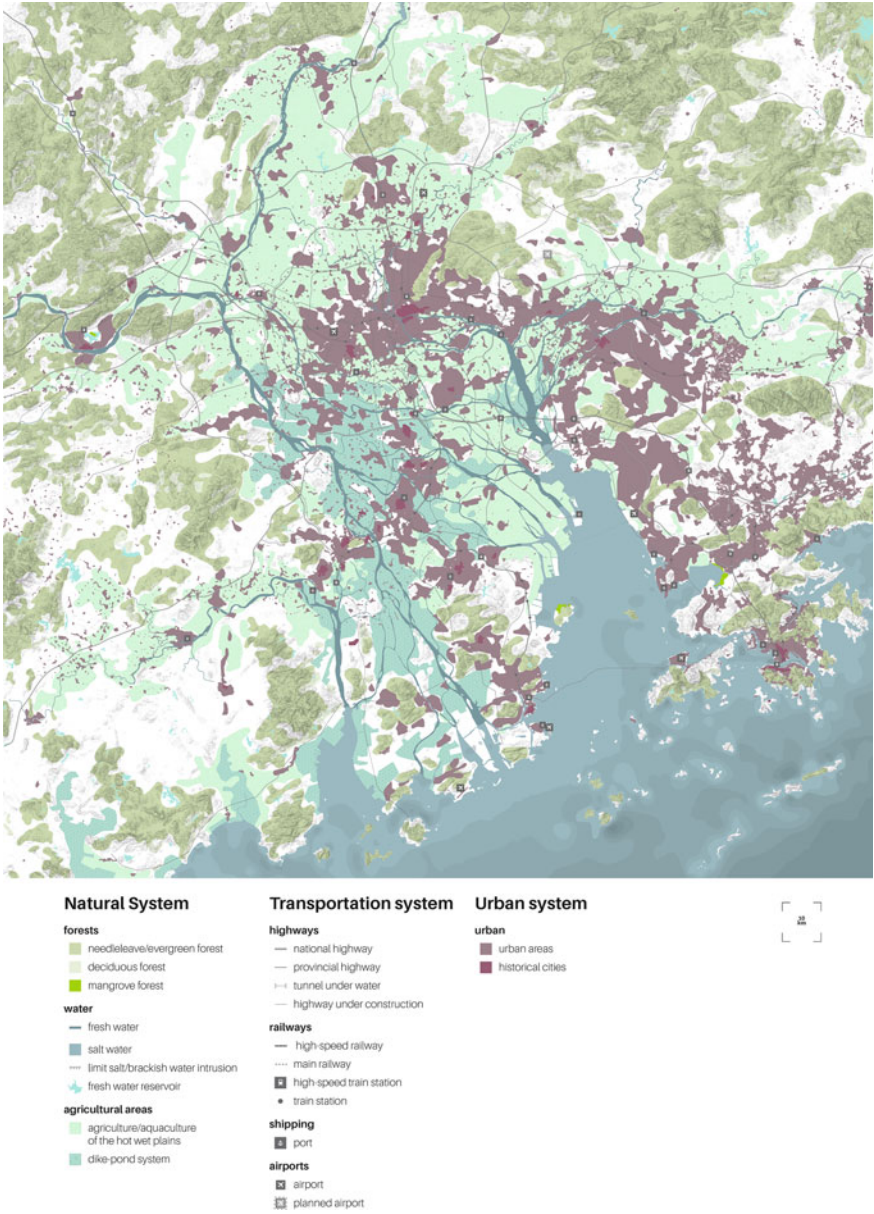


**Fig. 5.13** Urban development from 1950–2015. *Source* Xiong and Nijhuis (2018)



**Fig. 5.14** Structure of the PRD's urban tissue. *Image* Steffen Nijhuis, Daniele Cannatella and Liang Xiong, TU Delft

The synthesis map (Fig. 5.15) shows the urban landscape resulting from the interaction between environmental conditions (e.g. substratum and climate) and the infrastructural networks for transportation, water management and energy. These conditions have paved the way for the development of agricultural land uses and urban settlements, leading to the layer with the highest dynamics of change and transformation. However, the fast pace of urbanisation and climate change has led to some severe problems. Alongside rising sea levels, unprecedented storm surges from typhoons and increased river discharge have resulted in the frequent flooding of urban areas. The risk of flooding has been increased by the canalization of rivers with insufficient capacity to cope with additional discharge. Large farming areas have been transformed into industrial sites and urban areas, thereby greatly reducing their rainwater absorption/storage capacity and thus the ability to mitigate not only the risk of flooding but also water shortages. Natural mangrove forests have been cut down, making coastal areas more vulnerable to flooding. In addition to flooding, the PRD is also suffering from subsidence, saltwater intrusion, smaller areas of farmland (and thus lower food production), socio-economic problems as well as the loss of important ecological and cultural-historical sites. The collective recognition of these challenges and opportunities underlies efforts to realise a more sustainable and inclusive strategy for planning and design in the PRD.

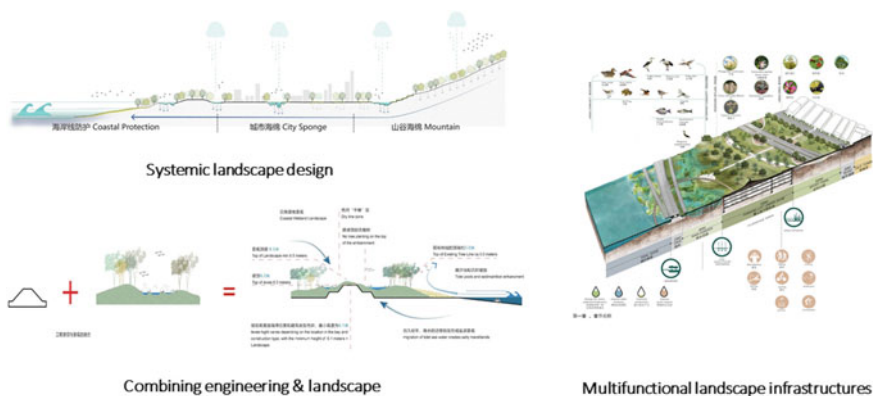


**Fig. 5.15** Urban landscape of the PRD. *Image* Steffen Nijhuis, Daniele Cannatella and Liang Xiong, TU Delft

### 5.4.2 Towards a Sustainable Future for the PRD

Adaptive urban transformations form the basis for a landscape-based regional strategy to address the main challenges and potentials of the PRD. In this strategy, natural and urban dynamics as derived from systems analysis must set the pace and nature of adaptation. The plan development and subsequent implementation will focus on the potential of interlinked economic and ecological development at multiple scales. The goal is to facilitate sustainable transformations of old industrial/housing areas as well as the region’s agricultural landscape, thereby removing constraints on the expansion of built up areas and thus accommodating continued economic and population growth. These areas, which possess good spatial conditions for long-term economic development, are generally located on newly reclaimed land within the delta’s estuaries, featuring a dense network of waterways, vast areas of fishing ponds as well as wetlands and agricultural land; they contain highly sensitive ecosystems and are vulnerable to flooding. In this phase, the possibilities for the development of regional green–blue infrastructure and city-level water networks are identified with the aim of increasing adaptive capacities, ecosystem services as well as water safety. This requires systemic, integral and multilayered solutions combining engineering and multifunctional landscape infrastructures (Fig. 5.16).

Scenario studies have been employed to investigate the PRD’s likely future development. Through a combination of empirical data, forecasting and imagination, it is possible to identify critical key locations, driving forces and likely impacts of future events, whether opportunities or threats (Lin et al. 2020). Together with the assessment of urban landscape growth over time and the evaluation of present spatial development projects in the region, several significant factors of future development have been identified, leading to an initial strategic vision for the PRD. This vision is based on the idea that the PRD will develop into China’s Silicon Valley, with



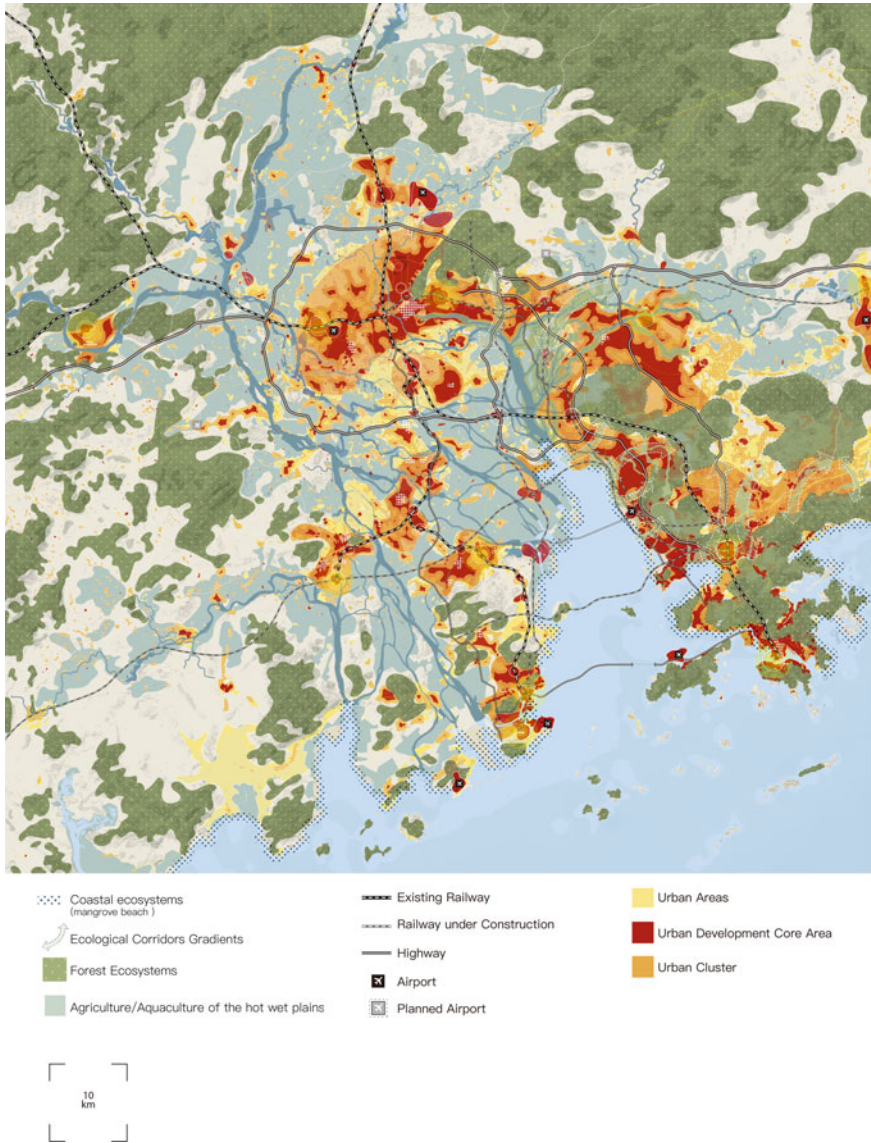
**Fig. 5.16** To increase adaptive capacity, develop ecosystem services and water safety requires systemic, integral and multilayered solutions that combine engineering and multifunctional landscape infrastructures. *Images* Steffen Nijhuis and OKRA landscape architects

strongly developed and well-connected urban qualities, robust green–blue frameworks, cultural-historical assets connected to the region and water-sensitive socio-ecological inclusive urbanism. In this vision, the landscape is taken as the basis for future-proof spatial development of the region addressing climate adaptation as a leverage for integral urban development, employing nature-based solutions for sustainability and water safety, strengthening and extending natural resources and nurturing cultural identity. In our vision, the east wing (Guangzhou-Hong Kong corridor) of the PRD will further develop into a well-connected red-green necklace, where strong urban hubs and marinas alternate with robust green corridors connecting the mountains to the sea. With the development of wet plains, the west wing will be transformed into a blue axis featuring water-sensitive ecological agri-aquaculture and considerable flood retention capacity, complemented by strong urban hubs that benefit from transit-oriented development (TOD) (Fig. 5.17).

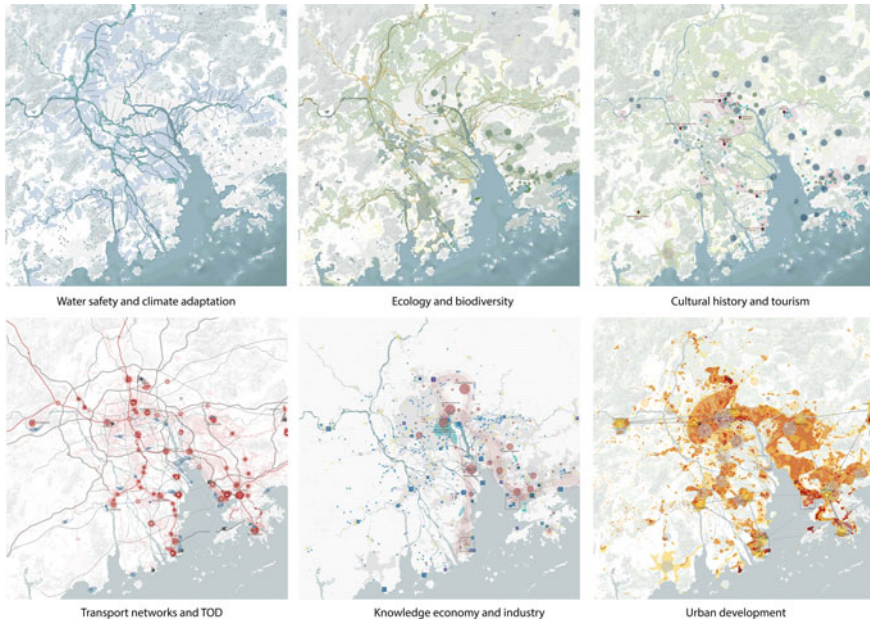
The primary use of the regional strategic vision is to determine priorities in spatial planning and design. Backcasting is used to identify spatial transformation perspectives that help accomplish the objectives set by the strategic plan and guide actions accordingly. The spatial transformation perspectives provide a set of adaptive design strategies that are specific to the challenges and potentials of the territories in the sub-deltas and the PRD estuary. The perspective of each transformation has spatial dimensions: namely, water sensitive and socio-ecologically inclusive, flexible and multifunctional, addressing multiple temporal and spatial scales. We identified and developed the following transformation perspectives regarding:

- Water safety and climate adaptation;
- Ecology and biodiversity;
- Cultural history and tourism;
- Transportation networks and transit-oriented development (TOD);
- Knowledge economy and industry;
- Urban development.

Each of these transformation perspectives are elaborated in regional maps (Fig. 5.18), allocating strategic spatial principles that require local adaptation, but at the same have a regional significance. For water safety and climate adaptation, for example the following strategic spatial principles are indicated: (1) increasing the sponge capacity urban tissue, agricultural land and mountains, (2) multifunctional flood defence and nature-based solutions and (3) building with nature for coastal protection (Fig. 5.19). And for ecology and biodiversity: (1) strengthening and extending natural resources by protecting and creating habitats, (2) connecting ecosystems and making gradual transitions and (3) developing robust urban green–blue multiscale networks (Fig. 5.20). The transformation perspectives also pave the way to more integral ways of thinking and solutions. In the sub-deltas of the PRD for instance, the transformation perspectives are connected to river and rainwater adaptive approaches, resulting in more resilient riverways, integrated agri-aquaculture, sustainable urban transformations, new urban districts, the integration of (historical) villages, industrial transformation and eco-tourism. In the estuary, the transformation perspectives are mainly connected to seawater adaptive approaches, encompassing



**Fig. 5.17** A long-term vision for integral urban landscape development of the PRD. *Image* Steffen Nijhuis, Yimin Sun, Daniele Cannatella and Xie Guangyuan, TU Delft

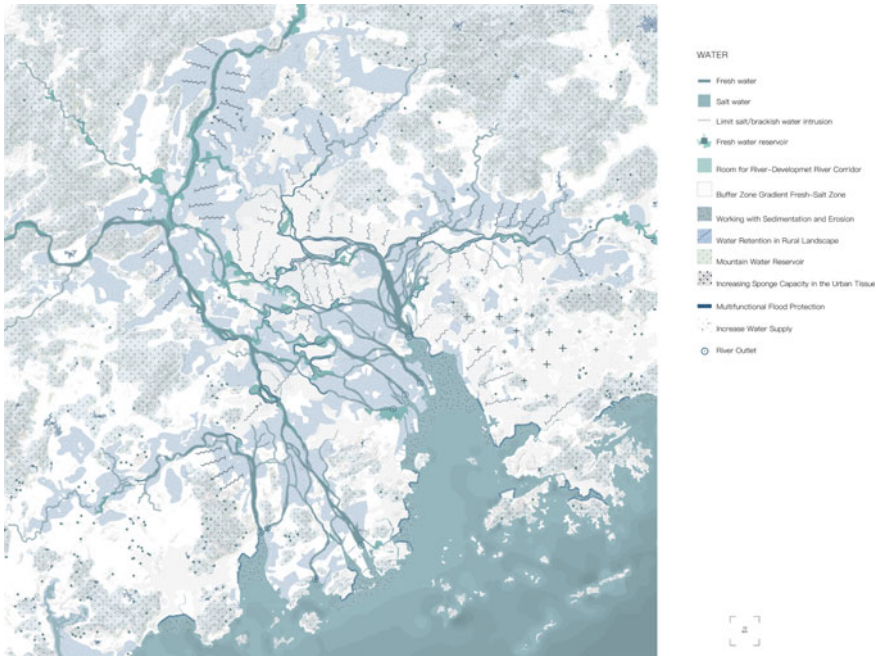


**Fig. 5.18** Six transformation strategies for adaptive urban transformation in the PRD. *Image* Steffen Nijhuis, Yimin Sun, Daniele Cannatella and Xie Guangyuan, TU Delft

multifunctional flood protection, harbour and marina development, land reclamation (sedimentation, erosion), the development and transformation of waterfronts as well as the protection and development of mangroves and other coastal ecosystems.

These are only two examples to illustrate how the transformation perspectives can provide guidance in strategic choices for the long term as well as inform short-term design choices as will be elaborated further in the next section. For each of the strategic spatial principles, sets of design principles can also be developed to provide concrete ‘tools’ for the urban planners, landscape architects and urban designers to translate abstract ambitions into concrete spatial plans and designs (Fig. 5.21). Local adaptation of the various design principles can be tested by research through design while exploring the spatial possibilities of their application and adjusting the principles according to the context and needs. In the framework of this research, these transformation perspectives are further elaborated through pilot projects in the region (Sect. 4.3), concrete design studies for local governments (Figs. 5.22 and 5.23), research projects (Chaps. 11, 12, 13, 14, 15, 16 in this volume), and MSc student design studios (Chaps. 6 and 7 in this volume; Chongwattanaoj et al. 2022; Van Eeden et al. 2021; Qu et al. 2020; Sun et al. 2019).



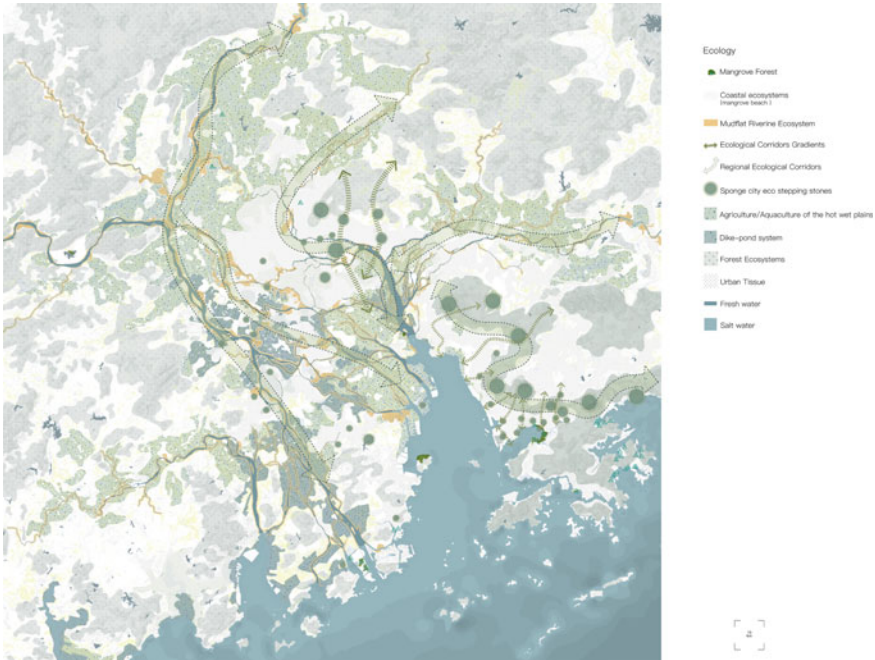


**Fig. 5.19** Transformation perspective for water safety and climate adaptation. *Image* Steffen Nijhuis, Yimin Sun, Daniele Cannatella and Xie Guangyuan, TU Delft

### 5.4.3 *Pilot Projects: Nansha Lingshan Island and Pazhou West District*

Nansha Lingshan Island and Pazhou West District can be regarded as pilot projects in which designers, policy-makers, citizens, academia and industry experimented, co-created and tested the application of strategic spatial principles as outlined in the transformation perspectives in a real-life environment. The purpose was to think together, contextualise the adaptive design principles through design and implement the ideas in practice and to learn from that. In that regard, we proposed and implemented the ‘chief designer system’ to transcend the professional boundaries of architecture, urban design, landscape architecture and project development, and to develop an inclusive platform for negotiation and communication, and to implement adaptive design principles in urban projects (transformation perspective urban development).

The development of grand urban projects is at the core of the chief urban designer system as mentioned in Chap. 1. Through the development and construction of urban districts at a mesoscale (measured by kilometres), it can optimise and correct the detailed control plans, explore and design adaptive urban open spaces and establish a balance between economic development, the integration of cultural heritage, the

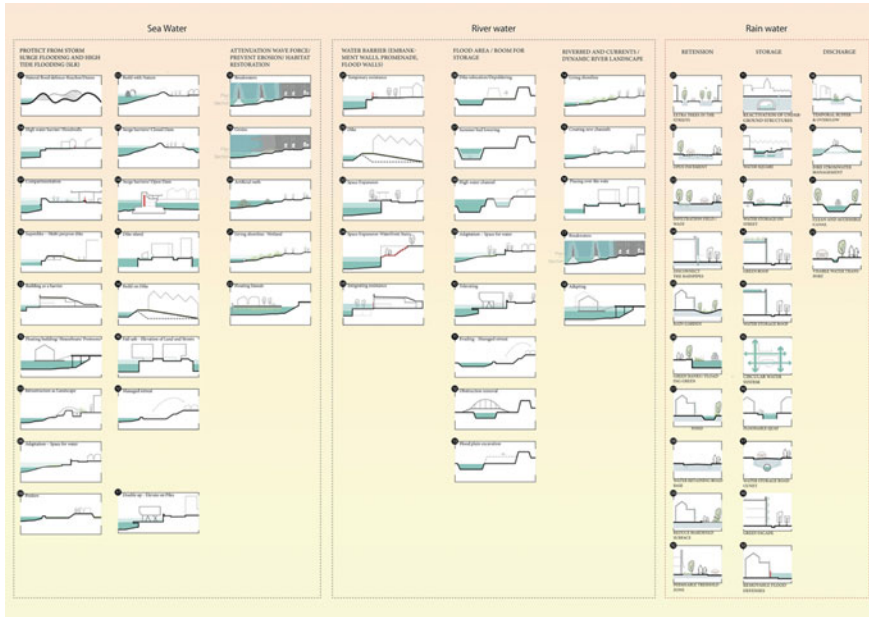


**Fig. 5.20** Transformation perspective for ecology and biodiversity. *Image* Steffen Nijhuis, Yimin Sun, Daniele Cannatella and Xie Guangyuan, TU Delft

creation of a green–blue environment and lively public spaces. On the basis of that, the urban design guidelines are therefore incorporated into the legal control, i.e. into the general contract documents of land transactions, legally secures the contractual binding of the fundamental application of the guidelines and avoids various possible negative impacts. Thus, the urban design guidelines would become the starting point for negotiation and coordination amongst multiple parties, and the chief designer team can seek win–win results through negotiation under the premise of safeguarding public interest and environmental benefits.

*Nansha Lingshan Island*

Lingshan Island is located in the geometric centre of Nansha District in Guangzhou, at the intersection of Jiaomen Waterway, Upper Hengli Waterway, Lower Hengli Waterway and Fuzhou Waterway and Longxue Waterway, with a total area of 103 square kilometres. Nansha District develops into an important city sub-centre of Guangzhou. This CBD is key to the economic development of the region, by introducing financial services, science and technology innovation industries. It has also national significance because it is indicated as a pilot free trade zone, named ‘Guangdong-Hong Kong-Macao cooperation demonstration zone’ (Fig. 5.24).



**Fig. 5.21** Adaptive design principles for water safety and urban development; sea, rain and river water. *Image* Steffen Nijhuis and Xie Guangyuan, TU Delft

Since 2013, the district administration organised the master planning and design of Pearl Bay and simultaneously carried out the building of infrastructural projects. In 2017, the district authority implemented the chief designer system to develop the tip of Lingshan Island. The chief urban designer and his team (also part of the AUT project) facilitated the full planning and construction process and all-round professional consulting services based on urban design, taking into consideration the existing circumstances. The urban design optimisation plan was developed from September 2017 onwards. The modification of the control plan based on the urban design optimisation scheme was authorised in June 2018 and adopted by the Planning Commission. The urban design standards for the development site were originally integrated into the site planning requirements in October 2018. And the urban design optimisation plan eventually passed the administrative assessment in April 2019. The work system of the primary designer of the full process area of the tip of Lingshan Island was announced in February 2020. So far, the urban design and the chief designer system of Lingshan Island has been running for three years and extended to the Hengli Island tip.

With regards to the regional strategy in the framework of AUT, the project has been optimised in several aspects during the urban design optimisation stage in 2019. Firstly, by understanding, respecting and integrating the geological features of the site, we fully used the potential of building height and volume. For example, by employing the logic of the landscape, the designers made use of the characteristics of the deeper more solid geological substrata (granite/gneiss-layer), in this case 50 m



**Fig. 5.22** Design vision for a new urban district in Shantou for the local government co-created in collaboration with national and international experts. *Image* Steffen Nijhuis with OKRA landscape architects



**Fig. 5.23** Visualisation of the vision at eye-level with landscape as natural infrastructure. *Image* Steffen Nijhuis with OKRA Landscape Architects



**Fig. 5.24** Urban development of Nansha District. *Photo Yimin Sun*

below the surface, to increase the average building height to 150–200 m, instead of the initial plans of 80–90 m possible based on the less stable upper geological layers. Based on this structural rationality, the building volume increased by 40% and at the same freeing up space for green–blue public spaces, nature and water. Secondly, based on the existing road network design, a three-level public space system was created to modify the building scope of the plot. In response to the large and irregular division of the plot since 2013, the public space system of ‘public green space–open square within plot–building arcade’ was proposed, adding 66,000 m<sup>2</sup> of public green space, about 25,000 m<sup>2</sup> of open plaza and about 24,000 m<sup>2</sup> of continuous building arcade to the Lingshan Island (Fig. 5.25).

#### *Pazhou West District*

Pazhou West District is an important portion of Guangzhou’s central urban region, Guangzhou compact new CBD, north of the Pearl River, west of Huangpu Chung, east of South China Express, with a total area of 2.1 square kilometres. The area is positioned for the development of headquarters business, the introduction of innovative Internet industry clusters (Fig. 5.26). It is a key site for Guangzhou to establish ‘three centres, one system’ and achieve the optimisation and adjustment of the industrial structure, as well as one of the ten core platforms of the Guangzhou-Shenzhen Science and Technology Corridor in the Pearl River Delta.

In the framework of AUT, the urban design of Pazhou West was based on the idea that should be developed in a compact, intensive, efficient and integral manner based on a framework of roads and robust green–blue public spaces providing extra space



Fig. 5.25 Urban design optimisation of unit C2 of Nansha Lingshan Island. *Image* Yimin Sun



Fig. 5.26 Urban development of Pazhou West District. *Photo* Yimin Sun

for water storage (e.g. rain gardens), shadow and cooling airflows. Next to that, our team was able to protect ecological valuable features (more than 10,000 m<sup>2</sup>), such as wetlands, based on the analysis of the original natural landscape, but also made full use of the existing natural water system and also recovered almost one kilometre of filled river streams. By these actions space for water and nature increased with 38,000 m<sup>2</sup>, which is about 10% more than in indicated in the original plan. In terms of energy

use, we advocated energy-saving urban design adapted to the subtropical climate of Guangzhou. In the design optimisation process, simulation software was employed to evaluate the wind flows, temperature and urban heat island effect of proposed urban layouts. This resulted in the implementation of 15 air corridors, 2000 m of arcades on buildings, 10,000 m<sup>2</sup> of underground commercial space, combined with a high-quality public riverfront, a three-dimensional park platform that connects the headquarters of Tencent, Ali and Vipshop 13,500 m<sup>2</sup> (Fig. 5.27).

Because of the regional design approach, local plot boundaries could be transcended. As a result, multiple urban plots were jointly prepared and constructed reducing the cost of, e.g. foundation pit construction by 45 million RMB through sharing underground protective walls and so forth. In terms of land use, the efficiency of land use is actively enhanced through compact development, with the number of development blocks increased from the original 9 to 19, resulting in an increase of 279,000 m<sup>2</sup> of development floor area to 1,164,000 m<sup>2</sup> compared to the original control plan, which increases local government revenue by nearly 3.9 billion RMB based on an average floor area price of 14,000 yuan per square metres. At the same time, more ecological values and space for water could be integrated in the urban development, as well as the much needed and appreciated climate adaptive green–blue open spaces in these high-density environments.

As demonstrated by the application of AUT to the two pilot projects, the regional design approach exemplified by the chief designer system the urban districts could



**Fig. 5.27** Urban design optimization of Pazhou West District. *Image* Yimin Sun

be developed in a more coherent and coordinated way. This led to financial benefits on the short term but also contributes to a sustainable and socio-ecological inclusive urban region.

## 5.5 Conclusion

The PRD's urban landscape is the result of various processes and systems that display different dynamics of change and which impact each other. The ability to interrelate systems through spatial design has become increasingly important, as the interconnection of different systems, and their formal expression is a fundamental aspect of contemporary regional development. Here, we have advanced a landscape-based regional design as an inclusive planning and design approach for the adaptive transformation of the PRD. In this approach, the interrelation of urban landscape systems and governance through planning and design was helpful to achieve more integrated and resilient governance of deltas. At a time of complex challenges, the development of alternative approaches such as this offers a pathway to realising socio-ecological inclusive design processes as well as modes for collaboration amongst disciplines and stakeholders. This will help to increase the adaptive capacity in urbanising deltas by institutional, cultural and financial innovations that are needed in territorial governance to steer the development of urban and rural areas to achieve more integrated and resilient futures for urban deltas such as the PRD. Landscape-based regional design as an approach proofed to stimulate cooperation between designers, experts, policy-makers, industry and other stakeholders. This led to co-creation of adaptive spatial development strategies and build support for suitable interventions and measures through interactive communication and decision-making in design, planning and management. As a result, established and regular urban transformation processes are used as opportunities to adapt systems in urbanised deltas at relatively low costs.

As demonstrated by the application of this approach, through the chief urban designer system in the pilot projects, this results in cost-saving plans by coordination of actions and joint efforts, as well as considerable financial revenue on the short term by optimisation of the design employing the natural characteristics of the site. More importantly, this adaptive urban transformation led to protection and development of regional green-blue infrastructures and city-level water networks that increases the adaptive capacity of the region, ecosystem services as well as water safety, which will also save cost on the longer term.

In sum, landscape-based regional design brings new operational power to spatial design—as an integrative, creative activity—and recognises the regional urban landscape as a significant field of inquiry, one that is context-driven, solution-focused and transdisciplinary. Furthermore, as an inclusive design approach, it establishes relationships between ecological and cultural factors, between process and form, between long-term and short-term developments as well as between regional strategies and local interventions. As such, landscape-based regional design is a powerful vehicle for guiding territorial transformations in a process of creating local identity



and safeguarding regional relationships, while simultaneously linking ecological and social processes to urban forms. The application of landscape-based regional design offers a way of resolving the conflicts and threats that arise between economic development and environmental recovery, as well as reducing the negative repercussions of climate change.

## References

- Ahern J (2011) From fail-safe to safe-to-fail: Sustainability and resilience in the new urban world. *Landscape Urban Planning* 100:341–343
- Chongwattanaoj A, Chu J, Hussain A, Lu W, Pu Y, Nijhuis S (2022) Resilient coastal landscapes: landscape architecture design explorations in the Pearl River Delta, Ningshao Plain, Mumbai and Bangkok through five MSc-graduation projects. Delft University of Technology
- Dammers E et al (2013) Scenario's maken voor milieu, natuur en ruimte: een handreiking. Planbureau voor de Leefomgeving, Den Haag
- Gill L, Lange E (2015) Getting virtual 3D landscapes out of the lab. *Comput Environ Urban Syst* 54:356–362. <https://doi.org/10.1016/j.compenvurbsys>
- Huang Z, Zhang W (2004) Impacts of artificial factors on the evolution of geomorphology during recent thirty years in the Zhujiang Delta. *Quat Sci* 24:394–401
- Lange E, Hehl-Lange S (2010) Citizen participation in the conservation and use of rural landscapes in Britain—the Alport Valley case study. *Landscape Ecol Eng* 7:223–230. <https://doi.org/10.1007/s11355-010-0115-2>
- Lin W, Sun Y, Nijhuis S, Wang Z (2020) Scenario-based flood-risk assessment for urbanizing deltas using future land use simulation (FLUS): Guangzhou metropolitan area as a case-study. *Sci Total Environ* 739:139899. <https://doi.org/10.1016/j.scitotenv.2020.139899>
- Lindgren M, Bandhold H (2009) Scenario Planning: the link between future and strategy. Palgrave Macmillan, London
- Lu X, Tomkins A, Hehl-Lange S, Lange E (2021) Finding the difference: Spatial perception of planning phases of high-rise urban developments. *Comput Environ Urban Syst* 90:101685. <https://doi.org/10.1016/j.compenvurbsys.2021.101685>
- Maas T, van den Broek J, Deuten J (2017) Living labs in Nederland. Van open testfaciliteit tot levend lab. Rathenau Instituut, Den Haag
- Meyer EK (1997) The expanding field of landscape architecture. In: Thompson GF, Steiner FR (eds) *Ecological design and planning*. Wiley, New York, pp 45–79
- Meyer H, Nijhuis S (2013) Delta urbanism: planning and design in urbanized deltas—comparing the Dutch delta with the Mississippi River delta. *J Urban* 6(2):160–191
- Mintzberg H (1994) *The rise and fall of strategic planning*. Prentice Hall International, London
- Neuman M (2000) Regional design: recovering a great landscape architecture and urban planning tradition. *Landscape Urban Planning* 47:115–128
- Nijhuis S, Bobbink I (2012) Design-related research in landscape architecture. *J. Design Res* 4(10):239–257. <https://doi.org/10.1504/JDR.2012.051172>
- Nijhuis S, De Vries J (2019) Design as research in landscape architecture. *Landscape J* 38(1–2):87–103. <https://doi.org/10.3368/lj.38.1-2.87>
- Nijhuis S, Jauslin D (2015) Urban landscape infrastructures: Designing operative landscape structures for the built environment. *Res Urbanism Ser* 3(1):13–34. <https://doi.org/10.7480/rius.3.874>
- Nijhuis S, Pouderoijen MT (2014) Mapping urbanized deltas. In: Meyer VJ, Nijhuis S (eds) *Urbanized Deltas in transition*. Technepress, Amsterdam, pp 10–22

- Nijhuis S, Xiong L, Cannatella D (2019) Towards a landscape-based regional design approach for adaptive transformation in urbanizing deltas. *Landsc Arch 风景园林* 170(9):8–22. <https://doi.org/10.14085/j.fjyl.2019.09.0008.15> (Chinese)
- Nijhuis S, Xiong L, Cannatella D (2020) Towards a landscape-based regional design approach for adaptive transformation in urbanizing deltas. *Res Urban Ser* 6:55–80. <https://doi.org/10.7480/rius.6.94>
- Nijhuis S, Thissen P, Storms-Smeets E (2023) Resilient estate landscapes Gelderland. In: Past, present, future. Jap Sam Books, Amsterdam
- Nijhuis S (2015) GIS-based landscape design research. Stourhead landscape garden as a case study. Delft: A+BE. <https://doi.org/10.7480/abe.2015.13>. ISBN 978-94-6186-568-7
- Nijhuis S (2022) Landscape-based urbanism: cultivating urban landscapes through design. In: Roggema R (ed) *Design for regenerative cities and landscapes. contemporary urban design thinking*. Springer Nature, pp 249–77. [https://doi.org/10.1007/978-3-030-97023-9\\_11](https://doi.org/10.1007/978-3-030-97023-9_11)
- Qu, L, Li, Y, Ghini, M, Mukkamala, T, Peng, B, Mohamed Rani, M, Wu, J, Zhao, X, Nijhuis S (2020) Landscape approach Greater Bay Area, China: landscape architecture explorations in the Pearl River Delta, Beijing and Jakarta through eight MSc-graduation projects. Delft University of Technology
- Robèrt KH et al (2012) Sustainability handbook: planning strategically towards sustainability. Studentlitteratur
- Ruddle K, Zhong G (1988) *Integrated agriculture-aquaculture in South China: the Dike-Pond System of the Zhujiang Delta*. Cambridge University Press
- Schliwa G, McCormick K (2017) Living labs: users, citizens and transitions. In: Evans J, Karvonen A, Raven R (eds) *The experimental city*. London, pp 163–178
- Schoonenboom I (1994) Overview and state of the art of scenario studies for the rural environment. In: Schoute JF et al (eds) *Scenario studies for the rural environment*. Kluwer Academic Publishers, London etc., pp 15–24
- Sijmons D (2012) Simple rules. emerging order? A designer's curiosity about complexity theories. In: Portugali J et al (eds) *Complexity theories of cities have come of age: an overview with implications to urban planning and design*. Springer, Berlin, pp 281–309
- Steenbergen CM, Meeks S, Nijhuis S (2008) *Composing landscapes: analysis, typology and experiments for design*. Birkhäuser, Basel
- Sun C, Nijhuis S, Bracken G (2019) Learning from agri-aquaculture for multiscale water-sensitive design in the Pearl River Delta. *Landsc Arch 风景园林* 170(9):31–44. <https://doi.org/10.14085/j.fjyl.2019.09.0031.14>
- Tomkins A, Lange E (2020) Bridging the analog-digital divide: enhancing urban models with augmented reality. *JoDLA J Digit Landsc Arch* 5:366–373. <https://doi.org/10.14627/537690037>
- Van Eeden EA, Gao M, Liu Y, Sun Y, Qi K, Zheng Y, Nijhuis S (2021) Designing coastal interfaces: landscape architecture explorations in the Pearl River Delta, the Haringvliet and Pekalongan City through six MSc-graduation projects. Delft University of Technology
- Veeneklaas FR, van den Berg LM (1994) Scenario building: art, craft or just a fashionable whim? In: Schoute JF et al (eds) *Scenario studies for the rural environment*. Kluwer Academic Publishers, London etc., pp 11–13
- Weng QH (2002) Land use change analysis in the Zhujiang Delta of China using satellite remote sensing, GIS and stochastic modelling. *J Environ Manage* 64:273–284
- Wu L, Chen W (2010) Historic site of the Nanyue Kingdom Palace. Guangzhou
- Xiong L, Nijhuis S (2018) Exploring spatial relationships in the Pearl River Delta. In: Ye X, Liu X (eds) *Cities as spatial and social networks*. Heidelberg, Springer
- Zhang Q, Xu C, Gemmer M et al (2008) Changing properties of precipitation concentration in the Pearl River basin, China. *Stoch Environ Res Risk Assess* 23:377–385
- Zhao Y (2010) The remote sensing dynamic monitoring of the evolution of Shoreline and Mangrove Wetlands in the Zhujiang River Estuary in the Past 30 Years. *Remote Sens L Resour* 22(suppl):178–184

**Open Access** This chapter is licensed under the terms of the Creative Commons Attribution-NonCommercial 4.0 International License (<http://creativecommons.org/licenses/by-nc/4.0/>), which permits any noncommercial use, sharing, adaptation, distribution and reproduction in any medium or format, as long as you give appropriate credit to the original author(s) and the source, provide a link to the Creative Commons license and indicate if changes were made.

The images or other third party material in this chapter are included in the chapter's Creative Commons license, unless indicated otherwise in a credit line to the material. If material is not included in the chapter's Creative Commons license and your intended use is not permitted by statutory regulation or exceeds the permitted use, you will need to obtain permission directly from the copyright holder.



# Chapter 6

## Design Studios as Method for Exploring Complex Challenges in the Pearl River Delta



Daniele Cannatella and Steffen Nijhuis

**Abstract** This chapter draws on three different design studios that focus on the Pearl River Delta to discuss what kind of knowledge has been generated within them, and how they can be used systematically as a method to address the region's complex challenges. The three studios differ in their objectives, duration and structure, but are linked by a research-through-design approach. A selection of some illustrative outcomes is presented and structured around three types of knowledge—project based, form based and idea based—which is typically produced in the design process. This knowledge refers to four main aspects through which it is possible to describe the complexity of the urban landscape, namely time, space, causality and materiality and can be either contextual or generic. Nonetheless, within a design studio, it can be systematically employed to support research activities, speeding up the development of research programmes dealing with complex issues, such as adaptation of fast urbanising deltas.

**Keywords** Research through design · Complex challenges · Design studio · Spatial design education

### 6.1 Introduction

In landscape architecture, as in other disciplines dealing with spatial issues, spatial design is a key activity for investigating the transformative potential of the urban landscape and exploring solutions to enhance its capacity to cope with the increasing uncertainty arising from the combined action of climate change and urbanisation.

Spatial design as a research strategy—often referred to as *research through design*—is a valuable way to address wicked problems such as climate adaptation

---

D. Cannatella (✉) · S. Nijhuis  
Faculty of Architecture and the Built Environment, Delft University of Technology, Julianalaan  
134, 2628 BL Delft, The Netherlands  
e-mail: [d.cannatella@tudelft.nl](mailto:d.cannatella@tudelft.nl)

S. Nijhuis  
e-mail: [s.nijhuis@tudelft.nl](mailto:s.nijhuis@tudelft.nl)

© The Author(s) 2023  
S. Nijhuis et al. (eds.), *Adaptive Urban Transformation*, The Urban Book Series,  
[https://doi.org/10.1007/978-3-030-89828-1\\_6](https://doi.org/10.1007/978-3-030-89828-1_6)

in urban systems (Nijhuis and Bobbink 2012; Roggema 2014). When framed as a research activity, spatial design entails searching for and generating new knowledge through the conception, implementation and execution of a plan. This is a creative process, outlined by coherent goals and structured around clear means of achievement (Nijhuis and de Vries 2019) to coherently and holistically address the complexity arising from the multiplicity of social, cultural, economic, spatial, ecological, administrative and organisational instances and the mutual relationships they establish among themselves (Klaasen 2004). In turn, this multitude of systems forming the urban landscape has distinct spatial domains and is marked by different evolutionary trajectories that require solutions aimed at their synchronisation over time (Meyer and Marchand 2015).

For this reason, the ability to establish a constant and fruitful dialogue amongst different disciplines, sectors, stakeholders and decision-makers is a prerogative of spatial design, as it sets the common ground for actors from different backgrounds and having different interests to take joint action in pursuing shared visions towards more desirable futures. At the same time, it demands the systematic implementation of approaches, methods, strategies and tools that can ensure a high degree of flexibility to operationalise such visions.

In this perspective, design studios are at the core of learning and education in spatial design disciplines, as they provide students with structured guidance and scientific rigour, while simultaneously offering a free environment where to spawn new knowledge through the active stimulation of creativity and invention in investigating and unravelling possible futures by means of design (Hinterleitner et al. 2021).

In addition to their pedagogic importance, design studios are a valuable resource for the research field. As Armstrong (1999) pointed out, they constitute ‘valid peer-reviewed research which contributes to the scholarly growth of spatial disciplines, adding to the general body of knowledge’, particularly when employed as a tool to investigate a broader research problem. In such circumstances, they act both as a stimulus to the research process or as a trigger to initiate research.

The outcomes produced in such a particular setting are manifold. They can be used to understand the conditions under which landscapes have developed in a specific way; can address specific solutions to the spatial challenges that characterise a specific socio-ecological context; or can serve as an inspiration, stimulating reflections and critical thinking on the design process itself.

However, what kind of knowledge do they generate, on what aspects, and in what form? What are the conditions for which this knowledge can be systematically integrated into research?

This contribution addresses these questions making use of the outcomes of three design studios connected or related to the Pearl River Delta (PRD). The three studios are different in terms of topics, goals, setting and duration. Nonetheless, they share the main premises and the overall design-oriented approach. They all look through different scales simultaneously, in order to connect them through the development of coherent, scalable and replicable design principles. Applied to the PRD, this implies a view that ranges from the regional scale—in addressing the urbanised

delta both as an administrative/economic entity, influenced by global dynamics, and a physiographical unit, as a deltaic landscape—down to the local scale, where the spatial, ecological and social implications of design choices materialise and people can experience them through their senses.

Furthermore, they are structured according to a multidisciplinary approach, with a strong interconnection among landscape architecture, regional design, urban design and planning fields.

This contribution elaborates on a selection of the outcomes of the design-related strategies developed within these studios, to reflect on the added value the latter have in producing systematic knowledge that can be beneficial for research. The article is structured as follows: Sect. 2 discusses the value of design studies in the teaching of spatial disciplines as a form of work; Sect. 3 introduces the three design studies related to the AUT project; Sect. 4 elaborates on the type of explorations carried out and the outputs generated in different contexts; Sects. 5 and 6 discuss the results and the implication of the findings.

## 6.2 Design Studio as a Work Form

In landscape architecture and urbanism education, design studios are powerful tools enabling students to explore ideas and produce spatial designs while generating particular forms of knowledge that can be specific to the context addressed within the studio or generic.

A design studio as means for education in landscape architecture offers multiple benefits, for both students and tutors. Firstly, it recreates the conditions and dynamics of professional practices in a relatively safe, student-centred environment, constituting the ideal bridge between academic training and working life; secondly, within a design studio, students are stimulated to deal with real-world issues and challenges, elaborate and critically evaluate spatial solutions and strategies that can find an application in a given real context; finally, design studios often offer the opportunity to interact with real stakeholders and professionals through workshops and presentations, challenging students to present their ideas in a clear, concise and persuasive manner. These conditions ensure constant learning and reflection throughout the whole design process throughout the duration of a studio.

Dynamic working, problem solving and interaction with experts are the elements of the typical setting of a design studio that serve as inspiration for the students. Such setting offers the ideal environment where pupils' imagination, creativity, fantasy and invention are encouraged and guided. Through a constant feedback loop between research and design, students' knowledge is broadened, enabling them to expand and refine their thinking, to create new relations between what they know and what they learn and consequently master the products of their fantasy (Munari 1998). In this regard, the free and informal environment that a design studio provides allows students to test their skills and step out of their comfort zone, use different methods and tools, and develop new design approaches, ideas and concepts.

Moreover, the design journey within a studio is not a solitary act. The knowledge of the people involved is put into system through a co-creation process engaging pupils and mentors since the studio's early stages, to generate shared perspectives and trajectories. This represents an added value for the learning process, as besides the professional experience and the acquisition of specific technical expertise students can develop fundamental 'soft' skills ranging from the ability to work in a team—the division of tasks and time management—to the communication of design choices and argumentation of their project.

Lastly, design studios provide the opportunity for experimenting new design approaches and techniques, as well as teaching methods. Instructors take part in all respects in the design team, acquiring different roles—as mentors or more experienced colleagues—playing a more interactive role and sharing knowledge not only on a theoretical level, but also on a practical one. Teachers structure in a reasoned manner activities and tasks envisioning ideal end products and outcomes that have to be delivered in a limited time. These activities are planned through a programmatic series of meetings, workshops and presentations over a timeframe that can span from a few days to several months to generate insights through design and integrate the results into broader planning and policy-making processes.

When framed in such fashion, design studios can be easily combined with research, following the idea of research through design. This process typically follows the research-by-design's three-phase structure (analysis-synthesis-evaluation) bringing about knowledge that can be integrated as part of a larger research programme (Armstrong 1999). Acting as arenas where students and tutors work together in a research partnership, to investigate problems and generate speculative ideas through a design process, exploring propositions on both the physical and social domains, to render them into abstract forms.

In a design studio, the knowledge of all those involved is brought into a co-creation process in an early stage, to produce common perspectives and structure design research. The latter involves the systematic investigation of strategies, procedures, methods, routes, tactics, schemes and modes through which people work creatively. Design involves the testing of ideas, materials and technologies. It involves innovative conceptual development, product evolution and market modification. It also involves research into cultural, social, economic, aesthetic and ethical issues (Strand 1997).

### **6.3 Three Design Studios on the Pearl River Delta**

This section presents three different design studios, all of which have the PRD as their objective of study. The studios are characterised by different disciplinary outlooks, although inevitably the topics addressed within each of them overlap. The adaptive urban landscape graduation studio offers a privileged investigative perspective on the role that the landscape plays in suggesting spatial strategies and solution enabling the conditions for sustainable urban development in the PRD. The Globalisation studio has a strong focus on spatial planning and social justice; whereas the Pazhou Island

**Table 6.1** Design studios

Design studio	Main topic(s)	Duration	Spatial scales
Adaptive urban landscape graduation studio	Landscape-based regional design; adaptive urban transformation	1 year	From regional to district
Globalisation studio	Globalisation; spatial planning	10 weeks	From regional to district
Pazhou Island design workshop	Landscape and urban design	1 week	District

design workshop revolves around the urban design assignment for the Pazhou district, in Guanzhou. The three studios differ on topics, scale of investigation and design output (see Table 6.1). Nonetheless, in all three cases, the PRD serves as an exemplary case for the complexity of the spatial challenges it presents to designers from many points of view: the economic development ambitions of this deltaic region make it one of the most vibrant areas in the world, in constant and swift transformation. At the same time, the most pressing questions revolve around the most pressing urgencies revolve around the impact of human activities on a vulnerable territory, on which the effects of climate change are being increasingly felt. Furthermore, in each of them participants were asked to investigate how spatial transformations at different scales can offer safe and quality spaces and without neglecting the environmental, historical and cultural values that characterise the whole delta. The following subsections briefly describe the objectives and settings of the studios.

### 6.3.1 *Adaptive Urban Landscape Design Studio*

The adaptive urban landscape design studio was set to explore landscape-based design approaches for adaptive urban transformation in fast urbanising deltas, making use of the PRD as a case study. The studio relied on design as a research strategy to explore landscape architecture principles for climate adaptation, social inclusion, industrial and agricultural heritage redevelopment and ecological restoration through an integral approach among governance, knowledge development and spatial design. The studio is part of the Flowscape MSc graduation studio at TU Delft within the Landscape Architecture master track (Nijhuis et al. 2012; Nijhuis 2020, 2021).

Within the studio, students were free to choose their topic depending on their interest to develop their project over a year. They kick-started their individual research projects by framing a set of research questions aiming at (1) defining the natural, economic and cultural factors and conditions that have led to a certain type of development of the urban landscape over time and through different spatial scales, as well as the relative challenges that need to be addressed; (2) understanding the relevance of nature-based approaches and solutions, exploring design principles that can fit to the context; (3) testing the effectiveness of latter in the PRD context by translating



them in the form of spatial design assignments; and (4) reflecting on the lessons learned through the application of the design experiments, their relevance and their replicability in other contexts.

Within such framework, design principles were derived through the investigation of both theory and practical cases, based on the review of relevant literature in the field of landscape architecture and exemplary international case studies. Experiments were conducted throughout the whole graduation work, using real-time cases and sample areas and shared in dedicated workshops in which students could present their progress and findings and receive feedback from peers and tutors.

### **6.3.2 *Globalisation Studio***

The MSc elective studio on regional design ‘globalisation’ is a joint programme of Delft University of Technology (TUD), faculty of Architecture and the Built Environment, Department of Urbanism and the Polytechnic University of Hong Kong PolyU Design, supported by the International Forum of Urbanism (IFoU).

The main goal of the studio was to develop inclusive spatial approaches, concepts and strategies jointly addressing socio-economic and environmental challenges to draw possible future planning scenarios for the PRD as a global economic player.

The outcomes of the studio fall mainly within the domain of spatial planning, but at the same time are thoroughly entangled with landscape architecture and urban design, in an interdisciplinary fashion. Students worked in groups of four to build a sound theoretical framework with the aim of investigating the current regional trends in the light of globalisation and metropolitisation of the delta and develop spatial visions at the regional scale for the future development for the area.

The unfolding of spatial visions was supported by the development of analytical frameworks and subsequently accompanied by the definition of strategic goals and actions addressing different contexts, ranging from urban to rural areas. The measures proposed were structured according to timelines and accompanied by stakeholder analysis.

### **6.3.3 *Design Workshop on Pazhou***

The design workshop on Pazhou, held in Guangzhou in 2019 and hosted by the South China University of Technology (SCUT), was organised within the AUT project. The aim of the workshop was to develop a spatial vision based on a landscape approach for the Pazhou Island. Pazhou is a sub-district of Haizhu, in south-eastern Guangzhou, that is today part of the city’s downtown area. The area hosts the Guangzhou International Convention and Exhibition Centre, as well as rural and fishermen villages and cultural heritage such as the Pazhou Pagoda, built in 1600. For its proximity

to the central business district (CBD), Pazhou has been redeveloping as high-end commercial, residential and offices areas (Shin 2016).

The workshop, lasting five days, was supported by various activities, such as site visits and lectures held by professors, researchers and local administrators on both theoretical approaches and the state of regional and local planning in the PRD.

Master's students, PhD Students and researchers from the three universities part of the AUT consortium were organised in groups of five to six people and worked together to develop masterplans in the form of drawings and sketches, starting from a set of analytical maps on the main systems (e.g. water, landscape, topography, mobility, land use, urban functions) existing in the area. The designs were used to test a set of adaptive principles on stormwater management and riverine flooding protection, that could support preserving enhancing the elements of cultural value in the area. Ultimately, each group presented their findings to other participants to receive feedback.

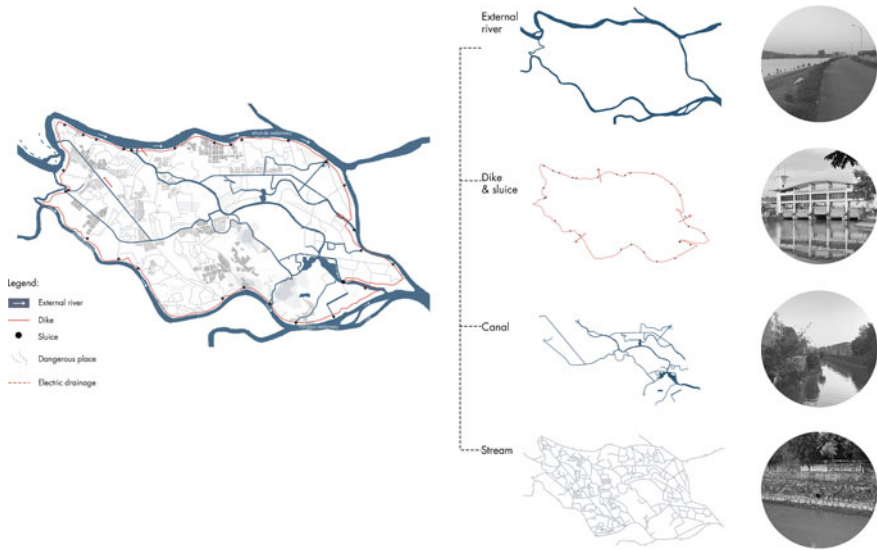
## 6.4 Results

In this section, the outcomes of the activities carried out in the above-mentioned design studios are gathered according to the nature of the different explorations and used as examples of what kind of knowledge is generated through them. For this purpose, the latter are clustered here according to three types of design explorations (cf. Nijhuis and de Vries 2019): project-based, form-based and idea-based explorations. Each of these explorations address four major overarching blocks related to both spatial design process and narrative, namely space, time, causality and materiality. These are the main blocks through which the knowledge produced in addressing the complexity of the PRD urban landscape.

### 6.4.1 *Project-based Explorations*

Project-based explorations have privileged view of the context under study. These approaches investigate and describe the spatio-physical, ecological or cultural features characterising a territory. The main purpose of the adaptive urban landscape studio was the exploration of landscape-based approaches for adaptive urban transformation in the PRD. For this reason, the first step carried out by the students required the understanding of both the natural and anthropogenic systems that make up the urban landscape in the delta.

This implied the investigation of the current spatial and physical configuration of some of these systems (e.g. the water system, mobility network, land use), which in turn was an essential step for the subsequent elaboration of tailor-made design principles to increase the adaptive capacity of the urban landscape to counteract and mitigate the impacts of flooding. This kind of analysis, which takes shape in the form



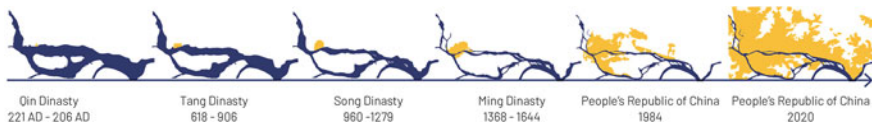
**Fig. 6.1** Existing water management system in Shunde district. *Image* Yijing Li, TU Delft

of descriptive maps, is fundamental to understand the functioning of the site, identify the areas vulnerable to flooding and pinpoint those with high transformational potential that can play a role in the structuring of green–blue networks, as in the case of Shunde (Fig. 6.1). Shunde is located in the hinterland of the PRD and suffers from waterlogging by rainfall due to the uncontrolled industrialisation and increasing soil sealing.

Here, the water management system has been decomposed in multiple layers depicting the main waterways surrounding the study area, the flood defence system, made out of dykes and sluices protecting from and regulating the water flow and the main canals and streams crossing the site. In the main map, these layers are superimposed on the urban system to investigate the spatial relationships among water and the urban environment. In this way, it has become easy to discern the current state of the water system, the degree of continuity and connectivity of the blue network, the spatial distribution and the hierarchies among the different natural and urban elements.

This kind of knowledge can be complemented with the temporal analysis on the co-evolution of specific systems (Fig. 6.2).

In this example, the development of the urban areas is taken as the object of investigation in relation to the water system in specific periods from 200 AD to the present day, highlighting the increasing reduction of the amplitude of the river pattern due to urbanisation in Guangzhou, especially from the 1980s. Looking at this series of comparative temporal maps, it is easy to reconstruct how the urbanisation process has in fact altered the natural structure of the water network, especially since the 1980s, when the economic reforms initiated.



**Fig. 6.2** Historical timeline of the water and urban systems in Guangzhou. *Image* Margherita Ghini, TU Delft

### 6.4.2 *Form-based Explorations*

Form-based explorations aim to visualise, test and evaluate design choices through the development of proposals and their consequent assessment with respect to functional, socio-cultural, ecological and aesthetic impacts. In this regard, visualisation plays a prominent role. Within the three studios, drawings were developed in the form of diagrams, landscape representations, sections and bird's-eye views. In this regard, these visual devices are not for their own sake. Rather, they support the understanding on how the resulting spatial configurations look, and how they would behave under different circumstances, for example under the shifting water levels and climate conditions (Fig. 6.3).

This sheds light on the effectiveness and flexibility on the elaborated solutions, by taking into account the temporal cycles and processes of natural systems to evaluate the capacity of the proposed design to cope with the uncertainty arising from climate change and allow for adaptation to different flooding scenarios.

In a similar fashion, masterplans and sections support the knowledge of how spatial solutions are translated and materialised into space, and what opportunities they provide to enhance environmental, social and economic processes.

Figure 6.4 shows how four layers of investigation (water, industrial transformation, mobility and public space) are integrated into one system, resulting in a new industrial park where the water network is redesigned to restore the ecological values of the site, and the existing facilities are given a new meaning through their reuse. By applying adaptation principles such as water collection, water purification and water reuse, water retention capacity of the area is enhanced, while at the same time the newly created park provides several functions and programmes grafted on different landscapes where people can experience nature and witness the historical traces left by industry.

Sections for water collection, water purification and water reuse (Fig. 6.5) show how topography, water, vegetation and the open space work together in supporting water management and what is the resulting final landscape, providing a hint of how the succession of spaces works, what types of edges exist in proximity to water features, patterns of vegetation serving multiple ecosystem services and their spatial relations with the built environment.



**Fig. 6.3** a Bird's-eye view of the proposed masterplan for the eastern side of Pashou Island; and b diagrams showing how the site changes with changing water levels and climatic conditions. *Images* Jiayun Wu, TU Delft

### 6.4.3 *Idea-based Explorations*

Explorations based on ideas may be strategic or conceptual. In strategic explorations, the problem is structured and addressed by proposing feasible solutions; conceptual explorations, on the other hand, are characterised by more speculative approaches that may seek extreme conditions or be driven by imagination and poetics. For instance, within the Globalisation studio, students were asked to formulate a vision for the PRD towards 2035. Unlike the adaptive urban transformation studio, the main focus was on the sustainable socio-economic development of the delta. Therefore,

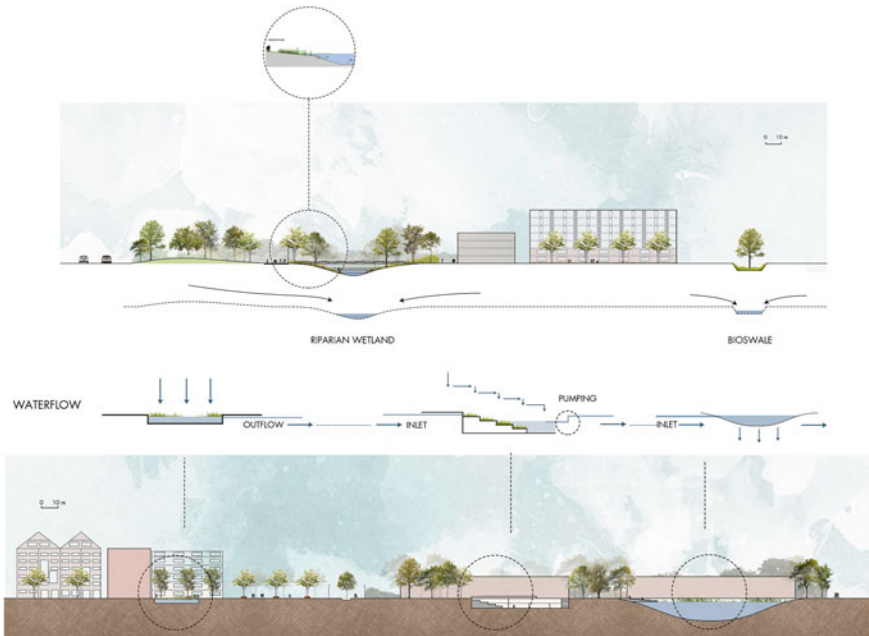


**Fig. 6.4** Masterplan for the proposed industrial park in Shunde. *Image* Yijing Li, TU Delft

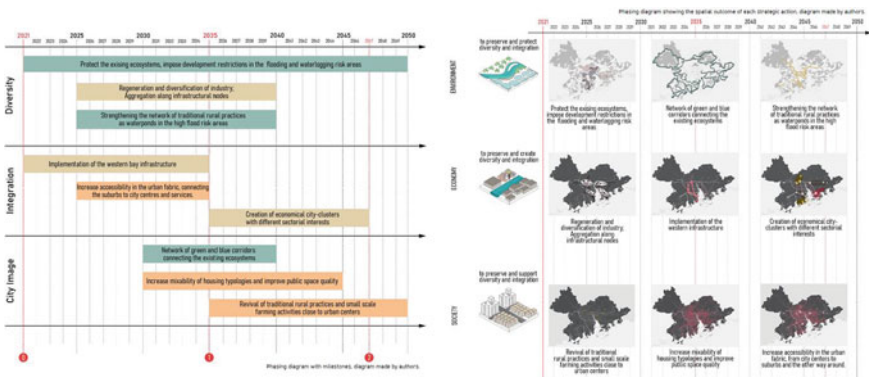
spatial strategies entailing economic and functional relationships in the urban environment have been developed, supported by plans structured around feasible actions and policies to be implemented.

The development of a phased time plan is helpful in determining how the identified strategies may unfold over time to meet the envisaged overarching objectives (Fig. 6.6). This helps to elucidate how the proposed strategies may work together, what synergies may emerge both in space and time, and what potential conflicts or impediments may arise in achieving the final objectives. Furthermore, it supports the definition of priority actions and policies to be implemented to initiate transformation processes and those without which the plan cannot be further carried out.

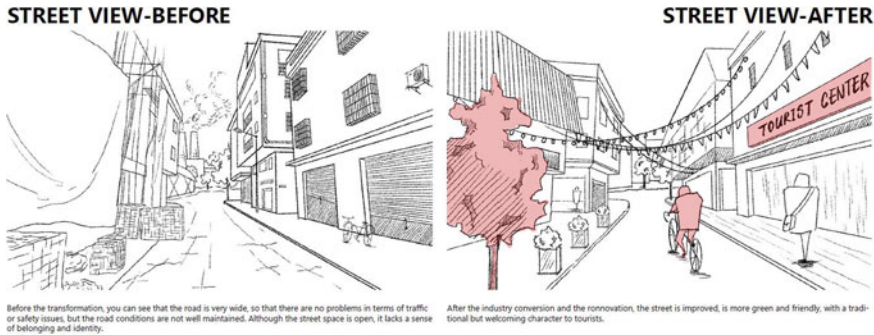
Drawing and sketches have been employed to visualise how certain policies proposed on a larger scale can be translated into smaller-scale designs, generating positive impacts on the quality of the built environment. Figure 6.7 shows how a street lacking maintenance and sense of identity (on the left) can be transformed through simple interventions, such as planting trees along the road, repaving it and adding tourist activities in place of abandoned workshops in an urban village.



**Fig. 6.5** Sections for water collection, purification and reuse for the proposed industrial park in Shunde. *Image* Yijing Li, TU Delft



**Fig. 6.6** Diagram showing the phasing of strategic actions. *Image* Nadya Chabayevski, Patrick Maurer, Pingyao Sun, Keyan Tang and Bowen Yuan, TU Delft



**Fig. 6.7** Sketches showing how a road changes after the proposed interventions. *Images* Yan Liang, Isabella Trabucco, Francien Fons, Yuru Chou and Xinqi Yao, TU Delft

## 6.5 Discussion

The examples presented in this chapter show how design studios can facilitate the production and sharing of new knowledge in different forms through a research-by-design approach.

This sort of knowledge, belonging to the designer's culture, is produced within a studio and becomes an integral part of the design process taking shape through different explorations. It is translated into spatial visions, proposals, strategies and solutions which in turn are supported by original methods and tools and based on the ability to conceive socio-ecological structures and processes embedded in space.

However, to be used systematically in research, such knowledge must be explicit, debatable, transferable and accumulable (Manzini 2009). In other words, it must be communicated in a clear and transparent manner and made available to anyone interested in discussing it; it must provide conceptual and operational tools for other designers who want to apply it and must be the point of departure for other researchers willing to produce further knowledge.

To meet these criteria, design studios must be set up to promote a scientific approach in the knowledge production process. This entails keeping a certain degree of generalisation, where selection and reduction processes are necessary to describe and interpret the systems through which the real world is decomposed, to define similarities and/or peculiarities of a given context; furthermore, reflections and considerations are based on a deliberate thought process where relations and conclusions are drawn consciously and logically (Klaasen 2004; Huisman 1996) and are shared to be subjected to verification/falsification.

In this sense, even a design workshop condensed into a week's work, such as the one on Pazhou, can generate stimulating results which can be used as input in a broader research. The work carried out in parallel by the different groups and presented in a plenary session managed to quickly create a consensus on which spatial, cultural and ecological instances are to be taken into account in the design process.



**Fig. 6.8** Presentation and deliberation of ideas through schematic drawings at the conclusion of the Pazhou Island workshop. *Photo* Daniele Cannatella



Most of the projects aimed at preserving the fishing villages along the Huangpu-chong River, on the southern bank of the island, and at creating water retention areas connected to the water network on the site. Some other design principles, such as softening the edges of the riverbanks, have found their place at various points along the borders of the island. The same applied to urban development, which each group interpreted differently. The presentations then generated a debate on where and how best to build on the site, and for what reason (e.g. densification versus preservation of green areas; favouring ecological processes versus finding the most appealing areas for developers, etc.) (Fig. 6.8).

Throughout the process activated within a design studio, rationality and creativity are totally complementary, with creative intuition acting as a trigger enabling scientific discovery and scientific rigour channelling creativity to enhance and exploit the innovative aspects of the act of designing.

The outputs of the three design studios are manifold: they range from analytical drawings and synthesis schemes to design strategies, concepts, design principles, masterplans or guidelines which aim to provide answers to the leading research questions. The latter may be overarching, specific to the context or thematic. Either way or in analogy with the type of explorations, these can be grouped into three broad categories of knowledge, as depicted in Table 6.2: project-based knowledge, form-based knowledge or idea-based knowledge (Nijhuis and de Vries 2019).

Project-based knowledge has to do with the context and focuses on understanding the conditions (environmental, socio-economic, functional, political and so on) that determine the nature of the project. In the case of Shunde, for example the analysis of the water system determines the critical areas on which to intervene in order to redesign a continuous blue network to which a system of green, permeable spaces can be pivoted to guarantee a greater buffer capacity for water, connecting the existing open spaces to the areas that can potentially be redeveloped.

Form-based knowledge implies the ability to realise and make judgements about the spatial qualities of the projected urban landscape, but also on how the latter

**Table 6.2** Types of knowledge (Nijhuis and de Vries 2019, adapted from Grocott 2010)

Project based	Situational	Engaging in deliberation concerning the legal, political, cultural, functional, economic and ecological context of the design task.
	Integrated	Creating a synthesis of contradictory interests, changing restrictions and conflicting agendas while working with various actors, applying diverse methods and operating in a variety of fields.
Form based	Visual	The development, fabrication, proposal and translation of ideas into words and images.
	Material	The assessment, exploration and realisation of qualities of urban and landscaping schemes and technical constructions, in consideration of the aesthetic, functional and ecological consequences of design choices.
Idea based	Conceptual	The production of ideas and proposals with space for poetic and speculative approaches that promote imagination and unexpected proposals.
	Strategic	The assessment of the situation and the creation of future plans; the problem is structured and defined based on the feasible solutions that have been proposed.

changes with changing circumstances. In a way, it is an exploration of how a given spatial configuration behaves in different scenarios. When it comes to adaptation strategies, it means testing design choices against changing water conditions, as in the case of the project on the Eastern side of the Pajou Island developed within the adaptive landscape transformation studio.

Idea-based knowledge can be either strategic or conceptual. In the first case, the understanding and assessment of the initial conditions is preparatory to the development of a plan that can dictate the directions of spatial development, but also how this may occur over time. This kind of knowledge becomes even more relevant in the light of increasing uncertainty due to the unpredictability of climate change impacts on urban systems, in supporting the investigation of what social, economic, ecological and climate conditions are necessary for the proper implementation of a plan, and how to build (or avoid when possible) the right circumstances through actions and policies linked to each other, according to a logic of incremental development.

All findings produced within the framework of the studios contributed to stimulate and steer strategic discussion directly related to the AUT project, whether they were proposals to be developed and integrated into the development of specific projects, approaches supporting the understanding of the state of the art and the implementation of design ideas, or design tools for the adaptation of the deltaic landscape of the PRD.

## 6.6 Conclusion

Although very different in their objective, structure, spatial scales addressed and duration, the three design studios presented in this contribution share a common thread that unites them and gives food for thought on the way in which designers address the complexity of urban systems through spatial design.

Firstly, in their attempt to grasp and address the reality in which the students were confronted, the kind of knowledge generated within the studios were led by research intentions focusing on the development of design solutions that find an application in the PRD context (specific knowledge) or it was derived from the meta-analysis of multiple studies (generic knowledge). Either way, design studios provided students with a structured guide to knowledge generation. This occurred at all stages of the design: from data collection and interpretation to the investigation of possible design alternatives and their subsequent evaluation.

Space, time, causality and materiality are the four guiding 'blocks of thought' through which students as young professionals are challenged to think, describe and intervene on the real world.

Secondly, a well-formulated research question helped students throughout the whole design process. Formulating sharp research questions serves to narrow down the research scope, to guide information gathering (i.e. to define the spatial and temporal scales worth investigating and their resolution), to understand processes and relationships between systems and elements (i.e. to designate and prioritise cause-effect dynamics and define challenges and opportunities arising from such interactions), and to support the development of plans and perspective for action. However, especially at the beginning of a workshop, this exercise can be puzzling for students. Group presentations and feedback from peers and tutors can give them a helping hand to start the design process, which in turn is a feedback loop constantly subject to adjustments and reduction.

Thirdly, the knowledge generated at the different levels (based on designs, forms, and ideas) is highly interconnected. Solutions that respond to a specific context are to some extent abstractable, as long as the defined criteria are made explicit and the conditions under which the approaches, methods and tools used can be replicated are clear. In complex areas such as the PRD, due to the multiplicity of spatial scales, landscapes and actors, this aspect is crucial to reflect on the extent to which certain plan choices, principles and implementation strategies can be upscaled or replicated in other areas of the region presenting similar characteristics to the case study used.

Finally, the systematic knowledge generated throughout the studios an support research in several ways: on the one hand, it enables the validation and refinement of both analysis and design methods, as it provides several practical cases on which to test them. On the other hand, the possibility of sharing and discussing tangible outcomes supported by drawings, schemes, models and diagrams makes it easier and faster to create common ground for different perspectives, speeding up the development of research programmes dealing with complex issues, such as the adaptation of fast urbanising deltas.

## References

- Armstrong HB (1999) Design studios as research: an emerging paradigm for landscape architecture. *Landscape Rev* 5(2):5–25
- Grocott L (2010) Design research & reflective practice: the facility of design oriented research to translate practitioner insights into new understandings of design. PhD dissertation, RMIT University
- Hinterleitner J, Daamen T, Nijhuis S (2021) Design studio performance in complex spatial projects: lessons from the Netherlands. *J Urban Des* 26(6):1–18. <https://doi.org/10.1080/13574809.2021.1917986>
- Huisman P (1996) Kennis gewogen: analyse van sociaal-wetenschappelijk denken: kritiek en aanwijzingen. PhD dissertation
- Klaasen IT (2004) Knowledge-based design: developing urban and regional design into a science. Delft University Press, Delft
- Manzini E (2009) New design knowledge. *Des Stud Elsevier Ltd* 30(1):4–12. <https://doi.org/10.1016/j.destud.2008.10.001>
- Meyer H, Marchand M (2015) New perspectives on urbanizing deltas. MUST, Rotterdam
- Munari B (1998) Fantasia: invenzione, creatività e immaginazione nelle comunicazioni visive. Laterza Editore, Bari
- Nijhuis S, Bobbink I (2012) Design related research in landscape architecture. *J Des Res* 10(4):239–257. <https://doi.org/10.1504/JDR.2012.051172>
- Nijhuis S, Jauslin D, de Vries C (2012) Flowscales: infrastructure as landscape, landscape as infrastructure. Graduation Lab Landscape Architecture 2012/2013. TU Delft. Retrieved from <http://resolver.tudelft.nl/uuid:d0f262d9-ab07-4ae7-839d-782727c534af>
- Nijhuis S, de Vries J (2019) Design as research in landscape architecture. *Landscape J* 38(1–2):87–103. <https://doi.org/10.3368/lj.38.1-2.87>
- Nijhuis S (ed) (2020) Landscape approach greater bay area, China: landscape architecture explorations in the Pearl River Delta, Beijing and Jakarta through eight MSc graduation projects. TU Delft. Retrieved from <http://resolver.tudelft.nl/uuid:c2ad69f8-8c59-4372-9bf4-272cbc39c457>
- Nijhuis S (ed) (2021) Designing coastal interfaces: landscape architecture explorations in the Pearl River Delta, the Haringvliet and Pekalongan City through six MSc-graduation projects. TU Delft. Retrieved from <http://resolver.tudelft.nl/uuid:bab4d63e-063c-41f8-8985-c864ff74668e>
- Roggema R (2014) Swarm planning: the development of a planning methodology to deal with climate adaptation. <https://doi.org/10.1007/978-94-007-7152-9>
- Shin HB (2016) Economic transition and speculative urbanisation in China: gentrification versus dispossession. *Urban Stud* 53(3):471–489. <https://doi.org/10.1177/0042098015597111>
- Strand D (1997) Research in the creative arts. Report prepared by Canberra School of Arts for DEETYA

**Open Access** This chapter is licensed under the terms of the Creative Commons Attribution-NonCommercial 4.0 International License (<http://creativecommons.org/licenses/by-nc/4.0/>), which permits any noncommercial use, sharing, adaptation, distribution and reproduction in any medium or format, as long as you give appropriate credit to the original author(s) and the source, provide a link to the Creative Commons license and indicate if changes were made.

The images or other third party material in this chapter are included in the chapter's Creative Commons license, unless indicated otherwise in a credit line to the material. If material is not included in the chapter's Creative Commons license and your intended use is not permitted by statutory regulation or exceeds the permitted use, you will need to obtain permission directly from the copyright holder.



# Chapter 7

## Unrelenting Change



Peter Bosselmann, Mathias Kondolf, and Jiang Feng

**Abstract** This chapter revisits the locations of six urban design proposals in the Pearl River Delta that were completed and presented to decision makers. Starting in 2007, proposals were completed with successive groups of young design professionals from the University of California at Berkeley and the South China University of Technology in Guangzhou. Our work over the years addressed two major regional concerns: water management strategies in low-lying delta communities and design proposals to counter-displacement of residents forced out by large-scale land redevelopment processes. The first concern led us to design strategies that address tidal and riverine flood risks when combined with seasonal monsoon events; the second concern addressed the social and economic future of residents in rural and urban communities by proposing small-scale community-driven responses versus medium to large-scale land re-adjustments that became typical in the fast-growing delta region since the 1980s. In evaluating our past work, we compare and analyse present conditions at six locations. The conclusion of our analysis points to the fact that our work over the years has reduced some of the potential harm to communities, but that only more deliberate planning decisions could produce sustainable solutions in the long term.

**Keywords** Urban design · Water management strategies · Design explorations · Landscape transformations

---

P. Bosselmann (✉) · M. Kondolf  
College of Environmental Design, University of California at Berkeley, Wurster Hall, Berkeley,  
CA 23094720, USA  
e-mail: [pbossel@berkeley.edu](mailto:pbossel@berkeley.edu)

M. Kondolf  
e-mail: [kondolf@berkeley.edu](mailto:kondolf@berkeley.edu)

J. Feng  
School of Architecture, South China University of Technology, Wushang Road,  
TianheGuangzhou 381510640, Guangdong, China

## 7.1 Introduction

When China opened its economy to investments from abroad in 1978–1979, two cities in the vicinity of Hong Kong and Macao became the initial focus of the central government's attention. Partly because of their deep-water ports, Zhuhai, adjacent to Macao, and Shenzhen, adjacent to Hong Kong, were selected as special economic zones. These two towns were expected to attract investments. A second strategy was to connect to the widespread network of Cantonese natives and their offspring in a worldwide diaspora. The Cantonese had migrated to places all over the world: to the Americas, but also to Malaysia and Singapore, where industrial development started earlier than in China. The strategies worked, and investments started to flow towards China. The two cities transformed from small towns to prefecture-level cities. Soon after, the government extended the investment zone to expand beyond the initial cities of Shenzhen and Zhuhai to all of Guangdong Province. That resulted in a conurbation of mega cities in Guangdong Province. They include Guangzhou, Shenzhen, Zhuhai, Foshan, Dongguan, Zhongshan, Jiangmen, Huizhou and Zhaoqing, as well as the two special administrative regions Hong Kong and Macau. These eleven cities surround the Pearl River Delta, with a total urbanised area of 56,000 square kilometres and a population of 72 million residents, or well over 300 million if migrant workers are counted. The Greater Bay Area, as it is now called, is the largest and most populous region in China. Its geography is frequently compared to the Tristate New York Metropolitan Area, the Greater Tokyo Area or the San Francisco Bay Area.

Since the opening of China to foreign investments forty years ago, an entire generation grew up amidst unrelenting change. The use of the word unrelenting was repeatedly voiced by professionals tasked with managing change in the Pearl River Region. For planning and design professionals, the management of change at the scale of a region remains a major challenge. The profession is better equipped to evaluate change in retrospect, rather than at the time when current development decisions are made. Change in the environment follows three dimensions: the magnitude of change, pace of change and the nature of change. Assessing the first two dimensions provides no problem to professionals aided by quantitative data on population growth, constructed floor space, roads, bridges, rail lines and GDP in general. By such measures, the magnitude of change in the Pearl River Delta has been large, even unprecedented. Initially, by the same measures, the pace of change has been great, in recent years somewhat slower, but still impressively rapid. More difficult to assess has been the nature of change. Thinking about the nature of change invites qualitative assessments that differ within social groups and the values individuals hold depending on the stage of their life cycle, their place of origin, their economic situation and their level of education.

In the Pearl River Delta, these dimensions of change take on a higher level of complexity when we consider the natural processes that act on the region. Landform, with its vegetation, water and climate have been far from static. Throughout history, the confluence of the three Pearl Rivers, with their high silt content, has added to and subtracted from the landform of the delta. Likewise, the water discharge differs

significantly between the three rivers. This resulted in shifting water flows throughout the extensive network of interconnected waterways between the rivers. The amount of rainfall during the monsoon season dictated agricultural surplus and shortfalls. With more land covered by factory buildings and more roadways and space for cars, run-off after rain events is no longer absorbed into the ground but needs to be stored until it can be channelled into the river's branches at low tide.

The cities of the Pearl River Delta owe their existence and prosperity to the tides that made the river system navigable for larger vessels. Mariners since medieval times have taken advantage of the incoming tide to reach the Pearl River Delta's largest city, Guangzhou, located 120 kms inland from the South China Sea. They used the outgoing tide for the journey out to sea. High tide in the Pearl River Delta remains something to be reckoned with, especially when the tide amplitude measures higher than normal during the lunar cycle and coincides with a major monsoon event. Such combined events were well recorded throughout the Ming and Qing dynasties. Storms produced major floods in history and more frequently now as sea level continue to rise from melting polar ice and the thermal expansion of water molecules as a result of warming ocean temperatures.

The extent of these natural phenomena is well understood. There is also growing research about social change in the Pearl River Delta Region. But, both fields of knowledge only made slow progress in forming policy aimed to guide planning and design for a sustainable future of the region. This chapter presents design proposals at six locations in the Pearl River Delta Region that were completed over a period of years from 2007 and compares them with conditions in 2021.

The most striking change revealed on the latest satellite images is the one by one kilometre grid of multilane highways laid onto agricultural land. New roadways became dividers of once continuous space. A square kilometre can easily contain a historic village, but only if the grid cells are centred on villages. That is not how the grid was laid out. Roadway design shows a bias for regularity and straightness; the grid only curves when aiming at important obstacles. Rarely do roadways curve around villages. Apparently, roadway engineers assumed that villages would no longer exist in the future.

This observation is certainly true for the first site we worked on in 2007–2008, Dadun village in the dyke and pond landscape south of Foshan. The village is easily recognisable from space. Slated for demolition at the time of our work, Dadun is still there, though truncated by two major roadways. To take credit for the continued existence of Dadun might be premature. Credit should go to the members of the village collective and their high level of organisation.

## **7.2 Dadun: A Village in the Dyke and Pond Landscape**

Dadun, together with a string of six villages, was settled on somewhat higher ground to the north of the historic Yandu River, today better known as one of the historic Lecong waterways. To encourage rural settlements and rice production, the Song



and the later Yuan dynasty started levee construction to control the braided network of free-flowing rivers in the delta in the late thirteenth century. Foshan, a historic city to the north of Dadun, close to Guangzhou, also originated on elevated land. It grew into a large industrial city famous for its ceramics and later for ironware production. With the opening of Guangdong Province to economic development, Foshan became a prefecture city in 1983 and expanded into agricultural land owned by village collectives in the Shunde municipality. In 2003, a design competition was awarded to a US planning firm; it proposed the removal of Dadun and three neighbouring villages (Fig. 7.1). Foshan's new ceremonial axis of cultural and sports facilities aimed directly at Dadun. Foshan made partial use of the competition results. With much confidence, highway engineers laid a one by one kilometre grid of major multilane roadways over the agricultural land with a new bridge on axis across the Dong Ping River. The roadway continued on the other side of the river, directly towards Dadun. Dadun's village collective resisted and construction of the roadway stopped (Figs. 7.2 and 7.3).

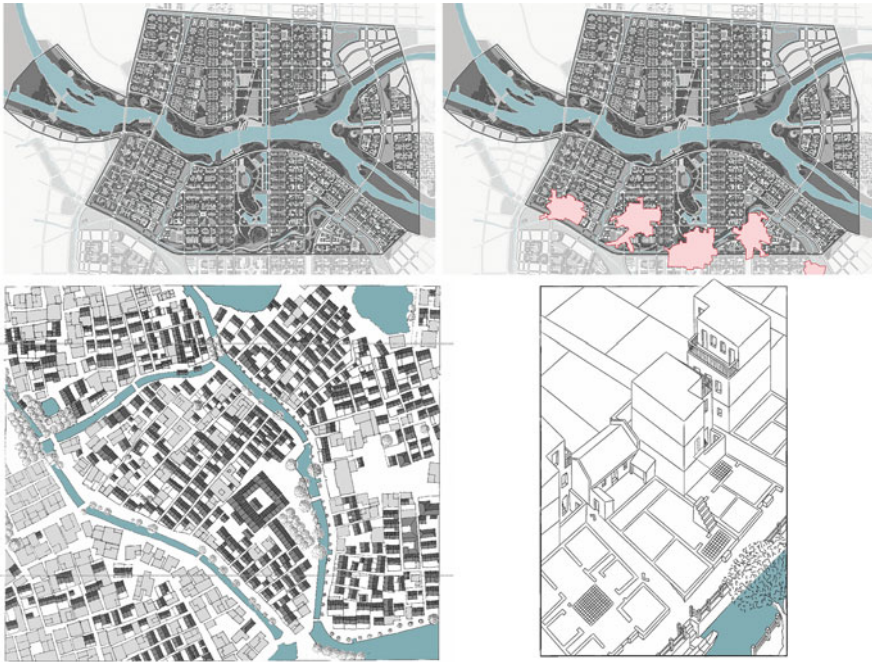
### ***7.2.1 Managing Flood Risks and Water Quality***

Our team started by talking to the chairman of the village board, Liang Jinghua. As part of a village history, Liang recorded floods that had inundated Dadun from 1915 to 1988 (Liang 1988). For example, water stood 2.5 m high in 1915, in 1924 knee deep, in 1962 a levee failed and water stood 2.3 m above the land. Villagers took refuge on the second and third floor of buildings, an experience that has motivated the construction of multi-storey buildings in delta villages since.

Earlier flood records existed for a one-hundred-year period from 1736–1839, when 44 major floods were recorded: one every 2.4 years. This sequence of floods triggered improvements to flood control measures during the Qing dynasty (1644–1912): higher levees were constructed with weir-gates to divert high water into canals. But with rapid urbanisation floods continued. Most recently, so called one-hundred-year floods occurred in 1994, 1998, 2005 (Zhang 2008) and onwards in 2010 and 2018.

Recognising that agricultural work at Dadun had shifted towards factory work, our team recommended a water landscape of lakes made from obsolete fishponds and restored canals designed to retain riverine as well as monsoon caused floodwater until it can be discharged at low tide.

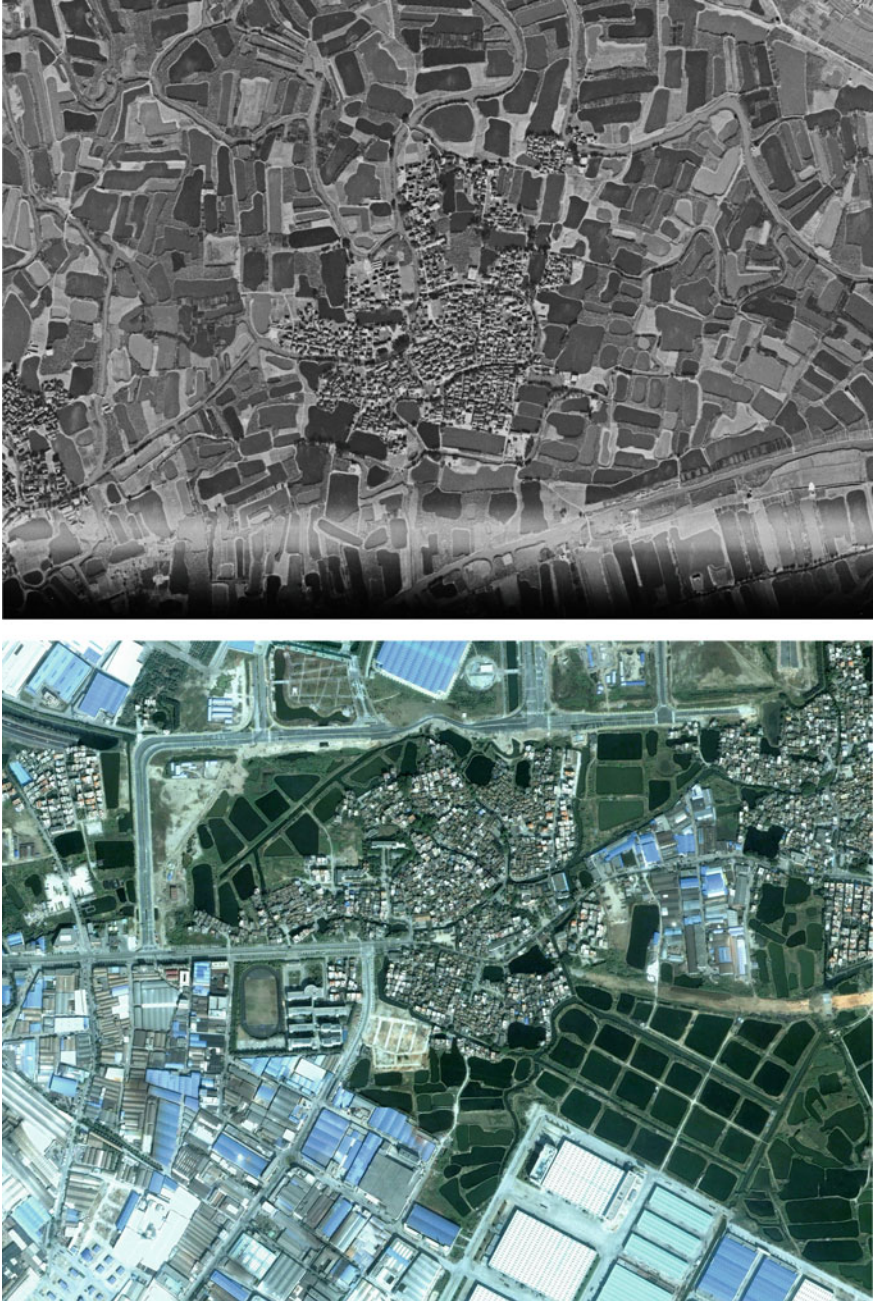
In addition to flood risks, villages like Dadun suffered from water contamination. Generally, delta villages did not have sanitary sewer systems. Historically, the farming population in this silk producing region gathered night soil and deposited it to fertilise mulberry trees. Villagers had planted trees on the berms between ponds. The practice was gradually discontinued when the silk industry vanished and when the ponds were used for aquaculture. Also, chemical fertilisers became available in the 1970s. No longer used as fertiliser, household sewer drained directly into the village canals. But, such drainage would only work to disperse the contaminated



**Fig. 7.1** In 2003, the City of Foshan proposed an extension of its Central Business District across the Dong Ping River, a branch of the Northern Pearl River. A plan developed by Sasaki Associates, Boston, was selected as the result of a competition shown on the left (*Source* City of Foshan, with permission from the Planning Department). The image on the right shows the proposed plan with five existing villages in that location. The villages were slated for demolition. Dadun is located in the centre (*Source* Bosselmann et al. 2010). Below left, building inventory of Dadun’s central portion. Roofs rendered in dark refer to historic village structures; roofs rendered in grey refer to buildings modernised by villagers prior to 2008. Below right, detail showing new and old construction (*Source* Bosselmann 2018)

waters if the network of canals is well maintained and connected to the tidal flow of the Dong Ping River to the north of Dadun. The canals were neglected because the city of Foshan operated under the assumption that the villagers would sell their land and village. Foshan authorities installed locks that interrupted the tidal flow in the canals.

Our team took water samples inside wells, canals, fishponds and on the banks of the Dong Ping River. Analysis of our samples at a laboratory of Sun Yat-sen University showed the worst water quality in the canal in front of the Liang ancestral hall, which also coincided with the canal in front of the former primary school: the laboratory measured 200,000 mg of faecal chloroform per litre, followed by 140,000 mg inside a courtyard well of a farmstead. An amount of contamination that prohibits skin contact. A still functioning canal connected to the river measured 20,000 mg, and the Dong Ping River itself had a low contamination of 10,000 mg. The water quality in the fishpond also measured 10,000 mg. These results were critical to the discussion



**Fig. 7.2** Dadun in 1979 and in 2007–2008, at the time of our workshop (*Source* Google Earth 2006, adapted by the authors)



**Fig. 7.3** Dadun in 2020. The tower block to the north-west of Dadun accommodated housing for displaced villagers (*Source* Gaodemap 2020, adapted by the authors)

with Foshan authorities that followed. Foshan opened the water lock at the entrance to the village. The village committed to laying sewer lines along the margins of the canal, and Foshan committed to connecting the pipes to a new sewer treatment plant.

### **7.2.2 Authority and Social Values**

With the economic opening of the region, the northern part of Shunde municipality, where Dadun is located, attracted large-scale furniture manufacturing, and with it a workforce of migrant workers who came to the Pearl River Delta from rural parts of China. In need of housing nearby, they rented rooms in villages. Dadun became a dormitory. In fact, the migrant worker population at Dadun had risen to 6,000 renters in 2008 and outnumbered the 3,500 villagers. The villagers benefitted from the rental income and used it to make improvements to their dwellings. Given the tight land coverage inside the village, they added more space vertically rather than horizontally. Villagers also built new homes at the village outskirts in order to rent out their former homes inside the village. The village council exercised permitting authority, but officials in Foshan criticised building activities. Some of that critique might have been justified, but it was clear to the villagers that officials in Foshan

did not want Dadun to grow, rather it expected the villagers to give up, take the offered compensation and use the money to move into new high-rise towers under construction in Foshan.

Our team recommended a more deliberate approach that envisioned a more gradual transformation allowing the village collective to maintain their independence and decision-making about how their members would like to live in the future. Change was inevitable. Life would not return to an agricultural economy, but as long as the collective held together, individual members could modernise an existing home, expand or reduce space depending on family size, take in an elderly family member or rent out space. Life in the uniformly designed high-rise clusters would not offer such freedoms. A move away from the community would also alter tangible qualities like reverence at the ancestor hall and the Taoist temple, collective care for the elderly and children.

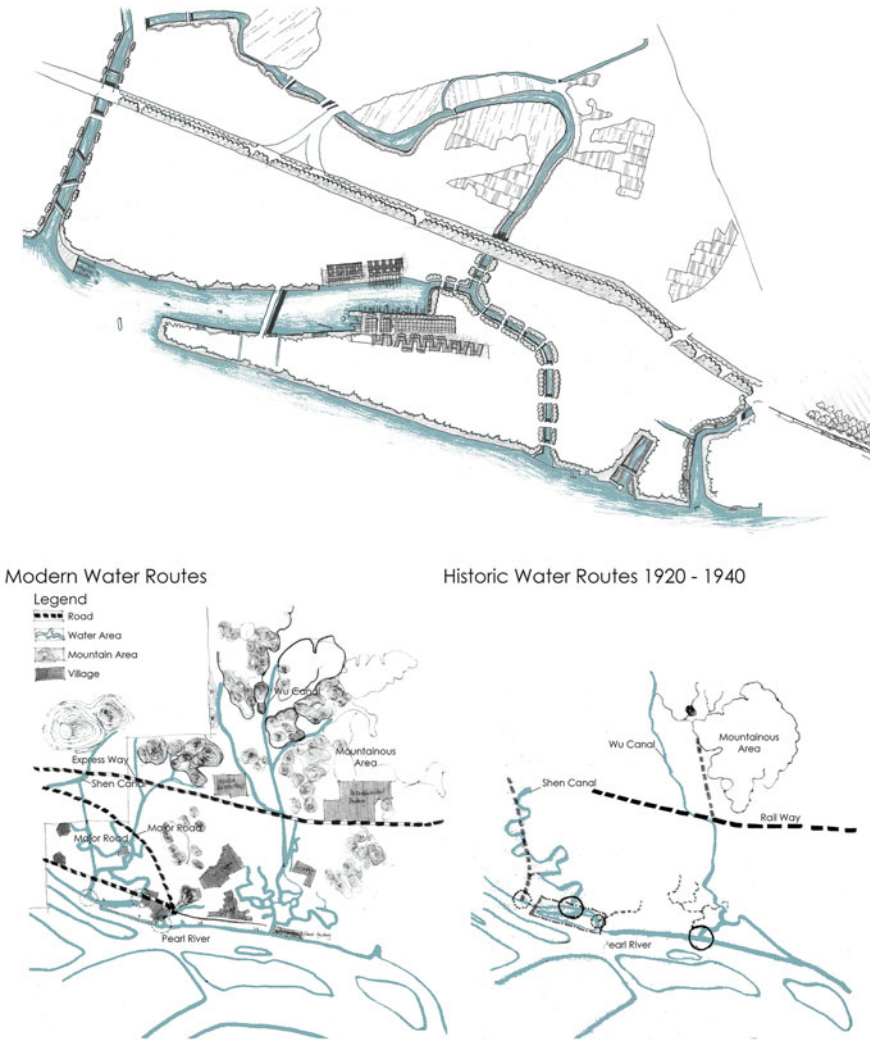
Important for our team was the consideration for the future of those who rented space at Dadun. While members of the collective have the right to compensation in the event of a sale, there is no guaranteed protection for renters. They would be subject to eviction. Initially, much economic activity in Guangdong Province had been fuelled by work for low wages, but new housing for low-income wage earners was unaffordable. Villages like Dadun provided rental housing at a cost workers could afford. A trend had started with the beginning of the new millennium that made industry hold on to an experienced work force. What was needed was industry sponsorship that made it possible for workers to transform abandoned buildings in villages like Dadun and through self-help build homes for themselves. An old idea, successfully demonstrated in many developing countries regardless of their government's political ideology (Turner 1976; Habraken 1982) (Fig. 7.4).

In the 15 years that lapsed since we started our work in Dadun, the demographics changed in Guangdong province.<sup>1</sup> The village population is ageing. Different from the previous two decades after the economic opening, the trends to hold on to qualified workers changed the definition of what it meant to be a migrant worker—or the more derogatory label, member of the *floating population*. Helen Sui in her research convincingly documented that workers who had migrated to the Pearl River Delta are floating less than assumed. Indeed, a second generation of migrant workers has been born locally with fewer ties to the rural origins of their parents (Sui 2007).

According to China's 2020 census, the young population of up to 14 years old has grown by 3.2% in Guangdong Province since 2010. Children of migrant workers, together with children from neighbouring villages, go to the Dong Ping primary school; nearby, at the middle school for older children, students number around 2,000 children. The increase in young people has kept the school population at a healthy level. Demographers are concerned about the population group of 15 to 59 year olds. This group shrank by 5.63% (Statistics Bureau of Foshan City 2021);

---

<sup>1</sup> Statistics Bureau of Guangdong Province, the Seventh National Population Census Leading Group Office of Guangdong Province. Bulletin of the seventh national census of Guangdong Province (No. 4)—age composition of population—15 May 2021.



**Fig. 7.4** Whampoa Harbour. Maps below illustrate the waterways at Whampoa Harbour. The harbour, itself a former arm of the Northern Pearl River, became available for new development after port activities closed. Shown on the right is the proposal of a multifunctional development that resulted from the 2009 design workshop (*Source* authors with UC Berkeley and SCUT students)

and the elderly, those over 60 years of age, increased by 2.4. Rental space in Dadun played an important role in this 10-year period of transition.

Not anticipated by our team was a 2009 political decision by the Guangdong Province government to transfer land use jurisdiction over Dadun and neighbouring communities from Foshan prefecture back to Shunde municipality, where it had

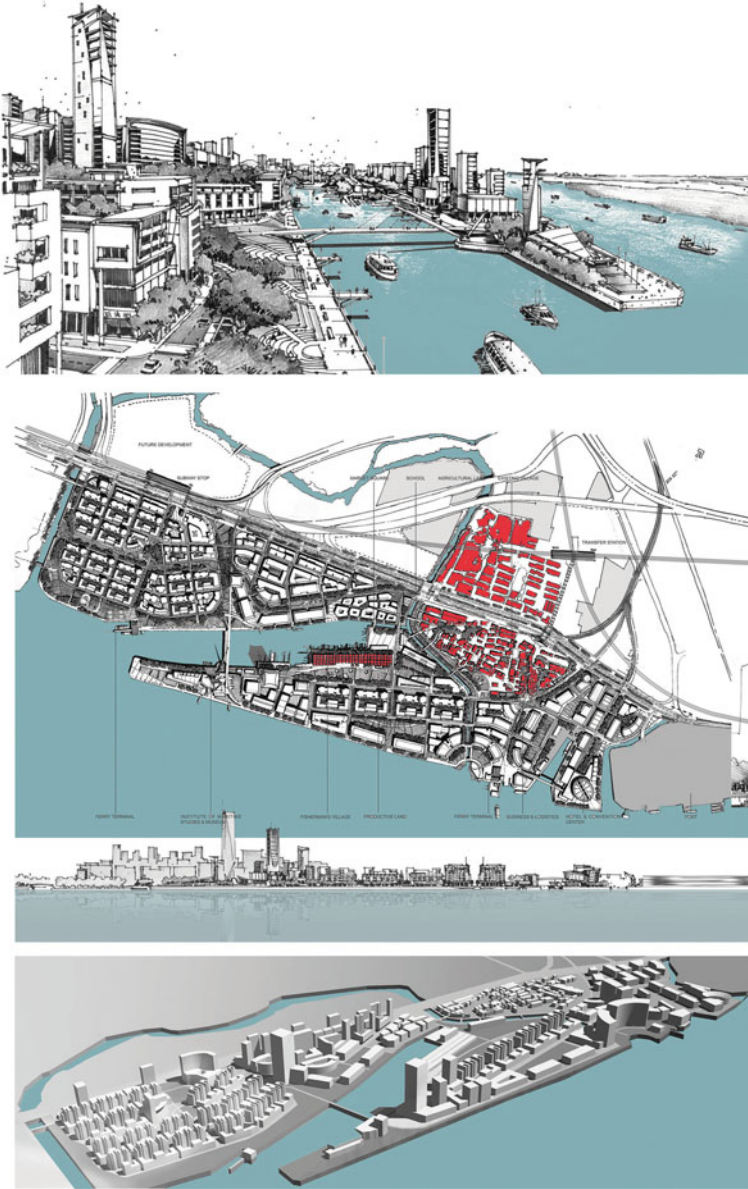


Fig. 7.4 (continued)

been administered prior to annexation. The province exercised land use authority consistent with policies of the Chinese central government.

### 7.3 Whampoa Harbour 2010

Whampoa is the name of an anchorage that was the terminus for foreign ships sailing up the Humen (Tigris), a tidal estuary into which both the northern and eastern branches of the Peal River empty. Modern port activities there largely ended once a new container terminal came into existence closer to the South China Sea, but at the time of our work in 2010 (Bosselmann 2013), non-containerized shipments, like steel and a large cross section of exotic lumber, still arrived at a Whampoa basin. The basin was also shared by ‘boatpeople’, who lived partly in a floating village and partly on land. Boatpeople are members of an ethnic minority believed to be descendants of the delta’s indigenous population prior to Han Chinese migrating into Southern China.<sup>2</sup> Boatpeople form tightly knit communities in various waterway locations of the Pearl River Delta (Hürliman 1962).

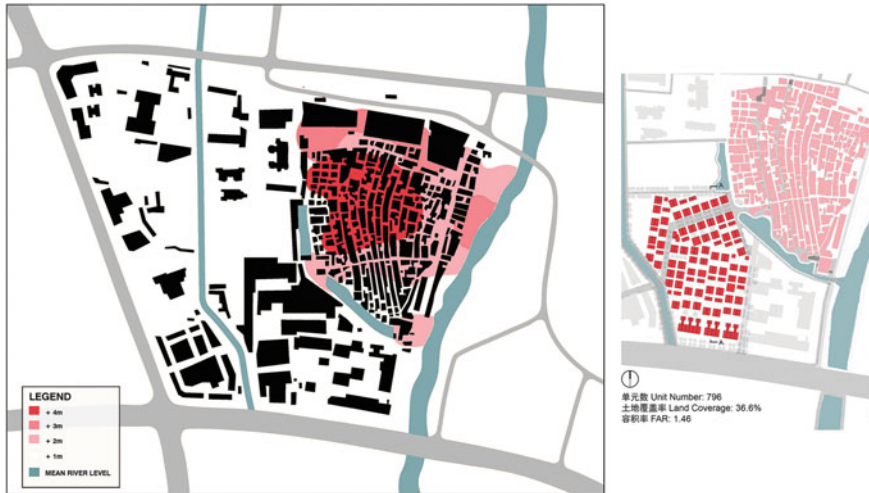
At Whampoa, we focused again on two issues: land use and fluvial history. Formerly, small waterways connected the harbour to inland locations. Their role as a transportation system used by sampans was abandoned long ago, and the canals have been filled with debris, and some still function as open sanitary sewer lines. In the future, with more urbanisation and more hard surfaces, the canals can take on a new role as drainage channels and increase water storage during tidal floods and monsoon events. For six months a year, from April to August, precipitation averaging 30 cm a month contributes to the annual 1.7 m of rainfall. Given the high ground water table and water-saturated low-laying terrain, run-off needs to be stored until it can be discharged at low tide.

By the time, we started work on the Whampoa Harbour area; changes in land use were discussed at the Whampoa municipal level. Our team argued for multiple future uses for the 60-hectare site and illustrated possible building scenarios (Fig. 7.5). In the first decade of the twenty-first century, strong land use controls were enacted in Guangdong Province. Changing land use became a difficult undertaking. Local governments had to go through a long process with different committees. Decision-making about development became subject to greater scrutiny, which was an improvement, but changing land use from industrial to other uses like housing remained almost impossible. For that reason, the Whampoa municipal government did not propose a change in land use, but simply a transfer of the site from receiving steel and precious wood to a trading floor where such commodities were auctioned. Feng Jiang observed that as a reaction to tight land use control planners assumed that

---

<sup>2</sup> Sui Seung Yan, ‘those born on the water’. Boatpeople are also known by the derogatory term Tanka. The Tanka are considered by some scholars to be related to other minority peoples of southern China. The anthropologist Ling Huihsiang argues that the Tankas are descendants of the Bai Yue.





**Fig. 7.5** Historic Xinxi village (New Stream) is located on a hill as shown below in grey tones adjacent to a channelised tributary of the Northern Pearl River. Shown on the right is an extension of Xinxi proposed to replace warehousing owned by the village collective (Source Bosselmann et al. with UC Berkeley and SCUT students 2012)

a parcel of land should be used for a single function (Feng 2015). But given the high cost of infrastructure investments and the goal of reducing private vehicular transport, mixed-use development would be more sustainable and is generally preferred. The Guangzhou Urban Planning Design and Survey Research Institute agreed. They developed a control and master plan. In 2013, Skidmore Owings and Merrill's City Design Practice in San Francisco was commissioned by a private developer to develop a refinement to the concept plan that met our objectives.

## 7.4 Xinxi 2013

Xinxi means *new stream*; the name referred to a small water course that exists today in the form of two constructed lakes to the west of a village with the same name. The water in the former creek bed is mostly stagnant, but hydrologically connected to the Wuchong Canal that borders the village on the east. As a tributary to the Northern River, the Wuchong Canal at Xinxi is subject to tidal flows. The village was established on a slightly raised hill at the confluence between the two waterways. Historically, both creeks functioned as free-flowing waterways and occasionally flooded the area near their confluence. Water flow in both creeks was regulated: Wuchong Canal runs between embankments, and Xinxi Creek was channelled into a small culvert further to the west of its historic course. On the south-facing slope of the hill in the direction of the historic confluence, the village formed as a comb-shaped layout with

rows of village homes along narrow lanes that sloped uphill. A street across the eight lanes functioned as the main street. It was the location of an ancestor hall that was no longer in use when we did our design and planning work in January of 2013.

One part of our team worked on a design that restored the flow of water in the former Xixi Canal by tapping into the culverted section of the diverted creek to improve the quality of the currently stagnate water. The restoration would also improve the air flow up the narrow lanes and restore the village's orientation to water at its southern end. It was also important to improve the living conditions for the village occupants without displacing them, be they owners or tenants.

At that time, we wrote: 'a village where the villagers are inclined to hold on to their collective ownership, at least for the time being' (Bosselmann et al. 2014). A 2019 satellite image shows the village without any noticeable change, but that is misleading. Apparently, the village committee agreed to a sale that was initiated at a December 2019 meeting (Fig. 7.5). The decision comes not as a surprise because already in 2013, the villagers in the neighbouring village had given up their ownership and demolition had begun. In contrast, the Xixi villagers showed no interest in selling their village and land because they had diversified their economic base. They had sold a portion of their farmland to a political party for a training facility. From the funds gained, they had built a hotel. They had kept a piece of low-laying land for a vegetable farm to grow produce for a large restaurant with seating under a large roof structure. And they had converted the rest of their farmland into a warehouse complex that served the nearby port. The Xixi collective had benefitted from an income stream, apparently sufficient to ward off any voluntary takeover by government or by developers. In addition, the 800 members of the collective benefitted from renting out rooms inside the village to a population of approximately 2,400 migrant workers. This elaborate arrangement of collective ownership of land and property came to an end in 2019. At the time of this writing, we learned that the village is now under a developer sponsored urban renewal process that will erase the village.

Anticipating, but not knowing the outcome of future decisions by the villagers at the time of our work, we conducted an experiment exploring the conditions that would need to be met in order to provide affordable housing for a population of workers and residents left out of the housing market. Guangzhou makes affordable housing available to low-income residents at a cost of a monthly rent of 29 yuan per square metre, but in 2013, migrant workers were not eligible for government sponsored housing.

We used the collective's 3.8-hectare warehouse complex as a potential site to build at least 600 units of affordable housing that would incrementally allow renters to move to upgraded living conditions. The difficulty with such a proposal was that the village collective cannot use any of its assets as collateral because banks cannot repossess assets of a collective in case of loan default. Only a developer could take out a mortgage, but that would necessitate a sale. At the time, the villagers would not agree to such a sale, and a sale involving a developer would make the cost of housing unaffordable for the group we had targeted. Our calculations showed that 4.4 million yuan would be needed for construction, plus carrying cost over 15 years

at 6.5% interest, which would bring the loan to 114 million yuan. That would result in a 1,500 yuan monthly rent for a 75-square metre unit or 20 yuan per square metre.

Our solution at the time was to propose sponsorship of housing by the industry that has an interest in retaining qualified workers. Eventually, such a model would become necessary if the government continues to restrict access to affordable housing for migrant workers. Industry would need to guaranty the loan for construction and financing. Two workers who bring home 1,550 yuan each per month, the minimum wage in Guangzhou at the time, would have difficulties paying the 1,500 yuan rent for a 75-square metre unit, unless they take on a third tenant. But, two established workers making 2,400 yuan per month each could afford such a flat (Bosselmann et al. 2014). The cost for rent calculated here compared more favourably to housing financed by the government and made available to low-income Guangzhou citizens.

During our work, we became aware of the discussion about the future of workers with rural registry from outside of Guangdong Province. The Xinxi villagers had provided a place of transition in which migrants gradually become citizens of the city (He et al. 2010). The emphasis is on gradual. In the last 10 years, the population of Guangzhou increased by 5,975,805 citizens, many of them with former rural registry. In urban villages like Xinxi, groups of migrants from the same rural region settled where peers already lived, forming sub-enclaves where language, food and traditions can be easily shared.

The urban renewal process that now unfolds largely ignores the fate of the migrant population. It will proceed by developing the village land in eleven phases. The development company will start with parcels closest to the metro station in the northern portion of the site and build a commercial high-rise tower followed by demolishing mid-rise structures from the 1980s and replacing them with seven residential towers. Demolishing Xinxi village will take place in four later phases with one labelled as the 'start-up resettlement', which coincides with utilising the warehouse complex that we used to demonstrate how affordable housing could be realised. The nine towers that eventually replace the village will have a range of apartments differing in size from 46 to 125 square metres with a monthly rent of 44 to 50 yuan per square metre (CPC Huangpu District Committee 2021).

## 7.5 Jiangmen

After the opening of China to foreign investment, Jiangmen became a prefecture-level city in 1983. Tangjiang River is draining directly into the South China Sea to the west of the Pearl River System. The waterway at Jiangmen connects the two river systems. In 1902, forty years after European powers concluded the Second Opium War against China, Jiangmen became a treaty port. Foreign shipping companies reclaimed land along the river embankment of the historic centre and built three-storey shop-houses in tight rows on narrow lots that formed fifteen urban blocks. The design of these blocks was carried out in an eclectic colonial style with arcades across all properties fronting the streets. In the 1980s, the town centre was slated for

demolition to make room for a contemporary commercial and administrative district; the central government intervened and a new city centre was built further inland.

By 2012, when we worked on the historic centre of Jiangmen, the city was committed to ‘the preservation and upgrading of streets, urban blocks and buildings with the goal of improving the quality of life for all its current residents’ (Bosselmann and Moos 2014). The reality in modern-day China is that residents who own cars have moved away from the centres to modern developments at a city’s outskirts. Elderly residents remain. Migrant workers and low-income residents move into flats that owners make available for rent, owners, who in many cases had left China during the twentieth century or earlier. Observations about income, car ownership and mobility raise important questions about who will benefit from the renewal of a historic district. For current residents to benefit, improvements must remain affordable for workers who earn low wages in an economy where the cost for housing and transportation has risen disproportionately to wages. This would require incremental renewal to avoid displacement of current residents. It would require low-interest loans to upgrade properties in the form of code enforcement grants (Fig. 7.6).

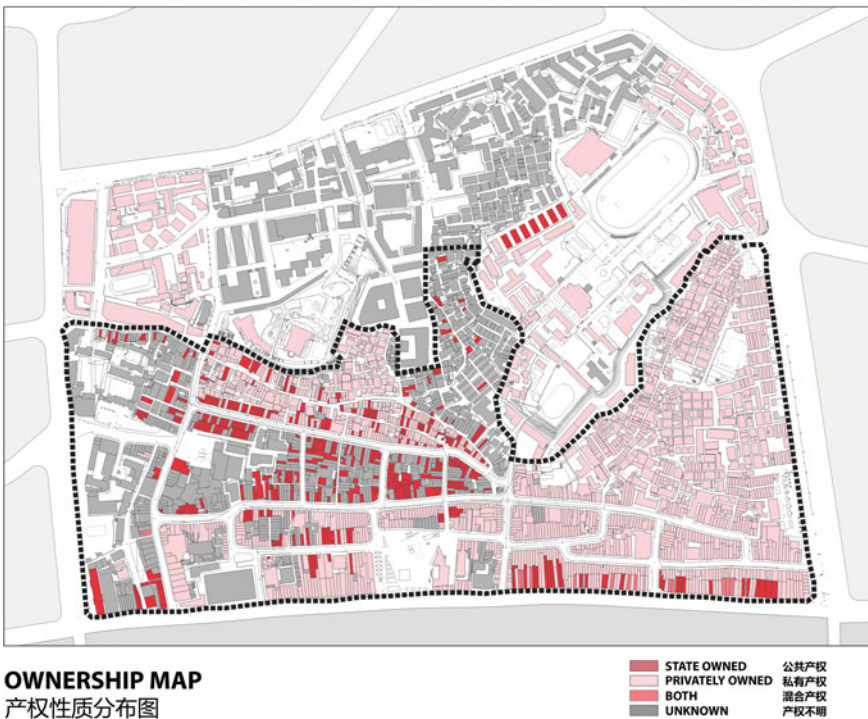


Fig. 7.6 Jiangmen is located on a tributary of the Western Pearl River. Below, property ownership in Jiangmen’s historic centre (Source City of Jiangmen, with permission from the Planning Department). Right: an inventory of urban blocks and proposed block repair (Bosselmann with UC Berkeley and SCUT students 2010)

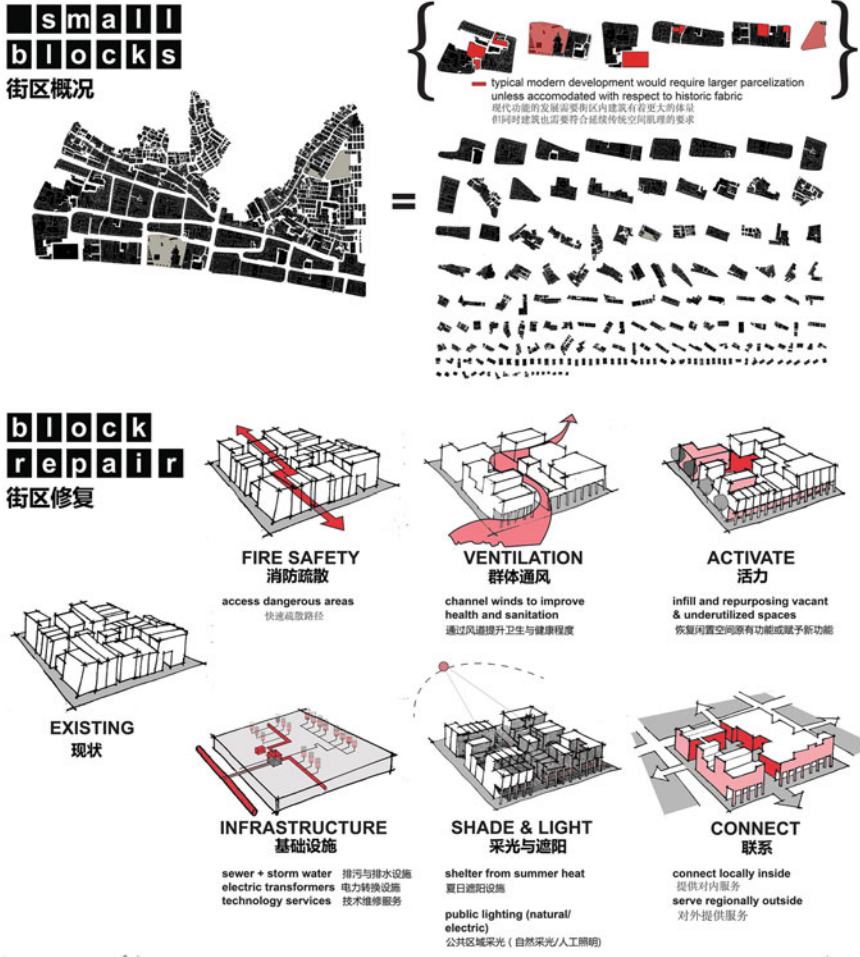
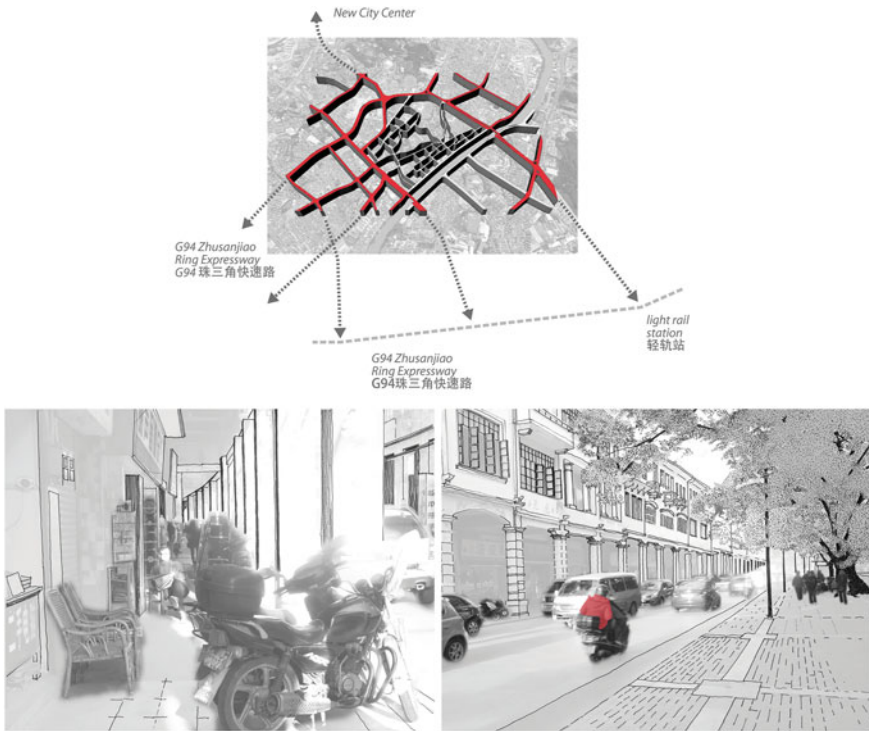


Fig. 7.6 (continued)

The young design professionals in our team working on Jiangmen in 2012 enjoyed the active street live, the mingling of several generations and the comfortable climate of shaded streets benefitting from natural ventilation even on hot days (Bosselmann 2018, pp. 123–132). The covered market street, the promenade along the river lined with mature banyan trees and the shops and restaurants at ground level all contributed to an ambience rarely observed in the new urban development districts. These young professionals could see themselves living in such a setting. They designed infill structures in the tradition of the narrow row houses, but with modern sanitation and two ways of egress to address fire hazards (Fig. 7.7). Eventually, such infill structures will be built, but in the ten years that have passed since our work, none of that has happened. This is not surprising, and if such infill will be built, for reasons of social

equity, infill should preferably happen gradually. The cost associated with such infill will necessitate residents of higher income, who, as residents with higher income, would not move to the centre out of economic necessity, but to live in a relatively car-free environment, where they are able to walk to places for their daily needs and enjoy social diversity.

Research on attachment to place and the different reasons for attachment has its roots in the Gestalt theories of the 1940s. Environmental psychologists have recognised its importance since Kurt Lewin coined the term ‘field theory’ (Stokols 1987). More recently, Renee Chow built on field theory in her book, *Changing Chinese Cities* (Chow 2015). Historic preservation of urban districts is still a relatively recent trend in Chinese cities. In the long run, investments made in such districts will create values associated with the public good that outrank investments in the new developments on the city’s periphery.



**Fig. 7.7** Repair of Jiangmen’s shop house typology (Source Bosselmann with UC Berkeley and SCUT students 2010)

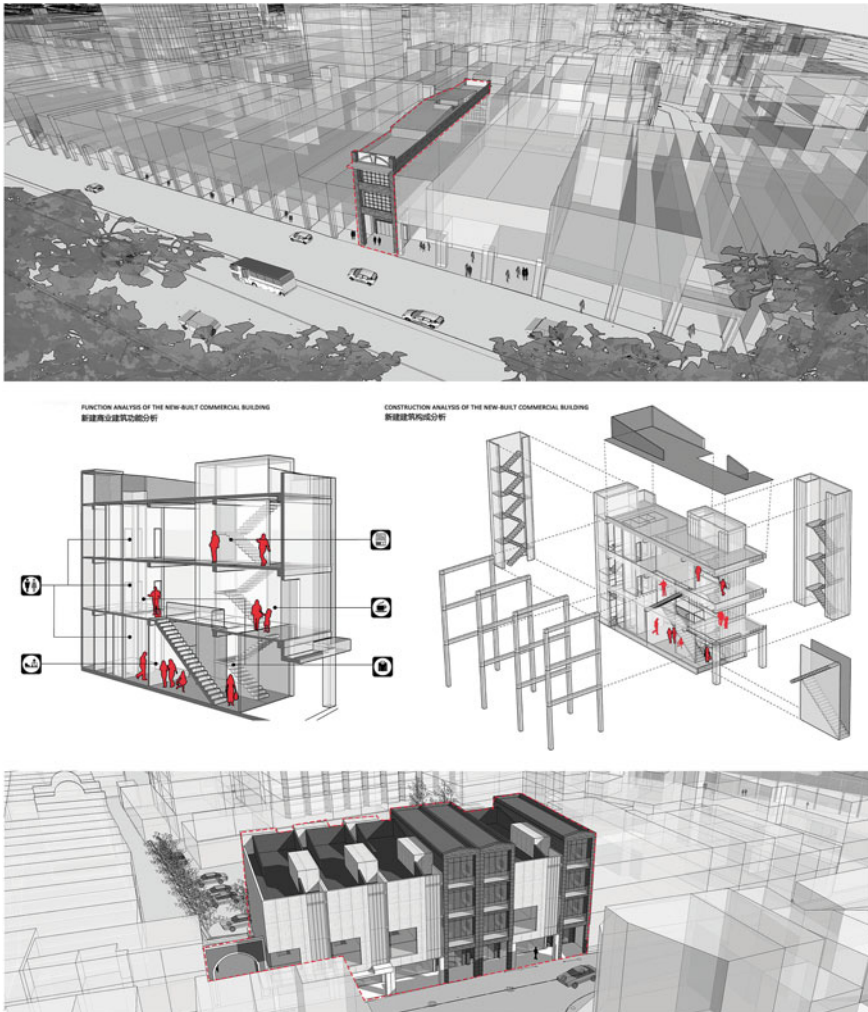


Fig. 7.7 (continued)

## 7.6 Pazhou Island East

Pazhou Island is located in the flood zone of the Bei River, the northern branch of the Pearl River. As the river runs from west to east along the south-facing slope of the Baiyun Mountains, the floodplain lies low, barely above the water table of the river at high tide. The floor of the riverbed at Pazhou Island is three metres above mean sea level; the river has a depth of 6.3 m at that location. The ground elevation on the island measures 7.5 m above mean sea level, the island's protective levee measures at 8.05 m above mean sea level; the tidal aptitude between low and high-tide amounts to

approximately one metre—higher during the twice monthly atmospheric tide, even higher when the tide is driven by strong winds.

On our first visit in the fall of 2014, all former agricultural use of the island had ceased on the western part of Pazhou Island. Only an experimental farm remained; it belonged to the Vegetable Science Institute of Guangdong University and was still operating on the low-lying terrain. The farm served as a reminder of how vegetables were grown on land that was subject to occasional flooding. There were 30-cm-deep channels between rows of vegetables designed in a grid to drain the land after rainfall. The villagers on this part of the island had given up their fields; and their village had been demolished. Villagers now occupied 670 units in thirteen 30-storey high-rise slabs. A hospital was under construction, as was a high-rise tower for a media company.

Pazhou Island was slated for a media technology centre. Closer to the middle of the island, a new bridge across the Bei River had been completed for the privately financed South China Expressway. It was designed to serve the huge hangar-like structure of the Pazhou Convention and Exhibition Centre, host to the biannual Canton Import and Export Fair. In the design workshop of January 2015, we focused on a 200-hectare site facing the Bei River between the western end of the island and the convention centre. The impervious surfaces in its predevelopment condition totalled 46 hectares, an area that will increase to 98 hectares once completely developed. The monsoon on 10 September 2010 dropped 202.5 mm of rain, resulting in run-off from the undeveloped of about 93,100 cubic metres. With new development and reduced infiltration, the same storm event would result in 180,000 cubic metres. Even though the island was still largely undeveloped, after the storm in September 2010, run-off flooded streets and underpasses around the new expressway and only slowly drained off over the course of several days.

During the workshop of January 2015 (Bosselmann 2018, pp. 132–140), we designed an urban district of multiple uses around a proposed subway station. The district included housing for the population that would staff the media industry on the island. Our design addressed water management in a manner that became known as *sponge city*. Potential flood water from monsoon events and/or tidal flooding could be absorbed after storm events and stored under streets that drained into an existing lake, where water could be further stored prior to discharge into the river. Three additional river-bound streets drained into a reservoir along the river embankment, again for later gradual discharge into the river at low tide.

Official planning for the western part of Pazhou Island had proceeded too far for our recommendations to be adapted. The land area of the site was filled with construction debris to eight metres above mean sea level. The lake we had envisioned to use for water storage was also filled. Urban blocks of 160 by 160 m were laid onto the land. Each block was designated for single commercial use and developed as such. Our proposal consisted of a future mixed-use development with small urban blocks designed to encourage living in walking distance to workplaces. Our urban blocks measured 75 m along the east–west streets and varied on the streets leading towards the river.



It is important to note that the Pearl River Delta is subject to long-term geological subsidence (Wang 2012). Reclamation fill made of construction debris places additional weight on the soft subsoil and results in additional differential settlement. The combined subsidence affects roadways, water and sewer pipes below streets and necessitates periodically raising levees along the river.

In January 2019, we returned to Pazhou Island to work on the eastern part. Development of Pazhou's underused eastern 400 hectares was seen as a missing piece in completing a new centre in the design of Guangzhou's polycentric Greater Bay Area. One of the observations our team made was about then steadily increasing expectation of Pazhou Island's development potential. These growing expectations were fuelled both by the provincial government and by the developer community (Fig. 7.8).

We recognised that greater caution was necessary when setting goals for the amount of development that government should authorise for the central and eastern portion of the island. Our concern resonated well amongst the government officials, especially at the regional level, but also at the level of Guangdong Province. Understandably, concerns about the greater frequency of disastrous floods were on everybody's mind. In 2018, the year prior to our workshop, typhoon Mangkhut had occurred on 15 September when the high tide reached 8.23 m above mean sea level



**Fig. 7.8** Eastern portion of Pazhou Island. An existing fishing village is shown in the foreground, historic Pazhou village in the middle and newly constructed high-rise development on West Pazhou Island in the background. A new seawall is graphically superimposed and designed to protect the southern shore of Pazhou Island, which is currently unprotected during storm events. The jetties in the foreground have a partly religious as well as functional role (Drone picture by Aaron Xie; drawing by Bosselmann and Li 2019)

at the Sun Yat-sen University tide-gauge station, which was a water level higher than the 8.05-m elevation of Pazhou Island's flood control dyke (Fig. 7.9).

High expectations about a buildout of the island would make disaster prevention costly, if not impossible. Instead, we recommended a process of incrementally permitting development in locations well served by transit, but not on low-lying land adjacent to the seven still existing villages.

Our second recommendation at the time urged the government to preserve all existing 80 hectares of low-lying land and to design this land to be suitable for flood water storage (Fig. 7.9). Recent history showed that combined storm and high-tide events had devastating effects on the island even with its then semi-industrial and rural land use. In the future, many new roads and building would further reduce infiltration and increase storage needs for floodwater. We quantified and documented future floodwater storage needs for two development scenarios of different intensity (Bosselmann et al. 2019). We also computed how the perimeter of the island should be strengthened (Fig. 7.10).

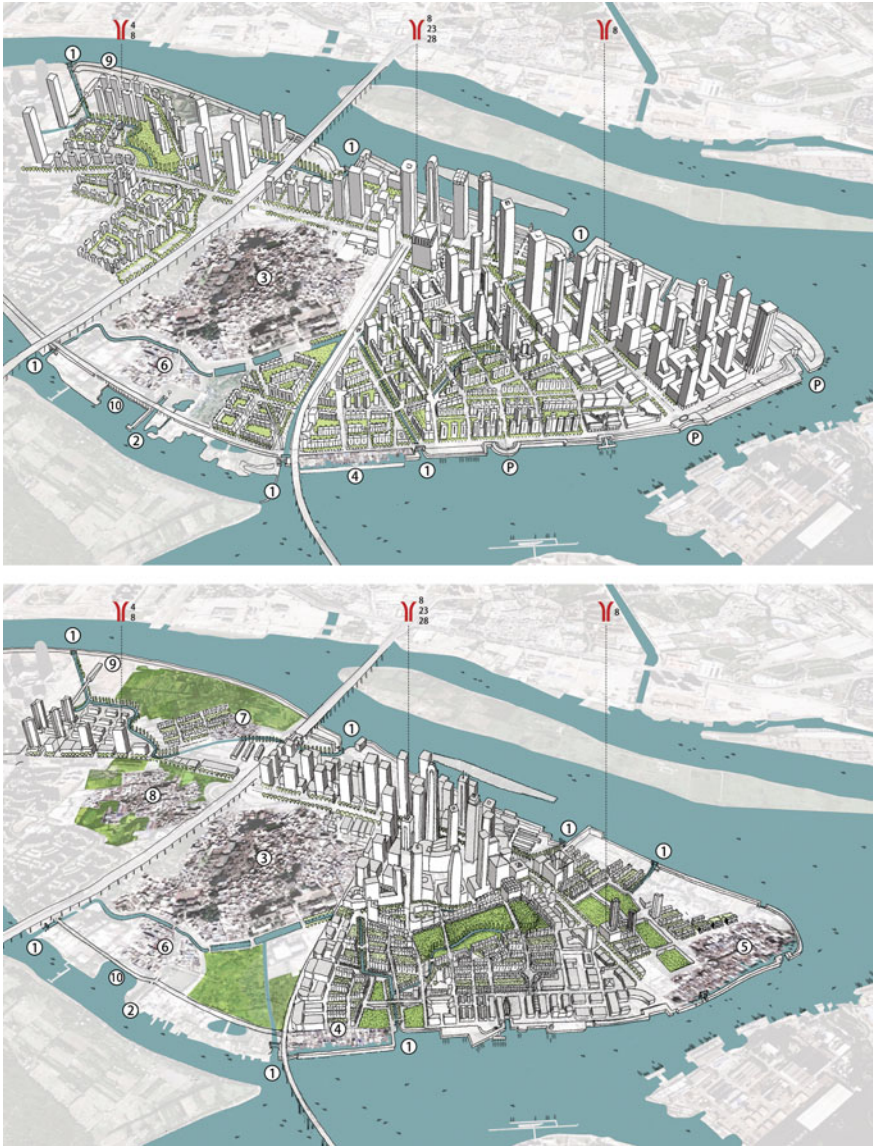
Clearly, floodwater storage capacity below streets and parking areas would become necessary under even modest development scenarios. With high development scenarios, water would need to be channelled away after storms to storage areas on low-lying land. Our computations showed that an exclusive reliance on storage capacity below streets and parking areas would not suffice during major storms.

## 7.7 Conclusion

Our work was done in an educational setting where young professionals were encouraged to develop ideas that value the environment and the people who live there. We started by asking what long-term policies should guide our designs. The challenge then was to demonstrate the implications of such policies through design or alternative designs. Naturally, our ideas frequently clashed with standard planning practice, like the way street grids are currently designed, largely as barriers with a bias only for vehicular mobility. The list goes on, like the bias for single-use developments, whereas multiple use offers many advantages. The size of urban blocks is generally too large and not conducive to walking. Then, there are deeper rooted convictions like the assumption that conditions will return to an equilibrium after interventions caused by humans or nature. An equilibrium is rarely ever found in cities or landscapes; constant change will continue to prevail into the future. The lessons for architects and professionals in the related fields were to learn not only to fulfil the needs of the present. Present conditions never last for very long. They certainly do not last long in an environment dominated by water like the Pearl River Delta—an important lesson for us all.

**Fig. 7.9** Six existing villages on East Pazhou Island. We proposed to preserve a total of 80 hectares of low-lying land adjacent to the villages and design the land to store floodwater after monsoon and combined tidal surges during storm events (Bosselmann et al. 2019)





**Fig. 7.10** A high development scenario for East Pazou Island (top), and a moderately high development scenario concentrated at three subway stations (below). Existing low-lying land amounting to 80 hectares would remain undeveloped and would be designed to store floodwater after monsoon and tidal surges (Bosselmann et al. 2019)

## References

- Bosselmann PC, Kondolf GM, Feng J, Bao G, Zhang Z, Liu M (2010) The future of a Chinese water village. Alternative design practices aimed to provide new life for traditional water villages in the Pearl River delta. *Urban Des J* 15(2):243–267
- Bosselmann P (2013) Metropolitan landscape morphology. *Built Environ* 37(4):462–478
- Bosselmann P, Moos S (2014) The Metropolitan landscapes of the Pearl River Delta and the San Francisco Bay Area. *Built Environ* 40(2):244–264
- Bosselmann P, Frassoldati F, Xu H, Su P (2014) Incremental transformation of a traditional village in China's Pearl River Delta. *Territorio* 71(4):121–129
- Bosselmann PC (2018) Adaptations of the metropolitan landscape in delta regions. Routledge, London
- Bosselmann P, Kondolf M, Webb P (2019) An island in transition: adaptation of urban form (Translation by Shiayo Li). *Landscape Archit* 4556
- Chow RY (2015) Changing Chinese cities: the potential of field urbanism. University of Hawaii Press, Honolulu
- CPC Huangpu District Committee (2021). Retrieved from <https://view.inews.qq.com/a/20210329A0BXWOO>, Accessed on 29 Mar 2021
- Feng J (2015) Shenzhen essays. Global Schindler Award 2015, pp 40–45
- Habraken NJ (1982) Transformation of the site. Awater Press
- He S, Liu YT, Wu FL, Webster C (2010) Social change and housing differentiation in China's urban villages: an institutional interpretation. *Hous Stud* 25(5):671–691. <https://doi.org/10.1080/02673037.2010.483585>
- Hürliman M (1962) Hong Kong. Thames and Hudson, London
- Liang J (1988) History of Dadun Village (unpublished handwritten manuscript). Committee of Dadun Village, Shunde
- Statistics Bureau of Foshan City, TS (18 May 2021) Bulletin of the seventh national census of Guangdong Province (no. 4 age composition). Foshan, City of Foshan
- Stokols D (1987) Conceptual strategies of environmental psychology. In: Stokols D, Altman I (eds) *Handbook of environmental psychology*, vol 1. Wiley, New York, pp 41–70
- Sui HF (2007) Grounding displacement: uncivil urban space in postreform China. *Am Ethnologist*, 34(2):329–350. <https://doi.org/10.1525/ae.2007.34.2.329>
- Turner JF (1976) *Housing by people*. Calder and Boyas, London
- Wang H et al (2012) InSAR reveals coastal subsidence in the Pearl River Delta, China. *Geophys J Int* 191(3):1119–1128
- Zhang H et al (2008) Rapid urbanization and implications for flood risk management in the Pearl River Delta, China: the Foshan study. *Sensors* 8(4):2223–2239

**Open Access** This chapter is licensed under the terms of the Creative Commons Attribution-NonCommercial 4.0 International License (<http://creativecommons.org/licenses/by-nc/4.0/>), which permits any noncommercial use, sharing, adaptation, distribution and reproduction in any medium or format, as long as you give appropriate credit to the original author(s) and the source, provide a link to the Creative Commons license and indicate if changes were made.

The images or other third party material in this chapter are included in the chapter's Creative Commons license, unless indicated otherwise in a credit line to the material. If material is not included in the chapter's Creative Commons license and your intended use is not permitted by statutory regulation or exceeds the permitted use, you will need to obtain permission directly from the copyright holder.



**Part III**  
**Stakeholder Participation**  
**and Visualization**

# Chapter 8

## Stakeholder Participation and Visualisation in Sustainable Urban Transformation



Xi Lu and Eckart Lange

**Abstract** Sustainable urban transformation calls for the inclusion of stakeholders in the planning process. Generally, visualisation can serve as a bridge to connect stakeholders with diverse backgrounds. It is widely assumed that stakeholder participation in China differs from elsewhere due to its unique historical, political and cultural context. However, hardly any systematic studies exist focussing on stakeholder participation in the contemporary Chinese planning process. This study takes a multiscale perspective investigating stakeholder participation and visualisation in the statutory planning process in the Pearl River Delta, China. Using the urban planning system as a structural framework, document analysis was conducted based on urban planning laws, regulations and rules across different planning levels and looking at participatory phase, participatory tools and visualisation media. The study provides impulses for improving stakeholder participation and visualisation in the Chinese sustainable urban transformation process.

**Keywords** Stakeholder participation · Visualisation · Pearl River Delta · Urban planning system

### 8.1 Introduction

By 2050, 70% of the global population are expected to live in urban areas (Un-Habitat 2012). Urbanisation and the increasing environmental degradation are threatening our quality of life. Therefore, introducing sustainability in the planning process is of

---

X. Lu (✉) · E. Lange  
College of Landscape Architecture, Nanjing Forestry University, Nanjing 210037, China  
e-mail: [luxi@njfu.edu.cn](mailto:luxi@njfu.edu.cn)

E. Lange  
Department of Landscape Architecture, The University of Sheffield, Sheffield S10 2TN, UK  
e-mail: [e.lange@sheffield.ac.uk](mailto:e.lange@sheffield.ac.uk)

utmost importance for future transformative changes (Amado et al. 2010). Sustainable urban transformation is a multi-dimensional process that can realise urban development through sustainable development goals (SDGs) (McCormick et al. 2013). Among these, effective stakeholder engagement is fundamental to attaining social and environmental sustainability since it 'supports the development of strong, constructive and responsive relationships that contributes to sound project design and implementation' (UNDP 2020, p. 3).

Since around the 1960s, the involvement of stakeholders in planning and decision-making processes has been articulated on a broader basis. The term 'stakeholder' refers to 'any group or individual who can affect or is affected by the achievement of the organisation's objectives' (Freeman 2010, p. 46). As a critique of the synoptic planning at that time, Arnstein (1969) classified the ladder of stakeholder participation into three sets of rungs: non-participation (manipulation, therapy), tokenism (informing, consultation, placation) and citizen control (partnership, delegation, citizen control). In the past, planning and design were rather exclusively seen as a top-down mechanism, with stakeholders being only on the receiving end. However, this has long changed since bottom-up mechanisms have been introduced widely (Flyvbjerg 1998; Forester 1982; Habermas 1997; Healey 2003). Thus, planning has gradually evolved from a rational comprehensive process into one of collaborative communication.

Effective participation has been supported through a range of visualisation techniques. This approach is linked to the fact that human perception is dominated by the visual sense (Bruce et al. 2003). While in the 1960s, visualisation techniques were analogue only, meaning physical 3-D models, sketches and perspectives, later on, video and image manipulation became more widely used (Lange and Bishop 2005). Nowadays, through the widespread use of 3-D visualisation and animation, including real-time immersion and, more recently, mixed reality and augmented reality, from the technical side, more opportunities have become available (Gill and Lange 2015; Portman et al. 2015). This offers far more advanced possibilities to represent planning and design proposals than some decades ago. Visualisation, whether analogue or digital, is a tool that, in general, can be used in planning communication (Lu et al. 2021). The way in which it is used largely depends on the context and the willingness of the stakeholders to make the best use of it.

It is widely assumed that stakeholder participation in China differs from that of elsewhere due to China's unique historical, political and cultural context (Enserink and Koppenjan 2007; Zhang et al. 2019). Upon establishing the Chinese nation in 1949, urban planning strategies were primarily shaped by the centrally planned system for socialist development and influenced by political movements (Chen 2015; Yeh et al. 2011). The reform and opening-up in the 1980s brought about political decentralisation and market-led urban initiatives. Yet, it also triggered increasing conflicts between different actors in land development (Gar-on Yeh and Wu 1999). The City Planning Law of the People's Republic of China (1989) and Measures for Formulating City Planning (1991) were therefore formulated to function as a framework for the planning of municipalities, cities and towns. For the first time stakeholder participation was introduced in these legal documents (Hao 2007). It



is not until the Urban and Rural Planning Law of the People's Republic of China (URPL) (2008) that the method and operation of stakeholder participation became institutionalised. Since then, technical rules and guidance specifying the methods of stakeholder participation have been applied at different planning levels (Kai 2011). However, hardly any systematic studies exist focussing on stakeholder participation in contemporary Chinese planning.

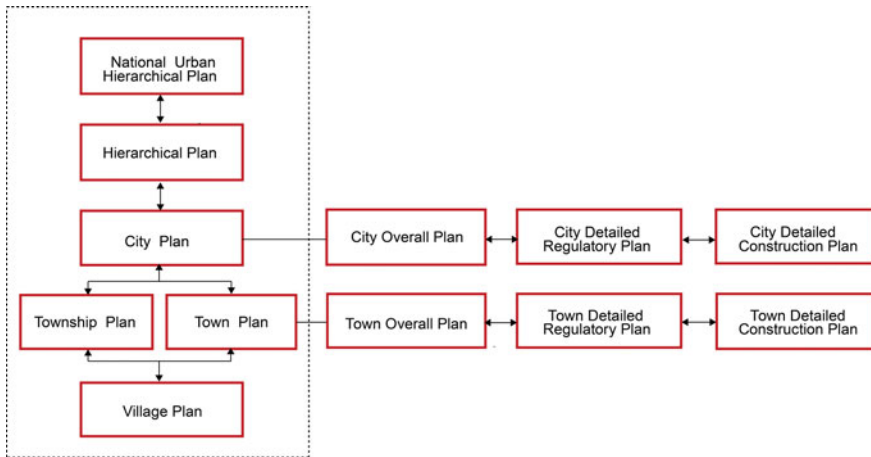
A sustainable urban transformation process needs to balance the pressures and expectations at different planning levels and the dynamics between the planning levels (Amado et al. 2010). Studies of visualisation tools in participatory planning have mainly focussed on the local scale; a multi-scalar approach to explore planning across different levels is still lacking (Pettit et al. 2012). Therefore, this study sets out to conduct a multiscale examination of stakeholder participation and visualisation in the Chinese urban planning process. It focuses on two questions: how stakeholder participation and visualisation work in the statutory planning process, and how effective they are.

## 8.2 Methods

### 8.2.1 Study Area and Urban Planning System

The Pearl River Delta (PRD) in the southern part of China covers nine cities ([https://en.wikipedia.org/wiki/Prefecture-level\\_city](https://en.wikipedia.org/wiki/Prefecture-level_city)) in Guangdong Province: Guangzhou (<https://en.wikipedia.org/wiki/Guangzhou>), Shenzhen (<https://en.wikipedia.org/wiki/Shenzhen>), Zhuhai (<https://en.wikipedia.org/wiki/Zhuhai>), Dongguan (<https://en.wikipedia.org/wiki/Dongguan>), Zhongshan (<https://en.wikipedia.org/wiki/Zhongshan>), Foshan (<https://en.wikipedia.org/wiki/Foshan>), Huizhou (<https://en.wikipedia.org/wiki/Huizhou>), Jiangmen (<https://en.wikipedia.org/wiki/Jiangmen>) and Zhaoqing (<https://en.wikipedia.org/wiki/Zhaoqing>). Although Hong Kong and Macau are also included in the greater PRD region, they are not discussed in this study due to the differences in urban planning systems between these and the mainland cities. The PRD has become a microcosm of China's rapid economic and social development, being the largest urbanised area in the world in both size and population (The World Bank 2015). The PRD differs from Beijing as the central capital in policy, actor and institutional contexts, allowing more democracy for local governance and stakeholder participation (Zhang et al. 2019). This has provided a lens to help in understanding the state-market-civil relations in current Chinese sustainable planning processes.

The multilayer urban planning system proposed in URPL (2008) serves as a structural framework of this study (Fig. 8.1). It includes national hierarchical planning, provincial hierarchical planning, city planning, town planning, township planning and village planning. A city or town plan is further divided into an overall plan and a detailed plan. A detailed plan includes a detailed regulatory plan and a detailed



**Fig. 8.1** Chinese urban planning system (Extracted from the Urban and Rural Planning Law of the People's Republic of China 2008)

construction plan (URPL 2008). The different levels of planning are interlinked. Generally, planning at the lower level needs to comply with the principles defined by the upper planning level (Curien and Thornely 2014). When the revision of planning at a lower level violates the principle determined by the upper planning level, the upper level must introduce a planning change before modifying the planning at the lower level (Article 48, URPL).

## 8.2.2 Document Analysis

Building on Ritchie et al. (2013), a framework analysis was conducted using laws, regulations and rules for urban planning in the PRD since 2008. A five-step structure was proposed to systematically simplify and visualise data, including familiarisation, identification of the thematic framework, indexing, charting and mapping and interpretation (Gale et al. 2013).

### Step 1—Familiarisation

In this step, an overall picture was obtained through scrutinising policy documents related to stakeholder participation and visualisation in Chinese planning. A total of 21 documents covering three administrative levels (LV) were referenced (see Table 8.1), including LV1 law and ordinances enacted by the State Council and Ministry of Urban and Rural Planning ( $n = 3$ ); LV2 provincial by-laws and regulations promulgated by the people's government of Guangdong Province and relevant provincial departments in charge of urban and rural planning ( $n = 4$ ); LV3 city-level regulations and rules formulated by the people's government and relevant departments in charge of urban and rural planning in the PRD ( $n = 14$ ).

**Table 8.1** Different levels of planning laws, regulations and rules

Level	Legal instruments	Formulation body
National	Law	State Council of China (Urban and Rural Planning Law of People's Republic of China 2008)
	Ordinance	Ministry of Housing and Urban–Rural Construction of the People's Republic of China (MHURC 2013); MHURC (2010)
Provincial	Administrative regulations	Standing Committee of People's Congress (SCPC) of Guangdong (2012), SCPC of Guangdong (2014)
	Administrative rules	Housing and Urban Rural Development Department (HURDD) of Guangdong (2012), HURDD of Guangdong (2005)
City	Local regulations	SCPC of Foshan (2018), SCPC of Guangzhou (2015), SCPC of Shenzhen (2020), SCPC of Zhuhai (2016), SCPC of Zhaoqing (2017), SCPC of Zhongshan (2007)
	Local governmental rules	HURDB of Dongguan (2017); HURDB of Guangzhou (2014); HURDB of Foshan (2015); HURDB of Huizhou (2016); Natural Resources Bureau (NRB) of Huizhou (2020); NRB of Jiangmen (2019); NRB of Jiangmen (2013); HURDB of Zhuhai (2016)

### Step 2—Identifying a Thematic Framework

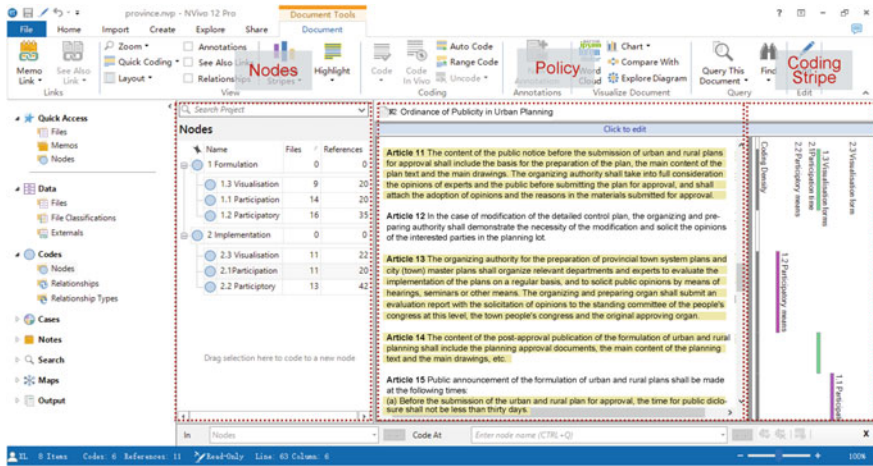
NVivo 12.0 was used to store policy documents and to conduct a systematic review and content analysis of all the legal documents. Following an inductive approach, texts and codes related to stakeholder participation and visualisation methods were highlighted. They were grouped into three themes: participation phase, participatory tools and visualisation media.

### Step 3—Indexing

Each policy was re-read and re-coded in line with the three thematic categories for further analysis. Figure 8.2 presents an example of the indexing process shown in the Ordinance of Publicity in Urban Planning (MHURC, 2013). Themes and codes used in the planning formulation stage were shown in the left column, numbered from 1 to 3 to represent (1) participation phase, (2) participatory tools and (3) visualisation media. The policy was presented in the middle column, with texts related to the themes highlighted in the right column.

### Step 4—Charting

Data was extracted from their original context and rearranged in a table according to the themes, using sources defined in the earlier steps. As is shown in Table 8.2, data from Step 3 was recorded in accordance with the relevant source (article number, name for the planning document). Following the same structure, all the urban and rural planning laws, ordinances, regulations and rules were sorted and charted. They were then combined into a larger chart, with rows (cases), columns (codes) and 'cells' of summarised data (policies).



**Fig. 8.2** Indexing process in NVivo of the Ordinance of Publicity in Urban Planning (2013) (adapted by the authors)

## Step 5—Mapping and Interpretation

The final stage includes analysis of the data that was listed in the charts, which could help to define concepts, map range and nature of phenomena, create typologies, find associations, provide explanations and develop strategies (Ritchie and Spencer 1994). The participation phase, participation tools and visualisation media across the planning formulation period were mapped following the diagram of urban planning system in Fig. 8.1. The similarities and differences between each planning level were then compared in the results section.

## 8.3 Results

### 8.3.1 Participation Phase

Figure 8.3 represents the phase of stakeholder involvement in the planning formulation stage. At different planning levels, while governmental authorities and relevant planning institutes are in charge of the earlier preparation of planning, the public is generally involved in the latter period of the decision-making process. Specifically, when a plan has been made and sent to the relevant governmental authority for approval, the public is often given 30 days or more for feedback. After planning approval, the information disclosure period varies between cities and the participatory tools used, ranging from more than 15 days for on-site publicity boards in Dongguan (SCPC of Dongguan 2012), to long-term publicity on governmental websites in Guangzhou (HURDB of Guangzhou 2014; SCPC of Guangdong 2012).

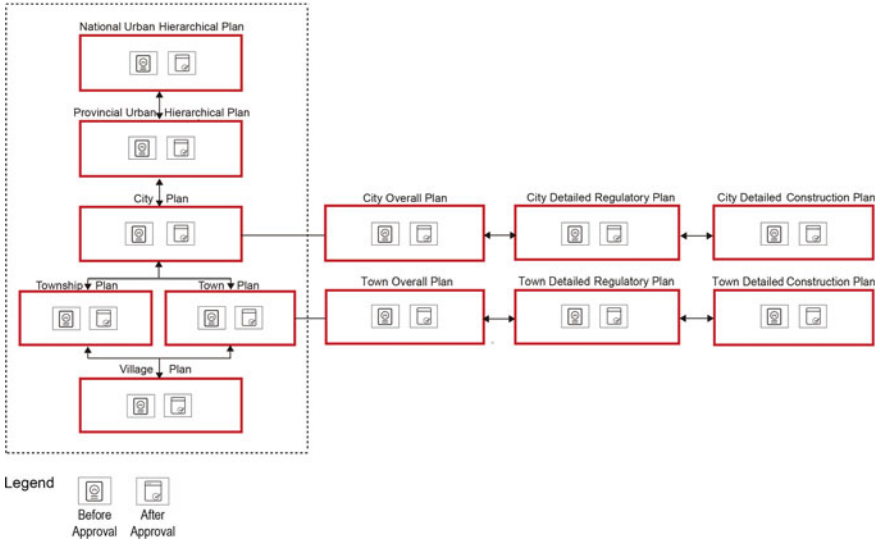
**Table 8.2** The charting process of the Ordinance of publicity in urban planning (2013)

Statutory planning	1.1 Participation phase	1.2 Participatory tools	1.3 Visualisation media
National system planning	□N/A	□N/A	□N/A
Provincial system planning	before approval, > 30 days (A9, N2); after approval, > 30 days (A15, N2)	demonstration (A13, N2); hearing (A13, N2)	text (A11, N2); 2D image (A11, N2)
City/Town overall planning	before approval, > 30 days (A9, N2); after approval, > 30 days (A15, N2)	governmental website (A5, N2)*; exhibition hall (A5, N2)* demonstration (A13, N2); hearing (A13, N2)	text (A11, N2); 2D image (A11, N2)
Detailed regulatory planning	before approval, > 30 days (A9, N2); after approval, > 30 days (A15, N2)	governmental website (A5, N2); exhibition hall (A5, N2); on-site (A5, N2)	text (A11, N2); 2D image (A11, N2)
Detailed construction planning	before approval, > 30 days (A9, N2); after approval, > 30 days (A15, N2)	On site (A5, N2); governmental website (A5, N2)	text (A11, N2); 2D image (A11, N2)
Township plan	before approval, > 30 days (A9, N2); after approval, > 30 days (A15, N2)	On site (A5, N2); governmental website (A5, N2)	text (A11, N2); 2D image (A11, N2)
Village plan	before approval, > 30 days (A9, N2); after approval, > 30 days (A15, N2)	On site (A5, N2); governmental website (A5, N2)	text (A11, N2); 2D image (A11, N2)

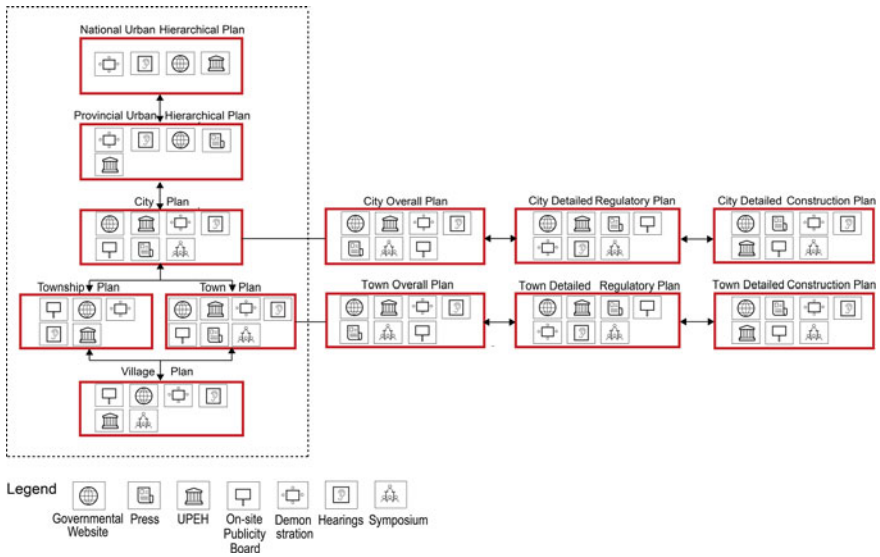
Note A refers to article, and N2 is the code for this ordinance

### 8.3.2 Participatory Tools

The participatory tools as suggested by different planning documents are shown in Fig. 8.4. There is generally little means for participation in hierarchical planning at the national level. At this level, participatory tools include demonstration, hearing, governmental websites and planning exhibitions. At the Guangdong provincial level, participatory tools include demonstrations and hearings (when necessary), governmental websites, news media and planning exhibitions. The use of participatory tools gets more diverse at the city and town scale, in which governmental websites, planning exhibition halls and news media are the most popular tools. Publicity in the public open space is the most frequently suggested tool at the village or township level (LRUPB of Zhaoqing 2004; SCPC of Guangdong 2012; SCPC of Guangzhou 2015; SCPC of Zhaoqing 2017).



**Fig. 8.3** Stakeholder involvement period as required by different planning processes (Note the icons of participatory period were arranged in descending order according to the mentioned frequency)

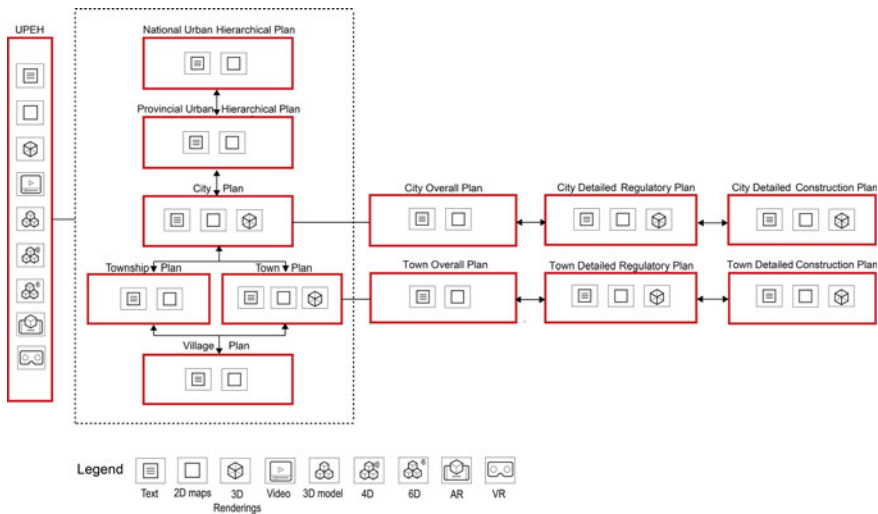


**Fig. 8.4** Participation tools in the planning formulation (Note the icons of participatory means are arranged in descending order according to the frequency of being mentioned)

### 8.3.3 Visualisation Media

Visualisation media for communication in the planning formulation stage are illustrated in Fig. 8.5. Visualisation media range from an abstract to more concrete levels as a project proceeds into a more detailed phase. Among the 21 documents, no provision has been specified regarding the visualisation media for the national urban hierarchical plan. Relevant publicity information on governmental websites suggests that visualisation media used at this level include text and 2-D plans, which align with the requirements for the provincial urban hierarchical plan and city/town overall plan (HURDD of Guangdong 2012). When it comes to critical projects in the city/town detailed planning, visualisation media may also include 3-D perspective renderings (SCPC of Foshan 2018). Visualisation tools at the township and village level are not addressed explicitly in some cities. It is recommended that they fit the local situation while following the next higher planning level regulations (HURDB of Guangzhou 2014; NRB of Jiangmen 2019).

In addition to conventional tools such as text, 2-D plans and 3-D rendering, the urban planning exhibition hall (UPEH) offers a whole range of media covering various planning information from a national perspective to site-scale design. In the UPEHs in the PRD, visualisation media for planning communication include large physical models, multi-channel digital sand table models, video, 4-D visualisation, Virtual Reality (VR) and Augmented Reality (AR) (Lu et al. 2020).



**Fig. 8.5** Visualisation media as used for stakeholder participation in the formulation of planning (Note the icons of visualisation media are arranged in descending order according to the frequency of being mentioned in different laws, regulations and rules)

## 8.4 Discussion

At the planning formulation stage, the general public in the PRD is often consulted before planning approval and notified after the decision-making with 30 days for providing feedback. As such, stakeholders in the Chinese context are typically involved at the ‘informing’ or ‘consultation’ level where they may ‘hear and be heard’ (Arnstein 1969, p. 217). However, under such circumstances, they have limited opportunities to get their opinions heeded by the decision-makers. This highlights the need to involve stakeholders at the earlier planning stage and throughout the entire planning cycle to reach more meaningful participatory outcomes.

In general, public hearings, demonstrations and symposiums are frequently used participatory tools to engage with stakeholders, e.g. when planning is associated with great social impact or may seriously affect the area’s image, etc. Nevertheless, these methods have been often criticised for their limited accessibility for the general public (Conroy and Evans-Cowley 2006). The timing and form of venues are often to blame for low participation levels; due to work, family and other responsibilities, few people are able to take the time to engage in these activities.

This weakness has been partially overcome by participatory tools including governmental websites, planning exhibition halls, on-site publicity boards and the news media. Nevertheless, they are primarily intended for one-way information rather than two-way interaction. Participatory tools that allow the general public to be actively and widely involved in the urban planning process are often lacking. Depending on the context of the project and the available resources, it is suggested that participatory methods should be tailored to different planning preparation stages and participation groups. This will allow improved interaction with stakeholders, including those who are hard to reach through conventional methods (Baker et al. 2007).

Text and 2-D mapping are commonly used for communication throughout the statutory planning process, which may fail to be understood by the laypeople due to their rather technical contents (Al-Kodmany 2002). On the other hand, 3-D perspective renderings are only occasionally used in a more detailed planning stage with greater social significance, e.g. in regulatory planning and detailed construction planning in Foshan and Guangzhou. A drawback with perspective images is that they often portray fixed viewpoints, resulting in possible incompatibilities between visual expectations and implementation outcomes (An and Powe 2015; Downes and Lange 2015).

Research has shown that advanced visualisation tools addressing interactivity, immersion and realism can contribute to a better understanding of planning (Lange and Hehl-Lange 2010; Moghimi et al. 2016; Salter et al. 2009). Conventional tools such as participatory maps and physical models may generate a social learning environment for more creative participation (Al-Kodmany 2002; Lu et al. 2021). Therefore, it is recommended to incorporate conventional and advanced visualisation tools in various planning stages to better suit diverse stakeholder needs (Gill et al. 2013). The UPEH is a unique forum providing multiscale planning information with various



state-of-the-art visualisation devices. However, in the Arnstein's (1969) ladder of participation it is located at the tokenism level to inform stakeholders and the full potential of the UPEH in planning communication is yet to be explored.

At the city and town level stakeholder participation is characterised through a range of participatory tools and visualisation media. In contrast, there is relatively little room for participation and at the higher and lower planning level. Several reasons could explain this: (1) higher-level planning that operates on a long-term basis is often very abstract and might be too complex for the general public to engage with; (2) the village and township plan were rather recently introduced in the urban planning system in 2008 (Gar-on Yeh and Wu 1999), which might explain a lower take-up in practice so far; (3) township and village levels are differentiated from the city and town level in economic power, land ownership, social style and governance model, which may affect effective participation at the local scale (Wu et al. 2015); and (4) a lack of awareness and level of education among the local people in the lower planning level. Overall, there is scope to improve active participation at the higher and lower levels of the comprehensive urban planning system.

## 8.5 Conclusion

This study highlights the importance of stakeholder participation and visualisation in sustainable urban transformation. It looks into the operation of stakeholder participation and visualisation in the Chinese statutory planning process. A document analysis was conducted using 21 planning policies at different planning levels of the PRD region, featuring participation phase, participatory tools and visualisation media. Results suggest that the public is often involved when the plan has been made, before approval and is notified after approval. The challenge remains to provide a participatory context allowing involvement of a wide range of stakeholders and offering two-way interaction. While typically text, plans and 3-D perspective images are used for stakeholder engagement, urban planning exhibition halls are unique forums for planning communication offering a range of sophisticated visualisation tools and providing multiscale planning information. The effectiveness of the UPEHs to communicate the contents of planning provides opportunities for further research.

**Acknowledgements** This study is supported by Nanjing Forestry University Metasequoia Talents Research Start-up Funding [No. 163120129], the Joint China Scholarship Council—University of Sheffield PhD programme [No. 201706090252]; IJURR Foundation Writing-up Grants 2021; and the Newton Fund/Engineering and Physical Sciences Research Council (EPSRC) as part of the Sustainable Deltas award [No. EP/R024979/1]. The Adaptive Urban Transformation research project is a collaborative project of Delft University of Technology (TU Delft), South China University of Technology and The University of Sheffield.

## References

- Al-Kodmany K (2002) Visualization tools and methods in community planning: from freehand sketches to virtual reality. *J Plan Lit* 17(2):189–211
- Amado MP, Santos CV, Moura EB, Silva VG (2010) Public participation in sustainable urban planning. *Int J Hum Soc Sci* 5(2):102–108
- An K, Powe NA (2015) Enhancing ‘boundary work’ through the use of virtual reality: exploring the potential within landscape and visual impact assessment. *J Environ Policy Plann* 17(5):673–690. <https://doi.org/10.1080/1523908X.2015.1012757>
- Arnstein SR (1969) A ladder of citizen participation. *J Am Plann Assoc* 35(4):216–224. <https://doi.org/10.1080/01944366908977225>
- Baker M, Coaffee J, Sherriff G (2007) Achieving successful participation in the new UK spatial planning system. *Plan Pract Res* 22(1):79–93
- Bruce V, Green PR, Georgeson MA (2003) Visual perception: physiology, psychology, & ecology. Psychology Press
- Chen F (2015) The design dimension of China’s planning system: urban design for development control. *Int Plan Stud* 21(1):81–100. <https://doi.org/10.1080/13563475.2015.1114452>
- City clanning law of the People’s Republic of China (1989) (testimony of NPCSC). Retrieved from [http://www.npc.gov.cn/wxzl/gongbao/1989-12/26/content\\_1481128.htm](http://www.npc.gov.cn/wxzl/gongbao/1989-12/26/content_1481128.htm)
- Conroy MM, Evans-Cowley J (2006) E-Participation in planning: an analysis of cities adopting on-line citizen participation tools. *Environ Plann C Gov Policy* 24(3):371–384. <https://doi.org/10.1068/c1k>
- Curien R, Thornely W (2014) Chinese urban planning: environmentalising a hyper-functional machine? *China Perspect* 3(99):23–31. Retrieved from <http://www.jstor.org/sheffield.idm.oclc.org/stable/24055633>
- Downes M, Lange E (2015) What you see is not always what you get: a qualitative, comparative analysis of ex ante visualizations with ex post photography of landscape and architectural projects. *Landsc Urban Plan* 142:136–146. <https://doi.org/10.1016/j.landurbplan.2014.06.002>
- Enserink B, Koppenjan J (2007) Public participation in China: sustainable urbanization and governance. *Manage Environ Qual Int J* 18(4):459–474. <https://doi.org/10.1108/14777830710753848>
- Flyvbjerg B (1998) *Rationality and power: democracy in practice*. University of Chicago Press
- Forester J (1982) Planning in the face of power. *J Am Plann Assoc* 48(1):67–80. <https://doi.org/10.1080/01944368208976167>
- Freeman RE (2010) *Strategic management: a stakeholder approach*. Cambridge University Press
- Gale NK, Heath G, Cameron E, Rashid S, Redwood S (2013) Using the framework method for the analysis of qualitative data in multi-disciplinary health research. *BMC Med Res Methodol* 13(1):117. <https://doi.org/10.1186/1471-2288-13-117>
- Gar-on Yeh A, Wu F (1999) The transformation of the urban planning system in China from a centrally-planned to transitional economy. *Prog Plann* 51(3):167–252. [https://doi.org/10.1016/S0305-9006\(98\)00029-4](https://doi.org/10.1016/S0305-9006(98)00029-4)
- Gill L, Lange E, Morgan E, Romano D (2013) An analysis of usage of different types of visualisation media within a collaborative planning workshop environment. *Environ Plann B Plann Des* 40(4):742–754. <https://doi.org/10.1068/b38049>
- Gill L, Lange E (2015) Getting virtual 3D landscapes out of the lab. *Comput Environ Urban Syst* 54:356–362. <https://doi.org/10.1016/j.compenvurbysys.2015.09.012>
- Habermas J (1997) The public sphere. In: Golding P, Murdock G (eds) *The political economy of the media*, vol 2. Edward Elgar Publishing, Cheltenham. Retrieved from <https://econpapers.repec.org/bookchap/elgeebook/1077.htm>
- Hao J (2007) Analysis on the barriers and causes in development of public participation in Chinese urban planning. *Urban Stud* 15(5):9–12. Retrieved from <http://www.cnki.com.cn/Article/CJFDTOTAL-CSFY200705004.htm>

- Healey P (2003) Collaborative planning in perspective. *Plan Theory* 2(2):101–123. <https://doi.org/10.1177/14730952030022002>
- Huizhou N (2020) Measure for implementing publicity in urban and rural planning of the Huizhou City. Retrieved from [http://land.huizhou.gov.cn/zcfg/zcjd/content/post\\_4066190.html](http://land.huizhou.gov.cn/zcfg/zcjd/content/post_4066190.html)
- HURDB of Guangzhou (2014) Measure for publicity of urban and rural planning in Guangzhou. Retrieved from [http://www.by.gov.cn/gzbygh/gkmlpt/content/4/4767/post\\_4767778.html#8437](http://www.by.gov.cn/gzbygh/gkmlpt/content/4/4767/post_4767778.html#8437)
- HURDB of Foshan (2015) Measure for the administration of publicity of urban and rural planning in Foshan. Retrieved from [http://www.foshan.gov.cn/zwgk/zcwj/gfxwj/bmgfxwj/content/post\\_1734095.html](http://www.foshan.gov.cn/zwgk/zcwj/gfxwj/bmgfxwj/content/post_1734095.html)
- HURDB of Huizhou (2016) Standard for urban and rural planning administration of Huizhou. Retrieved from <http://land.huizhou.gov.cn/attachment/0/47/47528/3770304.pdf>
- HURDB of Zhuhai (2016) Measure for the administration of publicity of urban and rural planning in Zhuhai. Retrieved from [http://www.zhuhai.gov.cn/zw/fggw/zfgb/2016n/201611/bmgfxwj/content/post\\_2542586.html](http://www.zhuhai.gov.cn/zw/fggw/zfgb/2016n/201611/bmgfxwj/content/post_2542586.html)
- HURDB of Dongguan (2017) Urban and rural planning regulation of Dongguan. Retrieved from [http://land.dg.gov.cn/xwzx/ywtzgg/content/post\\_160189.html](http://land.dg.gov.cn/xwzx/ywtzgg/content/post_160189.html)
- HURDD of Guangdong (2005) Guideline for formulation of detailed regulatory planning in Guangdong Province. Retrieved from [http://zrzyj.zhuhai.gov.cn/fgzc/ghgll/content/post\\_1974613.html](http://zrzyj.zhuhai.gov.cn/fgzc/ghgll/content/post_1974613.html)
- HURDD of Guangdong (2012) Guideline for publicity and disclosure of detailed regulatory planning in Guangdong Province. Retrieved from [http://zrzyj.zhuhai.gov.cn/fgzc/ghgll/content/post\\_1974613.html](http://zrzyj.zhuhai.gov.cn/fgzc/ghgll/content/post_1974613.html)
- Kai T (2011) Urban planning system in China: basic facts and reform progress. Retrieved from [https://dungdothi.files.wordpress.com/2011/09/urban\\_planning\\_system\\_in\\_china.pdf](https://dungdothi.files.wordpress.com/2011/09/urban_planning_system_in_china.pdf)
- Lange E, Bishop ID (2005) Communication, perception and visualisation. In: Bishop ID, Lange E (eds) *Visualization in landscape and environmental planning: technology and applications*. Taylor & Francis, Milton Park, pp 2–19
- Lange E, Hehl-Lange S (2010) Making visions visible for long-term landscape management. *Futures* 42(7):693–699. <https://doi.org/10.1016/j.futures.2010.04.006>
- LRUPB of Zhaoqing (2004) Management measure for publicity of urban and rural planning. Retrieved from [http://www.zqbmj.gov.cn/xxgk/zcjd/201703/t20170303\\_439241.html](http://www.zqbmj.gov.cn/xxgk/zcjd/201703/t20170303_439241.html)
- Lu X, Hehl-Lange S, Lange E (2020) Landscape visualisation and visitor perception in the Guangzhou urban planning exhibition hall. *J Digit Landscape Archit* 5:330–338. <https://doi.org/10.14627/537690034>
- Lu X, Hehl-Lange S, Lange E (2021) Long-term perspectives of stakeholders' perceptions of visualisation media in participatory planning: the case of Sanguan Temple Square in Guangzhou. *J Digit Landscape Archit* 6:203–211 <https://doi.org/10.14627/537705017>
- McCormick K, Anderberg S, Coenen L, Neij L (2013) Advancing sustainable urban transformation. *J Clean Prod* 50:1–11
- Measures for formulating city planning (1991) (testimony of MoC). Retrieved from <http://www.njghj.gov.cn/ngweb/Page/Detail.aspx?InfoGuid=6a026b56-3ca0-4429-a8c2-889087d7ef17>
- MHURC (2010) Measures for formulation and examination of the provincial urban system planning. Retrieved from [http://www.gov.cn/fffg/2010-06/30/content\\_1641639.htm](http://www.gov.cn/fffg/2010-06/30/content_1641639.htm)
- MHURC (2013) Regulations on public announcement and publicity of urban and rural planning. Retrieved from <http://www.waizi.org.cn/law/6747.html>
- Moghim M, Stone R, Rotshtein P, Cooke N (2016) Influencing human affective responses to dynamic virtual environments. *Presence Teleoperators Virtual Environ* 25(2):81–107. [https://doi.org/10.1162/PRES\\_a\\_00249](https://doi.org/10.1162/PRES_a_00249)
- NRB of Jiangmen (2013) Management regulation on urban and rural planning of the Zhongshan City. Retrieved from [http://www.jiangmen.gov.cn/bmpd/jmszrzyj/zcwj/wjfb/content/post\\_886978.html](http://www.jiangmen.gov.cn/bmpd/jmszrzyj/zcwj/wjfb/content/post_886978.html)

- NRB of Jiangmen (2019) Measure for implementing publicity in urban and rural planning of the Jiangmen City. Retrieved from [http://www.jiangmen.gov.cn/bmpd/jmszrzyj/zcwj/zcjd/content/post\\_1874704.html](http://www.jiangmen.gov.cn/bmpd/jmszrzyj/zcwj/zcjd/content/post_1874704.html)
- Pettit C, Bishop I, Sposito V, Aurambout J-P, Sheth F (2012) Developing a multi-scale visualisation framework for use in climate change response. *Landscape Ecol* 27(4):487–508. <https://doi.org/10.1007/s10980-012-9716-5>
- Portman ME, Natapov A, Fisher-Gewirtzman D (2015) To go where no man has gone before: virtual reality in architecture, landscape architecture and environmental planning. *Comput Environ Urban Syst* 54:376–384. <https://doi.org/10.1016/j.compenvurbsys.2015.05.001>
- Ritchie J, Spencer L (1994) Qualitative data analysis for applied policy research. In: Bryman A, Burgess R (eds) *Analysing qualitative data*. Routledge, London, UK, pp 173–194
- Ritchie J, Lewis J, Nicholls CM, Ormston R (2013) *Qualitative research practice: a guide for social science students and researchers*. SAGE, Thousand Oaks
- Salter JD, Campbell C, Journey M, Sheppard SRJ (2009) The digital workshop: exploring the use of interactive and immersive visualisation tools in participatory planning. *J Environ Manage* 90(6):2090–2101. <https://doi.org/10.1016/j.jenvman.2007.08.023>
- SCPC of Zhongshan (2007) Management ordinance of city planning. Retrieved from [http://www.law-lib.com/law/law\\_view.asp?id=311545](http://www.law-lib.com/law/law_view.asp?id=311545)
- SCPC of Dongguan (2012) Management ordinance of city planning. Retrieved from <http://dggh.dg.gov.cn/publicfiles/business/htmlfiles/dggh/s34206/201208/545705.htm>
- SCPC of Guangdong. (2012). Ordinance of urban and rural planning in Guangdong Province. Retrieved from [http://www.gd.gov.cn/zwgk/wjk/zcfgk/content/post\\_2532539.html](http://www.gd.gov.cn/zwgk/wjk/zcfgk/content/post_2532539.html)
- SCPC of Guangdong (2014) Regulation on the implementation of the coordinated development of the Pearl River Delta urban agglomeration in Guangdong Province
- SCPC of Guangzhou (2015) Urban and rural planning regulation of Guangzhou. Retrieved from [http://www.gzlpc.gov.cn/zwgk/zcfg/ghzcfg/201708/t20170830\\_1093365.html](http://www.gzlpc.gov.cn/zwgk/zcfg/ghzcfg/201708/t20170830_1093365.html)
- SCPC of Zhuhai (2016) Urban and rural planning regulation of Zhuhai. Retrieved from [http://www.zhgzj.gov.cn/xxgk/zcfg/ghfg/201309/t20130929\\_16145324.html](http://www.zhgzj.gov.cn/xxgk/zcfg/ghfg/201309/t20130929_16145324.html)
- SCPC of Zhaoqing (2017) Management regulation on publicity of urban and rural planning in Zhaoqing. Retrieved from <http://www.szrd.gov.cn/viewszfgnews.do?id=317>
- SCPC of Foshan (2018) Urban and rural planning regulation of Foshan. Retrieved from <http://fszrzy.foshan.gov.cn/attachment/0/47/47560/764346.pdf>
- SCPC of Shenzhen (2020) Urban and rural planning regulation of Shenzhen. Retrieved from [http://www.sz.gov.cn/zfgb/2020/gb1164/content/post\\_8049285.html](http://www.sz.gov.cn/zfgb/2020/gb1164/content/post_8049285.html)
- The World Bank (2015) World Bank report provides new data to help ensure urban growth benefits the poor. Retrieved from <https://www.worldbank.org/en/news/press-release/2015/01/26/world-bank-report-provides-new-data-to-help-ensure-urban-growth-benefits-the-poor>
- UNDP (2020) UNDP social and environmental standards (SES): stakeholder engagement. Retrieved from [https://info.undp.org/sites/bpps/SES\\_Toolkit/SES%20Document%20Library/Uploaded%20October%202016/UNDP%20SES%20Stakeholder%20Engagement%20GN\\_Final\\_Dec2020.pdf](https://info.undp.org/sites/bpps/SES_Toolkit/SES%20Document%20Library/Uploaded%20October%202016/UNDP%20SES%20Stakeholder%20Engagement%20GN_Final_Dec2020.pdf)
- UN-Habitat (2012) *State of the world's cities 2008/9: harmonious cities*. Routledge, London
- Urban and rural planning law of People's Republic of China (2008). Retrieved from [https://www.mee.gov.cn/ywgz/fgbz/fl/201906/t20190605\\_705768.shtml](https://www.mee.gov.cn/ywgz/fgbz/fl/201906/t20190605_705768.shtml)
- Wu ZG, Wang S, Chen ZN (2015) Public participation in township-village planning: Theory and path arrangement. *Urban Insight* 2:150–157
- Yeh AGO, Xu J, Liu K (2011) China's post-reform urbanization: retrospect, policies and trends, vol 5. IIED and UNFPA
- Zhang L, Lin Y, Hooimeijer P, Geertman S (2019) Heterogeneity of public participation in urban redevelopment in Chinese cities: Beijing versus Guangzhou. *Urban Stud* 57(9):1903–1919. <https://doi.org/10.1177/0042098019862192>

**Open Access** This chapter is licensed under the terms of the Creative Commons Attribution-NonCommercial 4.0 International License (<http://creativecommons.org/licenses/by-nc/4.0/>), which permits any noncommercial use, sharing, adaptation, distribution and reproduction in any medium or format, as long as you give appropriate credit to the original author(s) and the source, provide a link to the Creative Commons license and indicate if changes were made.

The images or other third party material in this chapter are included in the chapter's Creative Commons license, unless indicated otherwise in a credit line to the material. If material is not included in the chapter's Creative Commons license and your intended use is not permitted by statutory regulation or exceeds the permitted use, you will need to obtain permission directly from the copyright holder.



# Chapter 9

## Bridging the Analogue–digital Divide in Stakeholder Engagement



Adam Tomkins and Eckart Lange

**Abstract** Visualisation plays an increasingly important role in the planning and design of natural and urban environments, where it now contributes to advancements in landscape representation, critical assessment, and decision-making through stakeholder participation. Visualisations are a core component of communication and dissemination within various formats of project representation, publications, workshops, and stakeholder involvement. In this project, we utilised the latest augmented reality systems to explore how it can be used to bridge the analogue–digital divide. We explored the utility of augmenting workflows for stakeholder participation workshops. We developed a suite of apps, for both tablet-based and headset-based augmented reality, to allow multiuser interactions, blending data from analogue sources, such as maps, sketches, models, and the environment, with digital data, such as GIS layers, flood simulations, and digital 3D models. To advance this aim, we developed novel occlusion methods for enriching physical models with digital twins, created novel environmental-driven augmented reality frameworks, and presented the adaptive visualisation framework for augmented reality application development.

**Keywords** Participatory process · Augmented reality · Virtual reality · GIS · Urban design · Landscape architecture

### 9.1 Introduction

Visualisation can be considered as any graphical representation of information and data, from hand-drawn sketches of an idea to immersive and dynamic virtual environments in virtual reality (Lange 2011; Pietsch 2000). As an inherently visual field,

---

A. Tomkins (✉) · E. Lange  
Department of Landscape Architecture, The University of Sheffield, Sheffield S10 2TN, UK  
e-mail: [artomkins@googlemail.com](mailto:artomkins@googlemail.com)

E. Lange  
e-mail: [e.lange@sheffield.ac.uk](mailto:e.lange@sheffield.ac.uk)

the planning and design disciplines have embraced the continuous development of visualisation technology, from the pioneering ‘before and after’ visualisations introduced by Repton (Repton 1980) to the early adoption of 3D modelling technology and harnessing both early works in both augmented and virtual reality (AR and VR) simulations (Rekimoto 1996) and the current cutting-edge mixed-reality technologies (Çöltekin et al. 2020).

Visualisations are central to how researchers/academics in the field communicate both on a qualitative and quantitative level, through displays such as greenspace designs around physical models, fluid dynamics simulations within flood extent maps, tracing paper sketches, and photographs of on-site experience (Raaphorst et al. 2017). The advent of sophisticated digital tools has begun to reshape the role of visualisation (Portman et al. 2015). In this chapter, we discuss how visualisations are being shaped by the advent of augmented reality, demonstrating the advances made to adaptive visualisations, and creating more interactive experiences that marry together analogue and digital design approaches.

Stakeholder involvement within the planning and design process (in architecture, planning, and landscape architecture for example) has become more important over time and recent years. The original focus was solely on communication. Now, a more participatory approach is used. Visual representations now form the primary means of communication between stakeholders. This includes people who work in the industry, the government, and the public.

Since the early before-and-after visualisations of Humphry Repton (Repton 1980), we have used developments in visualisation technology to improve the communication of the effects of proposed landscape interventions. Augmented reality (AR) has been used since its inception as a method to enrich visualisation and communication techniques. Stakeholders’ active participation is necessary to facilitate collaboration for successful project results. Workshop topics usually include design (Wang 2009), land-use planning (Arciniegas et al. 2013), and risk management (Schroth et al. 2011).

Stakeholder engagement workshops are naturally a multiparty process. Information is shared in real time with everyone. Any technical enhancement to the workshop process, therefore, needs to support a multi-participant approach to design to be fit-for-purpose. As part of Adaptive Urban Transformation project, we have developed dynamic visualisations as a method to encourage stakeholder discussion with the goal of informing design processes.

Maps are considered both a support research tool and a communication aid (Carton and Thissen 2009). They provide an established medium for decision-making offering a spatial context to help participants explore spatial patterns. Even though they are not always intuitive, maps are often the most used information source during workshops, especially for decision-making (Uran and Janssen 2003). However, as technology develops, new digital methods are being used to improve traditional stakeholder participation.

As Geographic Information Systems (GIS) technology becomes more widely adopted, digital technologies are often replacing base maps and tracing paper with map layers presented using GIS visualisations on a computer screen. Unfortunately,

this approach still fails to capture the multiuser nature of its analogue counterpart. An evolution of this approach, large horizontal touch-sensitive screens known as touch-tables, is commonplace as an intermediary between hard-copy base maps and desktop-based GIS visualisations (Arciniegas and Janssen 2012).

In a survey of workshop participants, 70% said they would prefer a touch-table system over printed maps; 80% of respondents also suggested that the touch-table is an important addition despite its inability to be combined with the traditional maps and sketching approach (Arciniegas and Janssen 2012).

These results suggest that easy access to computational tools and digitisation can be useful because stakeholders can easily choose, combine, and consult maps of different types.

In contrast, purely digital models are an adaptable medium to illustrate landscape interventions. The ability to combine the spatial features of traditional scale models, with dynamic features such as progressive developments and simulation results, can add vital context to static visualisations (Lange 2011). In this project, we investigated the role that mixed reality can play in bridging the analogue–digital divide, using augmented layers of contextual information (Ghadirian and Bishop 2008).

Taking either the digital touch-table approach, or the hard-copy mapping approach to regional design problems ensures that the workflow that you use is bound to solely digital or analogue data, respectively. This concrete divide between analogue and digital workflows presents barriers to adoption and inclusion. The divide requires participants to have competence in each technology in order to be fully engaged in the workflow.

Physical models are often used to visualise proposed interventions, due to their more intuitive presentation of the spatial nature of the design intervention, without relying on intermediate symbolic representations found in 2D media (Duzenli et al. 2017). Nonetheless, physical models suffer from high financial and time costs to create, and they suffer from a lack of adaptability and utility as a project evolves. On top of these disadvantages, a physical model has no interaction with digital media, encouraging the same analogue–digital divide that plagues 2D representations.

Mobile augmented reality systems have been developed using custom hardware over an extended period. An early example of this is the Transvision mobile augmented reality collaborative work software (Reitmayr and Schmalstieg 2001). Through a mobile screen, users can view and move virtual objects. Further developments established the foundations of AR in workshop settings (Butz et al. 2002). Through transferable object ownership, it is possible for people to edit virtual objects together.

Due to technological advances, mixed-reality devices are becoming more affordable to use to support the design process. AR is being developed to better inform stakeholders about design issues and interventions in both on-site and off-site sessions (Portman et al. 2015; Wang 2009). Recent studies have used a mobile-based application to test augmented reality technology during public participation (Goudarznia et al. 2017). They found that, as part of an on-site presentation, participants feel like they can use augmented reality as a tool to find out more.



Shelton (2003) shows that using augmented reality can help people learn new things about the world around them (Shelton 2003). Soria and Roth (2018) show that by using augmented reality to engage our innate spatial cues through locomotion, they can improve a participant's spatial cognition when asked to recall the details of a proposed landscape intervention in the real world (Soria and Roth 2018).

To support collaboration and stakeholder participation throughout the design process, a growing body of work has sought to use digital augmentation to expand the utility of physical models (Piga and Petri 2017). Model augmentation increases the utility and flexibility of a model by opening up new avenues for design, evaluation, and communication (Ishii et al. 2002; Walz et al. 2008). Realistic occlusion remains a barrier to the effectiveness of on-site visualisation.

Realistically embedding digital designs into a detailed physical model is a complicated process. With complex geometries, due to a lack of fine-grained depth information, mobile AR and environmental tracking suffer from the problem of physical occlusion (Kruijff et al. 2010; Wloka and Anderson 1995). Where occlusion fails, a physical object cannot appear in front of and thus occlude a digital object, regardless of the spatial orientation of the scenes. This is because digital augmentations are necessarily layered on top of the camera feed to create the final visualisation.

Realistic occlusion for complex geometry is a challenging task in AR application development. It requires detailed modelling and laborious spatial calibration on-site ahead of time to get acceptable results. This leads to either site-specific single-use application without environmental occlusion (Goudarznia et al. 2017; Soria and Roth 2018), a cumbersome set-up process (Haynes et al. 2018), or generic applications with no interaction with the surrounding environment (Tomkins and Lange 2019a, 2019b).

Haynes et al. (2018) have demonstrated an innovative, yet time-consuming manual approach to roughly mapping the spatial profile of an area using primitive shapes to create simple occlusion geometries (Haynes et al. 2018). While this approach is feasible for small areas, its application would be problematic for both larger natural environments and smaller complex geometries such as physical models. These limitations pose a problem in harnessing the immersive power of augmented reality visualisation to affect change in large-scale projects.

Despite the issues with accurate occlusion, in previous studies participants have reported feeling comfortable with using augmented reality as a tool to explore future interventions (Goudarznia et al. 2017). This lays the groundwork for further developments in the AR approach to enriching stakeholder participation.

## 9.2 Materials and Methods

To directly utilise the application within an ongoing workshop format, we created a tablet-based AR application to interface with the traditional paper media used in the workshop setting (Carrera et al. 2017, 2018). We chose this format because the

application of AR ensures the current workflows can be maintained without modification due to the ability to layer information over reality. Pen-and-paper sketches can be augmented instead of replaced, maps can be dynamically enhanced, and physical models can be transformed digitally, without altering the underlying presentation. This is in contrast to other digital augmentations such as virtual reality (Song and Huang 2018) and touch-tables (Arciniegas et al. 2013), which require the transformation of the underlying representations from analogue media to digital data.

Each application covered in this chapter has been created in the Unity Game Engine. This provides application programming interfaces (APIs) for all current mixed-reality toolkits such as Vuforia, Google ARCore, Apple ARKit, and Microsoft HoloLens for augmented reality, as well as SteamVR and Google Cardboard, supporting all major virtual reality headsets and augmented reality devices.

The Unity Game Engine has a strong presence in the planning and design literature, with applications in public participation (Goudarznia et al. 2017), spatial cognition (Soria and Roth 2018), and future scenario visualisation (Haynes et al. 2018; Tomkins and Lange 2019b).

The Unity Game Engine provides several approaches to tracking. For our applications, we use both fiducial markers and 3D model tracking for tablet-based AR applications and full environmental tracking and mapping for the HoloLens applications.

The cartographic AR application uses visual anchor tracking. The Vuforia package in the Unity Game Engine supports this. Multipoint tracking enables users to easily track the base maps from a wider variety of angles, without losing tracking quality. This allows users to focus close-up on specific areas of a larger map, without losing tracking quality. Partial occlusion occurs when tracing paper overlays markers, and multiple obscuring participants surround the base maps. Multipoint tracking allows tracking to be maintained during the design process when using tracing paper over the base maps.

Crucially, Unity provides full access to the visualisation engine, allowing custom material shaders, a vital area of flexibility required to solve the occlusion problem in Tomkins and Lange (2020). Finally, to enable user interactions within our software, the Unity Game Engine supports an array of input modalities, including touch and gesture inputs for mobile devices. For our HoloLens approach, we use both gesture recognition and speech recognition to enable smooth user interactions.

For our visualisation software, we use off-the-shelf hardware, available to any research laboratory, which is well supported by the current game development engines for custom software development. For our AR applications, we use both a hand-held tablet device and a Microsoft HoloLens 2 headset. Each device has a different set of strengths and weaknesses, which render them suited to different stakeholder participation tasks, for example, workshops and guided tours.

For workshop-oriented tasks, we utilise hand-held augmented reality on a tablet device. Tablets come with a high degree of familiarity, creating a quicker on-boarding process in a multiuser workshop setting. Each tablet has a rear-facing high-definition camera, with which to capture the environment and detect tracking markers. While

trackerless tablet-based AR is possible (Tomkins and Lange 2019a, b), it is less suited to a workshop environment, as it encourages non-cooperative interactions due to being untethered to any particular space.

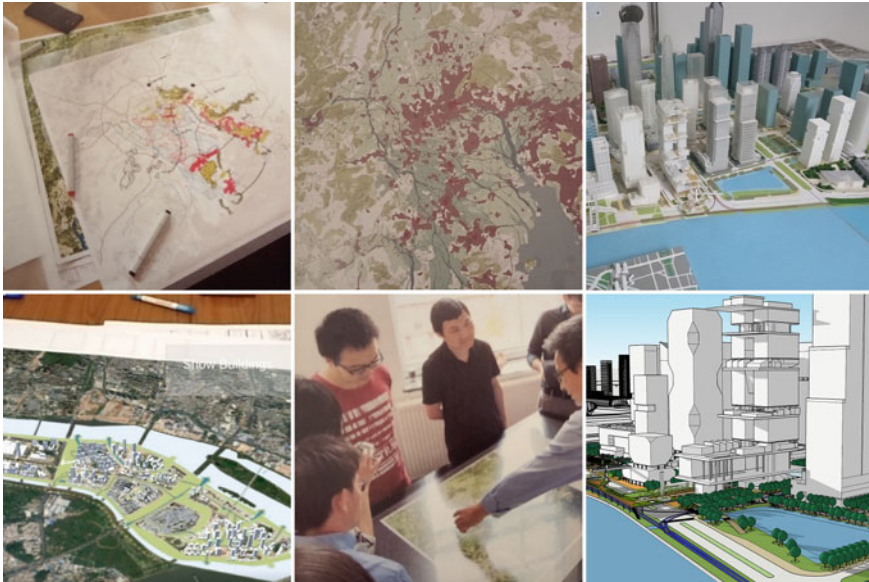
Fiducial marker tracking overlays the digital augmentation over a fixed, highly salient image in the environment, such as a QR code. In a workshop setting, this has the advantage of providing a single, central location for multiple users to focus upon. Each user perceives the same digital model in the same physical place. While less suitable for workshops, environmental tracking enables the AR explorations to take place simultaneously in remote locations or in the field. Full environment tracking is available with the Microsoft HoloLens and is used to craft more immersive and dynamic experiences on site.

The HoloLens 2 hardware is extremely capable in terms of mapping environments in real time and has the necessary computing power to perform on-the-fly medium-scale spatial mapping. On the other hand, unlike tablet-based AR, the environmental requirements, such as low light levels, pose issues in creating an effective and widely applicable experience with the HoloLens. Using these devices, we can bring augmentations to both on-site visits and to a large array of traditional analogue media used in the workshop setting.

Throughout the Adaptive Urban Transformation project meetings, we have harnessed a range of visualisation technologies, spanning analogue and digital tools, including both traditional media and cutting-edge digital technologies. Figure 9.1 shows the range of media used in a typical workshop setting. Traditional analogue media included maps, tracing paper sketches and physical models. The digital media used included GIS data sets, 3D models, simulations, and digital touch-tables. These visualisation materials formed the basis of the adaptive visualisation tools developed throughout the project, including both augmented reality and virtual reality experiences, described below.

### 9.3 Results

In this section, we will detail the three major approaches to bridging the analogue–digital divide that we have developed throughout the project, focusing on the adaptive augmented reality applications developed for both hand-held mobile devices and the Microsoft HoloLens headset. Here, we detail novel approaches to digitally enriching the three primary analogue media used for landscape communications, maps, models, and the site visit. Moving away from traditional augmentations, we ensure that the digital additions are driven by the analogue counterparts, creating a tight cycle of analogue–digital interactivity, usually reserved for the analogue domain.



**Fig. 9.1** Examples of visualisation media used in the adaptive urban transformation project. *Photos Adam Tomkins and Eckart Lange*

### 9.3.1 Enriching Maps

In this section, we introduce our tablet-based map augmentation application. The core aim of the application was to integrate the various data and visualisations created throughout the Adaptive Urban Transformation project and facilitate the next stage of designs that built upon a variety of data sources, including base maps, GIS data, hand-drawn sketches, and publication data.

In stakeholder participation workshops, digital and hard-copy maps, alongside other representation formats in 2D and 3D, are used extensively to support communication, spatial evaluation, and interactive decision-making processes. In this section, we present a novel tool to enhance traditional map-based workshop activities using augmented reality. Stakeholders use 2D base maps and static imagery to collectively assess, compare, and rank competing proposals (Arciniegas et al. 2013).

Analogue visualisations, such as maps, are natively enriched through tracing paper sketches and annotations. This activity plays a central role in the large-scale regional planning approach through the research by design paradigm (Nijhuis and Bobbink 2012). A major drawback is that these sketches, such as those on tracing paper outlays, cannot easily be reused throughout the project, as they are usually ephemeral creations to aid in communication, tied to a specific underlying base map. Lacking any specific registration, they cannot be combined with GIS sources, other than as a base map overlay. This lack of flexibility leaves sketches unable to interact with more

complex contextual information, such as flood simulations, limiting their utility as a comparative design tool.

Here we can enrich the basic mapping paradigm to simultaneously allow both analogue enrichment through sketches and digital enrichment through augmentation. The digital realm lends itself much more readily to the continuous evolution of the design process while providing new levels of context to the analogue enrichments, through changing base maps, dynamic data visualisation, and even 3D model integration. Figure 9.2 shows how traditional sketches can be integrated with digital layers, to provide design context, and enable a more grounded discussion of site concerns.

The application is designed to look like the base maps and layers that are used in traditional paper maps, combining established formats, such as GIS layers with more general image formats for layer flexibility. We use an array of real-world base maps as the anchor and introduce the ability to digitally switch the base map as desired, while the AR participant changes the base representation to support different aims at the same time. This separation of analogue and digital allows new comparisons to be made between different data sets at the same time, such as sketches and digital models shown in Fig. 9.2b. We use GIS base maps as our standard maps and allow users to add additional data on top of the base maps. The concept of layers has been



**Fig. 9.2** Views of the cartographic AR application: **a** the base map and tracing paper; **b** augmented 3D buildings onto the designs; **c** a participant annotating the map during augmentation; **d** overlaying 3D models and 2D designs onto the base map; **e** overlaying GIS data; **f** overlaying an interactive flood simulation. *Photos* Adam Tomkins and Eckart Lange

generalised in such a way as to allow 3D digital models and dynamic simulations to be coexisting inside a single layer at the same time.

Utilising AR for map enrichment ensures that the fundamental experience of design remains the same, allowing for an inclusive experience that can take place regardless of the technology readiness level among participants. Our application is solely used to offer targeted enhancements to the design process when required. Expanding the visualisation from 2 to 3D enables us to repurpose 2D data, for example, height maps into an interactive flood map (Fig. 9.2f), by following the method described in Tomkins and Lange (2019a, b). This transformation to an interactive flood simulation thus makes our data more interpretable, as seen in Fig. 9.2. From this interactive layer, users can specify a desired flood scenario as the base scenario for a design intervention. This method also provides a metric to evaluate potential designs in a way that could not be done with a static visualisation.

As the digital base layers emulate and expand upon the large-format printed base map toolset, data layers aim to emulate the configurable digital layered approach of spatial GIS tools. Static data layers include raster data such as population density, historical flood risk, surface permeability, and vector data such as land use and waterways (Figs. 9.2d, e). Each of these can be used as a base map layer or visualised seamlessly on top of the physical base map. The dynamic layer brings real-time interactivity to the static data layers and the underlying physical media. These dynamic elements can be used to intuitively explore the dynamic nature of data sets, such as flood extent, with configurable water levels as seen in Fig. 9.2f.

The pen-and-paper design approach is limited to the 2D plane. In the same application, both 2D and 3D data are combined, as shown in Fig. 9.2b. We anchor 3D models onto the 2D base map using static, 3D model layers, such as in SketchUp. For our site, we had two large-scale, urban models. These represent a three-year process in the urban planning and design process. This allows the 3D model to be more geographically contextualised. As a layer, the 3D model can then interact with other layers, such as sketches or digital plans shown in Figs. 9.2a and d.

Here, we have shown how we can enrich maps to include dynamic data switching, interactive simulations, and integrate 3D models, to bridge the gap between the traditional design process and the data-rich digital world. These enrichment and integration enable new contextually informed design methods. While the tactile nature of hard-copy maps will not be supplanted by innovative technology, it can be complemented with new technological capabilities.

### 9.3.2 *Enriching Physical Models*

Alongside maps, physical models play a key role in the communication of design interventions. However, as models are slow to create and hard to change, their fixed nature limits their utility as both a discursive and a design tool. In this section, we

describe our results in using mobile augmented reality to overlay 3D digital data onto 3D printed models, to enrich urban designs, as first published in Tomkins and Lange (2020).

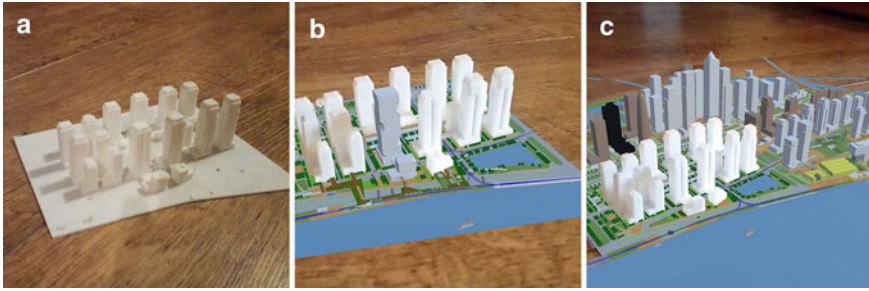
Dynamically altering the appearance of 3D models allows us to compare competing designs in situ, replace outdated physical characteristics as the design progresses, and contextualise urban models within a larger urban context. We accomplish this using a digital twin and a novel accurate physical occlusion model. The aim of this application is to encourage design exploration in 3D space, enabling costly physical models to become evolving design tools.

We use mobile tablet-based AR to ensure a cost-effective multiuser set-up. Our digital model is designed in SketchUp, which provides the basis for both our physical model and digital urban designs used for augmentation. We present results using 3D printed structures, produced on an Ender3 printer. Previously, we have detailed the process of creating physically occluded augmented reality visualisations to enhance currently employed physical models, opening up new possibilities in dynamic augmented reality landscape architecture and urban design visualisation. We have shown that with a digital twin of a physical model, such as when we build models from SketchUp, it is possible to augment the physical model with additional 3D features, by using a novel 3D cut-out occlusion method (Tomkins and Lange 2020).

Using 3D model recognition and tracking, a digital twin model and custom occlusion shader pipeline, we can achieve fine-grained physical occlusion, on portable models. First, the digital model is aligned perfectly to the physical model, with model tracking. Next, the desired 3D augmentations are aligned over the top of the model, occluding the physical model. Finally, using the digital twin occlusion shader, we remove any 3D augmentations which collide with the physical model. With this happening in each frame, the user can truly explore an augmentation from any angle to see what lies in front, beneath, and behind the model in question. Physically occluded visualisations open up new approaches to model-based visualisation and communication tasks. This adds a layer of adaptability and interactivity which is impossible to create with stand-alone models. Here we describe a selection of applications of this process, which can be adapted to many new design and communication tasks.

We take as a case study the evolving physical models of the Pazhou Island development area, as shown in Fig. 9.3a. A physical model represents a single point in time of a project's development history. Over time, the level of detail and purpose of proposed design changes throughout a project to reflect increased knowledge and changed vision or more in-depth planning. Our Pazhou Island case study included two important model design stages: the preliminary master plan and the approved master plan, which changes as the result of a three-year design process.

The novel physical occlusion allows the fine-grained augmentations to be seen, which emphasises the new ability to visualise dynamic greenspace designs below and behind structures visible from all angles, as seen in Fig. 9.3b. The result of including physical occlusion in mobile AR is that complex dynamic visualisations can be created and embedded organically within a physical space. Examples for enrichments could include land-use allocations and physical model design changes.



**Fig. 9.3** Enriching physical models with augmented reality from top left: **a** base 3D printed building; **b** augmenting model with a greenspace design and updated new building façade; **c** embedding the physical model in a larger urban context. *Photos Adam Tomkins and Eckart Lange*

With this new occlusion method, our digital augmentations can directly interact with a physical model that encompasses complex shapes like raised walkways, overpasses, and bridges.

The preliminary master plan contains a low-complexity urban design for illustrative purposes, such as the proposed scale of the development area, the architectural height constraints, required building density, and the desired green space ratio. In contrast, the accepted master plan contains a comprehensive urban design consisting of complex architect-designed buildings and the surrounding green and blue infrastructure to reflect the long-term characteristics of the urban environment. Figure 9.2b shows how an outdated building in the physical model master plan can be digitally altered in real time to an updated façade design.

This research introduced a novel AR application to convert static physical models into dynamic discursive tools adding new use-cases for physical models in design and communication roles. Figure 9.3b shows how the limits in the physical size of a 3D printed model can be addressed by embedding the physical model into a larger digital context of the surrounding area. This expands upon the use-case of physical models in both the information content and its portability while retaining the benefits of understanding given by a 3D model (Duzenli et al. 2017).

Here, we have shown how a novel physical model enrichment process can offset the significant upfront cost and time spent in creating these models, bringing dynamism and continuous evolution to an otherwise static medium. With this enrichment, a physical model could serve as a base design in which to embed progressive design changes and visualise and compare competing designs as well as analyse possible future interventions. Small-scale design changes can be located within a larger digital urban context. While physical models provide an intuitive understanding of future changes in a workshop setting, true site visits provide an unparalleled understanding of the topography and the larger context of a proposed intervention site, which cannot be captured by models alone.



### 9.3.3 *Enriching Reality*

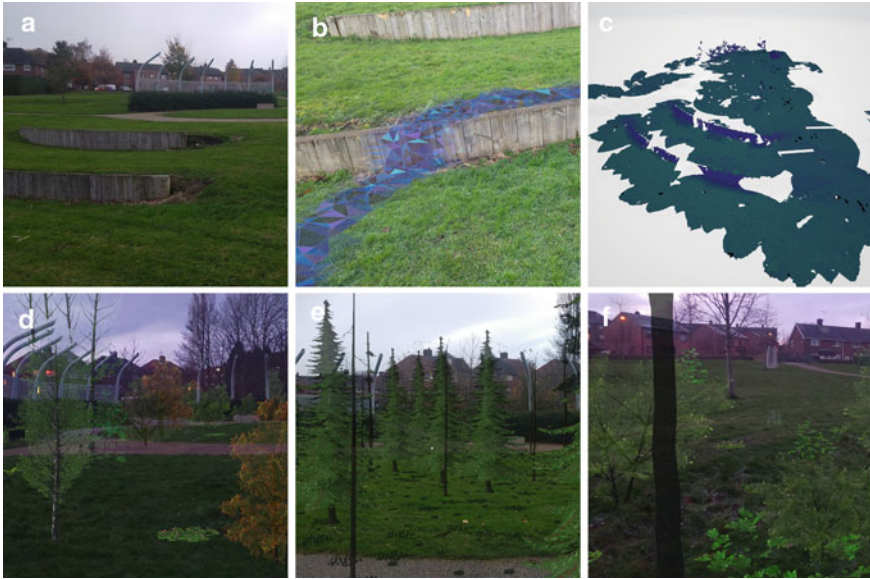
Site visits provide a new testing ground for AR augmentations. For large-scale projects, site visits with stakeholders are key to successful projects. In this project, we sought to enrich the site in real time, using the HoloLens, to enable visitors to experience a potential future scenario on the very site in question.

We built our application using the mixed-reality toolkit (MRTK) spatial mapping library to build and interact with a continuously maintained spatial mesh of the world around the user. The dynamic mapping process inherent in the HoloLens platform ensures that no prior knowledge of topography, nor prior modelling of the intervention is required. Topographical modelling is one solution to the occlusion problem, when less fine-grained. In practice, much larger geometries are often required, such as the immediate environment. The HoloLens SDK builds the local geometry as the user explores, creating a new form of exploration-driven visualisations which we combine with procedural generation to create unique and flexible visualisations.

In *Where the Wild Things Will Be* (Tomkins and Lange 2021), we aimed to create a visualisation engine that is driven by the environment. It was important that it be easily reconfigured to support different visualisation tasks. This is achieved through parameterisable procedural generation of visualisation based on project-specific 3D models, combined with rules for their spatial composition. To combat the drawback of single-use AR applications, the adaptive visualisation engine is model independent, allowing for experiences to be created by specifying different models, spatial distributions, and temporal stages. For example, this could be used to visualise the visual effect of progressive logging regimes, seasonal changes, or wildfire rehabilitation. This flexibility is designed to spatially contextualise the predictions of theoretical models, real-world measurements, or tailored scenarios (Kuuluvainen 2016). This allows users to visually experience representations of various scenarios in situ, a key benefit when communicating complex and widespread interventions (Ceausu et al. 2019).

For our case study, we choose to simulate the natural rewilding process for an urban park (Fig. 9.4a). We selected it as an inherently difficult intervention to visualise and communicate, due to its site-specific and stochastic outcomes. Multiple configurations are shown in Fig. 9.4 with both a birch-dominated configuration (Fig. 9.4d) and a pine-dominated configuration (Fig. 9.4e). Rewilding efforts are stymied by the difficulty in communicating long-term, unguided processes. With such a large array of potential sites, traditional mapping and calibration are not possible. In contrast, we describe an adaptive visualisation framework, which emphasises the roles of user interaction, procedural generation, and topographical mapping.

Site-specific outcomes are crucial to garnering support for rewilding efforts (Ceausu et al. 2019), severely limiting the single-use application's role across multi-site projects. To adapt AR to this role in large-scale projects, we built an approach that can be applied in advance to unknown environments. In *Where the Wild Things Will Be* (Tomkins and Lange 2021), we show that AR headsets can now be used



**Fig. 9.4** Enriching reality with procedural models: **a** the urban park site; **b** the HoloLens dynamic mapping process; **c** the resulting spatial geometry; **d** a potential late-stage visualisation of a birch-dominated regrowth; **e** an alternative pine-dominated regrowth configuration; **f** a close-up view of the augmented models. *Photos* Adam Tomkins and Eckart Lange

to develop applications that work with any local topography, without prior knowledge, across multiple sites without the need to explicitly build local geometries in advance (Haynes et al. 2018). A visualisation of the dynamic mapping process and the resulting maps can be found in Figs. 9.4b and c. Mapping was generated in real time, with a short walk around the urban park.

Figure 9.4d shows a possible pioneer stage, in conjunction with a small area of exploration. We see the addition of several larger birch trees, with smaller shrubs, and newly established maple saplings interspersed. Areas near the boundary of exploration can leave an abrupt gap in the augmentations. In contrast, in Fig. 9.4f, we see a close-up that shows the visual effect of walking through the dense shrubbery, including the level of detail available with close-up inspection. Unfortunately, we found that the visual efficacy of the HoloLens is strongly affected by direct sunlight, and as such these pictures were taken in the late afternoon. Three-dimensional models greatly affect the visualisations; less realistic models, without transparency, are captured better, as is seen with the low-definition pine models in Fig. 9.4e.

The adaptive visualisation approach is applicable to both research into the participation processes themselves and more generally as a tool for existing public participation processes. This application could be further used in more exploratory methods such as simulated walks through proposed parks, or visual impact assessment in a 360-degree panorama. We have demonstrated a headset-based experience that is both embedded in the natural world and applicable to a large range of sites, from small

urban green spaces to open abandoned farmlands, without prior topographical knowledge. This opens a new avenue to landscape visualisation that is complementary to well-established hand-held AR use-cases.

## 9.4 Discussion

Throughout the Adaptive Urban Transformation project (AUT), we have sought to understand and enhance the role of visualisation within the planning and design process, with an emphasis on stakeholder participation. We focus on the case study of Pazhou Island in Guangzhou, China. To further this aim, we have developed a range of novel approaches to interactive visualisations focused on two core use-cases: workshops and site visits. We sought to provide new ways to support collaborative decision-making in stakeholder participation exercises, by enabling novel methods for interactive planning and design generation.

To achieve this aim, we have developed two distinct AR applications: one tablet AR application as discussed in Sects. 9.1 and 9.2 and one headset application as discussed in Sect. 9.3. We have demonstrated that the cutting-edge technologies can create new use-cases for traditional visualisation forms, without requiring any restructuring of current workshop practices. Integration and inclusivity form the central guiding principles to augmenting traditional workflows. We ensured that the traditional approach remained prominent and that a wholesale change of participation techniques would not be required. As such, our applications can be seen as purely an enrichment process to the current workshop and on-site approaches.

Section 9.1 describes a single application that can combine 3D and 2D data from across the analogue–digital spectrum, to enable real-time rudimentary data synthesis through interactive explorations. During the AUT project meetings, we engaged the participants by drawing from both static data and dynamic simulations to generate a dialogue around hydrodynamic interventions. The application successfully combined hand-drawn maps, 3D models, and GIS data during a live presentation. This experience demonstrates that with a sufficiently dynamic framework the latest AR technology can augment our collaborative workflows without replacing existing methodologies, allowing the applications to be used by participants who had no prior application training.

Section 9.2 examines how we can improve the current approach to 3D model enrichment. Ideally, in circumstances with a large-scale physical urban model, discrete design changes could be visualised in situ as the need arises. For example, with the provision of new intervention (building plans, the design of green infrastructure, sub-surface features, land-use designation changes, or the insertion of whole city blocks) visualisations could be accessed by stakeholders without having to create new models. While this would be an implausible task with a standard physical model, we have demonstrated that with a 3D printed model and its digital twin, we can easily transform a static model into a dynamic display piece. As part of the AUT project, we combined the master plan of a new building process with a variety of greenspace

changes and adapted infrastructure projects from the literature into a situated example of the potential impact of the proposed design changes. This ability to use a standard model as a testbed for design interventions could improve our design approaches with increased spatial understanding afforded by spatially situated visualisations.

We considered how the adoption of this framework could enhance the role of visualisations in stakeholder participation practice, with respect to Arnstein’s ladder of stakeholder participation (Arnstein 1969). We argue that through a more immersive medium, mixed reality can enable a more reciprocal participation process in design consultations. For participants, mixed reality can serve as a tool to enhance spatial understanding and provide context to proposed interventions, allowing a more informed two-way communication process.

The AUT planning workshops took place over multiple sessions, with each session focusing on a specific activity, such as communication, analysis, or design. For an effective workshop process, the output of one workshop influenced the materials presented at the next, creating a workshop workflow. The primary session design ensured that all participants were familiar with the site to be studied. Next, participants were able to analyse the site to better understand the context of the site and to better define an intervention scenario. Finally, collaborative design workshops sought to use the distributed expertise of stakeholders to convene upon a variety of design solutions to solve previously identified concerns.

During the AUT project workshop, enriching the design process with augmentation encouraged the design choices taken in the exploratory session to be grounded in the whole project context. Using screen sharing of the AR application to a projected screen, the base map’s digital changes were visible to the entire audience as they were being developed live. This convenient way to cross-reference previous designs helped work to progress within multiple project constraints and stakeholders to incorporate prior knowledge. In addition, changing static base data to dynamic heat maps gave a new use-case for our underlying data, such as the flood visualisation, that would not have been possible with the static data alone.

In one workshop, we were able to describe where to put flood barriers, while simulating a progressive flood event, as part of the final presentation of different solutions along with an interactive data visualisation. We asked the designer the following question: ‘Do your flood plans address the areas of most concern?’ Using the intersection of overlaid digital data and hand-drawn designs to address the question, the application guided the design and discussion. Finally, we were able to change the project target to high population, low-lying areas without any prior planning or preparation using layer switching. Overall, we found that the ability to use these visualisations gave us a dynamic perspective on design processes.

Section 9.3 described the applicability of an untethered headset-based AR for displaying, exploring, and interacting with changes in the immediate environment. In response to identified workflow issues, we have proposed a new Adaptive Visualisation Workflow. This enables us to formulate the visualisation process in terms of the continuous interactions between the user and the environment using a procedural visualisation engine. This approach avoids many site-specific requirements, such as

mapping and calibration in advance, while remaining generic enough to configure the engine to produce a large range of desired scenarios.

We find this novel approach promising, especially for the illustration of general principles, which are guided by local topography. This is at odds with small-scale AR applications that use hand-held tablet devices. While this is a less prevalent use-case, we have shown that there is scope for innovation gains in both workshop environments and on-site visits.

Secondary to the development of new methods was the evaluation of the technical readiness of the latest AR hardware with respect to the demands of stakeholder participation events.

We found that the HoloLens creates an effective medium for free exploration of augmented natural landscapes. In its current iteration, however, the hardware does present some significant limitations. Primarily, effective use of the hardware is hampered by bright sunny days, as the over-saturation of natural light limits the ability to see visualisations clearly. This is not an issue with hand-held AR devices, and as such an effective communication strategy may still require both hand-held and headset AR until the hardware improves.

In general, we find that AR visualisation techniques can add a lot of power to the traditional visualisation media used in the planning and design subjects. Care must be taken to use the most appropriate form of augmented reality to ensure that participants feel that the technology is not a hindrance to usage. A focus on integrating with existing workflows, instead of replacing them, has provided for a fluid workshop experience, allowing for an array of novel approaches to contextualisation and iteration of design challenges.

## 9.5 Conclusion

Augmented reality has been used as a tool to enhance communication and education since its inception, focusing on hand-held AR devices in recent years. In this paper, we have discussed the contrasting roles of both hand-held and headset-based AR devices in enriching the communication capacity of visualisations, such as maps, models, and on-site experiences.

This iteration in mobile AR visualisation techniques for landscape architecture addresses a variety of drawbacks in previous data augmentation methodologies for urban planning and design visualisations. It provides a novel tool to visualise a variety of data and scenarios within and around complex physical models which would not be possible with projected augmentations or previous mobile AR applications. The cartographic applications developed have demonstrated that dynamic, interactive augmentations can enrich both the collaborative design process and stakeholder participation process, enabling new formats of collaborative and interactive discussions.

While both the analogue and digital approaches to landscape architecture have limitations, we have shown that bridging this divide and enriching analogue with

digital augmentations provides a rich set of new capabilities, allowing users to enjoy the strengths of analogue and digital approaches simultaneously.

**Acknowledgments** This work is part of Adaptive Urban Transformation (AUT) — Territorial governance, spatial strategy and urban landscape dynamics in the Pearl River Delta (EP/R024979/1), a collaborative project of Delft University of Technology (TU Delft), South China University of Technology and The University of Sheffield.

## References

- Arciniegas G, Janssen R (2012) Spatial decision support for collaborative land use planning workshops. *Landsc Urban Plan* 107(3):332–342. <https://doi.org/10.1016/j.landurbplan.2012.06.004>
- Arciniegas G, Janssen R, Rietveld P (2013) Effectiveness of collaborative map-based decision support tools: results of an experiment. *Environ Model Softw* 39:159–175. <https://doi.org/10.1016/j.envsoft.2012.02.021>
- Arnstein SR (1969) A ladder of citizen participation. *J Am Inst Plann* 35(4):216–224. <https://doi.org/10.1080/01944366908977225>
- Butz A, Hollerer T, Feiner S, MacIntyre B, Beshers C (2002) Enveloping users and computers in a collaborative 3D augmented reality. In: Proceedings of the 2nd IEEE and ACM international workshop on augmented reality (IWAR'99). IEEE Comput Soc, pp 35–44
- Carrera CC, Avarvarei BV, Chelariu EL, Draghia L, Avarvarei SC (2017) Map-reading skill development with 3D technologies. *J Geog* 116(5):197–205. <https://doi.org/10.1080/00221341.2016.1248857>
- Carrera CC, Perez JLS, de la Torre Cantero J (2018) Teaching with AR as a tool for relief visualization: usability and motivation study. *Int Res Geogr Environ Educ* 27(1):69–84. <https://doi.org/10.1080/10382046.2017.1285135>
- Carton LJ, Thissen WAH (2009) Emerging conflict in collaborative mapping: towards a deeper understanding? *J Environ Manage* 90(6):1991–2001. <https://doi.org/10.1016/j.jenvman.2007.08.033>
- Ceausu S, Graves RA, Killion AK, Svenning J-C, Carter NH (2019) Governing trade-offs in ecosystem services and disservices to achieve human-wildlife coexistence. *Conserv Biol* 33(3):543–553
- Çöltekin A, Lochhead I, Madden M, Christophe S, Devaux A, Pettit C, Lock O, Shukla S, Herman L, Stachoň Z et al (2020) Extended reality in spatial sciences: a review of research challenges and future directions. *ISPRS Int J Geo-Information* 9(7):439. <https://doi.org/10.3390/ijgi9070439>
- Duzenli T, Yilmaz S, Alpak EM (2017) The effects of model making on design and learning in landscape architecture education. *Eurasian J Educ Res* 17(70):121–134
- Ghadirian P, Bishop ID (2008) Integration of augmented reality and GIS: a new approach to realistic landscape visualisation. *Landsc Urban Plan* 86(3–4):226–232. <https://doi.org/10.1016/j.landurbplan.2008.03.004>
- Goudarznia T, Pietsch M, Krug MAR (2017) Testing the effectiveness of augmented reality in the public participation process: a case study in the city of Bernburg. *J Digit Landsc Archit* 2:244–251. <https://doi.org/10.14627/537629025>
- Haynes P, Hehl-Lange S, Lange E (2018) Mobile augmented reality for flood visualisation. *Environ Model Softw* 109:380–389. <https://doi.org/10.1016/j.envsoft.2018.05.012>
- Ishii H, Underkoffler J, Chak D, Piper B, Ben-Joseph E, Yeung L, Kanji Z (2002) Augmented urban planning workbench: overlaying drawings, physical models and digital simulation. In:

- Proceedings. International symposium on mixed and augmented reality, pp 203–211. IEEE. <https://doi.org/10.1109/ISMAR.2002.1115090>
- Kruijff E, Swan JE, Feiner S (2010) Perceptual issues in augmented reality revisited. In: Proceedings of the 2010 IEEE international symposium on mixed and augmented reality, pp 3–12. IEEE. <https://doi.org/10.1109/ISMAR.2010.5643530>
- Kuuluvainen T (2016) Conceptual models of forest dynamics in environmental education and management: keep it as simple as possible, but no simpler. For Ecosyst 3:18. <https://doi.org/10.1186/s40663-016-0075-6>
- Lange E (2011) 99 Volumes later: we can visualise: Now what? Landsc Urban Plan 100(4):403–406. <https://doi.org/10.1016/j.landurbplan.2011.02.016>
- Nijhuis S, Bobbink I (2012) Design-related research in landscape architecture. J Des Res 10(4):239–257
- Pietsch SM (2000) Computer visualisation in the design control of urban environments: a literature review. Environ Plan B Plan Des 27(4):521–536
- Piga BEA, Petri V (2017) Augmented maquette for urban design. In: Envisioning Architecture: space/time/meaning. The Proceedings of the 13th Biennial International Conference of the European Architectural Envisioning Association at the Glasgow School of Art, pp 104–113
- Portman ME, Natapov A, Fisher-Gewirtzman D (2015) To go where no man has gone before: virtual reality in architecture, landscape architecture and environmental planning. Comput Environ Urban Syst 54:376–384. <https://doi.org/10.1016/j.compenvurbsys.2015.05.001>
- Raaphorst K, Duchhart I, van der Knaap W, Roelvelde G, van den Brink A (2017) The semiotics of landscape design communication: Towards a critical visual research approach in landscape architecture. Landsc Res 42(1):120–133. <https://doi.org/10.1080/01426397.2016.1257706>
- Reitmayr G, Schmalstieg D (2001) Mobile collaborative augmented reality. In: Proceedings of the IEEE and ACM international symposium on augmented reality, ISAR 2001. IEEE Comput Soc, pp 114–123
- Rekimoto J (1996) Transvision: a hand-held augmented reality system for collaborative design. In: Proceedings of the proceeding of virtual systems and multimedia (VSMM'96), pp 18–20
- Repton H (1980) Observations on the theory and practice of landscape gardening. Phaidon, London
- Schroth O, Hayek UW, Lange E, Sheppard SRJ, Schmid WA (2011) Multiple-case study of landscape visualizations as a tool in transdisciplinary planning workshops. Landsc J 30(1):53–71. <https://doi.org/10.3368/lj.30.1.53>
- Shelton BE (2003) How augmented reality helps students learn dynamic spatial relationships. PhD dissertation, University of Washington
- Song J, Huang S (2018) Virtual reality (VR) technology and landscape architecture. MATEC Web Conf 227:02005. <https://doi.org/10.1051/mateconf/201822702005>
- Soria C, Roth M (2018) Unreal reality: an empirical investigation of augmented reality effects on spatial cognition in landscape architecture. Digit Landsc Archit Expand Boundaries Landsc Archit A Big Data World 3:150–162. <https://doi.org/10.14627/537642016>
- Tomkins A, Lange E (2019a) Augmented reality in flood risk communication. Landsc Archit 26(9):93–100
- Tomkins A, Lange E (2019b) Interactive landscape design and flood visualisation in augmented reality. Multimodal Technol Interact 3(2):43
- Tomkins A, Lange E (2020) Bridging the analog-digital divide: enhancing urban models with augmented reality. J Digit Landsc Archit 5:366–373. <https://doi.org/10.14627/537690037>
- Tomkins A, Lange E (2021) Where the wild things will be: adaptive visualisation with spatial computing. J Digit Landsc Archit 6:140–147. <https://doi.org/10.14627/537705011>
- Uran O, Janssen R (2003) Why are spatial decision support systems not used? Some experiences from the Netherlands. Comput Environ Urban Syst 27(5):511–526. [https://doi.org/10.1016/S0198-9715\(02\)00064-9](https://doi.org/10.1016/S0198-9715(02)00064-9)
- Walz A, Gloor C, Bebi P, Fischlin A, Lange E, Nagel K, Allgöwer B (2008) Virtual worlds—real decisions: model-and visualization-based tools for landscape planning in Switzerland. Mt Res Dev 28(2):122–127

- Wang X (2009) Augmented reality in architecture and design: potentials and challenges for application. *Int J Archit Comput* 7(2):309–326. <https://doi.org/10.1260/147807709788921985>
- Wloka MM, Anderson BG (1995) Resolving occlusion in augmented reality. In: Proceedings of the 1995 symposium on interactive 3D graphics (I3D'95), pp 5–12. <https://doi.org/10.1145/199404.199405>

**Open Access** This chapter is licensed under the terms of the Creative Commons Attribution-NonCommercial 4.0 International License (<http://creativecommons.org/licenses/by-nc/4.0/>), which permits any noncommercial use, sharing, adaptation, distribution and reproduction in any medium or format, as long as you give appropriate credit to the original author(s) and the source, provide a link to the Creative Commons license and indicate if changes were made.

The images or other third party material in this chapter are included in the chapter's Creative Commons license, unless indicated otherwise in a credit line to the material. If material is not included in the chapter's Creative Commons license and your intended use is not permitted by statutory regulation or exceeds the permitted use, you will need to obtain permission directly from the copyright holder.





# Chapter 10

## Urban Planning Exhibition Halls in the Pearl River Delta for Planning Communication and Public Participation



Xi Lu, Sigrid Hehl-Lange, and Eckart Lange

**Abstract** Planning exhibitions are one of the tools for raising awareness and civic engagement in urban planning, yet their effectiveness has hardly been examined in practice. This study aims to quantify the impact of the urban planning exhibition halls (UPEHs) in China on planning communication and public participation. The Guangzhou UPEH, a vital knowledge hub in the Pearl River Delta (PRD), is used as a case study. Using a repeated measures design, 115 adult visitors to the Guangzhou UPEH were randomly recruited and surveyed before and after visiting. Participants' knowledge of and degree of involvement in urban planning significantly improved after their visits. Levels of education, prior knowledge and visiting length were found to influence specific dimensions of knowledge acquisition. The study highlights implications for the potential of planning exhibitions for better engaging with the general public in the planning process.

**Keywords** Planning communication · Public participation · Urban planning exhibition hall

### 10.1 Introduction

Engaging the general public at a higher rung of Arnstein's (1969) ladder of citizen participation remains an important challenge in contemporary planning processes (Tewdwr-Jones et al. 2020). Enhanced public awareness is necessary for fostering a better understanding of the value of planning and progress (Council of Europe, 2004, 2008). Internationally, the role of planning exhibitions towards increasing

---

X. Lu (✉)

College of Landscape Architecture, Nanjing Forestry University, Nanjing 210037, China

e-mail: [luxi@njfu.edu.cn](mailto:luxi@njfu.edu.cn)

S. Hehl-Lange · E. Lange

Department of Landscape Architecture, The University of Sheffield, S10 2TN Sheffield, UK

e-mail: [hehllange@gmail.com](mailto:hehllange@gmail.com)

E. Lange

e-mail: [e.lange@sheffield.ac.uk](mailto:e.lange@sheffield.ac.uk)

© The Author(s) 2023

S. Nijhuis et al. (eds.), *Adaptive Urban Transformation*, The Urban Book Series,

[https://doi.org/10.1007/978-3-030-89828-1\\_10](https://doi.org/10.1007/978-3-030-89828-1_10)

civic engagement and communication in urban planning has been highlighted in a series of theories and practices. From the ‘White City’ presented in the 1893 World’s Columbia Exposition in Chicago, to the prototype of the ‘Outlook Tower’ in Edinburgh by Patrick Geddes (1915), to the ‘Futurama’ ride in New York’s World Fair in 1939, to ‘Barcelona in Progress’, a permanent exhibition featured in a 1:1,000 scale city model in 2004, to the concept of the ‘Urban Room’ proposed by Farrell (2014) and implemented in over 15 cities and towns in the UK (Tewdwr-Jones et al. 2020), various forms of past, present and future urban change have attracted visitors through diverse media.

Planning exhibitions worldwide vary due to the differences in funding bodies and planning systems (Tewdwr-Jones et al. 2020). The urban planning exhibition halls (UPEHs) in China are a similar example, which differ from others in terms of their huge number and scale. Since the first UPEH was built in Shanghai in the late 1990s, it has spread over the country at an unprecedented rate, totalling 880 UPEHs by 2017. The UPEH provides a platform to understand the past, present and future of a specific geographical area (Lu et al. 2020). As stated by the China Association of Urban Planning (CAUP 2007), the mission of the UPEH is to enhance planning communication and public participation, while some scholars have seen it rooted more in top down hierarchical power and city branding (de Jong et al. 2018; Fan 2014; Lai 2009).

Until now there is a considerable gap in knowledge about UPEHs and they have hardly been examined in practice, particularly from a quantitative perspective. Therefore, this study seeks to quantify the effectiveness of the UPEH in planning communication and public engagement. The contextual model of learning by Falk and Dierking (2016) provides a theoretical framework for understanding the dynamics of the individual learning process and outcome, in the example the UPEH suggesting that participants’ knowledge acquisition is jointly affected by their personal, social and physical contexts. The study focuses on two questions: (1) Are there differences in the knowledge acquisition and participation level in urban planning before and after the public’s visit to the UPEH? And if there are, (2) How do personal, social and physical factors interact with their changes in knowledge and participation in the UPEH?

## 10.2 Methods

### 10.2.1 Case Study

The Pearl River Delta (PRD) region refers to the dense city network in the Guangdong Province, including Guangzhou, Shenzhen, Zhuhai, Dongguan, Zhongshan (<https://en.wikipedia.org/wiki/Zhongshan>), Foshan (<https://en.wikipedia.org/wiki/Foshan>), Huizhou (<https://en.wikipedia.org/wiki/Huizhou>), Jiangmen (<https://en.wikipedia.org/wiki/Jiangmen>) and Zhaoqing (<https://en.wikipedia.org/wiki/Zhaoqing>) with approximately 78 million inhabitants. It includes the Special Administrative Regions

**Table 10.1** UPEHs in the Pearl River Delta

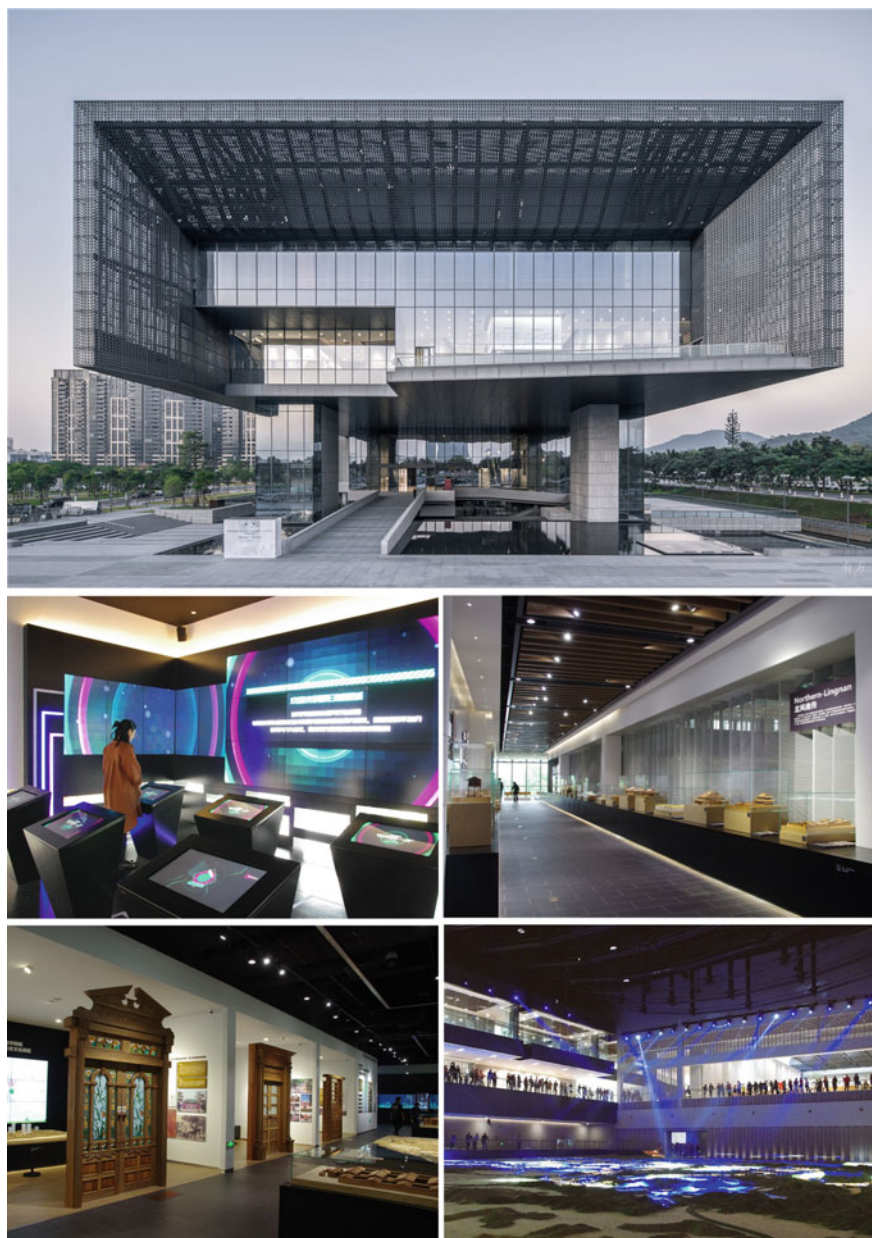
City	Name	Year of opening	Floor space (m <sup>2</sup> )	Media richness	Social impact	Accessibility
Dongguan	Dongguan Urban Planning Exhibition Hall	2017	15,000	***	**	***
Foshan	Foshan Urban Planning Exhibition Hall	2019	20,000	***	**	***
Guangzhou	Guangzhou Urban Planning Exhibition Hall	2018	84,000	***	***	***
	Nansha Pearl Bay Exhibition Hall	2016	3,800	**	*	*
Hong Kong	Hong Kong City Gallery	2012	3,000	*	**	***
Shenzhen	The Museum of Contemporary Art & Planning Exhibition	2020	88,185	***	***	**
	Bao'an District Urban Planning Exhibition Hall	2016	5,300	**	*	**
Zhuhai	Zhuhai Hengqin Urban Planning Exhibition Hall	2012	22,242	**	*	*

*Note* “\*” to “\*\*\*” indicates performance in the particular parameter, verified by the fieldwork of the first author

(SARs) of Hong Kong and Macau as well. There are a total of eight UPEHs in this region (Table 10.1). Using parameters including exhibition size, media richness, social impact and accessibility, the Guangzhou UPEH was selected as a focus of this study (Fig. 10.1). It occupies an exhibition area of 30,000 square metres and contains 119 sets of exhibitions over four floors. The exhibition content covers a range of topics regarding the past, present and future of Guangzhou, such as history, geography and culture, future planning, transportation, utilities and landscape environment.

## 10.2.2 Methodological Framework

Drawing on Falk and Storksdieck (2005), a repeated measures design approach was adopted to examine whether there are changes in knowledge and participation in



**Fig. 10.1** The Guangzhou UPEH and selective exhibits within it. *Photos Xi Lu*

**Table 10.2** Framework of research method

Group	Before visits	During visits	After visits
Experiment group	Personal info Self-assessment Test questions	Walking interview Record their time of duration in each exhibit	Re-evaluate self-assessment Revise test questions
Control group	Personal info Self-assessment Test questions	N/A	Re-evaluate self-assessment Revise test questions

urban planning after people spent time in the Guangzhou UPEH. Participant selection was designed to be unbiased and representative of the typical visiting public of the Guangzhou UPEH. One adult from every fifth group of visitors was randomly approached at the UPEH entrance and invited to participate in the experiment. As is shown in Table 10.2, participants were classified into two groups. The experiment group (n = 55) received questionnaires before and after their visit and a walking interview during their visit. The control group (n = 60) completed a questionnaire before and after their journey without the researcher’s presence. The walking interview data is discussed by Lu et al. (2020), and the primary focus of this study is on the data collected before and after visiting.

Building upon Falk and Dierking (2016), we collected participant data regarding personal, physical and social-cultural dimensions before and after their visits. This included age, gender, education level, familiarity with the city, prior knowledge, whether they came alone or with a group, if they were guided or not, researcher presence and the total length of their time in the exhibition.

Three types of measurements of knowledge acquisition with varying complexity were used before the journey: (1) a self-assessment of participant knowledge level based on a Five-Likert scale from ‘minimum or none’ to ‘very high’, (2) nine single-choice questions based on different facts about urban planning in Guangzhou and (3) an open-ended question to test participants’ comprehension of different knowledge dimensions of urban planning in Guangzhou. The questions were discussed with the local staff to ensure that they covered the key points as conveyed by the exhibition. Concerning visitors’ level of participation in urban planning, a self-assessment was conducted based on a Five-Likert scale ranging from none or minimal participation, informed about planning, involved in consultation and collaboration with others, to empowerment (Arnstein 1969).

Upon finishing their journey in the Guangzhou UPEH, the questionnaire was shown again to the participants. Given the time limitation and possible fatigue for repetitive work, they were asked to re-evaluate their knowledge level and participation extent in urban planning, revise their answers for the single-choice questions and supplement their responses to the open-ended questions.

### 10.2.3 Data Analysis

The personal, social and physical factors were calculated through descriptive analysis in SPSS version 26. The participants' self-assessment data on their knowledge and participation levels was analysed on a basis of 1–5. Single-choice questions were evaluated according to the standard answers with a score of one for a right answer and zero for a wrong answer. Drawing on Falk and Dierking (2016), the open-ended question results were measured by the breadth and depth of the answers. The breadth of responses is defined by the number of conceptual categories proposed by participants. The score ranges from 0–8, representing the answer out of a total of eight non-overlapping categories in the exhibition, including urban development and layout, future planning, economy and geography, landscape and environment, history and culture, historical preservation of ancient buildings and districts, transportation and utilities. The depth of responses is classified into six levels based on the level of detail and sophistication in the answers provided within each conceptual category. A score of 0–5 was used to represent the level of detail ranging from none, extremely limited, somewhat limited, generally adequate and fairly good to excellent. The user data was scrutinised and measured using the aforementioned standard and cross-checked by a research assistant.

To examine the difference between the outcomes prior to and after their visit, as well as the influencing factors on the changes in learning and extent of participation, the normality of participants' scores in different parameters was first measured with the Shapiro–Wilk test (Field 2013). The dependent variables were not distributed normally; thus, the Wilcoxon Signed Ranks Test was used to analyse the difference in mean scores and evaluation levels before and after their visit. The ordinal regression was used to examine the effects of different personal, social and physical factors on changes made in their self-assessed knowledge level, participation degree and single-choice questions. The Analysis of Covariance (ANCOVA) was used to detect the difference between the means of different independent groups for the open-ended questions.

## 10.3 Results

Between the data collection period from October 2018 to January 2019, there were altogether 115 effective participants involved in the experiment. The personal (age, gender, education level, occupation and familiarity with the city), social (if they came alone or with a group, if they were guided or not and researcher presence) and physical (visit length) factors that were hypothesised to influence the outcomes in learning and level of participation are shown in Table 10.3. Prior knowledge, as an additional hypothetical influencing factor, was determined by the participant's score before each visit.

**Table 10.3** Personal, social and physical environment of the UPEH

	Factor	Number	Proportion (%)
Gender	Male	62	53.9
	Female	53	46.1
Age	18–34	73	63.5
	35–54	31	27
	55 +	11	9.6
Level of education	High school, college and below	18	15.7
	University	70	60.9
	Master's and above	27	23.5
Familiarity with the city	Foreigner and people from SARs	4	3.5
	Visitors from mainland China excluding Guangzhou	24	20.9
	Local (<5 years)	23	20
	Local (>5 years)	64	55.7
Occupation	Government official	8	7.1
	Professionals and students in the built environment fields	16	14.2
	Professionals/students in the media/interior field	13	11.5
	Investor/businessman/policy-related	6	5.3
	Others	70	61.9
Researcher presence	With researcher	55	47.8
	Without researcher	60	52.2
Come alone or with a group	Alone	29	25.4
	In a group without kids	65	57
	In a group with kids	20	17.5
With guide or not	With guide whole process	14	12.4
	With guide periodically	7	6.2
	Without guide	92	81.4
Visiting length	0.13–4.5 h	115	100

The participants' knowledge levels significantly increased in all three tests. The mean score of self-evaluation of knowledge ( $M = 2.91$ ) after visiting was 0.8 points higher than the prior self-evaluation level ( $M = 2.10$ ) ( $p < 0.001$ ). The mean score of the single-choice questions was 4.08, and it increased to an average of 5.98 after each visit ( $p < 0.001$ ). Concerning the open-ended questions, the scores improved significantly in both depth and breadth dimensions. The average breadth of knowledge was 1.37 out of eight exhibition themes before visiting, and it increased to an average of 2.5 in the post-visit evaluation ( $p < 0.001$ ). The mean depth of the participants' knowledge increased from 2.85 to 6 after their visit ( $p < 0.001$ ). Regarding

level of participation in urban planning, there was also a significant increase in their self-assessment results from before visiting ( $M = 1.51$ ,  $SD = 0.842$ ) to after visiting ( $M = 2.05$ ,  $1.016$ ) ( $p < 0.001$ ).

Ordinal regression and ANCOVA tests were applied where appropriate to examine the significant differences between personal, social and physical factors in the changes in knowledge and participation levels in urban planning. Age, gender, occupation, familiarity with the city, whether they came alone or not, whether or not they used a guide and the researcher's presence did not significantly influence participants' knowledge acquisition and the extent of participation. However, prior knowledge, level of education and the visit length were significant predictors of the changes in specific knowledge tests.

An increase in prior knowledge level was associated with a decrease in the odds of having a higher knowledge level, with an odds ratio of 0.232 (95% Confidence Interval (CI), 0.108 to 0.499). Wald Chi-Squared test (or Wald test) showed a significant effect of prior knowledge level,  $\chi^2(1) = 13.988$ ,  $p < 0.001$ . For the factual knowledge revealed by single-choice questions, an increase in prior accuracy was linked to a decrease in the odds of improvement, with an odds ratio of 0.959 (95% CI, 0.930 to 0.989), Wald  $\chi^2(1) = 6.986$ ,  $p = 0.008$ . In contrast, an increase in time spent visiting the UPEH was positively linked to the odds of improvement in single-choice questions, with an odds ratio of 5.640 (95% CI, 2.4 to 13.2), Wald  $\chi^2(1) = 15.8$ ,  $p < 0.001$ .

Regarding the open-ended questions, there was a significant difference in mean depth gain [ $F(2,105) = 5.892$ ,  $p = 0.004$ ] between the level of education. Post hoc tests using Bonferri's test revealed a significant difference between master's level and above and high school level or lower ( $p = 0.006$ ) as well as between university level and master's level and above ( $p = 0.017$ ). People with a higher level of education are more likely to have an increased depth of knowledge ( $M = 4.58$ ) compared to those who hold a degree of high school level or below ( $M = 2.18$ ) and university level ( $M = 2.99$ ).

## 10.4 Discussion

The study showed that visitors to the Guangzhou UPEH improved significantly in terms of knowledge acquisition in urban planning. This is in line with the finding of Fan (2014) through the post-evaluation of visitors to the UPEHs in Shanghai, Nanjing, Hangzhou and Chongqing, where visitors were generally satisfied with the function of information dissemination. It supports the official function stated by CAUP (2007), and provides empirical backing for the framework proposed by Geddes (1915) and Farrell (2014). Similar to the results of Falk and Dierking (2016), demographic variables such as age, gender, familiarity with the city and occupation did not significantly influence knowledge increase. Social factors, including the nature of the visiting group, the presence of a tourist guide and the researcher bias



did not play a significant role either. These findings suggest that the UPEH could serve as a platform for inclusive learning for the general public.

People with less prior knowledge were found to be more likely to improve significantly in both the self-assessment and factual questions. Those with a higher education level were linked to an increased possibility of enhancing the depth of complicated knowledge. This suggests that people with varied knowledge backgrounds can visit the UPEH and improve in different knowledge dimensions. The results also revealed that people with a lengthier visit were more likely to gain more factual knowledge. This implies that the UPEH should focus on retaining visitor attention in order to enhance learning effects. Possible ideas for exhibition design could include using exhibits with larger dimensions, presentations through multi-media devices and presenting information that focuses on the city and site scale (Lu et al. 2020).

Despite a significant increase in participation level after visiting the UPEH, the value of the participation level remains at a relatively low level ( $M = 2.05$ ), falling just slightly over the 'information' rung in the ladder of citizen participation. In addition, none of the social, personal and physical factors investigated in this study played a role in its change. Post-interviews with participants and fieldwork across different UPEHs in the PRD suggest several possible causes: (1) participants are provided with limited opportunities to express their needs and suggestions at the UPEHs, (2) the space provided for feedback is not in the main circulation route in the UPEH and therefore not easily discovered and (3) the public are not aware of and confident with their right to participate and they believe that any attempt to do so will be in vain. This suggests that there is room for improvement in public awareness and setup of the UPEHs for greater public engagement.

## 10.5 Conclusion

This study seeks to understand the role of the UPEH in planning communication and public participation by using the example of the Guangzhou UPEH. A repeated measures design approach was adopted to test the knowledge acquisition and level of involvement before and after participants' visits. The study has demonstrated the effectiveness of the UPEHs for raising public awareness of urban planning after their visits. The personal, social and physical factors generally did not prove to have a significant effect on changes in self-assessment and objective tests. However, participants' prior knowledge, education level and visit length were found to influence changes in specific dimensions of knowledge.

The findings call for the UPEHs to provide more opportunities for effective public involvement. The initiatives at the Hong Kong City Gallery may serve as an example for offering the public a higher level of interaction with urban matters, rather than just being informed about them. This includes providing a wide range of materials, consultations, seminars and workshops to make planning contents more accessible.

This study primarily focussed on whether individuals acquired a new or enhanced understanding of the facts and/or concepts regarding urban planning shortly after

spending time within the Guangzhou UPEH. Memory restoration consists of short-term, long-term and working memory (Cowan 2008). Short-term memory may be accompanied by temporal decay and chunk capacity limits. Therefore, future research could examine public perception of urban planning over a longer period of time. Furthermore, increased learning in the museum could have a wide range of potential outcomes, including gaining skills, developing interests, improving attitudes and emotions and changing behaviours (Hooper-Greenhill 1991). Future research could examine other dimensions of learning outcomes to get a holistic understanding of the effectiveness of the UPEHs.

**Acknowledgements** This research is supported by Nanjing Forestry University Metasequoia Talents Research Start-up Funding [No. 163120129], the Joint China Scholarship Council—University of Sheffield PhD programme [No. 201706090252]; IJURR Foundation Writing-up Grants 2021; and the Newton Fund/Engineering and Physical Sciences Research Council (EPSRC) as part of the Sustainable Deltas award [No. EP/R024979/1]. The Adaptive Urban Transformation research project is a collaborative project of Delft University of Technology (TU Delft), South China University of Technology and The University of Sheffield.

## References

- Arnstein SR (1969) A ladder of citizen participation. *J Am Plann Assoc* 35(4):216–224. <https://doi.org/10.1080/01944366908977225>
- China Association of City Planning (2007) The professional committee of Chinese urban planning display was formally established. Wang Guangtao sent a letter to congratulate. Zhao Baojiang attended the inaugural meeting and made a speech. *Urban Planning Newsreport*, vol 24, p 6. Retrieved from <http://www.cnki.com.cn/Article/CJFDTotal-CSGT200724010.htm>
- Council of Europe (2004) European landscape convention. Retrieved from <https://www.coe.int/en/web/conventions/full-list/-/conventions/treaty/176>
- Council of Europe (2008) Guidelines for the implementation on the European landscape convention. Retrieved from <https://www.coe.int/en/web/landscape/guidelines-for-the-implementation-on-the-european-landscape-convention>
- Cowan N (2008) What are the differences between long-term, short-term, and working memory? *Prog Brain Res* 169:323–338. [https://doi.org/10.1016/S0079-6123\(07\)00020-9](https://doi.org/10.1016/S0079-6123(07)00020-9)
- De Jong M, Chen Y, Joss S, Lu H, Zhao M, Yang Q, Zhang C (2018) Explaining city branding practices in China's three mega-city regions: the role of ecological modernization. *J Clean Prod* 179:527–543. <https://doi.org/10.1016/j.jclepro.2018.01.098>
- Falk J, Storksdieck M (2005) Using the contextual model of learning to understand visitor learning from a science center exhibition. *Sci Educ* 89(5):744–778. <https://doi.org/10.1002/sc.20078>
- Falk JH, Dierking LD (2016) *The museum experience revisited*. Routledge
- Fan P (2014) Producing and consuming urban planning exhibition halls in contemporary China. *Urban Stud* 52(15):2890–2905. <https://doi.org/10.1177/0042098014536627>
- Farrell T (2014) The Farrell review of Architecture + the Built Environment. In: *Our future in place*, London. Retrieved from <http://www.farrellreview.co.uk/Downloads/TheFarrellreview.Pdf.1454326593>
- Field A (2013) *Discovering statistics using IBM SPSS statistics*. SAGE
- Geddes P (1915) *Cities in evolution: an introduction to the town planning movement and to the study of civics*. Williams, London

- Hooper-Greenhill E (1991) A new communication model for museums. In: Museum languages: objects and texts, pp 47–61
- Lai S-Y (2009) Museum as a representation of the city and an instrument of city image making Shanghai's urban planning exhibition centre. In: 2009 International conference on East Asian architectural culture, pp 225–237.
- Lu X, Hehl-Lange S, Lange E (2020) Landscape visualisation and visitor perception in the Guangzhou urban planning exhibition hall. *J Digital Landscape Archit* 5:330–339. <https://doi.org/10.14627/537690034>
- Tewdwr-Jones M, Sookhoo D, Freestone R (2020) From Geddes' city museum to Farrell's urban room: past, present, and future at the Newcastle city futures exhibition. *Plan Perspect* 35(2):277–297

**Open Access** This chapter is licensed under the terms of the Creative Commons Attribution-NonCommercial 4.0 International License (<http://creativecommons.org/licenses/by-nc/4.0/>), which permits any noncommercial use, sharing, adaptation, distribution and reproduction in any medium or format, as long as you give appropriate credit to the original author(s) and the source, provide a link to the Creative Commons license and indicate if changes were made.

The images or other third party material in this chapter are included in the chapter's Creative Commons license, unless indicated otherwise in a credit line to the material. If material is not included in the chapter's Creative Commons license and your intended use is not permitted by statutory regulation or exceeds the permitted use, you will need to obtain permission directly from the copyright holder.



**Part IV**  
**Socio-ecological Perspectives**

# Chapter 11

## Industrial Transformation and Sustainable Urban Planning in the Pearl River Delta: A Landscape-based Approach



Daniele Cannatella 

**Abstract** Industrialization in the PRD has brought about great economic growth and contributed to the rise and consolidation of this deltaic region as a key global player. However, it also generated severe environmental imbalances and pollution of vital and non-renewable resources, such as soil, water and air. Nowadays, the increasing shift towards service-oriented and innovation-driven sectors makes abandoned and decommissioned industrial areas available for transformation. However, to make the most of the potential of these areas to achieve sustainable urban development, novel approaches in planning and design practise are needed to tackle the complexity arising from the challenges posed by climate change and urbanization. This contribution provides a landscape-based approach to adaptive industrial transformation that looks at the spatio-temporal dimension, leveraging the intrinsic and relational qualities of these sites. The approach is tested through two applications in the Chancheng district (Foshan) and Haizhou (Guangzhou).

**Keywords** Industrial transformation · Landscape-based approach · Adaptive urban transformation · Sustainable urban design

### 11.1 Introduction

With around 60 million people living in the region, projected to be more than 120 million by the 2050s (Chan and Yao 2008; Zhu et al. 2002), the Pearl River Delta (PRD) is the fastest urbanizing delta in the world. Since the implementation of the economic reforms that marked the transition from a rural economy to an industrial one in the late 1970s, the PRD has been undergoing a series of sudden structural transformations that have not only affected the regional economy but also its spatial configuration and its relationship with the environment. Industrialization brought

---

D. Cannatella (✉)

Faculty of Architecture and the Built Environment, Delft University of Technology, Julianalaan 134, 2628 BL Delft, The Netherlands  
e-mail: [d.cannatella@tudelft.nl](mailto:d.cannatella@tudelft.nl)

about greater wealth and the recognition of the PRD as the ‘world’s factory’. The downside of this astonishing growth as a national and global key economic player is revealed in the environmental imbalance and the growing loss of social and ecological resilience due to the joint pressure exerted by urbanization and climate change, which threaten the long-term development of the region.

Today, the PRD is facing the same challenges as other urbanized deltas around the world, where industrialization and other anthropic activities alter water and sedimentary dynamics of the landscape (Tessler et al. 2015). Urbanization jeopardises the natural capacity of the floodplain to absorb and retain water, increasing both vulnerability and exposure of people and assets to flood events. Climate change impacts exacerbate such conditions, due to the uncertainty arising from the alteration of precipitation patterns caused by the shifting climate regime. In the PRD, the combination of these two factors result in increasing flood risks due to urbanization in flood-prone areas (Chan et al. 2021), air and water pollution due to industrial activities (Chan and Yao 2008; Zhu et al. 2002), the disappearance of mangrove forests (Zacharias and Tang 2010), ecological fragmentation and agricultural land loss (Yeh and Li 1999), water shortage (Yan et al. 2018), and the erosion of social and cultural values (Xiong 2016) amongst others.

To face these challenges and ensure a more sustainable future for the PRD, new approaches and strategies are needed to enhance its resilience to water-related risks, while simultaneously enhancing ecological conditions and the quality of life, leveraging the potential that those portions of territory left abandoned or underused by the transformative economic dynamics offer in rethinking the spatial development of the whole region.

In this regard, industrial transformation in the PRD serves as the ideal ground for investigating and proposing integrated approaches that go beyond the urgency of adapting to climate change, charting new trajectories that explore the potential of spatial solutions to offer a novel and more balanced relationship between human beings and the natural environment. As the manufacturing sector in the PRD is undergoing a fast restructuring, vast amounts of land are increasingly becoming available in urban, peri-urban and rural areas, presenting the opportunity for water and land restoration, water safety enhancement and socio-economic upgrading in urban areas. This multi-faceted palimpsest of vacant land acquires a territorial and landscape dimension that solicits multi-scalar and systemic approaches—ranging from the single fragment to the urban scale up to the large-scale systems that shape the region—to make the most out of their redevelopment. In this light, a landscape-oriented approach to industrial transformation provides methods and solutions to develop spatial strategies aiming at fostering ecological regeneration while contributing to more adaptive water management and a better quality of life.

This contribution presents an integrated landscape-based approach to industrial transformation for sustainable urban development in the PRD, exploring its potential on two urbanized areas in the delta: the Changchen historic district, in Foshan, and the Haizhu district, in Guangzhou. The paper is structured as follows: the following section provides an overview of the industrial transformation dynamics in the PRD over the past forty years, tracing the spatial outcomes of this process, as well as the

main social and ecological challenges that the delta is facing; section three elaborates on the opportunities and challenges in industrial regeneration, highlighting the increasing importance of the role of landscape in promoting sustainable adaptive strategies linked to industrial redevelopment; subsequently, a landscape-based adaptive industrial transformation approach is proposed and tested through the application on two case studies in the PRD. Finally, in the discussion and conclusions sections, the paper argues that industrial transformation can be a valuable tool to stimulate adaptation practises at the local scale and contribute to bridging the gap between adaptation and spatial planning.

## 11.2 Industrial Transformation in the PRD

The PRD is home to nine major cities on the mainland—namely, Guangzhou, Guangdong Province’s capital, Shenzhen, Foshan, Dongguan, Jiangmen, Zhongshan, Zhuhai, Zhaoqing and Huizhou—and the two Special Administrative Regions (SARs) of Hong Kong and Macao (Fig. 11.1). The region is nowadays one of the most economically vibrant and innovative mega clusters in China and in the world. With over 60 million permanent inhabitants, it is also the most populated and the largest urbanized deltaic region worldwide (Yeung 2010).

Since the implementation of the *open-door* policy in 1979, the PRD has experienced an unprecedented development led by industrialization that has dramatically changed its spatial and economic structure in just over forty years. This set of reforms aimed at transforming the regional economy, previously based on agriculture, into a manufacturing-based one, taking advantage of its proximity to two outposts of the Western world, Hong Kong and Macao. The establishment of the two Special Economic Zones (SEZs) of Shenzhen and Zhuhai in 1980, intended to attract foreign investment, turned out to be an extremely fortunate choice. In the first two decades

**Fig. 11.1** The Pearl River Delta. *Map* Daniele Cannatella



after the reforms, the PRD accounted for almost 70% of Guangdong's total GDP, and 91% of the province's export values (Shen et al. 2000). The regional economic growth is still reverberating in more recent times. In 2018, the PRD's GDP grew by an average 6.9%, accounting for 80.2% of the total GDP and the 95.1% of exports of Guangdong.<sup>1</sup>

However, this incredible economic development coincided with a progressive deterioration of environmental resources caused by uncontrolled industrial production. Intensive land use and manufacturing still affect both water quantity and quality. In 2015, the industrial sector in the PRD accounted for 37% of water use (1.4 times more than in the Guangdong Province and 1.6 times more than the national average) and was amongst the major contributors to wastewater discharge, resulting in 39% of water bodies to be classified as 'unfit for human touch'.<sup>2</sup>

To date, the ambition of the PRD is to position itself as a world-leading service-oriented and innovation-driven economy, as revealed in the Outline Development Plan for the Guangdong-Hong Kong-Macao Greater Bay Area (2019).

This raises a question as to what opportunities abandoned or decommissioned industrial land offers to jointly address socio-economic and ecological challenges to ensure sustainable urban development for the PRD and to adapt to changing climate regimes. To answer this question, it is necessary to understand what the transformative dynamics that have characterized the industrial development of the PRD over time are, and what the spatial and environmental implications at the different scales are.

### ***11.2.1 The Three Phases of Industrial Transformation in the PRD***

Before the reform era, the PRD was a grain-producing region, in which farming and aquaculture played a leading role in shaping basic land use patterns (Sepúlveda Carmona et al. 2014). The peculiar morphology of the delta, formed by sediments carried by the Xi, Bei and Dong rivers, and the massive presence of water represented the ideal conditions for waterway transportation, farm production and trade (Lin 1997). The almost total absence of rural–urban migration, along with the lack of investment in manufacturing and infrastructure, enormously hindered urban development. Major urban areas were mainly located in the central and western part of the delta. This was due to the resource scarcity of the eastern side, characterized by land of relatively recent river formation and high salt content, which made it unsuitable for intensive cultivation. The implementation of the open-door policy initiated a process that completely changed the face of the PRD, not only from a purely economic point of view, but also spatially.

---

<sup>1</sup> Guangdong Statistical Yearbook, 2019.

<sup>2</sup> See <https://www.chinawaterrisk.org/resources/analysis-reviews/pearl-river-delta-5-water-must-knows/>.



In the PRD, urbanization and industrialization are closely connected. During the first two decades after the implementation of the reforms, the consequent economic and spatial restructuring that occurred in the region was led by the rapid surge of rural industry. The deregulation of rural–urban migration and the inflow of foreign investment gave birth to rapid industrialization that took place mainly in the countryside. This process, known as rural industrialization, was characterized by mostly small-scale, labour-intensive and market-oriented industries based in rural villages and small towns. For this reason, during this phase, economic development did not correspond to actual urban growth. Rather, small towns played a dominant role in urbanization and land transformation process through the reclamation of nearby agricultural land. Between 1980 and 1990, more than 132,000 hectares of countryside were transformed into non-agricultural land, of which industrial expansion accounted for about one third (Lin 1997). The spatial outcome of this process was a peculiar landscape in which industrial, urban and agricultural land uses alternated, leading to a progressive blurring of the rural–urban borders. Most of the factories were small-sized and located at the entrance of towns and villages, along the main transportation axes or in the middle of rice fields. Rural industrialization and transport development were the main factors that promoted urban sprawl and land fragmentation. In addition, rural industry, as spontaneous and unregulated process, created serious environmental consequences. Many of these industries did not have the technology for proper treatment of industrial waste, and often wastewater was released directly into streams and rivers, leading to serious contamination of farmland, crops and fishponds (Lin 1997).

At the dawn of the new millennium, changing social conditions and the rising concern on environmental issues started a new regional restructuring process that saw the progressive abandonment of manufactories in the central delta. The increasing lack of low-cost labour, alongside the rise of minimum wage, forced industries to move towards more inland areas in the Guangdong Province, economically more convenient. During this phase, industrial parks specifically designated to host the relocated manufactories popped up throughout the province. Simultaneously, this process inaugurated the first wave of transformation of industrial areas, in particular those close and within the main cities. However, early industrial parks were characterized by a condition of separation between production and the city (Chao 2018).

The last phase is connoted by a shift of focus from urban development towards innovation-driven redevelopment of existing construction land. With the increasing control of land use and a change of course towards more sustainable development models, manufacturing sites located in inner areas began to be relocated to the urban fringe, and the redevelopment of idle industrial sites took hold, mainly through the regeneration of ‘old towns, old factories and old villages’ programme, initiated in 2009. The ‘Three Olds’ policy aimed at adjusting, transforming and upgrading industrial land located within towns, streets, villages and industrial parks to improve urban functions and the quality of life in cities and countryside. These comprehensive urban upgrading measures involved a total of 126 km<sup>2</sup> of industrial land in Shenzhen alone, and 171.66 km<sup>2</sup> in Guangzhou (Schoon 2014), and saw the emergence of

**Fig. 11.2** OCT loft area.  
 Photo Daniele Cannatella



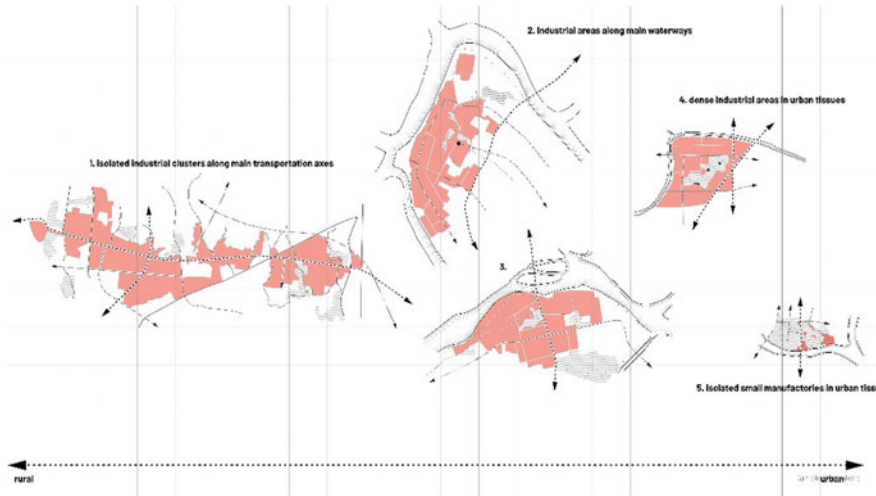
creative parks, recreational facilities, new industries and an overall increase in public green space within the two cities. One example is the OCT loft (Fig. 11.2), an old factory located in the western industrial zone of Shenzhen that was redeveloped in a creative industry district with exhibition space, artists' studios, restaurants and bars.

Meanwhile, the recent construction of the Hong Kong-Zhuhai-Macao bridge and the development of the Shenzhen-Zhongshan bridge, aiming at connecting the two sides of the estuary, raises the question of what will be the future of cities such as Zhongshan and Jiangmen, on the western side of the delta, where farmland is still characterized by relatively high integrity and spatial continuity (Cannatella 2019).

### ***11.2.2 Industrial Typologies in the PRD***

In the PRD, the industrial landscape is a ubiquitous, multi-faceted spatial phenomenon which acquires many forms and creates an infinite number of relationships with the natural and cultural systems that form the delta. Manufacturing spaces are found in the interstices of urban centres, in urban villages surrounded by the dense city, compressed between the city and streams, or in the open countryside, connected by major transportation axes. Their pervasiveness represents in fact a spatial framework articulating the physical continuity of open space that connects along the main transport corridors, grafts along the edges of the cities and provides potential space for adaptation in urban areas.

These qualities constitute an enormous potential for the exploration of multi- and cross-scale strategies to intercept and enhance the performance of large-scale structuring systems (such as the water system, mobility, ecological areas and corridors) that go beyond the administrative boundaries. Although it is difficult to trace an exhaustive map of industrial areas in the PRD, due to the lack of accessibility to official information and the extent of the region, looking at their spatial qualities it



**Fig. 11.3** Four main industrial typologies in the PRD. *Image* Daniele Cannatella

is possible to distinguish at least four main types of industries, located in different contexts (Fig. 11.3):

- **Industrial areas along main waterways:** these areas are located in the proximity of main rivers and/or streams. Often, they constitute a buffer between urban settlements and riverways, with main transportation axes that guarantee high accessibility while physically separating them from other areas with different land uses; furthermore, most of the time they are equipped with piers and docks for water transportation;
- **Isolated industrial clusters along main transportation axes:** located in rural or peri-urban areas, these industrial parks and manufactories are marked by high accessibility due to the presence of high-speed motorways. Although the presence of waterways is not a main feature, they encroach agricultural land and dyke-ponds, resulting in the fragmentation of the natural landscape;
- **Dense industrial areas within urban tissues:** these areas find themselves in the urban fringes, or around historical settlements; here, waterways are often buried as a consequence of urban development;
- **Isolated small manufactories in urban tissues:** the last typology is common especially in urban areas, and characterized by the presence of urban villages, fragments of agricultural land and remnants of wider dyke-pond systems. Since their development was more spontaneous and less regulated, it is easy to find them along canals that still mark the spatial structure of urban villages.

## 11.3 Industrial Transformation: From Industry to the Production of Multiple Values

Although fundamental for economic development, industrial production is characterized by an exquisitely linear, input–output relationship between mankind and nature in which man takes the necessary resources from the environment and discharges waste and scraps into the biosphere. This attitude has proved to be not only economically unsustainable in the long run, but also harmful for people’s health and the ecosystem. Starting in the last decades of the past century, with the crisis of the Fordist model, the discourse on abandoned industrial sites begun to emerge overbearingly (Waldheim 2016), with the landscape called upon to play a fundamental role in redeeming such places and reintegrating them into active and healthy urban dynamics, for its ability to stimulate multi-scale and adaptive strategies towards long-term resilience and socio-ecological sustainability (Gasparrini 2016).

However, despite the efforts in redevelopment practises, the pervasiveness of abandoned and polluted areas has reached a global extent. In Europe, there are almost 350,000 identified contaminated sites (Pérez et al. 2017); similar figures are present in the US as well, where between 500,000 and 1,000,000 brownfields have been estimated (Thornton et al. 2007). The plight is no different in emerging global economies. In China, polluted sites that need interventions are in the order of tens of millions of hectares (Li et al. 2017), with more than 100,000 factories closed in the last twenty years and over two million hectares of contaminated land left abandoned and untreated only in the main cities (Han et al. 2018). This has led idle industrial areas to emerge as an actual category of landscape, characterized by great diversity of size and former functions, sharing a common condition of contamination and vacancy (Oliver et al. 2005). This state of vacuity reverberates in both space and time and makes them spaces of transition from one use to another, physically and mentally detached from any urban function or process.

However, the benefits of reintegrating such lands in the urban landscape are manifold. Their redevelopment offers the opportunity to steer regional development towards a more sustainable future, enabling the possibility to intervene and redirect those natural, social and economic flows that shape cities, creating the ideal conditions for such flows to materialise (Bélanger 2009), adjusting the existing spatial forms and functions that require adaptation (Kempenaar and Brink 2018) and laying the foundations for more efficient and sustainable land development.

### 11.3.1 *Opportunities and Challenges in Industrial Transformation*

Linking sustainable urban development to adaptation strategies implies redesigning abandoned and underused areas, to remediate pollution when necessary, and improve

local social, economic and ecological conditions while lowering the vulnerability of urban and natural systems.

Turning the gaze on industrial transformation helps preserving those untouched open spaces and *greenfields* that are at the urban edges, avoiding further land consumption (Ashley et al. 2011). At the same time, these sites are more accessible than suburban greenfields, because of their proximity to dense urban areas and the presence of already existing infrastructure (Hollander et al. 2010). These conditions make industrial redevelopment more desirable, as the possibility of reusing features such as roads and sewer lines can counterbalance the high costs needed for clean-up. Furthermore, their reuse often implies recycling and remediating land, to protect and restore soil, groundwater and surface water qualities, thus enhancing public health and safety (De Sousa 2001) and providing additional ecological value within the urban landscape.

The benefits of remediation and redevelopment go beyond the physical boundaries of industrial sites. The conversion of brownfields to green infrastructure is closely connected with biodiversity restoration and the provision of multiple ecosystem services (Atkinson et al. 2014; Bardos et al. 2016), such as protection and water management at different spatial scales (De Graaf 2012), heat island effect mitigation in the surrounding urban areas (De Valck et al. 2019), and local air quality improvement. Furthermore, brownfield redevelopment can generate positive impacts on both society and economy, triggering urban cores renewal processes, thus improving the overall quality and liveability in urban areas and providing additional public green space where it is lacking (Mathey et al. 2015), revitalising surrounding communities by reducing their shrinking property values (De Sousa 2001). Industrial transformation can support attracting both domestic and foreign investment and stimulate local economies and green jobs. Investments on novel functions and programmes (e.g. housing, retail, green industry and service sector), attract both investors and new residents, thus contributing to social and economic diversification and increasing the level of safety of residents (Karwalska and Mazur-Belzyt 2020). Lastly, it can support the preservation of historical, cultural and aesthetic values inherited in these sites, as the vestiges of past forms of industrial development are intertwined to the identity of a place and materialized in such spaces.

Despite the multiple benefits associated with industrial transformation, many aspects, mainly related to site remediation practises, are in fact challenges that represent an obstacle to its more systematic and consistent application.

Idle industrial areas have often been left abandoned by potentially pollution-intensive production activities. Therefore, fundamental resources such as soil, groundwater and surface water might contain high levels of contaminants, posing a threat for human beings and other living organisms. Traditional redevelopment practises can involve high clean-up costs for remediation, which can make investments unprofitable and generate waste that has to be treated. Remediation practises depend on several factors linked to the type of contamination, its location and magnitude. This implies that there is no single way or technique to tackle pollution; rather, remedial actions can vary a lot, ranging from the removal of a modest amount of soil to large-scale and complex engineering works entailing building demolition and soil

and water body remediation (Hollander et al. 2010). In recent times, nature-based solutions such as phytotechnologies have proved to be a valid alternative to traditional remediation practises. Phytotechnology entails the use of vegetation to remediate and contain contaminants in soil, sediments and groundwater (Kennen and Kirkwood 2015). Plant-based clean-up methods can reduce remediation costs by more than 90% compared to traditional techniques (Glass 1999), are passive, solar energy-driven and can improve soil quality. However, their effectiveness depends on the typology of contaminants and their location and requires a long-term approach that may preclude other short-term programmes on the site. This might result in conflicts between short- and long-term redevelopment goals, therefore requiring flexible and open-ended strategies, where nature-based remediation techniques and processes can ideally dictate redevelopment stages and steer future urbanization. The advantage of using this type of nature-based solutions in industrial transformation practises is that they can be integrated into different design strategies, from small-scale landscape interventions on vegetation and landform to urban redevelopment and adaptation plans, up to regional design, thus supporting sustainable urban development.

#### **11.4 An Integrated Landscape-based Approach to Industrial Transformation for Sustainable Urban Development**

Sustainable urban development in urbanizing deltas implies guaranteeing a long-term, dynamic equilibrium amongst three distinct dimensions: water safety, ecological values, economic growth and quality of the living environment (Meyer and Marchand 2015). When translated into industrial redevelopment, this calls for novel approaches in planning and design practises, to systemically tackle the complexity arising from different challenges and coordinate the different remediation objectives that have different temporal horizons (Fig. 11.4).

To fully exploit the potential of industrial transformation in achieving the aforementioned objectives in the PRD, a landscape-based industrial transformation approach that is systemic, opportunistic and integrated is advocated.

It must operate on different systems, connecting site redevelopment to both natural and urban elements and processes, via multi- and cross-scalar strategies ranging from the local to the regional scale. This requires looking for spatial solutions to improve existing ecological structures and urban functions (e.g. the establishment of green corridors along riverways or the implementation of creative districts). It is opportunistic, in that it addresses the different stages of the site's lifecycle while taking advantage of both social and ecological 'pioneering' processes that already exist in the area, as well as the existing architectural and natural assets, to develop flexible and shared strategies to be implemented through a phased, incremental approach. Lastly, it requires the integration of different knowledge, actors and professionals to deliver multiple values, be ecologically active, socially inclusive and economically.

**Fig. 11.4** Industrial transformation and sustainable urban development. *Image* Daniele Cannatella



### ***11.4.1 Key Phases of the Approach***

The proposed landscape-based approach to industrial transformation is developed on the basis of the work of Nijhuis et al. (2019) and consists of four different iterative steps: collecting information, gaining understanding, strategy development and action perspective (Fig. 11.5). These steps are introduced below.

#### **11.4.1.1 Collecting Information and Gaining Understanding**

Before starting the design, it is necessary to determine what the objectives and the priorities of the site redevelopment strategy are. This has to be based on an effective and comprehensive knowledge of the site and the development trajectories desired by the stakeholders involved to have an overview of the opportunities that the site offers and challenges that must be faced. Challenges comprise the limitations imposed by the site conditions (e.g. the type and quantity of pollutants) that can slow down or prevent certain long-term programmes (housing, public schools, etc.) and/or hinge the use of nature-based solutions for remediation.

This phase entails the systematic collection and creation of data and information to perform critical analysis and evaluation of the site. This concerns two main aspects: the intrinsic characteristic of the site and its extrinsic properties that reveal its relational potentials. The latter concerns its geographical position, the adjacent land use (e.g. urban, peri-urban and rural context), and the spatial relationships that it establishes—or can potentially establish—at different scales with both landscape

**Fig. 11.5** Key phases of the landscape-based industrial transformation approach (Adapted from Nijhuis et al. 2019)



and urban features. Furthermore, this phase includes the identification of actors—existing or potential—who may have an interest in the site redevelopment or can play a relevant role in the redevelopment process. The questions to start from regard both the intrinsic and relational aspects. These include, amongst others: (1) What is the state and intensity of the pollution of natural resources (e.g. soil, surface water and groundwater, air)? That is, what are the pollutants that persist on the site, and where they are located. (2) What are the natural (e.g. spontaneous vegetation, water bodies, canals and ditches, open green areas) and anthropogenic (e.g. buildings, infrastructures, paved areas, piers and docks) elements in the area, and what is their state of decay? (3) What are the existing formal and informal uses and practises on the site? (4) What are the existing and/or latent spatial relationships that the site intertwines with the surrounding urban and natural landscape?

Addressing these questions means starting a process of description, selection and evaluation of the elements and limits imposed by the site, to build a preliminary knowledge base for the subsequent development phase of the project.

In addition, this knowledge serves to define the main challenges to be faced, and the opportunities that the site presents in relation to the territory, for example, in consolidating or building green–blue infrastructures or restoring ecological connections at larger territorial scales; or establish new urban centralities, public spaces and services that the surrounding neighbourhoods can benefit from; or define the potential of the site to mitigate water-related risks; or the level of accessibility it offers in relation to its geographical position and the degree of mobility infrastructure it presents. Lastly, understanding what actors, uses and hidden uses exist, as well as identifying stakeholders and experts to involve in the redevelopment process can help to gain acceptance and avoid potential conflicts for future programmes.



### 11.4.1.2 Strategy Development and Action Perspective

After the analysis and synthesis phases, with the definition of the main challenges and opportunities, the next step is the development and testing of integral and multiscale design strategies. The questions to be addressed at this stage are: (1) What are the techniques and processes that can be implemented for remediating the site? (2) How to preserve or reinforce the formal, ecological and socio-cultural values of the site? (3) What is the temporal horizon of remediation processes, and what are the temporary or final uses and programs that can be implemented accordingly? (4) How is it possible to make the most of the site's potential by means of multi- and cross-scale projects to ensure that the intended uses, vegetation, water and existing infrastructures can facilitate the provision of ecosystem services and socio-economic development? (5) Who are the important actors that need to be involved, and how to actively involve them in the process to ensure social acceptance, economic feasibility and optimal ecological performance? (6) How to synchronize long-term objectives and processes with short-term design intervention, to avoid possible conflicts and pursue an incremental and flexible development strategy?

To answer these questions, a survey of previous studies and best practises is useful to discern what principles and strategies can find an effective application on the site. Research through design and design thinking are a useful way to investigate the possible spatial configurations of the application and evaluate the impacts of the latter. In particular, visual exploration is also important for communicating project choices and co-assessing the effectiveness and feasibility of project alternatives with stakeholders, experts and local communities.

At this stage, it is also important to define a reasonable time plan that can support a robust and flexible strategy, where technical and ecological remediation and socio-cultural processes can go hand in hand throughout the whole process. The time plan must be able to provide a roadmap in which the actions necessary for redevelopment are identified and evaluated, to grasp what the possible synergies that can accelerate the process of re-appropriation of abandoned spaces are, and which ones are a priority to unlock the subsequent phases.

Such an approach necessarily looks at the temporal dimension to better capitalize the redevelopment of industrial sites through an incremental process that does not start from a *tabula rasa*, but rather builds on the existing elements and values. In this regard, it can be understood as a social and ecological recolonization process. Moreover, it can be applied to sites having different spatial and formal conditions—both on small sites and larger clusters—and in different geographical contexts—in urban, peri-urban or rural areas.

Even when the redevelopment objectives are driven by economic or social goals, such as the creation of new housing, commercial areas or new forms of industrial production, it is important not to underestimate or neglect the potential of the site in improving socio-ecological conditions at different scales. Lastly, such an approach finds its application as a stand-alone strategy, and it can be integrated into broader urban redevelopment strategies.

## 11.5 Two Applications in the PRD

The approach presented in the previous section was applied on two case studies in the PRD (Fig. 11.6). The applications are graduation projects developed within the Adaptive Urban Landscape lab, part of the Flowscape graduation lab (TU Delft Landscape Architecture track).

The two design explorations share a common approach to industrial transformation, although with different perspectives. The first makes use of the historic district of Chancheng, in Foshan, to explore spatial strategies based on the systemic reuse of abandoned and decommissioned manufacturing sites addressing environmental and water-related issues. In Chancheng, industrialization has resulted in heavy soil



**Fig. 11.6** Two study areas of Chancheng, Foshan (above), and Huizhou, in Guangzhou (below) (Google Earth images, adapted by the author)

and water pollution. At the same time, urban development has led to the progressive disappearance of natural water courses, increasing urban flooding in urban areas, and the weakening of the relationship between inhabitant and water. Landscape-based solutions and principles are proposed to explore the potential of green–blue networks to clean the polluted water and mitigate urban flood risk, while at the same time offering a diversified set of programmes and open spaces reconnecting people with water.

The second exploration integrates landscape-based industrial transformation principles in a broader urban regeneration strategy for the Haizhu district. Located in the centre of Guangzhou, Haizhu is nowadays facing social segregation and ecological fragmentation problems due to its rapid and uncontrolled urbanization. Here, a socio-ecological network is proposed, starting from the reinterpretation of physical barriers in the dense urban tissue (e.g. roads, canals) into corridors connecting existing ecological hot spots and newly created functional nodes, leveraging on the reuse and demolition of the fine grain of manufactories within the urban settlements.

## 11.6 Results

The application in Chancheng started from the research question: ‘What is the spatial potential of post-industrial transformation of areas along waterways to mitigate the impacts of urban flooding and water pollution, while redefining the relationship of the nearby inhabitants?’.

To answer this question, the first step consisted in mapping and defining industrial typologies in the district based on their spatial qualities, building materials, and location. This resulted in the classification of the manufactory types that served as a basis for the design phase. In Chancheng, four main types of factories have been identified, namely: metal structured factories, reinforced concrete and steel factories, brick factories and small-scale factories (Fig. 11.7). The analysis has been further integrated with information on the location of polluting industries in relation to waterways and the urban flooding spots at the district scale. Results show that pollution sources are located mainly on the central and western areas of the district and mainly along the Fenjiang River. In this area, due to urban expansion and industrialization, waterways have been gradually buried underneath factories and roads. Urban flooding is concentrated in the old city core, due to the high rate of soil sealing and the disappearance of the original water system (Fig. 11.8).

To tackle water pollution and urban flooding, a toolbox of landscape-based principles is applied around a robust, multi-scale green–blue network. The strategy is structured around the resurfacing of buried waterways and their reconnection to the existing surface water system to create a blue spatial framework serving as a backbone for greater ecological connectivity (Fig. 11.9) and new productive functions. By redesigning industrial sites along the major waterways, green buffer areas are established. The demolition of buildings provides space for shallow areas allowing for sedimentation and phytoremediation, while waterways depth and width are modified

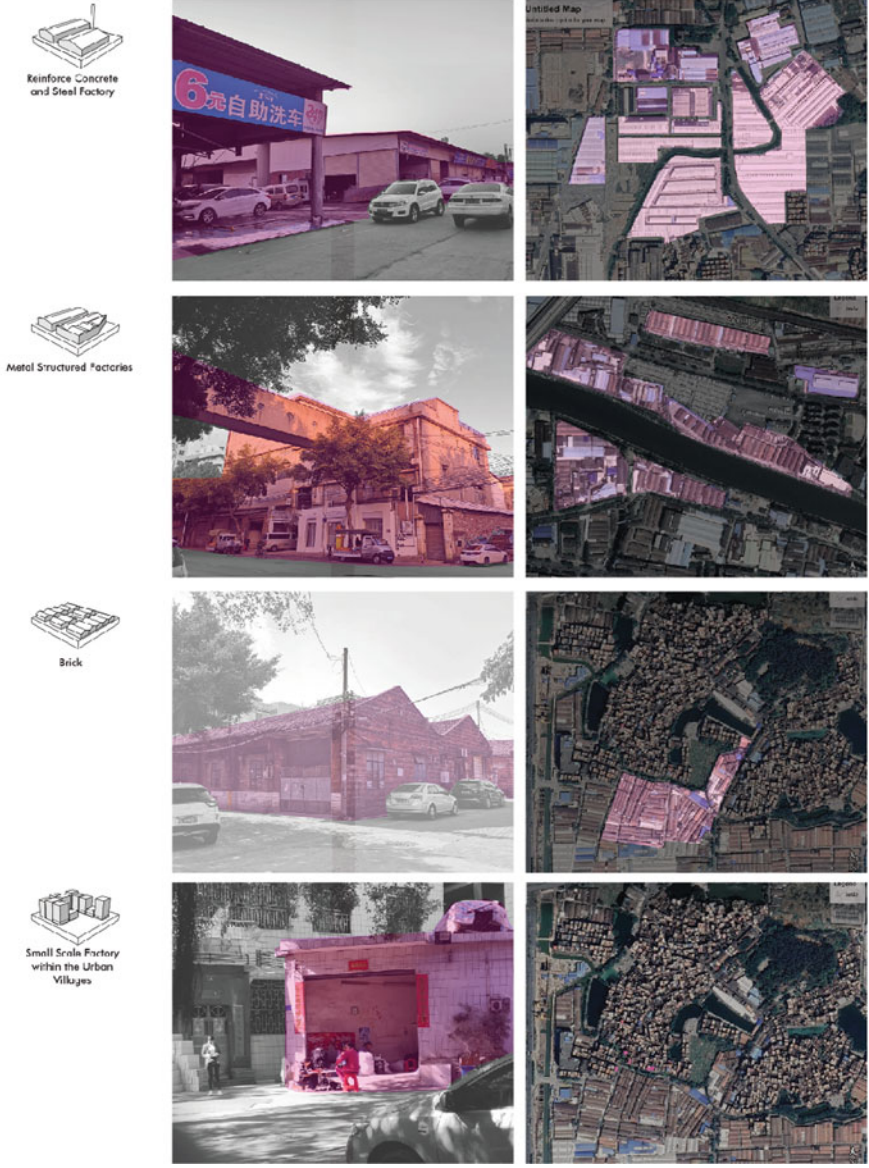
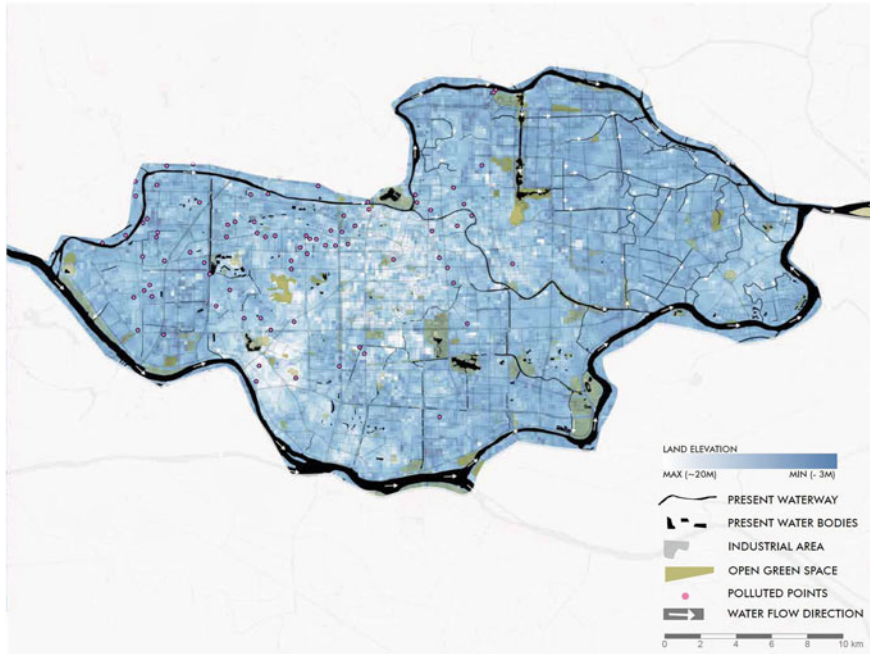


Fig. 11.7 Industrial typologies in the Chancheng district. Image Marina Mohamed Rani, TU Delft



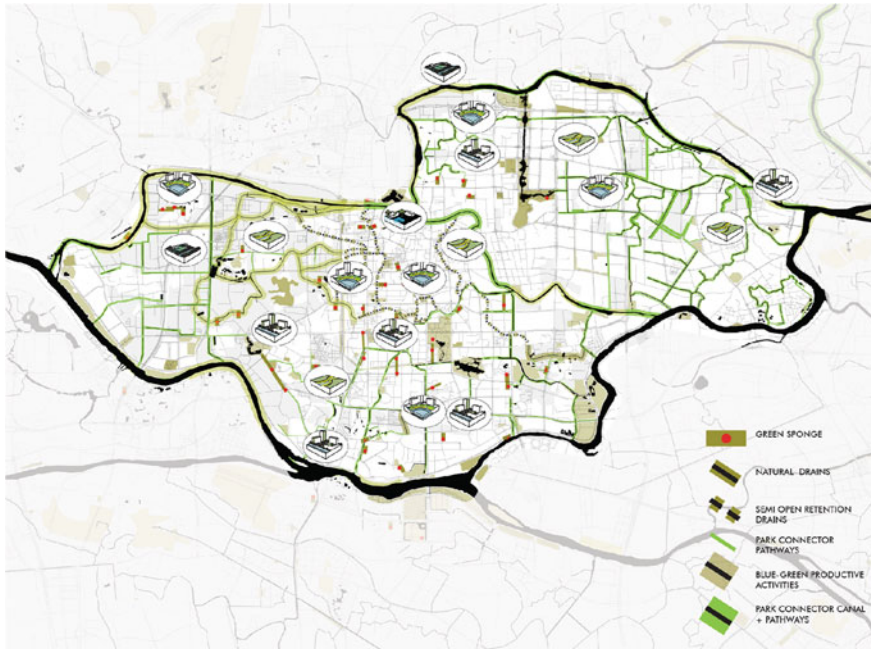
**Fig. 11.8** Urban flooding due to the high rate of soil sealing and the disappearance of the original water system. *Image* Marina Mohamed Rani, TU Delft

to ensure a more efficient circulation, thus avoiding water stagnating. Wetlands, bio retention swales and permeable surfaces are introduced for increased permeability and water retention, alleviating the occurrence of waterlogging in urban areas.

The spatial outcome is a new topography and vegetation system allowing water to slow down and be purified by plants, which in turn are harvested and processed into biomass. Factories along the waterways are reintegrated with new and cleaner forms of production, taking advantage of their characteristics: reinforced concrete and steel factories, with high ceilings, host spaces for plants processing and cleaner production activities, while the metal structures of buildings are reused for new public space, leisure activities, and offices. Industrial buildings within the urban village are demolished, to make room for new community space or public open green space (Fig. 11.10).

In Haizhu, a composite spatial strategy based on the introduction of public facilities, integrated mobility system and ecological space is proposed to overcome spatial segregation and environmental fragmentation.

As for the Chancheng district, the project started from the understanding of the bio-physical and socio-economic dynamics throughout different spatial scales, adopting the layer approach and mapping as methods of investigation to gain knowledge of the context and the spatial forms of urban settlements, transport network and landscape features. Haizhu district contains the presence of a great variety of settlements: within

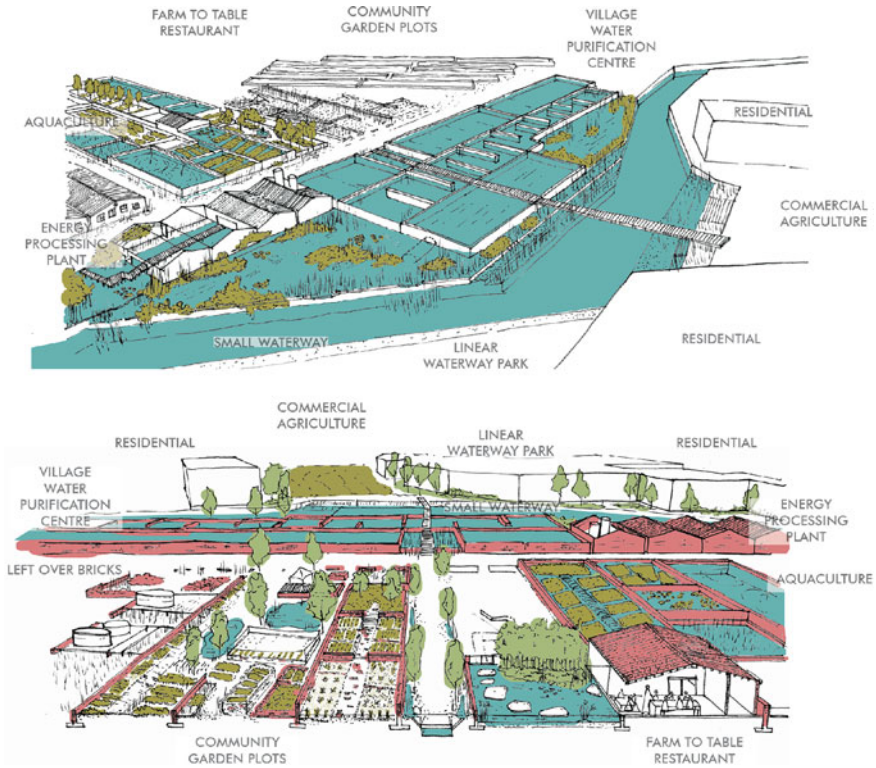


**Fig. 11.9** Proposed green–blue network for the Chancheng district. *Image* Marina Mohamed Rani, TU Delft

the thick urban tissue of the area, historical villages, traditional communities, urban villages and modern communities can be found, each characterized by different living conditions, open spaces and relationships with water (Fig. 11.11). However, the district presents an uneven distribution of public and commercial spaces, as well as lack of connection between ecological spaces and the built-up areas.

To overcome these issues, design principles and a toolbox are developed to foster great accessibility and interconnection to social and ecological spaces, provide diverse and integrated public spaces for more social inclusion and multifunctional ecological areas and services (Fig. 11.12).

These principles are applied at three different scales: regional (the whole Haizhu district), urban and local scale. At the local scale, different routes are designed, each of which having characteristics based on the peculiarities of the existing elements in the site. For the active route, vacant lots, abandoned factories and other underused spaces are transformed into recreational and ecological spaces, and the existing structures of the buildings are regenerated into new functions, such as urban farming and cafés. The freed space is redesigned to increase water storage and retention through the introduction of water squares, retention basins and soft edges along the waterways. The textile cluster that currently creates a barrier between neighbourhoods is reconverted into a more inclusive and creative space, with sport facilities, pocket parks and community parks. This new set of public facilities provides open, resilient



**Fig. 11.10** Bird’s-eye view of transformation interventions on two industrial sites in Chancheng district. *Image* Marina Mohamed Rani, TU Delft

space for new functions and events, such as a new informal market, an open theatre and sport areas for local communities (Fig. 11.13).

### 11.7 Discussion and Conclusions

This paper introduced a landscape-based approach to industrial transformation in the PRD and two applications in two different areas in the region.

Despite focusing on two different design objectives, the two applications share some similarities in looking at the transformative potential of industrial sites in the PRD in providing safer, healthier and more liveable urban landscapes while setting the base for greater sustainable urban development for the region.

To achieve these goals, such an approach must have different characteristics.

One of the key characteristics is the multi-scale and systemic approach.

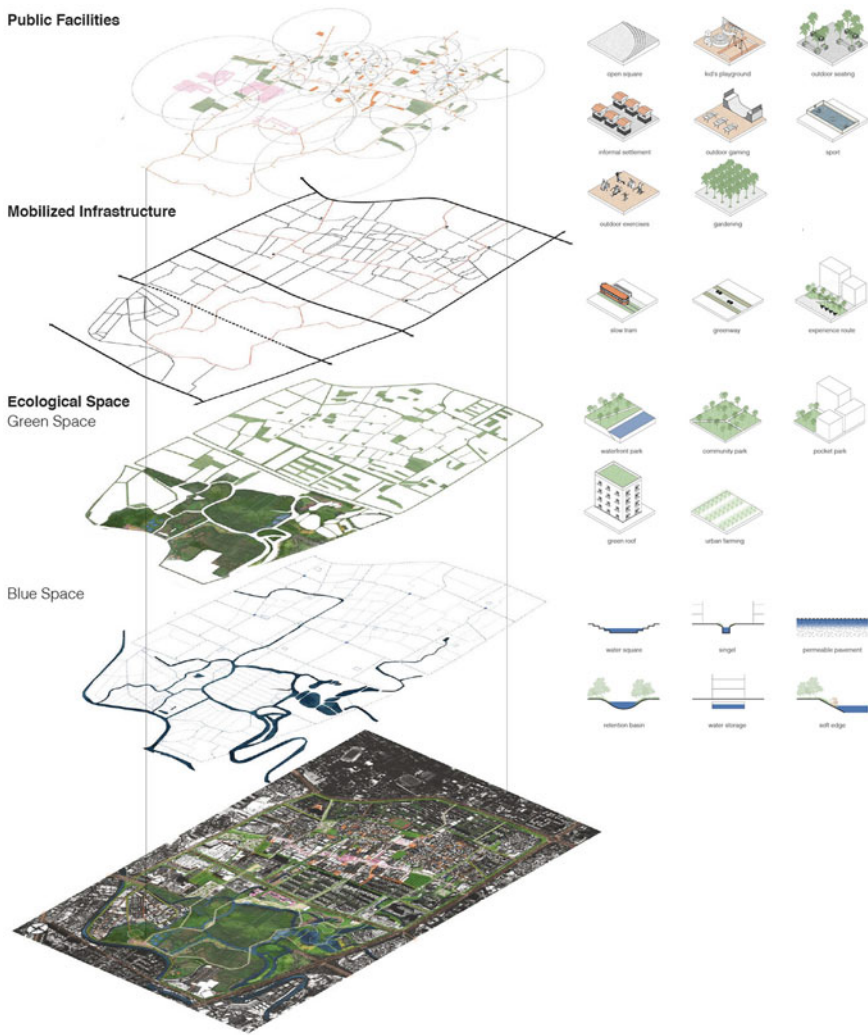
As shown above, the green–blue infrastructure proposed for the Chancheng district is structured around the relationship between industries and water. In Foshan, the



**Fig. 11.11** Settlement typologies and their relation with built environment, road system, water and open space. *Image Xinyan Zhao, TU Delft*

burial and channelling of waterways had an impact on the natural drainage. Their resurfacing creates the conditions for a more composite and resilient water system, where all the elements play a role in flood defence, but also in remediating polluted sites. Here, large industrial sites are reinterpreted as green buffer zones protecting urban areas from flooding, ensuring ecological connectivity and greater biodiversity.





**Fig. 11.12** Design toolbox. *Image* Xinyan Zhao, TU Delft

In a similar fashion, the punctual demolition of small industrial plots and single buildings proposed for Haizhu provides a new system of public spaces and centralities that become the new socio-ecological network of the district, reconnecting ecological hotspots at the district scale with the fragmented green areas in and around its neighbourhoods and acting as water management devices that are grafted onto the existing system.

Another important feature of the proposed approach is related to the temporal dimension. In Chancheng, a temporal strategy is developed through different phases, to explore programmes and functions accommodating remediation processes. Such



**Fig. 11.13** The industrial area transformed into an inclusive, creative space. *Image Xinyan Zhao, TU Delft*

an incremental approach sets the hierarchy of interventions, identifying what the priority actions to be pursued are to create the condition for further development in each phase, while leaving room for adjustments and synchronization. This implies understanding the landscape and ecological processes. Water and vegetation play a role in both risk mitigation and pollution reduction, but they have their own dynamics of development and follow their own processes and cycles. Redesigning industrial areas as green spaces for remediation can be a valuable strategy to accommodate rainwater and provide room for the rivers while making areas available again for new urban programmes. However, these programmes should strive to balance social, economic and ecological goals.

This approach strongly relies on nature-based solutions to provide both greater ecological and social resilience in urban areas, working with natural processes to remediate soil and water, while creating the conditions for new, greener economies. However, these need to be integrated into broader planning strategies involving residents and local communities.

Lastly, the two applications show how the proposed landscape-based industrial transformation approach can be applied both as a guiding strategy, starting from the systemic redevelopment of idle or decommissioned industries, or as integrated programme into broader urban redevelopment processes. In this regard, industrial transformation can be a valuable tool to stimulate adaptation practises at the local scale and offers the chance to bridge the gap between adaptation and spatial planning.

## References

- Ashley R, Nowell R, Gersonius B, Walker L (2011) Surface water management and urban green infrastructure. Foundation for water research. <http://www.fwr.org/greeninf.pdf>. Accessed 14 March 2021
- Atkinson G, Doick KJ, Burningham K, France C (2014) Brownfield regeneration to greenspace: delivery of project objectives for social and environmental gain. *Urban for Urban Greening* 13(3):586–594. <https://doi.org/10.1016/j.ufug.2013.04.002>
- Bardos RP, Jones S, Sthepenson I et al (2016) Optimising value from the soft re-use of brownfield sites. *Sci Total Environ* 563–564:769–782. <https://doi.org/10.1016/j.scitotenv.2015.12.002>
- Bélangier P (2009) Landscape as infrastructure. *Landsc J* 28(1):79–95
- Cannatella D (2019) Landscape and identity in regional design: the case of the Pearl river delta (China). *Abitare la Terra* 37
- Chan CK, Yao X (2008) Air pollution in mega cities in China. *Atmos Environ* 42(1):1–42
- Chao H (2018) Development model of city-industry integration in Pearl river delta Desakota: case of Foshan city. *Urb Rural Dev* 12:51–54
- Chan FKS et al (2021) Urban flood risks and emerging challenges in a Chinese delta: the case of the Pearl river delta. *Environ Sci Policy* 122(May):101–115. <https://doi.org/10.1016/j.envsci.2021.04.009>
- De Sousa C (2001) Contaminated sites: the Canadian situation in an international context. *J Environ Manage* 62(2):131–154
- De Graaf R (2012) Adaptive urban development. A symbiosis between cities on land and water in the 21st century. Rotterdam University Press, Rotterdam
- De Valck J et al (2019) Valuing urban ecosystem services in sustainable brownfield redevelopment. *Ecosyst Serv* 35(Nov 2018):139–49
- Gasparini C (2016) Drosscity. Raccontare la Città degli Scarti. In: Gasparini C, Terracciano A (eds) *Dross city. Metabolismo Urbano, Resilienze e Progetto di Riciclo dei Drosscape*. LIST Lab, Rovereto, pp 8–31
- Glass DJ (1999) US and international markets for phytoremediation, 1999–2000. D. Glass Associates, Needham, MA
- Han Q, Zhu Y, Ke GY, Hipel KW (2018) An ordinal classification of brownfield remediation projects in China for the allocation of government funding. *Land Use Policy* 77(February):220–230
- Hollander JB, Kirkwood NG, Gold JL (2010) Principles of brownfield regeneration: cleanup, design, and reuse of derelict land. Island Press, Washington
- Karwalska R, Mazur-Belzyt K (2020) Eco-city: model concept for transforming brownfield into modern urban district. *IOP Conf Ser: Mater Sci Eng* 960(4)
- Kempenaar A, Van Den Brink A (2018) Regional designing: a strategic design approach in landscape architecture. *Des Stud* 54:80–95
- Kennen K, Kirkwood N (2015) *Phyto: principles and resources for site remediation and landscape design*. Routledge, Oxon. <https://doi.org/10.1016/j.destud.2017.10.006>
- Li X et al (2017) Contaminated sites in China: countermeasures of provincial governments. *J Clean Prod* 147:485–496. <https://doi.org/10.1016/j.jclepro.2017.01.107>
- Lin C (1997) Red capitalism in South China: growth and development of the Pearl river delta. UBC Press, Vancouver
- Mathey J et al (2015) Brownfields as an element of green infrastructure for implementing ecosystem services into urban areas. *J Urban Plann Dev* 141(3):1–13
- Meyer H, Marchand M (2015) New perspectives on urbanizing deltas. Must Publishers, Amersfoort
- Nijhuis S, Xiong L, Cannatella D (2019) Towards a landscape-based regional design approach for adaptive transformation in urbanizing deltas. *Landscape Archit J* 26(9)
- Oliver L et al (2005) The scale and nature of European brownfields. In: CABERNET 2005: proceedings of the first international conference on managing urban land, Nottingham

- Pérez AP, Sánchez SP (2017) European achievements in soil remediation and brownfield redevelopment: a report of the European information and observation network's national reference centres for soil. Eionet NRC Soil, JRC
- Schoon S (2014) Three olds: experimental urban restructuring with Chinese characteristics, Guangzhou and Shenzhen in comparison. In: Altrock U, Schoon S (eds) *Maturing megacities: the Pearl river delta in progressive transformation*. Springer, Dordrecht, pp 105–122
- Sepúlveda Carmona D, Qu L, Tai Y (2014) Towards a livable urbanized delta region: spatial challenges and opportunities of the Pearl river delta. *Revista M* 11(1):8–23
- Shen J, Wong KY, Chu KY, Feng Z (2000) The spatial dynamics of foreign investment in the Pearl river delta, South China. *Geog J* 166(4):312–322
- State Council of the People's Republic of China (2019) *Outline development plan for the Guangdong-Hong Kong-Macao Greater Bay area*
- Tessler ZD et al (2015) Profiling risk and sustainability in coastal deltas of the world. *Science* (349/638):638–43
- Thornton G et al (2007) The challenge of sustainability: incentives for brownfield regeneration in Europe. *Environ Sci Policy* 10(2):116–134
- Waldheim C (2016) *Landscape as urbanism: a general theory*. Princeton University Press, Princeton
- Xiong H (2016) *Urban crime and social disorganization in China: a case study of three communities in Guangzhou*. Springer, Singapore
- Yan D et al (2018) Exploring future water shortage for large river basins under different water allocation strategies. *Water Resour Manage* 32:3071–3086
- Yeh AGO, Li X (1999) Economic development and agricultural land loss in the Pearl river delta, China. *Habitat Int* 23(3):373–390
- Yeung Y (2010) The further integration of the Pearl river delta: a new beginning of reform. *Environ Urban Asia* 1(1):13–26
- Zacharias J, Tang Y (2010) Restructuring and repositioning Shenzhen, China's new mega city. *Prog Plan* 73(4):209–249. <https://doi.org/10.1016/j.progress.2010.01.002>
- Zhu Z et al (2002) Water pollution and degradation in Pearl river delta, South China. *Ambio* 31(3):226–230

**Open Access** This chapter is licensed under the terms of the Creative Commons Attribution-NonCommercial 4.0 International License (<http://creativecommons.org/licenses/by-nc/4.0/>), which permits any noncommercial use, sharing, adaptation, distribution and reproduction in any medium or format, as long as you give appropriate credit to the original author(s) and the source, provide a link to the Creative Commons license and indicate if changes were made.

The images or other third party material in this chapter are included in the chapter's Creative Commons license, unless indicated otherwise in a credit line to the material. If material is not included in the chapter's Creative Commons license and your intended use is not permitted by statutory regulation or exceeds the permitted use, you will need to obtain permission directly from the copyright holder.



# Chapter 12

## Historical Canals as Urban Landscape Infrastructure in Guangzhou: Reactivating Public Life Through Water



Yu Zheng, Steffen Nijhuis, and Gregory Bracken

**Abstract** In the heart of the Pearl River Delta, the city of Guangzhou is fast-growing and prone to flooding. In history, people constructed canals based on natural waterways to deal with water problems. The canal system not only served as an important infrastructure but was also as the backbone of urban life. But with the development of the road network in recent decades, the urban canals in the historical inner city have been neglected and are disappearing, losing their identity, and becoming the forgotten side of the city. What can be learned from the historical situation to reactivate the urban canals as carriers of socially and ecologically inclusive urban space? This chapter aims to identify design principles for (historical) urban canal design and examine their potential through design exploration, with Donghao Chong as a typical example. The results showcase how, through the meaningful application of historical knowledge, urban canals can become a water landscape infrastructure that effectively integrates public space by combining design, heritage, water management, and ecology.

**Keywords** Historical urban canals · Heritage design · Public space design · Blue space · Urban landscape infrastructure · Canal restoration

---

Y. Zheng (✉)

Room 14B, Yuexiu District, East Block, Hongye Building, Dongxing South Road, Guangzhou, Guangdong, China

e-mail: [zhengyubjfu@outlook.com](mailto:zhengyubjfu@outlook.com)

Y. Zheng · S. Nijhuis · G. Bracken

Faculty of Architecture and the Built Environment, Delft University of Technology, Julianalaan 134, 2628 BL Delft, The Netherlands

e-mail: [s.nijhuis@tudelft.nl](mailto:s.nijhuis@tudelft.nl)

G. Bracken

e-mail: [G.Bracken@tudelft.nl](mailto:G.Bracken@tudelft.nl)

© The Author(s) 2023

S. Nijhuis et al. (eds.), *Adaptive Urban Transformation*, The Urban Book Series, [https://doi.org/10.1007/978-3-030-89828-1\\_12](https://doi.org/10.1007/978-3-030-89828-1_12)

233

## 12.1 Introduction

### 12.1.1 The Forgotten Urban Canals

Located in the Pearl River Delta, Guangzhou is one of the biggest cities in China. Its geographic characteristics determine that its urban development is inseparable from water. The historical districts of Guangzhou not only have the characteristics of traditional Chinese urban culture, but also have the distinctive characteristics of a water town. The urban water system is an important driving force for the development of Guangzhou; it is also the lifeline of the city. With the rapid development of the Pearl River Delta, and the continuous expansion of Guangzhou’s urban area, historical canals have been disappearing, with those that remain mainly used for industrial waste and sewage, which has led to water pollution and waterlogging problems (Meng et al. 2019). The poor condition of the canals makes them the forgotten side of the city, isolated in the urban tissue where they used to be the hotspots of the city: the centre of urban life for Guangzhou’s inhabitants in the past. In short, the historical canals used to be a well-functioning water landscape infrastructure but now are single-use drainage canals (Fig. 12.1). There were two canal restoration projects undertaken in Guangzhou in the last 10 years. However, these projects delivered public space that barely functions because the designers did not think of the canals as part of the surrounding areas. Some interventions even increase the risk of flooding, and the cost of maintenance is also very high.

To summarise, with city development, the potential of the historical canal system in Guangzhou as an urban landscape infrastructure has been ignored, leading to water pollution in the canals and the decline of the water infrastructure and a greater risk of flooding in the canal areas (Fig. 12.2).

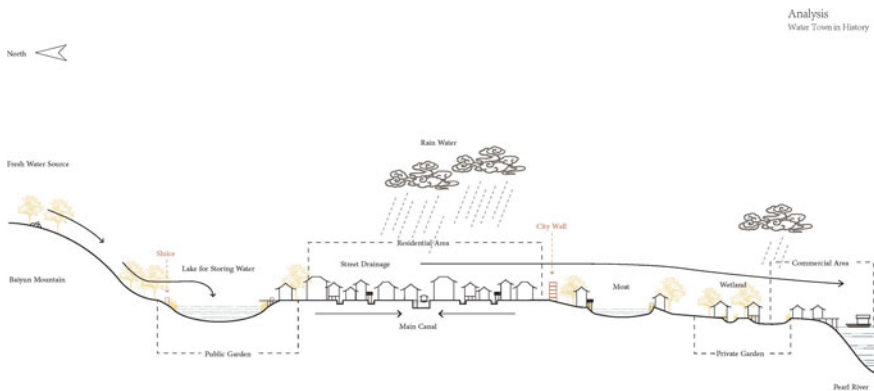


Fig. 12.1 Analysis of water town in history. Image Yu Zheng

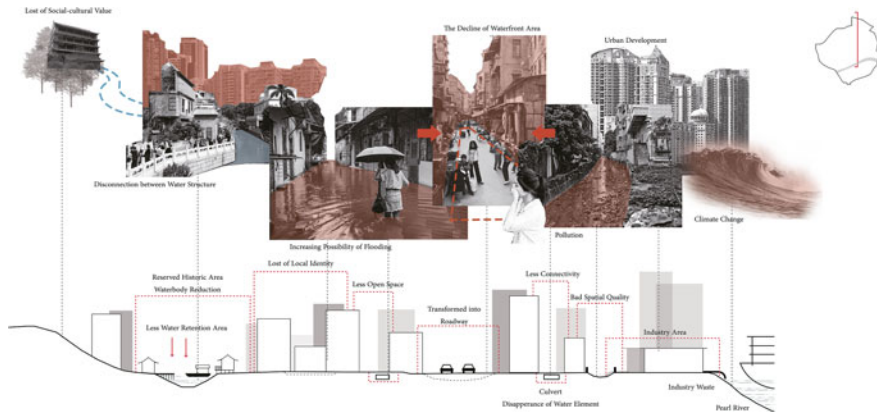


Fig. 12.2 Challenges facing the historical urban canals of Guangzhou. Image Yu Zheng

### 12.1.2 Objective

To understand the dilemma facing historical canals in Guangzhou, we need to consider them as an urban landscape infrastructure interacting with the different layers of the city: from the natural base to the urban system itself.

Guangzhou is located at the heart of the Pearl River Delta, which is the centre of a dense river network. This natural condition determines that Guangzhou needs a water drainage network. Therefore, historically, the people who lived in Guangzhou developed a canal system that expanded along with the city. Apart from their drainage function, the canals also played an important role in improving spatial quality, residents’ urban life and transportation. On the one hand, past inhabitants constructed the canal system based on the natural river network, and this water system, with different hierarchies, has worked well in draining water in the rainy season and storing it in the dry season. On the other hand, the canals shaped the built environment and facilitated different social and ecological interactions, for instance, the freshwater lake acted as a public garden for the whole city, there was also a royal garden that combined a water purification system. Throughout history, people have worked well with the water; and the canal system in Guangzhou was not only an important water infrastructure but also the centre of urban life.

However, in the last 50 years, because of the rapid growth of population and limited land, the built-up area has quickly expanded in the historical inner city. Because of the rapid increase of the number of impervious surfaces, less rainwater can filter into the land directly, leading to a greater risk of flooding. The expansion of the built-up area also means a decrease in volume of the water body. The places where drainage canals used to be now have problems with waterlogging (Zhang et al. 2018). The water issues of the historical canals have greatly affected the spatial quality of their surrounding areas, which are losing their local identity as historical waterfront areas and have gradually become separated from the water. Therefore, for the safe and

sustainable future development of Guangzhou, we need to ask how people can better live with water and what role it can play in their daily lives?

This brings us to our research objective: How to redefine the role of the historical canal system in Guangzhou as a water landscape infrastructure and adapt it to future urban development? And how can the historical canals work with this? What can we learn from the historical use and function of the canals in the city? And how can we use the knowledge of the past for today?

### ***12.1.3 Relevance***

This chapter aims to identify design principles for reactivating urban canals based on historical urban canal design and examines their potential for future use through design exploration. In the current situation, the function of the canal system as an important public space, and its potential for shaping the urban environment, have been abandoned. The quality of the canal system, in its social and ecological aspects, has greatly decreased; they no longer meet their needs as water infrastructure, particularly in the face of possible extreme climate events and further urban expansion. This chapter is intended to help readers understand the importance of the historical canal system in Guangzhou, and its social-cultural influence on surrounding areas, and to outline what this understanding can do to mitigate the adverse effects of climate change. In the part that deals with design exploration, the social-cultural and ecological values of water infrastructure are reinstated, and their influence on the surrounding built environment explored.

Guangzhou is not the only city whose canals and water-based life have deteriorated in recent decades, but the importance of canals to local life has also faded in many places due to modern urban development. Neither is Guangzhou the only city to suffer from water problems like flooding. Its geographical conditions and city development are mirrored in many places throughout the world. This chapter provides a new perspective for solving some of these problem by looking back at history to explore the potential that historical waterways have in their social-cultural values and what these can contribute to the spatial qualities of the city. The resultant design could then provide a template for resilient and adaptive coastal- or canal-city development, as well as give guidelines for other similar projects.

### ***12.1.4 Structure of the Chapter***

The next section elaborates the theoretical and methodological background of the study. This is followed by an introduction of the historical canals of Guangzhou and the research problem. Next, the design principles for historical urban canal design are identified via an in-depth study of the development and structure of Guangzhou's canals throughout history. This is followed by a design exploration that shows the



potential for using historical design principles in the future. The chapter closes with a discussion of its findings and the potential use of its design processes in a wider context.

## 12.2 Theoretical Background

### 12.2.1 *Urban Landscape Infrastructure*

The main object of this research is the canal system of Guangzhou, an important infrastructure for the urban system. In flowscape theory, infrastructure is considered a type of landscape and landscape a type of infrastructure, summarised as urban landscape infrastructure (Nijhuis and Jauslin 2015). The hybridisation of the two concepts seeks to redefine infrastructure beyond its strictly utilitarian definition, while allowing spatial design to gain operative force in territorial transformation processes (Nijhuis and Jauslin 2015).

The potential these infrastructure systems have for performing the additional function of shaping architectural and urban form is largely unrealised. They can be designed with a formal clarity that expresses their importance to society, at the same time creating new layers of urban landmarks, spaces and connections (Strang 1996). By exploring this theory, the potential and possibility of the historical canal system working as landscape and infrastructure, and how it affects its surrounding environment, physically and social-culturally, have been explored. Urban canals can work as an operative force in territorial transformation processes, in which the structure of the built environment and the river-course keep affecting each other. During this process, it facilitates dynamic social and ecological interactions, such as local identity as water town.

### 12.2.2 *Resilient Landscape*

In popular terms, resilience means the capacity to persist in the face of change: to continue to develop within an ever-changing environment. Resilience thinking is about how periods of gradual change interact with those of abrupt changes, and the capacity of people, communities, societies and cultures to adapt or even transform into new development pathways in the face of dynamic change.

A resilient landscape is one that has the capacity to adapt in the face of constant change. This concept has allowed the development of an approach to understanding complex adaptive systems and serves as a platform for interdisciplinary and transdisciplinary research with an emphasis on social-ecological systems (Folke 2016).

In this research, a resilient landscape is one that focuses on improving its ability to adapt to future urban development and climate change. The historical canals could (and should) be part of this and could (and should) develop and grow with the city. In this process, interdisciplinary and transdisciplinary research can also help lead to a better understanding of the social-cultural aspects of these developments.

### ***12.2.3 Learning from the Past***

Landscape architecture is one of the few disciplines in which the history of the future can be created. Pillaging an ‘endless bank of history’, landscape architects play the role of ‘critical historians’. That being said, these artists of the built environment should ‘always study history. If they are good, they can then invent their own (Hunt 2014). Looking back into history does not mean just copy-pasting what is found there. As an old Chinese saying has it: ‘History could be a mirror to today’s questions’. History can help us better understand the nature of today’s problems by comparing situations now and then. As a result, it helps us have better understanding and possibly even become better decision-makers if we are open to the lessons of the past.

In this research, we could not begin to investigate Guangzhou’s historical canal system without taking its development into account. Learning from history means identifying core problems in this historical landscape infrastructure that can be relevant to current situations, and identifying design principles that have potential use today.

### ***12.2.4 Design Research***

The relationship between research and design should be dynamic because they affect each other. Design can be the orientation of research. The goal of design sets the framework for research, making its process more targeted and efficient, and its results more effective. On the other hand, research works as a major input for design: it provides background knowledge, can help establish parameters and informs design decisions. In this research’s design exploration, the research created the basis for the design (Laurel 2003).

### ***12.2.5 Research Through Design***

This project is not only about project design. Here design is also employed as a research strategy, often referred to as research through design (Nijhuis and De Vries 2020). Research through design is used to explore the possibilities of the design

principles learned from history and studies how they are relevant to modern challenges and specific site conditions. This is also an important process for transforming research knowledge into practical design. In this case, the design principles learned from history are not enough for a design, they also need to be tested and transformed under specific conditions (Nijhuis and Bobbink 2012). In the design exploration part, different design principles are combined and tested via several design explorations. This process enriched the design principles, showing how they not only worked in Guangzhou, but could also have the potential to work in similar situations elsewhere.

## 12.3 Learning from the Past

### 12.3.1 *Development of the Canal System*

The canal system was developed into an urban landscape infrastructure through the efforts of generations of people, even if they did not realise it. It was first constructed to drain fresh water from the mountains, and combined with a great royal garden, the system had social and ecological functions. Gradually, with the expansion of the city, the canals connected more and more, and became closely intertwined with people's daily lives.

A city cannot develop without water. Therefore, having a sufficient water source is one of the important prerequisites for a city's location. The water system of Guangzhou runs through the history of its urban development, with a bearing on various aspects and needs, including urban space, ecology, the military, transportation, culture, etc., presenting the social, natural, economic, and other values of the whole city in a holistic way. This can be seen in the comprehensive review of the evolutionary history and related governance processes of the water system in the main urban areas of Guangzhou that follows.

### 12.3.2 *Types of Waterfronts*

To deal with the flooding threats and the lack of fresh water, there was a clear hierarchy in the canal system: street drainage collected rainwater into the six main canals in the city centre, rainwater then ran into the moat through sluices in the city walls before flowing into the Pearl River and, eventually, the South China Sea. The canal system was constructed based on the natural water system, connecting the lake and wetlands around the city, which were a buffer zone for flooding and had ecological functions that greatly improved capacity for water storage.

This systematically arranged water system worked as the backbone of the urban public space. The relationship between landscape composition, urban areas, and



### 12.3.2.2 Waterfront Residential Zones

Compared to the commercial areas, the waterfront residential zones had a more intense street pattern and use of public space. The canals were the backbone of these areas, acting as a transportation network connecting the different layers of these public spaces. The narrow canals also made the relationship between people, the built environment, and the water more intense.

The built environment, together with the canals, were the backdrop for various lively activities. The waterfront residential zones in the ancient city of Guangzhou were initially concentrated in the inner harbour and wharf at the centre of the urban canal network. Various types of buildings, such as inns, temples, businesses, and community centres were formed along the waterways. The canals were the backbone of the urban public space structure. Roadways stretched into the blocks and connected the different layers of public space to the canals. Because the canal water was connected to the Pearl River it was brackish, so people built wells and retention ponds to store fresh water.

Compared with the historical waterfront residential zones, public space in the canal restoration projects does not work well because it does not involve residents in the design decisions, nor does it consider water an important part of their daily lives. The waterfront residential areas used to be more abundant and livelier. Not only were there many buildings standing next to the water, but there were also public spaces, especially at the bridgeheads, such as small piers, performance stages, old trees, temples, making these zones the social and cultural centre of the old city.

### 12.3.2.3 Waterfront Gardens

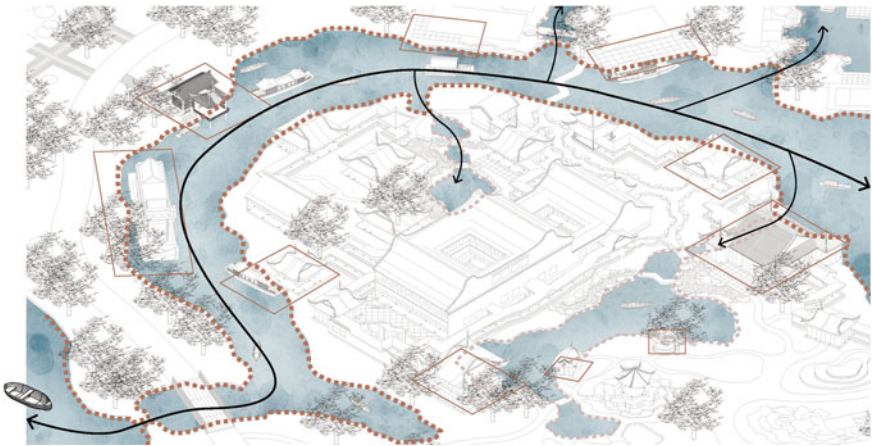
Waterfront gardens include public, private, and royal gardens. There used to be harmony between the built environment and nature in ancient Guangzhou. People could enjoy panoramic views as well as store or drain water in the dynamic waterscape. Waterfront gardens were the most abundant water landscape in ancient times and were mostly distributed around the waterways. The urban canal system of the ancient city in Guangzhou, based on its different topography and water sources, formed different regional water forms, each with its own natural characteristics based on the water system, and which have diachronic and sustainable ecological characteristics (Fig. 12.4).

There were dense river networks in the suburbs of the ancient city of Guangzhou, so the owners often used the original water resources to excavate ponds and build gardens. Ancient gardens in Guangzhou were mostly a combination of living and courtyard spaces. Therefore, the setting of the waterfront garden can adapt to the needs of Guangzhou's subtropical regional climate, with local species of flowers and trees planted around them. The waterfront yard connected to the urban water system, which not only prevented the water from drying up, but also played a role in reducing temperature and preventing drought during intense heat, and, more importantly, it could drain flood water quickly during the rainy season. The inclusion of trees and



**Fig. 12.4** The waterfront gardens of Guangzhou as recorded by the English architect Thomas Allom around 1850 (private collection Steffen Nijhuis)

plants were also beneficial to the microclimate of the garden, and simple adjustments could enhance the practicability and convenience of the water court (Cai 2018). The waterfront garden was the centre of the green structure of ancient Guangzhou (Fig. 12.5).



**Fig. 12.5** The system waterfront gardens in Guangzhou. Image Yu Zheng

### 12.3.3 Design Principles

What can be learned from the historical situation to reactivate the urban canals as carriers of socially and ecologically inclusive urban space? Design principles learned from history are divided into two separate but interconnected aspects: landscape and water management.

The connectivity between public space and water is a key aspect of Guangzhou's landscape. The analysis of the city's management of its water network throughout history provides the base for the design principles outlined in the following section (Figs. 12.6 and 12.7). The analysis of waterfront commercial area shows the diverse interface brought variety to water as public space. The analysis of waterfront residential area shows how the systematic water network worked with natural water purification system and artificial retention pond. These offer a template for sustainable water management in the city in the future. Both aspects, landscape and water management, should work *with* the natural environment to play their role in improving the spatial quality of the city and increase its capacity to resist flood and drought (Fig. 12.8).

In conclusion, this study of the city's history shows how canals have shaped the built environment, and these design principles, based on the canals that worked so well in managing Guangzhou's water system in the past, should also ensure the creation of good quality space, with both space and water playing important roles in people everyday lives.

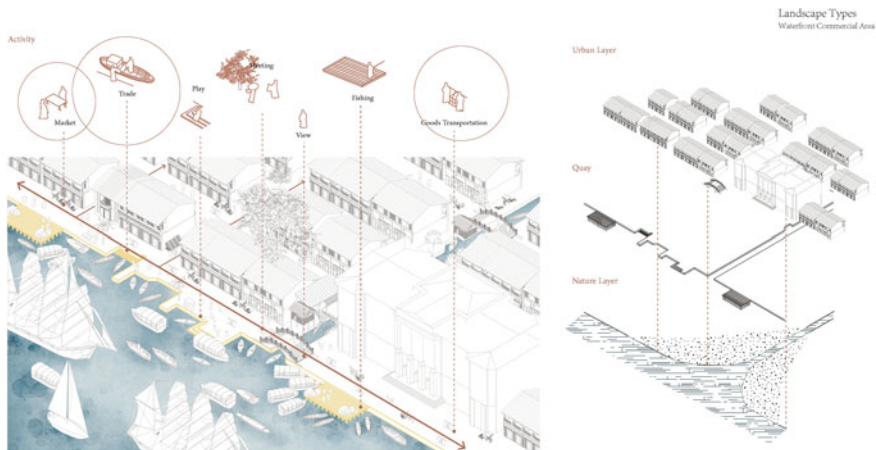


Fig. 12.6 Design principles in waterfront commercial area. Image Yu Zheng

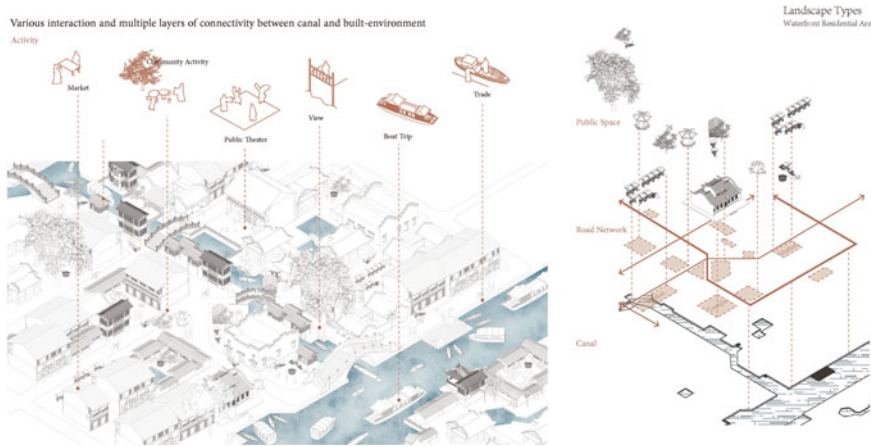


Fig. 12.7 Design principles in waterfront residential area. Image Yu Zheng

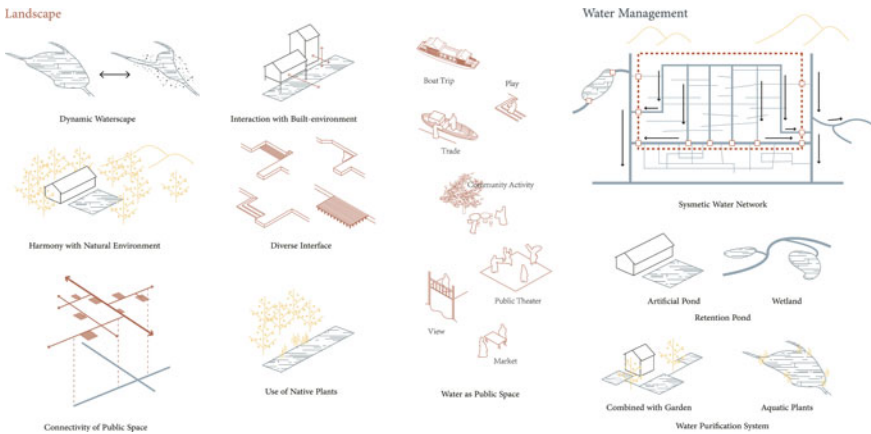


Fig. 12.8 Design principles learned from historical analysis. Image Yu Zheng

## 12.4 Design Exploration

### 12.4.1 The Application of Design Principles

The toolkit of the design principles learning from the past keeps growing in the process of design exploration. It has three steps: first, select suitable design principles from history; second, adapt them to specific sites; and third, explore the possibilities of those sites and the possibilities of the design principles in different situations. In this iterative process, the design principles can be further developed, providing a more effective toolkit for today’s situation in Guangzhou and even beyond.



### 12.4.2 Donghao Chong as a Typical Example

Donghao Chong is a typical example of what has happened to historical canals in Guangzhou. Isolated by hard interfaces, the canal is now the forgotten side of the neighbourhood. Interface conditions differ according to the surrounding elements. This research has identified a number of different types of interface, including apartment complexes, a community park, office buildings and open squares. Different elements, like the parking lot, or temporary housing (that is in poor condition), as well as the heavily trafficked roads, create hard boundaries along the waterfronts. To address these different interface conditions, different design principles learned from history are tested in design models to visualise the possibilities of the site so that it can be improved by these principles. Design models include a wetland park, a water-adapted neighbourhood, and a traditional water town. It is also important to remember to transform historical design principles so as to adapt them appropriately for current situations.

The results show that through the meaningful application of historical knowledge, urban canals can become a water landscape infrastructure that effectively integrates public space, design, heritage, water management, and ecology (Fig. 12.9).

For example, in Donghao Chong's residential areas, the wetland park provides the possibility for diverse waterscapes and water-based activities while also purifying and storing water. This new neighbourhood is connected to the city's canals via a green structure of public space, and also via the water system itself. The retention pond with reeds can purify water, while socially the new water system also enlivens the environment. In this new urban system, new social and ecological interactions are facilitated and new processes shape the built environment into a better place. In the site's nodal points there are layers for different transportation types and other

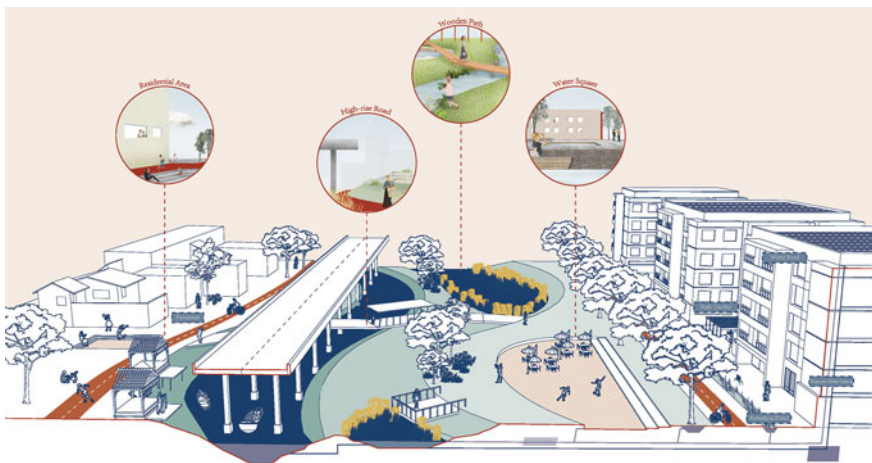


Fig. 12.9 Design exploration to reconnect Guangzhou to its canals. Image Yu Zheng

activities that create a complete and continuous experience for pedestrians, cyclists and boat users. The dysfunctional public space at the edge of the site can be replaced by a green area in harmony with nature allowing more space for water. This can also be connected to the surrounding area via an underground walkway offering space for an exhibition showcasing the history of the Donghao Chong area.

### ***12.4.3 Reconnecting the Urban Canal System***

The revived historical canal system could provide a new green–blue infrastructure for the whole city. It could flow through every corner of the city, making travel, and communication between its neighbourhoods better. It could also create more space for water and open up to new river channels. In the rainy season, the river system can quickly drain water from the historical city to the Pearl River, while during the dry season it has more space to store water.

As urban landscape infrastructure, the canal system is an integral part of the urban ecology, landscape environment, and spatial patterns at a material level (Fig. 12.10). As a part of urban life on the social level, it serves the local community and the wider city. As the starting point of the Maritime Silk Road, Guangzhou's historical development has always been closely related to water. Each urban canal has its unique significance. Through the improvement of the urban canal system in the city centre of Guangzhou, and the comprehensive and effective management of the environment, the relationship between the city, its urban canals, and the people who use them could be restored. People would be able to revive the memory of Lingnan Watertown, and the water culture, urban culture, and humanistic culture that were so much a part of these places' way of life, and which have been missing in recent years—they could be revived to create a new and vibrant waterfront city in Guangzhou.

## **12.5 Discussion and Conclusion**

Canals as urban landscape infrastructure activate public life and become important public space structures for the whole city while also reorienting the urban tissue to the water. At the same time, they can play a critical role in sustainable water management and the ecological development of the city as a whole. To redefine the role of the historical canal system in Guangzhou as water landscape infrastructure adapting to future urban development, the historical canals and their surrounding areas need to be understood as a whole system. Since the canals have a long history and deep relationship with the city, to understand the system, looking back into history is necessary. By comparing historical and current situations, the nature of the challenges the city now faces can be better understood. Looking back at history does not mean trying to recreate scenes from it; it means learning established design principles and applying them to current situations. These days, people tend to seek



**Fig. 12.10** Overview of plans to revive Guangzhou's historical canal system. *Image* Yu Zheng

solutions in modern technology. However, the nature of current problems is very often like historical ones, with answers to questions already there, for those prepared to look. To understand the challenges Guangzhou is facing, this research conducted a layer analysis. The urban landscape is a complex system, consisting of a natural layer and urban layers, and they affect each other. To investigate the challenges of the urban areas, basic natural conditions are an essential element to consider because this natural layer is the basis on which all later city development is built. Mapping these layers was the diagnosis part of the research. Analysis begins with the natural base, and then moves on to city development and the condition of the public spaces. Finally, how the revival of this historical canal system could work as a new urban landscape infrastructure is shown. Landscape infrastructure is an important driving force for the processes that shape the built environment and contemporary space. The revitalised historical canal system could be the driving force for the development of surrounding areas, creating a new green–blue infrastructure that reorients the city back towards the canals as newly activated waterfront areas created through this revival.

Furthermore, this chapter also shows the potential of urban canals as landscape infrastructure and provides a new perspective on their spatial development, not only in Guangzhou but also, potentially, for other canal cities around the world. The design explorations in this study provide the possibility for the sustainable urban development of cities in delta areas as well as guidance for similar canal restoration projects worldwide.

## References

- Cai Y (2018) Research on the construction of the water-system landscape of ancient Canton. Master's Thesis, South China University of Technology
- Folke C (2016) Resilience. Oxford Research Encyclopedia of Environmental Science. <https://doi.org/10.1093/acrefore/9780199389414.013.8>
- Hunt JD (2014) Historical ground. Routledge, London
- Laurel B (2003) Design research: methods and perspectives. MIT Press, Cambridge MA
- Li Z (2017) Research of Guangzhou downtown typical water system landscape renovation. Master's Thesis, South China University of Technology
- Meng M, Dąbrowski M, Tai Y, Stead D, Chan F (2019) Collaborative spatial planning in the face of flood risk in delta cities: a policy framing perspective. *Environ Sci Policy* 96:95–104. <https://doi.org/10.1016/j.envsci.2019.03.006>
- Nijhuis S, Jauslin D (2015) Urban landscape infrastructures: designing operative landscape structures for the built environment. *Res In Urbanism Ser* 3(1):34
- Nijhuis S, Bobbink I (2012) Design-related research in landscape architecture. *J Des Res* 10(4):239–257
- Nijhuis S, de Vries J (2020) Design as research in landscape architecture. *Landsc J* 38(1–2):87–103. <https://doi.org/10.3368/lj.38.1-2.87>
- Strang GL (1996) Infrastructure as landscape. *Places* 10(3):8–15
- Zhang H, Cheng J, Wu Z, Li C, Qin J, Liu T (2018) Effects of impervious surface on the spatial distribution of urban waterlogging risk spots at multiple scales in Guangzhou, South China. *Sustainability* 10(5):1589. <https://doi.org/10.3390/su10051589>

**Open Access** This chapter is licensed under the terms of the Creative Commons Attribution-NonCommercial 4.0 International License (<http://creativecommons.org/licenses/by-nc/4.0/>), which permits any noncommercial use, sharing, adaptation, distribution and reproduction in any medium or format, as long as you give appropriate credit to the original author(s) and the source, provide a link to the Creative Commons license and indicate if changes were made.

The images or other third party material in this chapter are included in the chapter's Creative Commons license, unless indicated otherwise in a credit line to the material. If material is not included in the chapter's Creative Commons license and your intended use is not permitted by statutory regulation or exceeds the permitted use, you will need to obtain permission directly from the copyright holder.



# Chapter 13

## From Modelling and Analysis of Accessibility of Urban Green Space to Green Infrastructure Planning: Guangzhou as a Case Study



Yueshan Ma , Paul Brindley, and Eckart Lange

**Abstract** With the rapid growth of cities around the world, numerous studies have highlighted the positive effects of accessing urban green space (UGS) in a reasonable distance for both physical and psychological health. In China, Guangzhou is a typical population-intensive metropolis, in which green infrastructure (GI) requires even allocation for a high utilisation rate. This chapter explores the relation between modelled and public perceived walking accessibility of UGSs. It utilizes 237 park green spaces in the central-city area of Guangzhou for modelling spatial UGS accessibility and collects 2360 questionnaires for analysing public perceived UGS accessibility. The research highlights the deficiency of current common factors used for modelling walking accessibility. This paper offers a summary of potential factors affecting the actual public accessibility to a park based on analysing the responses to the questionnaires. This assessment of willingness to travel can inform GI planning and improve the accuracy of modelling walking accessibility. Overall, this case study contributes to a novel conceptual framework for future UGS walking accessibility analysis via comparing the model of UGS provision and the reality.

**Keywords** Urban green space · Green infrastructure planning · User-based accessibility · Accessibility modelling

---

Y. Ma (✉) · P. Brindley · E. Lange  
Department of Landscape Architecture, The University of Sheffield, Sheffield S10 2TN, UK  
e-mail: [yma51@sheffield.ac.uk](mailto:yma51@sheffield.ac.uk)

P. Brindley  
e-mail: [p.brindley@sheffield.ac.uk](mailto:p.brindley@sheffield.ac.uk)

E. Lange  
e-mail: [e.lange@sheffield.ac.uk](mailto:e.lange@sheffield.ac.uk)

## 13.1 Introduction

### 13.1.1 *Accessibility of Urban Green Space in Urban Planning*

There is an increasing consensus of Urban Green Space's (UGS) role on promoting physical activity, psychological health and social connectivity (Ghimire et al. 2017; Kaczynski et al. 2010). In China, according to the 2010 PRC National Standard, UGSs are divided into three main types: namely, Park Green Space (PGS), Green Buffer (GB) and Square Green Space (SGS). Given this standard, PGS is defined as green spaces open to the public with inherent beneficial impacts on people and environment. Numerous literatures indicate that parks offer comprehensive functions for people to engage in leisure, exercise and socialising (Zhang et al. 2013; Kaczynski and Henderson 2008; Hong et al. 2018). Specifically, greener living environments can help with reducing risk of obesity (Mears et al. 2020; Manandhar et al. 2019), relieving depression (Meyer-Grandbastie et al. 2020), improving self-esteem (White et al. 2017) and enhance social cohesion and sense of belonging (Hong et al. 2018).

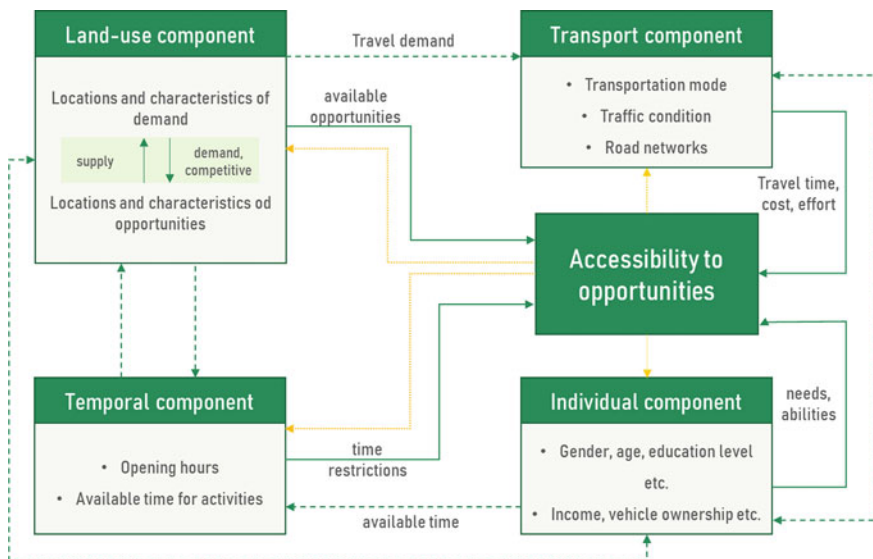
A considerable number of studies have proved that residents within reasonable access to UGS are able to take advantage of the benefits (Jenks and Jones 2010). Therefore, understanding how people access urban parks plays a vital role in investigating whether the Green Infrastructure (GI) is allocated scientifically and effectively. For example, with the rapid urbanized growth in Copenhagen in the 1990s, lacking the balance between GI provision and intense land development led to the pressure on UGS network (Caspersen et al. 2006).

Planners and local government realise the importance of UGS provision. The European Environment Agency (EEA) notes that the residents should be within a 15-min walking distance from the nearest UGS. Great London Authority offers a guidance that there should be accessible UGS of at least 0.02 hectares no more than an 800-metre walk from home. Accessing UGS has been recognised as a concern for environmental justice, gaining recognition on assessing the disparity between GI provision and the public demand based on socioeconomic population groups (Xiao et al. 2017; Xu et al. 2018). For example, Boone et al. (2009) indicated that black ethnic groups have less urban park acreage within 400-m walking distance than the white ethnic groups in Baltimore, Maryland. However, there is far from a consensus on findings obtained by empirical studies. Two opposite reviews are presented by Macintyre (2007) and Wolch et al. (2014), of which the former found a better access to parks in lower-income population than other groups, whilst the latter found low-income communities are provided with less park service than white and more affluent counterparts. Therefore, the question of how to best measure UGS accessibilities has a vital influence on research findings (Lee and Hong 2013a, b; Mears and Brindley 2019; Rigolon 2016; Wolch et al. 2014).

### 13.1.2 Methods of Accessibility Modelling and Measurement

Methods of modelling the accessibility of urban parks still remain debated within urban planning and the sustainability of cities (Dadashpoor and Rostami, 2017; You 2016; Xing et al. 2018). Geurs and Van Wee (2004) discussed that the accessibility measurements can be divided into four perspectives, including infrastructure-based measure, individual-based measure, location-based measure and utility-based measure. Park accessibility measures are seen as indicators for the effect of distribution and quality of parks and transport systems on people’s access to parks (Xu et al. 2017). Based on this concept, and referring to Geurs and Van Wee (2004), the constitution of park accessibility measures can be regarded as coming in four parts: namely, *park component*, *transportation component*, *temporal component* and *individual component*. The interrelationship among the four components is depicted in Fig. 13.1.

Following this framework of measuring accessibility, Table 13.1 lists some measuring and modelling standards and methods of UGS accessibility from the literature. Common measurements calculate the amount of UGS per capita or add up the average/total time/distance to access to UGS (de Sousa Silva et al. 2018; Rigolon 2017; Quatrini et al. 2019). The travel time or distance can be estimated by a simulation model (Kim et al. 2018) such as the buffer area (Tratalos et al. 2007; de Sousa Silva et al. 2018), network analysis (Rigolon 2017; Quatrini et al. 2019), collected from floating car data (Nigro et al. 2018), or captured via an online map API (Chen



**Fig. 13.1** Interrelationship among four components of accessibility measure. (Adopted from Geurs and Van Wee 2004)

et al. 2017). Their main drawback is failing to consider the potential impacts of other components and the interactions among them.

To fill the research gap of a people-oriented accessibility measurement, a considerable number of studies have focused on people's activities to investigate urban park accessibility by using such methods as collecting activity diaries (Chai et al. 2009), GPS techniques (Chai et al. 2013; Vich et al. 2019), online POI data or mobile phone signalling data (Li et al. 2011; Liu et al. 2012; Zhai et al., 2018; Mears et al. 2021). Such studies, however, frequently overlook the effects of the 'supply' component, and it is difficult to interpret the characteristics of individuals.

Other research employs a gravity concept for modelling the UGS accessibility, which considers the way that attraction of destination affects the accessibility and combines the influences of land use and transportation. However, the interaction between supply and demand is not reflected. To improve the original gravity-based model, Luo and Wang (2003) firstly posed the two-step floating catchment area (2SFCA) method, which subsequently has become widely used in the field of

**Table 13.1** Some standards and methods of modelling and measuring of UGS accessibility according to the literature

Author(s)/Year	Standard of accessing to UGS	Measuring/modelling method(s)
Willemsse (2013)	15-min walking time	Container approach
Zhang et al. (2011)	6.7 miles (no specific transportation)	Container approach
Cetin (2015)	500-m (15-min) walking distance (time)	Buffer analysis
Miyake et al. (2010)	400-m walking distance	Street network analysis
Maroko et al. (2009)	Density of park acreage and density of physical activity sites	Kernel density
Oh and Jeong (2007)	1,000-m walking distance	Street network analysis
Liang and Zhang (2018)	800-m walking time	Street network analysis
Zhang and Zhou (2018)	Geotagged check-in data from social media	Statistical analysis
Reyes et al. (2014)	Local household travel surveys database	A statistical estimation model
Lee and Hong (2013a, b)	A distance decay function where the maximum distance is 1000 m	Gravity model
Rahman and Zhang (2018)	800-m walking distance	Buffer analysis
Wu et al. (2018)	1–10 km walking and cycling distance	Street network analysis and Gaussian-based two-step floating catchment
de Sousa Silva et al. (2018a)	300-m and 500-m walking distance	Buffer analysis
Mears and Brindley (2019)	100, 300, 500-m walking distance	Buffer analysis and street network analysis



analysing access to health care (see Chen et al. 2021; Ghorbanzadeh et al. 2021; Kiani et al. 2021). During recent years, researchers have applied the method to evaluating GI accessibility (Lin et al. 2021; Liu et al, 2021; Xing et al. 2020). However, the content of data does not embrace personal and preference information, potentially overlooking the relationship between public behaviour and public perception on using parks. For example, when some studies use a gravity model, most of them regard only the size of green space area as assessing the factor of GI's attractiveness indicator.

As discussed above, deficiencies in current UGS accessibility studies remain, including indicators of park accessibility that lack an investigation into whether there is a supply–demand imbalance of GI allocation. It has been demonstrated that people do not always visit the nearest parks given the quality of destinations (Vaughan et al. 2013) and different transportation modes (McKenzie 2014). Different population groups who walk to access UGS are demonstrated to be closely related with significant social inequality in Shenzhen, China (Xu et al. 2017). Additionally, walking is the most equitable mode of transport, available to everyone (Arellana et al. 2021). Walking accessibility of urban parks is crucial to assess the rationality of GI provision under the context of urban planning and environmental justice.

Given the background and gaps mentioned previously, this paper aims to answer the following questions: (1) What is the spatial walking accessibility of urban parks in Guangzhou? What is the actual walking accessibility perceived by the residents? (2) To what extent is there a disparity between modelled accessibility and public perceived accessibility of urban parks? Where are the regions that lack a sense of proximity to UGS? (3) What factors could potentially lead to such disparities in UGS accessibility? More importantly, this empirical study contributes to improving traditional UGS accessibility modelling and provides insight into urban parks planning for local administrators from the residents' perspectives rather than a traditional top-down mode.

## 13.2 Materials and Methods

### 13.2.1 Study Area

This empirical study is conducted in the southern Chinese city of Guangzhou, the capital of Guangdong Province and a major area of the Pearl River Delta. It lies adjacent to Macao and Hong Kong and covers an area of 7434 km<sup>2</sup>. It is currently one of the most populous cities in the mainland of China with a permanent population of 18.6 million in 2020, which has increased 64% in the past 13 years. According to the revised administrative division of Guangzhou in February 2014, it consists of six main districts and five satellite districts (Fig. 13.2). Our research focuses on the central-city area that is constituted by its six districts: Yuexiu district, Haizhu district, Tianhe district, Liwan district, Baiyun districts and the new Huangpu district

(including the old Huangpu district and Luogang district) as shown in Fig. 13.2a. In this region, less than 10% of population is employed in agricultural work, such as farming and fishing (Chen and Yeh 2018).

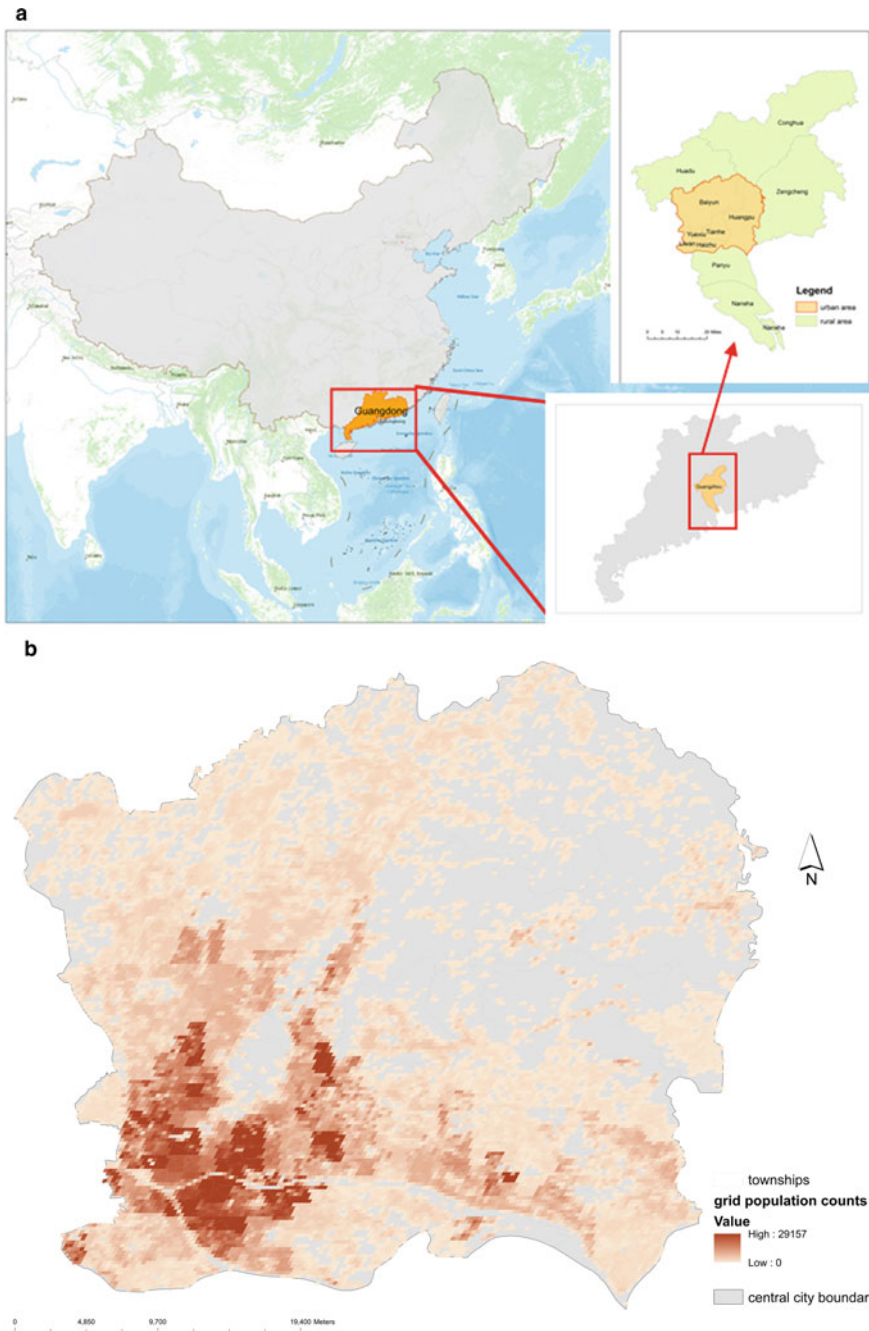
Local government has facilitated the construction and protection of GI under the intense state of land sources. The Forestry and Garden Bureau (FGB) of Guangzhou municipality (2018) stated that, by 2035, the per capita green space area of parks should be raised to no less than five square metres and citizens should be able to visit the nearest parks within a ten-minute walking time. Additionally, it aims to make the public the beneficiaries and supervisors of park green spaces. By the end of 2035, there will be more than 800 new parks in Guangzhou. The central city area takes up around 20.3% of the land area of Guangzhou city area and has about 52.8% of the park green space area of the whole city. All the parks with free admission located in the central city area are included in the study. In addition, parks within the 500-m buffer area surrounding the central city area are selected as study objects for avoiding 'boundary effects'.

### ***13.2.2 Data Source and Pre-processing***

The following data were utilised:

- Green spaces and road networks from OpenStreetMap (OSM);
- Age and other population demographics from the census alongside administrative boundaries from the Statistic Bureau of Guangzhou Municipality;
- Population counts at 250-m grid cells from Global Human Settlement Layer;
- Additional green spaces not found in OSM from the Bureau of Forestry and Landscaping of Guangzhou Municipality.

It is possible to simply aggregate the fine spatial population data from the Global Human Settlement (250-m grid cells (Schiavina et al. 2019)) to the much larger areal units associated with township data from the Statistic Bureau of Guangzhou Municipality (average township area is around 1,267 ha). Therefore, the population grid data (Fig. 13.2b) was spatially joined to the townships, and census data was added to each town based on corresponding town names. Guangzhou encompasses 170 townships in which the central city districts include 116 townships under jurisdiction of six districts. As stated before, the UGS polygons were filtrated by the type of Park Green Space (PGS) and only parks located in the central city area and its 500-m buffer were chosen. In total, 237 parks were included (Fig. 13.2c), which vary in function, location and size. Entrances of parks were extracted from OSM, but for those parks without an entrance the geometric centroids were utilised. In reality, it should be noted that there is no reliable open source of entrances for the hundreds of parks in the city.



**Fig. 13.2** Location of study area in China and the administrative division of Guangzhou **a** Study area is in the central region of Guangzhou indicated in orange; **b** Population distribution; **c** Parks distribution and entrances. *Images* Yueshan Ma

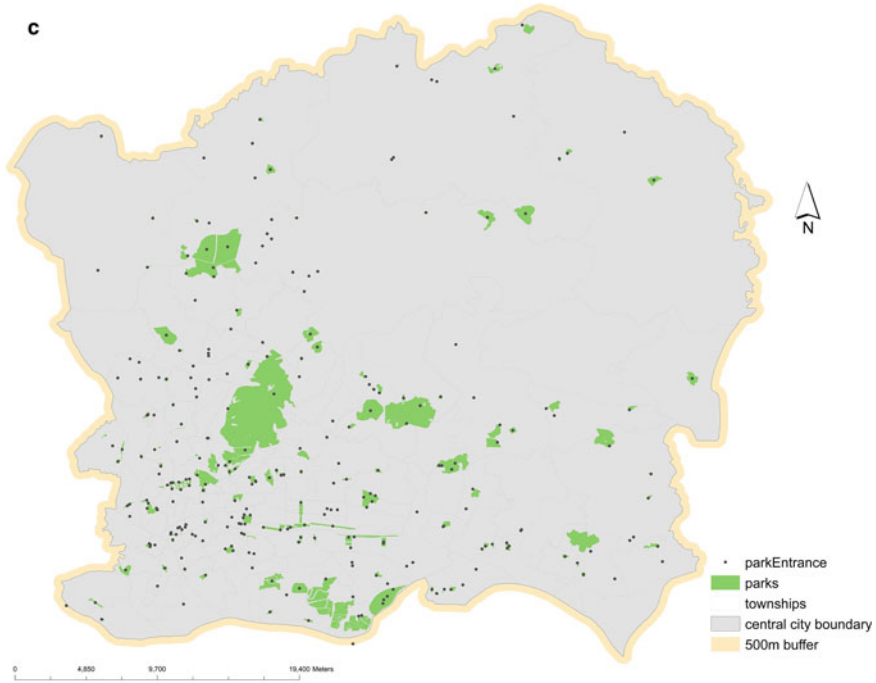


Fig. 13.2 (continued)

### 13.2.3 Methods

This study utilises the Two Step Floating Catchment Area (2SFCA) method proposed by Luo and Wang (2003). This measurement quantifies the relationship between supply and demand. The first step is generating a service catchment ( $S_j$ ) with the travelling cost ( $d_{jk}$ ) for each destination ( $j$ ), and then adding up the population ( $P_k$ ) within this area to obtain an area-to-population ratio ( $R_j$ ). The second step is to accumulate the area-to-population ratio ( $R_j$ ), in which the population contains people within the catchment ( $P_i$ ) covering a distance ( $d_{ij}$ ) from each population location ( $i$ ), and the area ( $A_i$ ) is the sum of parks located in the population catchment. The distance is set as a constant of 1000 m according to the public preferred walking time of 15 min (the preferred walking time results from the questionnaire output—and is also supported by literature, such as the European Environment Agency guidance).

- Step 1 For each service ( $j$ ),  $R_j = S_j / \sum_{k \in \{d_{jk}\}} P_k$ .
- Step 2 For each population ( $i$ ),  $A_i = \sum_{j \in \{d_{ij}\}} R_j$ .

The primary data collection method involved both an online and on-site questionnaire which employed a random sampling strategy to collect 2505 responses (2375 online and 130 on-site). All participants were aged 18-years or over and stay or have stayed in Guangzhou more than three months. This field survey was conducted from

October 2019 to January 2020, and the online survey was continued from November 2019 to November 2020. As such, the period covered all seasons of the year. These random samples were tested to be representative of the actual population characteristics of Guangzhou (including age groups, gender groups and areal distribution) and were also normally distributed.

The 2SFCA method and service area analysis are mainly used for modelling the spatial accessibility of parks. The questionnaire survey contributed to both qualitative analysis and quantitative analysis including statistical analysis and analytic hierarchy process (AHP). The modelling process used ArcGIS, and the statistical analysis was undertaken in SPSS. It should be noted that AHP is utilised as a tool for obtaining the coefficient of factors for representing the accessibility of parks. The factors are selected based on previous studies, and the priority of factors is decided by answers from the questionnaires (<https://www.wenjuan.com/s/2iQzAvX/>).

## 13.3 Results

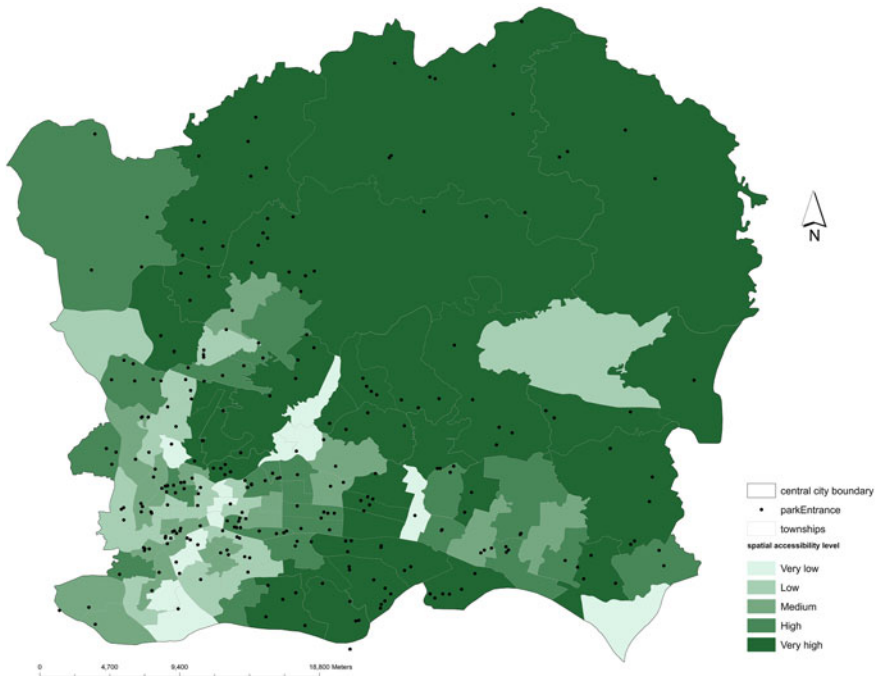
### 13.3.1 Two Types of Accessibility

We analyse the accessibility of parks in the central city area using two measures. The first describes the modelled spatial relationship between park supply and population demand using the 2SFCA method. The final accessibility values are reclassified into five levels by geometric interval classification and allocated to corresponding townships. The second measure represents the public perception on access to parks. The grades are rated 1–5 by respondents on the basis of their ease of walking to parks (1: Very hard; 2: Hard; 3: Medium; 4: Easy; 5: Very easy). The statistical description of accessibility levels is shown in Table 13.2. This shows that in aggregated terms, the accessibility of parks based on residents' actual use (PPAG) appears broadly comparable with those from the spatial modelling (MSAG). To some extent, the PPAG is slightly higher than the MSAG in total.

The distribution of classified modelling accessibility levels is shown as grades in Fig. 13.3. It reveals potential deficiencies in park supply in the south-west region of the central city area, where although the park entrances are greater in number, the population is more densely distributed than in other areas (Fig. 13.2b). Among regions with modelling spatial accessibility grades (MSAG) less than three, the lowest MSAGs are found in townships in Liwan district and Yuexiu district, taking up 26.3%

**Table 13.2** Descriptive statistics on overall accessibility (both modelling accessibility and perceived accessibility) in central city area

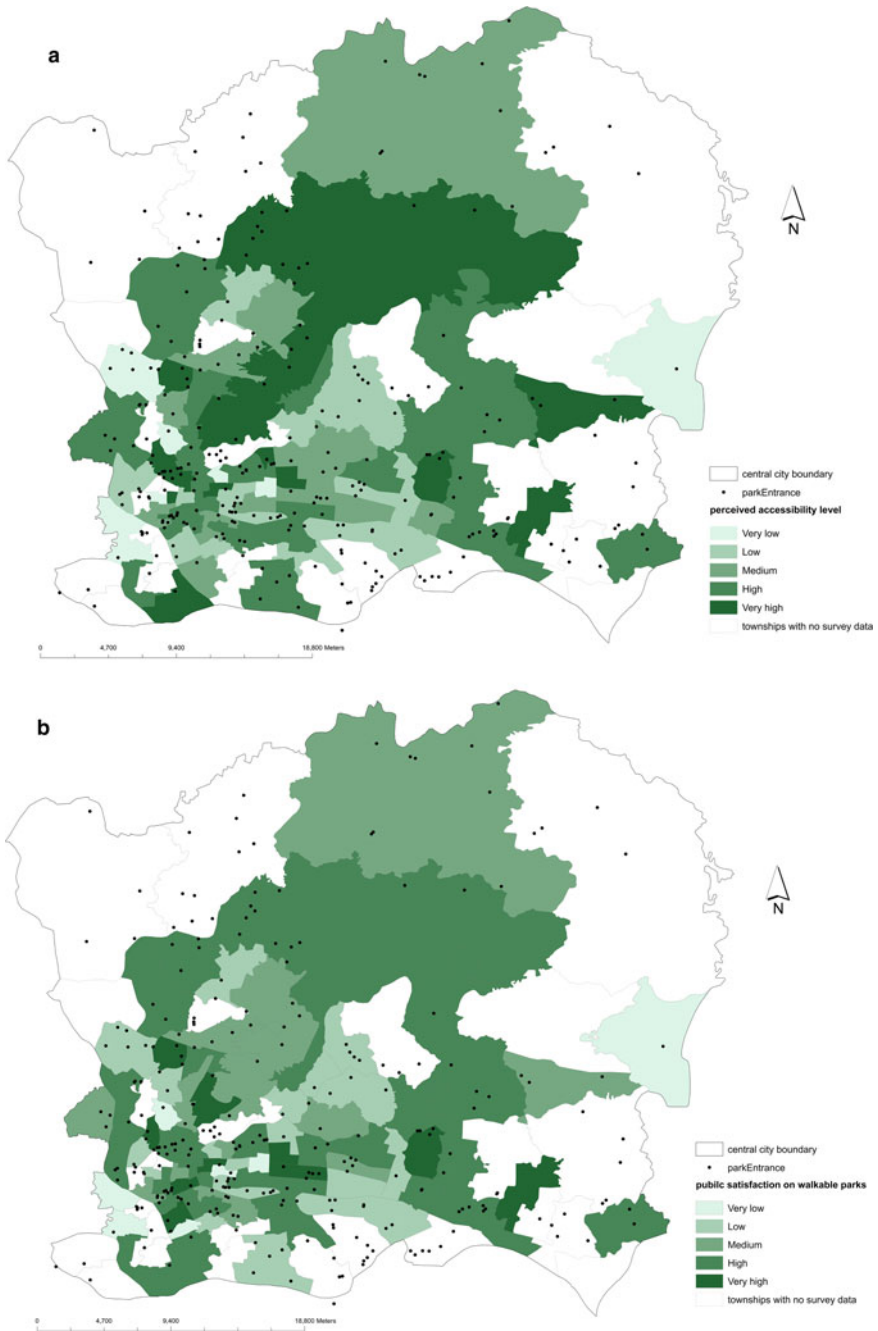
Accessibility description	Median	Mean	St. Deviation
Modelling spatial accessibility grades (MSAG)	3	3.29	1.36
Public-perceived accessibility grades (PPAG)	4	3.30	1.23



**Fig. 13.3** Modelling spatial accessibility grades (MSAG) of Parks at township level. *Image* Yueshan Ma

equally. Huangpu district has the least proportion of low MSAGs with 5.3%. Among townships with a high MSAG (>3), the most belong to Tianhe district with the proportion of 29.6%.

The public-perceived accessibility grade (PPAG) is obtained from people's self-rated satisfaction on access to parks in their townships as presented in Fig. 13.4a. The low PPAGs (<3) are mostly found in the Yuexiu district (26.9%) and the Tianhe district (23.1%) and rarely appear in the Huangpu district (3.8%), which matches with MSAG distribution discussed above. In terms of high PPAGs (>3), Baiyun district includes the highest PPAGs accounting for 24.4%. However, when comparing the PPAG with its corresponding overall experience on visiting walkable parks (Fig. 13.4c), many high-MSAG regions exhibit lower satisfaction. In contrast, in some low PPAG regions, although people feel that there is not enough access to parks, visiting these parks could fulfil their requirements for UGS within a walkable distance. To some extent, this corroborates the findings of previous studies that people do not always visit their nearest parks. In other words, spatial distance should not be the only factor in representing the actual walking accessibility of parks based on public usage.



**Fig. 13.4** Perceived accessibility levels of parks **a** and corresponding satisfaction regarding visiting walkable parks **b** Image Yueshan Ma

### 13.3.2 Public Perception on Visiting Parks

After exploring the relationship of user ages and users' preferred resident-reported walking times and acceptable longest walking times to parks, Table 13.3 shows a significant correlation between walking time and age. This demonstrates that up to the age of 50, people are willing to take a longer time to walk to visit a park (Table 13.4). The time range of '2' represents 10 to 20 min and '3' relates to 21 to 30 min. There is a decrease in preferred walking time for people over 50 years old.

As discussed above, the actual public perception on access to parks may not reflect the modelled accessibility. Therefore, in addition to travelling costs (expressed as travelling distance) there must be other factors affecting people walking to parks. Factors are identified from analysing their importance within the questionnaire responses, including: park area, facilities (toilets, fitness equipment etc.), views (views within the park), cleaning (clean environment in parks), travel time, reputation (perceived park popularity), activity diversity (public benefit activities, sports activities etc.), traffic safety (on the route to parks), environmental quietness (noise in the park from surrounding traffic, crowd noise etc.), surrounding infrastructure (markets, restaurants, etc.) and surrounding security (when walking in and nearby

**Table 13.3** Correlations between age and walking time with significant relationship (Sig. value = 0.00)

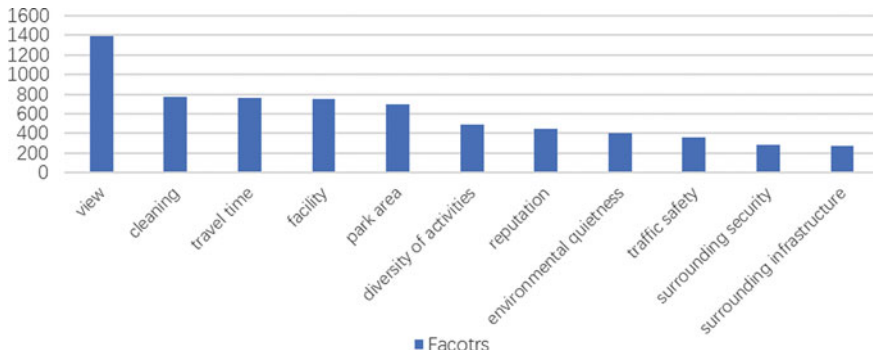
Spearman's rho		Longest walking time	Proper walking time	Age
Age	Correlation coefficient	0.117**	0.157**	1.000
	Sig. (2-tailed)	0.000	0.000	
	N	2254	2254	2254

\*\*Correlation is significant at the 0.01 level (2-tailed)

**Table 13.4** Descriptive statistics for the relationship between walking time (original time range is from 1 to 5, where 1-'less than 10 min'; 2-'10-20 min'; 3-'21-30 min'; 4-'3-40 min'; 5-'more than 40 min') and age

	Age group	Mean time range	Std. error
Preference of resident-reported walking time	18-24	2.16	0.066
	25-30	2.30	0.033
	31-40	2.46	0.029
	41-50	2.74	0.072
	> 50	2.35	0.179
Acceptable longest walking time	18-24	2.46	0.069
	25-30	2.63	0.034
	31-40	2.69	0.029
	41-50	2.94	0.070
	> 50	2.73	0.154





**Fig. 13.5** Factors affecting access to parks on foot (y-axis represents the number of respondents selecting this factor)

the park). The public scored views as the most important factor influencing how far they would be willing to walk to parks (Fig. 13.5). The joint second-most important factors were cleanliness, travel cost and level of facilities, with the park area being the next ranked factor (Fig. 13.5). The influence of the surrounding security and infrastructure were comparatively lower rated factors. Additionally, these results offer the specific coefficients of these factors after conducting the AHP (Table 13.5), which can be used as reference for modelling actual accessibility from user-based aspects.

## 13.4 Conclusion

The results of our case study show that, in total, the accessibility level is average in the central city area. Specifically, Yuexiu district and Liwan district recorded MSAG values of 2.5, which is lower than the average level of 3. Contrarily, Huangpu district shows the best access to parks with a MSAG of 4. Discrepancy between modelling and actual accessibility is detected via comparing MSAG and PPAG within the same region. From the public perception, the MSAGs of Yuexiu district and Liwan district rank equally last with scores of 3.5. Baiyun district and Huangpu district rank equally first with MSAG of 3.9. When adding geographical distribution characteristics to these grades, there are several townships having high MSAG but low PPAG, including three townships in Yuexiu district, five districts in Haizhu district, three townships in Liwan district and five districts in Huangpu district. This difference might indicate that planners should pay more attention to other factors in addition to distance in order to improve the accessibility of parks, especially in these regions. In this respect, this case study has provided suggestions on weighting indicators that influence people's walking to parks. The view of parks was the most important factor and considered more important than travel cost which ranked second.

As an empirical study, these results can also help to inform park green space planners and policy makers in Guangzhou about both spatial provision of parks and

**Table 13.5** Weights of factors in Fig. 13.5 affecting access to parks on foot

	View	Cleaning	Travel time	Facility	Park area	Diversity of activities	Reputation	Environmental quietness	Traffic safety	Surrounding security	Surrounding infrastructure
Rank	1	2	2	2	5	6	7	8	9	10	11
Priority (%)	28.7	11.9	11.9	11.9	9.5	7.6	6.5	4.5	3.2	2.4	1.9

public perception of park accessibility. The research highlights the novel approach of comparing modelled and user-based accessibility to explore park accessibility. Discrepancies between the two measures serve as a reminder of the additional hidden factors that significantly affect accessibility of park green spaces.

**Acknowledgements** This work is part of Adaptive Urban Transformation (AUT) – Territorial governance, spatial strategy and urban landscape dynamics in the Pearl River Delta (EP/R024979/1), a collaborative project of Delft University of Technology (TU Delft), South China University of Technology and The University of Sheffield.

## References

- Arellana J, Alvarez V, Oviedo D, Guzman L (2021) Walk this way: pedestrian accessibility and equity in Barranquilla and Soledad, Colombia. *Res Transp Econ* 86:101024. <https://doi.org/10.1016/j.retrec.2020.101024>
- Boone CG, Buckley GL, Grove JM, Sister C (2009) Parks and people: an environmental justice inquiry in Baltimore, Maryland. *Ann Assoc Am Geogr* 99:767–787
- Caspersen OH, Konijnendijk CC, Olafsson AS (2006) Green space planning and land use: an assessment of urban regional and green structure planning in Greater Copenhagen. *Geogr Tidsskr* 106:7–20
- Cetin M (2015) Using GIS analysis to assess urban green space in terms of accessibility: case study in Kutahya. *Int J Sustain Dev World Ecol* 1–5. <https://doi.org/10.1080/13504509.2015.1061066>
- Chai YW, Zhang WJ, Zhang Y, Yan YN, Zhao Y (2009) The production and quality management of disaggregated space–time data of individual’s behaviors: a case study of activity–diary survey in Beijing. *Hum Geogr* 24(6):1–9
- Chai YW, Shen Y, Ma XJ, Zhao Y (2013) The collection and management of space–time data of individual behavior based on location-based technology: a case study of activity–travel survey in Beijing. *Geogr Res* 32(3):441–451
- Chen J, Ni J, Xi C, Li S, Wang J (2017) Determining intra-urban spatial accessibility disparities in multimodal public transport networks. *J Transp Geogr* 65:123–133
- Chen W, Cheng L, Chen X, Chen J, Cao M (2021) Measuring accessibility to health care services for older bus passengers: a finer spatial resolution. *J Transp Geogr* 93:103068. <https://doi.org/10.1016/j.jtrangeo.2021.103068>
- Chen Z, Yeh AGO (2018) Accessibility inequality and income disparity in urban China: a case study of Guangzhou. *Ann Am Assoc Geogr* 109(1):121–141. <https://doi.org/10.1080/24694452.2018.1470923>
- Dadashpoor H, Rostami F (2017) Measuring spatial proportionality between service availability, accessibility and mobility: empirical evidence using spatial equity approach in Iran. *J Transp Geogr* 65:44–55
- De Sousa Silva C, Viegas I, Panagopoulos T, Bell S (2018) Environmental justice in accessibility to green infrastructure in two European cities. *Land* 7(4):134
- Geurs K, Van Wee B (2004) Accessibility evaluation of land-use and transport strategies: review and research directions. *J Transp Geogr* 12(2):127–140
- Ghimire R, Ferreira S, Green G, Poudyal N, Cordell H, Thapa J (2017) Green space and adult obesity in the United States. *Ecol Econ* 136:201–212
- Ghorbanzadeh M, Kim K, Erman Ozguven E, Horner M (2021) Spatial accessibility assessment of COVID-19 patients to healthcare facilities: a case study of Florida. *Travel Behav Soc* 24:95–101. <https://doi.org/10.1016/j.tbs.2021.03.004>

- Hong A, Sallis J, King A, Conway T, Saelens B, Cain K, Fox E, Frank L (2018) Linking green space to neighborhood social capital in older adults: the role of perceived safety. *Soc Sci Med* 207:38–45
- Jenks M, Jones C (2010) Dimensions of the sustainable city. *Mopt.org.pt*. <http://www.mopt.org.pt/uploads/1/8/5/5/1855409/mikejenks.pdf>. Accessed 27 May 2021
- Kaczynski AT, Henderson KA (2008) Parks and recreation settings and active living: a review of associations with physical activity function and intensity. *J Phys Act Health* 5:619–632
- Kaczynski AT, Johnson AJ, Saelens BE (2010) Neighborhood land use diversity and physical activity in adjacent parks. *Heal Place* 16:413–415. <https://doi.org/10.1016/j.healthplace.2009.11.004>
- Kiani B, Mohammadi A, Bergquist R, Bagheri N (2021) Different configurations of the two-step floating catchment area method for measuring the spatial accessibility to hospitals for people living with disability: a cross-sectional study. *Arch Public Health* 79(1). <https://doi.org/10.1186/s13690-021-00601-8>
- Kim S, Tak S, Yeo H (2018) Agent-based network transmission model using the properties of macroscopic fundamental diagram. *Transp Res Part C: Emerg Technol* 93:79–101
- Lee G, Hong I (2013a) Measuring spatial accessibility in the context of spatial disparity between demand and supply of urban park service. *Landsc Urban Plan* 119:85–90. <https://doi.org/10.1016/j.landurbplan.2013.07.001>
- Lee G, Hong I (2013b) Measuring spatial accessibility in the context of spatial disparity between demand and supply of urban park service. *Landsc Urban Plan* 119:85–90
- Li Q, Zhang T, Wang H, Zeng Z (2011) Dynamic accessibility mapping using floating car data: a network-constrained density estimation approach. *J Transp Geogr* 19(3):379–393
- Lin Y, Zhou Y, Lin M, Wu S, Li B (2021) Exploring the disparities in park accessibility through mobile phone data: evidence from Fuzhou of China. *J Environ Manage* 281:111849. <https://doi.org/10.1016/j.jenvman.2020.111849>
- Liu D, Kwan M, Kan Z (2021) Analysis of urban green space accessibility and distribution inequity in the City of Chicago. *Urban for Urban Greening* 59:127029. <https://doi.org/10.1016/j.ufug.2021.127029>
- Liu Y, Kang C, Gao S, Xiao Y, Tian Y (2012) Understanding intra-urban trip patterns from taxi trajectory data. *J Geogr Syst* 14(4):463–483
- Liang H, Zhang Q (2018) Assessing the public transport service to urban parks on the basis of spatial accessibility for citizens in the compact megacity of Shanghai, China. *Urban Stud* 55(9):1983–1999. <https://doi.org/10.1177/0042098017705846>
- Luo W, Wang F (2003) Measures of spatial accessibility to health care in a GIS environment: synthesis and a case study in the Chicago region. *Environment and planning B: Plann des* 30(6):865–884. <https://doi.org/10.1068/b29120>
- Macintyre S (2007) Deprivation amplification revisited; or, is it always true that poorer places have poorer access to resources for healthy diets and physical activity? *Int J Behav Nutr Phys Act* 4(1):1–7. <https://doi.org/10.1186/1479-5868-4-32>
- Manandhar S, Suksaroj T, Rattanapan C (2019) The association between green space and the prevalence of overweight/obesity among primary school children. *Int J Occup Environ Med* 10(1):1–10
- Maroko A, Maantay J, Sohler N, Grady K, Arno P (2009) The complexities of measuring access to parks and physical activity sites in New York City: a quantitative and qualitative approach. *Int J Health Geogr* 8(1):34. <https://doi.org/10.1186/1476-072x-8-34>
- McKenzie BS (2014) Access to supermarkets among poorer neighborhoods: a comparison of time and distance measures. *Urban Geogr* 35:133–151
- Mears M, Brindley P, Barrows P, Richardson M, Maheswaran R (2021) Mapping urban greenspace use from mobile phone GPS data. *PLOS One*. <https://doi.org/10.1371/journal.pone.0248622>
- Mears M, Brindley P (2019) Measuring urban greenspace distribution equity: the importance of appropriate methodological approaches. *ISPRS Int J Geo Inf* 8(6):286. <https://doi.org/10.3390/ijgi8060286>

- Mears M, Brindley P, Baxter I, Maheswaran R, Jorgensen A (2020) Neighbourhood greenspace influences on childhood obesity in Sheffield, UK. *Pediatr Obes* 15(7)
- Meyer-Grandbastien A, Burel F, Hellier E, Bergerot B (2020) A step towards understanding the relationship between species diversity and psychological restoration of visitors in urban green spaces using landscape heterogeneity. *Landsc Urban Plan* 195:103728. <https://doi.org/10.1016/j.landurbplan.2019.103728>
- Miyake K, Maroko A, Grady K, Maantay J, Arno P (2010) Not just a walk in the park: methodological improvements for determining environmental justice implications of park access in New York City for the promotion of physical activity. *Cities Environ* 3(1):1–17. <https://doi.org/10.15365/cate.3182010>
- Nigro M, Cipriani E, del Giudice (2018) Exploiting floating car data for time-dependent origin–destination matrices estimation. *J Intell Transp Syst* 22(2):159–174
- Oh K, Jeong S (2007) Assessing the spatial distribution of urban parks using GIS. *Landsc Urban Plan* 82(1–2):25–32. <https://doi.org/10.1016/j.landurbplan.2007.01.014>
- Quatrini V, Tomao A, Corona P, Ferrari B, Masini E, Agrimi M (2019) Is new always better than old? Accessibility and usability of the urban green areas of the municipality of Rome. *Urban for Urban Greening* 37:126–134
- Rahman K, Zhang D (2018) Analyzing the level of accessibility of public urban green spaces to different socially vulnerable groups of people. *Sustainability* 10(11):3917. <https://doi.org/10.3390/su10113917>
- Reyes M, Páez A, Morency C (2014) Walking accessibility to urban parks by children: a case study of Montreal. *Landsc Urban Plan* 125:38–47. <https://doi.org/10.1016/j.landurbplan.2014.02.002>
- Rigolon A (2017) Parks and young people: an environmental justice study of park proximity, acreage, and quality in Denver, Colorado. *Landsc Urban Plan* 16:73–83
- Rigolon A (2016) A complex landscape of inequity in access to urban parks: a literature review. *Landsc Urban Plan* 153:160–169
- Schiavina M, Freire S, MacManus K (2019) GHS population grid multitemporal (1975–1990–2000–2015), R2019A. Eur Comm, Joint Res Centre (JRC). <https://doi.org/10.2905/0C6B9751-A71F-4062-830B-43C9F432370F> PID: <http://data.europa.eu/89h/0c6b9751-a71f-4062-830b-43c9f432370f>
- Tratalos JA, Barbosa O, Fuller RA, Davies RG, Gaston KJ, Armsworth PR, Johnson P (2007) Who benefits from access to green space? A case study from Sheffield, UK. *Landscape Urban Plan* 83(2–3):187–195. <https://doi.org/10.1016/j.landurbplan.2007.04.004>
- Vaughan K, Kaczynski A, Wilhelm Stanis S, Besenyi G, Bergstrom R, Heinrich K (2013) Exploring the distribution of park availability, features, and quality across Kansas City, Missouri by income and race/ethnicity: an environmental justice investigation. *Ann Behav Med* 45:28–38
- Vich G, Marquet O, Miralles-Guasch C (2019) Green streetscape and walking: exploring active mobility patterns in dense and compact cities. *J Transp Health* 12:50–59
- White PCL, Wyatt J, Chalfont G, Bland JM, Neale C, Trepel D, Graham H (2017) Exposure to nature gardens has time-dependent associations with mood improvements for people with mid- and late-stage dementia: innovative practice. *Dementia* 17:627–634
- Willemse L (2013) A flowmap–geographic information systems approach to determine community neighbourhood park proximity in Cape Town. *S Afr Geogr J* 95(2):149–164. <https://doi.org/10.1080/03736245.2013.847799>
- Wolch JR, Byrne J, Newell JP (2014) Urban green space, public health, and environmental justice: the challenge of making cities ‘just green enough.’ *Landsc Urban Plan* 125:234–244
- Wu J, He Q, Chen Y, Lin J, Wang S (2018) Dismantling the fence for social justice? Evidence based on the inequity of urban green space accessibility in the central urban area of Beijing. *Environ Plan B: Urban Analytics City Sci* 47(4):626–644. <https://doi.org/10.1177/2399808318793139>
- Xiao Y, Wang Z, Li Z, Tang Z (2017) An assessment of urban park access in Shanghai—implications for the social equity in urban China. *Landsc Urban Plan* 157:383–393

- Xing L, Liu Y, Wang B, Wang Y, Liu H (2020) An environmental justice study on spatial access to parks for youth by using an improved 2SFCA method in Wuhan, China. *Cities* 96:102405. <https://doi.org/10.1016/j.cities.2019.102405>
- Xing L, Liu Y, Liu X (2018) Measuring spatial disparity in accessibility with a multi-mode method based on park green spaces classification in Wuhan, China. *Appl Geogr* 94:251–261
- Xu C, Haase D, Pribadi DO, Pauleit S (2018) Spatial variation of green space equity and its relation with urban dynamics: a case study in the region of Munich. *Ecol Indic* 93:512–523
- Xu M, Xin J, Su S, Weng M, Cai Z (2017) Social inequalities of park accessibility in Shenzhen, China: the role of park quality, transport modes, and hierarchical socioeconomic characteristics. *J Transp Geogr* 62(129):38–50. <https://doi.org/10.1016/j.jtrangeo.2017.05.010>
- You H (2016) Characterizing the inequalities in urban public green space provision in Shenzhen, China. *Habitat Int* 56:176–180
- Zhai Y, Wu H, Fan H, Wang D (2018) Using mobile signaling data to exam urban park service radius in Shanghai: methods and limitations. *Comput Environ Urban Syst* 7:27–40
- Zhang H, Chen B, Sun Z, Bao Z (2013) Landscape perception and recreation needs in urban green space in Fuyang, Hangzhou, China. *Urban for Urban Greening* 12(1):44–52
- Zhang S, Zhou W (2018) Recreational visits to urban parks and factors affecting park visits: evidence from geotagged social media data. *Landsc Urban Plan* 180:27–35. <https://doi.org/10.1016/j.landurbplan.2018.08.004>
- Zhang X, Lu H, Holt J (2011) Modeling spatial accessibility to parks: a national study. *Int J Health Geogr* 10(1):31. <https://doi.org/10.1186/1476-072x-10-31>

**Open Access** This chapter is licensed under the terms of the Creative Commons Attribution-NonCommercial 4.0 International License (<http://creativecommons.org/licenses/by-nc/4.0/>), which permits any noncommercial use, sharing, adaptation, distribution and reproduction in any medium or format, as long as you give appropriate credit to the original author(s) and the source, provide a link to the Creative Commons license and indicate if changes were made.

The images or other third party material in this chapter are included in the chapter's Creative Commons license, unless indicated otherwise in a credit line to the material. If material is not included in the chapter's Creative Commons license and your intended use is not permitted by statutory regulation or exceeds the permitted use, you will need to obtain permission directly from the copyright holder.



# Chapter 14

## Inclusive Urban Transformation: Embracing the Values of Urban Villages in the PRD Region



Lei Qu 

**Abstract** The presence of urban villages inside the city is a common phenomenon in the Pearl River Delta (PRD) region. This chapter investigates the reference cases of Guangzhou and Shenzhen, to provide insights into the issues of inclusiveness in the rapid urbanisation process in this region, in the context of industrial upgrading and migration. This is done by exploring potentials and values of urban villages through mapping analysis, which serves as the basis for inspirational design proposals on alternative redevelopment models for urban villages, in contrast to the ongoing tabula rasa approaches. This chapter introduces a Delft approach of using ‘mapping’ as a tool to build a visual narrative on spatial relations and governance models in urban villages in the PRD region. The results indicate the values of urban villages as arrival cities to migrants, in terms of cultivating micro-economy and strengthening social resilience. To enhance such values, incremental developments that contribute to a more integrated spatial structure, providing space for small businesses and social interactions in urban villages, are considered strategic. In this sense, a more adaptive planning framework that makes room for co-creational urban regeneration processes is needed, in which these incremental developments can be facilitated.

**Keywords** Urban village · Urban transformation · Inclusiveness · Migration

### 14.1 Introduction

Currently, cities in the Pearl River Delta (PRD) region are mostly undergoing an industrial upgrading process, stimulated by various new industrial policies implemented by regional authorities (Liu 2020) to enhance socio-economic and environmental sustainability, which has led to a certain level of exodus of capital in affected sectors and increased industrial restructuring (Chen and de’Medici 2010). For example, since 2005, the Shenzhen municipality has tightened restrictions on land

---

L. Qu (✉)

Faculty of Architecture and the Built Environment, Delft University of Technology, Julianalaan 134, 2628 BL Delft, The Netherlands  
e-mail: [L.Qu@tudelft.nl](mailto:L.Qu@tudelft.nl)

© The Author(s) 2023  
S. Nijhuis et al. (eds.), *Adaptive Urban Transformation*, The Urban Book Series,  
[https://doi.org/10.1007/978-3-030-89828-1\\_14](https://doi.org/10.1007/978-3-030-89828-1_14)

267

usage, increased minimum wages and raised environmental standard for industrial development. The city has since then been re-profiling itself from a ‘world factory’ to a ‘world city’. New types of industries, e.g. in services and creative industries, started to increase while capital in those polluting, labour-intensive manufactory industries has seen a certain degree of withdrawal (Wall 2016). Along with this trend, it is foreseeable that new social groups will emerge, new social relations are to be formed and new demands on liveability and urbanity will be generated in cities of the PRD region. Next to such socio-economic transformation, spatial development in this region is focussing more and more on the built-up areas. Urban regeneration is playing a crucial role in reshaping spatial structure at the city-regional scale and urban form at the neighbourhood level. This reflects the paradigm shift in urban planning and development, from extensive urban expansion to adaptive urban redevelopment (Zou 2015). In this sense, the future of the cities lies in existing urban fabrics.

Urban villages, as one type of old urban fabric in the PRD region (as defined by ‘Sanjiu’ redevelopment in Guangdong Province, i.e. redevelopment of ‘three old types’ of land: old villages, old urban areas and old factories) (Wu 2018), have gradually been put on the agenda of urban regeneration practice in the last two decades, especially those located in central urban areas. For example, renewal of urban villages in Shenzhen in the 2010s started from those in the older sections of the city (O’Donnell 2021). For those who are unfamiliar with this phenomenon, urban villages are informal settlements built by villagers on homestead land, managed by village collectives. These informal settlements emerged during the rapid urbanisation process in which rural villages became part of the city due to urban expansion. The formation of urban villages is a process of densification with mixed urban functions, while at the same time, these villages remain rural in terms of governance and serve mainly rural–urban migrants. Due to the high demand on land for large-scale redevelopment in central areas, tabula rasa approaches were often implemented in the renewal of urban villages in PRD cities. As a consequence, issues related to gentrification and shortages of affordable housing in central urban areas emerged, which have generated debate in society. This is also the starting point of this chapter: to explore the potentials and values of urban villages, seeking more inclusive redevelopment models.

Thus, this chapter contributes to the understanding of socio-economic values of urban villages in PRD cities. It indicates the role of urban villages as arrival cities for migrants, in terms of cultivating micro-economies and enhancing social resilience as well as urban vitality. The intention of this chapter is to raise questions about the current urban regeneration practice in big cities like Guangzhou and Shenzhen in the PRD region. It also touches upon broader questions related to sustainable urbanisation in Chinese city regions and the role of urban planning and design in it: Who could play a vital role in the co-creational process for a more inclusive, liveable and vital city? And how could urban planning and design guide the spatial transformation within such processes? The ambition is not to give answers, but to generate a meaningful discussion, using the redevelopment of urban villages as examples (Fig. 14.1).





**Fig. 14.1** Hubei village in the central urban area, Luohu district, of Shenzhen. *Photos Lei Qu*

## 14.2 Theories and Practices Related to the Phenomenon of Urban Villages

### 14.2.1 *The Formation and Transformation of Urban Villages*

Villages in China are governed by village collectives, which is different to the urban system. In the PRD region, it is a common phenomenon that along with the rapid rural industrialisation and urban expansion processes, farmland in peripheral areas of cities has, to a large extent, been gradually transformed into urban use. During this process, villages that owned the farmland got compensated land for construction, to replace the lost form of income. From the late 1980s, these villages started to build factories and apartment buildings on compensated land, which were rented out to manufactories and new migrants, respectively. The village collectives oversaw the planning—dividing the homestead land—for these new developments; the individual families were the ones who raised funding and built apartment buildings on their own plots. Depending on the management style and capacity of the village, the physical environment as the result can be very different in terms of the level of informality. Nevertheless, the typical urban villages can be described as patchworks of semi-planned informal settlements.

As noted by Saunders (2011), many metropolises around the world have experienced the emergence of arrival cities, including Shenzhen. These are informal settlements, often at the outskirts of cities, in which rural–urban migrants try to integrate themselves socially and economically into the city. These arrival cities are mostly overlooked, and some even destroyed as their value and potential, for example cultivating the future middle class, is ignored.

Urban villages in the PRD region have indeed played the role of arrival cities, accommodating numerous rural–urban migrants by providing low-cost living for

them. However, due to the informal setting and problems in infrastructure and building quality, they are usually defined as problematic neighbourhoods that do not meet the universal standard of a ‘healthy city’, which leads to the ‘tabula rasa’ urban redevelopment approach. This approach has been commonly used in cities in the PRD region in central urban areas, where more large-scale urban renewal projects based on urban villages have been implemented than in peripheral districts. These projects are mostly related to the development of high-end housing or other urban functions, driven by the high pressure of industrial upgrading, population growth and land scarcity. Such pressure for redevelopment is usually less severe in peripheral districts, where alternative approaches of improving liveability in urban villages are being tested by local governments, social organisations, practitioners and people themselves in urban regeneration processes, focussing more on social construction (Vlassenrood 2016). Therefore, it is necessary to address the different local context when evaluating the urban regeneration practices in the PRD region. In places with a high pressure of large-scale redevelopment, recognising the value and potential of urban villages is essential to maintain affordable living for rural–urban migrants inside the city; in areas where no immediate redevelopment is to happen, adaptive solutions can be tested for improving the living and working conditions inside these arrival cities.

### ***14.2.2 Inclusiveness and Liveability***

The current discussion of liveability in Chinese cities focusses more on the universal standard of physical environment than the context-related perception and satisfaction of people, especially when it is related to old urban fabrics like urban villages. In these informal settlements, factors such as the commensurate level of income (Evans 2002), living expenditure, housing and services need to be considered in the discussion on liveability. For example, due to the inflamed real estate housing development and increasing focus on urban regeneration in Chinese cities, newly built commodity housing areas that are homogeneous, mono-functional and owner occupied have largely replaced the old neighbourhoods that accommodate the middle-low and low-income groups. These old neighbourhoods are usually not appreciated by the real estate market; however, they function as affordable housing and contribute to a real proximity between living and working for vulnerable groups (Qu et al. 2017).

Production and jobs are endogenous forces to the process of urban growth rather than exogenous drivers (Storper and Scott 2009). Meanwhile, along with the industrial upgrading process in the PRD region, social groups that work in emerging industries are increasing and they embrace new lifestyles. This development trend poses challenges to PRD cities in meeting the diversified demands of living. According to Florida (2004), places that are open and tolerant can attract different kinds of people and generate new ideas. This explains why big metropolises in the PRD region, especially Shenzhen with the slogan ‘You are a Shenzhener once you came’, are attracting migrants, including young graduates and skilled and unskilled workers to live there.

Thus, inclusiveness is essential to cities in the PRD region, from the perspective of liveability in the context of industrial upgrading and migration.

### ***14.2.3 Social Resilience Versus Entrepreneurship***

As indicated by the discussion above, this chapter proposes a people-centred approach in response to the rapid urbanisation and industrial upgrading processes in the PRD region, one to help the rural–urban migrants coping with the socio-economic and spatial transformations. From this perspective, social resilience—the relations among and adaptive capacities of social actors—needs to be emphasised.

Generally speaking, social resilience refers to the capacity of individuals and institutions to respond to crisis—the capacity to absorb changes, coping with known or un-known threats and disturbances (Glavovic et al. 2002). Social resilience within a society evolves from acceptance of changes passively, to prepare for them proactively. For rural–urban migrants, the sudden shift from rural to urban identities and environments along with the urbanisation process could be seen as an example of disturbance in their lives. The industrial upgrading process is part of the rapid socio-economic changes, which imposes extra challenges to the migrant workers who might lose job opportunities due to such transitions. From the perspective of cities, the influx of rural–urban migrants is also a huge challenge on public facilities and housing provision. The emergence of urban villages in the PRD region is the local response to demands of rural–urban migrants on low-rent housing, a challenge absorbed by the self-built houses of villagers. Next to the massive construction of apartment buildings inside urban villages, people (villagers and migrants themselves) kept adapting these informal settlements for livelihoods, which is a way to prepare for future uncertainties (Béné et al. 2012). As often seen in urban villages in the PRD region, shops and small businesses emerge along streets and alleys, where open markets are also organised by village collectives using leftover spaces, showing the adaptive capacities of people in the use of space, seeking every chance to thrive.

Such adaptive capacity varies among stakeholders, depending on their access to property rights, which determines their powers of influence in governance, as well as the level of participation in the process of urban redevelopment—the transformative capacity. Stakeholders with (or without) property rights are engaged (or not) in the decision-making process, which leads to, very often, big changes to their living environment (Voss 2008). For example, the village collective as the association of property owners can decide on radical redevelopment strategies in collaboration with real estate developers, for the sake of greater profit and a more promising future on financial terms. Such decisions, however, exclude the voices of the majority of migrants living in the urban village, who still struggle with adapting themselves into the urban life, and rely on their social capital attached largely to the place they live in. Hence, in a nutshell, urban villages inside the city contributed to social inclusiveness, functioning as arrival cities for migrants; however, they were built by villagers and managed by village collectives, functioning as a business entity for property owners

at the same time. Knowing such a fact can help us to understand the social value and entrepreneurship within such informal settlements.

#### ***14.2.4 Mapping as a Way of Thinking***

The above-mentioned theories and practices can provide a framework for interpreting the phenomenon of urban villages in the PRD region. However, to thoroughly unravel the complex issues at hand and explore the potential and possibility for more inclusive redevelopment of these informal settlements through urban planning and design, we need an effective tool to visualise the spatial features of urban villages that are associated with the socio-economic transition and governance model. ‘Mapping’ is usually seen as such a tool to analyse the current situation in cities and regions, linking spatial structure, functionality and urban form with social, economic and environmental performances. In this chapter, it is also seen as a visual narrative on inclusive urban redevelopment that is derived from illustrations of the current status and future scenarios of two urban villages in Guangzhou and Shenzhen, as representative cases of the PRD region. Examples of mapping analysis included in this chapter are from selected graduation projects conducted by TU Delft urbanism master’s students of the Complex Cities studio from 2013 to 2017. These analyses can help us to understand the interactions between macro-level spatial development trends and micro-level socio-economic dynamics inside urban villages, which could be used to inform decision-making and opt for alternative ways of urban regeneration. This MSc graduation studio serves as a powerful platform for conducting such research, as students are equipped with the knowledge and skills needed for mapping spatial relations and governance models, linking research, planning and design. The studio follows the Delft approach that uses mapping and drawing as a way of thinking (Nijhuis et al. 2017).

### **14.3 Two Cases of Urban Regeneration in Guangzhou and Shenzhen**

This section introduces two cases of urban regeneration in areas with urban villages in Guangzhou and Shenzhen. The case of the Lijiao village in Guangzhou represents the large-scale redevelopment of urban villages in central urban areas, and the foreseeable social consequences of the tabula rasa approach; the case of the Dalang district in Shenzhen showcases the potential for alternative incremental urban redevelopment in peripheral districts.

### 14.3.1 *The Lijiao Village in Guangzhou–Urban Redevelopment in Central Urban Areas*

The Lijiao Village is located at the end of the southern extension of the central axis of Guangzhou, currently one of the largest urban village redevelopment projects in the city (Fig. 14.2). The village has a history of almost 800 years. It is one of the key areas that represents the historical and cultural resources of the city. According to the head of the village, there are more than 70,000 migrants living in the village, much more than the number of villagers (around 10,000). In recent decades, the Lijiao village has experienced an evolution from a clan-based society to a production-oriented economic entity, later on to a semi-acquaintance community and eventually a neighbourhood with a majority of migrants. These changes are reflected in the transformation of its physical environment, such as the remaining ancestor halls of the clans, collectively owned land for industrial development, informal markets selling local food along the river and housing densification with new typologies of apartment buildings accommodating migrants upstairs and shops on the ground floor (Fig. 14.3).

Along with the decreasing of secondary industries in the overall economic structure of Guangzhou, low-end manufactory industries inside urban villages, such as those collectively owned land for industrial development in the Lijiao village, will be gradually replaced soon. Instead, the emerging industries, like e-commerce, will

**Fig. 14.2** The location of the Lijiao village in Guangzhou. *Image* Qiao Yang, TU Delft





**Fig. 14.3** The spatial configuration representing the transformation of the Lijiao village in the past decades. *Image* Qiao Yang, TU Delft

offer new opportunities for young entrepreneurs who see urban villages as suitable places for investment. For example, in Guangzhou, ‘Taobao villages’ have emerged in urban (and rural) villages along the edge of the central city, with clustered small businesses based on the e-commerce platform called ‘Taobao’ (Zhang et al. 2016). The flexibility embedded in informality in the use of space in urban villages offers people possibilities to be entrepreneurial. Such processes of accumulating wealth and social capital is also a process of climbing the social ladder.

Since 2007, the village collective intended to collaborate with developers in the redevelopment of the Lijiao village. After five years of negotiation, the village reached an agreement with the developer Zhuguang Group on the redevelopment model, which will be ‘demolition and reconstruction’ for most parts of the village, except for the preserved cultural heritage sites such as the ancestor halls. One of the conditions was that the developer would construct apartment buildings for relocating villagers as compensation for the property owners of the current apartment

buildings in the village. However, the negotiations about compensation standards became a protracted battle among all stakeholders, including the government, developer, village collective and villagers. In August 2015, Zhuguang Group raised the compensation standard, which attracted interest from many villagers. In May 2018, more than 80% of the villagers agreed with the compensation proposal, which means the long process of negotiation had come to an end and the redevelopment will go forward. This also means that soon the large number of migrants and businesses in the village will be gone.

The mapping analysis not only provides evidence for the foreseeable social consequence of such a tabula rasa approach, but also serves as a basis for exploring alternative development models that are more incremental and can accommodate certain types of the new economy (mainly small businesses, e.g. the above-mentioned e-commerce) while maintaining this urban village as an inclusive living and working environment for the migrants. Such alternative models seek a balance between social resilience and entrepreneurship and require a more adaptive planning framework that encourages the property owners to transform their self-built houses. A win-win situation can possibly be achieved through design experiments within a co-creational process, in which the government, the villagers, the small businesses and the migrants jointly adapt the built environment. The proposal sheds light on such a planning and design process for exploring the potential of urban villages in strategic locations in Guangzhou as inclusive neighbourhoods. It is based on conclusions from the mapping analysis for the Lijiao village—the potential of adapting the village into an open neighbourhood for all, using the inherited historical spatial structure as a framework for self-organisation. (Fig. 14.4).

### ***14.3.2 The Dalang District in Shenzhen—Alternative Development Model in Peripheral Areas***

There are around 300 urban villages in Shenzhen, and the majority of them are located in peripheral districts. This is related to the urban planning and development trajectory of Shenzhen. In the 1980s, Shenzhen started its rapid urban development almost from scratch, from a series of fishing villages and small towns with a total population of 300,000. Urban planning was focussing on the central urban districts, where the construction of a special economic zone and a city became the priority of the municipal government. To the contrary, the peripheral districts experienced spontaneous, rural industrialisation processes as the result of the absence of urban planning. Furthermore, the contrast between the informal urban landscape in the periphery and the well-planned global-city image of the central areas represent different stages of urban redevelopment in Shenzhen.

Dalang is an industrial city district located close to the northern edge of a central urban district (Nanshan district) of Shenzhen (Fig. 14.5). Over 95% of the population there are young migrant workers. The urban fabric in Dalang represents the mutual



**Fig. 14.4** A design proposal for adapting the Lijiao village into an open neighbourhood. *Image* Qiao Yang, TU Delft

development of industrial parks and urban villages typical in peripheral districts of Shenzhen. In recent years, the municipal government started to stimulate more integrated development in Shenzhen, which led to urban redevelopment in peripheral districts, including Dalang. The four main types of urban regeneration practices in Shenzhen are all taking place here: the improvement of infrastructure; reconstruction near the new metro station; the former industrial buildings renovated for commercial use; and urban village regeneration (Fig. 14.6). However, comparing to central urban areas, regeneration of urban villages in Dalang is more incremental, as there is no pressure for large-scale redevelopment. Improving living conditions for migrant workers becomes the main objective.

Within urban villages in Dalang, retail is to a large extent involved in migrants' daily lives and offers them job opportunities. According to a survey done by TU Delft students, amongst over 100 migrant workers in Dalang, most migrant workers have lived in Dalang for more than three years. Staying in Shenzhen is often seen as a preference, although many of them are not fully satisfied with the current living conditions. The survey shows that many of them would like to become a manager, or to be self-employed in the future. Therefore, running a small business, such as a retail store in an urban village, could be an option for some migrant workers for career development. These stores, on the other hand, can provide low-cost living for migrants in urban villages and contribute to street vitality. Some TU Delft students summarised the main factors that affect retail store distribution based on street integration analysis by space syntax and verification on site in urban villages in North





Fig. 14.5 The location of the Dalang district in Shenzhen. Image Qiao Yang, TU Delft

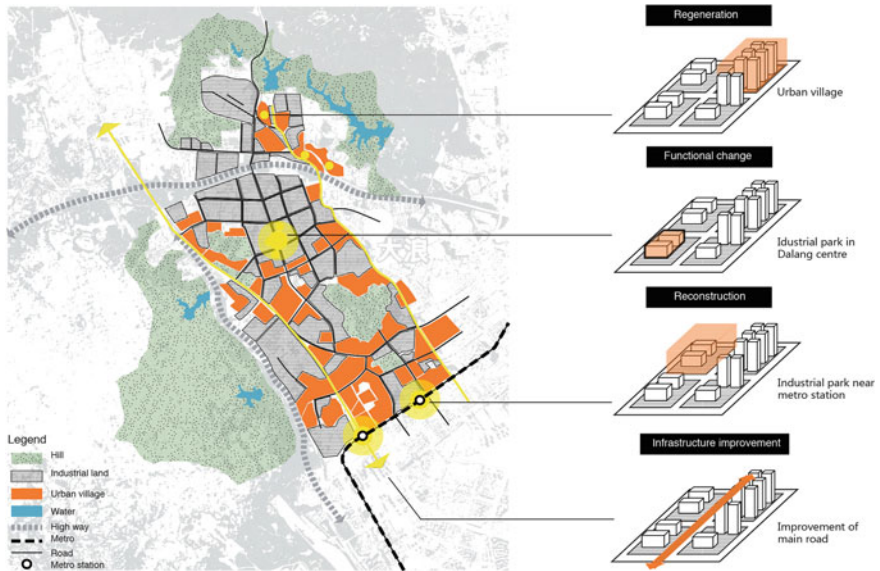


Fig. 14.6 The urban fabric and four main types of urban regeneration practices in Dalang. Image Yishiqin Li, TU Delft

Dalang. The findings clearly show that the distribution of retail stores is strongly correlated with street connectivity (Fig. 14.7). The retail stores are mostly situated on the ground and first floors of residential buildings, which show a tendency of clustering in pedestrian friendly streets with wide sidewalks.

From the perspective of inclusiveness, an alternative redevelopment strategy for urban villages in Dalang other than the tabula rasa approach implemented in central urban areas would be to maintain and unlock the potential of these urban villages in accommodating such small businesses. This is actually in line with the ongoing developments encouraged by the local district government. There are small projects in Dalang districts co-created by villages (providing space), local district government (providing funding), practitioners (providing design proposals) and social organisations (facilitating public participation), improving public spaces and facilities for the migrant workers. A participatory planning approach oriented towards social construction and community development is emerging in this peripheral district of Shenzhen.

Considering the special context of this peripheral district, TU Delft students concluded their research with planning and design principles for urban regeneration



**Fig. 14.7** Overlaying the mapping of retail stores and street integration analysis at  $R = 800$ . *Image* Yishiqin Li, TU Delft



**Fig. 14.8** A design proposal for activating waterfront public spaces through new connections in North Dalang. *Image* Yishiqin Li, TU Delft

in urban villages in Dalang. These include, for example, increasing street integration, prioritising slow traffic as well as the comfort of walking and cycling environment and diversifying public space to facilitate street vendors and other informal activities. The mapping analysis helped to indicate potential areas for intervention. Figure 14.8 shows an example of a design proposal that illustrates how the improvement of (currently abandoned) waterfront area next to an urban village in North Dalang and the new connections through a footbridge can contribute to the integration of street networks and activate public spaces. Based on this, new commercial functions and flexible spaces for vendors are expected to emerge, which will contribute to the inclusiveness and vitality of this area.

## 14.4 Discussion

As shown by both case studies, informality is the main feature of micro-economy in urban villages, including, for example, the informal housing market and small businesses. From the perspective of property owners—the villagers—rental income generated by their self-built houses is the most important part of the village economy. However, the small businesses located in urban villages not only contribute to the village economy through rent, but also offer job opportunities to migrants, as well as urban vitality to the neighbourhood. Such informal economy is accommodated within a self-organised spatial structure inside the urban villages. From the spatial perspective, the integration of such spatial structure—mainly public space networks that are connected by streets, alleys and waterways in urban villages—provides the most potential to generate adaptable and affordable spaces for small businesses to thrive. This is meaningful for developing alternative urban regeneration approaches for urban villages that are more incremental and inclusive in the context of industrial upgrading and migration. In this sense, facilitating small-scale strategic interventions and making room for self-organisation are relevant principles to planning and design

for urban regeneration in urban villages. To do so, a powerful tool is needed to analyse the current socio-spatial conditions, envisage better scenarios and identify strategic interventions, so that stakeholders could be better informed on win–win situations. This chapter introduced ‘mapping’ as such a tool. Through exemplary student work, it demonstrated how mapping can help to unravel the complex issues and facilitate decision-making in the planning and design process.

As indicated by both case studies, such incremental and inclusive approaches require a co-creational process that engages the stakeholders involved, including villagers, migrants, social organisations and the local government. In practice, experiments on similar participatory urban regeneration projects are emerging in peripheral areas in Shenzhen (as shown in the Dalang case) that are very different to the tabula rasa redevelopment happening in central locations of the PRD cities (such as the Lijiao village in Guangzhou). How could urban planning and design guide the spatial transformation process when co-creation and self-organisation become the way of working? The current physical conditions in urban villages are not ideal and have up- and down-sides: on the one hand, they lack public spaces and amenities; on the other, there are a variety of public activities (e.g. those centred around food stands, retail stores, nightlife, etc.). Improving safety, hygiene and providing possibilities to socialise in public spaces can offer migrants opportunities to build social networks and further improve social resilience (indicated by the design proposal for the Lijiao village). Besides, being part of the owners of small businesses inside urban villages is also an option for migrants’ career development (conclusions from the research on Dalang). These socio-economic benefits are nested in the role of urban villages as arrival cities for migrants, providing affordable housing and as stepping-stones to climb the social ladder. From the planning perspective, a more adaptive and flexible framework is needed which makes room for incremental developments that enhance spatial quality, urban vitality and social resilience. This requires a new mentality and entrepreneurial capacity of the planning sector. Within this framework, design proposals can play a new role that provides inspiration for and facilitates the co-creation process in small-scale urban regeneration projects.

Although this chapter introduced ‘mapping’ as a tool for analysing the socio-spatial conditions of urban villages in the PRD region and facilitating decision-making in co-creational processes of urban regeneration, one has to know the limitations of such methods. One of the major challenges in using this method is the lack of reliable data in urban villages, as the development of these informal settlements have never been officially registered. Most of the mapping analyses shown in this chapter were manually done by students with data obtained through intense field work. When applying this method in practice, extensive investigation is needed to gather data, which needs the support from villagers when it comes to complex issues such as property ownership.

## 14.5 Conclusions

Urbanisation in China is an ongoing process that leads to formation and transformation of city regions with large numbers of migrants. What are effective planning and design strategies that could stimulate the transition of PRD cities like Guangzhou and Shenzhen towards a more inclusive, liveable and socially resilient future scenario? Answers to this question may vary between cities, which are at different stages of industrial and urban development. A good understanding of correlations among socio-economic conditions, urban form and governance can help unlock the potential of cities.

Generally speaking, Chinese cities are experiencing a paradigm shift in urban development modes, focussing more and more on regeneration of existing built-up areas than the construction of new towns or districts. Urban regeneration brings opportunities to improve liveability and urban vitality, creating better places for people and facilitating social development. This, however, can only happen when the planning process is inclusive to all social groups, especially migrants who do not have the equal access to public resources as local citizens, nor voices in the decision-making process.

Urban villages in the PRD region represent a unique phenomenon of informal settlements that facilitate social resilience and entrepreneurship at the same time. They emerged and contributed greatly to accommodating the large number of rural–urban migrants along with the rapid urbanisation process, providing space for these people to adapt themselves to a new urban life. The micro-economy inside urban villages also offered job opportunities to migrants and vitality to the city. Furthermore, the flexibility embedded in informality enables urban villages to adapt to new economies in response to the ongoing industrial upgrading process. These above-mentioned values all help to strengthen the role of urban villages as arrival cities to rural–urban migrants, which is crucial to social resilience and needs to be recognised in urban redevelopment processes. This requires a new mentality and entrepreneurial capacities of the public sector in guiding the co-creation processes in urban regeneration practices. It is an alternative approach focussing more on social construction and cultivating small businesses, different to the large-scale *tabula rasa* redevelopment projects often seen in central areas of the big cities in the PRD region.

This chapter focuses on urban villages in the PRD region, using two cases from Guangzhou and Shenzhen. It introduces a powerful tool—‘mapping’—for analysing the current socio-spatial conditions of urban villages, which can serve as the basis for envisioning more inclusive future scenarios and identifying strategic interventions. This is not a new tool for urban planning in general, but indeed new and promising to studies on urban villages, as the development of such informal settlements in the PRD region have never been officially registered, which also poses challenges for conducting such research due to the lack of data. Nevertheless, as mentioned above, a more adaptive planning framework is needed to make room for co-creational and self-organised processes, in which incremental development that enhances the values of urban villages as arrival cities for migrants are encouraged. Hopefully, with such an

alternative planning and development model, the tool and research method introduced by this chapter can be used more effectively through the support of all stakeholders involved.

## References

- Béné C, Godfrey-Wood R, Newsham A, Davies M (2012) Resilience: new utopia or new tyranny? Reflection about the potentials and limits of the concept of resilience in relation to vulnerability reduction programmes. IDS working paper 405, Institute of Development Studies, Brighton
- Chen X, de’Medici T (2010) Research note—the ‘instant city’ coming of age: production of spaces in China’s Shenzhen special economic zone. *Urban Geogr* 31(8):1141–1147. <https://doi.org/10.2747/0272-3638.31.8.1141>
- Evans P (2002) Introduction: looking for agents of urban livability in a globalized political economy. In: Evans P (ed) *Livable cities? Urban struggles for livelihood and sustainability*. University of California Press, Berkeley, pp 1–30
- Florida R (2004) *The rise of the creative class: and how it’s transforming work, leisure, community and everyday life*. Basic Books New York
- Glavovic B, Scheyvens R, Overton J (2002) Waves of adversity, layers of resilience: exploring the sustainable livelihoods approach. In: Storey D, Overton J, Nowak B (eds) *Contesting development: pathways to better practice*. Proceedings of the third biennial conference of the Aotearoa New Zealand international development studies network (DevNet), Massey University, pp 289–293
- Liu Y (2020) Industrial upgrading and evolutionary strategic coupling in the Pearl River Delta. In: *Local dynamics of industrial upgrading: the case of the Pearl River Delta in China*. Springer, Singapore. [https://doi.org/10.1007/978-981-15-4297-8\\_4](https://doi.org/10.1007/978-981-15-4297-8_4)
- Nijhuis S, Stolk E, Hoekstra M (2017) Teaching urbanism: the Delft approach. *Proceedings of the Institution of Civil Engineers - Urban Design and Planning* 170(3): 96–106. <https://doi.org/10.1680/jurdp.16.00013>
- O’Donnell MA (2021) The end of an era? Two decades of Shenzhen urban villages. *Made China J* 6(2). <https://madeinchinajournal.com/2021/12/01/the-end-of-an-era-two-decades-of-shenzhen-urban-villages/>
- Qu L, Huang X, Yang Q (2017) The declining and the thriving neighborhoods: urban regeneration in the Chinese context of migration and economic transition. In: Tieben H, Geng Y, Rossini F (eds) *The entrepreneurial city*. Proceedings of the 10th conference of the international forum on urbanism (IFoU). Chinese University of Hong Kong, Hong Kong, pp 286–296
- Qu L, van Oostrum M, Liu J, Li Y, Hoek R, Yang Y, He Z, Buyschaert A, Xiao Y, Peng J, van Eijk S, Yang Q (2017) *Mapping atlas of Shenzhen—Urban villages*. Delft University of Technology, Delft
- Saunders D (2011) *Arrival city: how the largest migration in history is reshaping our world*. Windmill Books, London
- Storper M, Scott A (2009) Rethinking human capital, creativity and urban growth. *J Econ Geogr* 9(2):147–167
- Vlassenrood L (2016) Chinese urbanization through the lens of Dalang. In: Vlassenrood L (ed) *Shenzhen: from factory of the world to world city*. NAi Publishers, Rotterdam, pp 92–103
- Voss M (2008) The vulnerable can’t speak. An integrative vulnerability approach to disaster and climate change research. *Behemoth: J Civilisation* 1(3):39–56
- Wall R (2016) Shenzhen centre for life science: from workshop to laboratory. In: Vlassenrood L (ed) *Shenzhen: from factory of the world to world city*. NAi Publishers, Rotterdam, pp 174–194
- Wu F (2018) Planning centrality, market instruments: governing Chinese urban transformation under state entrepreneurialism. *Urban Stud* 55(7):1383–1399

- Zhang J, Qian Q, Chen Y, Jiang Y (2016) The spatial change of Tao Bao village in Lirengdong, Guangzhou in the perspective of spatial production. *Econ Geogr* 2016(1):120–126
- Zou B (2015) The transition from increment planning to inventory planning: theoretical analysis and practical response. *Urban Plann Forum* (5):12–19. (paper written in Chinese: 邹兵. 增量规划向存量规划转型: 理论解析与实践应对[J]. 城市规划学刊

**Open Access** This chapter is licensed under the terms of the Creative Commons Attribution-NonCommercial 4.0 International License (<http://creativecommons.org/licenses/by-nc/4.0/>), which permits any noncommercial use, sharing, adaptation, distribution and reproduction in any medium or format, as long as you give appropriate credit to the original author(s) and the source, provide a link to the Creative Commons license and indicate if changes were made.

The images or other third party material in this chapter are included in the chapter's Creative Commons license, unless indicated otherwise in a credit line to the material. If material is not included in the chapter's Creative Commons license and your intended use is not permitted by statutory regulation or exceeds the permitted use, you will need to obtain permission directly from the copyright holder.



# Chapter 15

## Wetland Parks in Guangzhou: Ecosystem Services and Perception



Xuezhu Zhai , Ross Cameron , and Eckart Lange 

**Abstract** The Pearl River Delta is suffering from increased vulnerability to flooding and declining biodiversity. Loss of wetlands is contributing significantly to these factors. Designed wetland parks are believed to compensate for the loss of natural wetlands and to support urban ecology, reduce flood vulnerability and disaster risks, and promote human well-being by providing ecosystem services, i.e. direct or indirect benefits that people get from ecosystems. This chapter gives an overview of the transition in wetlands and their ecosystem services in Guangzhou. It also explores the ecosystem services that wetland parks provide and how they are perceived by the public. It aims to determine which ecosystem services are preferred and what kind of wetland parks are most suitable for ecologically and culturally sustainable development in Guangzhou. The findings are expected to inspire future adaptive planning and design of wetland parks.

**Keywords** Wetlands transition · Wetland parks · Ecosystem services · Perception · Guangzhou

## 15.1 Introduction

### 15.1.1 Wetlands and Deltaic Sustainability

The Pearl River Delta (PRD) is formed by a network of several large rivers, the West, North and East River. It is a highly flood-prone region with about 85% urbanisation. It has a classical subtropical monsoon climate and suffers from excess water due to

---

X. Zhai (✉) · R. Cameron · E. Lange  
Department of Landscape Architecture, The University of Sheffield, Sheffield S10 2TN, UK  
e-mail: [Xzhai4@sheffield.ac.uk](mailto:Xzhai4@sheffield.ac.uk)

R. Cameron  
e-mail: [r.w.cameron@sheffield.ac.uk](mailto:r.w.cameron@sheffield.ac.uk)

E. Lange  
e-mail: [e.lange@sheffield.ac.uk](mailto:e.lange@sheffield.ac.uk)



heavy precipitation from April to September every year. Over the past 40 years, the natural wetland<sup>1</sup> area of the PRD has decreased dramatically; large areas of mudflats have been replaced by modern buildings and sealed surfaces (Zhao et al. 2016). The remaining urban wetlands are severely fragmented and often polluted, wildlife habitats have been damaged, and the ecological restoration function has declined. After losing the “sponge” that detains and stores stormwater, there have been more summer floods in the PRD in recent years. In this context, wetland parks (WPs), i.e. designed sustainable ecosystems with human and ecological value (Day et al. 2016), could be an appropriate basis for sustainable delta management and contribute to the remaining wetland ecosystem (Zhang et al. 2012).

### 15.1.2 Ecosystem Services

Ecosystem services (ESs) are understood as the benefits that humans get from the ecosystem and its conditions and processes (Costanza et al. 2017; Daily et al. 1997; Millennium Ecosystem Assessment 2003). ESs can link healthy biophysical ecosystems to human well-being. It is well established that ESs assessment could support biodiversity conservation, decision making, site management and spatial planning (Daily et al. 1997). In addition, the 14th Five-Year Plan of Guangzhou also emphasises the need to establish an Ecological Product Value (EPV, i.e. ESs) Realisation Mechanism, to better understand the wider values of natural/semi-natural ecosystems, such as wetlands and the need to protect them. Thus, we believe that a reasonable estimate of the ESs, especially the perceived value of the public, is the first step to embed them more fundamentally into future landscape designs.

## 15.2 Wetlands and Their ESs in Transition, Guangzhou

Located in the centre of the PRD between approximately 112°57′–114°3′E and 22°26′–23°56′N, Guangzhou covers an area of 7434.4 km<sup>2</sup>. The land slopes gradually from the north to the south. In the mountainous north, water catchments are depicted largely by lakes and streams, but are dominated by wider rivers and coastal wetlands in the south.

Most places of Guangzhou were still coastal or seascapes until the Ming and Qing dynasties (about six hundred years ago), when the current landscape pattern of Guangzhou began to take shape (Li 1983). It was also during this period that mulberry-dyke-fishpond began to develop as an efficient agricultural system for fish

---

<sup>1</sup> This chapter adopts the definition by the Ramsar Convention: “wetlands are areas of marsh, fen, peatland or water, whether natural or artificial, permanent or temporary, with water that is static or flowing, fresh, brackish or salt, including areas of marine water the depth of with at low tide does not exceed six metres” (RSC 2016).

and silk production (Liu 2016). Until 1954, the built-up area of Guangzhou was still small, with a large area of surrounding wetlands (e.g. rice paddy, rivers, dyke-ponds, and coastal wetlands), orchards, and woods (U.S. Army Map Service 1954).

From the 1950s, Guangzhou began its economic development and the population has grown: there are 18.7 million permanent residents, nearly ten times the population in 1953 (Guangzhou Statistics Bureau 2021). The rise in population and urbanisation has resulted in a significant loss of wetlands, including paddy fields, aquaculture ponds, shallow marine water and rivers (Zhao et al. 2016). Meanwhile, highly intensive aquaculture replaced the traditional and ecological dyke-pond system (Hehl-Lange and Lange 2019). Moreover, many river branches (e.g. Liwan River and Donghao River) have been covered over and/or polluted since the 1950s.

New wetland parks (WP) have been designed and constructed recently, in response to more frequent flood disasters in the city and the increasing demand for recreational space. These landscapes are believed to be an effective nature-based solution to provide a compromise between wildlife protection and human utilisation. The development of WPs in Guangzhou covers the following four stages:

### ***15.2.1 Spouting (1958–2003)***

Four lake parks (LPs) were built in 1958. Labour was organised to excavate four artificial lakes, i.e. Liwan Lake (17 ha), Liuhua Lake (32 ha), Lu Lake (21 ha) and Dongshan Lake (23 ha) and to create parks that could maintain ecological balance, retain floods and provide cultural services (Li et al. 2018; Wu 2013; Wu and Lin 2018).

On joining the Ramsar Convention in 1992, the Chinese government agencies have gained relevant experience of legal, technical and management aspects associated with wetlands from cases abroad and thus laid the foundations for developing a new generation of WPs (Ma 2016).

### ***15.2.2 Forming (2004–2012)***

Recognising the local and regional environmental significance of wetlands, from 2004 to 2005, the State Council issued a series of documents to strengthen wetland protection and point out the development direction of WPs (Ma 2016, p. 6). After Xixi National WP in Hangzhou, the first national WP in China was opened in 2005 and the number of WPs accelerated rapidly (Ma 2016, p. 7).

At the end of 2006, construction of Baiyun Lake Park started as part of the Pearl River West Channel Water Diversion Project and became the largest artificial lake in Guangzhou (with 106 ha of waterbody) (Yu et al. 2018). In 2008, Haizhu National WP (with an area of 1100 ha) was created by turning some orchard-dyke-fishponds

into larger lakes and reserving other dyke-ponds as ecological conservation areas (PPCCHD 2013).

Riverine wetlands were also transformed into WPs in this period. Remediation projects of the submerged and heavily polluted Lizhi River and Donghao River were implemented in 2009. Nowadays, these water systems possess clear water and have become popular places for recreation.

### ***15.2.3 Maturing (2012–2019)***

In the following years, many more artificial lakes or wetlands were created. Improved knowledge and advanced technology about constructed wetlands was utilised in the development of these wetlands, making WPs more mature in terms of habitat structure and ecological complexity.

Currently within Guangzhou, there are 12 large lakes and eight artificial wetlands for stormwater storage (Guangzhou Water Authority 2020) as a nucleus for WPs.

### ***15.2.4 Developing and Upgrading (2020 Onwards)***

More WPs are still under construction, and some existing WPs are currently being renewed or re-designed. For example, renewal of the Haizhu National WP includes expanding the water area, expanding the size of the area of floral displays, adding food courts, adding a museum etc., to improve recreation and aesthetic experience supporting natural education.

Considering the abundant river resources in Guangzhou (with 30 large rivers and 1338 river branches, with a total length of 5000 kms), the Ecological Belt programme along rivers was proposed for urban water treatment, ecological restoration and recreational and aesthetics services (Guangzhou Water Authority 2020). The 14th five-year plan (2021–2025) of Guangzhou emphasised the importance of the Ecological Belt and pointed out the necessity to upgrade three WPs (i.e. Baiyun WP, Haizhu National WP and Nansha WP) by strengthening the landscape and recreational facilities while protecting ecological resources. From a historical perspective, the ESs provided by the early wetlands in Guangzhou under human intervention changed from water supply services to regulation services. Then more emphasis was placed on cultural services and support services while ensuring regulation services, indicating the transitions within wetland and human needs. In the future, WPs will play an essential role in the development of Guangzhou.

### 15.3 Wetland Park and Their ESs in Guangzhou

WPs in Guangzhou (Fig. 15.1) vary considerably in area and width, and they usually originated in three ways:

- Designation of existing park space for wetlands management.
- Transfer of natural wetlands for use as new park space because they contain wetland characteristics worthy of protection and restoration in a more public setting.
- Creation of park space with constructed wetlands for surrounding run-offs retention or water quality improvement.

Some ESs associated with WPs in the PRD have been evaluated through multiple methods by local experts. WPs in Guangzhou can provide ESs, including wildlife habitat, flood regulation, air regulation, water purification, recreation, aesthetics and natural-based education (Table 15.1).

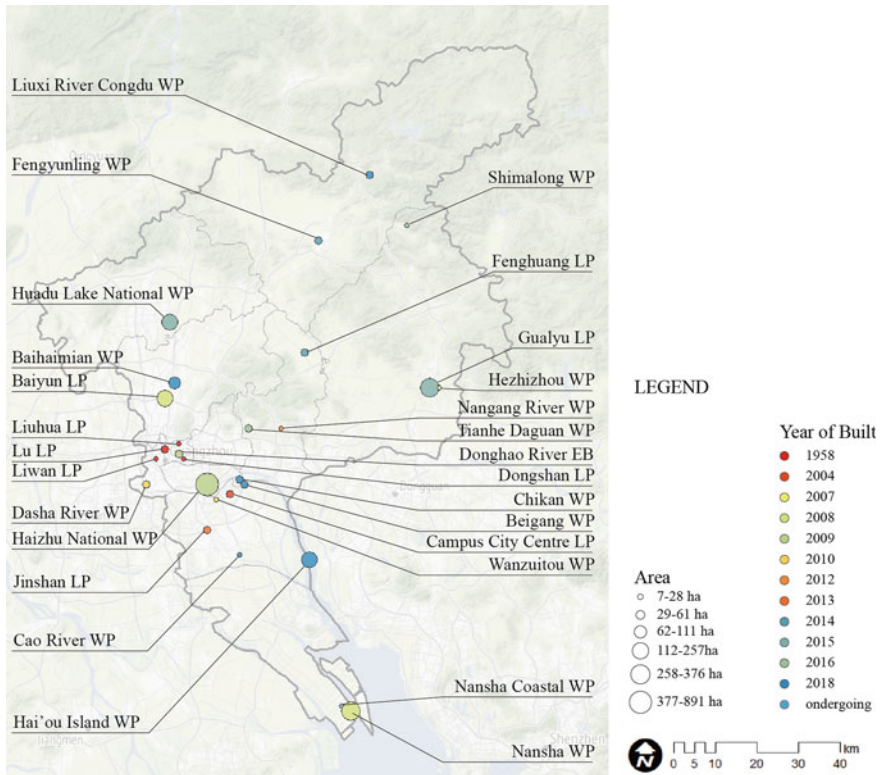


Fig. 15.1 Wetland parks in Guangzhou. Image Xuezhu Zhai

**Table 15.1** ESs associated with WPs in Guangzhou

	S1	S2	P1	R1	R2	R3	R4	R5	C1	C2	C3	C4
Liwan LP	+					√						+
Lihua LP				+		√			+			
Dongshan LP						√						
Lu LP						√						
Wanzuitou WP	+	√							√			
Baiyun LP				+		+			+			
Nansha WP	+	+	+	+		+	+	+	+		+	
Haizhu national WP	+	+		+	+	+		+	+	+	+	+
Dasha river WP	+					+			+			
Nangang river												
WP	+					+			+			
Tianhe Dagan WP	+			+		√			+			

S1: flora habitat, S1: fauna habitat; P1: food provisioning; R1: water purification, R2: air regulation, R3: flood regulation, R4: climate regulation, R5: water regulation; C1: recreation, C2: aesthetics, C3: natural-based education, C4: cultural heritage

+ : ESs that have been assessed, √: ESs that the WP aim to provide

Note Only the WPs and ESs mentioned in the literature were listed in the table

### 15.3.1 Habitat

Wetland parks provide habitat for wildlife. Several studies have evaluated habitat services of WPs for plants and birds. Imported and invasive plant species account for a large proportion of WPs in Guangzhou. For example, there are a total of 625 species of vascular plants recorded in the Haizhu Wetland, including 320 species (51.2%) of introduced plants, 268 species (42.88%) of native plants and 37 species of invasive alien plants (5.92%) (Huang et al. 2018). It is estimated that the habitat service value is 2.1 million CNY per year, accounting for 1.83% of the total ESs value of this WP using the Benchmarking Method according to unit value of wetland wildlife habitat of global ESs assessment (Xie and Guo 2018, p. 30). In the Tianhe Dagan WP, the 2017 survey showed that there are 66 plant species, and that there is a slight increase in the number of plant species compared to before the WP was created (Wang 2019). Mangroves are mainly distributed in two coastal WPs in Nansha, and there is also a small area in Haizhu National WP.

WPs provide habitats for many birds in Guangzhou: there have been 392 species of birds recorded in Guangzhou in recent years, of which 258 have been recorded in WPs (Joint Action Platform of Chinese Bird Watching Organisation 2021). Among the 258 species, 24 are National Secondary Protected species, including five near-threatened species, two vulnerable species, two endangered species (i.e. black-faced spoonbill (*Platalea minor*) and great knot (*Calidris tenuirostris*)) and two critically endangered species (i.e. Baer’s pochard (*Aythya baeri*) and yellow-breasted bunting

(*Emberiza aureola*) (defined by IUCN)). Nansha WP plays a vital role in providing habitat for migrating waterfowl, especially endangered species such as black-faced spoonbill and great knot.

### ***15.3.2 Water Purification***

Wetlands can filter nutrients and pollutants from surface water and upstream water. After sedimentation and filtration of the Pearl River water flowing into the Haizhu National WP, the water quality improves and reaches the standard for recreation. The value of the water purification is estimated to be 17.7 million CNY per year, accounting for 15.47% of the total ESs value (Xie and Guo 2018, pp. 29–30). The water quality at Daguan improved after it became a WP, with almost all sampling points reaching water quality standards for recreation, with water purification correlating with increased vegetation coverage in the water (Wang et al. 2019).

### ***15.3.3 Flood Regulation***

Low-lying wetland areas work as sinks that retain flood water. However, the actual flood regulation performance and storage capacity of WPs has not been studied yet in detail.

### ***15.3.4 Air Regulation***

Theoretically, vegetation in WPs could regulate the atmospheric CO<sub>2</sub> and O<sub>2</sub> balance and absorb air pollutants. However, there is no quantitative survey on air regulating service in WPs in Guangzhou. According to vegetation type and area, the annual atmospheric regulation value of the Haizhu Wetland is estimated to be about 6.5 million CNY (Liu 2019).

### ***15.3.5 Recreation***

The Haizhu National WP attracts approximately 10 million visitors. It is estimated that the recreation value of Haizhu National WP is about 507 million yuan per year (Liu et al. 2019). About 14.5 million people used Liwan LP in 2009, for taking walks, sitting, exercising and watching Cantonese Opera (Zhang and Huang 2015).

### **15.3.6 Environmental Education**

Information is provided to visitors through signs which convey information about wetland functions and wetland habitats in WPs. Several well-known WPs with high quality habitats also hold some nature-based education activities. Haizhu Wetland Nature School offers popular courses and activities, e.g. for family groups at weekends (Fan et al. 2017). Environmental education companies provide fee-based nature study tours and wildlife watching activities in Haizhu National WP and Nansha WP, allowing participants to learn about plants, birds and insects in the daytime and amphibians at night. Most of these activities are only aimed at children, and there are few specific activities for adults; however, the willingness of adults to participate in nature observing activities is not low. From June 2019, Guangzhou Nature Observation Association organised a half-year wild bird observation and education activity in three WPs (i.e. Haizhu National WP, Lu LP and Liuhua LP); in June alone, more than 5,000 participants (mostly adults) were involved (Luo 2019).

## **15.4 Public Perception of Ecosystem Services Delivered in Wetland Parks**

Generally, all ecosystems deliver ESs. People from urban environments are often not aware of their existence. If explained, it is easy for people to understand their importance, but they may still question their value (see Daily 1997). The disparity between actual ecosystem service value and perceived value may be significant (Daily 1997). Therefore, not only understanding the actual value of ESs in WPs is of importance; it is also vital to explore the citizens' perceived value.

Previous research has shown that recreation, aesthetics and habitat services are the three most frequently perceived services in WPs in Guangzhou (Zhai and Lange 2020). An online survey during the peak of COVID-19 found that the public generally believes that visiting WP is beneficial to physical and mental health. The benefits for mental health are perceived to be higher than for physical health. In addition, the results emphasise that wildlife habitat services are considered an essential ecosystem service that promotes perceived health benefits (Zhai and Lange 2021).

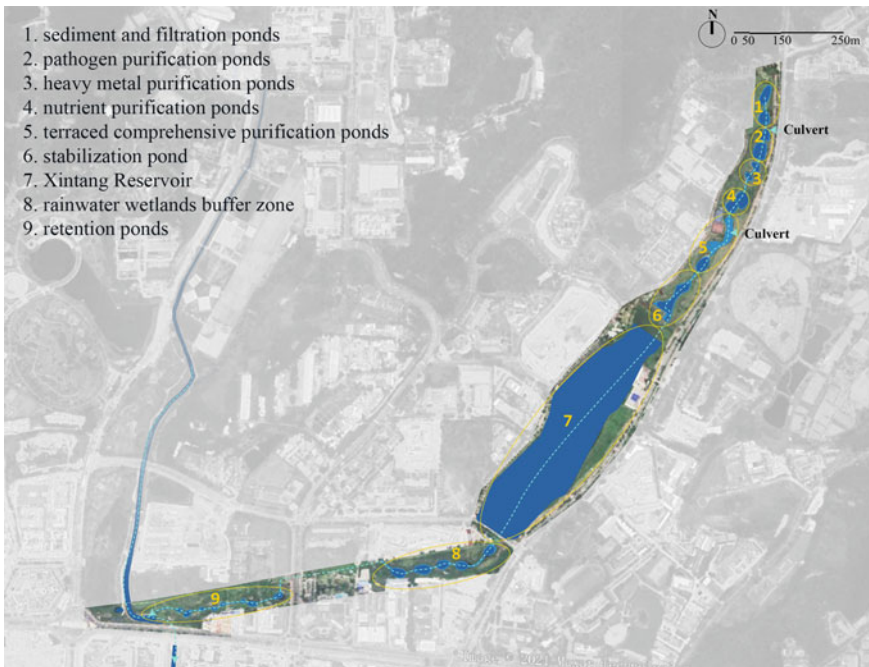
### **15.4.1 The Case of Tianhe Dagan Wetland Park**

Building on these studies, an in-depth survey of public perception on ESs delivered in WPs was conducted, using Tianhe Dagan WP as a case study. Tianhe Dagan WP was built in 2015 and is in the Tianhe District, where many high-tech companies are located. It is a linear park approximately 120 m wide and with a total area of

46.8 hectares. It consists of 23 cascade ponds and a reservoir to collect and purify stormwater. The water flows from north to south and then flows into a river (Fig. 15.2).

Since the perception of the environment is multisensory, a questionnaire and semi-structured interview were conducted on-site to obtain their users' perceptions. Questions were asked about motivations for the visit, overall perception of the WP and the perception of the ESs that the WP delivered. Data was collected between 26 December 2020 and 5 February 2021. The study was approved by The University of Sheffield ethics committee.

Seventy respondents were involved in the questionnaire and 45 took part in the whole interview. This chapter is focussed on the key results from the qualitative data gathered in the interview. There were slightly more female respondents (55.6%) than male-respondents (44.4%). 70% of respondents have a college degree or higher. 68.9% of respondents were younger than 35 years old. Seventy percent of the respondents were visiting this WP for the first time.



**Fig. 15.2** Wetland system of Tianhe Dagan WP (based on signs on-site and Wang 2019; Map Google earth adapted by Xuezhu Zhai)



## **15.4.2 Perceived ESs**

### **15.4.2.1 Flood Regulation and Water Purification**

Although flood regulation and water purification are the primary purposes for creating this WP, no one mentioned the flood regulation service. Only two respondents mentioned water purification services in the interview. Both respondents thought the water purification service is essential. One respondent thought water purification is more important than having more ornamental plants. Another respondent believed the water quality had improved since his last visit, thus allowing his child to play with the water.

As visitors typically avoid times of heavy rain, this pattern might help to explain why flood regulating services are not obvious for the visitors during normal visitation times.

### **15.4.2.2 Air Purification**

Good air quality was the primary motivation of visits for a large proportion of respondents. Most respondents agreed that the air is clean in this WP, and the air quality in this WP is better than in the vicinity with the primary road and its many vehicles. Their judgements were mainly linked to the number of trees, i.e. many trees equating good air quality or sparse woods for poor air quality.

### **15.4.2.3 Wildlife Habitat**

Most respondents agreed that there are abundant and diverse plants in this WP, but nearly half (42.31%) of the respondents had difficulties estimating the number of plants. Around one-third of respondents thought there were less than 100 plant species in this WP, while 11.5% believed there were 101–200 plant species. Only about 10% of respondents thought there were more than 200 species. Compared with a field survey conducted by the authors in October 2020 (144 species, with 58 quadrats) and a study in August 2017 (66 species, with 25 quadrats) (Wang 2019), the estimation by 17% of respondents was close to the actual circumstance.

Most respondents thought that diversity of birdlife in this WP is low. 36.5% of respondents did not pay attention or had difficulties estimating the number of bird species. Respondents who usually pay attention to wild animals found that they only encountered less than five bird species. 40.38% of respondents thought there were less than 20 bird species in this WP; among them, 15 respondents thought there were less than ten bird species. Only two respondents thought there are more than 100 bird species. In reality, 66 species (including 23 common species, which appears in more than 10% of records) have been recorded from April 2020 to May 2021 by citizen scientists. For each visit, on average, ten species were witnessed (ranging from one to

twenty). In general, the bird habitat service was underestimated by the visitors. This might be explained by their visitation period and because most birds in this WP are small and difficult to see (e.g. the long-tailed shrike *Lanius schach*). Some birds are usually “only heard but not seen” (e.g. Asian Kole, *Eudynamis scolopaceus*), and it is difficult for people with a lack of basic knowledge to distinguish some birds. Also, there are bird species that look relatively similar (e.g. little egret (*Egretta garzetta*) and Chinese pond heron (*Ardeola bacchus*)).

#### 15.4.2.4 Aesthetics

When talking about scenic beauty, some respondents mentioned “uniqueness”. Interestingly, several respondents noted that scenery of this WP reminded them of their hometown, so they thought it was beautiful. These stimuli vary from visual to olfactory experiences and from the fallen leaves and fish in the lake to the swamp and ponds.

The cypress forest is regarded as the most attractive place in this WP, especially the cypress forest next to ponds. Because of its attractiveness, many people leave the trail and enter the forest to take pictures (Fig. 15.3 top-left corner), which in turn might negatively impact the habitat. The reservoir, the lake (Fig. 15.3 bottom-right corner and ponds (Fig. 15.3 top-right corner) are also attractive due to the preference of water. A large area of diverse emergent aquatic plants (except water lilies) covering the water surface (Fig. 15.3 bottom-left corner) was considered messy.

#### 15.4.2.5 Recreation

The most common activities visitors perform in this WP were taking walks, sitting and photography. Cat or dog-walking (on-leash), jogging, lying down and resting, bird watching, having picnics and pursuing nature observations were activities that respondents conducted in this WP. None of the respondents picked wild vegetables and fruits. Respondents did at least one activity and up to seven activities in their WP visit. On average, each respondent did three activities per visit in this WP.

Many respondents appreciate this WP as they can get close to nature pursuing activities such as picnics on the grassland, fishing or catching butterflies. While adults were having picnics on the lawn, they were also able to watch their children playing by the ponds.

For most respondents, thermal comfort was the main reason for choosing a place to stay. When there is direct sunlight and temperatures are high in summer, and even on sunny days in winter, respondents prefer to do activities in the shade. Other criteria include quiet locations with few people around, beautiful scenery (especially when there is a possibility to see animals) and a comfortable place for sitting.



**Fig. 15.3** Attractive places in Tianhe Dagan Wetland Park. *Photos Xuezhui Zhai*

#### 15.4.2.6 Environmental Education

Overall, there are 75 signs about environmental education in the north part of this WP (with an area of 10 ha), from knowledge about Sponge City and the water purification of this WP to information on the plants and animal species in this WP. However, respondents mentioned the lack of signs and complained about the complex contents or the mismatch of the content and nearby plants. Several respondents said they did not pay attention to the signage because they are not interested in it, or they have no knowledge or background which would help them to understand it. Environmental education services that do not rely on signage have also been highlighted, mainly by respondents who came with young children.

### 15.5 Conclusions

By exploring the transition and status quo of wetlands and their ecosystem services and the perceived ESs by the public, this study summarises the characteristics of the ecosystem services of WPs in Guangzhou and the problems in the delivery of ecosystem services to propose suggestions for the future planning and design of

WPs. Future research to widen the theoretical basis for WPs in adaptive transformation could be extended to include children and teenagers' perception as well as the seasonal variation in ecosystem services in WPs. Depending on the individual, visitor perceptions of the ESs will vary to some degree. Results indicate that only a few members of the public understood the value of these locations in terms of water and flood management. Yet, from a policy perspective, this is one of the key drivers for WP creation. There is strong potential for signage and other media to help inform about the need and value of such landscapes. In contrast, the public made stronger links with recreation and leisure, and to a moderate degree with the value for wildlife and as a place to attain some relief from poor quality air and noise. Based on anecdotal information, WPs are perceived as being beneficial to health. Further empirical research is required to deliver "hard" facts to inform the public and guide policy makers in future planning.

**Acknowledgements** This work is part of Adaptive Urban Transformation (AUT)—Territorial governance, spatial strategy and urban landscape dynamics in the Pearl River Delta (EP/R024979/1), a collaborative project of Delft University of Technology (TU Delft), South China University of Technology and The University of Sheffield.

## References

- Costanza R, de Groot R, Braat L, Kubiszewski I, Fioramonti L, Sutton P, Farber S, Grasso M (2017) Twenty years of ecosystem services: how far have we come and how far do we still need to go? *Ecosyst Serv* 28:1–16. <https://doi.org/10.1016/j.ecoser.2017.09.008>
- Daily GC (ed) (1997) *Nature's services: societal dependence on natural ecosystems*. Island Press, Washington DC
- Day JW, Agboola J, Chen Z, D'Elia C, Forbes DL, Giosan L, Kemp P, Kuenzer C, Lane RR, Ramachandran R, Syvitski J, Yañez-Arancibia A (2016) Approaches to defining deltaic sustainability in the 21st century. *Estuar Coast Shelf Sci* 183:275–291. <https://doi.org/10.1016/j.ecss.2016.06.018>
- Fan C, Zhong W, Cai Y (2017) 广东海珠湿地自然教育模式解读 (Interpretation of nature education model in Haizhu Wetland in Guangdong). *Wetland Sci Manag* 13:24
- Guangzhou Statistics Bureau (2021) 广州市第七次全国人口普查公报 (Bulletin of the 7th national census of Guangzhou). 广州日报 (Guangzhou Daily) A9
- Hehl-Lange S, Lange E (2019) The big picture: landscape Dynamics in the Pearl river delta. *Landscape Archit* 26(9):23–30
- Huang Y, Mao J, Zhan H, Wu H, Liang L, Wu Y (2018) 广州海珠国家湿地公园植物资源研究 (Plant resources of Haizhu national Wetland Park, Guangzhou). *For Environ Sci* 34:81–85
- Joint Action Platform of Chinese Bird Watching Organization (2021) Chinese Bird Report. <http://www.birdreport.cn/>. Accessed 7 June 2021
- Li J (1983) 广州地区古海岸线的变迁 (The evolution of the ancient Guangzhou coastal line). *Ocean Sci* 14–17
- Li Z, Tan Y, Qiu Q (2018) 广州四大人工湖公园的特色营造及其变迁研究 (The study of the characteristic constructions and changes of four artificial lakes in Guangzhou). *广东园林 (Guangdong Landscape Archit)* 40(01):27–33
- Liu K (2016) 珠江三角洲桑基鱼塘景观遗产研究. Master's Thesis

- Liu D (2019a) 广州国家湿地公园生态系统服务功能评估 (Estimation of ESs of Haizhou national Wetland Park in Guangzhou). Master's Thesis, Guangzhou University
- Liu D, Huang Y, Zhu W, Chan X (2019b) TCIA法在湿地公园休憩旅游价值评估中的应用——以广州海珠国家湿地公园为例 (Application of TCIA method in the evaluation of resting tourism value in wetland parks—take Guangzhou Haizhu national Wetland park as an example). 环境与发展 (Environ Dev) 31:179–183
- Luo M (2019) 【鹭】广州野鸟观测及保护公益计划--6月份月报出炉 (Heron: Guangzhou wild bird observation and conservation public welfare plan--June report released). <https://mp.weixin.qq.com/s?src=11&timestamp=1623129486&ver=3117&signature=b88AwYLyWTWniVzjVHXPFgQoEDKWpaTne4IUTkknQvHr2Pkg4D14BtdU0cmRhIp0-GBdipTeNKrmq7vd65l-7HgfgOgFPVRTuZ4suoafbrlxKgr54Bxvckes1mxo0tP&new=1>. Accessed 8 June 2021
- Ma G (2016) 中国湿地公园建设. 中国林业出版社 (China Forestry Publishing House), Beijing
- Millennium Ecosystem Assessment (2003) Ecosystems and human well-being: a framework for assessment. Island Press, Washington DC
- People's Political Consultative Committee of Haizhu District (2013) 走近海珠湖——海珠湖建设侧记. (1st edn). South China University of Technology Press, Guangzhou
- U.S. Army Map Service (1954) China AMS topographic maps
- Wang L, Xu S, Lin H, Wu S (2019) 城市湿地公园建成后综合绩效评估: 以广州大观湿地为例 (Comprehensive performance evaluation after completion of the urban wetland park: case study of the Daguan wetland park in Guangzhou City). Acta Ecologica Sinica 39
- Wu X (2013) 城市公园修建性详细规划修编的探讨——以广州市东山湖公园为例 (Discussion on detailed planning revision of urban parkstaking). Guangdong Landscape Archit 35:23–26
- Wu A, Lin G (2018) 城市公园使用者的场所依恋影响因素探索——以广州市流花湖公园与珠江公园为例 (Exploratory research on predictors of users' place attachment to urban park—a case study of Liuhua Lake park and the Pearl river park in Guangzhou). Chinese Landscape Archit 34
- Xie H, Guo C (2018) 广州海珠湿地生态系统服务价值评估 (Evaluation of Haizhu Wetland ecosystem service value in Guangzhou). 热带地貌 (Trop Geomorphol) 39:26–33
- Zhai X, Lange E (2020) Using social media to explore perceptions of ecosystem services by nature-based solution projects. Landscape Archit Front 8:58. <https://doi.org/10.15302/J-LAF-1-020030>
- Zhai X, Lange E (2021) The influence of Covid-19 on perceived health effects of wetland parks in China. Wetlands 41(8):101. <https://doi.org/10.1007/s13157-021-01505-7>
- Zhang Y, Liu W, Guo J, Gao L, Fan S (2012) 城市湿地生态系统保护的现状与思考 (Situation and thoughts on ecological system protection of urban wetland). Environ Sci Manag 37:162–175
- Zhang X, Huang S (2015) 广州市荔湾湖公园活动设施使用问题及对策研究 (Current problems and strategies in activity facilities application in Guangzhou Liwan Lake Park). Guangdong Landscape Archit
- Zhao H, Wang X, Cai Y, Liu W (2016) Wetland transitions and protection under rapid urban expansion: a case study of Pearl river estuary, China. Sustainability 8:471. <https://doi.org/10.3390/su8050471>

**Open Access** This chapter is licensed under the terms of the Creative Commons Attribution-NonCommercial 4.0 International License (<http://creativecommons.org/licenses/by-nc/4.0/>), which permits any noncommercial use, sharing, adaptation, distribution and reproduction in any medium or format, as long as you give appropriate credit to the original author(s) and the source, provide a link to the Creative Commons license and indicate if changes were made.

The images or other third party material in this chapter are included in the chapter's Creative Commons license, unless indicated otherwise in a credit line to the material. If material is not included in the chapter's Creative Commons license and your intended use is not permitted by statutory regulation or exceeds the permitted use, you will need to obtain permission directly from the copyright holder.



# Chapter 16

## Community Supported Agriculture in the Pearl River Delta



Ziyi Liu, Nicola Dempsey, and Eckart Lange

**Abstract** While community supported agriculture (CSA) is becoming an increasingly popular form of agriculture in some parts of China, there is limited understanding about the barriers of promoting and developing CSA in a local food system. There is little published evidence about attitudes towards CSA and how public opinion influences the demand for, and the development of, CSA in the Pearl River Delta. This chapter aims to investigate CSA by considering a range of factors such as spatial distribution and customer perception to explore how CSA contributes to the local food system and reducing concerns about food safety in China. By focussing on different factors of development of CSA farming, this chapter will investigate the role of CSA farms in the local food system in the Pearl River Delta. The chapter will identify current socio-economic and environmental catalysts and barriers for CSA farming and explore the developing opportunities for this emerging type of urban agriculture in the Pearl River Delta.

**Keywords** Food system · Ecological farming · Community supported agriculture · Peri-urban landscape planning

### 16.1 Introduction

In recent years, due to the rapid growth of its population and economy, China's food production and consumption has increased significantly. A fundamental transformation is taking place with the development of modern agriculture to address issues ranging from food sufficiency crises to food safety scandals in the food system (Si et al. 2015). Within this transformation, the question of how to not only ensure

---

Z. Liu (✉) · N. Dempsey · E. Lange  
Department of Landscape Architecture, The University of Sheffield, Sheffield S10 2TN, UK  
e-mail: [zliu117@sheffield.ac.uk](mailto:zliu117@sheffield.ac.uk)

N. Dempsey  
e-mail: [N.Dempsey@sheffield.ac.uk](mailto:N.Dempsey@sheffield.ac.uk)

E. Lange  
e-mail: [e.lange@sheffield.ac.uk](mailto:e.lange@sheffield.ac.uk)

food safety, but also to protect small farms has become a key topic for experts and scholars (Tang et al. 2019). Some Chinese food activists believe that community supported agriculture (CSA) is an important approach to help address the increasing food concerns in China and provide support for the small farms (Li 2019).

Community supported agriculture (CSA) is an alternative food network (AFN) system which connects producers and consumers more directly than traditional agriculture (Galt et al. 2016). The original CSA model was called *Teikei* and emerged from Japan in the 1960s (Tegtmeier and Duffy 2005). It was a response to the occurrence of Minamata disease caused by severe mercury poisoning, as well as a perceived imbalance between Japanese and foreign agriculture trade, which led to the urgent demand for Japanese people to access healthy and safe food (Tang et al. 2019). It was then introduced in the United States in the 1980s (Paul 2019), where the term CSA was coined and evolved (Araz 2020).

As CSA has been developed to meet a public preference for healthy and ecological agriculture products, there is a strong social connection based on the trust mechanism between producer and consumer (Tang et al. 2019). CSA members pay an up-front fee to support the farmers to access operating capital before the growing season and to ensure that farmers focus on ecological farming practices without having to be focussed on making profits. In return, members receive healthy and fresh produce at frequent intervals during harvest time. Through this mode of operation, consumers and producers share the agricultural risks and rewards and can forge a long-term relationship of mutual trust and exchange.

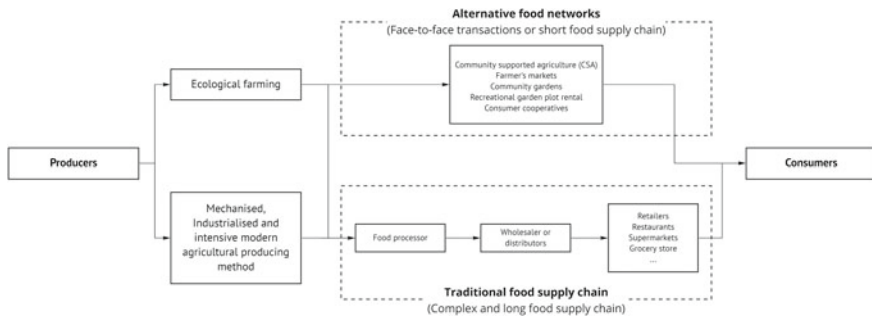
As one of the most productive areas in China, the Pearl River Delta has natural, cultural, economic, political and geographic advantages in relation to agriculture. Currently, the development of CSA farms in the Pearl River Delta area is still in its infancy (Tang et al. 2019). Compared to other first- and second-tier cities in China, there are fewer CSA farms set up in the Pearl River Delta region.

This chapter reviews current literature to provide an analysis of CSA as an ecological agriculture production mode with focus on the development status, catalysts and barriers to CSA farms in the Pearl River Delta. It further identifies the knowledge gaps and proposes insights into potential routes for CSA farm development in the Pearl River Delta. The chapter concludes by providing reference points for future in-depth research into the development of ecological agriculture in this region.

## 16.2 CSA as Ecological Farming

Over the last few decades, the significant effects of rapid globalisation have led to a series of impacts on agriculture. China is currently in a period of transition from traditional smallholder production to mechanised, industrialised and intensive modern agricultural production. The current process of agricultural transformation, due to the effects of climate change, the low efficiency of mechanisation and the lack of labour, makes excessive use of fertilisers and pesticides in the production process to ensure maximum production and revenue (Chen and Wang 2019). Consequently,





**Fig. 16.1** Traditional food supply chain and alternative food networks schematic *Image* Ziyi Liu

pollution of the environment has become one of the greatest barriers to people's access to healthy and safe food (Krul and Ho 2017). In response, domestic agricultural institutions and academia are focussing their attention on alternative food networks (AFNs) (see Fig. 16.1), which can play an important role in guaranteeing food safety, protecting the environment and developing rural and peri-urban areas (Tang et al. 2019). The types of AFNs in China include community supported agriculture (CSA), farmers' markets, community gardens, recreational garden plot rental and consumer cooperatives (Si et al. 2015; Tang et al. 2019). Of these, CSA is the most well-known model and has developed significantly over the last decade in China.

The concept of CSA in China was introduced with the main motivation being food safety (Yan et al. 2011; Scott et al. 2014) rather than improving the environment or supporting local farmers (Cox et al. 2008; Peterson et al. 2015). CSA is believed to guarantee the livelihood of the producers, provide high-quality food for the local community, establish a collaborative consumer-producer relationship of mutual trust, and to address the issue of a lack of transparency, sustainability and resilience in the food system (Community Supported Agriculture 2015). It can also provide a fair platform for both the farmer and the urban consumer in the development of local production for local consumption (Partnerships for Community Development 2013).

CSA has a relatively short history in China with the Little Donkey Citizen Farm believed to be the first CSA farm in China, which was founded in Beijing in 2009. CSA has characteristics which distinguish it from traditional agriculture regarding its distribution, operators, customer perception, scale, trade principles and certification process, some of which are discussed later in the chapter.

Krul and Ho (2017) explored the demographics of the farmers in a survey of fifteen CSA farms in China. Their research showed that about two thirds of interviewees described themselves as a 'new' farmer that can be described as young and well-educated urban citizens. The characteristics of participants who showed a high level of interest in this form were as follows: well-educated, living in the urban centre and from the middle or upper class; women also make up a high proportion of these farmers (Zheng et al. 2017). Most new farmers started their CSA farm on a small area of land, less than two hectares, where they prefer to adopt polyculture rather than monoculture practices (China CSA Alliance and SMART 2019). CSA farms

follow the ‘local producing and marketing’ model (Tang et al. 2019), which can also be reflected in the distribution of CSA farms in China.

CSA farms in China are mainly located in peri-urban areas around first- and second-tier cities such as Beijing, Shanghai and Fuzhou, normally within a radius of 30–50 kms from the city centre (for first-tier cities, this radius extends to 100 kms) (China CSA Alliance and SMART 2019). The location of CSA farms emphasises that the Chinese peri-urban agriculture landscape not only serves urban markets but—as the chapter will discuss later—also supports urban residents as agricultural tourists (Shao et al. 2012).

## 16.3 CSA in the Pearl River Delta

Compared to other first- and second-tier cities in China, there are fewer CSA farms in the Pearl River Delta region. According to the data from Yogevee (有机会), a domestic social media platform promoting organic food and sustainable lifestyle, and map of CSA network published by the China CSA Alliance, for first-tier cities in China, there are 56 CSA farms in Beijing and 21 in Shanghai. In the second-tier cities of Chengdu and Fuzhou there are 32 and 15 CSA farms, respectively.

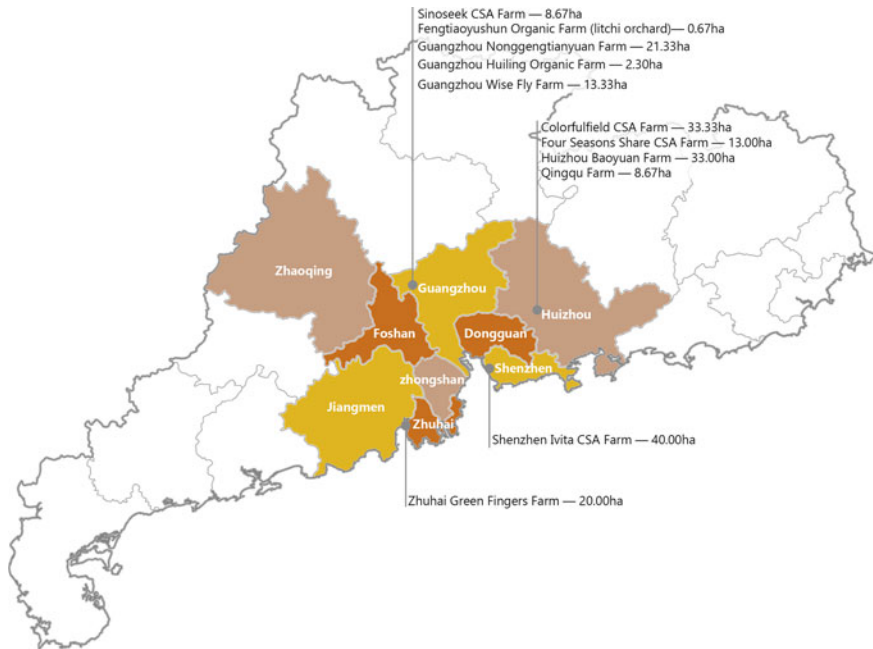
According to Yogevee and China CSA Alliance, currently, in the Pearl River Delta there are only 11 CSA farms (Fig. 16.2). Most of the farms are located in Guangzhou, with another four in Huizhou, whilst in Shenzhen and Zhuhai, there is one farm each. Most farms are operating at mid- to large-scale with sites ranging from 8.67 ha to 40 ha.

In terms of natural resources, location, economy, history of sustainable agriculture and marketing (Yu 2008; Zeng 2011) the Pearl River Delta has strong potential to develop ecological agriculture. However, there is limited understanding of why there is a rather low number of CSA farms in this region (Fig. 16.3). There is also little literature discussing the potential catalysts for, and barriers to, developing CSA, especially small-scale CSA farms, in the Pearl River Delta. The potential catalysts are discussed in the next section.

## 16.4 Catalysts for Developing CSA Ecological Agriculture in the Pearl River Delta

### 16.4.1 *A Favourable Environment for Farming*

As one of the most productive areas in China, the Pearl River Delta has a natural advantage in terms of ecological agriculture development. The Pearl River Delta is one of the largest flat regions in Guangdong Province, China. This has a long history of ongoing farming practices which trace back to ancient times (Yang et al. 2012).



**Fig. 16.2** Distribution of CSA farms in Pearl river delta. *Image* Ziyi Liu

**Fig. 16.3** CSA farmers removing weeds manually with hoes. *Photo* Ziyi Liu



The region has a subtropical marine monsoon climate, which results in a year-long warm and moist environment. Annual mean temperatures in this area are between 21 and 23 °C and average annual precipitation is over 1500 mm (Wang 2010). The favourable climate, combined with fertile soil and abundant river water is conducive to farming activities in the Pearl River Delta throughout the year (Lo and Pannell 2013).

### ***16.4.2 Ecological Farming and Culture Heritage***

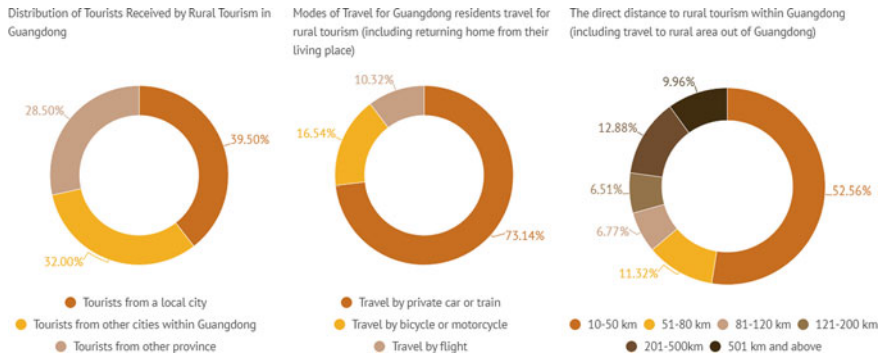
Ancient ecological farming practices have been pursued in this region for a long time. It is believed that the use of the dyke-pond system in the Pearl River Delta can be traced back to the Ming dynasty Wanli period (AD 1573–1620) (Wu 2011). Local farmers grow plants on the dykes which are used, along with agricultural waste, to feed fish and shrimp in the ponds. The pond water and sludge (mud) in turn fertilise and irrigate the plants. The dyke-pond system is based on cultural wisdom which contributes to this sustainable form of agriculture, which has been developed alongside other local traditional farming practices and represents producers' understanding of the characteristics of harmonious structure, benign circulation and effectiveness (Li et al. 2021).

### ***16.4.3 Economic Demand***

The Pearl River Delta economic zone is one of China's main economic zones and manufacturing centres. The region's rapid economic growth has laid the foundation for the development of ecological agriculture. According to the Statistical Yearbook of Guangdong Province (Guangdong Bureau of Statistics 2020), in 2020, Guangdong Province will achieve a regional GDP of 110.76 billion yuan (equivalent to 15.36 billion euros, as of 2022), an increase of 2.3% on the previous year. The GDP of the core areas of the Pearl River Delta accounts for 80.8% of that of the province. In 2020, the added value of the primary industry was 476.99 billion yuan, marking a yearly increase of 3.8%. The annual per capita disposable income of residents in the province was 41,029 yuan, a yearly increase of 5.2%; the per capita disposable income of urban residents was 50,257 yuan, a yearly increase of 4.4%. The Engel coefficient represents the proportion of family income that is spent on food. The United Nations (UN) use it as an indicator to show the standards of living: an Engel coefficient between 30 and 40% represents a good standard of living. The Engel coefficient for residents in Guangdong province is 33.8% and the Engel coefficient of urban residents is 32.2%. With the growth of urban residents' income, people's demand for high-quality, healthy and pollution-free agricultural products is increasing. The CSA mode can potentially contribute to meeting this change in demand while helping improve the agricultural industry in terms of its long-term ecological sustainability.

### ***16.4.4 Infrastructure for Tourism***

The Pearl River Delta has become one of the most developed areas in China, providing convenient transportation for people who wish to visit the rural agricultural landscape,



**Fig. 16.4** Guangdong rural tourism big data analysis report. *Source* the department of culture and tourism of Guangdong province

and it also meets local demand for agricultural products in the urban area (Wang 2010). As the income of urban residents increases, their lifestyles and leisure activities are gradually changing. Urban residents are eager to experience rural landscapes that are different from metropolitan life and can contribute to their quality of life (Chen 2005). According to the Guangdong Rural Tourism Big Data Analysis Report (Department of Culture and Tourism of Guangdong Province 2018) (Fig. 16.4), in the first half of 2018, Guangdong’s rural area received 337 million tourists. Among them, 39.5% came from the nearby local city. Figure 16.4 shows how access to rural tourism in Guangdong Province mainly relies on private transport and highways and that this tourism mainly takes place over a short distance. The average distance that over half of the tourists travel is between 10 and 50 kms. The data not only shows the interest of Guangdong residents in rural landscape and lifestyles, but also suggests that there are opportunities for the potential of urban agriculture in the outskirts of their city. A highway network with Guangzhou, as the centre in the Pearl River Delta, is currently being built to meet people’s travel needs (Wang 2010). Given the location of CSA farms in the peri-urban area, there is clearly potential to promote CSA farms to the Pearl River Delta’s urban residents.

### 16.4.5 Policy-Driven Technological Developments

Agricultural technology is an important driver for the development of sustainable ecological agriculture. In 2019, the Guangdong government proposed building a modern agricultural technology and equipment system and promoting high-tech agricultural production methods as one of the five major goals for accelerating the transformation of the agricultural industry and improving the level of modern agriculture in the Pearl River Delta. The Leading Group of the Guangdong Provincial Committee (2020) for the Implementation of the Rural Revitalization Strategy formulated the Guidance on Promoting the High-quality Development of Modern Agriculture on the

basis of the Guangdong Province Quality Agriculture Strategic Plan (2018–2022). The document emphasises the strengthening of the process management of agricultural production safety and proposes establishing and improving the environmental protection and governance system of the production area, setting up an agricultural green cycle low-carbon production system, strengthening the supervision of the quality and safety of agricultural products, and promoting agricultural brands.

Guangdong's investment in agricultural science and technology innovation has laid the foundation for the development of ecological agriculture (Liu et al. 2017). According to a government report (The State Council of the People's Republic of China 2016), agricultural scientific and technological progress in Guangdong Province was ranked second in (mainland) China in 2016. Excluding forestry, scientific and technological achievements, the agricultural industry has won a total of 174 national and provincial scientific and technological progress awards, 82 technological awards from the Ministry of Agriculture, and 1056 provincial agricultural technology promotion awards. However, it is not yet clear how agricultural technological advances can be applied to ecological farming at a variety of scales to potentially reduce the cost and improve production and promote CSA to a wider consumer group, including the lower-income class.

## 16.5 Barriers to CSA

Since 1978, due to reform and opening-up, the Pearl River Delta has moved from a region dominated by agriculture, through rural and urban industrialisation, to a new stage characterised by metropolitanisation and urban agglomeration (Zhou et al. 2019). While these changes have stimulated rapid economic growth; they have also led to negative impacts including pressure on land and changing population structure as this section outlines.

### 16.5.1 *Pressure on Land Resources*

In the early stages of the reform and opening-up, the Pearl River Delta region relied on special policies and its proximity to Hong Kong and Macau to attract foreign investment and encourage private enterprises with cheap land and labour. Policies at the time were conducive to promoting Pearl River Delta's rapid economy growth and urbanisation. This process also led to an increase in developed land and a decrease in arable land, which Zhou et al. (2019) describe as resulting in inefficient land use in the Pearl River Delta.

According to a report on the Integrated Planning of the Ecological Security System in the Pearl River Delta issued by the Guangdong Government (2014), between 1988 and 2010, development land expanded from 1765.30 to 8790.21 km<sup>2</sup>, increasing more than four times and removing a large amount of cultivated land, forest land and

water areas. From 2003 to 2008, the arable land in the Pearl River Delta decreased by 123,000 ha, and the per capita arable land area in the whole region was only 0.032 ha. This is equivalent to one third of the national average and less than the United Nations guidelines which cite an absolute minimum of 0.053 ha. The scarcity of arable land has thus exacerbated the conflict between urban expansion and agricultural development (Zeng 2012).

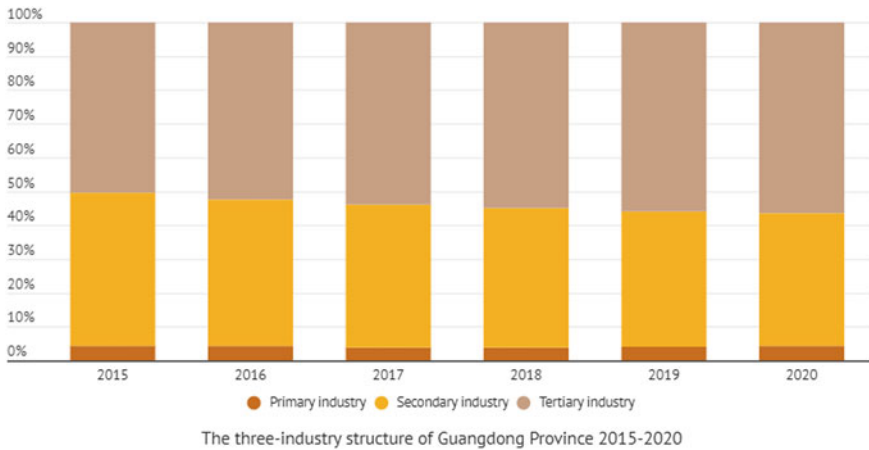
### ***16.5.2 The Workforce Shifting of the Rural Population in the Pearl River Delta***

In addition to cheap land, cheap labour was also an important condition for the development of the early processing and manufacturing industries in the Pearl River Delta (Zhou et al. 2019). With increased employment opportunities as a result of the reform and opening up, and increased production efficiencies in traditional agricultural practices in the Pearl River Delta, the rural labour gradually moved to the secondary and tertiary industries to engage in non-agricultural activities (Jiang 2014). Between 1980 and 1990, 2.7 million people in the local villages of the Pearl River Delta were engaged in non-agricultural activities. By the end of 2006, more than half of that rural labour had shifted to the secondary industries (Jiang 2014) such as manufacturing industries in textiles, electronic and communication products and chemical raw materials (Zhou et al. 2019).

However, it should be noted that the workforce transfer *of farmers* in the Pearl River Delta is not accompanied by signs of large number of rural labourers moving to cities. The workforce transfer from rural areas in the Pearl River Delta mainly took the form of transferring to non-agricultural activities in local areas, thereby manifesting in the industrial structural transfer of agricultural labour, rather than migration to the urbanised areas (Xu and Wei 2012).

The three-industry structure (Fig. 16.5) of Guangdong Province from 2017 to 2020 shows that the proportion of the primary industry in the regional GDP has held mostly constant since 2015. Compared with the inherent uncertainty of agriculture for rural labour, the potential financial opportunities for rural workers who choose to engage in the secondary and tertiary industries are better than those who engage in agricultural production. Therefore, as the Pearl River Delta is dominated by the secondary and tertiary industries, the cost of rural labour is higher than in the surrounding areas (Wang 2010).

Limited arable land resources and the high price of labour in agricultural production are two main dilemmas faced by CSA farms in the Pearl River Delta. Unlike other types of ecological farms that sell their produce through orders, the advance payment in the form of shares in CSA is done by participants to help producers to cover the anticipated cost. Although the CSA model theoretically guarantees profits



**Fig. 16.5** The three-industry structure of Guangdong province 2015–2020. *Source* Guangdong bureau of statistics

to the farm, the current ecological planting method followed by CSA requires significant labour, which makes it difficult for domestic CSA farms to manage their costs, particularly where there is a shortage of agricultural labour in the Pearl River Delta.

There is also another barrier for CSA to involve the wider consumer group, including low-income group. According to the China Community Supported Agriculture Network Annual Report (China CSA Alliance and SMART 2019), CSA members pay farms for their products on a monthly basis. On average, 42% of farm members spend less than 500 yuan (around 65 euros) per month, 39% of farm members spend 500–1000 yuan (between 65 and 130 euros) and only 19% of farm members spend more than 1000 yuan (around 130 euros). Moreover, it has been noted that the high expense of certification may result in no profit for CSA farmers (Connolly and Klaiber 2014). Therefore, some CSA farms choose a type of third-party certification, such as participatory guarantee systems (PGS), or they may rely on their own reputation among local networks to ensure consumer trust and cut costs (Du et al. 2012).

## 16.6 Discussion and Outlook

CSA reflects global issues such as sustainable development, food safety and enhanced community cohesion in the context of globalisation (Zhu 2018). While this chapter has outlined the catalysts and barriers to developing ecological farming in the Pearl River Delta, there remains a limited understanding of CSA farming in this region of China.

The current domestic research mainly focuses on people's willingness to participate in CSA and analysing consumer characteristics. However, this has only been



carried out in a few Chinese cities, such as Beijing (Li et al. 2015) and Nanjing (Zhao 2012). There is limited understanding of the willingness of urban residents to participate in CSA and willingness to pay for CSA-produced food in the Pearl River Delta. Researchers have analysed why CSA is conducive to building consumer trust in food (Meyer et al. 2012), and the factors that affect trust (Zhu 2018; Fu 2017); however, the literature exploring how trust is established between CSA producers and consumers is in its infancy (Tan and Chen 2018; Chen 2013). There is therefore a need to understand how the concept of building mutual trust, which is critical to the development of CSA, is manifested in the Pearl River Delta. Trust is believed to be dynamic and continuous (Zahedi and Song 2008). The relationship between initial trust and ongoing trust, as well as the time and methods required to establish this, and whether it is applicable to CSA farms of all scales in the Pearl River Delta, still requires research and investigation.

Research shows that, compared with other types of urban agriculture, such as pick-your-own (PYO) farms, CSA tends to be more resilient in terms of operation. The income of PYO farms depends on the peak visitor flow during harvest season. In 2019, when the coronavirus pandemic restricted people's travel, the disadvantages of PYO farms were therefore revealed. According to a survey with 67 domestic new farmers presented at the China CSA conference (2021), during the pandemic more than half of new CSA farmers confirmed that their farm sales had increased. The strengths of the short supply chain were thus reflected, and the relationship between consumers and producers became closer. To what extent this also happens in the Pearl River Delta will need to be explored in future research.

This chapter has provided an overview of how the CSA model can affect rural economic activities, healthy environments and land use in the sustainable development of rural and peri-urban landscapes in the Pearl River Delta. There is strong potential for the CSA farm sector in the Pearl River Delta to increase. CSA farms need to be studied systematically and require a comprehensive analysis of the perspectives of consumers, producers and the government, which is the subject of ongoing research by the authors.

## References

- Araz OM (2020) Community-supported agriculture: systems thinking in action. *Am J Public Health* (1971) 110(1):19–21. <https://doi.org/10.2105/AJPH.2019.305463>
- Chen W (2005) Continued development study of urban agriculture tourism and the rban—take Guangzhou as an example. *Econ Geogr* 25(6):915–919
- Chen W (2013) Producers' strategies for building consumer food trust under the context of community supported agriculture 社区支持农业情境下生产者建立消费者食品信任的策略—以四川安龙村高家农户为例. *Chin Rural Econ* 2013(2):48–60
- Chen Y, Wang J (2019) The obstacles and countermeasures of the transformation from traditional agriculture to modern agriculture in China 我国传统农业向现代农业转变的障碍及对策. *Theor Obs* 2019(11):82–84
- China CSA Alliance and SMART (2019) 2019 China community supported agriculture network annual report, p 29

- Community supported agriculture (2015) What is CSA? [Communitysupportedagriculture.org.uk. <https://communitysupportedagriculture.org.uk/what-is-csa/>](http://communitysupportedagriculture.org.uk/what-is-csa/). Accessed 7 June 2020
- Connolly C, Klaiber HA (2014) Does organic command a premium when the food is already local? *Am J Agr Econ* 96(4):1102–1116. <https://doi.org/10.1093/ajae/aa030>
- Cox R et al (2008) Common ground? Motivations for participation in a community-supported agriculture scheme. *Local Environ* 13(3):203–218. <https://doi.org/10.1080/13549830701669153>
- Department of Culture and Tourism of Guangdong Province (2018) Guangdong rural tourism big data analysis report. The Department of culture and tourism of Guangdong province. [http://whly.gd.gov.cn/news\\_newzwhd/content/post\\_2802360.html](http://whly.gd.gov.cn/news_newzwhd/content/post_2802360.html). Accessed 1 July 2021
- Du S, Cai J, Guo H, Fan Z (2012) Food security-oriented urban agriculture development typologies: a case study of vegetable production in peri-urban Beijing 食品安全导向下的都市农业发展模式—以北京蔬菜生产为例. *Prog Geogr* 31(6):783–791
- Fu H (2017) Trust problems in production and marketing interaction of community supported agriculture: based on trust game theory framework. *J Southwest Univ Polit Sci Law* 19(5):95–103
- Galt RE et al (2016) Eroding the community in community supported agriculture (CSA): competition's effects in alternative food networks in California. *Sociol Rural* 56(4):491–512. <https://doi.org/10.1111/soru.12102>
- Guangdong Bureau of Statistics (2020) Statistical yearbook of Guangdong province 2020. Guangdong statistics information Website. [http://stats.gd.gov.cn/gdtjnj/content/post\\_3098041.html](http://stats.gd.gov.cn/gdtjnj/content/post_3098041.html). Accessed 1 July 2021
- Guangdong Government (2014) Integrated planning of the ecological security system in the Pearl river delta. [http://www.gd.gov.cn/gkmlpt/content/0/143/post\\_143525.html#7](http://www.gd.gov.cn/gkmlpt/content/0/143/post_143525.html#7). Accessed 1 July 2021
- Jiang L (2014) Rural-urban relationship characteristics of Pearl river delta research based on rural-urban interaction. Master's Thesis, pp 60–63
- Krul K, Ho P (2017) Alternative approaches to food: community supported agriculture in urban China. *Sustain (Switz)* 9(5). <https://doi.org/10.3390/su9050844>
- Leading Group of the Guangdong Provincial Committee (2020) Guidance on promoting the high-quality development of modern agriculture. Department of agriculture and rural affairs of Guangdong province. [http://dara.gd.gov.cn/nyyw/content/post\\_2794189.html](http://dara.gd.gov.cn/nyyw/content/post_2794189.html). Accessed 1 July 2021
- Li L (2019) Research on the development mechanism of community-supported agriculture under the background of rural vitalization strategy. *Spec Zone Econ* 371(12):132–135
- Li H et al (2021) Land-use modes of the dike-pond system in the pearl river delta of china and implications for rural revitalization. *Land* 10(5):1–21. <https://doi.org/10.3390/land10050455>
- Li M, Zhang Y, Wu B (2015) A study on REM model of experiential tourism products development in allotment farm garden: a case study of Beijing Little Donkey farm. *J Cent S Univ For Technol* 35(12):143–146
- Liu Y, Liu X, Zhou C, Li X, Lei B, Yu H, Cao Y (2017) Study on development status and countermeasures of agricultural science and technology in Guangdong. *Hubei Agric Sci* 56(2):393–396
- Lo C-P, Pannell CW (2013) Seasonal agricultural land use patterns in China's Pearl river delta from multi-date landsat images<sup>†</sup>. *J Chem Inf Model* 53(9):1689–1699
- Meyer SB et al (2012) Reconnecting Australian consumers and producers: Identifying problems of distrust. *Food Policy* 37(6):634–640. <https://doi.org/10.1016/j.foodpol.2012.07.005>
- Partnerships for community development 社区伙伴 (2013) Preface, definition, concept and background. <http://pcd.org.hk/csa/eng/aboutus01.html>. Accessed 1 July 2021
- Paul M (2019) Community-supported agriculture in the United States: social, ecological, and economic benefits to farming. *J Agrar Chang* 19(1):162–180. <https://doi.org/10.1111/joac.12280>
- Peterson HH, Taylor MR, Baudouin Q (2015) Preferences of locavores favoring community supported agriculture in the United States and France. *Ecol Econ* 119:64–73. <https://doi.org/10.1016/j.ecolecon.2015.07.013>

- Scott S et al (2014) Contradictions in state- and civil society-driven developments in China's ecological agriculture sector. *Food Policy* 45:158–166. <https://doi.org/10.1016/j.foodpol.2013.08.002>
- Shao J, Zhang Y, Li X, Li Z (2012) Study on the Recreational Mode of Community-Supported Agriculture Type Urban Farms 社区支持农业型市民农园休闲模式研究. *Tourism Tribune* 2012(12):74–79
- Si Z, Schumilas T, Scott S (2015) Characterizing alternative food networks in China. *Agric Hum Values* 32(2):299–313. <https://doi.org/10.1007/s10460-014-9530-6>
- Tan S, Chen W (2018) How to build consumers' trust in community supported agriculture—the case of four seasons share organic farm in Huizhou, Guangdong Province. *China Agric Univ J Soc Sci Ed* 35(4):103–114
- Tang H, Liu Y, Huang G (2019) Current status and development strategy for community-supported agriculture (CSA) in China. *Sustain (switz)* 11(11):1–15. <https://doi.org/10.3390/su11113008>
- Tegtmeier EM, Duffy M (2005) Community supported agriculture (CSA) in the midwest United States: a regional characterization part of the agriculture commons, and the international and community nutrition. Leopold center pubs and papers: Leopold center for sustainable agriculture 1–2005. [http://lib.dr.iastate.edu/leopold\\_pubspapers](http://lib.dr.iastate.edu/leopold_pubspapers)
- The State Council of the People's Republic of China (2016) The contribution rate of agricultural science and technology progress in Guangdong ranks second in the country. The State Council of the People's Republic of China. [http://www.gov.cn/xinwen/2016-11/19/content\\_5134545.htm](http://www.gov.cn/xinwen/2016-11/19/content_5134545.htm). Accessed 1 July 2021
- Wang C (2010) Tows matrix analysis on developing urban agriculture in the Pearl river delta area. *Asian Agric Res* 2(9):21–24
- Wu J (2011) Land-pool farming and economic restructuring in Shunde County during the times of Ming, Qing dynasties and the Republic of China. *Ancient Mod Agric* 2011(1):96–104
- Xu S, Wei L (2012) Reconsideration of village plan for Pearl river delta region in the context of social transformation—a case study of Guangzhou Zengcheng events. *Urban Planning Forum* 2012(4):65–72
- Yan S et al (2011) Safe food, green food, good food: Chinese community supported agriculture and the rising middle class. *Int J Agric Sustain* 9(4):551. <http://ecu.summon.serialssolutions.com/link/0/eLvHCXMwQ7QykesDY8LlgZE5aLTOArwBFjGijlTYu4kyyLm5hjh76MIKzfiUnJx4YI1ubGpmaWpiaMj3zZwz-32Lz75eiWyu59Z17QCTYipF>
- Yang S et al (2012) Modern pollen assemblages from cultivated rice fields and rice pollen morphology: application to a study of ancient land use and agriculture in the Pearl river delta, China. *Holocene* 22(12):1393–1404. <https://doi.org/10.1177/0959683612449761>
- Yu G (2008) Discussion on the development strategy of urban agriculture in Guangzhou 广州市都市农业发展对策探讨. *Agric Econ* 2008(12):26–28
- Zahedi F, Song J (2008) Dynamics of trust revision: using health infomediaries. *J Manag Inf Syst* 24(4):225–248. <https://doi.org/10.2753/MIS0742-122240409>
- Zeng Y (2011) Enlightenment to Guangzhou from the international experience of urban agriculture development. *Rural Econ Sci* 22(06):100–102
- Zeng Y (2012) Situation and sustainable development of modern urban agriculture in Guangzhou. *Res Agric Modernization* 33(3):304–308
- Zhao M (n.d.) Research on the citizen's willingness and factors influencing public participation in the CSA—based on research in Nanjing. Master'S Thesis, pp 32–47
- Zheng X, Dong H, Fang X (2017) Research on consumers' participation willingness of community supporting agriculture. *Econ Manage* 31(4):33–38
- Zhou C, Wang Y, Xu Q, Li S (2019) The new process of urbanization in the Pearl river delta. *Geogr Res* 38(1):45–63
- Zhu M (2018) Research progress of community supported agriculture. *World Reg Stud* 27(2):106–117

**Open Access** This chapter is licensed under the terms of the Creative Commons Attribution-NonCommercial 4.0 International License (<http://creativecommons.org/licenses/by-nc/4.0/>), which permits any noncommercial use, sharing, adaptation, distribution and reproduction in any medium or format, as long as you give appropriate credit to the original author(s) and the source, provide a link to the Creative Commons license and indicate if changes were made.

The images or other third party material in this chapter are included in the chapter’s Creative Commons license, unless indicated otherwise in a credit line to the material. If material is not included in the chapter’s Creative Commons license and your intended use is not permitted by statutory regulation or exceeds the permitted use, you will need to obtain permission directly from the copyright holder.

