

**Dissemination, Future Research and Education
Adaptive Facade Network**

Pottgiesser, Uta; Knaack, Ulrich; Louter, Christian; Luible, Andreas; Konstantinou, Thaleia; Metcalfe, David; Henriksen, Thomas

Publication date

2018

Document Version

Final published version

Citation (APA)

Pottgiesser, U., Knaack, U., Louter, C., Luible, A., Konstantinou, T., Metcalfe, D., & Henriksen, T. (Eds.) (2018). *Dissemination, Future Research and Education: Adaptive Facade Network*. TU Delft OPEN Publishing.

Important note

To cite this publication, please use the final published version (if applicable).
Please check the document version above.

Copyright

Other than for strictly personal use, it is not permitted to download, forward or distribute the text or part of it, without the consent of the author(s) and/or copyright holder(s), unless the work is under an open content license such as Creative Commons.

Takedown policy

Please contact us and provide details if you believe this document breaches copyrights.
We will remove access to the work immediately and investigate your claim.

Dissemination, Future Research and Education – Adaptive Facade Network

Uta Pottgiesser
Ulrich Knaack
Christian Louter
Andreas Luible
Thaleia Konstantinou
David Metcalfe
Thomas Henriksen

Dissemination, Future Research and Education

Adaptive Facade Network

Dissemination, Future Research and Education – Adaptive Facade Network

This book is based upon work from COST Action TU 1403 adaptive facade network, supported by COST (European Cooperation in Science and Technology).

COST (European Cooperation in Science and Technology) is a pan-European intergovernmental framework. Its mission is to enable break-through scientific and technological developments leading to new concepts and products and thereby contribute to strengthening Europe's research and innovation capacities.

It allows researchers, engineers and scholars to jointly develop their own ideas and take new initiatives across all fields of science and technology, while promoting multi- and interdisciplinary approaches. COST aims at fostering a better integration of less research intensive countries to the knowledge hubs of the European Research Area. The COST Association, an international not-for-profit association under Belgian Law, integrating all management, governing and administrative functions necessary for the operation of the framework. The COST Association has currently 38 Member Countries.

www.cost.eu

Publisher

TU Delft Open
for the COST Action 1403 adaptive facade network

Editors

Uta Pottgiesser, Ulrich Knaack, Christian Louter, Andreas Luible, Thaleia Konstantinou, David Metcalfe, Thomas Henriksen

Layout and Co-Editing

Ashal Tyurkay

Design

Sirene Ontwerpers, Rotterdam

Cover Image

Marcin Brzezicki, Wroclaw

The editors worked intensively to collect all copyrights of pictures/graphs. In the unforeseen case of using unauthorized pictures/graphs the editors ask to get in contact with them.

The scientific posters and fact sheets within the book do represent a documentation of scientific activities and results – they do not focus at individual pictures/graphs. Copyright of the posters are with the authors of the posters.

ISBN 978-94-6366-112-6

© 2018 TU Delft Open

This work is subject to copyright. All rights are reserved, whether the whole or part of the material is concerned, specifically the rights of translation, reprinting, re-use of illustrations, recitation, roadcasting, reproduction on microfilms or in other ways, and storage in data banks. For any kind of use, permission of the copyright owner must be obtained.



COST is supported by
the EU Framework Programme
Horizon 2020

Dissemination, Future Research and Education

Adaptive Facade Network

Uta Pottgiesser, Ulrich Knaack, Christian Louter, Andreas Luble, Thaleia Konstantinou,
David Metcalfe, Thomas Henriksen

TU Delft for the COST Action 1403 adaptive facade network

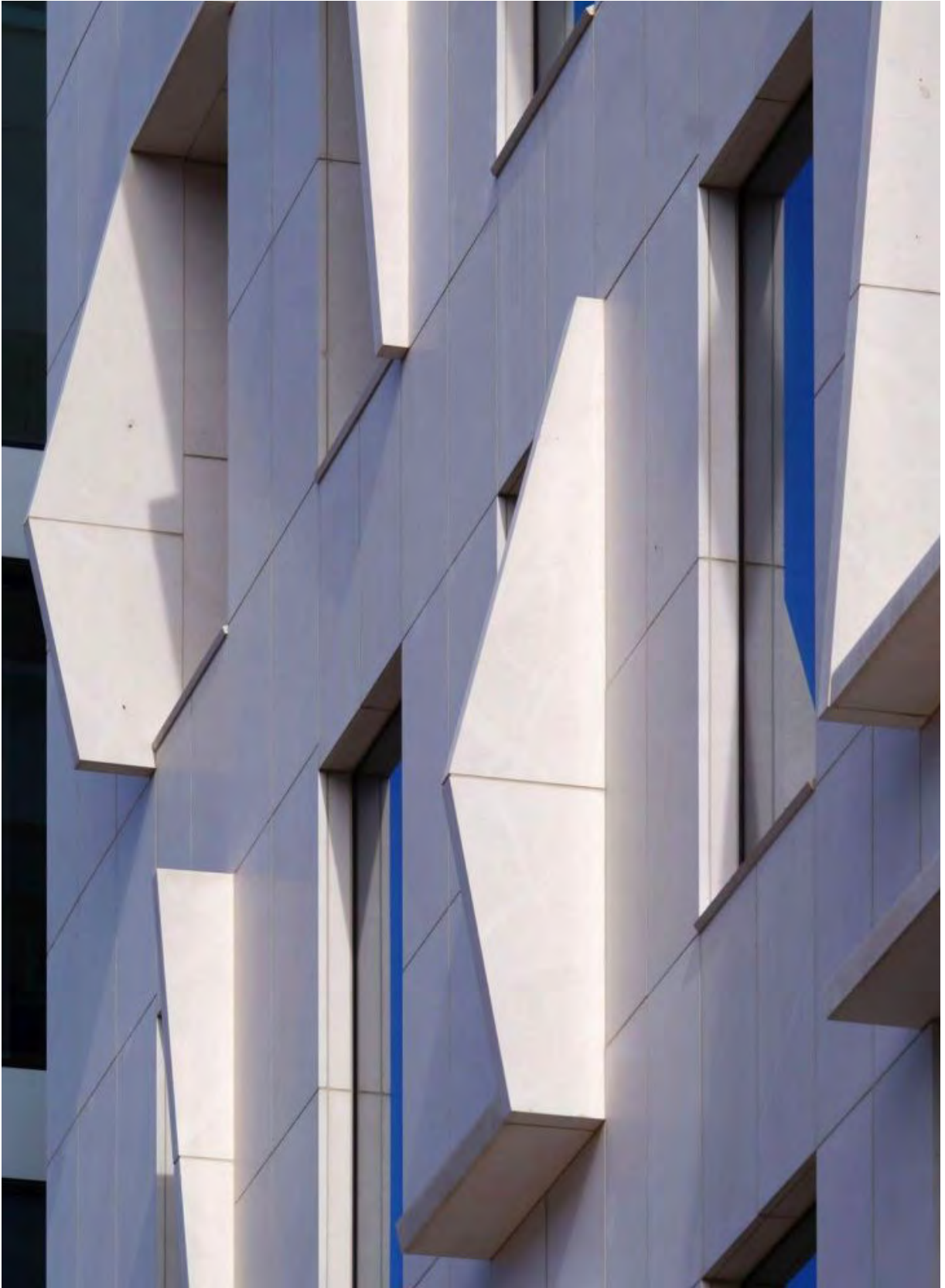

Kommunal Landspensjonskasse (KLP) Building / Solheim & Jacobsen (image: M. Brzezicki)

Preface

This booklet is one of three final documentations of the results of the COST-Action TU 1403 'ADAPTIVE FACADE NETWORK' to be published next to the proceedings of the Final COST Conference 'FACADE 2018 – ADAPTIVE!' and a Special Issue of the Journal of Façade Design & Engineering (JFDE).

While the proceedings and the journal present current scientific research papers selected through a traditional peer review process, these three final documentations have another focus and objective. These three documentations will share a more holistic and comparative view to the scientific and educational framework of this COST-Action on adaptive facades with the objective to generate an overview and a summary – different from the more specific approach of the proceedings and connecting to the first publication that was presenting the participating institutions. The three titles are the following and are connected to the deliverables of the responsible Working Groups (WG):

Booklet 3.1 Case Studies (WG1)

Booklet 3.2 Building Performance Simulation and Characterisation of Adaptive Facades (WG2)

Booklet 3.3 Dissemination, Future Research and Education (WG4)

Booklet 3.1 concentrates on the definition and classification of adaptive facades by describing the state of the art of real-world and research projects and by providing a database to be published on COST TU 1403 website (<http://tu1403.eu/>). **Booklet 3.2** focusses on comparing simulation and testing methods, tools and facilities. And finally, **Booklet 3.3** documents the interdisciplinary, horizontal and vertical networking and communication between the different stakeholders of the COST-Action organised through Short Term Scientific Missions (STSM), Training Schools and support sessions for Early Stage Researchers (ESR) / Early Career Investigators (ECI), industry workshops, and related surveys as specific means of dissemination to connect research and education. All three booklets show the diversity of approaches to the topic of adaptive facades coming from the different participants and stakeholders, such as: architecture and design, engineering and simulation, operation and management, industry and fabrication and from education and research.

The tasks and deliverables of Working Group 4 were organized and supported by the following group members and their functions:

- Thomas Henriksen, Denmark ESR/ECI
- Ulrich Knaack, The Netherlands Chair (2015-16)
- Thaleia Konstantinou, The Netherlands ESR/ECI
- Christian Louter, The Netherlands Vice-Chair, STSM Coordinator
- Andreas Luible, Switzerland Website, Meetings
- David Metcalfe, United Kingdom Training Schools
- Uta Pottgiesser, Germany Chair (2017-18)

As editors and Chairs, we would like to thank the Working Group members and authors from other Working Groups for their significant and comprehensive contributions to this booklet. Moreover, we sincerely thank Ashal Tyurkay for her great assistance during the whole editing and layout process. We also want to thank COST (European Cooperation in Science and Technology).

Uta Pottgiesser, Ulrich Knaack, Christian Louter



Contents

Preface	5
Introduction	9
Training School 2016 Hamburg	11
Introduction	13
Case Studies	15
Training School 2018 Belgrade	41
Introduction	43
Case Studies	45
Conclusions	47
Educational Package	67
Introduction	69
Reflection	73
ESR/ECI Support Sessions	75
Introduction	77
Support Session Hamburg 2016	81
Support Session Belgrade 2018	121
Short Term Scientific Missions (STSMs)	147
Introduction	149
STSM Descriptions	150
Industry-Workshops and Research Roadmap	181
Research and Collaboration today	183
Industry Workshop Delft 2015	183
Industry Workshop Lisbon 2018	185
Networking and joint Research Proposals	189
Research Roadmap	189
Biographies	193

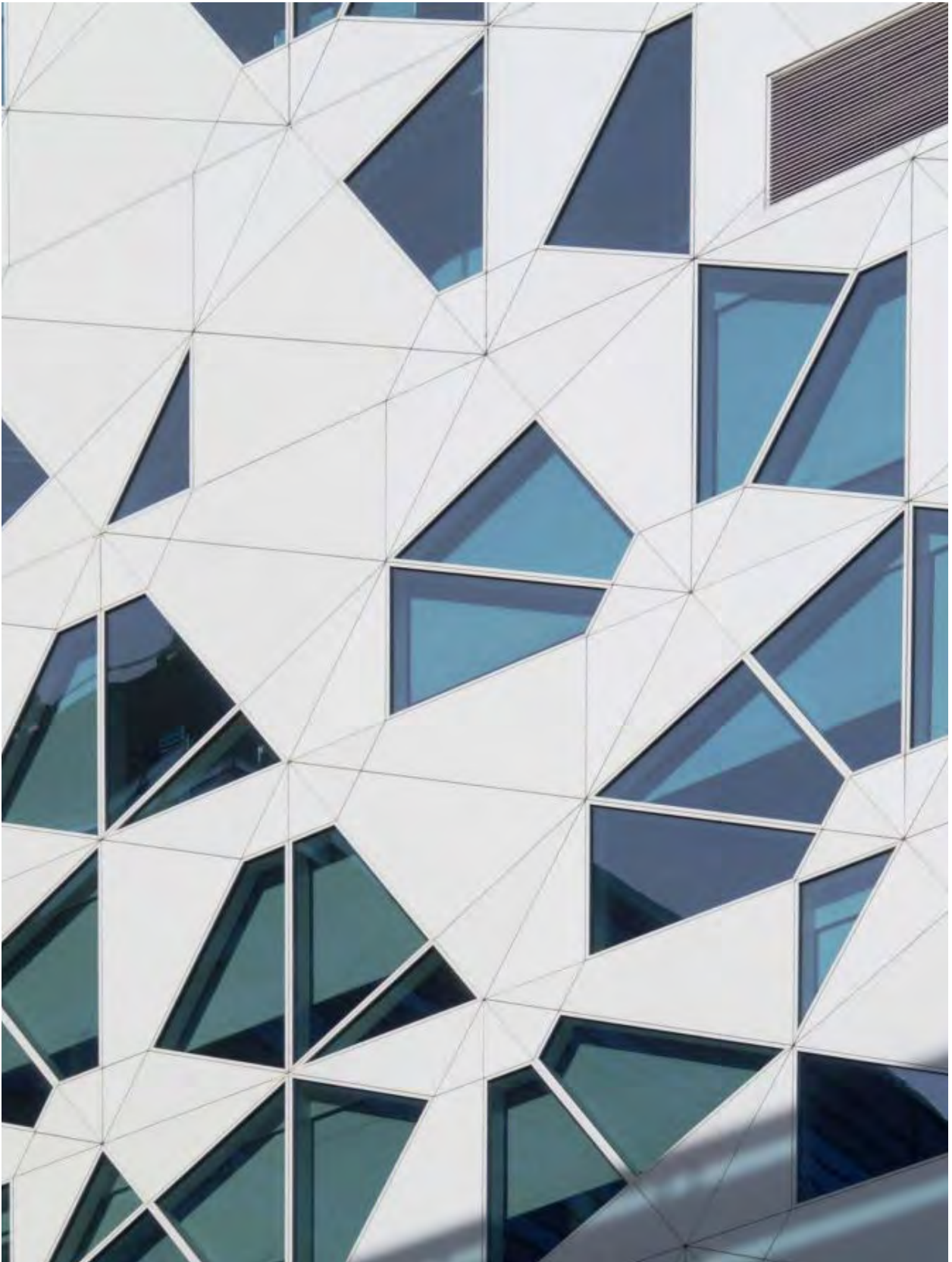

Deloitte Building / Snøhetta (image: M. Brzezicki)

Introduction

Uta Pottgiesser, Ulrich Knaack, Christian Louter

Working Group 4 was responsible for organising and managing the overall dissemination, networking and communication of the COST-Action and in particular for connecting research and education and with other academic and industry networks and environments. While these activities were defined in Tasks and Deliverables in the MoU and will be listed accordingly in the Final Report, this publication aims to visualise and give live to the achieved results by showing how the different COST-Tools (Conferences, Educational Pack, Training Schools, ESR/ECI support sessions, STSMs and two Industry Workshops) were connected with each other to create synergies and collaboration and long-term relationships. This publication on 'Dissemination, Future Research and Education' (Booklet 3.3) gives a specific overview of the Educational Pack, Training Schools, ESR/ECI-Workshops and STSM and is published online. Separate documentations of the Training Schools are also available online.

The first '**Task 4.1 Organisation and coordination of Action events**' resulted in eight MC/WG meetings in Brussels, Prague, Delft, Le Bourget du Lac, Lucerne, Wroclaw Munich and Lisbon, two Industry Workshops in Delft and Lisbon, two Training Schools and related ESR/ECI support sessions in Hamburg and Belgrade respectively, a Mid-Term Conference in Munich and a Final Conference in Lucerne. These activities are documented in individual publications as proceedings of the Mid-Term Conference 'Next Facades' (Booklet 2), of the Final Conference 'FAÇADE 2018 – ADAPTIVE!' (Booklet 4) and in a Special Issue of the Journal of Façade Design and Engineering (JFDE). Both booklets and the Special Issue will be printed for the Final Conference and are available online at the Action-website: <http://tu1403.eu/>.

'**Task 4.2 Educational Pack and Training School**' produced two Training Schools in Hamburg (2016) and in Belgrade (2018) with educational material and combined it with support sessions for 85 Early Stage Researchers (ESR)/Early Career Investigators(ECI). Both Training Schools attracted more than 35 participants each and can be considered as very successful. The Educational Pack consists of 20 lectures with more than 800 slides that are available digitally at the Action-website for the 210 Action-members, protected with a password.

With 31 STSM's in 6 separate calls **Task 4.3 Coordination of Short Term Scientific Missions (STSMs)** involved 46 individuals, 16 different EU countries, 1 near neighbour country (AU) and 34 different institutions who represented all Working Groups.

'**Task 4.4 Database of research project and experimental facilities in the domain of the Action**' was produced in the beginning of the Action in 2015 and was presented during the 3rd meeting in Delft as a poster exhibition and as a printed publication 'Adaptive Façade Network – Europe' (Booklet 1). The same counts for '**Task 4.5 Creation and management of Action website**' (<http://tu1403.eu/>) and for '**Task 4.6 Dissemination through journal, conference, trade publications and website**' - peer reviewed scientific journal papers and conference publications are accessible online.

As described in '**Deliverable 4.8 Submission of at least two research proposals at the end of the Action**' the Action-members submitted and prepared 15 joint research proposals on national and European level and as a result of the networking within the Action.



Hamburg city view

Training School 2016 Hamburg

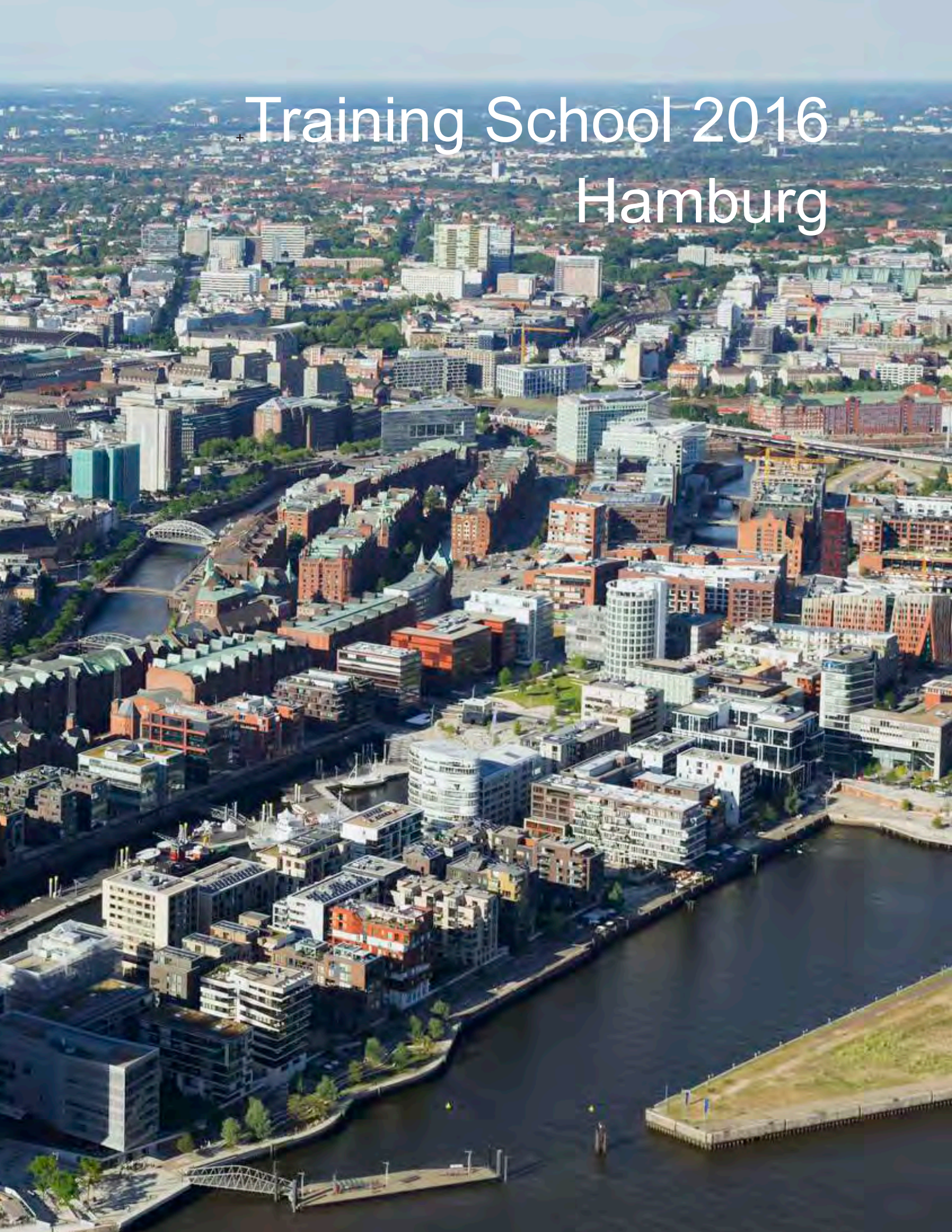



Hafencity Universität Hamburg (image: F. Wellershoff)

Training School 2016 “Adaptive Façades”

Frank Wellershoff

Introduction

Our demands concerning the quality of buildings and the room comfort they offer are steadily increasing. Well planned facades with functional technical solutions are a requisite to fulfil our demands under dynamic external environmental conditions while optimizing energy consumption. Therefore the expenditure for planning and erection of building envelopes has increased immensely in recent decades. A multitude of existing façade technologies and those still in research and design phase, driven by the market needs, has considerably expanded.

The next generation of façades (or building envelopes) consists of multifunctional and highly adaptive systems, where the physical separator between the interior and exterior environment (i.e. the building envelope) is able to change its functional features or behaviour over time in response to transient performance requirements and boundary conditions with the aim of improving the overall building performance. Numerous programs on modern universities are today dedicated to the subject of facade design and the number of research groups is steadily increasing. Within the COST program in the European Union (Cooperation in Science and Technology), a project “Adaptive Facades Network” was therefore promoted, which offers European scientists a platform to collaborate and exchange perspectives.

To connect the young generation of scientists, a summer school took place in September 2016 at the HafenCity University, Hamburg with a total of 62 participants from 37 universities. In addition to lecturers from Europe, invited experts from Brazil shared their research practices and findings. Their participation was supported by DAAD (German Academic Exchange Service).

In a very intensive week of lectures and workshops, the participating PhD and Master Students had the opportunity to look beyond the scope of their own research and to follow aspects of parallel research on different case studies. Not only new knowledge was gained and shared, but new long-term cross-border contacts are also established to make a prosperous contribution to continuation of the European science-evolving idea.



Figure 1 - TS 2016 Hamburg organisers and participants (image: F. Wellershoff)

The Adaptive Façades Training School took place from the 12th to 17th of September 2016 in the HafenCity University in Hamburg. During this week participants were offered opportunities for getting in touch with international researchers. Integrated in the program of the week were following key points:

- Frontal lectures from experts in areas related to Adaptive Façades
- PhD workshop about organisation of research projects
- 3-day innovative façade design workshop
- Final presentation on Saturday in front of evaluation expert committee

During the week the applicants were also offered a variety of social events reaching from a Hamburg City Tour Guide over a Welcome Dinner at HCU until a Final Party to round off the experiences during an exciting week.

As a part of the School, on the first day, there was a PhD / Research Colloquium and Workshop Session aimed at supporting new PhD students and researchers in the development of research methodologies and scientific writing. All PhD students and Researchers were instructed on how to create an overview of their research projects. The workshop was interactive – participants worked together to re-evaluate their research organisation with the help of expert supervisors



Figure 2 - Workshop Organising and Experts Committee

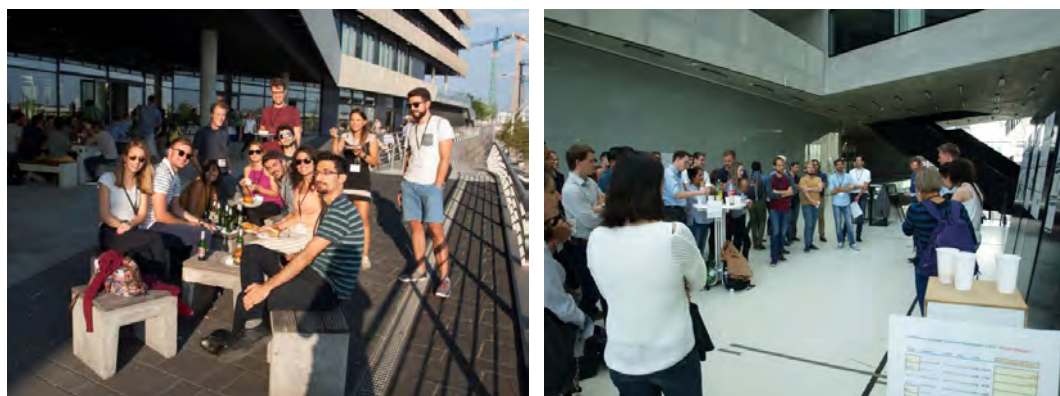

Figure 3 - Team-building BBQ party at the terrace of HCU and final presentations (images: F. Wellershoff)

Case Studies

Under given design conditions using state-of-the-art knowledge, workgroups had to design a conceptual solution for an adaptive façade system that would serve as a building's envelope with the possibility of performance adaptation in regards to outdoor (and indoor) conditions.

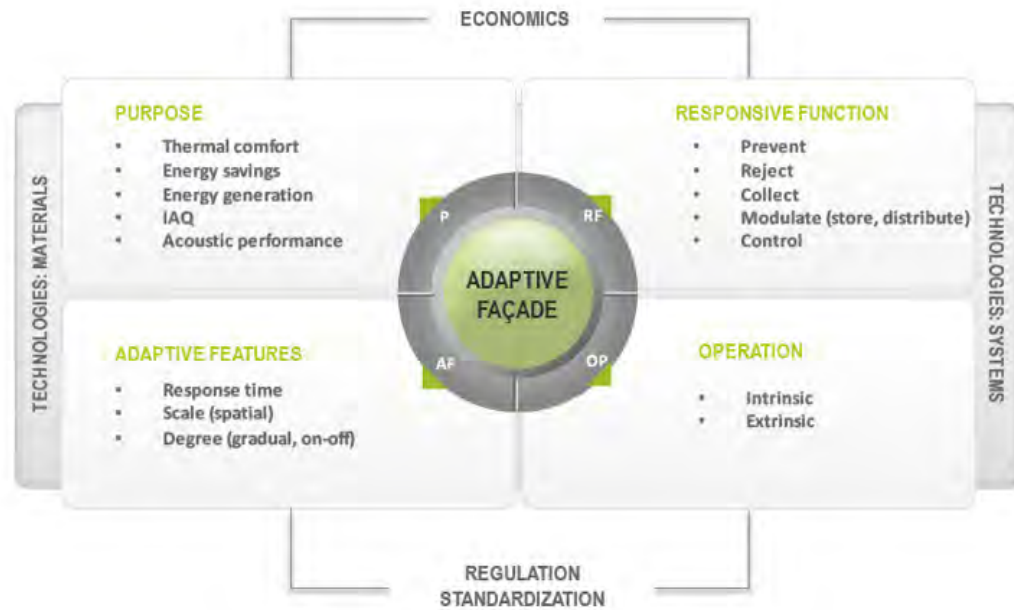

Figure 4 - Adaptive facade (Source: COST – Adaptive façade network – Europe)

There were 9 workgroups assembled based upon educational and working background. The main topics of the workshop were three different case studies. Of these 9 workgroups 3 were randomly chosen per case study to study and develop a solution for the task. Design was evaluated by the expert group. The workgroup with the best design solution per case study was awarded with a prize certificate.

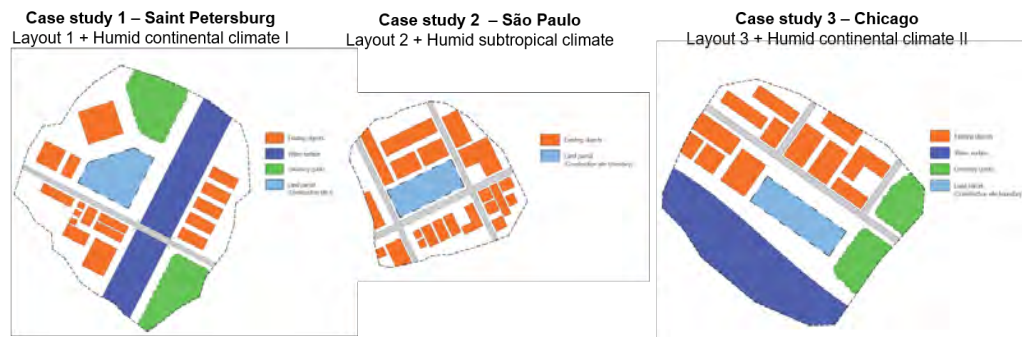

Figure 5 - Case studies

All buildings had to be designed as an office building located in area without high noise sources (high noise reduction was not a criteria). Specific climate conditions were given per each case study and are consisted of:

- Temperature range
- Diurnal averages of solar radiation and temperatures
- Relative humidity
- Global horizontal radiation

- Precipitation
- Weather data summary

Using the diverse know-how experience of the participants, workgroups had to develop a realistic and feasible solution of an adaptive façade system capable to harness benefits from its performance adaptation in regards to outdoor conditions. The final outcome of the workshop was a conceptual design of an adaptive façade system.

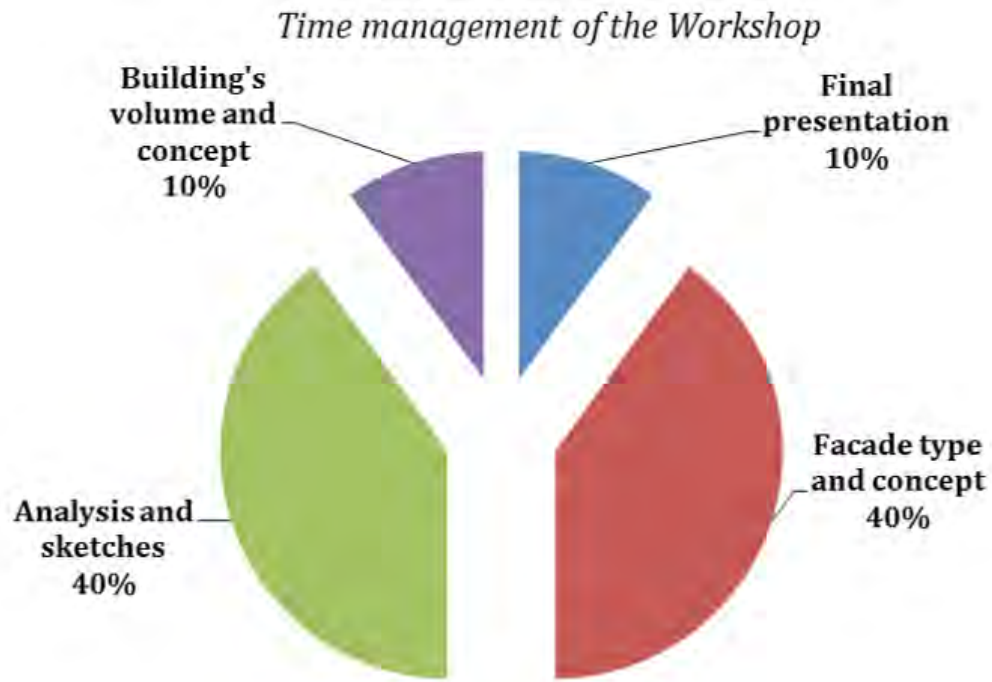

Figure 6 - Time management of the Workshop



Figure 7 - PhD / Research Colloquium (images: F. Wellershoff)

	block 1 9:00 - 10:00	block 2 10:15 - 11:15	block 3 11:30 - 12:30	lunch 12:30 - 13:30	afternoon	evening	
Monday	Foyer Registration 8:15 - 8:50 foyer HCU entrance east	Room 150 Tillmann Klein Introduction to adaptive facades: General, history of adaptivity, definitions, the adaptive facade survey	Room 150 Tillmann Klein State of the art on adaptive facades	Room 150 Daniel Aelenes Design of adaptive facades - Lessons learned from survey case studies	HCU Canteen Lunch Use your meal voucher	Room 150 PhD Progress Report 13:30 - 19:30 Feedback & Discussion	HCU Canteen Welcome Dinner 20:00 You are invited to enjoy our dinner buffet
Tuesday		Room 150 Chiara Bedon Identify structural, fire + safety facade performances where adaptive technologies are useful. Life-cycle cost assesment	Room 150 Christian Struck Adaptive facade system design process	Room 150 Christian Struck Adaptive facade system perfor- mance analysis	HCU Canteen Lunch Use your meal voucher	Excursion 14:00 - 18:00 See and learn from the buildings of the international building exhibition (IBA) http://www.iba-hamburg.de/en	
Wednesday		Room 150 Albert Castell Evaluate current simulation methods, identify lack of know- ledge, perspective for new simulation tools	Room 150 Jerome Le Dreau Map out performance metrics and requirements for adaptive facades / Experimental proce- dures and metrics, mock-up	Room 150 Frank Wellershoff Adaptive facade system perfor- mance measuring, occupant behavior, natural ventilation	HCU Canteen Lunch Use your meal voucher	Room 150 Workshop Intro 13:30 - 16:00 Definition and scope of the workshop	BBQ 16:00 Elbe Terrace Relax at the terrace and have a deli- cious barbecue
Thursday		Seminar rooms 2nd floor Workshop 9:00 - 12:30 Workshop „Adaptive Facade Design for New Buildings in Different Climate Zones“			HCU Canteen Lunch Use your meal voucher	Seminar rooms 2nd floor Workshop 13:30 - open end Workshop „Adaptive Facade Design for New Buildings in Different Climate Zones“	
Friday		Seminar rooms 3rd floor Workshop 9:00 - 12:30 Workshop „Adaptive Facade Design for New Buildings in Different Climate Zones“			HCU Canteen Lunch Use your meal voucher	Seminar rooms 3rd floor Workshop 13:30 - 18:00 Workshop „Adaptive Facade Design for New Buildings in Different Climate Zones“	Reeper- bahn Time for party! See the Hamburg nightlife, guided by Locals
Saturday		Seminar rooms 3rd floor Workshop 10:00 - 13:30 Workshop „Adaptive Facade Design for New Buildings in Different Climate Zones“ Food We will have a small Brunch with Snacks, Fruits, Juice, Coffee, Tee and typical „Frankfurterchen“ from Hamburg as well as a lunch				Room 150 Final Presentation 13:30 - 15:30 Present your workshop results	Foyer Farewell 15:30 - 17:00

Figure 8 - TS 2016 Hamburg schedule

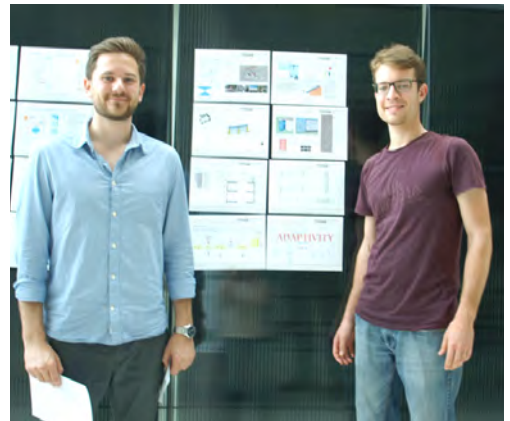

Figure 9 - Awarded workgroups (images: F. Wellershoff)

Awarded workgroups - teams:

- Case Study I: St. Petersburg
Team 5
- Case Study II: São Paulo
Team 4
- Case Study III: Chicago
Team 1

Table 1 - Workgroups - Teams

Case Study I – St. Petersburg

Team 3	Bacha Ben Cherif Bosserez Ann Friedrich Matthias Juaristi Miren Schultz-Cornelius Milan Van Lancker Bert	University of Constantine Hasselt University HafenCity University University of Navarra Technische Universität Kaiserslautern Ghent University
Team 5	Arantes Beatriz Cakaric Ivan Rios Elida Schweers Klaus Speroni Alberto Valdenebro Esaiy Antonio	State University Of Campinas Ostwestfalen-Lippe Hochschule University Polytechnic of Madrid HafenCity University Politecnico di Milano HafenCity University
Team 9	Ghasempourabadi Mohammadhossein Contrada Francesca Cosmatu Tudor Meloni Marco Reina Kathia Vanapalli Manikanta	Eindhoven University of Technology SIE Paris EST – IRC ESTP Delft University of Technology University IUAV of Venice HafenCity University Hochschule Anhalt

Case Study II - São Paulo

Team 4	Denz Paul Fernandez Mario Hannequart Philippe Posavec Matija Santoro Giulia Scheuring Leonie	Delft University of Technology Polytechnic University of Madrid Ecole Nationale Des Ponts et Chaussees HafenCity University Politecnico di Milano Technische Universität Dresden
Team 6	Abdellatif Mostafa Carcassi Olga Beatrice Ives Shawn Nguyen Anh Phan Saini Hemshikha Souza Caetano Diego	HafenCity University University of Pisa Anhalt University of Applied Science Delft University of Technology Technische Universiteit Eindhoven Federal Fluminense University Niteroi RJ Brazil
Team 8	Alatawneh Bader De Michele Giuseppe Giovannini Luigi Martin-Conseuegra Fernando Milkova Aleksandra Wattez Yvonne	University of Palermo Free University of Bolzano Politecnico di Torino Universidad Politecnica de Madrid Lund University Delft University of Technology

Case Study III - Chicago

Team 1	Baudisch Roman Castaneda Estefana Charpentier Victor Dubljevic Andjela Grassi Giulia Soliman Mohamed	HafenCity University Technical University of Madrid Princeton University University of Belgrade University of Pisa University of Lund
Team 2	Förch Matthias Fallahi Amin Khoont Mehul Pereira Julia Sousa Christoph Villaca Ana	HafenCity University University of Bath HafenCity University Universidade Técnica de Lisboa University of Minho University of Wollongong
Team 7	Basarir Bahar Campos-Morales Beatriz Curpek Jakub Kamari Aliakbar Silvestru Vlad Tugrul Asli	Istanbul Technical University HafenCity University Faculty of Civil Engineering STU Bratislava University of Palermo + Aarhus University University of Technology Graz Ostwestfalen-Lippe Hochschule

Workshop Case Study I – St. Petersburg

Case study 1 – Saint Petersburg Layout 1 + Humid continental climate I

LOCATION: SAINT-PETERSBURG, RUS
Latitude/Longitude: 59.97° North, 30.3° East, **Time Zone from Greenwich 3**
Data Source: IWECC Data 260630 WMO Station Number, **Elevation 4 m**

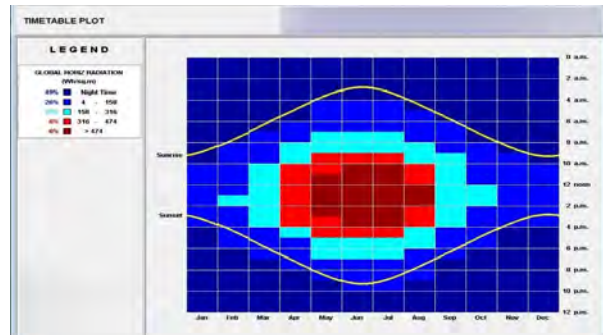
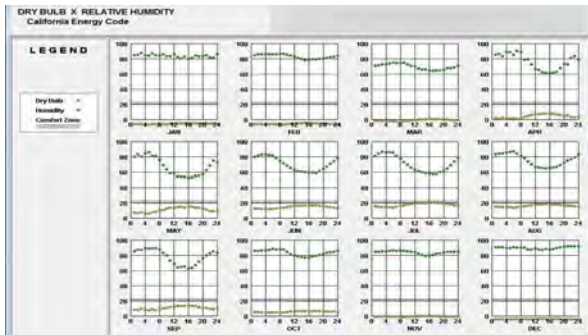
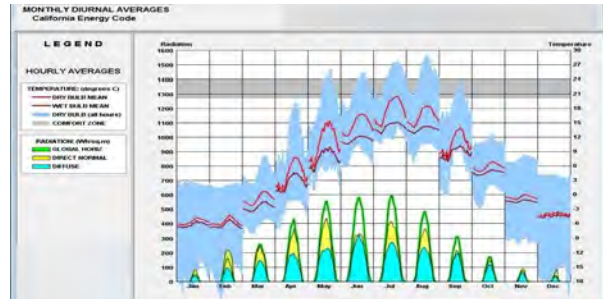
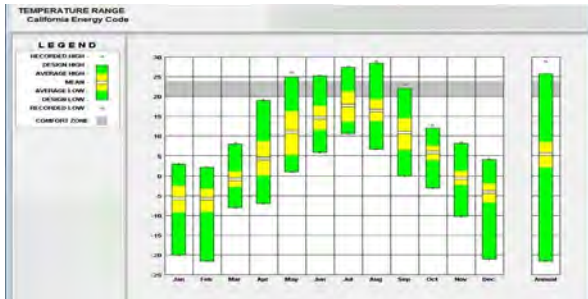
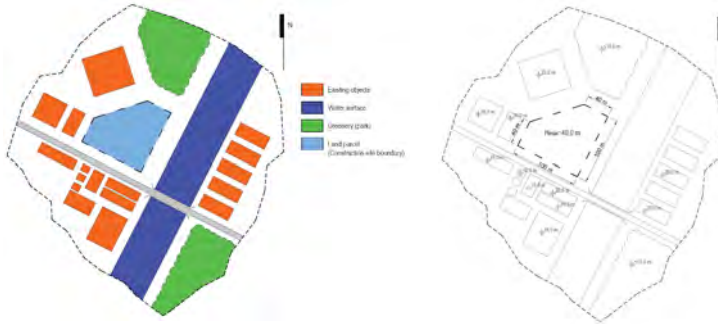

WEATHER DATA SUMMARY												
MONTHLY MEANS												
	JAN	FEB	MAR	APR	MAY	JUN	JUL	AUG	SEP	OCT	NOV	DEC
Global Horiz Radiation (Avg Hourly)	34	100	154	224	268	264	302	238	168	97	48	26
Direct Normal Radiation (Avg Hourly)	31	136	158	191	214	177	718	337	108	81	11	94
Diffuse Radiation (Avg Hourly)	26	61	93	122	148	177	162	145	118	70	36	21
Global Horiz Radiation (Max Hourly)	171	343	466	648	741	792	746	670	542	389	172	132
Direct Normal Radiation (Max Hourly)	613	786	839	853	718	725	757	700	613	512	461	409
Diffuse Radiation (Max Hourly)	89	165	275	360	402	421	419	311	196	108	57	57
Global Horiz Radiation (Avg Daily Total)	223	879	1857	2548	2881	2397	5331	2548	1129	641	324	148
Direct Normal Radiation (Avg Daily Total)	137	1387	1870	2787	2862	2781	3851	3003	1391	815	205	252
Diffuse Radiation (Avg Daily Total)	175	535	1187	1798	2151	2123	2851	2222	1462	802	248	122
Global Horiz Illumination (Avg Hourly)	1700	1070	1679	2464	3129	3239	3209	2814	1833	1069	480	267
Direct Normal Illumination (Avg Hourly)	2028	1242	1428	1847	2040	1760	2072	1868	1607	893	296	238
Dry Bulb Temperature (Avg Monthly)	-8	-6	0	6	11	14	17	18	16	9	0	-4
Dew Point Temperature (Avg Monthly)	-7	-7	-5	0	4	8	11	11	8	3	-2	-9
Relative Humidity (Avg Monthly)	84	82	89	76	67	70	70	78	79	81	84	80
Wind Direction (Avg Monthly)	230	240	150	180	270	270	0	230	270	290	270	270
Wind Speed (Avg Monthly)	3	2	3	3	2	2	3	2	3	2	2	2
Ground Temperature (Avg Monthly of 3 Depth)	5	5	-2	-2	0	3	7	11	12	11	9	5

Month	Jan	Feb	Mar	Apr	May	Jun	Jul	Aug	Sep	Oct	Nov	Dec	Year
Average precipitation mm (inches)	44	33	37	31	46	71	79	83	64	68	55	51	661
Average rainy days	-1.73	-1.3	-1.46	-1.22	-1.81	-2.8	-3.11	-3.27	-2.52	-2.68	-2.17	-2.01	-26.02
Average snowy days	9	7	10	13	16	18	17	17	20	20	16	10	173
Average snowy days	17	17	10	3	0	0	0	0	0	2	9	17	75

Case Study I: St. Petersburg – Team 3

► Juaristi, Ann Bossarez, Bert Van Lancker, Cherif Ben Bacha, Milan Schlutz-Cornelius, Matthias Friedrich

General information

Site Plan

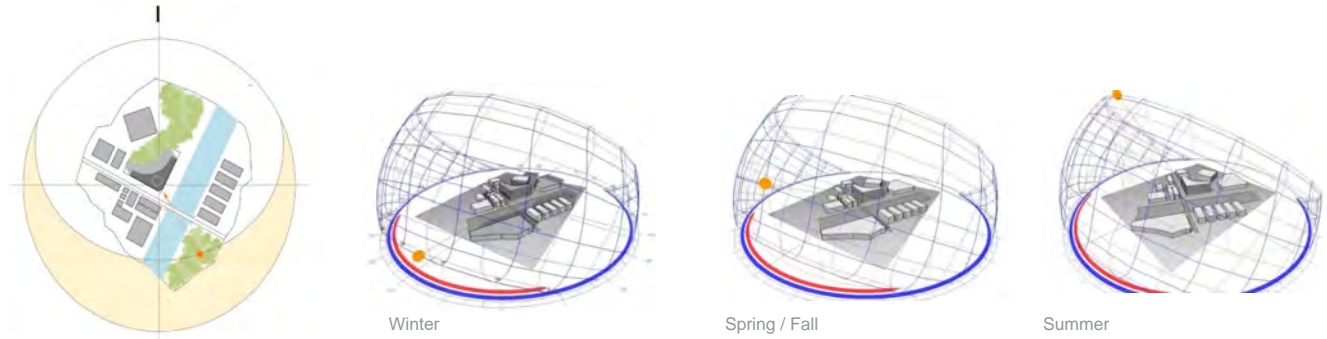

Climate and decision

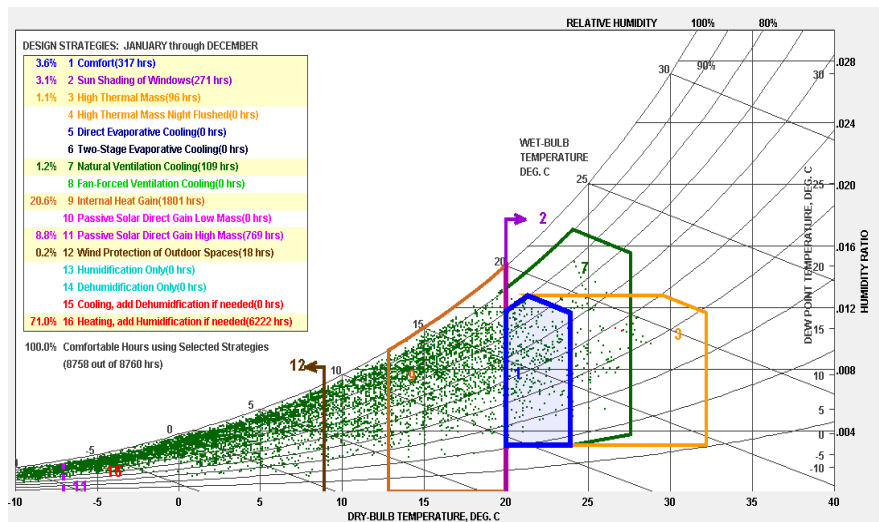

Psychrometric conditions

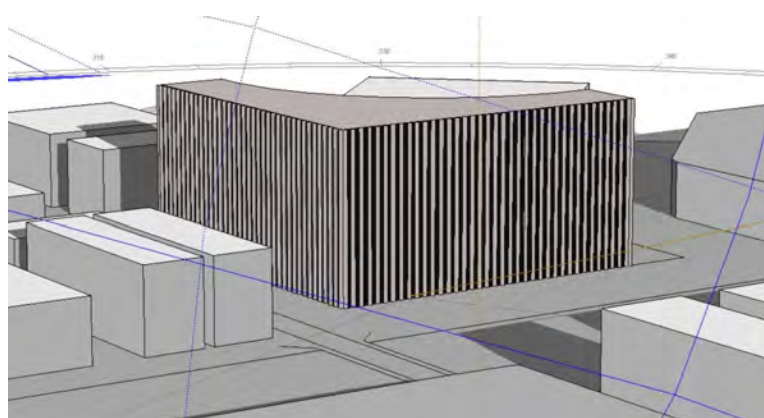

Building needs

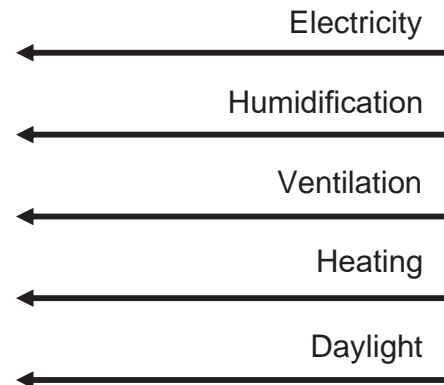

Case Study I: St. Petersburg – Team 3

► Juaristi, Ann Bossarez, Bert Van Lancker, Cherif Ben Bacha, Milan Schlutz-Cornelius, Matthias Friedrich

Architectural design concept

Adaptive façade concept

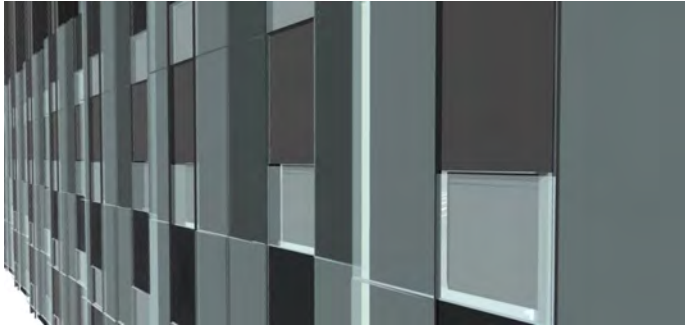

General facade view - A

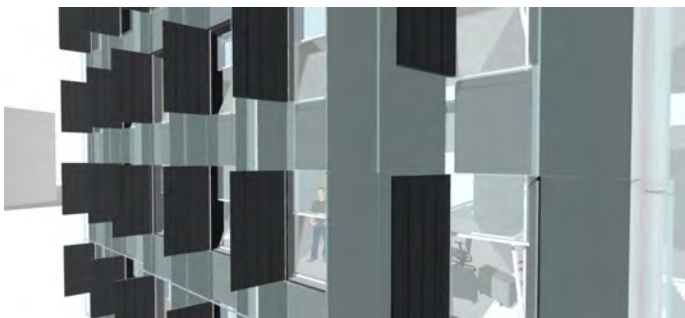

General facade view - B

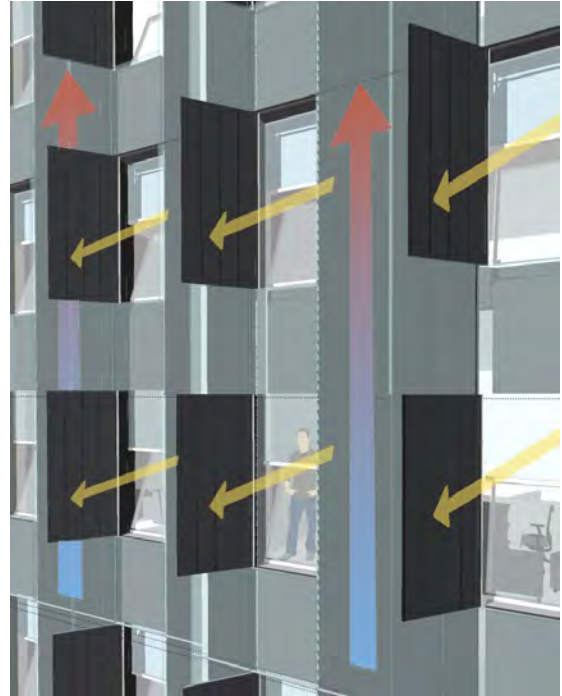

Ventilation

Technical details + Materials

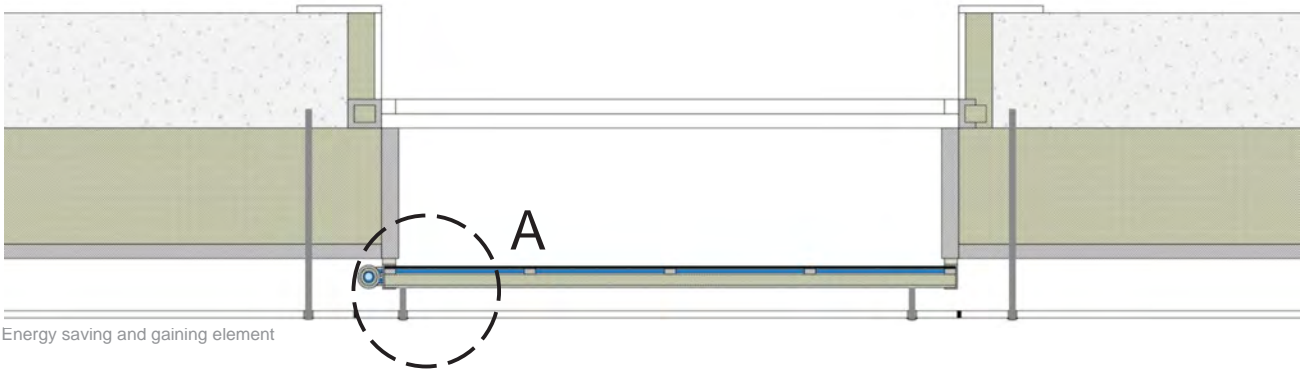

Energy saving and gaining element

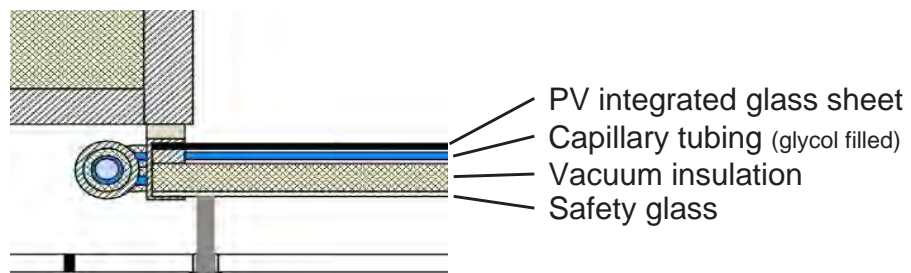

Detail A

Case Study I: St. Petersburg – Team 5





▶ Beatriz Arantes, Ivan Cakacic, Elida Rios, Alberto Speroni , Klaus Schweers, Esaiy Valdenebro

General information

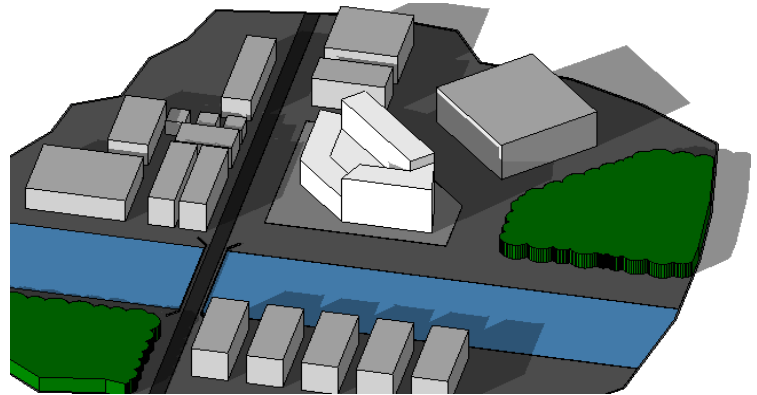
Location

Latitude / Longitude: 60.0 ° North / 30,3 ° East



- Existing Objects 
- Water Surface 
- Greenery - Park 
- Land Parcel 

Architectural design concept

Building concept

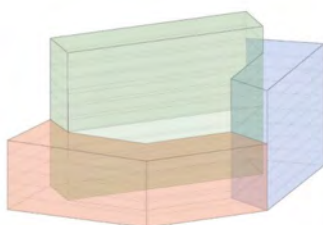
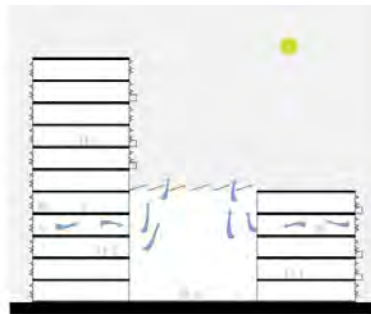
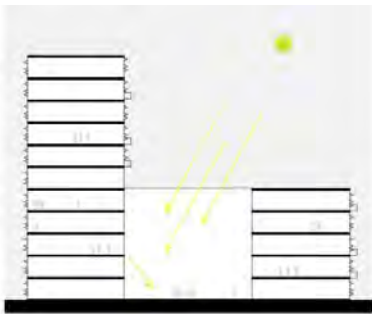

Total GFA: 25, 415 m²



Compact



Extensive

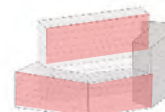

South facade

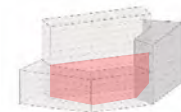

Court yard

Case Study I: St. Petersburg – Team 5

► Beatriz Arantes, Ivan Cakacic, Elida Rios, Alberto Speroni , Klaus Schweers, Esaiy Valdenebro

Architectural design concept

Façade concept

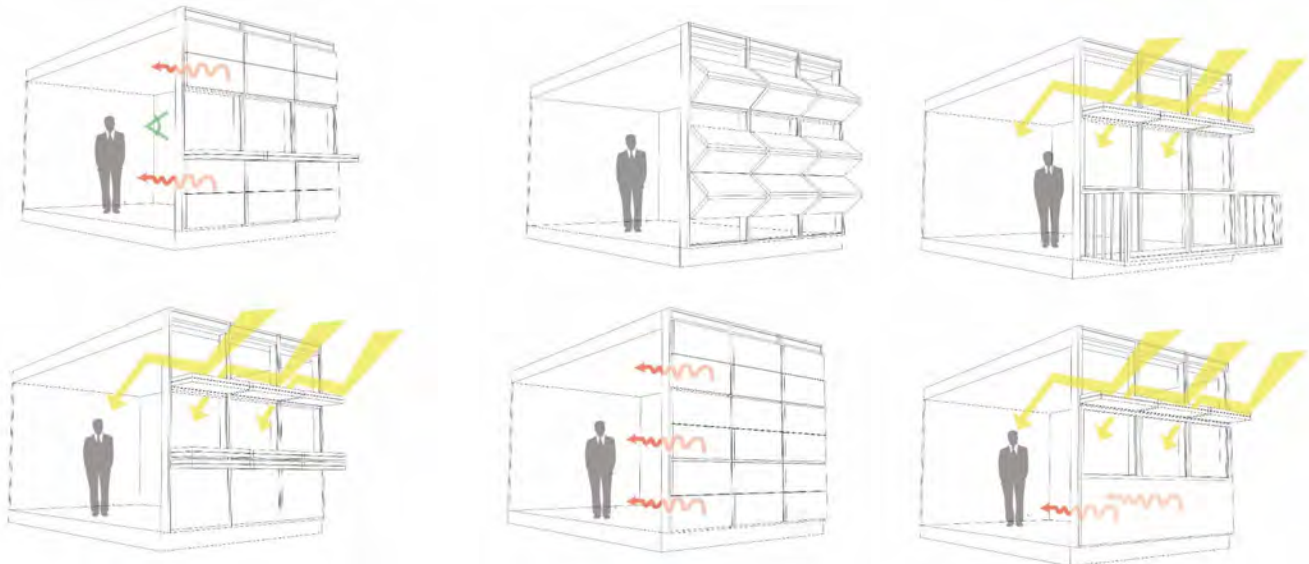

Technical details

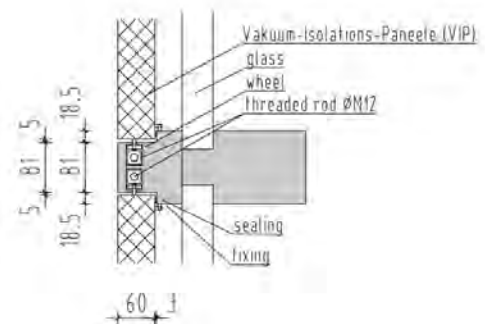
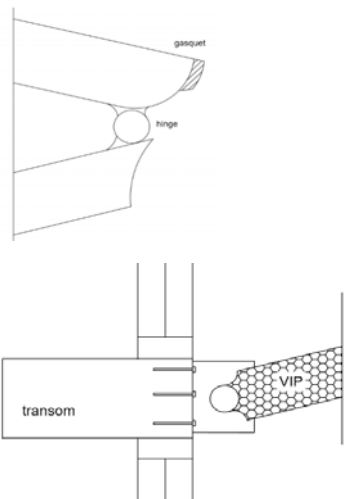
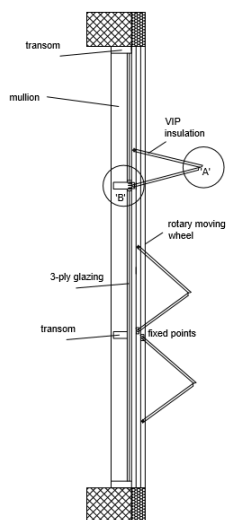

PROS	CONS
<ul style="list-style-type: none"> •Thermal resistance •User comfort •Redirecting daylight •Vision outside 	<ul style="list-style-type: none"> •Mechanical elements •Expensive •Durability

Visualisation

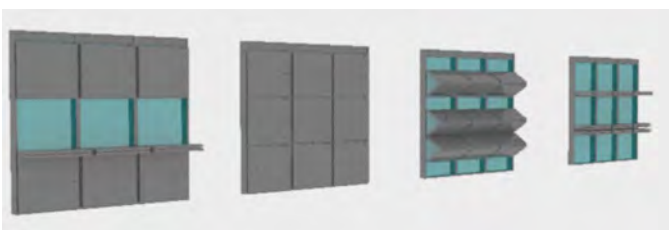

Case Study I: St. Petersburg – Team 9

► Francesca Contrada, Tudor Cosmatu, Mohammadhossein Ghasempourbadi, Marco Meloni, Kathia Vanessa Román Reina, Manikanta Vanapalli

General information

Façade orientation

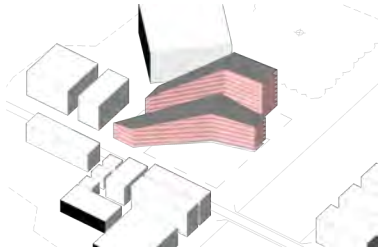

Project details

- Type of use: Office
- Footprint: 3500 m²
- Average story height: 3,5 m
- Building height: 40 m
- Floor area: 850- 3500 m²
- Number of floors: 11

Architectural design concept

Building concept

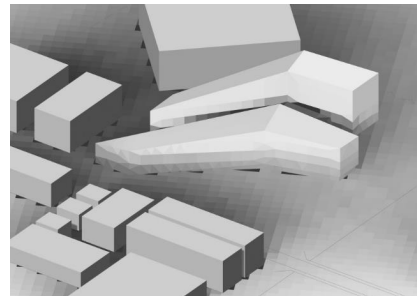
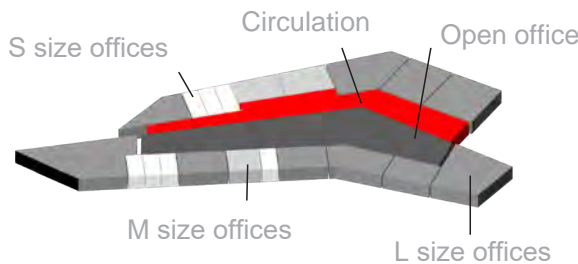

Needs

- Heating for winter
- User control
- Glare control
- No overheating in summer
- Thermal mass
- Natural ventilation
- Snow

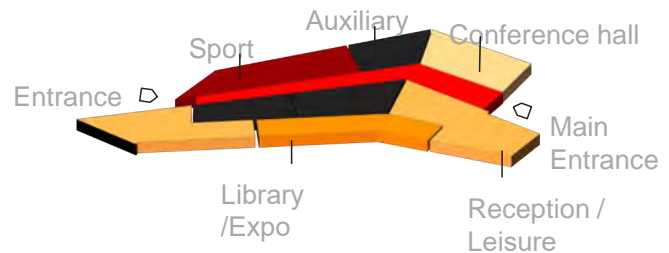
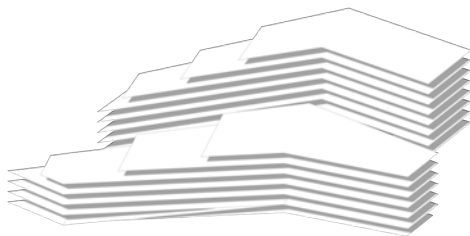

Façade concept

Façade solution

- Heating air cavity/insulation
- Modular strategy & whole-building strategy
- Electrochromic fenestration components
- Shutters for heat control
- Concrete building structure
- Natural ventilation by user control
- Roof geometry to minimize loads

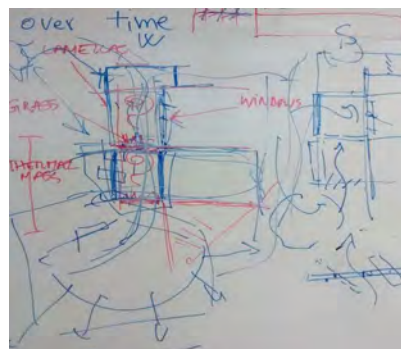

Sketches

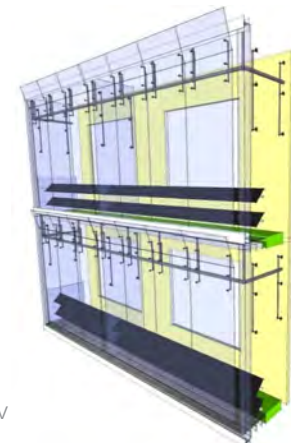

First option
façade + PV
panels

Case Study I: St. Petersburg – Team 9

► Francesca Contrada, Tudor Cosmatu, Mohammadhossein Ghasempourbadi, Marco Meloni, Kathia Vanessa Román Reina, Manikanta Vanapalli

Winter behaviour

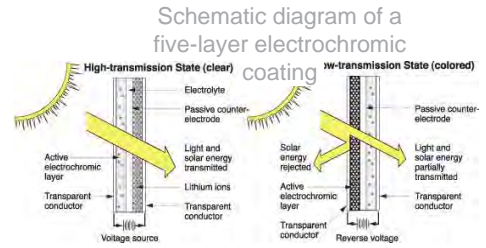
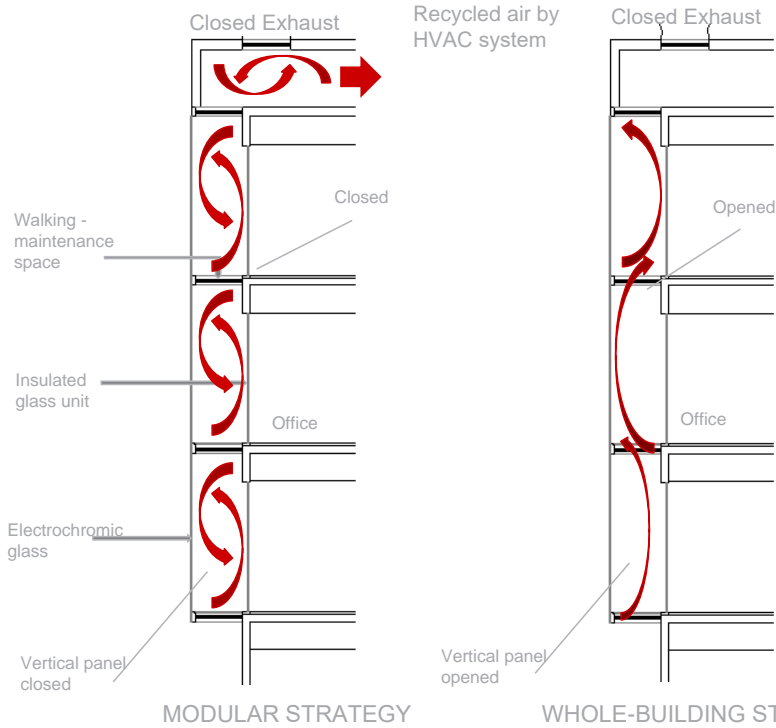

Source:
<http://www.commercialwindows.org/electrochromic.php>

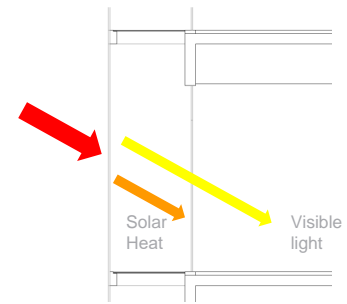

Summer behaviour

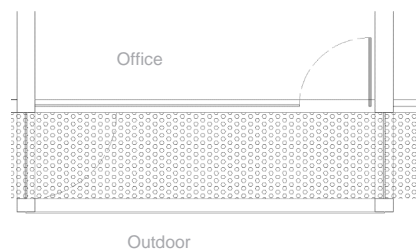
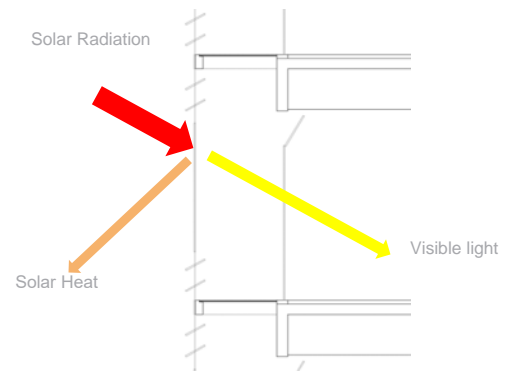
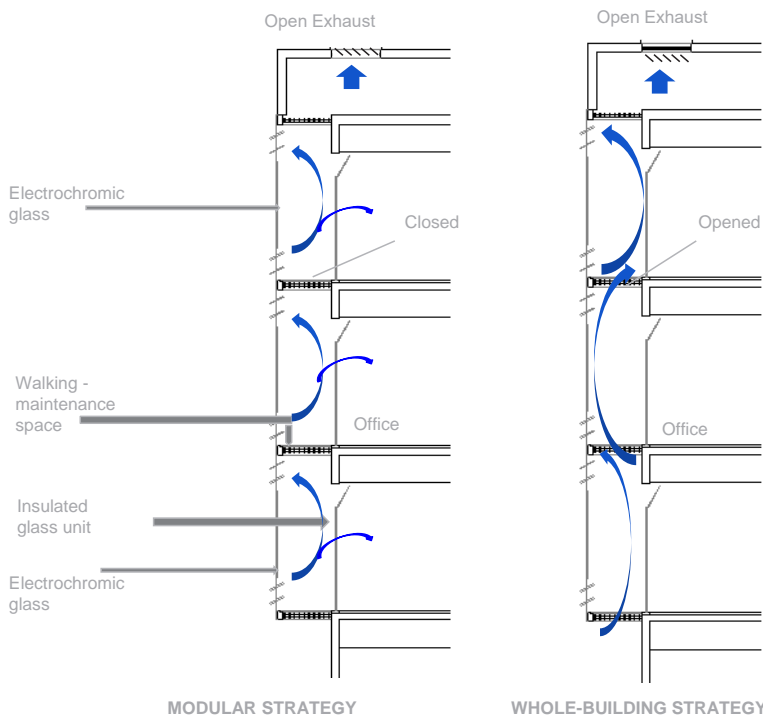

Workshop

Case Study II – São Paulo

Case study 2 - São Paulo
Layout 2 + Humid subtropical climate

LOCATION: SAO PAULO, -, BRA
Latitude/Longitude: 23.62° South, 46.65° West, **Time Zone from Greenwich -3**
Data Source: IVEC Data 837800 WMO Station Number, **Elevation 803 m**

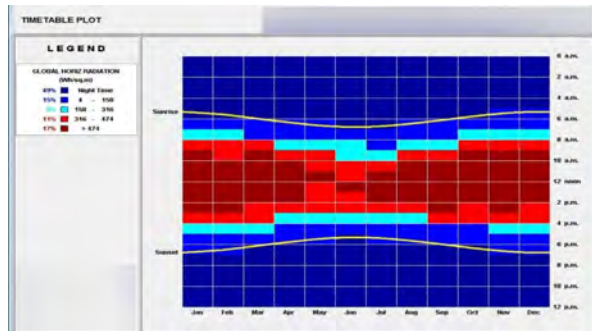
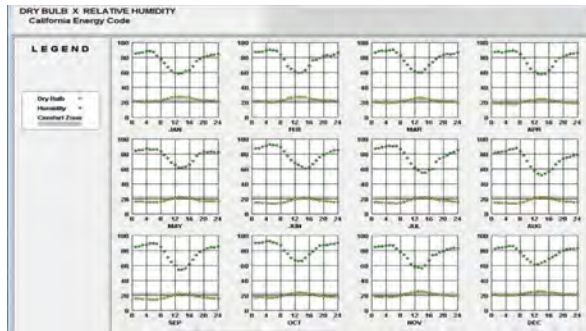
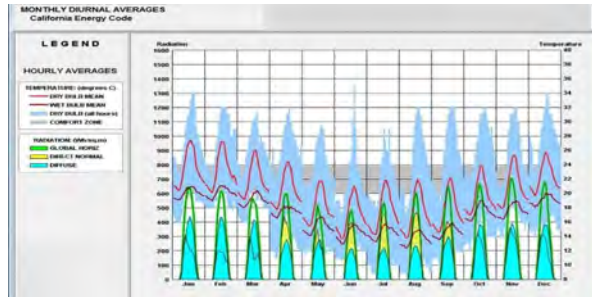
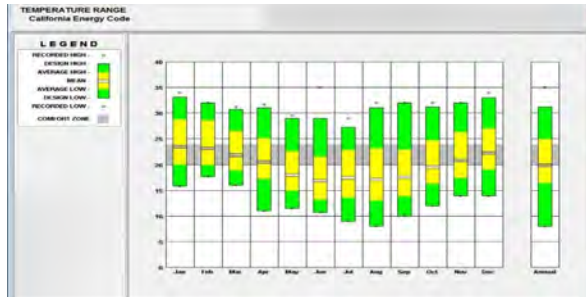
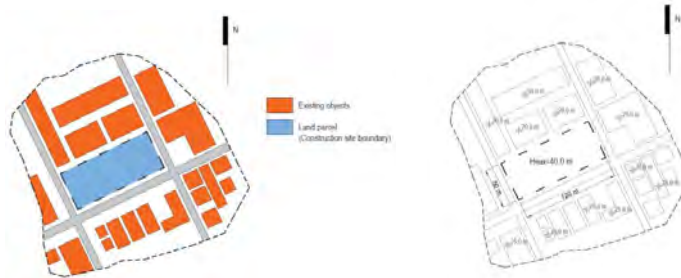

WEATHER DATA SUMMARY

MONTHLY MEANS	JAN	FEB	MAR	APR	MAY	JUN	JUL	AUG	SEP	OCT	NOV	DEC
Global Hourly Radiation (Avg Hourly)	386	353	330	322	292	278	279	329	363	372	423	380
Direct Normal Radiation (Avg Hourly)	170	133	138	282	386	240	289	284	241	176	221	183
Diffuse Radiation (Avg Hourly)	250	251	241	276	274	240	242	252	285	231	229	223
Global Hourly Radiation (Max Hourly)	1138	987	937	905	779	642	704	804	836	1040	1004	1000
Direct Normal Radiation (Max Hourly)	586	508	590	820	875	777	792	880	907	1209	1003	1003
Diffuse Radiation (Max Hourly)	458	583	458	427	270	343	364	400	472	591	594	549
Global Hourly Radiation (Avg Daily Total)	5112	4340	4248	4128	3739	2822	3173	3803	4275	4882	5288	5157
Direct Normal Radiation (Avg Daily Total)	2251	1708	1892	3812	2347	2340	2781	2288	2881	2231	2813	2480
Diffuse Radiation (Avg Daily Total)	3465	3228	2812	2015	2887	1486	1522	1711	2227	2813	3017	3261
Global Hourly Radiation (Avg Monthly)	43467	38887	38263	38089	32480	30824	32763	37381	38913	43822	48862	42720
Direct Normal Radiation (Avg Monthly)	18780	12813	14274	28286	18238	22770	24760	27792	27960	18774	23286	17537
Dry Bulb Temperature (Avg Monthly)	23	23	21	20	18	16	17	17	17	18	20	21
Dew Point Temperature (Avg Monthly)	18	18	17	15	15	12	12	11	12	14	15	17
Relative Humidity (Avg Monthly)	78	78	78	77	77	70	70	72	76	82	75	78
Wind Direction (Monthly Mode)	200	120	120	120	120	120	120	120	120	120	120	120
Wind Speed (Avg Monthly)	2	1	2	2	2	2	2	2	2	2	2	2
Greatest Temperature (Avg Monthly of 3 Depths)	29	29	29	29	29	29	29	29	29	29	29	29

Month	Jan	Feb	Mar	Apr	May	Jun	Jul	Aug	Sep	Oct	Nov	Dec	Year
Average rainfall mm (inches)	237.4	221.5	160.5	72.6	71.4	50.1	43.9	39.6	70.7	126.9	145.8	200.7	1,441
Average rainy days (≥ 1 mm)	-9.346	-8.72	-6.319	-2.858	-2.811	-1.972	-1.728	-1.559	-2.783	-4.996	-5.74	-7.902	-56.73
Average rainy days (≥ 1 mm)	15	14	11	7	6	4	4	4	7	10	11	14	107

Case Study II: São Paulo – Team 4

► Paul Denz, Mario Fernandez, Philippe Hannequart, Matija Posavec, Giulia Santoro, Leonie Scheuring

Architectural design concept

Building concept

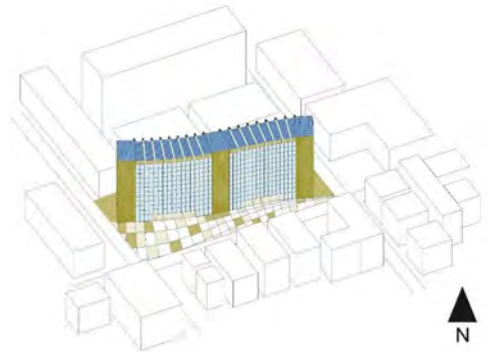

Facade concept

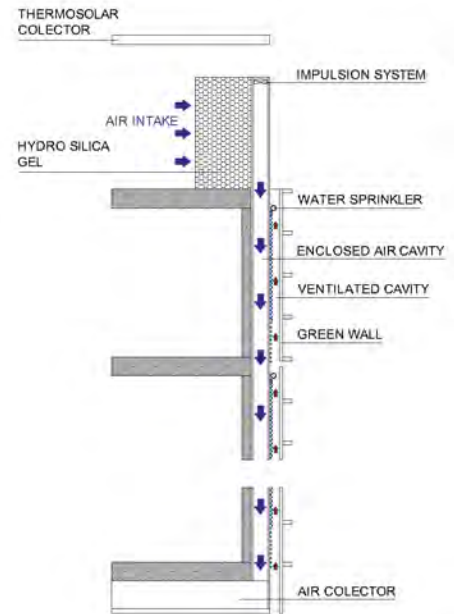
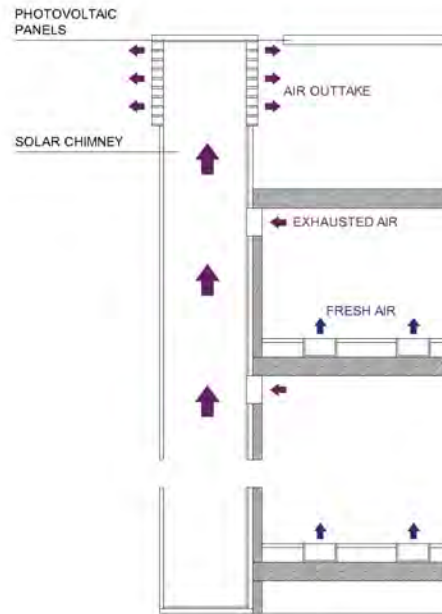
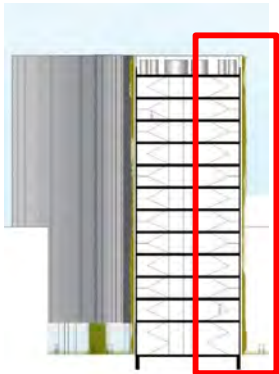

Operating process

Silica gel's high specific surface area (around 800 m2/g) allows it to adsorb water readily, making it useful as a desiccant (drying agent).

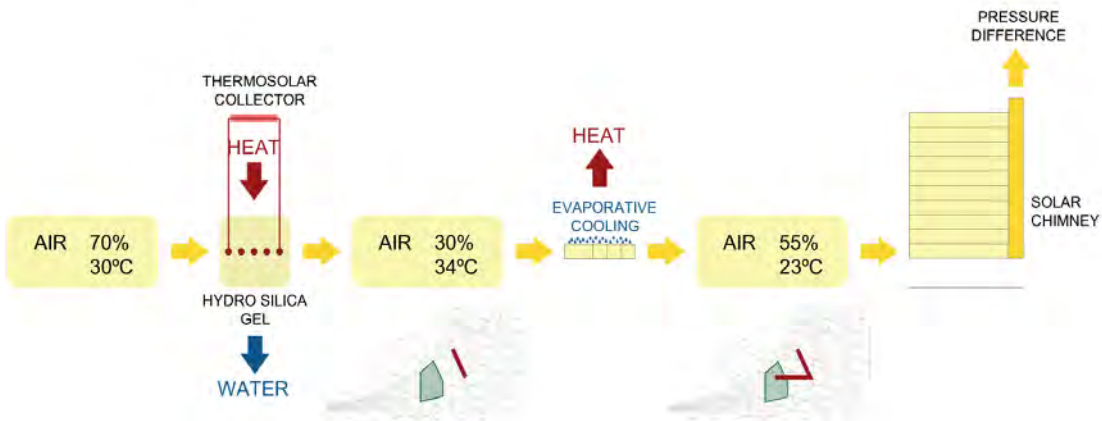

Case Study II: São Paulo – Team 4

► Paul Denz, Mario Fernandez, Philippe Hannequart, Matija Posavec, Giulia Santoro, Leonie Scheuring

Evaporative cooling

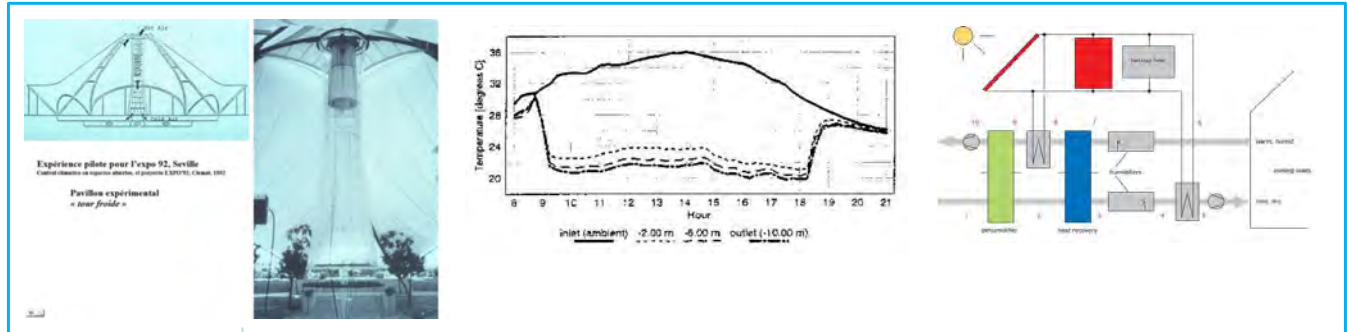

Inspiration

If the droplets of water had size $14 \mu\text{m}$ – the temperature dropped by 12°C in the first meters of the tower.
 If the droplets of water had size $62 \mu\text{m}$ – the temperature dropped by 11°C in the whole tower length.

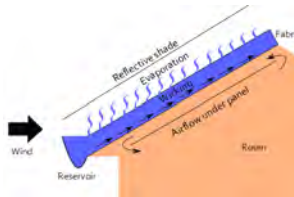

An evaporative cooler (also swamp cooler, desert cooler and wet air cooler) is a device that cools air through the evaporation of water. Evaporative cooling works by employing water's large enthalpy of vaporization.

Solar chimney

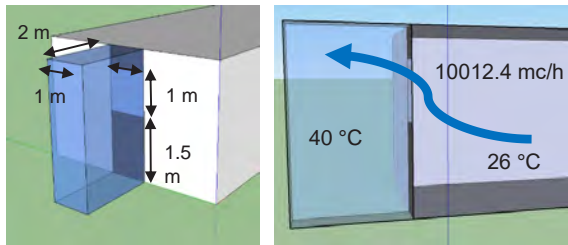

Need air flow rate/floor: $10800 \text{ m}^3/\text{h}$
 Natural air flow rate/floor: $10012.4 \text{ m}^3/\text{h}$

usage:	office building
flow rate/pers:	36 m ³ /h pers
crowd:	0.2 p/sqm
people/floor:	300 people/floor
flow rate/floor:	10800 m ³ /h
floor area:	1500 sqm/floor
floor volume:	4500 m ³
n.air change/h:	2.4 h ⁻¹
n. storey:	11
speed velocity:	0.05-0.2 m/s

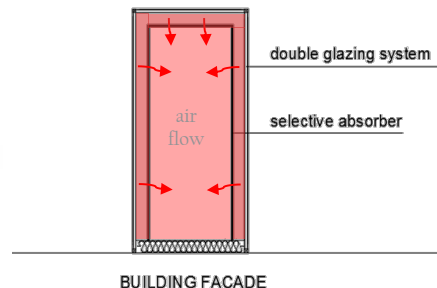
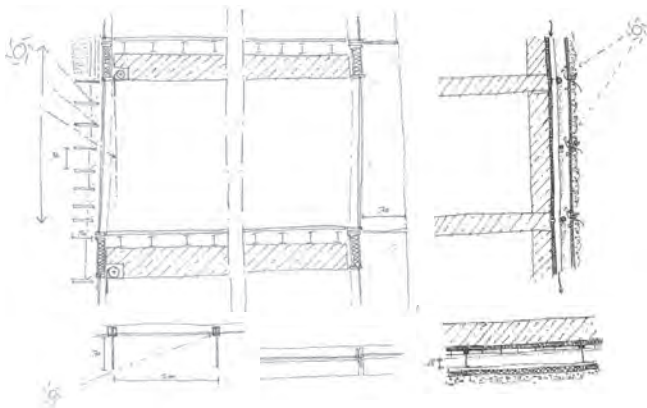

Selective absorber:
 perforated steel plate with solar absorber coatings

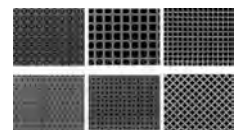

Case Study II: São Paulo – Team 6

► Olga Beatrice Carcassi, Hemshikha Saini, Mostafa Abdellatif, Diego Souza Caetano, Shawn Ives, Phan Anh Nguyen

Architectural design concept

Façade concept

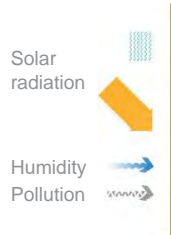
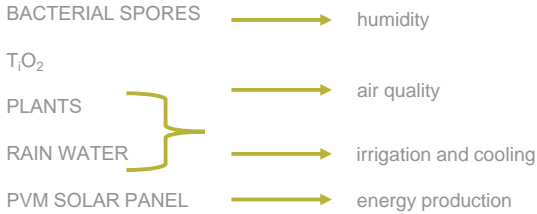

OPORTUNITIES

- high solar radiation
- high average rainy days (173 days/year)

PROBLEMS

- high solar radiation
- high pollution (natural ventilation)
- humidity

PURPOSES

- Product energy
- Purify the air
- Dehumidify
- Reuse of rain water



BACTERIAL SPORES_BACILLUS

Spore formation (Sporulation) is a method for bacterias to survive under **unfavorable conditions** (es: lack of nutrients)

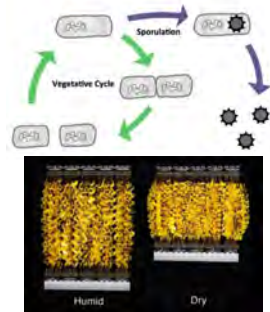

As **hygroscopic material** they respond to change in RH by expanding / shrinking anisotropically changing volume by 12%

<https://www.google.com/patents/US9234508>

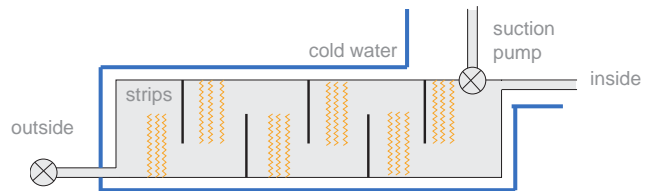

TYPICAL PLANTS



CAETANO, FERNANDO D. N., Influence of living walls on the thermal performance of buildings. 2014.

Humidity influence in North and West facades between 2% to 5%. Similar results you can find in Boa Sorte, Pedro D. 2016 and ALMEIDA, Marco A. M. 2008

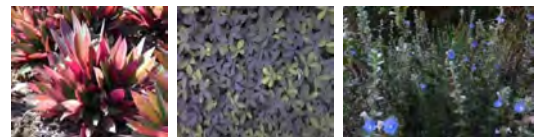
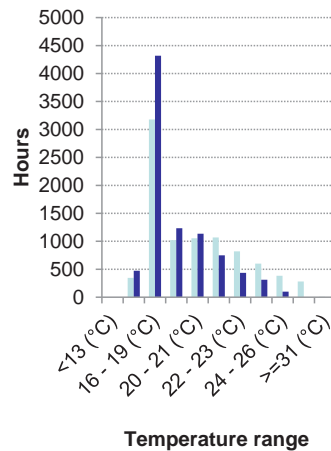

Tradescantia spathacea, Arachis repens, Evolvulus glomeratus

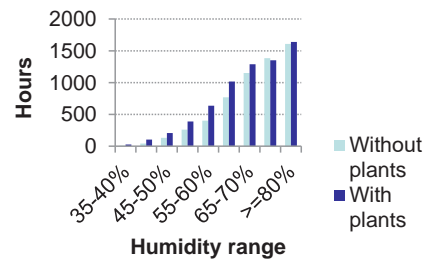

Case Study II: São Paulo – Team 6

► Olga Beatrice Carcassi, Hemshikha Saini, Mostafa Abdellatif, Diego Souza Caetano, Shawn Ives, Phan Anh Nguyen

RAIN WATER

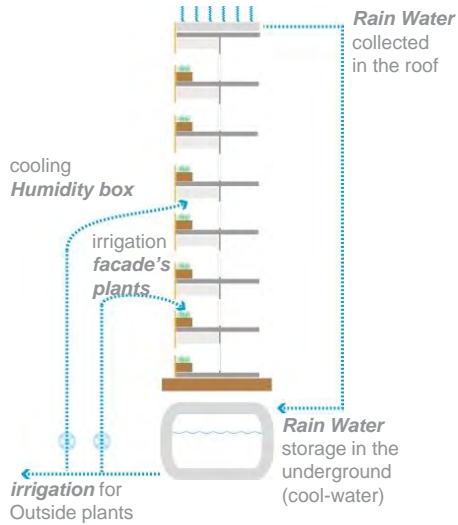

ENERGY PRODUCTION

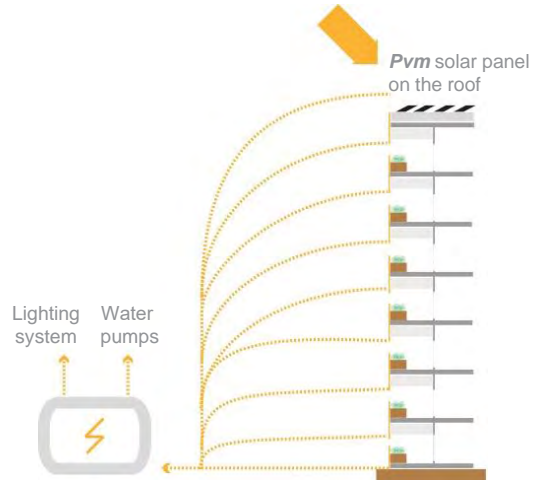

DEPOLLUTION WITH TITANIUM DIOXIDE (TiO₂) COATED GLASSES

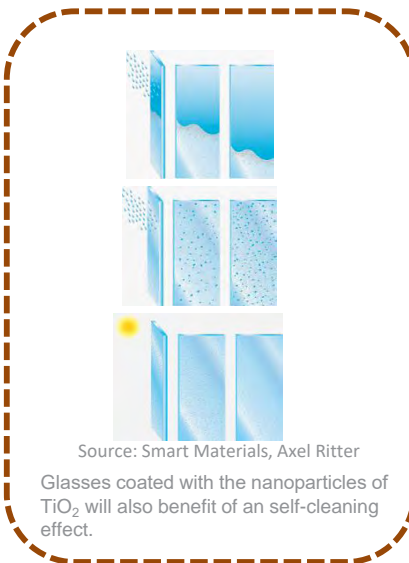
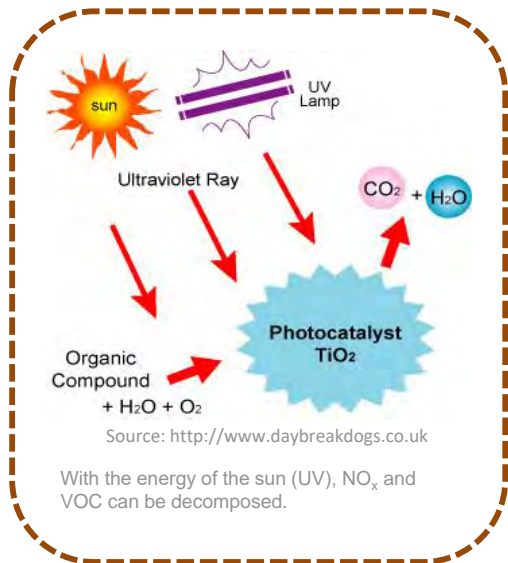

Around 50% of the NO_x and 70% of the Volatile Organic Compound (VOC) are decomposed

All the panels (except 50% of the northern facade) would be coated with TiO₂ as well as all the windows. All of this represents more than 8500m².

According on the weather conditions, this surface would have the capacity to eliminate more than 16 000m³ of each VOC per hour

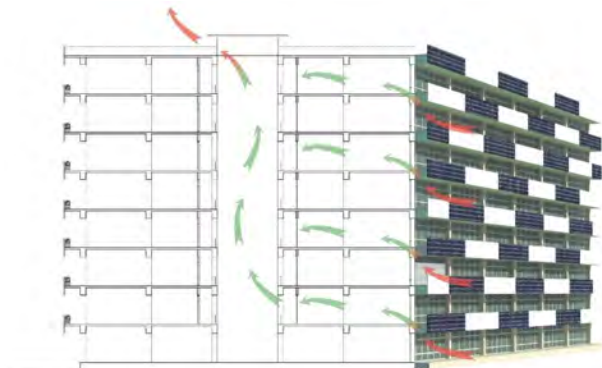

Case Study II: São Paulo – Team 8

► Aleksandra Milkova, Bader Alatawneh, Fernando Martin-Consuegra, Giuseppe De Michele, Liugi Giovannini, Yvonne Wattez

Architectural design concept

Building concept

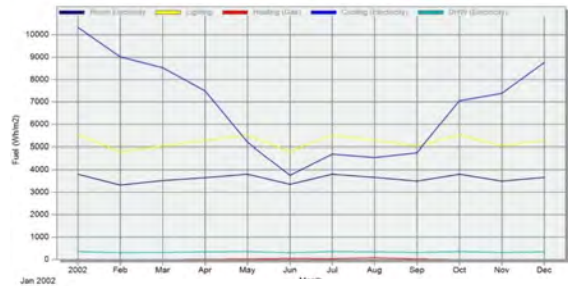
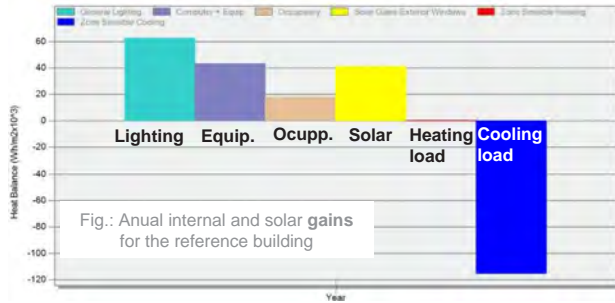
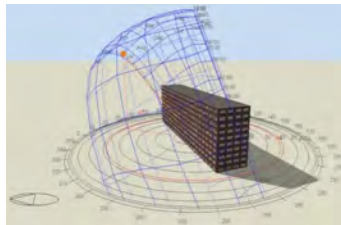

Fig.: Monthly fuel breakdowns for the reference building



Objectives

Humidity reduces cooling via evaporation as the air is already saturated, so by ventilating a space, the saturated air is removed.

1. Natural ventilation
2. Natural lighting
3. Solar shading



Facade concept



VENTILATION & HUMIDIFICATION

DAY

PCM cools air = moisture = absorption in ceramic tubes

NIGHT

Outside (colder) air charges PCM

- Outside: 80% RH → Goal inside: 50% RH
- Dehumidify 3,2 litres per office per day (ventilation for 3 persons)
- Absorption by ceramic: 30 tubes of 6 cm diameter per office

Case Study II: São Paulo – Team 8

► Aleksandra Milkova, Bader Alatawneh, Fernando Martin-Consuegra, Giuseppe De Michele, Liugi Giovannini, Yvonne Watez

SOLAR RADIATION

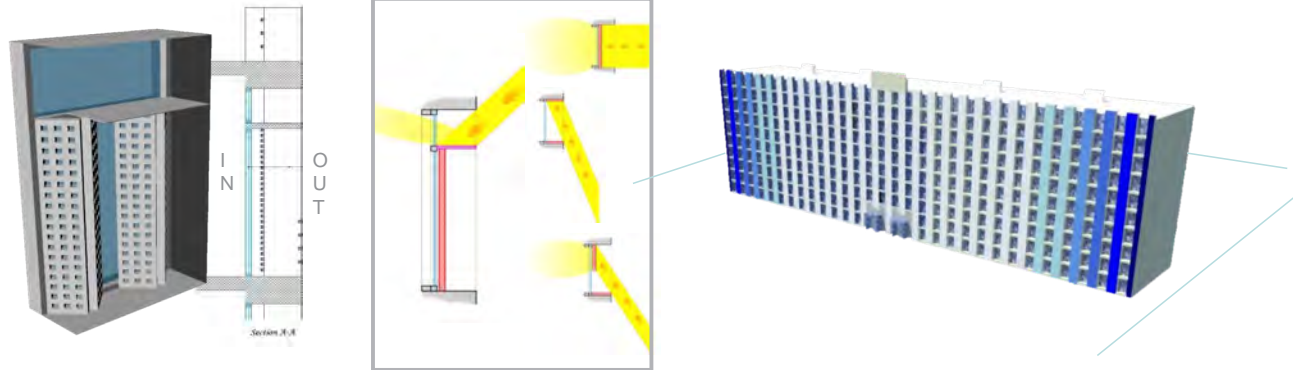

VISUAL COMFORT

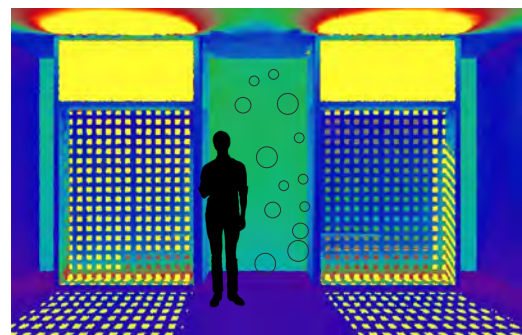
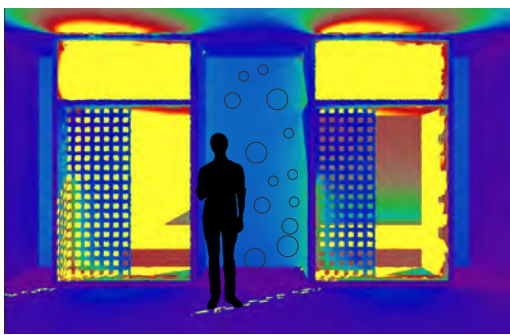

21 June, 10:00



21 June, 14:00

FINAL CONCEPT

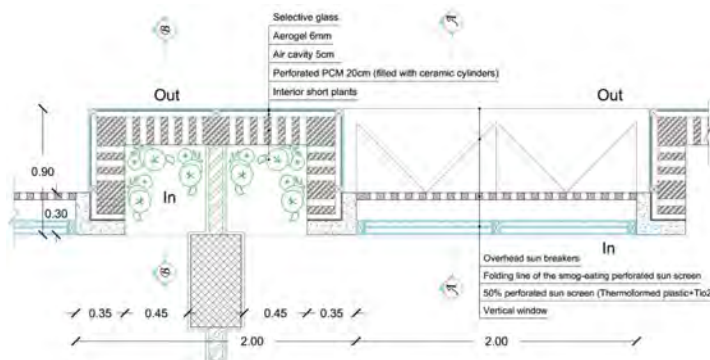

Workshop

Case Study III – Chicago

Case study 3 - Chicago

Layout 3 + Humid continental climate II

LOCATION: Chicago Ohare Intl Ap, IL, USA
Latitude/Longitude: 41.98° North, 87.92° West, **Time Zone** from Greenwich -6
Data Source: TMY3 725300 WMO Station Number, **Elevation** 201 m

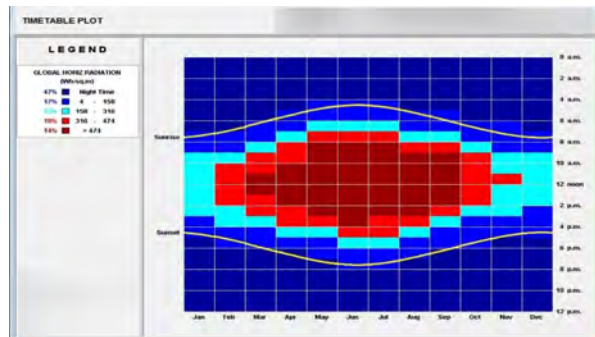
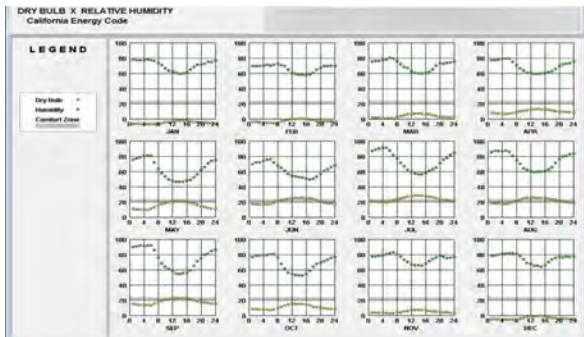
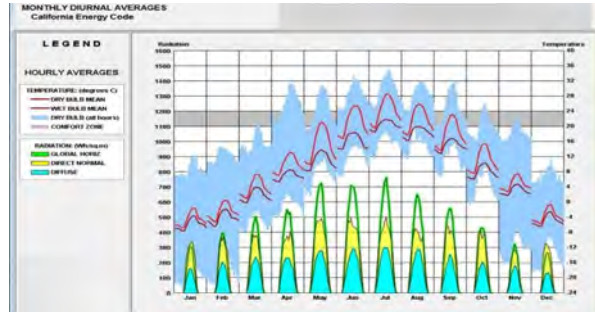
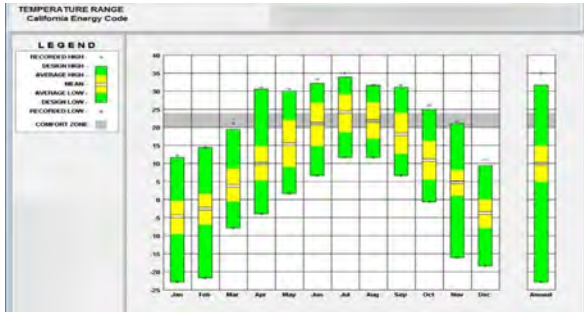

WEATHER DATA SUMMARY

MONTHLY MEANS

	JAN	FEB	MAR	APR	MAY	JUN	JUL	AUG	SEP	OCT	NOV	DEC	YEAR
Global Hourly Radiation (Avg Hourly)	389	343	392	552	624	629	620	540	370	270	289	287	419.6
Direct Normal Radiation (Avg Hourly)	232	229	289	527	587	547	529	429	289	188	216	216	319.6
Diffuse Radiation (Avg Hourly)	157	114	103	125	137	84	191	111	81	82	73	71	100.0
Global Hourly Radiation (Std Hourly)	313	257	289	523	584	580	583	523	331	217	260	257	419.6
Direct Normal Radiation (Std Hourly)	211	207	282	509	571	531	511	411	279	181	211	211	319.6
Diffuse Radiation (Std Hourly)	121	78	71	94	66	53	118	62	49	57	57	57	100.0
Global Hourly Radiation (Avg Daily Total)	1263	1093	1266	1764	1920	1920	1764	1422	1093	766	854	854	1500.0
Direct Normal Radiation (Avg Daily Total)	720	720	900	1620	1800	1620	1620	1260	854	540	630	630	1000.0
Diffuse Radiation (Avg Daily Total)	543	373	366	144	120	300	144	162	239	216	224	224	500.0
Global Hourly Illumination (Avg Hourly)	2026	1817	2173	3241	3640	3512	3241	2700	1817	1260	1360	1360	2500.0
Direct Normal Illumination (Avg Hourly)	1240	1236	1588	2732	3032	2732	2732	2160	1588	1032	1160	1160	1800.0
Diffuse Illumination (Avg Hourly)	786	581	585	509	508	300	509	270	239	228	200	200	700.0
Dry Bulb Temperature (Avg Monthly)	-4	-2	3	9	18	23	24	21	18	10	4	-5	10.0
Dew Point Temperature (Avg Monthly)	-8	-6	-5	3	7	12	13	12	12	8	5	2	6.0
Relative Humidity (Avg Monthly)	70	66	70	69	62	62	70	74	68	74	79	79	68.0
Wind Direction (Monthly Mean)	230	240	270	280	300	300	270	270	230	230	230	230	270.0
Wind Speed (Avg Monthly)	4	5	5	4	3	4	4	3	4	4	4	4	4.0
Ground Temperature (Avg Monthly @ 3 Depths)	2	0	1	2	6	12	17	18	15	10	5	2	6.0

Month	Jan	Feb	Mar	Apr	May	Jun	Jul	Aug	Sep	Oct	Nov	Dec	Year
Average precipitation inches (mm)	2.06	1.94	2.72	3.64	4.13	4.06	4.01	3.99	3.31	3.24	3.42	2.57	39.09
Average snowfall inches (cm)	-29.2	-23.1	-13.7	-2.5	0	0	0	0	0	-0.3	-3.3	-22.1	-94.2
Average precipitation days (≥ 0.01 in)	10.7	8.0	11.2	11.1	11.4	10.3	9.9	9	8.2	10.2	11.2	11.1	123.1
Average snowy days (≥ 0.1 in)	8.1	5.5	3.8	0.7	0	0	0	0	0	0.1	1.8	6.7	26.7

Case Study III: Chicago – Team 1

► Andjela Dubljevic, Giulia Grassi, Estefana Castaneda, Roman Baudisch, Victor Charpentier, Mohamed Soliman

Architectural design concept

Building concept

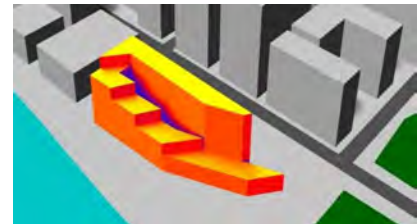
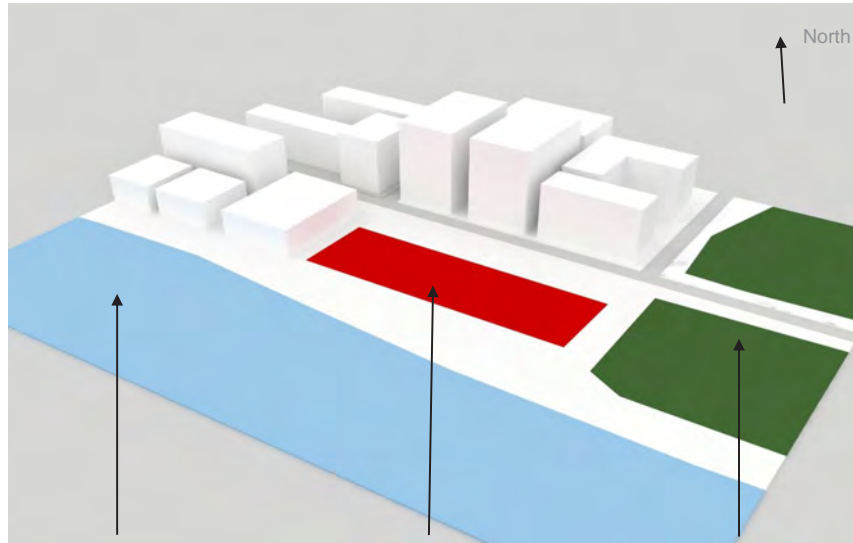

Option 1

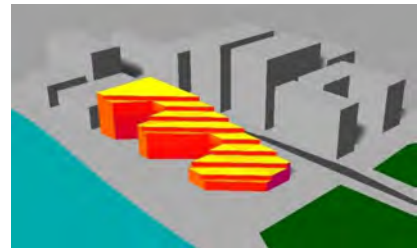

Option 2

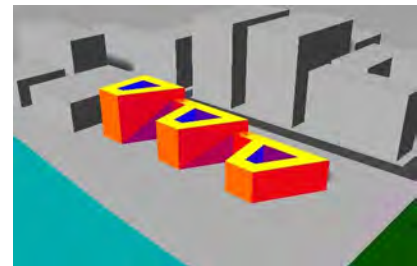

Option 3

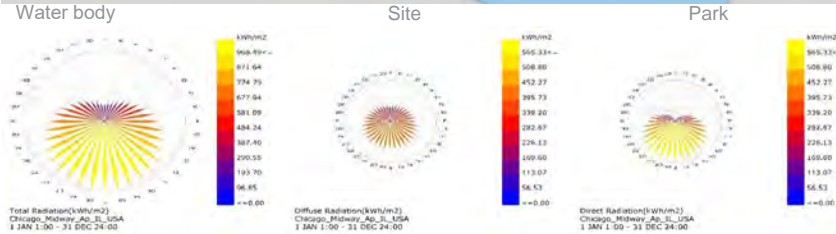

Radiation Rose

Summer

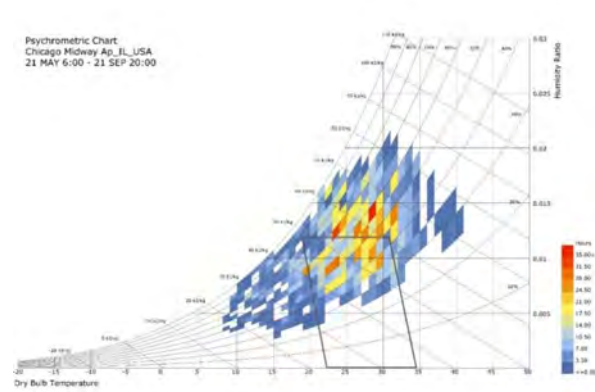

- Hot summer air temperature
- High relative humidity

Strategy:

- External shading system
- Using the water body for cooling of fresh air in the atrium
- Dehumidify air on cold surface of the cooling pipes

Winter

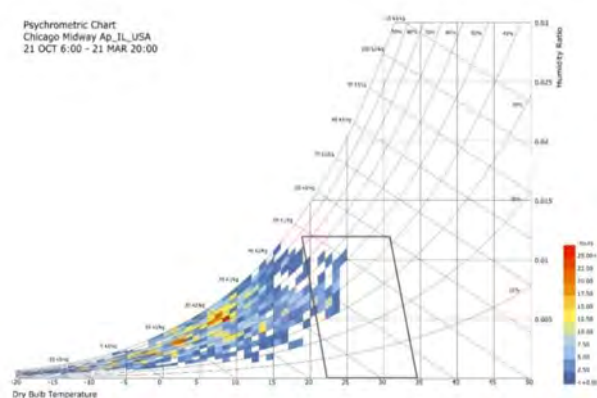

- Very cold air temperature

Strategy:

- Create a buffer zone in front of the facade to reduce energy consumption in the building
- Heat the fresh air before it enters the room

Case Study III: Chicago – Team 1

► Andjela Dubljevic, Giulia Grassi, Estefana Castaneda, Roman Baudisch, Victor Charpentier, Mohamed Soliman

Systems

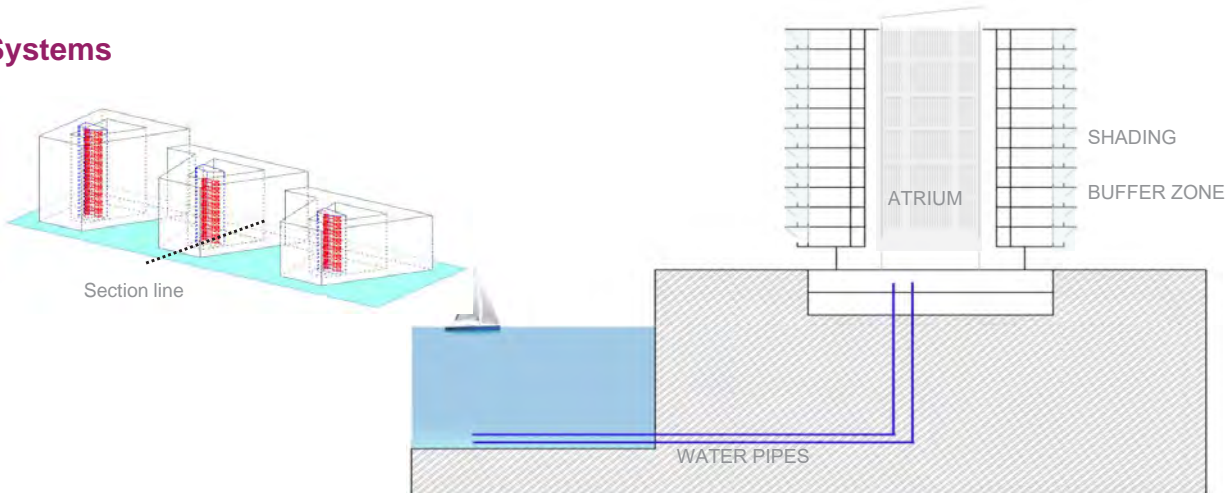

AIR FLOW

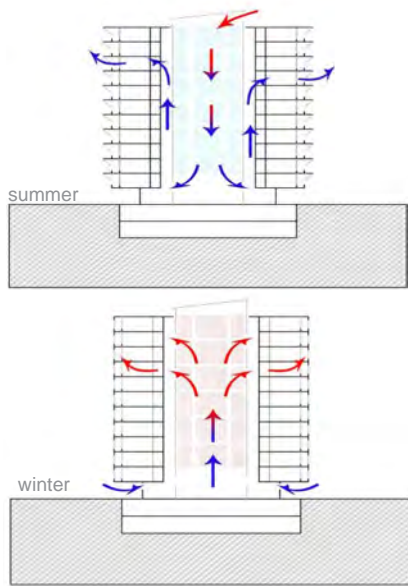

COOLING AND DEHUMIDIFICATION

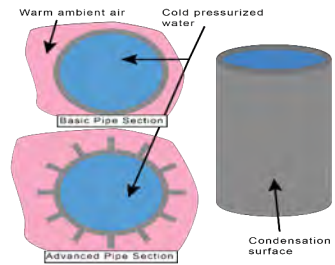
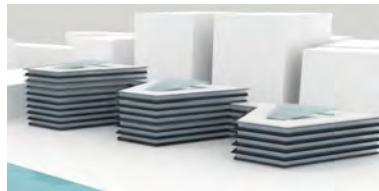

July In Chicago: extreme

$$T_{\text{dryBulb_avg}} = 24^{\circ}\text{C}$$

$$R_h = 74\%$$

Water extraction rate

bring R_h to 45%

1.5*V air flow

$$m_w = 828.5 \text{ kg/h}$$

SHADING AND BUFFER ZONE

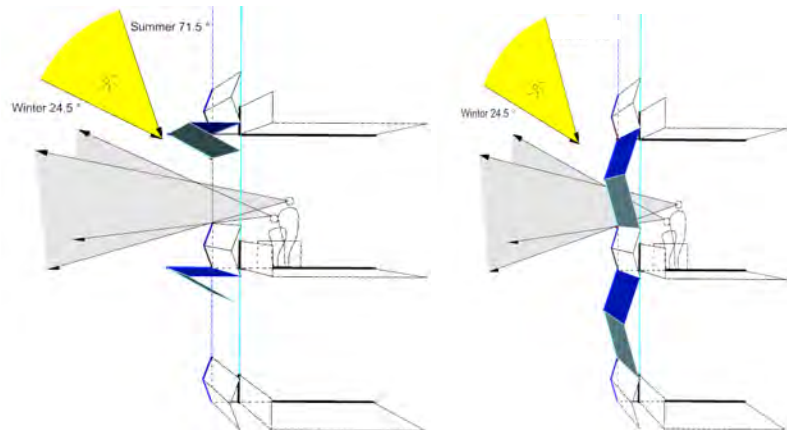
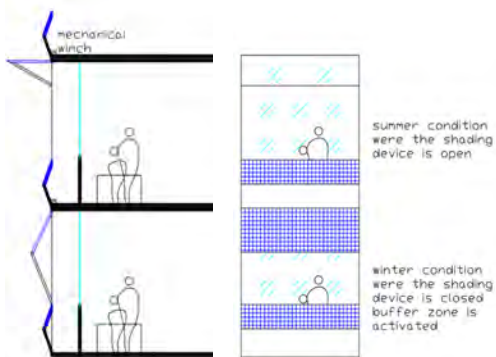

Case Study III: Chicago – Team 2

► Matthias Förch, Amin Fallahi, Mehul Koont, Júlia Pereria, Christoph Sousa, Ana Villaca

Architectural design concept

Building concept

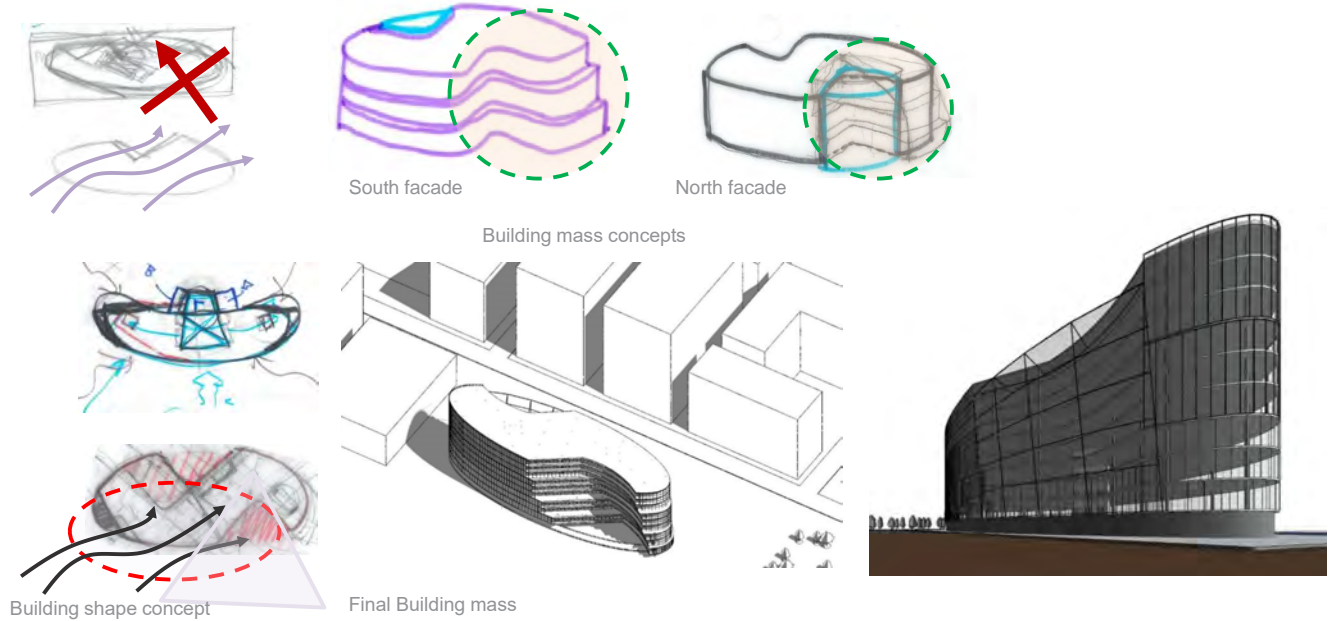

Energy concept – I

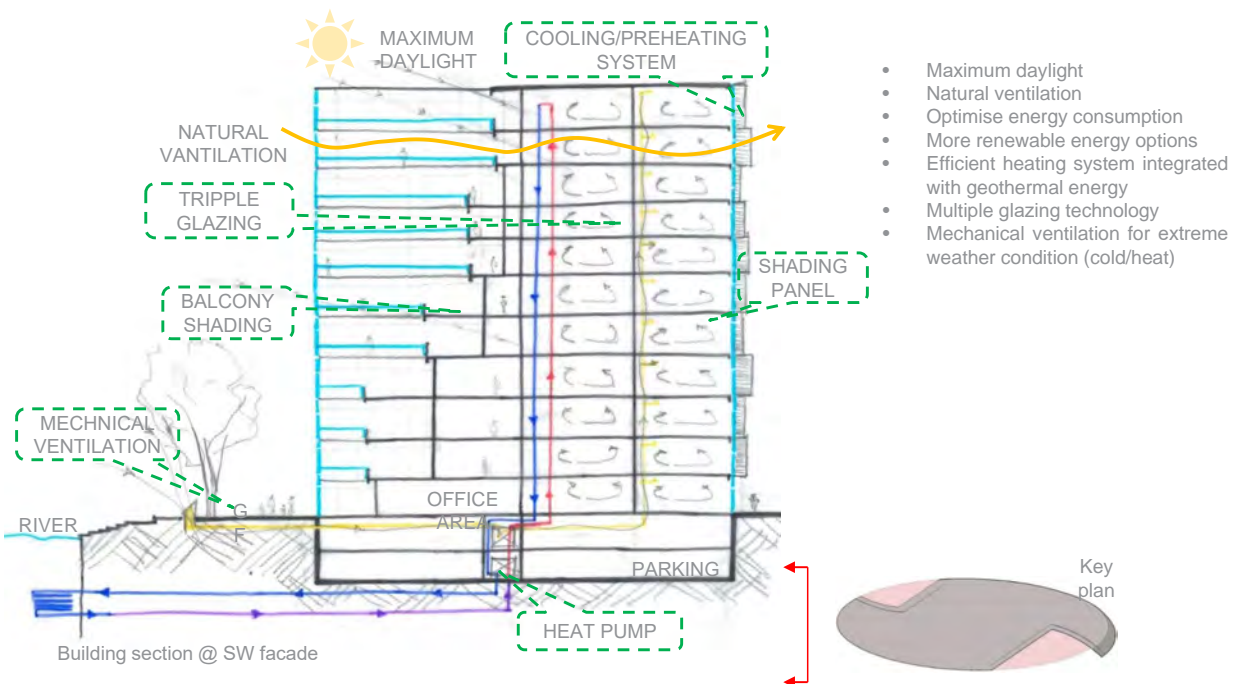

Case Study III: Chicago – Team 2

► Matthias Förch, Amin Fallahi, Mehul Koont, Júlia Pereria, Christoph Sousa, Ana Villaca

Enerav concept – II

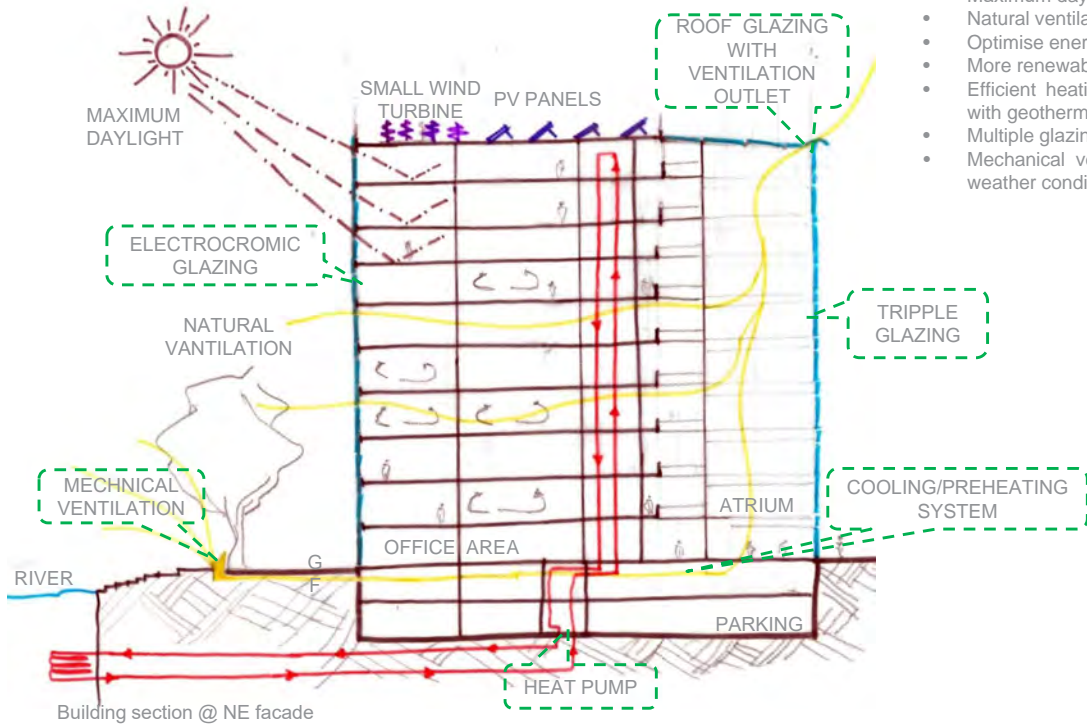

- Maximum daylight
- Natural ventilation
- Optimise energy consumption
- More renewable energy options
- Efficient heating system integrated with geothermal energy
- Multiple glazing technology
- Mechanical ventilation for extreme weather condition (cold/heat)

Core-façade solutions

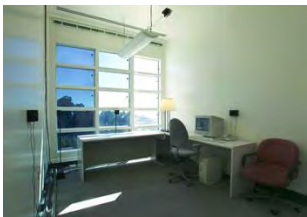
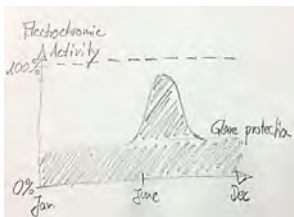

<https://windows.lbl.gov/news/article/11575/a-dawning-day-for-energy-efficient-electrochromic-windows>

- Increase solar gains performance;
- Avoid glare;
- Reduce energy consumption;
- Can be controlled by user's preferences or by a sunlight sensor;
- Privacy;
- Convenience;
- Cost intensive solution

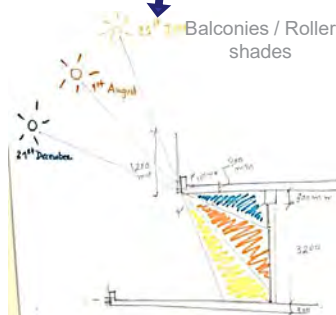
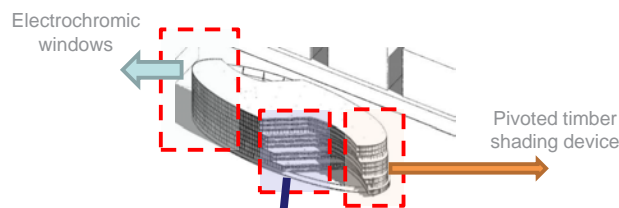

<http://www.groupdla.com.au/projects/enterprise-1-building/>



<https://deavita.com/wohnen/fenster-tueren/rollos-plissees-und-jalousien-sonnenschutz.html>

Case Study III: Chicago – Team 8

► Bahar Basarir, Beatriz Campos, Jakub Curpek, Aliakbar Kamari, Vlad Silvestru, Asli Tugrul

Architectural design concept

Building concept

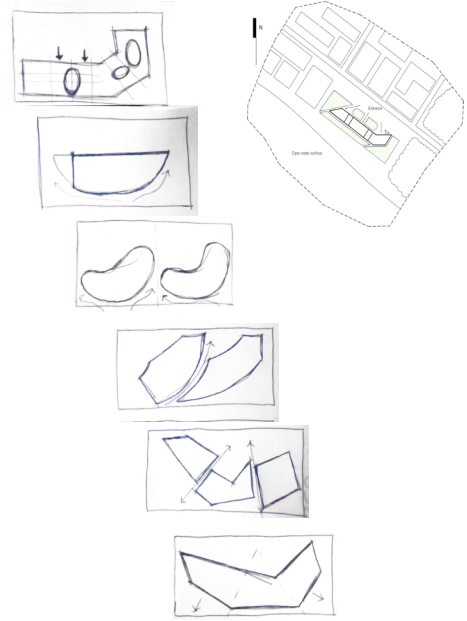
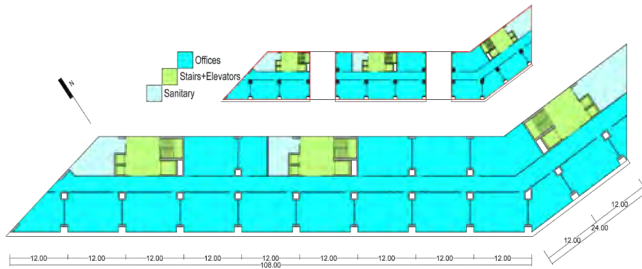

South-West Facade

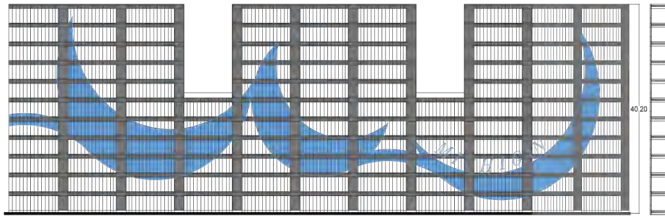

Façade concept - summer

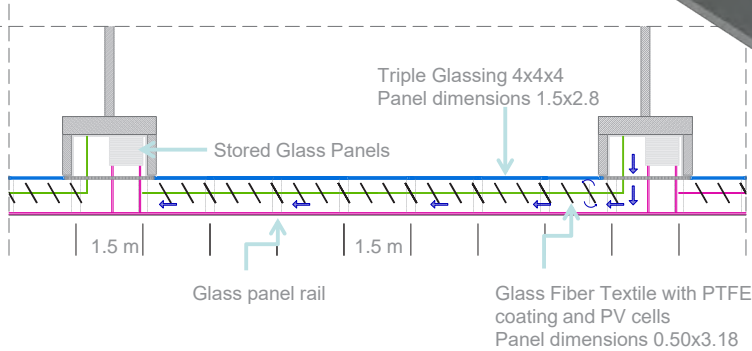
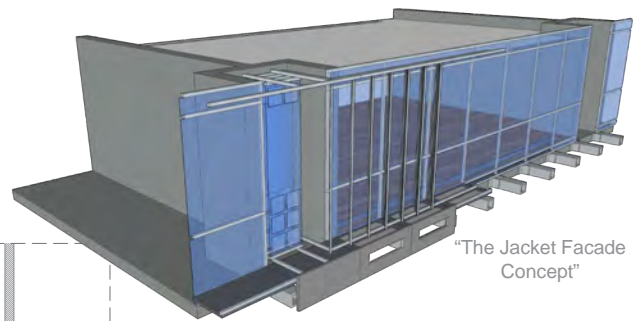
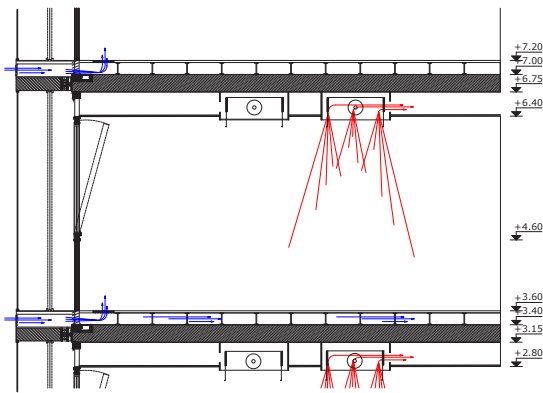

Case Study III: Chicago – Team 8

► Bahar Basarir, Beatriz Campos, Jakub Curpek, Aliakbar Kamari, Vlad Silvestru, Asli Tugrul

Façade concept - winter

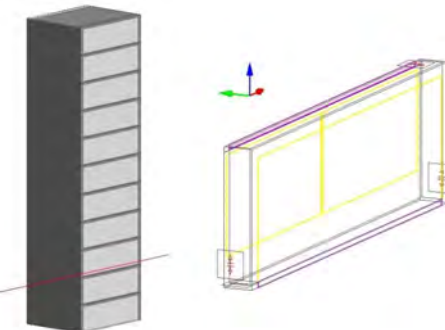
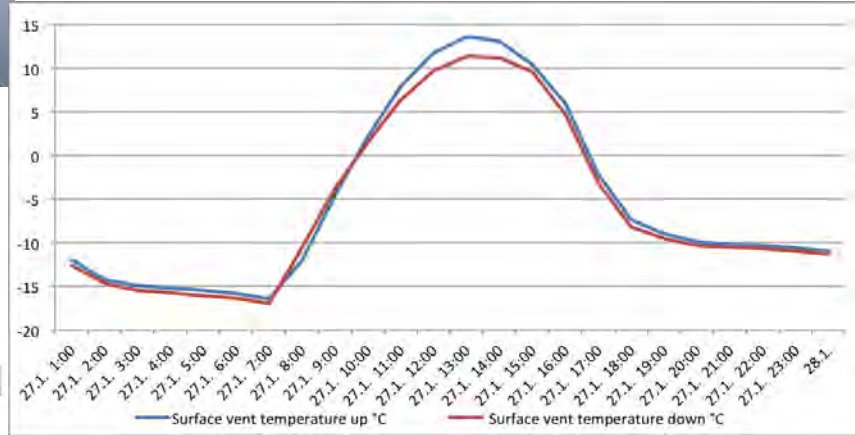
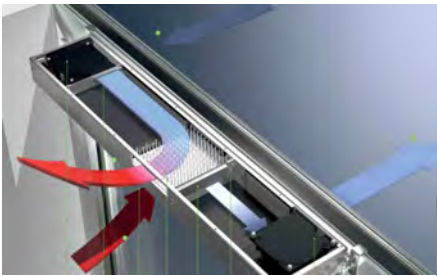
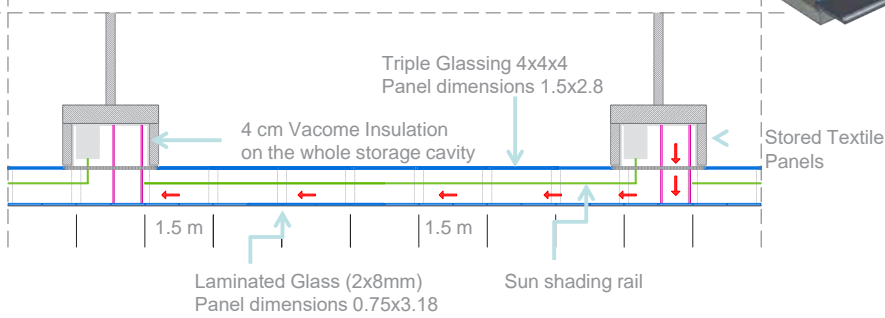
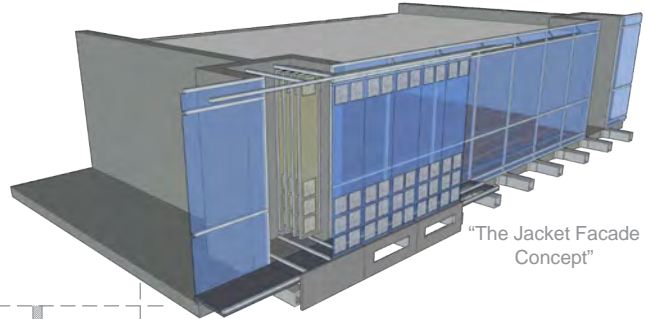
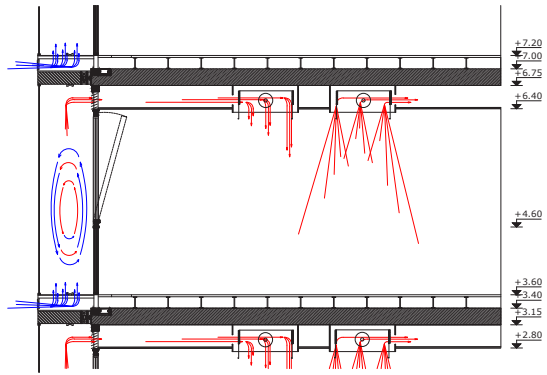



Belgrade city view

+ Training School 2018 Belgrade





Factory Berlin / Julian Breinersdorfer Architecture (image: M. Brzezicki)

Training School 2018 “Retrofitting Facades for Energy Performance Improvement”

Aleksandra Krstić-Furundžić

Introduction

Facades as part of the building envelope are considered to be the most important for achieving the proper indoor comfort, for reducing the consumption of energy from fossil fuels and thus the CO₂ emissions. The fact that newly constructed buildings represent a small percentage in relation to the total building stock indicates the importance of buildings refurbishment, while retrofitting of facades is crucial for energy performance improvement. Different refurbishment measures are available to improve thermal, light, acoustic and air comfort, as well as aesthetic values. Design of energy efficient buildings is based on achieving appropriate energy performances, i.e. energy savings and energy gains from renewable energy sources.

The point is to achieve active relationship between the building and the environment through the application of heating, cooling, ventilation and daylighting technologies that are based on natural forces (as pressure, temperature and moisture differences) and the use of renewable energy, thus reducing environmental pollution. Establishing active relationship between the building and its surroundings means adapting to natural and built environments, location; climate, annual and daily cycles (changes); various needs of users. In this respect, the concepts of adaptive facades have been developed and are constantly evolving.

One of the objectives of the project “Adaptive Facades Network” - COST Action TU1403, within the framework of European Cooperation in the field of Scientific and Technical Research, is to create the basis for exploiting recent technological developments in adaptive façades and energy efficient buildings, and to help train the future generation of façade R&D professionals in Europe. Therefore, 2nd Training School was organized by the COST Action TU1403 and the Faculty of Architecture, University of Belgrade.

The aim of the Training School “Retrofitting Facades for Energy Performance Improvement”, held in September 2018 at the University of Belgrade, Faculty of Architecture, was to educate students on adaptive facade systems and assess the possibilities of their application in façade retrofitting and resulting energy and environmental benefits. In the period of five days, from 03 to 07 September, the teaching process included a theoretical block and workshop (more detailed information about the content and organisation is given in the schedule). During the theoretical block, frontal lectures were held by 12 lecturers, experts in the fields related to innovative facades, from 8 universities from Europe, and five tutors helped the creative work of participants during the workshop. A total of 33 participants, PhD and Master students, from 17 European universities had the opportunity to learn more about the design phases for adaptive facade systems that included: Conceptual Design, Materials and Technologies; Performance Evaluation and Mock Ups & Testing and Modelling/ Numerical Simulation.



Figure 1 - TS 2018 Belgrade organisers and participants (image: A. Krstić-Furundžić)

The organizing committee included Prof. Dr. Aleksandra Krstić-Furundžić, the creator of the Training School 2018, and Ass. Prof. Dr. Budimir Sudimac.

The education process included the following steps:

- Lectures ex-cathedra on concepts and technologies of adaptive facades and façade retrofitting.
- Early stage investigators - ESI workshop. PhD and Master Students had the opportunity to discuss individual research topics within interdisciplinary teams.
- 3-day Workshop on the integration of innovative façade technologies into the building retrofitting.
- Two phases of project presentation in front of the critics and evaluation expert committee – concept presentation and final presentation.

A very intense week of lectures and workshops enabled participants to learn from professionals and colleagues, and meet fellow researchers from other European universities for networking.

Particular importance was given to social activities that included visit to locations selected for case studies (typical Belgrade office and residential building), sightseeing of several historical locations in the city center, welcome dinner, and Belgrade nightlife, guided by locals. This, like all other activities during the Training school, contributed to the strengthening of friendship and business relations among participants.

During the Workshop, participants developed concepts to improve the energy performances of facades of two post-war high-rise buildings in Belgrade and learned how these concepts can be validated and improved with actual simulation tools. The research and creative work of trainees was assisted by 6 trainers of different professional backgrounds, which additionally contributed to the multidisciplinary approach, which is generally considered essential in the design of innovative facades. The projects were presented in two phases to the critics. The first phase included presentation of the concept of improvement of the facade of the existing building with an explanation of the approach, various scenarios for facade improvement and criteria for decision

making, as well as the functional and visual characteristics of the selected solution. This allowed trainees to get additional suggestions for further project development. The second phase was the final presentation of the entire project, with technical solutions and energy performance analysis. The design solutions have been evaluated by the expert group. All participants received certificates for attending the Training School 2018 in Belgrade.



Figure 2 - Workshop Expert Committee

Practical work and research during the 3 days' innovative façade design workshop were organized through 7 workgroups-teams with members of different background (architecture, engineering, building physics), who have a research interest in facade design and engineering, and adaptive facades in particular. Under given design conditions, physical circumstances and technological constraints, using up-to-date knowledge, for certain types of buildings in Belgrade, facade improvement has been created in order to achieve better functional, energy and environmental effects. The trainees have expressed a responsible approach in considering the issue of keeping or replacing the existing façade and proving their attitudes.

One of the objectives of the project "Adaptive Facades Network" - COST Action TU1403, within the framework of European Cooperation in the field of Scientific and Technical Research, is to create the basis for exploiting recent technological developments in adaptive façades and energy efficient buildings, and to help train the future generation of façade R&D professionals in Europe. Therefore, 2nd Training School was organized by the COST Action TU1403 and the Faculty of Architecture, University of Belgrade.

Case Studies

Case study I - The task was to create a facade improvement of the "Beogradjanka" office building for a typical office area at the height of one floor using the concept of an adaptive facade. The building is located in the central zone of Belgrade, and it can be considered as one of the recognizable symbols of the city. It is high-rise stand-alone building with glass suspended façade (curtain wall), built in the post-war period 1969 - 1974.

Case study II - The task was to create an improvement of the facade of one of the three residential buildings called the East Gate of Belgrade, Rudo, for the proposed floor at the height of one floor using the concept of an adaptive facade. These high-rise stand-alone buildings are located in the suburban settlement Konjarnik and represent a benchmark when entering the city from the eastern direction of the highway. The buildings are constructed in the post-war period 1973 - 1976 and have a reinforced concrete prefabricated structure and reinforced concrete precast facade parapets.

	Morning 9:00-11:00			11:00-11:30		11:30-13:00		13:00-14:00		Afternoon 14:00-16:00		16:00-16:30		16:30-18:30		Evening 20:00-23:00		
Monday	Room 200	Registration 8:30-9:00	Room 200	Aleksandra Krstić-Furundžić Welcome and an introduction to the Training School program Marcin Brzeziński Adaptive Facade Concept and Typologies, Kinetic Facades (WG 1) (45 min) Mireen Juaristi Gutiérrez Smart and Multifunctional Materials and their possible application in facade systems (WG 1) (45 min)	Room 254	Coffee break	Room 200	Mark Alston Climate Adapted Facades for Belgrade (WG 1) (45min) Aleksandra Krstić-Furundžić Building refurbishment in the context of adaptive facades (WG 1) (20 min) Budimir Sudimac Green wall systems for energy savings in buildings (WG 1) (20 min)	Room 254	Lunch break	Room 200	Thaella Konstantinou ESI Workshop and Teambuilding Part 1 PhD/Master Posters/progress reports discussion of individual themes/topics in interdisciplinary teams (same teams as for the workshop)	Room 254	Coffee break	Room 200	Thaella Konstantinou ESI Workshop and Teambuilding Part 2 PhD/Master Posters/progress reports discussion of individual themes/topics in interdisciplinary teams (same teams as for the workshop)		
Tuesday	Room 200	Mislav Stepić Structural Concepts for Adaptive Facades (WG 2) (45 min) Chiara Bedon Structural aspects & case studies (WG 2) (45 min)	Room 254	Coffee break	Room 200	Roman Rabenseifner Post-occupancy Performance Evaluation (WG 3) (45 min)	Room 254	Lunch break	Room 200	Fabio Favoino Performance - Time conscious building envelopes (WG 2) (60min) Aleksandra Krstić-Furundžić, Budimir Sudimac, Nikola Blacot Information on site visit-Definition and scope of the workshop	Room 254	Coffee break 15:15-15:30	Excursion ALL Visit to locations for case studies - typical Belgrade office and residential building 15:30-20:00			Welcome dinner		
Wednesday	Rooms 217, 218, 219, 220	Workshop "Retrofitting Facades for Energy Performance Improvement" Task: Definition and consideration of facade concept / Working in Groups Support by trainers: Marcin Brzeziński, Riccardo Pinotti, Nikola Perković, Aleksandra Krstić-Furundžić, Budimir Sudimac, Djordje Stojanović Room 254 - Coffee break - 11:00-11:30	Room 254	Lunch break	Room 217, 218, 219, 220	Workshop "Retrofitting Facades for Energy Performance Improvement" Task: Definition and consideration of facade concept / Working in Groups/ Support by trainers: Marcin Brzeziński, Riccardo Pinotti, Nikola Perković, Aleksandra Krstić-Furundžić, Budimir Sudimac, Djordje Stojanović Room 254 - Coffee break - 16:00-16:30	Room 200	Concept presentation Task: 10 min each group with external critics: Jelena Ivanović-Šekularac, AF-BU, Belgrade and Anica Dragutinović, hs-oel Detroid										
Thursday	Room 218	Riccardo Pinotti Building modelling using Tsmays software	Room 254	Coffee break	Room 217, 218, 219, 220	Workshop "Retrofitting Facades for Energy Performance Improvement" Task: Elaboration of facade concept by digital simulation and modelmaking / Working in Groups Support by trainers: Marcin Brzeziński, Riccardo Pinotti, Nikola Perković, Aleksandra Krstić-Furundžić, Budimir Sudimac, Djordje Stojanović	Room 254	Lunch break	Room 217, 218, 219, 220	Workshop "Retrofitting Facades for Energy Performance Improvement" Task: Elaboration of facade concept by digital simulation and modelmaking / Working in Groups Support by trainers: Marcin Brzeziński, Riccardo Pinotti, Nikola Perković, Aleksandra Krstić-Furundžić, Budimir Sudimac, Djordje Stojanović Room 254 - Coffee break - 16:00-16:30								
Friday	Rooms 217, 218, 219, 220	Workshop "Retrofitting Facades for Energy Performance Improvement" Task: Detailed elaboration of the facade concept and preparation of the final presentation / Working in Groups Support by trainers: Marcin Brzeziński, Riccardo Pinotti, Nikola Perković, Aleksandra Krstić-Furundžić, Budimir Sudimac, Djordje Stojanović Room 254 - Coffee break - 11:00-11:30	Room 254	Lunch break	Room 217, 218, 219, 220	Workshop "Retrofitting Facades for Energy Performance Improvement" Task: Detailed elaboration of the facade concept and preparation of the final presentation / Working in Groups Support by trainers: Marcin Brzeziński, Riccardo Pinotti, Nikola Perković, Aleksandra Krstić-Furundžić, Budimir Sudimac, Djordje Stojanović Room 254 - Coffee break - 16:00-16:30	Room 218	Final public presentation of the results of the Workshop 10 min each group with external critics: Jelena Ivanović-Šekularac, AF-BU, Belgrade and Anica Dragutinović, hs-oel Detroid								Time for party. See the Belgrade nightlife, guided by locals.		

Figure 3 - TS 2018 Belgrade schedule



Figure 4 - Photo documentation of the Lectures (images: A. Krstić-Furundžić)



Figure 5 - "Beogradjanka" office building, Case Study I

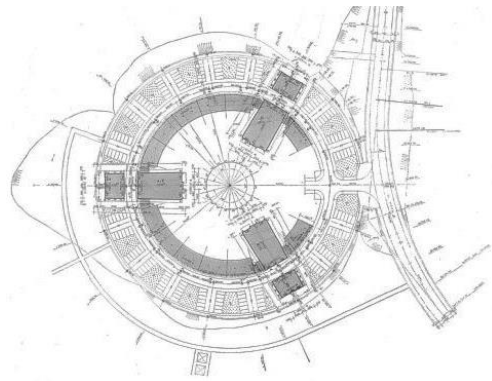

Figure 6 - East Gate of Belgrade, Rudo, residential building, Case Study II

Conclusions

The process of designing the improvement of the facade implied several stages. On the first day of the Workshop, the existing situation, limitations and disadvantages were considered, and the concepts of facade with the integration of innovative facade technologies were defined and discussed. The next two days were dedicated to the elaboration of new facade concepts by digital simulation and modelling, as well as numerical simulations to verify the energy consumption for heating and cooling. In the case of a business building, it can be noticed that some of the teams took into account the fact that the building is one of the symbols of the Moderna period with dark color and hexagonal shape, and therefore proposed a replica of the existing facade using innovative technologies. On the contrary, there was a vision that the existing facade should be completely replaced with a new innovative concept. Both approaches have resulted in interesting and realistic solutions with positive effects. In the case of a residential building, the improvement of the existing facade is considered suitable and the application of adaptive systems as a preferred solution in order to improve the energy performance and appearance of the building.

The overall/general impression is that trainees through their projects have shown a significant understanding of the design issues of innovative facades. A very balanced quality of projects has made the selection of the best proposals complex, but three projects have been awarded, among which are two proposals for improving the facade of the office building and one for the residential building.



OP Financial Group Vallila Campus / JKMM Architects (image: M. Brzezicki)



Figure 7 - Photo documentation of the Workshop (images: A. Krstić-Furundžić)



Figure 8 - Photo documentation of the Social events – Lunches and Welcome dinner (images: A. Krstić-Furundžić)

Team 1



Team 2



Team 3



Team 4



Team 5



Team 6



Team 7



Awarded workgroups - teams:

- Team 7 – Retrofitting the façade of the office building
- Team 1 – Retrofitting the façade of the office building
- Team 4 – Retrofitting the façade of the residential building

Figure 9 - Members of each team for the design work (images: A. Krstić-Furundžić)

Table 1 - Workgroups - Teams

Case study I – Office building		
Team 1	Ahmed Felimban Ali Aghazadeh Ardebili Martina Di Bugno Magdalena Patrus Nevena Lukić	Delft University of Technology, Netherlands University of Trieste, Italy University of Pisa, Italy University of Bath, United Kingdom University of Belgrade, Faculty of Architecture, Serbia
Team 2	Tiantian Du Marina Bagarić Zein Omar Arqoub Al-Doughmi Cecillie Gry Jacobsen	Delft University of Technology, Netherlands University of Zagreb, Faculty of civil engineering, Croatia Cardiff University, United Kingdom The Royal Danish Academy of Fine Arts, School of Architecture (KADK), Denmark
Team 5	Aleksandra Ugrinović Dijana Savanović Mariana Velasco Carrasco Paolo Bonato Yeşim Keskinel	University of Belgrade, Faculty of Architecture, Serbia University of Belgrade, Faculty of Architecture, Serbia University of Nottingham, United Kingdom Energy Engineering, Politecnico di Milano, Italy Izmir Institute of Technology, Turkey
Team 6	Ana Kontić Milan Varga Valentina Frighi Michael Michalis	University of Belgrade, Faculty of Architecture, Serbia University of Belgrade, Faculty of Architecture, Serbia University of Ferrara, Department of Architecture, Italy University of Cambridge, United Kingdom
Team 7	Miroslav Vulić Neda Džombić Yorgos Spanodimitriou Mohataz Hossain	University of Belgrade, Faculty of Mechanical Engineering, Serbia University of Belgrade, Faculty of Architecture, Serbia University of Campania "Luigi Vanvitelli", Italy University of Nottingham, United Kingdom
Case study II – Residential building		
Team 3	Federico Bertagna Ariadna Carrobé Montalvo Juan Manuel Cruz Nikola Macut Mirjana Miletić	University of Pisa, Italy University of Lleida, Spain Norwegian University of Science and Technology (NTNU), Norway University of Belgrade, Faculty of Architecture, Serbia University of Belgrade, Faculty of Architecture, Serbia
Team 4	Jorge Luis Aguilar-Santana Anka Mirković Berk Ekici Milica Petrović Ashal Tyurkay	University of Nottingham, United Kingdom University of Belgrade, Faculty of Architecture, Serbia Delft University of Technology, Netherlands University of Belgrade, Faculty of Architecture, Serbia University of Antwerp, Belgium

Case Study: Office building

► Ahmed Felimban, Ali Aghazadeh Ardebili, Martina Di Bugno, Magdalena Patrus, Nevena Lukic

PROJECT DEVELOPMENT PROCESS

Location

- High-rise commercial unit located in central Belgrade
- Semi-dense urban environment
- The tallest building in the city

Limitations and decisions

- Maintain the form
- Sustain the uniformity
- Maintain the materiality (dark colours to follow the initial architectural concept of a *black building in the 'White City'*)
- Maintain the prominence of the building on the city's skyline
- Sustain and highlight the historical value fo the building
- Holistic approach to accommodate and address the existing conditions

Façade concept

- Address the prevailing winds → E-W axis orientation optimal for natural ventilation
- Maximize solar gains in the winter
- Control glare
- Solar control on southern-oriented facades
- Heat loss prevention
- Improved insulation inside the cladding panels

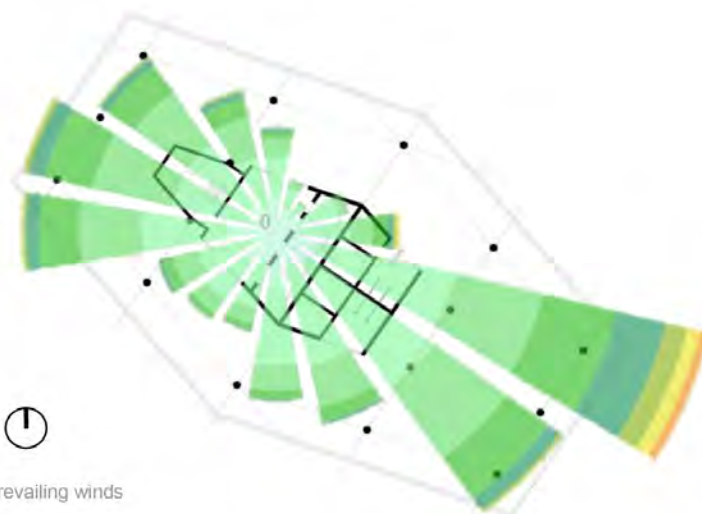

Cloudy, sunny, and precipitation days

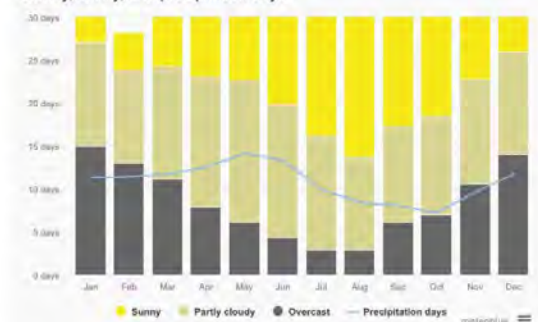

Average temperatures and precipitation

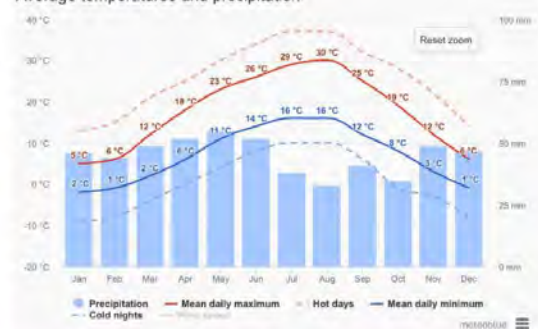

Option 1: improving the fabric of the existing facade

- Maintained form & structure of the building
- Cost-effective solution
- Minimized construction waste
- Less controversial solution
- Minimal potential for operational issues

Improved energy efficiency

Option 2: new facade fabric with kinetic shading

- Innovative & trendy solution
- More cost-imposed
- Construction waste generation
- Potential for better solar control in summer
- Operational & installation issues
- Uncertainty of the performance

- Psychometric analysis to investigate optimal indoor environmental conditions:

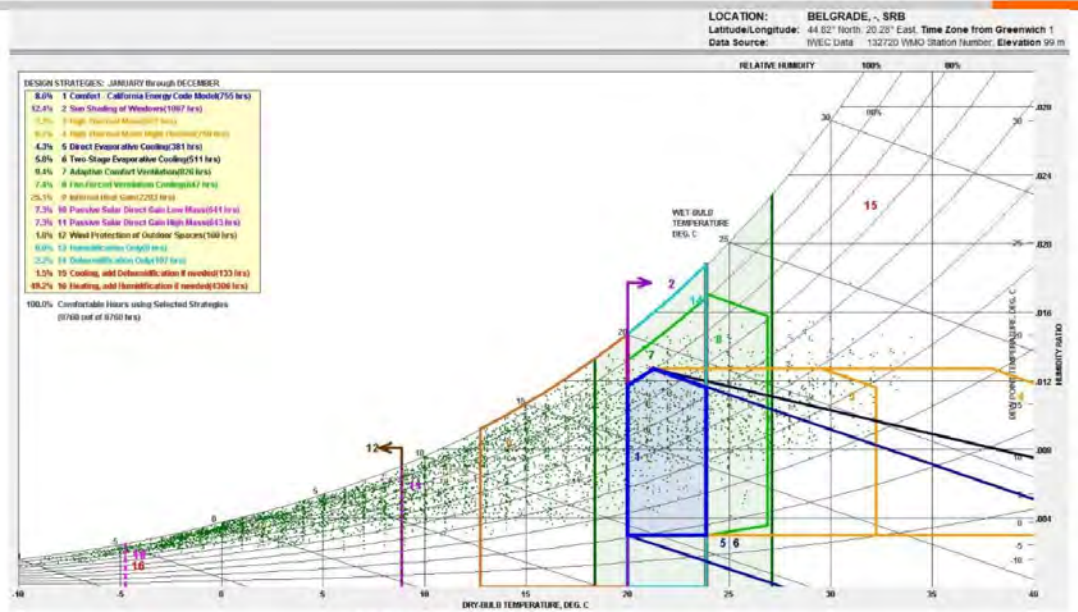

Summer behaviour



Double skin facade:

- Buoyancy driven cooling
- Solar stack extract

Winter behaviour



Double skin facade:

- Pre-heated ventilation, buoyancy driven
- Thermal buffer

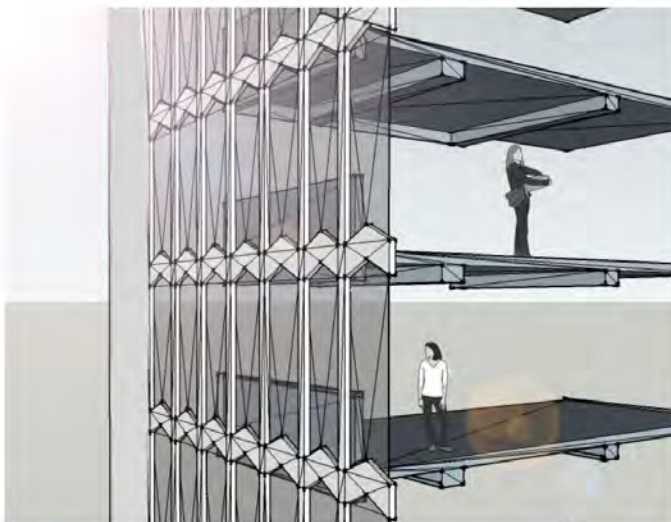

Case Study: Beogradjanka

► Authors: Taintain Du, Marina Bagaric, Zein Al-Doughmi, Cecilie Gry Jacobsen

Façade concept

By trying to cool the building in summer and heat in winter, a combination of different strategies were used:

- Stack effect in double skin facade
- Night purge
- Adaptive shading
- PCM materials placed in suspended ceiling

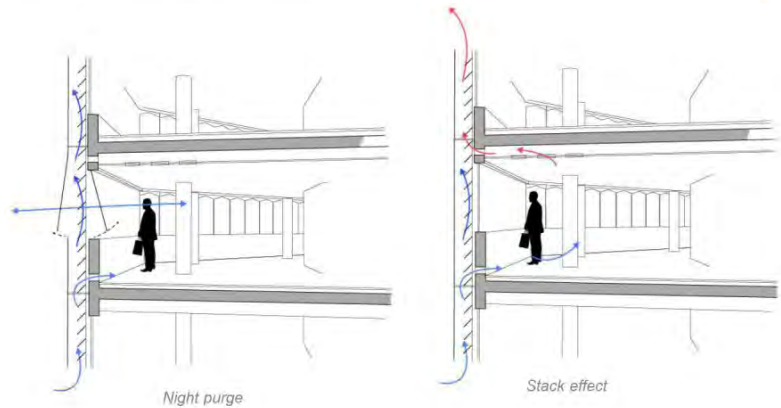

Shading

Density of movable blinds

- High density of Horizontal blinds
- Less density of horizontal blinds

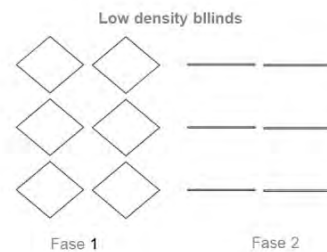
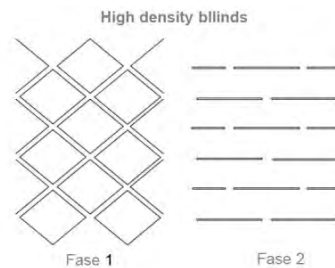
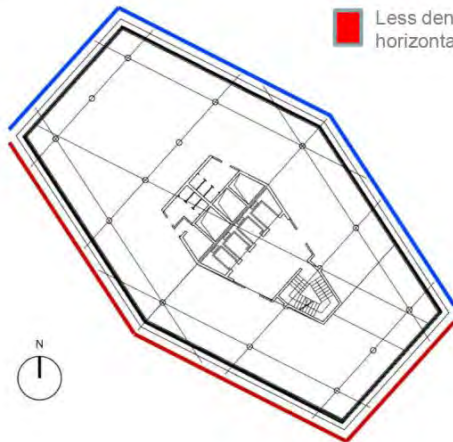

Summer behavior

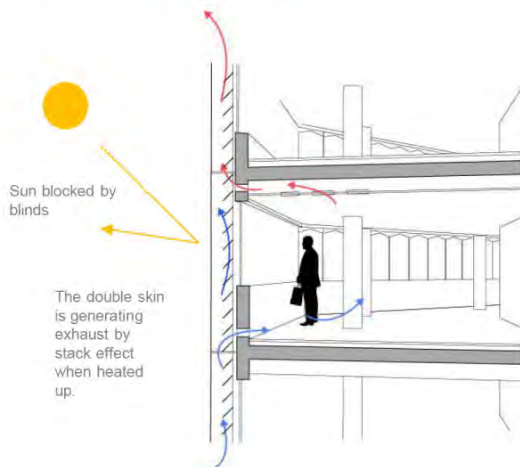

Winter behavior

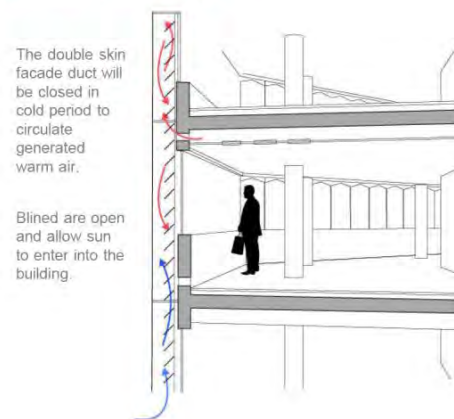

Case Study: Beogradjanka

► Authors: Taintain Du, Marina Bagaric, Zein Al-Doughmi, Cecilie Gry Jacoben

Façade adaptivity

As one of the features of adaptivity, blinds within the double facade cavity is placed to give the user a possibility to block out the sun. The blinds also functions as a mean to reflect the daylight into the room

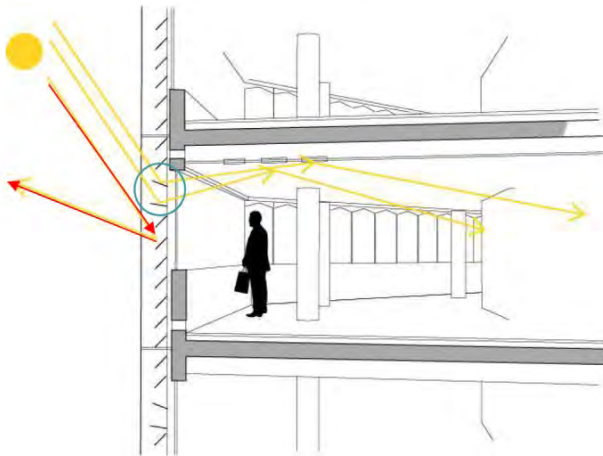

The reflection of light into the room

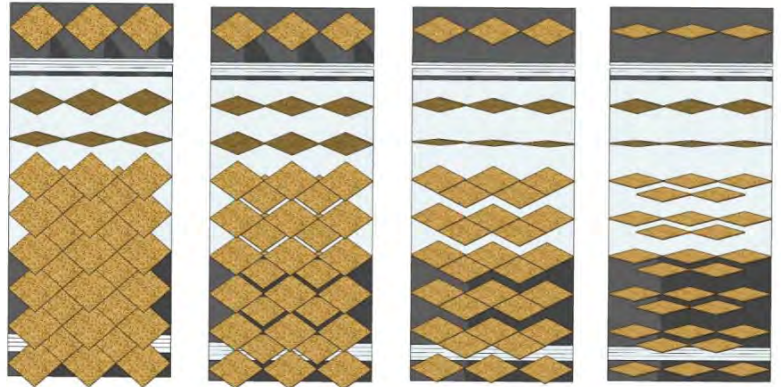

The different positions of the horizontal blinds



Material references: PVDF aluminium

Technical details

- Thickness of air cavity: 40cm - 50cm (Reference: „Double skin façades – cavity and exterior openings dimensions for saving energy on Mediterranean climate“)

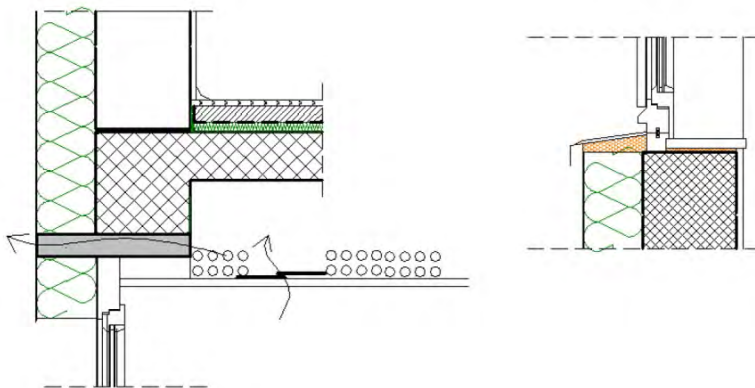

Details of window-wall connection (minimization of thermal bridges) and PCM material location in suspended ceiling for passive maintenance of indoor air temperature

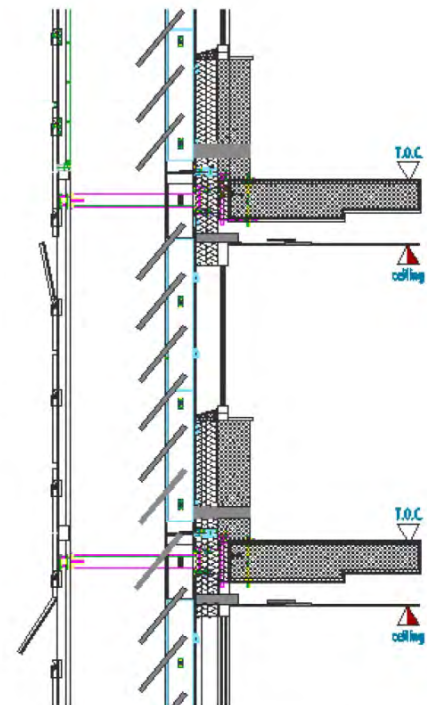

Detail of double-facade supporting structure

Case Study: Belgrade Istocna Kapija

► Federico Bertagna, Ariadna Carrobé, Juanma Cruz, Nikola Macut, Mirjana Miletić

PROJECT DEVELOPMENT PROCESS

Location

The case study building is called Eastern City Gate and it is located in the Konjarnik district in Belgrade, Serbia.



The complex is composed of three residential buildings. For this case study, the south facing building was investigated.

Climate and decision



Source: Eotect - Weather tool

As shown in the graph above, during winter the temperature in Belgrade decreases up to -10°C . Since the thermal insulation properties of the external walls in the current condition proved to be rather poor, in order to prevent excessive thermal losses through the envelope, there is the need to implement some passive systems. On the contrary, during summer, the uncontrolled solar radiation that enters the building is possibly the main cause of overheating issues. An external shading system can represent a simple yet effective solution to this problem.

According to the climate data, solar and wind analysis, two solutions are proposed in order to improve the current situation in terms of energy performances and user comfort.

The first is based on the improvement of the thermal insulation properties of the building envelope; the second one is the inclusion of an adaptive façade system where simple rectangular louvers can slide and rotate along the windows depending on the sun position during the day.

Façade concept

Current situation

The window to wall ratio in the building is about 50%. The external layer is made of concrete and only 5 cm of polystyrene is installed in some parts of the external wall as an insulating layer. Most of the windows have wooden frames and a double glass layer.

Type	Composition	Total Thickness (cm)	U value (W/m ² *K)	Gas
Window	Outer Pane / Cavity / Inner Pane	24	1,9326	Air
WALL Type 2	Reinforced Concrete / Polystyrene / Reinforced Concrete	12	3,8917	-
WALL Type 2	Reinforced Concrete	200	0,5294	-

Proposed solution

Description	Serbian Law U (W/m ² K) / ACh	EnerPHit/EnerPHit+ U (W/m ² K)
External wall	≤ 0,4	≤ 0,15
Ground floor	≤ 0,4	≤ 0,15
Roof	≤ 0,2	≤ 0,15
Windows	≤ 1,5	≤ 0,85
Internal walls and floor construction	≤ 0,9	≤ 1,0

According to the Serbian regulations, all renovated buildings must improve their energy efficiency by a minimum of one degree. In addition, an upper threshold for the U-value of each constructive element is prescribed.

Type	Composition	Total Thickness (cm)	U value (W/m ² *K)	Gas
Window	Three glass	8	0,789	Argon
WALL Type 1	Reinforced Concrete / Polystyrene / Mineral Fibre slab	230	0,2942	-
WALL Type 2	Reinforced Concrete / Polystyrene / Cellular polyurethane	270	0,1667	-
WALL Type 3	Rock wool / Concrete Cast	150	0,288	-

One type of window is proposed, whose U-value meets the requirements of both Serbian and EnerPHit parameters. As for the walls, three different types have been tested. As shown in the table, the best insulation material is the Polystyrene, but taking into account the properties in terms of sustainability, rock wool will be used instead.

Case Study: Belgrade Istocna Kapija

Federico Bertagna, Ariadna Carrobé, Juanma Cruz, Nikola Macut, Mirijana Miletec

Façade adaptivity

Adaptive Element: vertical louvers

Materials: steel frame + PVC mesh

Width: 0.3m | Angle of rotation: various ($\pm 90^\circ$)

Mechanism of Adaptation: rotation along axis

Softwares: Rhinoceros 3D, Grasshopper, Ladybug

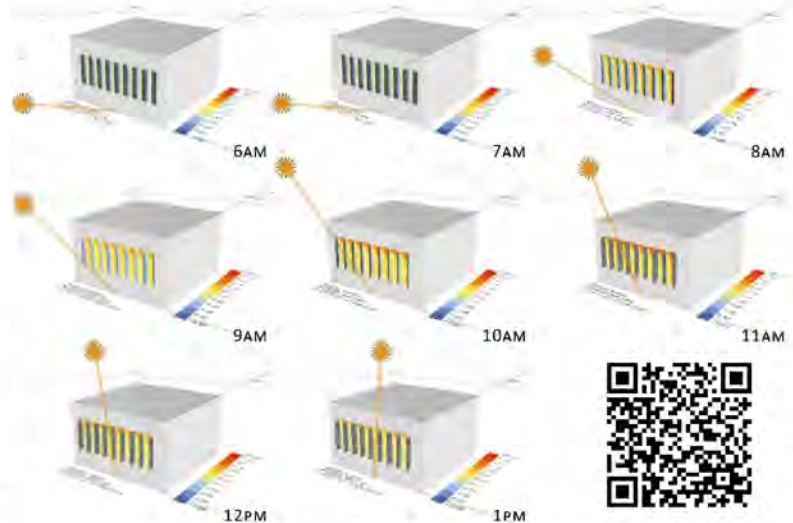

Fig.1: Radiation Analysis, West window | June 21st, 6AM-1PM

Model

For this simulation a simplified parametric model of a single window protected by a set of vertical rectangular louvers has been used (Fig.2). The analysis have been carried out for an East-facing windows as well as for an West-facing window.

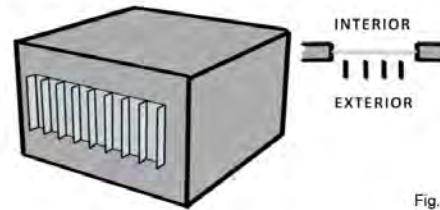

Fig.2: View of the model

Simulation

Analysis Period: June 21st, 6AM-10PM

Time step: 1 hour

Adaptation

The objective is to prevent uncontrolled solar radiation to enter the building through the windows. The system adapts its shape according to the position of the sun, more specifically, the angle of rotation of the louvers depends on the sun azimuth. This was achieved through a Grasshopper definition (Fig.3).

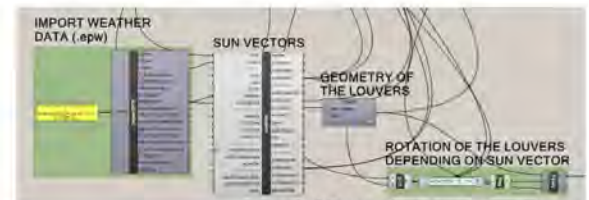

Fig.3: Extract of the Grasshopper definition

Results

Three cases have been investigated for each window orientation:

CASE 1: no louvers

CASE 2: static louvers, normal to the facade (Fig.2)

CASE 3: adaptive louvers

For the analysis period investigated, compared to Case 1, the solar radiation on the west-facing window is reduced by 36% in the case of static louvers while the reduction reaches 45% when an adaptive system is applied.

Critical aspects

- Radiation reduction during summer is not the only requirement in order to achieve a suitable comfort level and good energy performances. More detailed investigations are needed.
- How to evaluate to what extent an adaptive facade is a better solution compared to traditional shading systems?

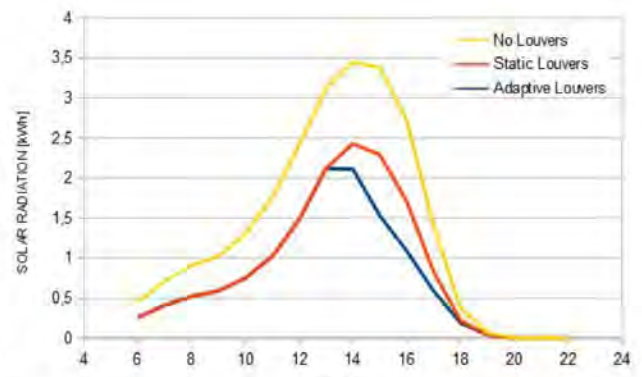

	WEST WINDOW		
	No Louvers	Static Louvers	Adaptive Louvers
TOTAL [kWh]	23,09	14,67	12,7
REDUCTION [%]	-	36%	45%

Case Study: Residential Building “Rudo”

► Jorge Luis Aquilar-Santana, Anka Mirkovic, Berk Ekici
Milica Petrovic, Ashal Tyurkay

Architectural design concept

Façade concept

The façade concept is developed with the performance approach which takes user requirements into consideration based on building typology and climatic conditions of the site. Design solutions are proposed with this point of view after the existing building façade problems have been identified.

As the building façade lacks of thermal insulation, in winter time interior spaces are over-heated, and in summer time unwanted thermal gains are too high, thus, energy efficiency of the building is low. Since the window systems are replaced individually by tenants, most of the apartments experience weathertightness problems which also decreases the energy efficiency considerably. In parallel to this, users have to spend a lot on space heating and cooling which is not economical in the long term. Moreover, exposed prefabricated concrete panels have remained unmaintained and pose structural risks. Another factor in choosing the façade systems and developing the solutions is the affordability that matches the users' economic conditions.

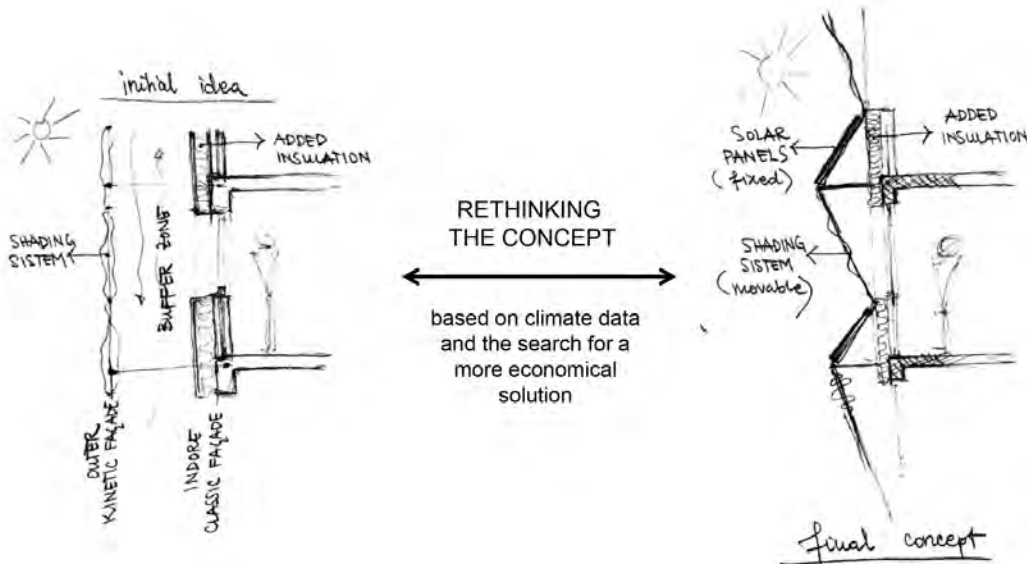

Problems / Challenges

- Prefabricated concrete panels
- No insulation in facade elements
- Poor window conditions /weathertightness
- Absence of shading
- Uncomfortable interior temperatures

Prioritized Requirements

- RESIDENTS' HAPPINESS 😊
- Thermal comfort
 - Energy efficiency
 - Affordability

Solutions

- Repair and maintenance
- Adding thermal insulation
- Changing the windows
- Providing solar control
- Adding solar panels

Case Study: Residential Building “Rudo”

► Jorge Luis Aquilar-Santana, Anka Mirkovic, Berk Ekici
Milica Petrovic, Ashal Tyurkay

Parametric façade model

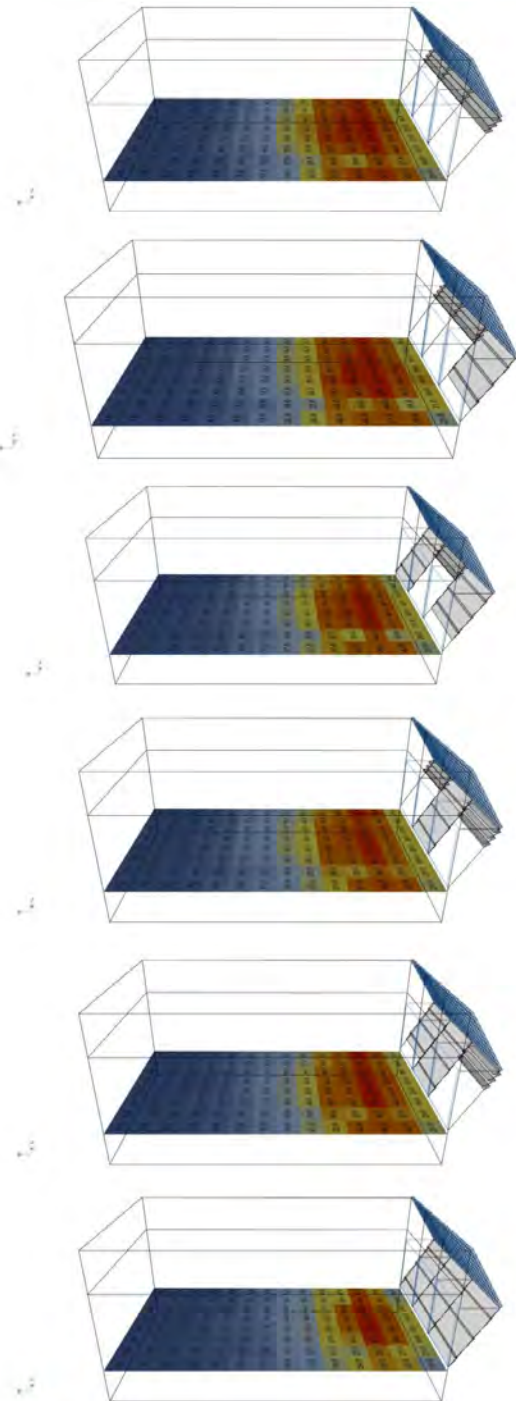

► Fig. 11: Variations of the adaptive facade

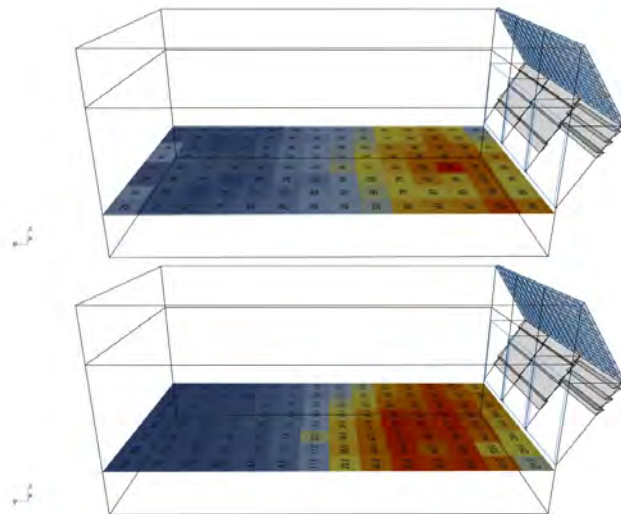
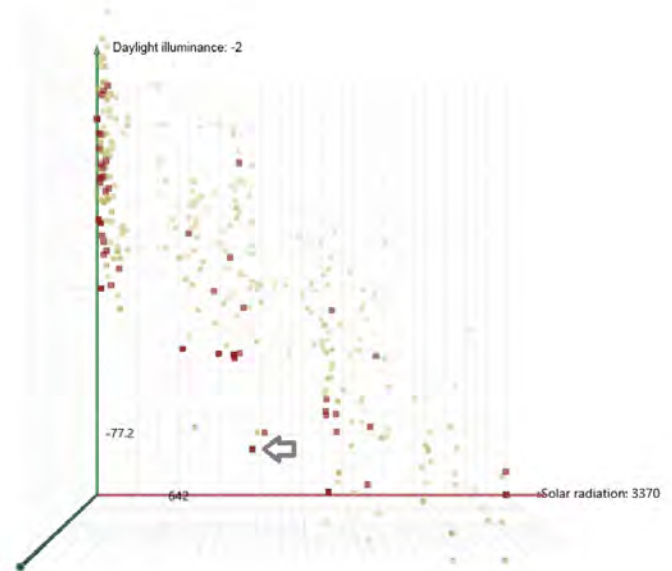
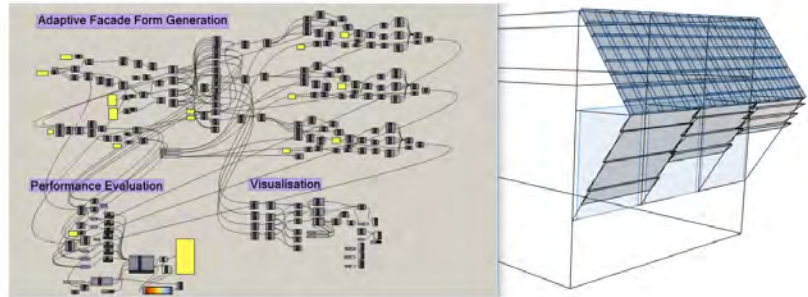

► Fig. 12: Optimized design solution

Case Study : Refurbishment of “Beogradjanka”



ADAPTIVE FACADES 2018
BELGRADE

► Aleksandra Ugrinovic, Dijana Svanovic, Mariana Velascoc, Paolo Bonato, Yeşim Keskinel

Façade concept

After analysing the advantages and disadvantages, replacing the façade was selected as the most suitable option.

- Preserving the height of the building
- Highlight buildings' height by applying vertical elements
- Emphasise the buildings' colour : conserve the black unlike the “White City”
- Preserve the shape of the building
- Use façade materials that will indicate the purpose of the building (commercial)

Technical details

- In replacing the façade, the following issues were emphasised;
- Installation of suitable colored triple safety glazing with interstitial shading device for reduction of heating load in winter and protection from glare.
- To improve thermal break, the insulation materials are improve with aeregel for reduction of heating load in winter.
- Replacement of the existing technology when needed (internal shading devices, internal seals of the glazings, cleaning of the weep holes and drainage system)

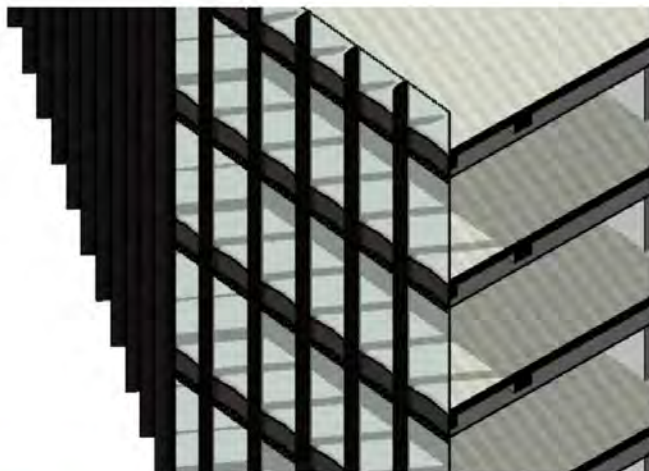

KEEP		REPLACE	
PROS	CONS	PROS	CONS
Identity	Limited range of retrofitting options	New identity and values	Disposal of old façade modules
Shorter time of construction	Structural uncertainty (double skin?)	Wider range of retrofitting options	Additional storage space and effort
(Cheaper)	Uncertain status of façade module (permeability, airtightness..)	Easier application of new materials and technologies	Longer inaccessibility of the building
	Some components already need replacement	Possibility to differentiate façade module typologies	(More expensive?)



► Aleksandra Ugrinovic, Dijana Svanovic, Mariana Velascoc, Paolo Bonato, Yeşim Keskinel

TRYSNIS Simulations Results

The replacement of the façade allows to reduce the space heating demand of 58% and the space cooling demand of 16% and to achieve energy-purchase savings in the order of 14 €/m²/y, i.e. about 9000 €/y for one floor.

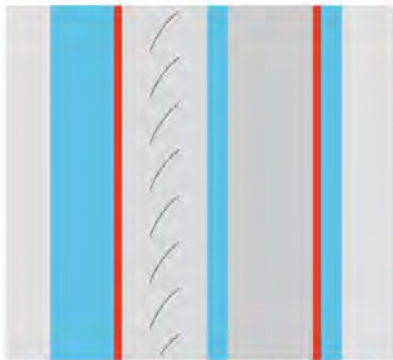

12mm	SGG PLANICLEAR
40'	SGG COOL-LITE KS 147
16mm	Argon 90%
45°	SL 16 S157
4mm	SGG PLANICLEAR
16mm	Argon 90%
65	SGG COOL-LITE KS 147
4mm	SGG PLANICLEAR

Saint Gobain + Pellini ScreenLine SL16 S157 + Selective dark coating.
Venetian system and glass chosen with a brownish colour to keep the old appearance.

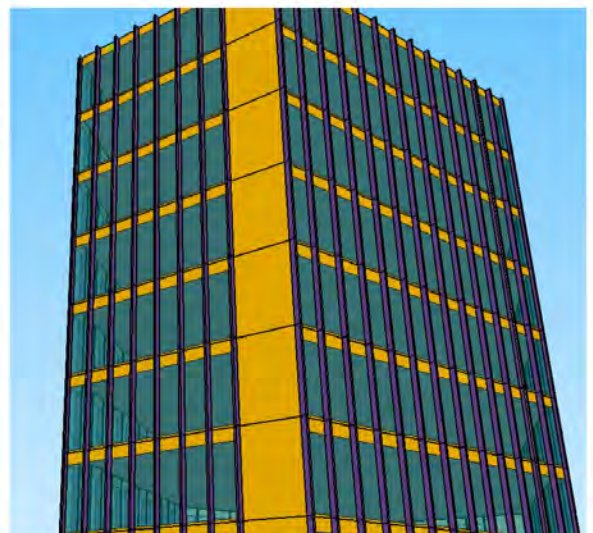
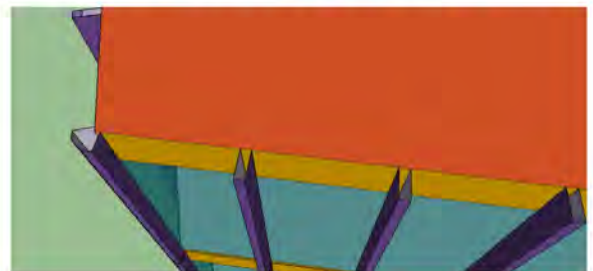
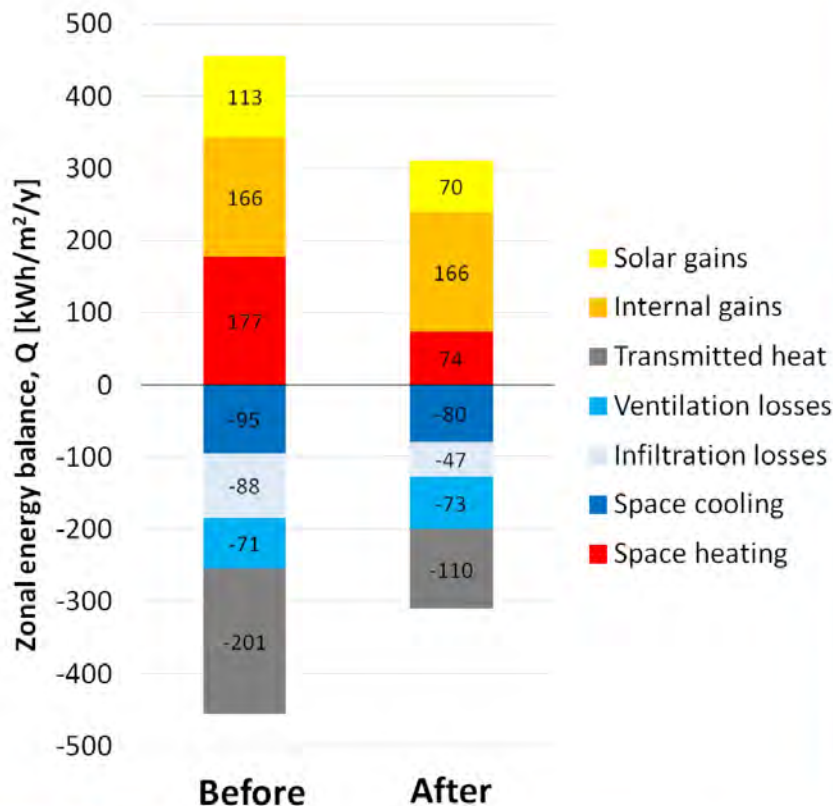
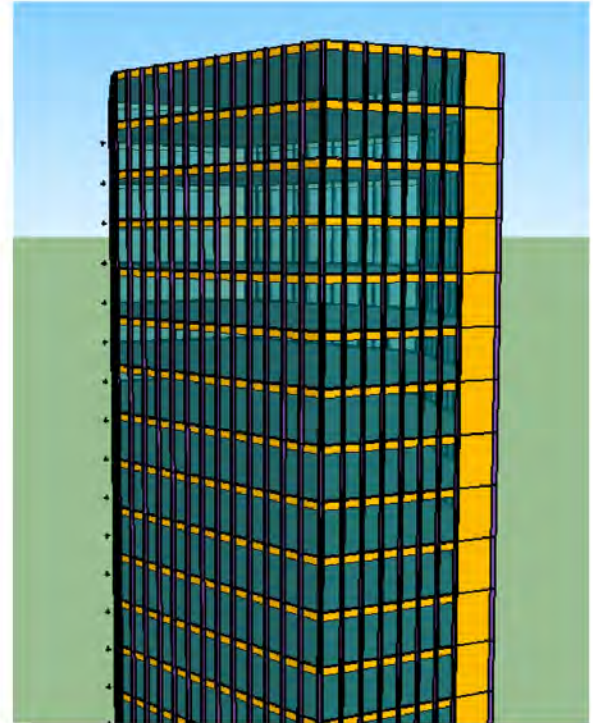

Case Study 1: Office building "Beogradjanka"

► Names: Ana Kotic, Milan Varga, Valentina Frighi, Michael Michalis.

Project development process

Technical details

The intervention strategy for the energy performance improvement of the façade is mainly based on the implementation of the thermal performance of the building envelope by inserting a layer of thermal insulation and by placing a high performance window on the internal skin of the casing.

Furthermore, it been foreseen the maintenance of the existing curtain wall to which we will add a sun shading adaptive device, which possibly will allow to retrofit the facade thanks to a BMS system that will allow its control through predicted scenario, according to indoor activities and occupants behavior and preferences.

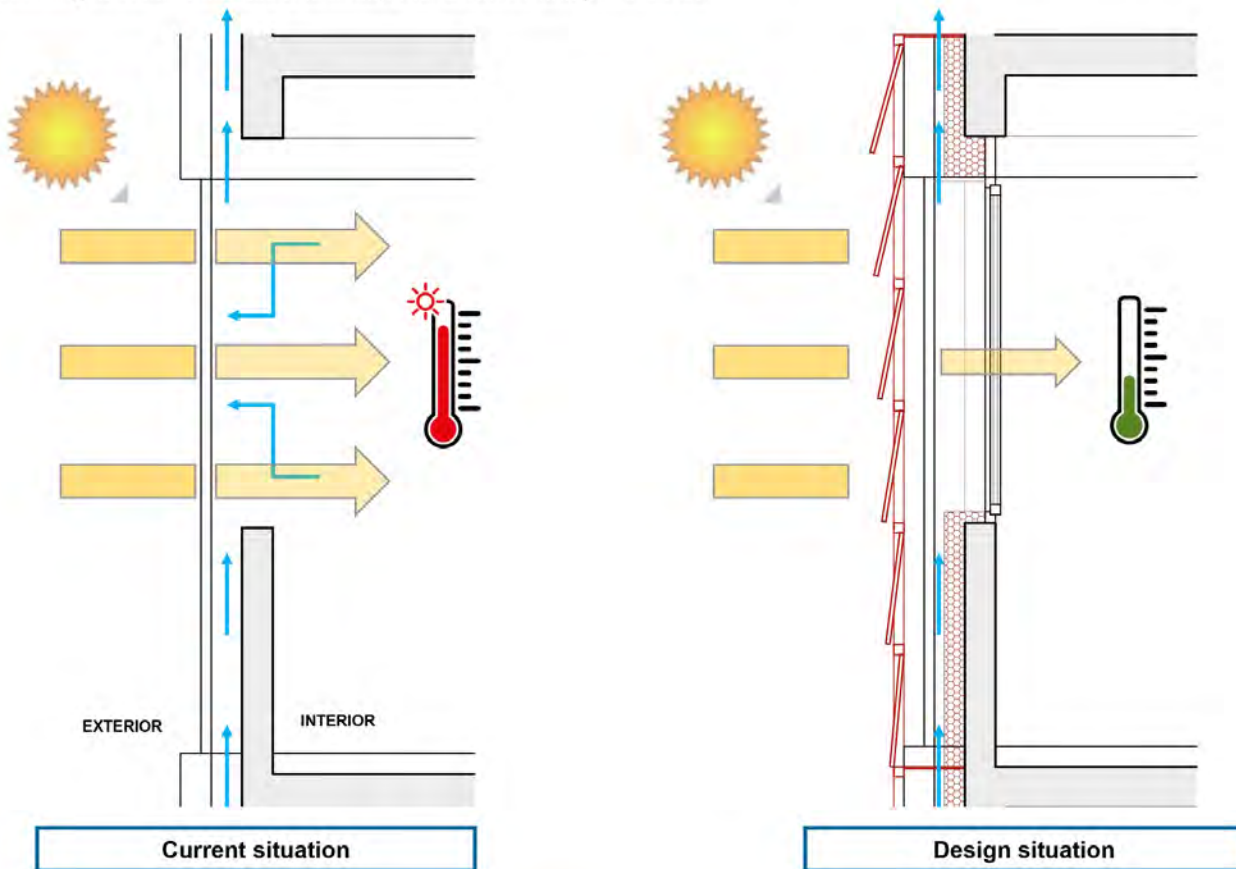

Museum of Paper Art (2002), Shigeru Ban Engineer(s), Shizuoka, Japan.



Helio Trace (2012), Skidmore, Owings & Merrill (SOM).



Adaptive Solar Façade (2011), ETH Zürich.

Case Study 1: Office building "Beogradjanka"

► Names: Ana Kotic, Milan Varga, Valentina Frighi, Michael Michalis.

Simulations and results

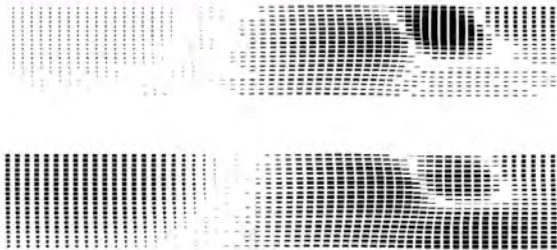

Early concept

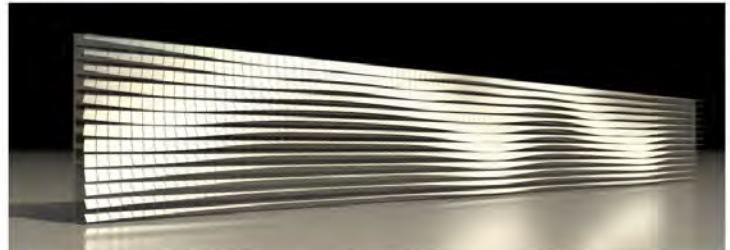

Single floor Grasshopper output

By using the parametric software Grasshopper in combination with Rhinoceros 3D, we developed a definition which is disposing the kinetic panels over the facade planes.

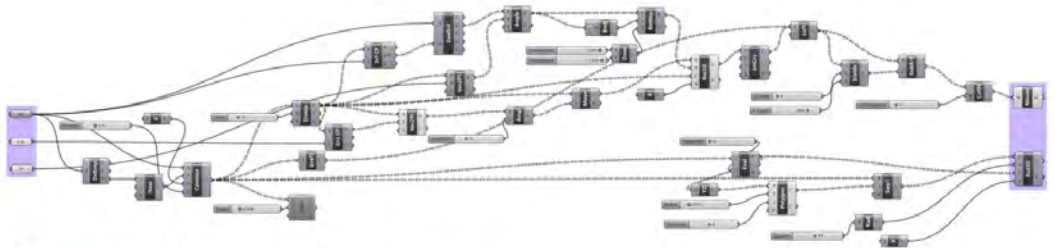

Grasshopper definition

Each of the panels is responsive and reacting to the given curve. In this way we are able to control the aesthetics of the facade and the amount of insolation.

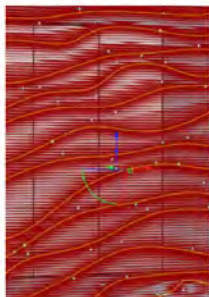

Design process

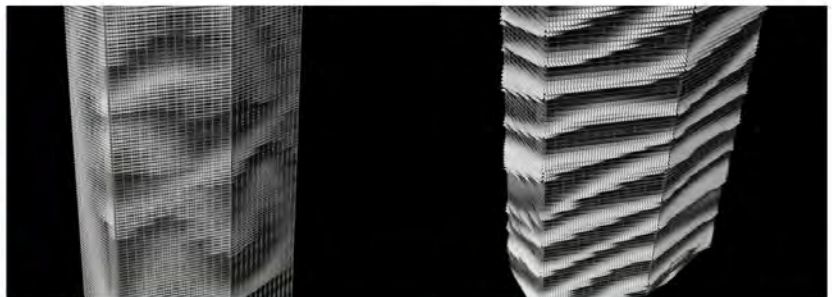

Variations

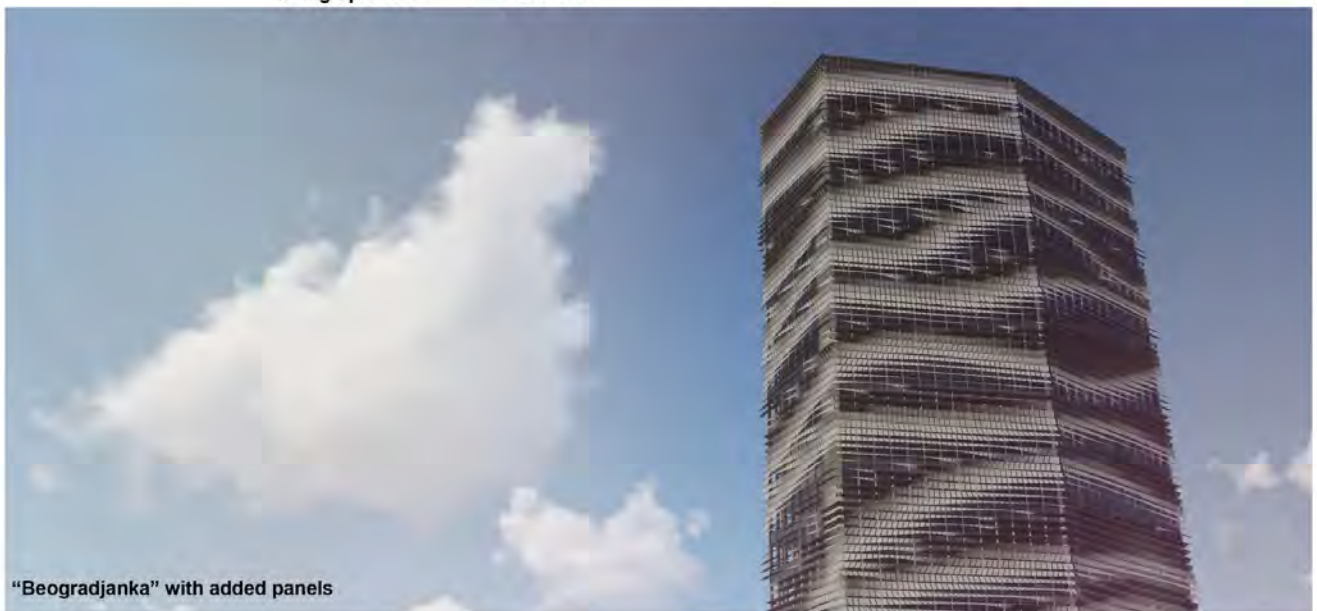

"Beogradjanka" with added panels

Retrofitting Office Building: Beogradjanka

Group 7: Miroslav Vulić, Neda Džombić, Yorgos Spanodimitriou, Mohataz Hossain

Location

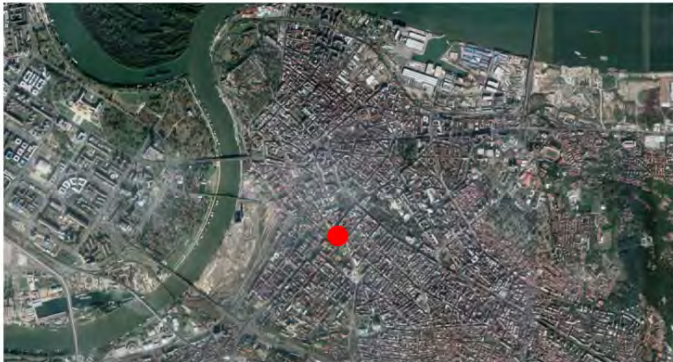

Location: Belgrade, Serbia
Architect: Branko Pešić
Project year: 1969-1974
High: 101 m
Area: 40.000 m²
Story: 24

Location

- Beogradjanka Tower is located in the middle of Belgrade, Serbia
- Part of the city with commercial and residential buildings

Context

- Modern high-rise building
- 3rd tallest building in Belgrade (1st Usce Tower and 2nd Western City Gate of Belgrade)

Climate and decision

1.

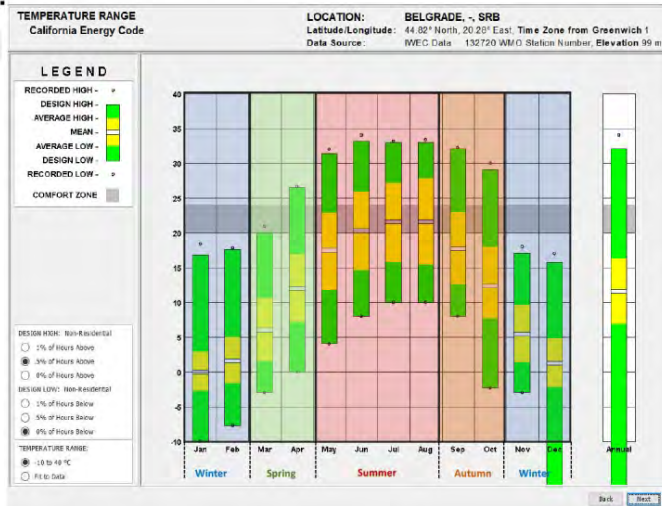

Graph 1: The temperature graph shows that in the summer, daytime temperatures get quite high (almost 35 C° on average), but also that during night the temperature drops significantly (almost down to 15 C° on average).

2. Daily Air Temperature: Summer Solstice

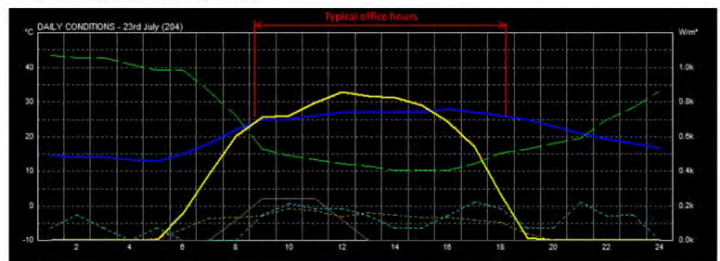

Daily Air Temperature: Winter Solstice

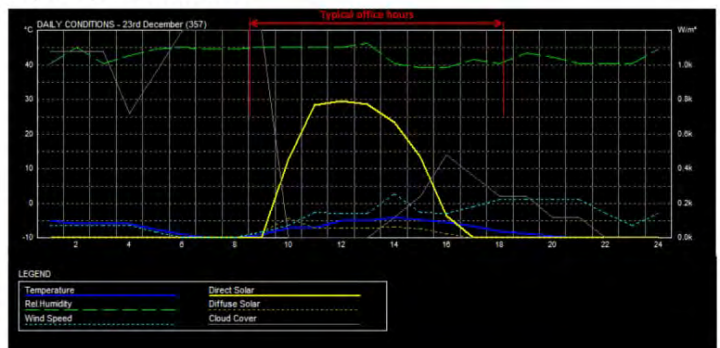

Graph 2: Through a confrontation between temperature and direct solar radiation, both in summer and winter, it's possible to observe how there is constant solar radiation during workhours during the whole year.

Graph 3: The solar and wind geometrical graph show how the building is exposed to solar radiation and natural winds during the whole year on average.

Through the weather analysis, it has been possible to assess a dynamic strategy based on natural ventilation (in summer) and greenhouse effect (in winter).

3.

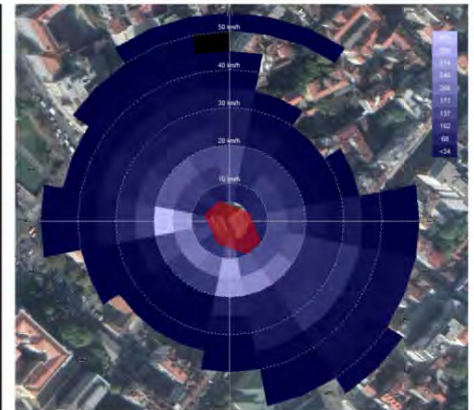
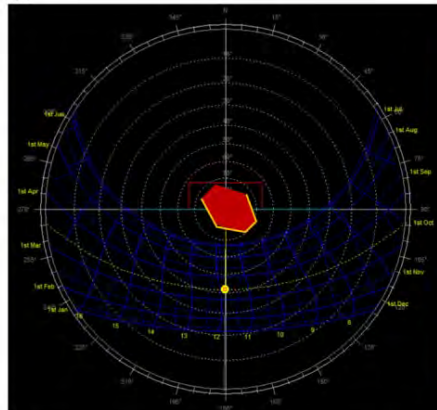

Retrofitting Office Building: Beogradjanka

Group 7: Miroslav Vulić, Neda Džombić, Yorgos Spanodimitriou, Mohataz Hossain

Model visuals



Technical details

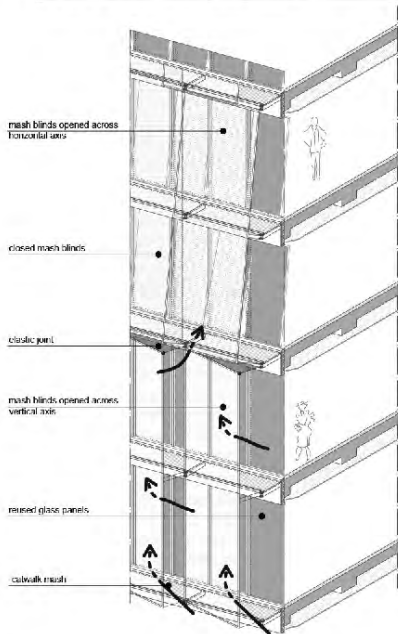

ISOMETRIC VIEW, SEGMENT OF FACADE

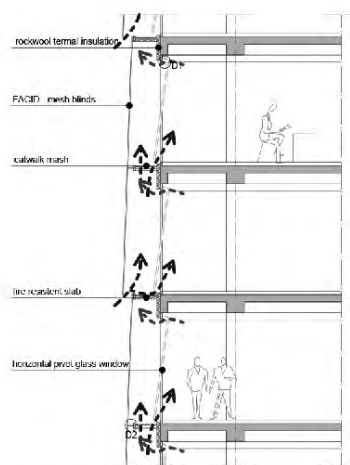

SECTION PLANE, SEGMENT OF FACADE

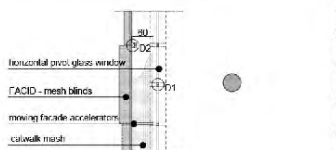

FLOOR PLANE, SEGMENT OF FACADE

Section detail of windows frame

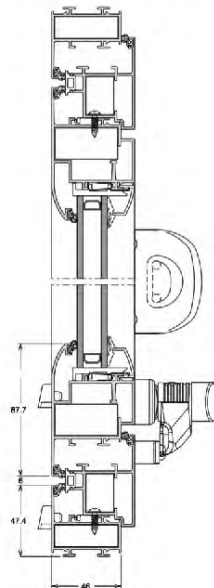

Technical detail of linear actuator

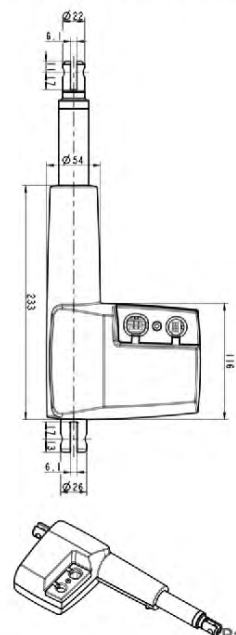



Schweigaards gate 16 / LOF Arkitekter AS (image: M. Brzezicki)

& SCHALA
PARTNERS

& S
P

Educational Package



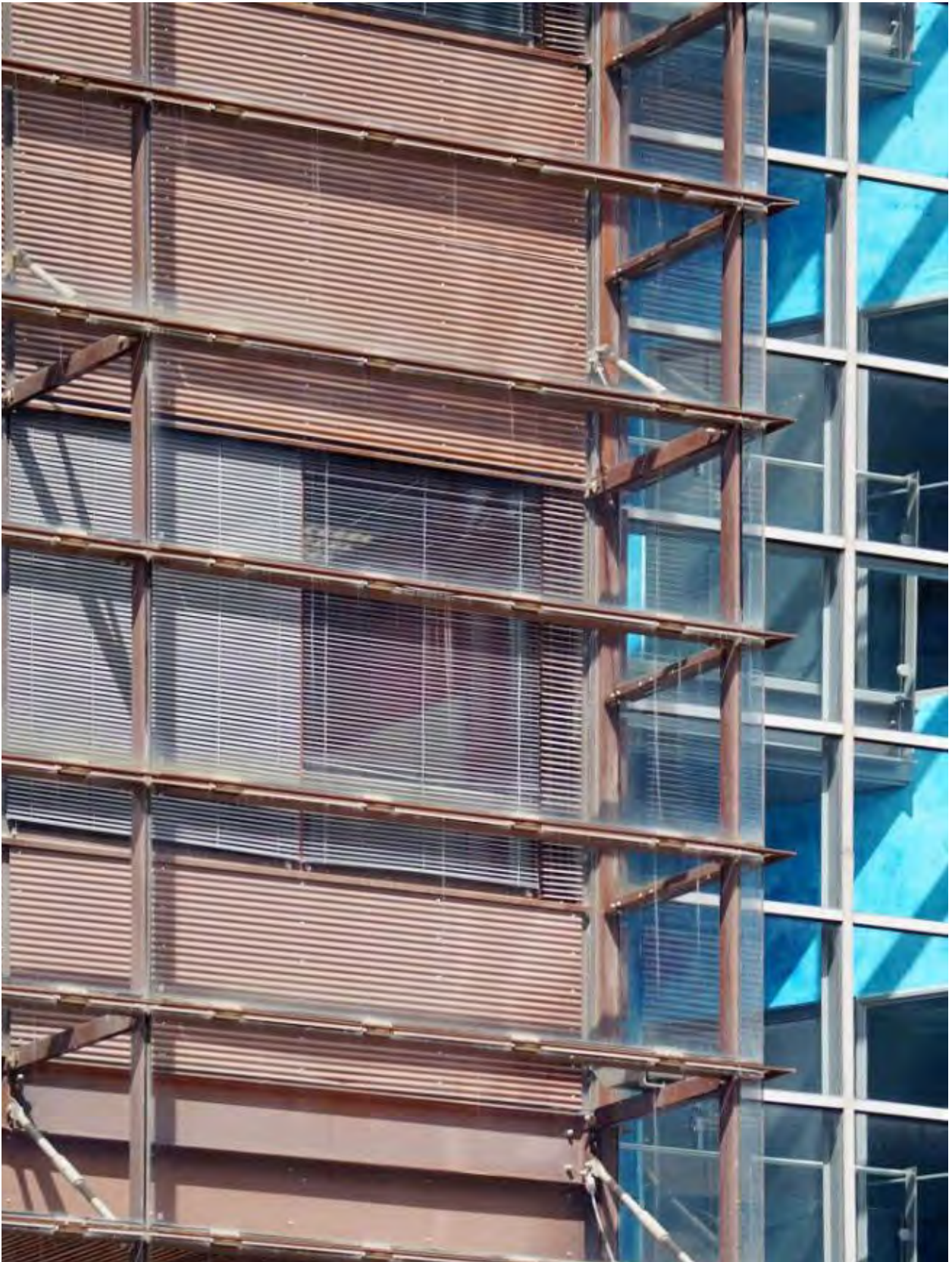

Sitra Tower / Helin & Co Architects (image: M. Brzezicki)

Educational Package

Uta Pottgiesser

Introduction

The Educational Package generally supports the general goals of this Action that shall lead to:

- increased knowledge sharing between the various European research centres and between these centres and industry;
- the development of novel concepts and technologies and/or the new combinations of existing technologies for adaptive facades;
- the development of new knowledge such as effective evaluation tools / design methods for adaptive facades;
- the start of new collaborations and research projects in the area of adaptive facades technologies that will continue beyond the end of this Action.

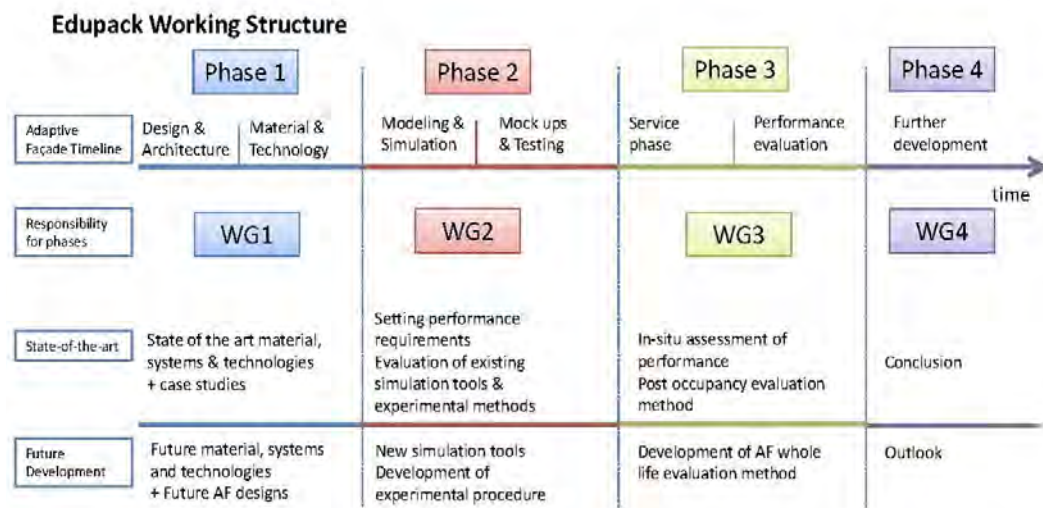

Figure 1 - To develop the lectures, a general EduPack Working Structure has been used.

To do so the Educational Package consists of lectures and educational material, such as pictures, design guides and training courses that correspond with the tasks and deliverables of the Working Groups but also with complementary input for different kind of researchers to inform about other fields of research. The lectures and presentations are in particular targeted to teaching staff at Universities, but it is expected that researchers, practicing engineers and architects and other stakeholders will also find it useful for extending their knowledge on adaptive facades, which will be:

- Educational bodies
- Practicing engineers and Architects
- Façade Industry, Component Manufacturers and Professional Associations
- Researchers and Research Institutes
- Standards Bodies
- Building Owners and Building Investors
- General Public

EduPack for Training School 1 Hamburg 2016

	Phase 1		Phase 2		Phase 3 + Phase 4	
	Conceptual Design	Material & Technology	Modeling & Simulation	Mock ups & Testing	Operation phase	Performance evaluation
WG1 3 h lecture	1. Definitions + Typologies of AF 2. Components + Elements of AF 3. Requirements + Objectives of AF (WG3.1 Definition of system requirements and comfort criteria) (State of Art, based on case-studies and realised projects)					
WG2 3 h lecture			1. Map out performance metrics and requirements for Adaptive Facade 2. Modeling + Simulation of AF 3. Physical Testing + Measuring of AF. Structural Systems + Dimensioning of Adaptive Facades			
WG3 3 h lecture					WG3.5 + WG3.4 1. System Control + Operation of AF 2. Adaptability + User Behavior of AF 3. Post-Occupancy Evaluation of AF (Evaluation of performance, Usage, façade interaction, communication)	

EduPack for Training School 2 Belgrade 2018

	Phase 1		Phase 2		Phase 3 + Phase 4	
	Conceptual Design	Material & Technology	Modeling & Simulation	Mock ups & Testing	Operation phase	Performance evaluation
WG1 3 h lecture	1. AF: Concepts and Typologies 2. Materials for Adaptive Facades 3. Climate adapted Facades for Belg. 4. AF for Retrofitting (Definition of system requirements comfort criteria)					
WG2 3 h lecture			1. Structural Concepts for AF 2. Structural aspects & case studies 3. Simulation Approaches			
WG3 3 h lecture					WG3.5 + WG3.4 1. Performance assessment and evaluation 2. Post-occupancy Performance Evaluation (Evaluation of performance, Usage, facade interaction, communication)	

Figure 2 - Specific Themes for the Training Schools within the general EduPack Structure.

The Educational Pack reflects the multidisciplinary approach of the Action and will therefore serve to train the next generation of facade designers, engineers and researchers in this area with its 26 lectures and more than 1.300 slides, available digitally (password-protected) for the 210 Action-members at the Action-website. The lectures have an average of 50 slides, each of the scientific Working Groups has contributed with 8-10 lectures. At each Training Schools 9-10 lectures were presented and specific content for 8 lectures has been produced by the STSM (Table 1).

Table 1 - Overview of lectures showing the distribution of the lectures according themes and WGs.

STSM

WG1_STSM Double Skin Facade (DSF) (Stefano Fantucci)
WG1_STSM Smart and Multifunctional Materials (Juren Miresti)
WG2_STSM Comparison of Energy Performance of conventional and adaptive Facades (Alexander Petrovski)
WG2_STSM Holistic Investigation and IEQ Assessment of Building integrated Hybrid Façade Element (Andjelkovic)
WG2_STSM New Strength Evaluation (GabrielePisano)
WG3_STSM Air Flow Measurement Techniques (Matthias Friedrich)
WG3_STSM Façades Commissioning (Francesco Causone)
WG3_STSM Visual Comfort Assessment (Luigi Giovannini)

Training School Hamburg 2016

WG1_L1 Introduction Adaptive Facades (Tillmann Klein, Philipp Molter)
WG1_L2 State of the Art Adaptive Facades (Tillmann Klein, Philipp Molter)
WG1_L3 Design for Adaptive Facades (Daniel Aelenei, Laura Aelenei)
WG2_L4 Structural Aspects & Case Studies 1 (Chiara Bedon)
WG2_L5 Building Performance Simulation (BPS) (Alberto Castell)
WG3_L6_Adaptive Facade System: Performance Analysis (Christian Struck)
WG3_L7_Adaptive Facade System: Design Process (Christian Struck)
WG3_L8_Adaptive Facade System: Occupant Behaviour (Shady Attia)
WG3_L9_Adaptive Facade System: Performance Measuring (Shady Attia)
WG3_L10_Adaptive Facade System: Multidisciplinary Design System (Attia et. al.)

Training School Belgrade 2018

WG1_L1_Adaptive Facades: Concepts and Typologies (Marcin Brzezicki)
WG1_L2_Smart and Multifunctional Materials (Juren Miresti) s. STSM
WG1_L3_Climate Adaptive Facades for Belgrade (Mark E. Alston)
WG2_L4_Adaptive Facades for Retrofitting (Aleksandra Krstic-Furunzic, Budimir Sudimak)
WG2_L5_Structural Concepts for Adaptive Facades (Mislav Stepinac)
WG2_L6_Structural Aspects & Case Studies 2 (Chiara Bedon)
WG2_L7_Building Performance Simulation of Adaptive Facades (Fabio Favoino)
WG3_L8_Performance: Time conscious Building Envelopes (Fabio Favoino)
WG3_L9_Post Occupancy Performance Evaluation (Roman Rabenseifer, Shady Attia)



Champilimaud Centre for the Unknown / Charles Correa Associates (image: M. Brzezicki)

Reflection

The discussion of structure and content of the Educational Package has also shed light to certain questions that were discussed controversial, such as the need a **more holistic understanding** of the topic and how to design the integral collaboration between designers and engineers. In particular, the collection of case studies in WG 1 has shown that missing **integration** is still a theme. The creation of a **common understanding** of 'adaptivity' and the expectations associated therewith has been topic of several papers and present in the lectures.

The different focus and nature of approaches in the WG also brought up the question of how **common** research and knowledge can be further developed and how **complementary** research and knowledge can be connected in education, professional training and research. The themes explored and presented in the Educational pack have been developed step by step covering all WG and all phases of buildings life-span to finally create a coherent story.



Rolex Learning Center / SANAA (image: M. Brzezicki)

ESR/ECI Support Sessions





Sede EDP / Aires Mateus Architects (image: M. Brzezicki)

ESR / ECI Support Sessions

Thaleia Konstantinou

Introduction

Scope of the sessions. According to the Memorandum of Understanding for the implementation of a European Concerted Research Action designated as COST Action TU1403: Adaptive Facades Network, the action aims at supporting the Early Stage Researchers (ESR)¹ and in particular Early Career Investigators (ECI)². The Action should operate as an ideal incubator and platform for ESR and ECI, engaging them in the working groups and training schools, as well as helping them to identify relevant research fields and to create a strong network with the relevant experienced researchers and industrial partners.

To this end, it was decided to organise ESR / ECI support sessions. Within the Action framework, those sessions were coupled with Training Schools since this is where we had the chance to include a larger number of ESR and ECI. The ESR / ECI session was, thus, part of the Training School schedule, but independent from the content. In both Training Schools, the session took place on the first day, in the afternoon. The sessions, which had the form of an interactive workshop, provided an opportunity for the participants to get acquainted with each others' background and research, and better prepare for the collaboration during the rest of the training school.

Aim. During the project meeting and in preparation of the sessions, a number of different topics were proposed, such as research methodologies, paper/thesis writing, present/pitch scientific work etc. In the end, a focus on research methods and the structure was selected, as it was considered to have more potential to be informative and offer opportunities for interaction. In this sense, the session had multiple objectives, as follows:

- Learn how to organise the research structure and methodology
- Get the participants acquainted with each other
- Practice in present complex research concisely in a short time
- Be able to understand in depth and use research that you are not an expert on

Structure of the interactive workshop. In both Training Schools, the background of the participants is diverse, comprising of both engineers and architects. All of them have research experience, at different levels, however. Some researchers were close to concluding their PhD, while other had recently begun or were working on their master thesis. The workshop had two parts; lecture and group work with support from the tutors. During the training school in Hamburg, there were 54 participants, distributed in 14 groups of 4 members. The trainers were Thaleia Konstantinou, Thomas Henriksen, Ulrich Knaack. In the Belgrade training school, the 32 participants formed 7 groups of 4 or 5 members each and the lecture and tutoring was by Thaleia Konstantinou. Both lecture and workshop layout were the same in both training schools, only improved after remarks and feedback of the first training school participants.

The session consisted of two main parts; lecture on theoretical approach on how to structure research and then the workshop when the approach was applied. Moreover, some preparation before the training school was required by the participants.

Preparation. After the participants' acceptance in the training school was confirmed, they were requested to provide a poster describing their research. The posters used a template provided by the Action and included general research information, background, objective deliverable etc.

All the posters were collected and redistributed to the participants, who had to read them so that they get familiar with the background of their fellow participants.



Figure 1 - Lectures in ESR / ECI Support Sessions

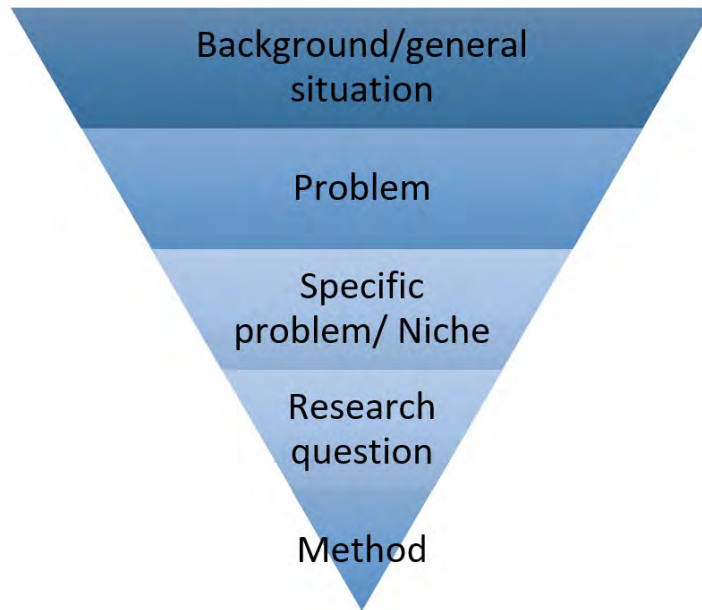

Figure 2 - "Research Funnel"



Figure 3 - Workshops in ESR / ECI Support Sessions

Lecture. The lecture introduced the significance of research in design disciplines, such as Architecture. We explained the difference between design and research and how the latter can answer in a scientific, structure and objective way, questions that the design triggers. To achieve this objective, the definition of this question is essential and should be based on facts and arguments, following a logic as shown in the figure below, the “research funnel”. To illustrate this principle, the PhD thesis of the trainers were presented as examples.

Workshop. The objective of the workshop was for the participants to structure or re-structure their research, according to what was discussed in the lecture. Due to lack of time, but also to make the workshop more interactive, not all topics discussed, but one per group. First, the researcher of the topic in questions explained his/her research to the other group mates. They asked questions and clarifications, highlighted issues that needed to be further defined and discussed how those issues can be improved or solved. Then the group worked on preparing a presentation which would explain the research based on the research funnel steps. The topic would be presented by one or more group members, but other than the topic’s original researcher. The benefit of this approach was twofold; for the researcher, being able to explain your research clearly and for the group, being able to understand and repeat research themes in a constructive way. During the workshop, the trainers would discuss with the groups, to support the process.

Final comments. Based on the participants’ feedback, the ESR / ECI session was useful to support their own research and develop their ideas further. The researchers seemed to know well the background of the research and in some cases, the method and the expected results, but often they were not able to identify the specific problem clearly. Through the session, the feedback and sometimes pressure from their peers helped in getting out of a tunnel view of their own work. Moreover, explaining in depth the research to others, who needed to understand and make it their own, worked to the benefit of the project.

1 ESR: an individual in the first 4 years of their research careers and have not been awarded a doctoral degree (full-time equivalent).

2 ECI: an individual who is within a time span of up to 8 years from the date they obtained their PhD/doctorate (full-time equivalent).



Tipote Health Center / Sigge Arkkitechdit Oy (image: M. Brzezicki)

ESR / ECI Support Session Hamburg 2016

Participants

Bader Alatawneh, University of Palermo
Beatriz Arantes, State University of Campinas
Bahar Başarır, Istanbul Technical University
Roman Baudisch, HafenCity University Hamburg
Matija Posavec, HafenCity University Hamburg
Cherif Ben bacha, University of Constantine 3
Ann Bosserez, Hasselt University
Diego Caetano, Federal Fluminense University Niteroi Brazil
Estefana Castañeda, Technical University of Madrid
Victor Charpentier, Princeton University
Francesca Contrada, Université Paris EST
Jakub Čurpek, Slovak University of Technology in Bratislava
Paul-Rouven Denz, TU Delft / Facade-Lab GmbH
Andjela Dubljevic, University of Belgrade
Mario Fernández, Polytechnic University of Madrid
Matthias Förch, HafenCity University Hamburg
Matthias Friedrich, HafenCity University Hamburg
Klaus Schweers, HafenCity University Hamburg
Mohammadhossein Ghasempourabadi, SEAC-TU/Eindhoven-TU/Delft- 3TU
Luigi Giovannini, Politecnico di Torino
Giulia Grassi, Pisa School of Engineering
Philippe Hannequart, Université Paris-Est – ENPC, Arcora (Ingérop Group)
Shawn Ives, Hochschule Anhalt
Miren Juaristi, University of Navarre
Aliakbar Kamari, Aarhus University / University of Palermo
Fernando Martín-Consuegra, Universidad Politécnica de Madrid
Phan Anh Nguyen, TU Delft
Júlia Oliveira Pereira, Instituto Superior Técnico
Elida Rios , University Polytechnic of Madrid
Hemshikha Saini, TU Eindhoven
Giulia Santoro, Politecnico di Milano
Leonie Scheuring, TU Dresden
Milan Schultz-Cornelius, TU Kaiserslautern
Vlad Alexandru Silvestru, Graz University of Technology
Christoph de Sousa, University of Minho
Alberto Speroni, Politecnico di Milano
Bert Van Lancker, Ghent University
Manikanta Raghu Sagar Vanapalli, Hochschule Anhalt
Ana Cristina Villaca, CAPES, University of Wollongong
Tudor Cosmatu, TU Delft
Yvonne Watez, TU Delft

The Perforated Envelopes: An analytical vision for a sustainable architectural trend

► Bader Alatawneh, Department of Architecture, University of Palermo, Italy

► Research information

Introduction, Background to the Research

It is difficult to design effective buildings without understanding their relationship to their local environmental system, it is also impossible to protect the natural environment without decreasing the human intervention that affect it. Therefore, architects started to seek for minimizing the negative environmental impacts of buildings by searching for the efficient buildings, and for the moderation of the use of building materials, energy, etc. These environmental and socio-economic challenges were inexistent in the past, as the traditional architecture met the cultural, environmental, economic considerations in each community, by employing many different urban and architectural tools to maintain thermal comfort, visual comfort, social integration, cultural identities, etc. For example, the traditional "Mashrabiyyah" as an architectural element, played a significant role in maintaining the sustainability in the Arab-Islamic architecture. The integrative use of traditional architectural elements has led to a sustainable urban fabric and sustainable buildings. The traditional "Mashrabiyyah" as a successful perforated model, and other traditional perforated models, encouraged some of the contemporary architects to imitate them, to metaphor them, or to develop them in a new innovative solution, which has led recently to the emergence of a global contemporary trend of perforation.



Research problem

The building's envelop is the most important component to be considered when evaluating or analyzing the building's sustainability, since the envelope is the tool of controlling natural ventilation, daylight, heat gain and heat loss, visual comfort, shading, etc. Dependently, the building envelope can be considered as the barrier or the shield which has to be effectively-designed to maintain the occupants needs beside saving the environment in parallel by using integrated and sustainable solutions. The different architectural trends have produced different solutions of buildings envelopes. What draws attention here is the increasing global emergence of the contemporary perforated envelopes. This trend is connected -in some circumstances- to the traditional perforated models in different ways to employ different purposes in the building design. The traditional perforations are characterized by sustainability, however, is it the same for the case of contemporary perforated envelopes? Is it going positively, negatively, or it has no significant contribution to the sustainability? Following this point of view, the research significance takes its place by highlighting this issue, to explore the roles and the rules in which the contemporary perforated envelopes maintain the sustainability.



Research Questions (Main Questions and sub question)

Main question

How does the design process of a perforated envelope take the environmental, social and economic dimension into consideration? Or, in other words; what are the characteristics and rules those make the perforated envelope as sustainable?

Sub-questions

- 1- What are the main technological and environmental guidelines that should be considered in the design of a perforated building's envelope?
- 2- What are the main socio-cultural guidelines that should be considered in the design of a perforated building's envelope?
- 3- what are the main socio-economic guidelines that should be considered in the design of a perforated building's envelope?

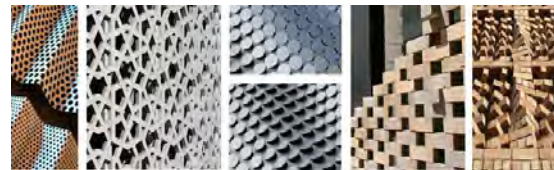

Research Objectives

The research aims at extracting a set of guidelines for designing a sustainable perforated envelope, which successively contribute to the achievement of future sustainable buildings. The extraction of these guidelines comes after making a holistic analysis for multi-cases of the contemporary trend in a sustainability point of view to come up with a deep understanding for the characteristics and rules that make the perforated envelope as sustainable.

Research Deliverables

The guidelines extraction as a main deliverable, is an important contribution which helps in outlining a clear starting point for architects and students of architecture, to design their future sustainable perforated envelopes, by considering various aspects related to the envelope's perforation, and taking into consideration the intersections and interrelations between the environmental, social and economic dimensions in their future approaches.

- **Researcher:** Bader Alatawneh
- **Supervisors:** Prof. Maria Luisa Germana', Prof. Rabee Reffat
- **Time span:** 2014-2016
- **Contact data:** bader.alatawneh@gmail.com
- **Associated Publications:**

- M.L. Germana', B. Alatawneh, R. Reffat, *Technological and Behavioral Aspects of Perforated Building Envelopes in the Mediterranean Region*, 10th Conference on Advanced Building Skins 2015, Bern, Switzerland
- B. Alatawneh, M.L. Germana', R. Reffat, *Near Zero Energy House in Palestine: Identification of the future challenges*, 5th International energy Conference (ICEP) 2015, Palestine
- B. Alatawneh, M.L. Germana', *Earth for Social Housing In Palestine: An alternative for a sustainable refurbishment of buildings' envelopes*, The International Congress on Earth Architecture in North Africa (CIAT) 2015, Marrakesh, Morocco
- M.L. Germana', B. Alatawneh, *Reviving Earthen Architecture in Palestine: the added significances of the building sustainability and an opportunity for the future*, 41st IAHS World Congress: Sustainability and Innovation for the Future 2016, Algarve, Portugal, in press

Potential on Building Performances Improvements Using Seasonal Adaptable Facades – The Context of residential Buildings

► Beatriz Arantes, State University of Campinas

► Research information

Introduction, Background of the Research

Improvements in design, conception and construction of facades play an important role in recent efforts toward energy conservation goals. In particular, climate adaptable building shells can improve building thermal performance by the modification of properties in response to the dynamic environmental boundary conditions. While most work in this field has been focused on short-term adaptation (e.g. hourly), recent research has demonstrated the potential of seasonal (i.e. long-term) climate adaptable building shells in office buildings in moderate climates. In this study, it is proposed to evaluate the potential of seasonal adaptable facades for residential buildings in different climatic zones of Brazil.

Research problem

Buildings are in a dynamic and complex environment. The use of a flexible design in facades, making them adaptable to adverse weather conditions, leads to reduce energy consumption and improve environmental comfort.

The application of short-term adaptive systems requires a high level of complexity during the design, construction and operational phase of the building. Although the use of such technology is mainly studied for commercial buildings those can be adapted to residential typologies, presenting less complex solutions with high potential of applicability.

Research Questions (Main Questions and sub question)

Main question

Which is the potential of applicability of seasonal Climate Adaptable Building Shells for residential buildings in different climatic zones of Brazil?

Sub-questions

- 1- Which is the relationship between the thermal properties of the facade, the energy consumption for cooling and the hours of discomfort?
- 2- Which is (are) the most important property (properties)/characteristic (s) to consider for adaptation of the facades of residential buildings?
- 3- What is the optimal interval of adaptation for each analyzed strategy?

Research Objectives

The aim of the research is evaluate the potential of seasonal adaptable facades for residential buildings in different bioclimatic zones of Brazil. The research intends to analyze the viability of application of Climate Adaptive Building Shells in favor of improving energy performance and living conditions of residential buildings. The optimal seasonal adaptation strategies will be identified.

This will be done through the following objectives:

- 1- Check the viability of adapting facades each month.
- 2- Check the viability of adapting facades every six months (summer / winter).
- 3- Check the viability of adapting facades every three months (spring / summer / autumn / winter).
- 4- Identify a thermal and energy efficient solution for adaptive facade for residential buildings located in different Brazilian climatic zones.

Research Deliverables

A summary of all the analyzed strategies prioritized by their potential of applicability (energy savings and comfort rates improvements).

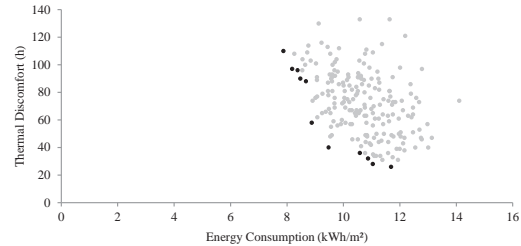

Figure 1: Scatter plots results and fronts of mensal optimization for the room zone model

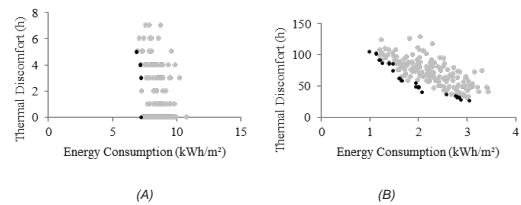
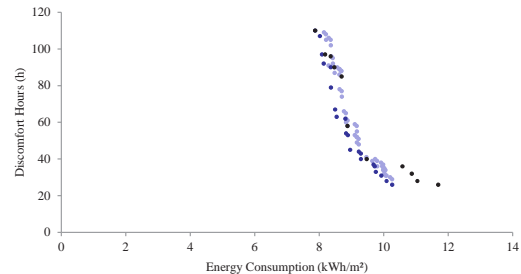

Figure 2: Scatter plots results of the available solutions and fronts of optimization process conducted for January (A) and July (B)



Legend: Light blue cloud dots: possible combinations of January and July Pareto front.
Blue dots: Adaptive facades - better combinations of January and July Pareto front.
Black dots: Static facade.

Figure 3: Comparison of the monthly Pareto fronts for the static and adaptive facades

- **Researcher:** Beatriz Arantes
- **Supervisors:** Professor Lucila Chebel Labaki / PhD Daniel Cóstola
- **Time span:** 2015-2019
- **Contact data:** beatriz.arantes@live.com
- **Associated Publications:**

- B. Arantes; L.C. Labaki, Fachadas sazonalmente adaptáveis: mapeamento sistemático da literatura, ENTAC 2016, São Paulo, Brazil.

An Approach to Build Adaptive Facades with Standard Products

► Bahar Başarır, Istanbul Technical University Department of Architecture

► Research information

Introduction, Background to the Research

Adaptive facades are considered the next milestone in facade technology and receiving increasing attention by researchers and producers on building sector as they combine low energy consumption with good indoor environmental quality. Even though this technology has evolved from simple traditional methods of construction, most of the current examples are custom solutions which include high level of complexity in design, production and maintenance. Simple and reliable solutions are needed to expand feasibility of adaptive facades and widen its application.

Research problem

Various studies have acknowledged the potential of adaptive facades, but thus far, there is no method available to build them with standard products. The main problem in simplifying the complex adaptive facades to build with standard products is maintaining the same adaptive features and performance of the facade system. Both the facade system (as a product) and manufacturing process has to be simplified to achieve the goal of building adaptive facades with standard products.

Research Questions

Main question

How can a complex adaptive facade system simplified to build with standard products without a significant loss at its performance to increase its feasibility and widening its application area?

Sub-questions

1. What are the components of adaptive facades and their functions in the facade system?
2. Which components of adaptive facades can be replaced by standard products?
3. Which methods can be used to simplify the complex adaptive facades?

Research Objectives

Intention in this research is to build adaptive facades with standard products which are available on market. More broadly, the aim is to develop a low-tech adaptive facade whose components are based on engineered and reassembled standard products with the least number of materials and layers, each of them covering several functions and adaptable performance.

This will be done through the following objectives:

1. Defining the changeable facades.
2. Classifying the adaptive facades.
3. Analysing both high-tech and low-tech adaptive facade case studies.
4. Identifying key problems that complicate the adaptive facade system and manufacturing.
5. Compiling and analysing of systematic innovation, product simplification, lean production, buildability and technology transfer methods.
6. Applying chosen systematic methods to a case study and building an adaptive facade with standard products.
7. Evaluation of the new adaptive facade system.

Research Deliverables

1. Holistic review of adaptive facades.
2. A systematic method for building adaptive facades with standard products.
3. An adaptive facade design build with standard products.

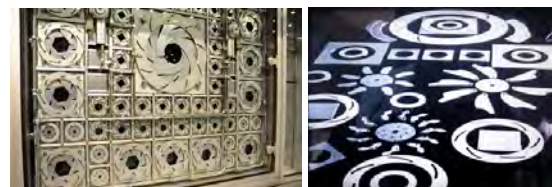
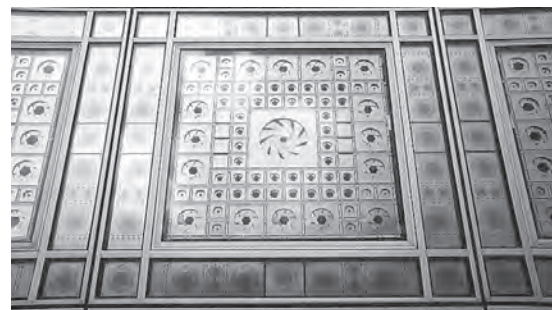

- **Researcher:** Bahar Başarır
- **Supervisors:** M. Cem Altun
- **Time span:** 2014-2018
- **Contact data:** baharbasarir@gmail.com
- **Associated Publications:**

Development of Double Curved and Twisted Girder Structure made of Glued Laminated Timber

► Roman Baudisch & Matija Posavec, HafenCity University Hamburg – Department of Architectural Engineering

► Research information

Introduction – The Challenge!

The aim of the cooperation between HafenCity University and Hess Timber Limitless is the development of a new laminated timber beam system that can be used as basis segment for double-curved freeform surfaces. Especially the development of a holistic concept for a new, integral, and consistent structural design method and fabrication technology are in the focus of the research project. Altogether a multi-functional laminated timber girder structure for wide spanning double-curved shells will be developed and realized.

Research problem

1. Complex structural calculations in regards to free-form structure shape
2. Time consuming design process – link: Architect – Engineer – Manufacturer
3. Material limitations – non existing background regarding double curved timber
4. Manufacturing constraints
5. Poor mechanical behaviour of the structure connections

Research Guideline

Is it possible to design and manufacture a free-form timber structure which can be feasible and competitive with structures made of steel?

Research Objectives

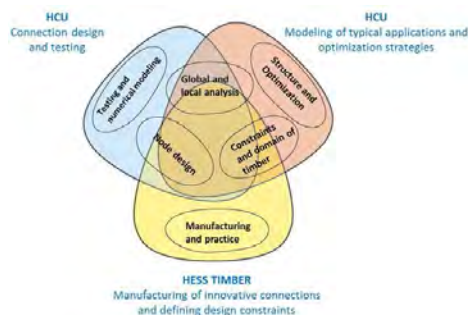

Research Methods and Deliverables

For the development of gluing technology of double curved and twisted beams it is necessary to further improve the production equipment. Another aim of the project is the development of a calculation concept that enables a holistic structural design including the numerical verification of the node-system. By developing a design model of the timber beam structure, consisting of beams and nodes, a numerical analysis system with free defined parameters shall be developed to optimize the variable configuration of double-curved surface timber structures. Further more a data transfer tool to interchange geometrical and structural data between a geometry tool (Rhinceros 3D) and a frame-structure calculation tool (R-Stab) shall be programmed with the possibility to integrate a recursive algorithmic optimization system.

Nodes with different configurations will be developed, accompanied with mechanical tests of transversal and longitudinal joints. The test results about the load-bearing and deformation characteristics of the knots and beams are implemented into a structural model as mechanical constraints. Additional geometrical constraints that are used to evaluate the feasibility of a structural solution, are the maximum component dimensions given by transportation and mount ability in the digital model.

Final outcome

1. New production technology
2. Enhanced correlation between the designers and the manufacturers
3. Automated CNC production files
4. Numerical tool as a link between RSTAB and Rhinceros = structure optimization
5. Innovative type of crossed timber-timber connection
6. Parametric model of the connection ANSYS

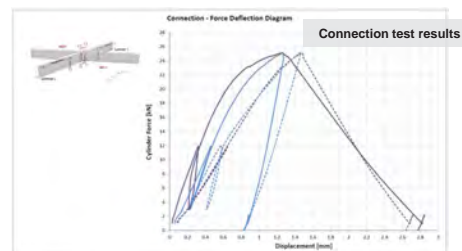
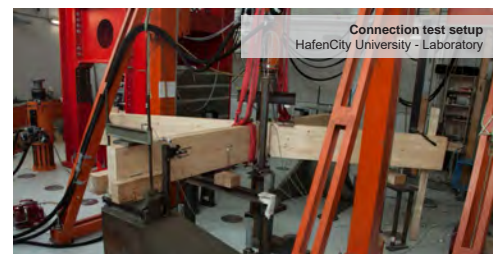
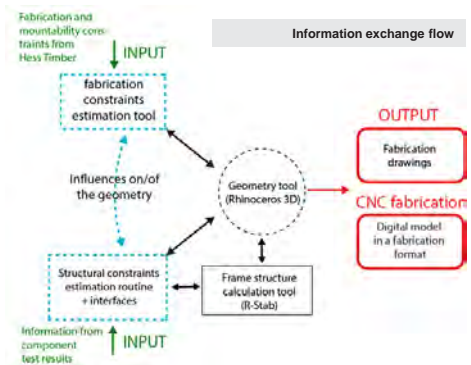
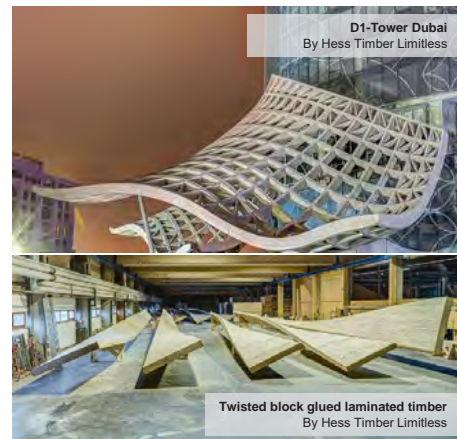

- **Researcher:** Dipl.Ing-Arch. Roman Baudisch & M.Sc.Eng. Matija Posavec
- **Supervisors:** Univ.-Prof. Dr.-Ing. Frank Wellershoff
- **Time span:** 2015-2017
- **Contact data:** roman.baudisch@hcu-hamburg.de
matija.posavec@hcu.hamburg.de
- **Partners:** Hess Timber Limitless, Kleinheubach
- **Funding:** Zentrales Innovationsprogramm Mittelstand (ZIM)

Dynamic facades as solar control tool to increase the energy efficiency of administrative buildings in arid climate

► Cherif Ben bacha, University of Constantine 3, Faculty of Architecture and urban planning, (ABE) Laboratory

► Research information

Introduction, Background to the Research

The aim of the research is to examine and evaluate the effect and performance of adaptive and dynamic façades in the context of the indoor thermal comfort and energy efficiency. These parameters are achieved by controlling the levels of solar radiation and by calculating shading element sizes for sun control in response to environmental changes. In order to ensure the systems autonomy the semi-transparent PV modules has been used as panel's material. The method is applied to the case study of a reference office building with a fixed glazed façade windows-to-wall ratio in hot arid climate zone of Algeria.

Research problem

The main problem related to the adaptive skin research is the complexity of the subject and the lack of information related to the software used and the absence of this kind of technology in Algeria. The **evaluation** of the indoor thermal comfort, using the adaptive façade cannot be assessed for the in-situ measurements.

Research Questions (Main Questions and sub question)

How can the dynamic shading devices be optimized for different building skins, to reduce the energy consumption and improving the indoor comfort levels in hot and dry climate ?

Sub-questions

1. Mechanical shading devices in building envelopes are most suitable for hot -arid climates that non- mechanical shading devices ?
2. What are the advantages of using software for parametric design shading devices and what are the tools available to use during the design phase ?
3. Does solar control in buildings helps to define an energy balance in the envelope?

Research Objectives

The design of a dynamic envelope sunscreen and sun control systems are analyzed as an aid to achieve the following objectives :

1. the creation of a new dynamic system in the external envelope that will lower both the cooling and heating demands throughout the year.
2. Reduce the heat gain in buildings while reducing energy consumption.
3. Improve the indoor thermal comfort and increase the satisfaction levels for the inhabitants of the office buildings.
4. Ensure the autonomy of the dynamic adaptive systems with semi-transparent Photovoltaic modules.
5. Provide An optimal visual environment in office spaces, achieved through the use of daylight.
6. Allow exterior views.
7. Provide an aesthetic dynamism in the building envelope.

Research Deliverables

1. 3D modelling of an existing office building in a detailed way with a dynamic simulation (Rhinceros) .
2. Design with a parametric definition of a dynamic protection system (Grasshopper) .
3. Site measurement for several climatic conditions.

Results

The results showed that after the integration of a dynamic sun protection system, as a second skin, we minimize exposure to direct radiation of **17.9%**. Which directly influence in a positive way the thermal and visual comfort levels, this dynamic shading system contribute to a significant reduction of the energy consumption reaching 43%, with a decreasing of indoor air temperature ranging between **4.0 C°** to **4.8 C°** . In addition, the integration of photovoltaic cells into the kinetic façade has a positive contribution in producing electricity that generate the amount **6000 kW / month**.

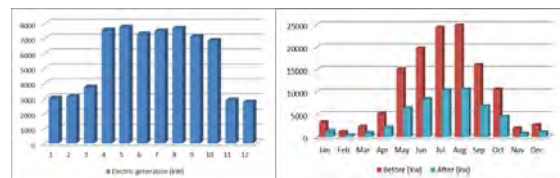
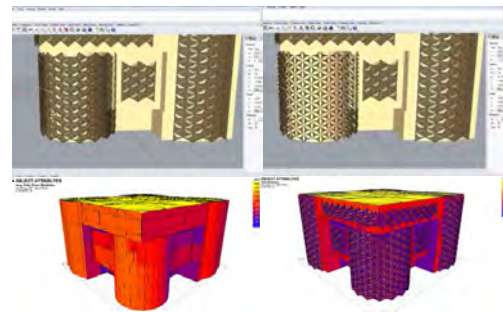

- **Researcher:** Cherif Ben bacha
- **Supervisors:** Pr: Fatiha Bourbia
- **Time span:** 2014-2016
- **Contact data:** cherif1399@hotmail.fr
- **Associated Publications:**

- C. Ben bacha, F. Bourbia, *Effect of kinetic façades on energy efficiency in office buildings - Hot dry climates* , 11th Conference on Advanced Building Skins 2016, Bern, Switzerland.

Development of a dwelling concept which enables a dynamic way of living throughout the seasonal changes in view of sustainability

► Ann Bosserez, Sustainability Group, Faculty of Architecture and Arts, Hasselt University

► Research information

Introduction, Background to the Research

The aim of the research is to develop a dwelling concept which enables a dynamic way of living for the resident throughout the seasonal changes. With a user-centred approach, the dwelling concept will lead to resource-efficient housing concepts that bring forth more energy-efficient occupant behaviour and limits the need for high material consumption (e.g. insulation) and building costs. These new housing concepts serve as an alternative housing model for the traditional, detached single-family Flemish dwelling.

Research problem

- Due to environmental, economic and social developments, the Flemish detached single-family dwelling is under pressure. This common housing model brings forth a high environmental impact, is not cost-efficient and has a low occupancy rate which results into inefficient use of the dwelling.
- With a strong focus on energy-efficiency, the Flemish energy legislation promotes current energy-efficient housing concepts that allow for a reduction of the energy consumption. But these housing concepts also induce new problems such as a high material consumption, higher building costs and inefficient occupant behaviour.
- Due to an object-centred approach, the housing concepts focus mostly on the building skin, structure and services (e.g. insulation and active techniques) while little work has been done on creating an interaction between resident (social layer) and its environment. This leads to a constant, static, controlled living environment that does not support the resident and or sustainable user behaviour.

Research questions

- **Main question**
Can a dwelling concept which enables a dynamic way of living for the resident throughout the seasonal changes, lead to an affordable house with a lower total environmental impact (energy and materials) than an equivalent house while still providing optimal comfort and spatial quality?

Sub-questions

1. How to define a concept for contemporary dynamic way of living throughout the seasonal changes?
2. Can this dwelling concept lead to a more resource-efficient housing concept, with a decrease in total environmental impact and lower building costs, than an equivalent dwelling while still providing spatial quality and optimal comfort?
3. How can this resource-efficient housing concept which enables a dynamic way of living be implemented in the Flemish context as an alternative housing model for the underused, large detached single-family dwelling?

Research objectives

- **Main objective**
Developing and evaluating a dwelling concept which enables a dynamic way of living in view of sustainability

Sub-objectives

1. Defining a conceptual framework for a contemporary dynamic way of living for the resident in dialogue with seasonal changes
2. Developing resource-efficient housing concepts that enable a dynamic way of living while still providing optimal comfort, spatial quality, lower building costs and a decrease in environmental impact (energy and materials)
3. Investigating if the developed dwelling concept can serve as an alternative housing model for the underused, large, detached single-family dwelling in Flanders

Research deliverables

1. Literature review about the interactive relationship between the resident and its environment
2. A critical overview of relevant design strategies and principles
3. Contemporary living and user patterns throughout the seasonal changes
4. Architectural design projects that induce a dynamic way of living and meet the boundary conditions under which these housing concepts work
5. Architectural design projects as an alternative housing model for the detached single-family dwelling and design guidelines for designers to create resource-efficient dwellings which enable a dynamic way of living

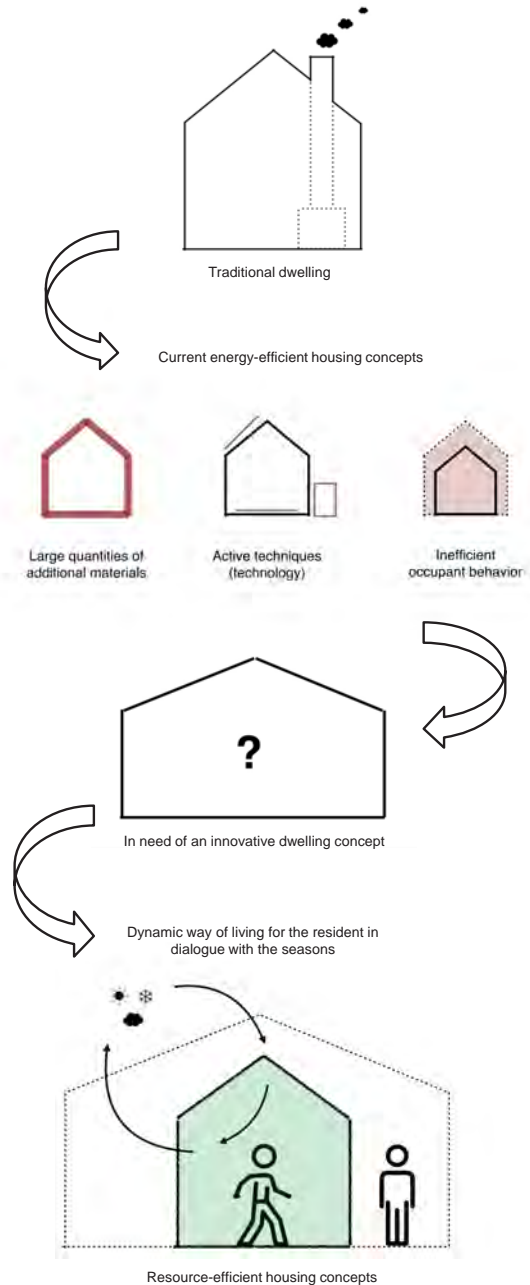

- **Researcher:** Ann Bosserez
- **Supervisors:** Griet Verbeeck and Jasmien Herssens
- **Time span:** 4 Years
- **Contact data:** ann.bosserez@uhasselt.be

NZEB and adaptive comfort in hot and humid climate regions in Brazil

► Diego Caetano M.Sc., Federal Fluminense University Niteroi Brazil, Graduate Program in Architecture and Urbanism

► Research information

Introduction, Background to the Research (Research Theme)

Energy-efficient buildings and the initiation of the use of renewable energy in the private and commercial sector challenge significantly future infrastructure projects in Brazil. The cooling of residential and nonresidential buildings is an important contribution to the overall electricity consumption of the country and its continuous growth is motivated mainly by the rising standard of living and working. At the same time, people's requirements on comfort have increased. The aim of the research is to investigate strategies to realize nearly zero-energy non-residential buildings in the hot and humid climate regions of Brazil.

Research problem

The scope of the research is to analyze if the concept of adaptive thermal comfort in buildings is applicable to non-residential buildings in hot and humid climate regions in order to reduce the cooling demand while maintaining thermal comfort requirements.

Research Questions (Main Questions and sub question)

Main question

- "How can we achieving low-energy or even net zero-energy buildings in in hot and humid climate regions in Brazil. Is the adaptive thermal comfort model, as one measure in order to reduce the cooling demand, applicable in Brazil?"

Sub-questions

1. How do occupants in office buildings perceive and assess the higrthermal comfort?
2. How much cooling is necessary in order to achieve certain room temperature conditions considering occupant requirements and behavior in hot and humid climate regions?
3. Which passive measures help to reduce the cooling demand in buildings?

Research Objectives

Results of my thesis will be conducted by thermal dynamic building and plant simulations, by long-term field monitoring of interior thermal comfort conditions in ten office buildings, and by intensive questioning of occupants with respect to their perception of temperature and satisfaction with thermal comfort.

The following methodology is applied to my research:

1. Collecting information of the state of the art of buildings and plants by a comprehensive field survey and by a literature review.
2. Monitor indoor temperature and humidity in six office buildings during occupancy and analyze occupant perception of and satisfaction with thermal comfort;
3. Analyze passive measures that help to reduce the cooling demand in buildings, through building thermal dynamic building and plant simulations;
4. Discuss the theme with the perspective to incorporate the NZEB's concept in RTQ-C Brazilian Energy Non-Residential Building Guidelines;

Research Deliverables

1. Identify thermal comfort requirements of occupants in Rio de Janeiro and Niteroi and develop recommendations of the national thermal comfort guideline for the hot humid climate regions in Brazil;
2. Identify the potential for application of NZEB concept and the passive measures in office buildings in Brazil;
3. Suggestions for Brazilian Energy Non-Residential Building Guidelines.



COPPETEC - Rio de Janeiro: Office buildings analyzed. 2015.



NAB - Niteroi: Office buildings analyzed. 2015.

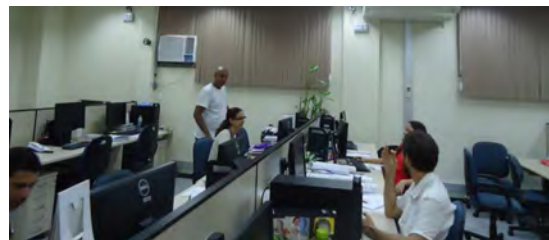

CISCEA - Rio de Janeiro: Office Standard Room in the analyzed buildings. 2015.

- **Researcher:** Diego Souza Caetano
- **Supervisors:** Dr. Sc. Louise L.B. Lomardo; Dr.-Ing. Doreen Kalz
- **Time span:** 2015-2018
- **Contact data:** diego.caetano@gmail.com
- **Associated Publications:**

- Doreen E. Kalz, Louise L. B. Lomardo, Diego S. Caetano, *Evaluation of thermal comfort and occupant satisfaction in office buildings in hot and humid climate regions, AREQ 2017, Barcelona, Spain. Submitted for publication.*

Manufacturing digital processes for free-form façade panels.

► Estefana Castañeda, Technical University of Madrid, Department of Construction and Technology in Architecture.

► Research information

Introduction, Background to the Research

Free-form architecture is one of the major challenges for architects, engineers, and the building industry. This is due to the inherent difficulty of manufacturing double curvature facades at reasonable prices and quality. The main purpose of the research is to discuss the possibility of developing geometry complex façade panels through several digital processes, especially those that avoid the use of mould, thus reducing the final cost.

Research problem

The main problem in free-form façade panels is that every single panel of the envelope usually is unique, which means that every piece has to be manufactured using a like no other mould, and therefore the price is increased.

Research Questions (Main Questions and sub question)

Main question

How can we manufacture double-curved architectural façade panels in an affordable price and quality?

Sub-questions

1. What are the main obstacles to the production of free-form façade panels?
2. How the digital processes can face these drawbacks?
3. What are the possibilities to avoid the use of mould to reduce the final price and to make an affordable method for all kind of projects?

Research Objectives

Manufacturing double-curved panels is an as yet unresolved issue in construction industry. The existing procedures for obtaining complex forms are costly and offer a limited quality results.

This will be done through the following objectives:

1. Defining currently digital processes that can afford the manufacturing of free-form façade panels.
2. Identify main limits and restrictions of complex forms panels fabrication that cause the high prices and low quality.
3. Analyse the 3D printing process as a possible solution to the main drawbacks, due this method avoid the mould necessity.
4. Develop a prototype free-form panel.
5. Identify the main problems of manufacturing the prototype free-form panel.
6. Appraise the desirable goals for industrialize this process as a final product.

Research Deliverables

1. Review of digital processes that can produce free-form facade panels.
2. A summary of all key problems prioritised by importance and a list of desirable performance parameters.
3. Prototype mould 3D printed.

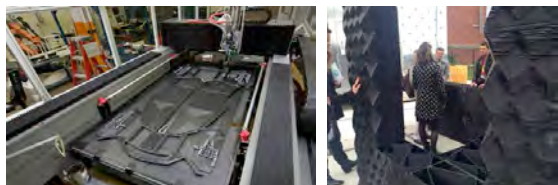

- **Researcher:** Estefana Castañeda
- **Supervisors:** Benito Lauret
- **Time span:** 2012-2016
- **Contact data:** estefanacastaneda@gmail.com

► Associated Publications:

- Alonso, L., Lauret, B., Castañeda, E., Domínguez, D., & Ovando, G. (2014). Free-Form Architectural Façade Panels: An Overview of Available Mass-Production Methods for Free-Form External Envelopes. In *Construction and Building Research* (149–156). Springer Netherlands.
- Castañeda, E., Lauret, B., Lirola, J. M., & Ovando, G. (2015). Free-form architectural envelopes: Digital processes opportunities of industrial production at a reasonable price. *Journal of Facade Design and Engineering*, 3(1), 1–13.
- Patent: Reinforced panel for opaque envelopes. P201530690, May 2015.

Co-optimization of shading and interior lighting based on large displacement of shell structures

► Victor Charpentier, Civil and Environmental Engineering Department, Princeton University, USA

► Research information

Introduction, Background to the Research

The benefits of adaptability in façade energetic performance has been proven. However adaptive façade systems most implemented today remain variations and adaptations of movable horizontal or vertical slats. The proposed research hypothesizes that more energy-efficient and durable design for adaptive building skins may come from elasticity of structures and materials.

Research problem

This research aims at harnessing elastic deformations in the particular case of shell structures to create an adaptive building skin that will reduce the operational energy consumption through shading as well as improve the occupant's experience of the building (thermal and visual comfort, ease of use).

Research Questions (Main Questions and sub questions)

Main question

How elastic deformation of thin flexible shells can be tailored to achieve site-specific large displacements in adaptive building skins to reduce energy consumption and improve thermal comfort and access to daylight inside buildings?

Sub-questions

1. Shell deformations are among the most complex structural problems. How can we identify typologies of structures that would serve the intended shading function?
2. The tailoring of intended structural deformation demands the assessment of deformation in a large variety of structures. What are the available methods to refine the identified flexible shell geometries?
3. The end goal is to improve the user's experience of the building as well as the energy consumption. How can those two objectives be integrated in the exploration of forms to guarantee their equal representation in the system?
4. Although they have been around for several years, advanced adaptive façade systems have not been extensively implemented. Can the resulting façade be simple enough to become both economically and energetically attractive in the built environment?

Research Objectives

1. Identify elastic deformation mechanisms in shell structures
2. Model, parameterize and characterize the mechanisms
3. Design an analysis framework to optimize the flexible shells
4. Tailor the shape of the shading modules to adapt to the site-specific sun exposure and daylight requirements.
5. Evaluate the elastic behavior and intended low-actuation with large displacements of the proposed geometries by:
 - a. Design and manufacture prototypes with actuation, supports and weather resistance
 - b. Test the influence of the full scale shading modules on a study case building

Research Deliverables

- A catalogue of shell typologies which displacements can be harnessed for shading of buildings.
- A new understanding of how actuation can be integrated to the structure to produce a multi-purpose and simpler shading system
- A prototype of adaptive shading that presents excellent thermal and light performances.

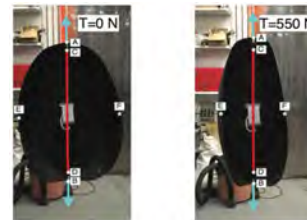
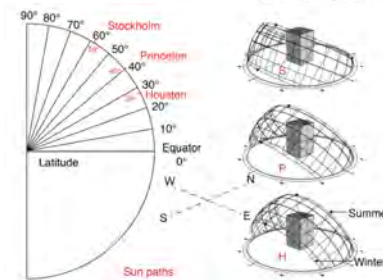
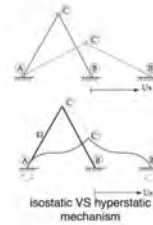
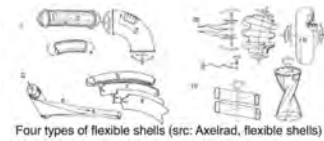

- **Researcher:** Victor Charpentier
- **Supervisors:** Sigrid Adriaenssens
- **Time span:** 2015-2018
- **Contact data:** vc6@princeton.edu
- **Associated Publications:**

- Charpentier, V., Hannequart, P., Viglino, E., Adriaenssens, S., & Baverel, O. (2016). An overview of mechanical principles of plant movements and their applications. (to be submitted)
- Charpentier, V., Adriaenssens, S., & Baverel, O. (2015). Large Displacements and the Stiffness of a Flexible Shell. *International Journal of Space Structures*, 30(3-4), 287-296.
- Adriaenssens, S., Rhode-Barbarigos, L., Kilian, A., Baverel, O., Charpentier, V., Horner, M., & Buzatu, D. (2014). Dialectic form finding of passive and adaptive shading enclosures. *Energies*, 7(6), 5201-5220.

Evaluation of a holistic assessment of building performance in early design phase

► Francesca Contrada, Université Paris EST – IRC ESTP Ecole Doctorale en Science, Ingénierie et Environnement

► Research information

Introduction, Background to the Research

Nowadays it is necessary to choose, in early design stages, techniques and procedures which are capable of univocally and efficiently assessing building performance towards an holistic approach. Holistic approach relates at the same time: Indoor Environmental Quality (visual comfort, acoustic comfort, indoor air quality, thermal comfort), the energetic performance (cooling, heating and lighting), Life Cycle Assessment (environmental impacts) and Life-cycle Cost Assessment of the building. At the same time new dynamic technologies are proposed in order to ensure a high performance level for all the building life-cycle. Adaptive façade systems have dynamic behaviour which requires the definition of novel specific bespoke indices.

Research problem

Two main problems : the difficult characterisation of adaptive facades through adapted performance indices; facilitate the decision-making process in the early design stage through a holistic approach able to consider several performance indices. The PhD project intends to suggest a methodology to investigate the performance indices of adaptive façades and their link with building performance.

Research Questions

Main question

How can the holistic assessment of building performance be realised starting from the characterisation of an adaptive envelope component?

Sub-questions

1. How to consider the adaptive façade dynamic characteristics in modelling phase?
2. Which is the relationship between the dynamic component characteristics and building performance ?
3. How to consider benefits and drawbacks for a considered solution and propose easier indices for early-design stages?

Research Objectives

This research aims to provide a methodology for the assessment of the holistic assessment of building performance and the characterisation of the adaptive envelopes. Adaptive envelope components will be analysed by means of numerical modelling in order to consider, at first, the façade dynamic behaviour and later the whole-building performance.

This will be done through the following steps:

1. Choice of a case study integrating one or more kinds of adaptive façade;
2. Simulation of component's dynamic behaviour through a numerical tool such as EnergyPlus;
3. Implementation of energetic simulation by LCA, LCCA and comfort approaches;
4. Development of the holistic assessment linking the specific performance indices;
5. Definition of easier indices for the decision-making in the early design stages.

Research Deliverables

1. Review of performance assessment methodologies and their limits faced with adaptive envelopes;
2. Review of numerical tools and methods for a holistic assessment;
3. Summary of required performance parameters for a case study, concerning the envelope component and the whole-building;
4. Methodology development and proposition for a case study.



The holistic performance in the early design stage
(source : <http://www.jhdarchitects.co.uk>)



Dynamic facade (Kiefer Technic Showroom) Bad Gleichenberg, Autriche
(source: <https://www.architonic.com/fr>)

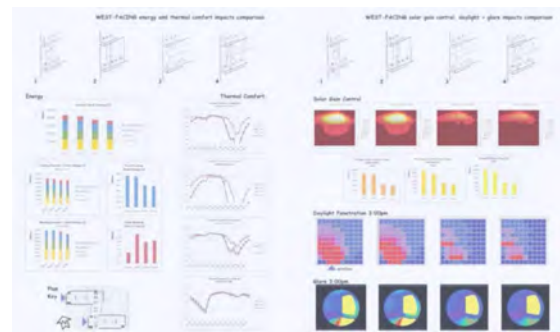

Performance results for a case study analysed by several modelling tools
(source: <http://info.aia.org/EnergyModeling.aspx>)

► **Researcher:** Francesca Contrada

► **Supervisors:** Christophe Gobin, Andrea Kindinis, Jean-François Caron,

► **Time span:** 2015-2018

► **Contact data:** fcontrada@estp-paris.eu

► Associated Publications:

- F. Contrada et al, *Bâtiville: conception d'un îlot urbain optimisé*. IBPSA 2016, Champs sur Marne, France

Thermodynamic Simulation of Ventilated BiPV Facade Coupled with Phase Change Material

► Jakub Čurpek, Department of Building Construction, Faculty of Civil Engineering, Slovak University of Technology in Bratislava

► Research information

Introduction, Background to the Research

Activating the building facade by incorporating solar technology is necessary due to insufficient area on the roof, for meeting standards of EPBD from the European union. Building integrated photovoltaic (BiPV) ventilated facade coupled with phase change material (PCM) is the certain type of building responsive element in the whole envelope, designed by using selective approach. PV system provides electricity production and PCM could provide mitigating PV operating temperature, storing heat energy and consequently releasing it during night time, as well as decreasing of whole overheating of urban space during hot sunny days. This material combination signifies correlation between facade engineering and building services. Decentralized energy production by facade could be directly used for heating/cooling loads. PCM can provide good thermal inertia of outer layer well it can be considered as some „warm coat“ for building. Facade air cavity can be used as low-temperature energy source by additional decentralized building component such as heat pump or air conditioning systems. Generally, indirect solar expansion solar assisted heat pump (air source) can be considered as combined system with BiPV+PCM solar collector in many ways. The main intension of research is detailed investigation of performance and efficiency of this novel adaptive facade as the effort to achieve net-zero energy building.



Research problem

Thermo-physical properties of this adaptive facade are changing over time as well as energy production from renewable resource. In order to, computing simulations would provide suitable outputs, simulation process have to be pursue in narrow time-steps. In addition to, simulation of the electricity production by PV does has to take into account the heat transfer process between PCM and PV and rear-side ventilation as well. Heating of circulating air in the cavity of facade by releasing latent heat from PCM is nonlinear due to diurnal solar intensity that determinates charging process. Air temperature in the cavity is varying over time and it is difficult to establish efficiency of air source heat pump. Commonly, air cavity have high temperature than outdoor air so intensity of heat transfer from inside to outside changes over time.

Research Questions (Main Questions and sub question)

Main question

–“How can the investigated adaptive facade influence energy performance of smart or net-zero energy building in the path to meet the requirements of the European union?”

Sub-questions

- “Which type of PCM with intrinsic enthalpy function is the most suitable for efficiency of the facade in the certain location of building?”
- “How can PCM and rear-side ventilation influence the operating temperature of PV cell and consequently electricity production?”
- “How much thermal energy can be utilized by discharging process of PCM in the air cavity during night time?”
- “What is intensity of heat flux between inside and outside through the facade?”
- “Does investigated facade play important role in the efficiency of adjoined building services, if yes, in which way?”
- “When the heating/cooling loads are the most affected by this facade?”

Research Objectives

Many researches have been done in the separate fields yet, how to decreasing PV temperature by PCM, effect of ventilated BiPV facade, interconnection of PV as evaporator of heat pump. However, no one tried to investigate these research in the whole one and to create certain type of high performance adaptive facade.

This will be done thorough following objectives:

1. Analyze diurnal thermodynamic performance of PCM in the narrow time-step.
2. Define electricity production of PV cell coupled with PCM accordance to operating temperature function .
3. Estimate amount of releasing thermal energy by discharging process of PCM.
4. Analyze hypothetical thermal barrier as „warm coat“ through heat exchange.
5. Evaluate the efficiency of air source heat pump connected to the air cavity.
6. Experimental analyze of investigated facade in the real dynamic climatic conditions and laboratory testing in a climate chamber and twin boxes.
6. Assess the overall performance of BiPV+PCM adaptive facade.

Research Deliverables

1. Worldwide outlook of BiPV facade systems and PCM thermal management.
2. Eligible control strategy methods enable the integrated adaptive facade to work in an efficient way in cooperation with HVAC systems under various climatic conditions.
3. Mathematical interpretation of non-linear changes of facade thermal performance in accordance to weather changes in the investigated climatic zone.

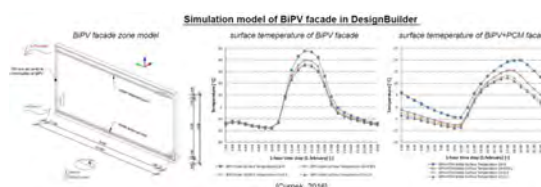
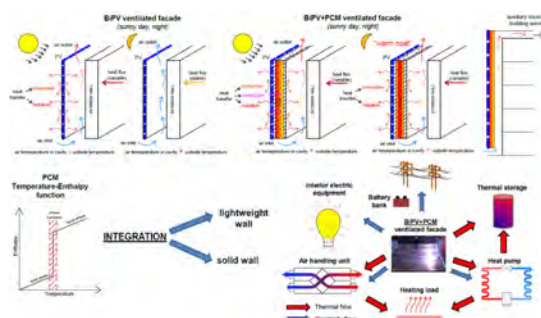

- **Researcher:** Ing. Jakub Čurpek
- **Supervisors:** prof. Ing. Jozef Hraška, Ph.D.
- **Time span:** 2015-2019
- **Contact data:** jakub.curpek@gmail.com
- **Associated Publications:**

- J. Čurpek, J. Hraška, *Simulaton Study on Thermal Performance of a Ventilated PV Façade Coupled with PCM, enviiBUILD 2016, Brno, Czech Republic*
- J. Čurpek, J. Hraška, *Simulation on influence of PCM melting point temperature on thermodynamic behaviour of ventilated BiPV facade, ATF 2016, Leuven, Belgium*
- R. S. Kamel et al., *Solar systems and their integration with heat pump: A review, Energy and Buildings 87 (2015) 395-412*
- T. Ma et al., *Using phase change materials in photovoltaic systems for thermal regulation and electrical efficiency improvement: A review and outlook, Renewable and Sustainable Energy Reviews 43 (2015) 1273-1284*

► Paul-Rouven Denz, TU Delft / Facade-Lab GmbH

► Research information

Introduction, Background to the Research

The building skin as layer between interior and exterior has to fulfil many functions and at the same time be flexible to adapt to environmental conditions and user needs. Smart Textiles with its multifunctional, adaptive and/or self-sufficient character would therefore be a highly interesting material to be integrated into the building skin. But so far smart textiles are not used in the façade in contrast to automotive industry, medical technology or mechanical engineering.

Research problem

In building industry, responsible for approximately 10% of Europe's GDP, Smart Textiles are almost never used. High requirements in durability and stability as well as the large-scale of building elements have so far prevented an integrative usage of Smart Textiles for smart building components or smart surfaces.

Research Questions (Main Questions and sub question)

Main question

How can Smart Textiles be executed within the building skin?

Sub-questions

What kind of functions and requirements can be covered by Smart Textiles?

What are limits and restrictions for Smart Textiles in building skins?

How can these Smart Textiles be integrated constructively?

What surplus may these Smart Textile Skins have to currently used façade solutions?

Research Objectives

The research examines general drivers and barriers for textile building skins and aligns these with the new development. Based on these the construction of the Smart Textile, its functionality and its holistic integration into the building envelope is developed and tested by simulations and prototypes. Thus showcasing the possible usage of Smart Textiles in building construction and especially façades.

1. Analysis of smart textiles and textile constructions
2. Definition of smart textiles in the context of the built environment
3. Functional integration of smart textiles into the building skin
4. Constructional integration of smart textiles into the building skin
5. Fabrication and measuring of prototypes of smart textile building skin
6. Marketability of smart textile skin based on previous development

Within the PhD a Research & Development project called ADAPTEX is executed with the support of research institutes and industrial partners developing a specialized smart textile for and its integration into the building envelope.

Research Deliverables

1. Definition of smart textiles in the context of the built environment
2. Matrix on smart textiles in accordance to building integration and properties
3. Constructional concepts for smart textile skins
4. Smart textile skin prototype

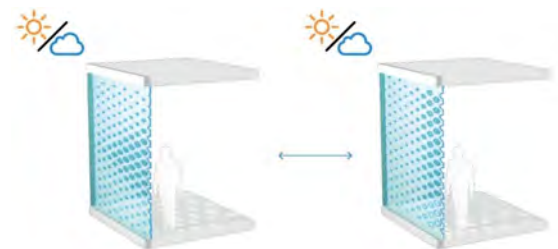
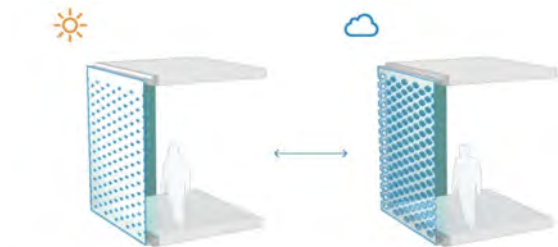

- **Researcher:** Paul-Rouven Denz
- **Supervisors:** Prof. Dr.-Ing. Ulrich Knaack, TU Delft/TU Darmstadt
Prof. Dipl.-Ing. Christiane Sauer, KH Berlin
Prof. Dr.-Ing. Tillmann Klein, TU Delft/TU Munich
- **Time span:** 2016 - 2021
- **Contact data:** paul.denz@facade-lab.com
- **Associated Publications:**

- Sauer, C.; Denz P.-R.: ADAPTEX, Entwicklung eines textilen Halbzeuges zur Anwendung als Basisprodukt für intelligent-adaptive Hüllen im architektonischen Kontext durch technische und funktionale Integration von Formgedächtnislegierungen in der textilen Werkstoffebene. Smart² Netzwerkbericht, Bautzen (2016)
- Haase W.; Sedlbauer K.; Klaus, Th. Sobek W., Schmid, F.; Synold, M.; Schmidt T.: Adaptive textile und folienbasierte Gebäudehüllen. In: Bautechnik 88 (2011), Nr. 2 S. 69-75

Design of tall office buildings from the aspect of energy efficiency in climatic conditions of Belgrade

ADAPTIVE FACADES 2016
HAMBURG

► Andjela Dubljevic, University of Belgrade – Faculty of Architecture, Department of Architectural Technologies

► Research information

Introduction, Background to the Research

The aim of this research is to investigate possibilities for design and construction of tall buildings in Belgrade, Serbia. Last significant tall buildings in Belgrade were built 40 years ago and since then there were some projects for development of city but none of them was realized, not only because of political and economic issues, but also due to problems in the technological development. The aim of the research is to create recommendations for tall office buildings design particularly from the energy efficiency aspect.

Research problem

The main problem is to consider the possibilities of adapting and improving common designs concepts of tall buildings, taking into account Belgrade conditions.

Research Questions (Main Questions and sub question)

Main question

"In what way does the form, building materials and facade concepts of tall buildings affect energy consumption for cooling and heating in climatic conditions of Belgrade?"

Sub-questions

1. "What are the most common types of tall buildings in the world?"
2. "What are the specifics of certain typologies from the aspect of energy efficiency?"
3. "Which are the key issues of the facade concepts of tall buildings in terms of thermal comfort?"

Research Objectives

Firstly, research includes making of typologies based on form, building materials and facade concepts of existing tall buildings in the world. In addition, intention is to make several models based on the previous typologies and examine them through simulations, considering aspects of energy efficiency. The final step is to analyze and compare results that have been gathered through simulations, in order to give recommendations for designing of tall office buildings in climatic conditions of Belgrade.

This will be done through the following objectives:

1. Review of the state of art of the most common types of tall buildings built worldwide.
2. Identification of different typologies of tall buildings based on form, building materials and facade concepts.
3. Design of hypothetical models of tall buildings in Belgrade climate conditions.
4. Numerical simulations of different hypothetical models from the aspect of energy consumption.
5. Comparison of results.
6. Creation of recommendations.

Research Deliverables

1. Review of tall building typologies.
2. A summary of criteria for the analysis of models of tall buildings from the aspect of energy consumption for cooling and heating.
3. Recommendations for the design of tall buildings based on comparison of previous results.



- **Researcher:** Andjela Dubljevic, ing.- arch.
- **Supervisors:** Professor, Aleksandra Krstic-Furundzic, PhD, ing. - arch.
- **Time span:** 2014-2020
- **Contact data:** andjela.dubljevic@arh.bg.ac.rs
- **Associated Publications:**
 - Sudimac, B., Dubljevic, A. (2015) "Solar energy - design element", *International Conference Education, Research & Development Science and Education Foundation, Bulgaria, 04. – 08. September 2015., Elenite Holiday Village, Bulgaria. Materials, Methods & Technologies - Journal of International Scientific Publications, Volume 9, 2015, 626-634. (ISSN 1314-7269).*
 - Krstic-Furundzic, A., Sudimac, B., Dubljevic, A. (2014) "Energy And Environmental Aspects Of Improvement Of Office Building By Application Of PV Modules", in the *Proceedings of the Fifth International scientific-professional symposium Installations & Architecture, Faculty of Architecture, University of Belgrade, Belgrade, Serbia, 12-22. (ISBN 978-86-7924-133-7, COBISS.SR-ID 2 12389900).*

Biomimetic principles in the design of adaptive building skins. Methodology and application.

► Mario Fernández. Department of Architectural Technology and Construction, Polytechnic University of Madrid.

► Research information

Introduction, Background to the Research

Adaptive building skins emerge as a necessary evolution of facades, for their ability of adaptation to climate, environment and changing uses of buildings, improvement of energy performance and greater efficiency in the use of materials.

The development of adaptive building skins is just beginning to raise. Despite the increasing number of scientific papers and research projects, it's still limited mainly to experimental prototypes.

Adaptive behavior is new to building skins; given its parallel with the adaptive behavior of natural organisms, it seems logical to look for adaptive strategies of natural organisms as a source of inspiration, so that, according to current researches, adaptive behaviour of building skins is improved; could serve as a tool for finding better solutions and as a driver of innovation in architectural technology, and would allow us to take advantage of the great amount of knowledge of evolution. Nevertheless, creating a suitable design process is still a challenge.

Research problem

The problem that this research tries to solve is how to use and exploit the source of knowledge of adaptive strategies of natural organisms in a systematic way, so that they can be applied in the design of architectural building skins.

Research Questions

Main question

How to systematize the application of natural adaptation strategies in the design of adaptive building skins?

Sub-questions

1. How to draw a parallel or correlation between architectural functions and biological functions of natural organisms,
2. How to select adaptation strategies appropriate to each case depending on the functional requirements of architectural envelopes.
3. How to integrate into the design process strategies that respond to different and/or conflicting requirements.
4. How to abstract the underlying principles and integrate them into the design process.
5. How to simulate adaptive behavior of envelopes with current design tools.
6. Which criteria should be used to evaluate the results obtained, following biomimetic principles.

Research Objectives

1. Establish classification criteria for adaptive strategies, from the point of view of its architectural application.
2. Define behavioral patterns of natural organisms in relation to environmental adaptation strategies.
3. Establish design criteria for selecting adaptation strategies and integrate them into the design process.
4. Develop a methodology for implementing adaptation strategies and patterns of natural organisms in the design of adaptive building skins.
5. Analyze current technologies and development possibilities for its use in building skins.
6. Propose the use of digital simulation tools for adaptive behaviour.
7. Establish criteria for evaluating adaptive building skins from the point of view of biomimetic principles and environmental regeneration,
8. Develop a prototype of an adaptive building skin according to biomimetic criteria.

Research Deliverables

1. A taxonomy of adaptive strategies according to the requirements of adaptive building skins, so that it can represent a useful biological knowledge in the design of architectural envelopes.
2. A methodology to select strategies, manage conflicting requirements, and systematize the application of a biomimetic approach to the design of building skins.
3. An application protocol of modeling and simulation tools, suitable to adaptive and changing behavior of adaptive building skins.
4. A prototype as an application model which will allow to compare, validate and improve this methodology in a process of continuous improvement.

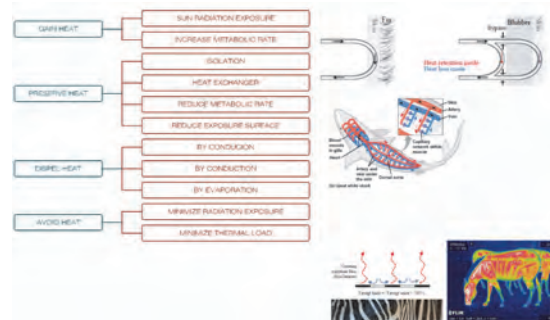
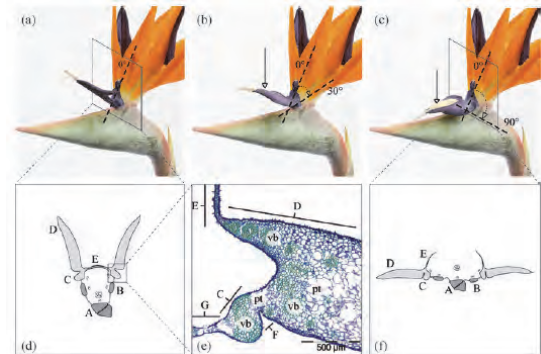

- **Researcher:** Mario Fernández Cadenas
- **Supervisors:** Francisco Javier Neila González
- **Time span:** 3 years.
- **Contact data:** mf@ofaa.eu
- **Associated Publications:**

- M. Fernandez, F.J. Neila. Biomimicry in climate adaptive building skins. Relevance of applying principles and strategies. 2015, VII International Congress of Architectural Envelopes, San Sebastian, Spain,

► Matthias Förch, HafenCity University Hamburg

Introduction, Background to the Research

Main target in building and facade design is to protect people inside the building and to reduce damages in the facade and main structure to minimize the risk of building collapse. Investigations of bomb blast attacks show that the large part of fatal casualties were caused by glass splinters of broken windows acting as missiles. Therefore, the glazing system is an important issue within the design of blast enhanced facades. Basically it is required that the glass panels remain in the facade frames during a bomb blast event and that hazard criteria are fulfilled if specified. E.g. ISO 16933 specifies hazard criteria for windows during arena tests, where a witness panel is installed behind the tested window. After the blast test the witness panel is inspected for perforations and indents resulting from the blast.

Research Problem and Objectives

Aim of the research project is to determine short time design values for glass surface strength of glass products used for windows and facades that are required for impact or blast loading. Beside other aspects load duration and tempering level influence the glass surface strength. Microscopic surface flaws can grow under permanent load, e.g. dead load, before glass fracture occurs with delay. Therefore every glass code offers surface strength design values for untempered glass products depending on the load duration. The shorter the load duration is, the higher is the design surface strength. Usually long term (dead load), mid term (snow) and short term loading (wind) is distinguished. The German glass standard DIN 18008 considers the load duration by k_{mod} factors, which are based on fracture mechanical model. For long term load duration the fracture mechanical model can be verified by long term tests. Due to high complexity of such tests for short load duration, occurring during impact or bomb blast events, there are only limited test data available to confirm the theoretical fracture mechanical model. The available test data result from complex pendulum or shocktube tests, but these data are not sufficient for a solid statistical determination of characteristic fractile values (5 % fractile, 95 % quantile). Therefore there is a lack in the verification of the theoretical fracture mechanical model, especially in terms of high strain rates.

Research Methods

200 glass specimen with the dimensions 1100 mm x 360 mm are tested by four point bending test. The tests are run with standardized strain rate ($2,9E-05 s^{-1}$) as well as with high strain rate ($2,3E-02 s^{-1}$) on the same testing machine in order to investigate strain rate behaviour of glass surface strength. All common glass types in building sector, untempered glass (Float), heatstrengthened glass (HST), and fully tempered glass (FT) are subjected for testing.

In order to achieve a predamage of the glass surface comparable to long term site conditions and to reduce the variation of the test results, the glass specimen are treated with corundum. Another positive effect of such predamage treatment is, that the initial crack of the specimen is avoided to start from the edge. The high-speed tests are performed up to surface stress rates of $2000 Nmm^{-2}s^{-1}$, which are typical for impact or bomb blast events. The surface strains during testing are investigated by strain gauges and high-speed measurement amplifier. In addition high-speed cameras are used to monitor the location of initial crack.



Facade of Brussels airport after the terror attack on 22.03.2016 [nzz.ch].

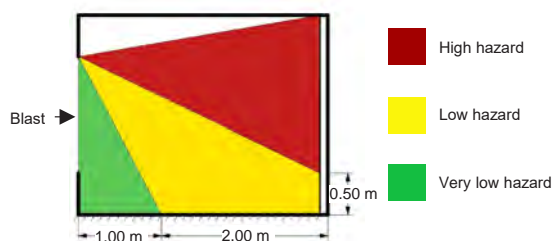

Hazard criteria for windows according to ISO 16933.

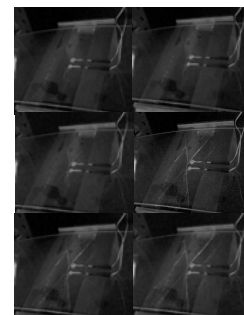

Left: Four-point-bending-test setup in high-speed testing machine. Right: Untempered float glass specimen in breakage phase during high-speed test monitored with high-speed camera in 30.000 fps mode.

- **Researcher:** Dipl.-Ing. Matthias Förch
- **Supervisor:** Prof. Dr.-Ing. Frank Wellershoff
- **Funding:** Fachverband Konstruktiver Glasbau e.V.
- **Time span:** 2015-2016
- **Contact data:** matthias.foerch@hcu-hamburg.de

▶ Matthias Friedrich & Klaus Schweers, HafenCity University Hamburg

▶ Double Facade System with natural ventilation in optional flow path

User Comfort and Double Skin Facades

Due to the lack of sufficient design guidelines for double skin facades the energetic and acoustical aspects are often not sufficiently considered and the design is primarily driven by aesthetic perspectives. Complex thermal effects in the facade cavity often lead to losses in energy efficiency and user comfort.

The Bypass Double Skin Facade

The main aim of the bypass double facade is to maintain the user comfort and to protect the interior against overheating in summer without active cooling or mechanical air ventilation. Therefore the focus of this facade are bypass air channels through which the external air will be directed into the interior without absorbing additional thermal energy in the regular facade cavity. In winter time this absorbed energy in the facade cavity will be used to reduce the demand of heating energy. The energetic conception of the facade and the dimensions of the bypass channels and all louvers is based on four climatic design cases.

Climatic Case I – cloudy winter day

Limitation of the air exchange rate to the hygienic required minimum to minimize heat losses. For the intelligent control of the louvers, the CO₂-level of the room air will be measured. A heat recovery system will be used.

Climatic Case II – sunny winter day

The inlet air is preheated by the heat recovery system. Then the inlet air is directed through the facade cavity to gain additional thermal energy before it reaches the opening to the interior.

Climatic Case III – hot summer day

Limitation of the air exchange rate to the hygienic required minimum to reduce heat gains in summer. The inlet air flows is directed through the bypass channel directly to the interior to avoid additional heating in the cavity.

Climatic Case IV – summer night cooling

Maximize the heat convection from inside to outside. The air exchange rate is limited by air velocities which may occur damages during the night or by user comfort (draught) during the morning.

Dynamic facade control system

Electromotive adjustment of the facade openings based on decision data. A field bus system records air temperatures, concrete core temperatures and CO₂-data for the control system. The systems aim is to keep the room air temperature in the comfortable zone according to the adaptive comfort model in DIN EN 15251 and to maintain a hygienic CO₂-level. Additional data like humidity, air velocities, surface temperatures of walls and glass, solar radiation, illuminance and pressure differences will be recorded for verification of transient models that can be used for parameter studies.

Target results of the research project

It is aimed to provide simple design tools for dimensioning of double facades with natural ventilation for building planners. Recommendations for advanced dynamic control methods will be given.

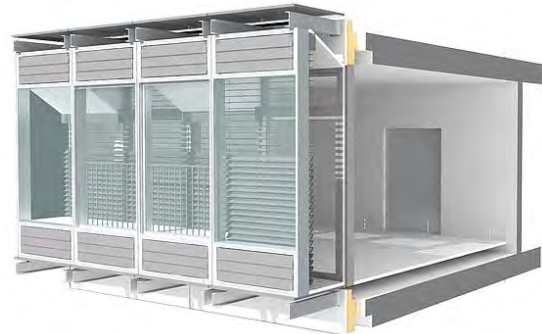

▶ Fig. 1: Rendering of the test room equipped with a bypass double skin facade

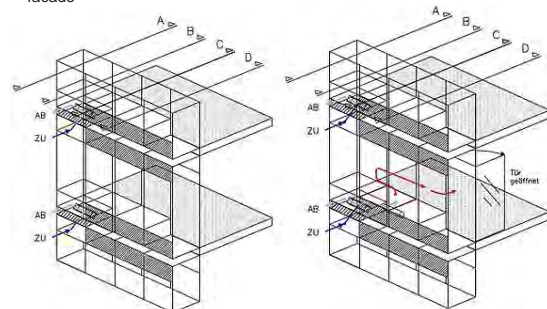

▶ Fig. 2: Variable air flow directions in climatic case I (left) and II (right)

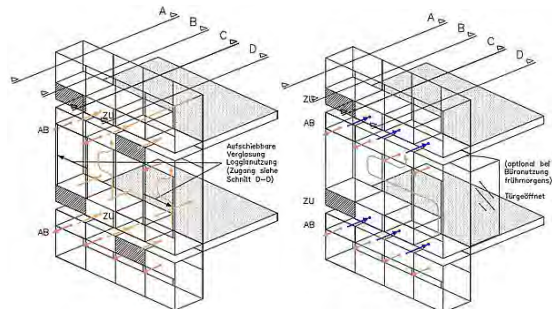

▶ Fig. 3: Variable air flow directions in climatic case III (left) and IV (right)

- ▶ **Researcher:** M.Sc. Matthias Friedrich & M.Eng. Klaus Schweers
- ▶ **Supervisors:** Univ.-Prof. Dr.-Ing. Frank Wellershoff
- ▶ **Time span:** 2014-2017
- ▶ **Funding:** Bundesministerium für Wirtschaft und Energie (BMWi) Forschung für Energieoptimiertes Bauen (EnOB)
- ▶ **Contact data:** frank.wellershoff@hcu-hamburg.de

Performance assessment for technological design of innovative BIPV façade systems

► **Mohammadhossein Ghasempourabadi**, Graduate Research Assistant, SEAC-TU/Eindhoven-TU/Delft- 3TU, The Netherlands

► Research information

Introduction, Background to the Research

This PDEng project is related to the development of two of types of building-integrated photovoltaic (BIPV) façade systems: SoloWall and ZigZagSolar. SoloWall is a modular type of BIPV for integration in vertical facades, developed by SCX Solar. ZigZagSolar, developed by Wallvision, uses a series of slanted reflectors and solar modules to augment the PV yield of vertical BIPV while giving special attention to architectural integration.

Research problem

Experiments: After scaling up from conceptual ideas and initial mock-ups to a full-scale prototype, real characteristics and benefits of the technology can be investigated and demonstrated under realistic operational conditions.

Modelling and simulation: Complementary to experiments, the development of a reliable enough simulation model can help the developers to understand the performance of their product under different what-if scenarios, since such a virtual testbed allows us to apply changes in simulation parameters and predict the outcomes for variant situations. The simulation model can be calibrated with inputs from the experiment.

Understand the needs of stakeholders: The first step is to identify performance aspects and indicators (e.g. the amount of radiation that is received by PV panels, the amount of electricity generated by the PV panels, payback of the system) that are actually of interest to the end user, in relation to system design considerations and physical principles. Such a study will give insight into what should be measured and modelled, and will later also help to propose design variants in response to promising business strategies.

Research Questions (Main Questions and sub question)

- ❖ Which of the two façade systems is performing better in one year period? (And have related comparison with the help of simulation)

Sub-questions

- 1) What are the performance indicator of each system?
- 2) How we can improve the performance of each system?
- 3) Find out each system suites for where, and with what orientation and characteristics?

Research Objectives

This project aims at supporting the development of two innovative BIPV façade systems by making the connection between research outcomes and technological design opportunities. The following three objectives are identified:

- ❖ Further investigation of PV integrated solar façade systems and their potential to generate power, with the help of experimental validation and calibration of a simulation model.
- ❖ Generate and suggest new ideas as an approach to whole system design for this type of BIPV façades.
- ❖ Find business applications based on scientific data from simulation and experiment to provide better understanding of the whole project and a better value proposition to the owners and to future customers.

Research Deliverables

Related to the project scope and objectives as identified in the previous section, the following deliverables are planned:

- ❖ Further development of the existing simulation models, validated with experimental data.
- ❖ A report with analysis of measurement data in relation to meteorological observations and sky conditions.
- ❖ A database with clear estimations of whole system performance to introduce a technological design fact sheet and design support approach to empower Wallvision and SCX Solar and customers to easily interpret performance information for desired climate, façade orientation and etc.
- ❖ Business plan explorations for proposing this new generation of façades to the market. This report includes strategic information about the benefits of this type of BIPV façades, possibilities for customization of the façade systems, and market evaluation and potentials.



- **Researcher:** Mohammadhossein Ghasempourabadi
- **Supervisors:** Jan Hensen, Roel Loonen, Roland Valckenborg
- **Time span:** 2014-2017
- **Contact data:** M.Ghasempourabadi@tue.nl
- **Associated Publications:**

- M.Ghasempourabadi, Xin Xu, Roel C.G.M. Loonen, Jan L.M. Hensen, Roland M.E. Valckenborg, *Development and validation of a discretized solar irradiance model for tilted collectors augmented by planar reflectors*. *Solar Energy*, under review, July 2016.
- M.Ghasempourabadi, K.Sinapis, R.C.G.M. Loonen, J.L.M. Hensen, *Towards simulation-assisted performance monitoring of BIPV systems considering shading effects*, 43rd IEEE Photovoltaic Specialists Conference, June 5 - 10, 2016, Portland, USA

Transparent adaptive façades: a novel approach to optimise energy and comfort aspects

► Luigi Giovannini, Politecnico di Torino, DENERG - Department of Energy, TEBE Research Group

► Research information

Introduction, Background to the Research

The research is aimed at bridging the existing methodological gap between novel transparent adaptive façade components characterisation and their application to real spaces with occupants. Starting from the most recent findings in literature, this study proposes to identify new strategies and concepts concerning the integration between energy and comfort issues, as well as new testing procedures and evaluation methodologies to assess them.

Research problem

Adaptive façades, often relying on novel materials and concepts, are particularly complex to be comprehensively characterised, due to their dynamicity and the high level of interdependency among different performance aspects: requirements concerning energy, lighting and acoustical behaviour have to be contemporarily satisfied and priority criteria need to be identified. Presently, these different aspects are not addressed through a synergic approach and most analyses are focused on the performance of the façade components only, without considering their application to real spaces.

Research Questions (Main Questions and sub question)

Main question

- "How can dynamic components be characterized in a synergic way so as to simultaneously take into account their performance in different aspects and at different levels?"

Sub-questions

1. "How can the visual comfort be assessed from the adaptive component point of view?"
2. "How can visual and thermal comfort be assessed with a synergic approach?"
3. "How can the comfort aspects be linked to the component (and the building) energy performance?"

Research Objectives

In the field above defined, a systematic approach from different points of view at a time has a limited literature background, being addressed at present time mainly the thermal aspects, without much regard for visual comfort problems. The objectives of this research, which will imply both architectural and energetic benefits, are therefore the following:

1. Characterisation of the adaptive components from the visual comfort point of view
2. Study of the correlation between visual comfort and thermal comfort provided by the adaptive components
3. Definition of a novel methodology to assess the performance of transparent adaptive façades, with regard to the component alone and to sample rooms, as a trade-off between energy performance and comfort for the occupants
4. Definition of ad hoc metrics to robustly and comprehensively characterise these new adaptive technologies
5. Validation of the research outcomes by means of experimental campaigns and modelling activities

Research Deliverables

1. A novel methodology for the optimisation of dynamic façade components as most viable trade-off between the energy use optimisation and the comfort issues
2. New performance metrics both for the component performance (with particular attention to the visual behaviour) and for the environmental performance, as well as for end users' acceptance

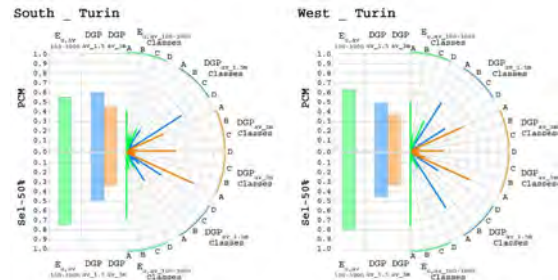
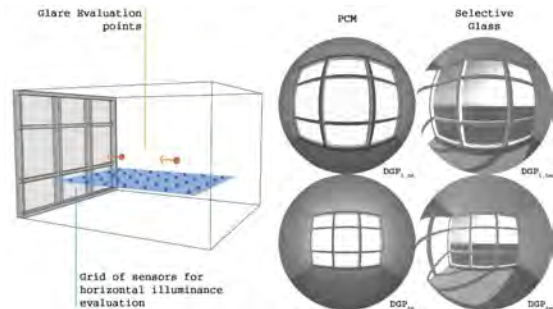

- **Researcher:** Luigi Giovannini
- **Supervisors:** Valentina Serra, Valerio RM Lo Verso, Anna Pellegrino
- **Time span:** 2015 - 2018
- **Contact data:** luigi.giovannini@polito.it
- **Associated Publications:**

- Giovannini L, Goia F, Lo Verso VRM, Serra V. Phase Change Materials in glazing: implications on light distribution and visual comfort. Preliminary results. SEB-16, Turin, Italy. Accepted for Publication
- Giovannini L, Lo Verso VRM, Karamata B, Andersen M. Lighting and Energy Performances of an Adaptive Shading System for Arid Climates. IBPC 2015, Turin, Italy. In: Energy Procedia 2015, vol. 78, pp. 370-375.
- Karamata B, Giovannini L, Lo Verso VRM, Andersen M. Concept, Design and Performance of a Shape Variable Mashrabiya as a Shading and Daylighting System for Arid Climates. PLEA 2014, Ahmedabad, India.
- Lo Verso VRM, Serra V, Giovannini L, Iannarella S. Light versus Energy Performance of Office Rooms with Curtain Walls: A Parametric Study. SEB-14, Cardiff, Wales. In: Energy Procedia 2014, vol. 62, pp. 462-471.

► Giulia Grassi, Pisa School of Engineering, Building Engineering and Architecture

► Research information

Introduction, Background to the Research

This study wants to show the effective benefits of a green facade developing a sustainable living wall system for the retrofit of existing buildings. The effects of plants on thermal performance of a building are evaluated with a mathematical model that takes into account all the processes happening in the wall heat exchange. The reduction of heat flux is evaluated in comparison to the bare façade. A case of study is developed as an example of application of the system proposed.

Research problem

The main issue for the calculation of benefits gained from the retrofit is to find an appropriate mathematical model to describe heat transfer processes inside the green layer. The challenges to design the façade system are: the integration of devices for energy production and storage, water distribution, structural and environmental features of materials employed.

Research Questions (Main Questions and sub question)

Main question

How much can we gain in terms of flux reduction?
How can we design a sustainable living wall?

Sub-questions

Which are the parameters that affect more the flux reduction?
Which are plants needs and how can they be related with the building needs?
Can we produce and harvest energy from plants?
Which material can be employed that has good structural characteristics and can be easily assembled?

Research Objectives

- 1) Definition of a mathematical model
- 2) Model sensitivity analysis
- 3) Parametric architecture that integrates plants needs and varieties, and building's features
- 4) Digital fabrication as a process of design
- 5) Bio electrochemical systems based on plants for energy production

Research Deliverables

- 1) Review of greening wall systems and in particular of LWS features
- 2) Results in terms of flux reduction through the installation of a living wall on an existing building, comparison between different kind of existing walls, comparison with a bare wall, comparison between parameters that affect the leaf temperature.
- 3) Design of a living wall (strategy, drawings, technical data)

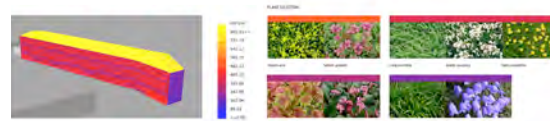
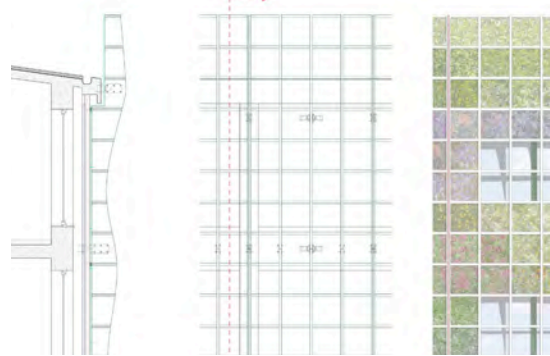
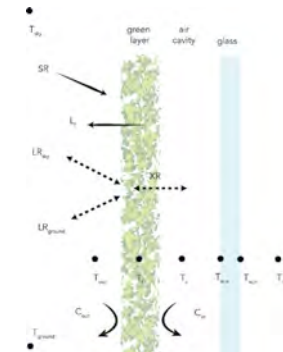

- **Researcher:** Giulia Grassi
- **Supervisors:** Francesco Leccese, Rodrigo Rubio, Lorenzo Secchiari
- **Time span:** 2015-2016
- **Contact data:** grassi.giulia@hotmail.it
- **Associated Publications:** none

► Philippe Hannequart, Université Paris-Est, Laboratoire Navier – ENPC, Arcora (Ingérop Group)

► Research information

Introduction, Background to the Research

Buildings with high glazing ratios often rely on shading devices to avoid summer overheating. Fixed devices are efficient only for specific orientations, and mobile devices, besides limiting architectural expression, require an expensive maintenance program. For this reason, new materials which could change shape without mechanical linkages and bypass the use of motors and complex actuation systems are investigated.

Research problem

Assessing the potential of composite structures with shape memory alloy actuators as morphing solar shading devices for facades is the core of the research. This will be done through the development of material behaviour models, numerical simulations, experimental investigations and full-scale prototyping.

Research Questions

Main question

- "How to integrate shape memory alloy actuators and fibre reinforced polymers in order to design deformable solar shadings for facades, with controlled, reversible and cyclic movements?"

Sub-questions

1. Which shape memory alloy thermomechanical model should be used?
2. Which alloy composition for which phase change temperature should be used?
3. Which kinematics comply with the material parameters of all constituents and with the shading requirements?
4. How to fulfill the constraints of facade integration? (respecting building codes, fire safety requirements, etc...)"
5. How to control the precise movement of the shading system?
6. Retrofitting old facades or integrating in new projects?

Research Objectives

After a comprehensive survey on current facade shading systems, the specifications of a morphing solar shading system have been listed. Some key technical constraints as well as constraints of use are being traduced in terms of specifications of material behaviour and design constraints.

In parallel, a fine understanding of the thermomechanical behaviour of composites and shape memory alloys has to be reached. Thus, some existing thermomechanical models will be reviewed, new ones will be proposed, and some calculation tools will be developed in order to model and simulate these smart structures. Besides, experimental campaigns will be carried out in order to validate these tools.

The final objective is the application of the developed concepts: in strong collaboration with a facade engineering consultancy firm, the system's potential for controlling the sunlight and the energy supply in building projects will be demonstrated with energy simulation tools, prototypes and detailed integration proposals.

Research Deliverables

1. A one-dimensional polycrystalline thermomechanical model for shape memory alloy wires, validated by experimental testing, which could be numerically implemented at low computational cost.
2. Enriching a multilayer finite element code (commercial or developed by the laboratory) with a tool for calculations including embedded shape memory alloys.
3. A full-scale prototype highlighting the architectural integration of the novel solar shading system, for communication in scientific journals as well as in technical and architectural reviews.

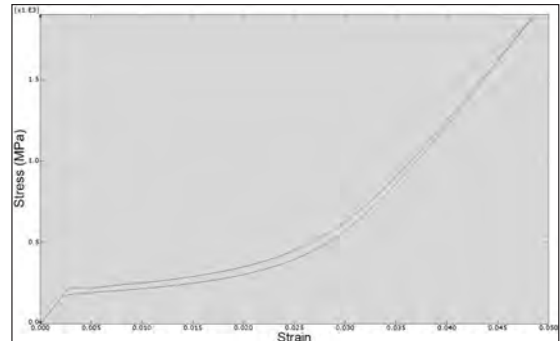

Fig. 1: Tensile Stress-Strain curve, polycrystalline shape memory alloy model

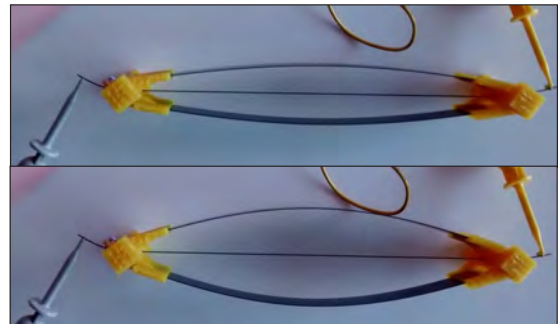

Fig. 2: Shape Memory Alloy wire actuator with bent steel plates

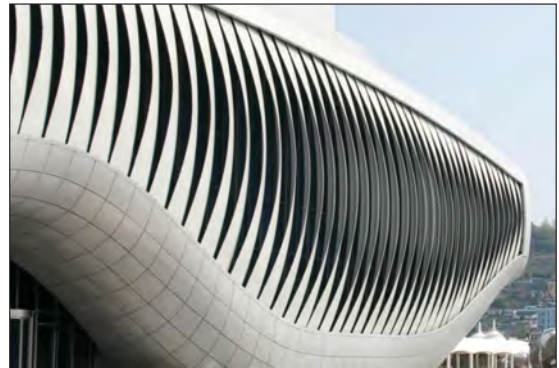

Fig. 3: One Ocean Pavillon in Yeosu, kinetic facade, Knippers Helbig, Soma architecture

- **Researcher:** Philippe Hannequart
- **Supervisors:** Jean-François Caron, Michael Peigney, Olivier Baverel, Emmanuel Viglino
- **Time span:** 2015-2018
- **Contact data:** philippe.hannequart@enpc.fr
- **Associated Publications:**

Security laminated glass with a phosphorescent character; durability of this security laminated glass

► Shawn Ives, Hochschule Anhalt, Architecture, Facility Management, Geoinformation

► Research information

Introduction, Background to the Research Atrial

This research's aim is to give a phosphorescent character to laminated glass using phosphorescent paints. The aim is to find the best combination between the films and paints and an optimised process to have a laminated glass with the same characteristics as standard laminated glasses. These tests are around the durability of the glass (humidity, temperature, adhesion between the different layers). Another point is to know how long this phosphorescent characteristic will last in time. After that, the aim will be focused on the processes for different kind of applications and design.

Research problem

The main problems concern durability. Obtaining a laminated glass with the standard characteristics and also an ability to be phosphorescent in the long term.

Research Questions

Main question

-"How can we produce a laminated glass with a phosphorescent character which will match the security requirements with the use of paint?"

Sub-questions

- 1."What is the limit of the phosphorescent surface part of the glass to get a safe glass?"
- 2."How long will last the phosphorescent character?"
- 3."Will it be possible to use one or several kind of process which will answer several needs?"

Research Objectives

- 1.Finding compatible paints
- 2.Finding the limit surface
- 3.Finding the optimal number of layers
- 4.Identifying and defining what to avoid during the process in order to get a final product free from defects
- 5.Defining a process/several processes to achieve a phosphorescent laminated glass which respect European safety norms and have a long-lasting phosphorescent character

Research Deliverables

- 1.A report of the research with all the steps which lead to a solution
- 2.A working process to produce phosphorescent laminated glass
- 3.Demonstration products

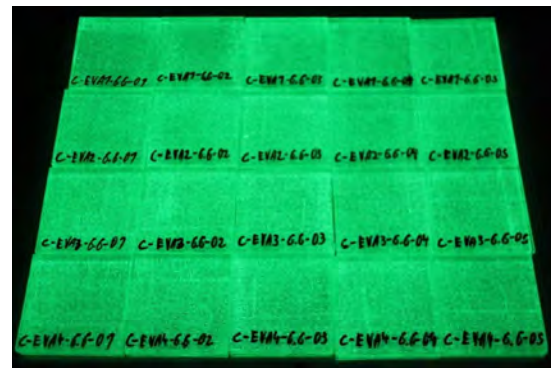
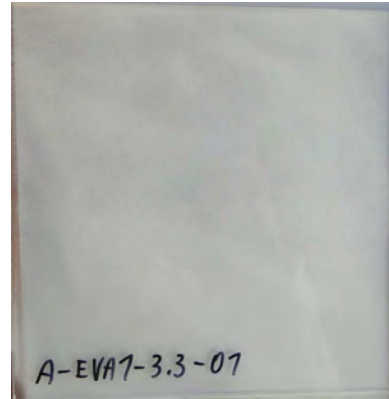

- **Researcher:** Shawn Ives
- **Supervisors:** Professor Doctor Stephan Reich
- **Time span:** 2015-2017
- **Contact data:** Shawn.Ives@hs-anhalt.de
- **Associated Publications:**

Design and assessment of Adaptive facades building upon Atlantic zone resources

► Miren Juaristi, School of Architecture, University of Navarre, Department of Construction, Structures and Facilities

► Research information

Introduction, Background to the Research

The Atlantic Area is characterized by climatic conditions with mild temperatures, smooth temperature fluctuations, high humidity, significant wind conditions, and solar radiation with a large indirect component.

Traditional buildings have responded by protecting against high and uncomfortable relative humidity and windy condition. The chances of an adaptive façade not only protecting from adverse weather conditions but taking advantage of these conditions have not been sufficiently exploited and have great potential.

Research problem

A correct time-scales in an adaptive facade is essential for its optimal operation. Temperate climates demands adaptability to short-term fluctuations, as wind variations or cloud covering and uncovering. The system must be very flexible and quick without being theatrical or losing its architectural quality. Besides, adverse conditions increase the need of maintenance in façade system.

Research Questions (Main Questions and sub question)

Main question

- "Could adverse climatic conditions in Atlantic zone become a favourable resource to reduce energy demand by an adaptive façade system?"

Sub-questions

- 1."How do different façade systems change with natural variable conditions?"
- 2."Which are the main barriers in adaptable façade in temperate climates?"
- 3."How can be combined boundary conditions to reduce discomfort and get energy saving?"
- 4."Will the façade system be designed considering new climatic scenarios due to climate change?"
- 5."Can the façade been changed by the variable condition itself without any computerized action?"
- 6."How and how much should the user be involved in the adaptability of the façade?"
- 7."Which is the relation between energy saving and economy saving?"

Research Objectives

Adaptive façades in temperate climate have not been researched in a detail and there are few building experiences. This research looks to develop a system suitable for Atlantic zone, which turns unfavourable boundary conditions into a protection system through the resilience of materials and dynamic changes in the façade.

This will be done through the following objectives:

1. Defining the State-of-the-art of adaptive façade in temperate climates.
2. Identify existing building solutions to protect from the wind and humidity. Analysed key problems that they deal with.
3. Study architectural limitation and the optimal user interaction with the system.
3. Analyse given current connection details in adaptable façade system.
4. Design the system and test it with computerized simulations (Energy+, Fluent)
5. Develop a mock-up
6. Monitorized the mock-up and analyse the results.
7. Identify key challenges that must be resolved to implement the system in buildings.

Research Deliverables

1. Reviews / state of the art / previous studies applied to Atlantic climate. (Year 1)
2. Design of adaptive prototypes (Year 1)
3. Mock-up manufacturing (Year 2)
4. Monitoring and analysis of its results (Year 2-3)
5. Calibrated simulation (Year 2-3)
6. Implementation through simulation (Year 3-4)
7. Results and conclusions (Year 3-4)

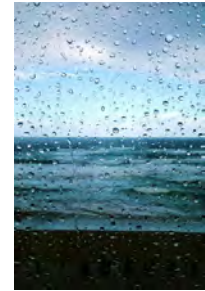

Adverse conditions will not be considered as weakness points but as potentials.

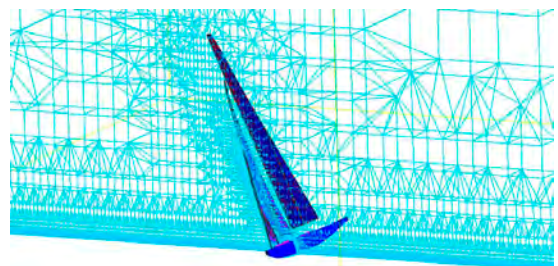

Natural sources and their potential will be analysed in different fields.

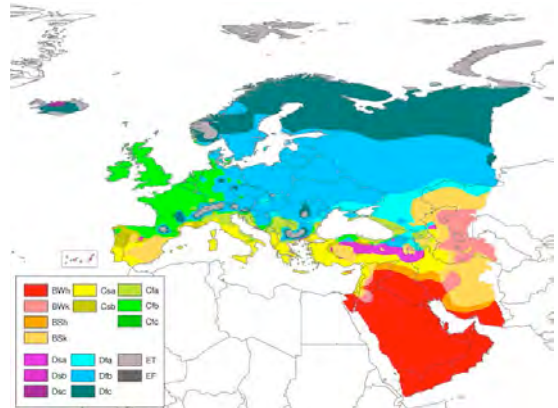

Koppen-Geiger European classification

- **Researcher:** Miren Juaristi
- **Supervisors:** PhD Aurora Monge-Barrio, PhD Tomás Gómez-Acebo
- **Time span:** 2016-2020
- **Contact data:** mjuaristi@alumni.unav.es
- **Associated Publications:**

- Loonen n, M. Trčka, D. Cóstola, J.L.M. Hensen, *Climate adaptive building shells: State-of-the-art and future challenges*.2013

► Aliakbar Kamari, 'Department of Engineering, Aarhus University' & 'Department of Architecture, University of Palermo'

► **Research information**

Introduction, Background to the Research (Research Theme)

Overview of Danish and Italian recent researches and challenges for the future of building renovation context has revealed that present takes on objectives accomplishment at any rate in this context is not fully in accordance with the sustainable development paradigm. The aims of the research is to develop a methodology which reflects the conflicting nature of the criteria guiding decision makers in retrofitting projects via the support of design decision making processes during the conceptual design phase using metric and visual analysis holistically.

Research problem

Compounding the typical challenges of a sustainable retrofitting from theory to implement stages is the lack of an appropriate methodology and decision support tool which takes into account the nature of retrofitting projects initially in order to 'Learning Improvement' among the different stakeholders and then 'Multiple Optimization' through sustainable perspective in its full sense. It should be able to identify, manage, and evaluate the building objectives among different retrofitting alternatives during the early design stages.

Research Questions (Main Questions and sub question)

Main question

- "How can a multi-methodology throughout mixing certain techniques be equipped that primarily influences the society in retrofitting context and secondarily identifies and addresses the sustainability in building renovation? [Due to the diversity of the related design dependencies, prioritization of the most critical elements may be necessary. To this end, the research would be centralized on the envelope retrofitting of the existing buildings components.]"

Sub-questions

1. "How can existing Engineering Design and Decision Making methods from other domains be applied in buildings to benefit retrofitting projects and its stakeholders specifically architects concentrating conceptual design phase?"
2. "The second question seeks to address how can a methodology be extended based on application of the mix methods so as to function as a decision support systems to dissolve the main discovered issues in retrofitting domain, including 'learning improvement' and 'multi-optimization'?"
3. "What are the characteristics of envelopes in existing buildings and a sustainable retrofitting in terms of their specific change requirements? The outcomes of the previous stage will inform the second research question, which explores and develops a change management methodology and method that addresses the unique requirements of retrofitting projects in a sustainable perspective."
4. "The final question seeks to explore how this methodology can allow designers to explore and utilize retrofitting alternatives during the conceptual design stage to support decision making in terms of functionality (performance), feasibility, accountability, or sustainability in its totality. The focus here is on the first stage of the developed methodology."

Research Objectives

- To explore current conflicts against retrofitting of existing buildings process concerning 21st century and rise of complexity in connection with sustainability in its totality.
- To develop a holistic environment and method which initially may both guide and facilitate architect's work via support of design decision making processes during the conceptual design stages indicating the features, constraints, and classification/leveling upon different criteria.
- To demonstrate of how combinations of methods that are parts of soft systems methodologies and MCDM may support multiple perspectives representations of complex managerial problems.
- To promote a methodology to be synchronized specially upon the nature of retrofitting process in order to improve the communication and collaboration through leaning among stakeholders and carry out a real sustainable retrofitting.
- To facilitate designers in their assessment of the benefits and risks concerning to different retrofitting alternatives in retrofit decision making processes and buildings' operation.

Research Deliverables

1. Review of the issues of existing buildings
2. Develop a mix method methodology
3. Develop a Characteristic Diagram and Value Map
4. Study a case in order to validate and enlarge the results

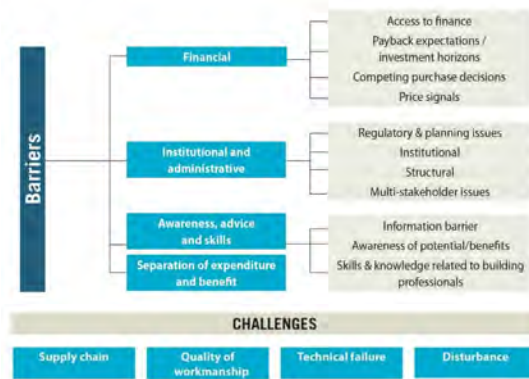
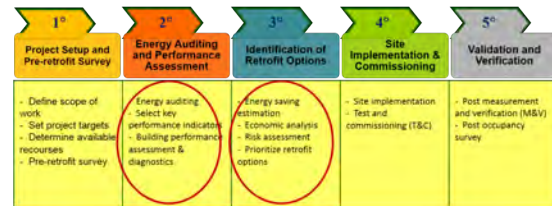

- **Researcher:** Aliakbar Kamari
- **Supervisors:** Poul Henning Kirkegaard - Rossella Corrao
- **Time span:** 2015-2018
- **Contact data:** ak@eng.au.dk , aliakbar.kamari@unipa.it
- **Associated Publications:**

- Kamari, A., Jensen, S.R., Corrao, R. and Kirkegaard, P.H. (2017), "Towards a holistic methodology in sustainable retrofitting: Theory, Implementation and Applications", in *Transforming Our Built Environment through Innovation and Integration: Putting Ideas into Action* proceedings of the SBE 2017, Hong Kong, China.
- Kamari, A., Corrao, R. and Kirkegaard, P.H. (2017), "A Holistic Building Environment Method of Evaluating Sustainable Retrofitting", *Building and Environment*, under review.
- Jensen, S.R., Kamari, A., Strange, A. and Kirkegaard, P.H. (2017), "Towards a holistic approach to retrofitting: A critical review of state-of-the-art evaluation methodologies for architectural transformation", in *Transforming Our Built Environment through Innovation and Integration: Putting Ideas into Action* proceedings of the SBE 2017, Hong Kong, China.

► Fernando Martín-Consuegra. Universidad Politécnica de Madrid. Instituto Eduardo Torroja de ciencias de la construcción

► Research information

Introduction, Background to the Research

Urban areas renovation may lead to problematic situations associated with financing of the works in absence of a detailed analysis of the distribution of resources. An analysis of the needs and the obstacles in achieving buildings refurbishment to improve their energy efficiency must be observed.

The building's energy demand is assumed to be a suitable indicator for quantifying building-related energy vulnerability, for it determines the energy needed to establish indoor thermal comfort and depends largely on geometric and construction characteristics of buildings and urban fabric.

Nearly 70 % of the city's primary residences were built between 1941 and 1980 and are considered as the most inefficient stock (Oteiza et al. 2015). Multi-dwelling housing units are the main target for energy refurbishment since just 4 % of its total housing stock of 1.080.306 primary residences were single family homes in 2001 (INE 2001). These buildings' façades improvement is the improvement measure with a highest potential of energy needs reduction.

Monitoring of different façade solutions at test cells (Alonso et al. 2016) show that, for Mediterranean climates, ventilated facade is optimal during summer at the orientations that receive sun radiation. Instead, ETICS based solutions works best in winter on northern orientations and shaded facades.

Research problem

Low cost solutions are needed. Buildings requiring energy refurbishment will be those with poor construction quality, not adapted to the new energy efficiency requirements and probably constructed between 1941 and 1980. People with insufficient resources to deal with such actions will inhabit many of them. 83 % of all dwellings are occupied by their owners, 86 % of whom have low incomes and 12.6 % are over the age of 65 (ENTRANZE 2008).

In the first part of the research, urban areas have been characterized from an indicator of energy demand for heating based on the official Spanish energy classification system. Vulnerable quarters (Hernandez Aja et al 2014) with high energy demand, which are at risk of fuel poverty, are located.

Solutions based on payback periods of the investment are not suitable in a high amount of cases.

Research Questions

Main question

Does high scale urban refurbishment have enough potential to reduce energy consumption and improve air quality of European cities?

Sub-questions

1. What's the optimal solution for a low-cost large-scale façade rehabilitation according to urban fabric and existing building construction characteristics in Madrid?
2. Is it possible to generate an energy-related urban fabric parametrisation in order to estimate energy needs at a large-scale for Mediterranean climates?
3. Can renewable energy generation through buildings' façades with radiation incidence help to achieve the viability of the refurbishment project in vulnerable quarters?

Research Objectives

The main objective is the reduction of energy dependence on vulnerable social housing quarters' inhabitants.

The aim is to design a system for multifamily residential buildings facades rehabilitation at an urban scale. An ability for environmental adaptation is needed.

Research Deliverables

1. Heating and cooling energy demand calculation of a residential vulnerable quarter in Madrid, by simulation.
2. Best practice for social housing façades rehabilitation catalog.
3. Energy demand improvement potential by the rehabilitation of facades at an urban scale.
4. Estimation of renewable power generation potential in a social housing residential neighborhood in Madrid.

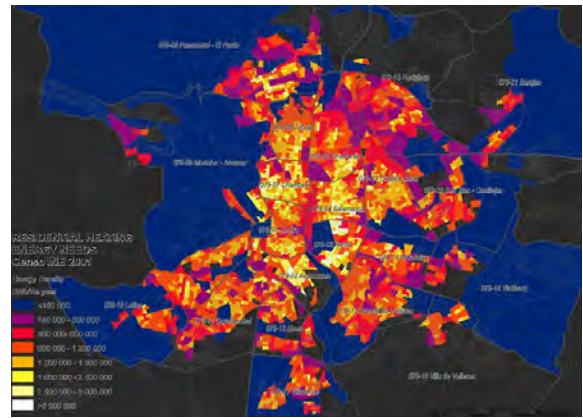

Heating demand density (MWh/Ha year)

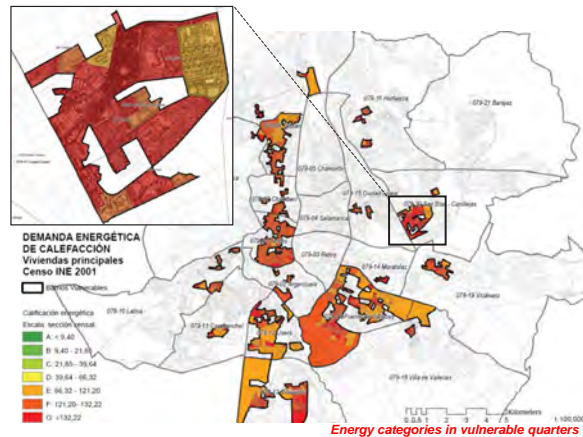

Energy categories in vulnerable quarters



- **Researcher:** Fernando Martín-Consuegra
- **Supervisors:** Agustín Hernandez Aja / Ignacio Oteiza
- **Time span:** 2015-2018
- **Contact data:** fernando@martin-consuegra.com
martin-consuegra@ietcc.csic.es

► Associated Publications:

- F. Martín-Consuegra, et al. 2016. "Energy needs and vulnerability estimation at an urban scale for residential neighbourhoods heating in Madrid (Spain)". Conference proceedings of PLEA 2016 Los Angeles - 32th International Conference on Passive and Low Energy Architecture.
- F. Martín-Consuegra, 2014. "Vulnerabilidad energética asociada a la edificación. Estudio de caso para la periferia urbana del sur de Madrid" Territorios en Formación N06", Madrid, Spain, pp. 105-118,
- I. Oteiza et al. "Energy Retrofitting for Social Housing by Improving the Building Envelope: Madrid, 1939-1979". 2015. The Sustainable Renovation of Buildings and Neighbourhoods. Bentham Science Publishers LTD. ISBN 978-1-68108-065-9
- F. Martín-Consuegra et al. 2015. "User utility as the financial justification for low energy refurbishment" Conference proceedings of 10th Energy Forum: Advanced Building Skins

► Research information

Introduction, Background to the Research

Accounting for more than 31% of the total energy consumption in 2012, the residential sector has been addressed as one of the most important sector that can potentially reduce the total energy consumption in Vietnam. In order to tackle the issue of energy shortage in the future, the Vietnamese government has performed several actions including the National Energy Efficiency Program for the period 2006-2015 (Decision No. 79/2006/QĐ-TTg, April 2006). In this program, as one of the key aspects, a legal framework for energy efficiency in construction management, industrial production and energy-using equipment is established. In 2013, the Ministry of Construction has issued the National technical regulation on energy efficiency buildings (QC:09/2013/BXD) which applies both to newly constructed buildings and renovation of existing buildings.

Research problem

Though refurbishment activities are being carried out regularly in Vietnam, little effort was seen in improving the energy performance of the building. One of the reasons is that the contemporary construction methods in Vietnam are still quite simple and do not incorporate energy efficiency measures. Moreover, little research has been done on the actual effectiveness of modern techniques.

Research Questions

Main question

How can refurbishment design strategies improve the energy performance of current existing houses in Vietnam?

Sub-questions

- What is the current condition of the existing housing stock in Vietnam?
- What are the potential refurbishment strategies for existing housing in Vietnam?
- What are the incentives and challenges for energy efficient refurbishment in Vietnam?
- How to minimize the differences between the planned and real performance of housing?
- What are the outcomes of the strategies, in terms of energy upgrade and improved living comfort?
- What are the costs and benefits of energy efficiency refurbishment? Do they fit the user expectation?
- What governmental actions are required and recommended to facilitate the implementation of refurbishment strategy in Vietnam?

Research Objectives

This research aims to develop design strategies for tube house refurbishment projects in Vietnam to achieve better energy performance. The design strategies should be in different refurbishment levels and indicate their energy saving potential. On the other hand, the cost-benefit analysis is also an important part to assess the application of a potential refurbishment action. Apart from the strategies, the research also establishes a set of recommendations for the legalisation of energy efficiency requirements for private housing for the coming years. These recommendations are expected to be used by the architects to help them in decision making in the early design stage and as a guideline to persuade their clients to follow a more sustainable way of design.

Research Deliverables

1. Review of energy efficiency strategies and energy performance of existing houses
2. Refurbishment design strategies for energy efficiency in Vietnam, including consideration of cost-benefit analysis
3. Recommendation for construction technical regulation for energy efficiency

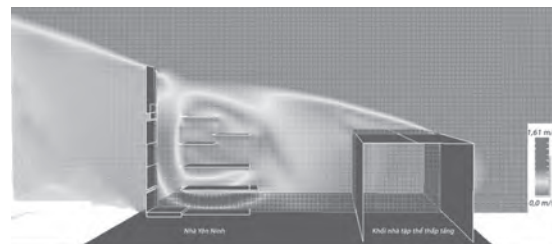
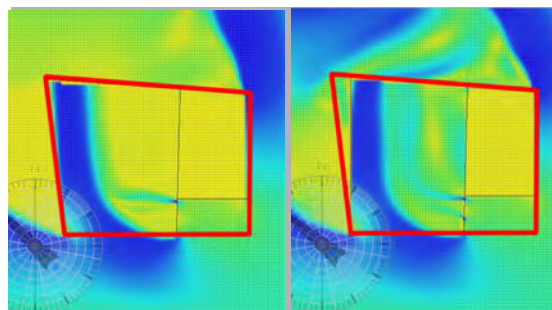

- **Researcher:** Phan Anh Nguyen
- **Supervisors:** Andy van den Dobbelsteen
- **Time span:** 2015-2019
- **Contact data:** p.a.nguyen@tudelft.nl
- **Associated Publications:**

- Nguyen, P. (2016). Towards a sustainable plan for new tube houses in Vietnam. International Planning History Society Proceedings, 17(2).

► Júlia Oliveira Pereira, Instituto Superior Técnico – Department of Civil Engineering, Architecture and Georesources

► Research information

Due to global environmental and energy conservation concerns, new directives from the European Union have been created these last years that reinforces the initial target of a 20% improvement in energy efficiency by 2020. According to several directives and papers, Buildings, Industries and Transportation systems are the major contributors in energy consumption. The Building sector is already responsible for 30% of the total energy consumption in the planet and is expected to grow. The aim of this research is to investigate thermal, daylighting and energy performance of glazing systems with solar control films (SCF) and shading devices and it's viability in rehabilitation of heritage buildings.

This research contemplates two major strategies, measurement and simulation, and they both present specific problems.

- **Measurement Strategy** (experimental method): implicates a long period of data collection and a wide coverage of multiple buildings for a representative data base. Another major problem is the access to private buildings that need permission from the owners and specific reserved places for the experimental equipment;
- **Simulation Strategy** (simulation method): the major problem with the data collected from simulation programs will be to re-create the actual characteristics of the buildings (detailed information) as well as occupants' behaviours throughout the whole experimental campaign.

Main question

- "How can SCF influence thermal, daylighting and energy performance of a glazing system?"

Sub-questions

1. "What types of SCF are available in the market that are adequate to reduce energy consumption in existing commercial and residential buildings. What are there main characteristics."
2. "How do this different types of window films influence thermal and optical characteristics of a glazing systems."
3. "Are they appropriate for any kind of building renovation. What are the major disadvantages/limits of this application regarding other available solutions in the market."
4. "When is it cost-efficient to implement this solution in the short and long run."

SCF presents a huge potential for further investigation, specially in a rehabilitation point of view. As a market in expansion, new kinds of SCF are introduced in the market each year, with different thermal and optical characteristics that try to solve nowadays problems of energy consumption, illumination, glare and thermal comfort. The aim of this research is to study the available solutions in the market of SCF in order to achieve the best possible equilibrium for thermal comfort, illumination, glare and energy consumption, for that, the following objectives were set:

1. Analyze and build two cell tests in order to study the behavior of glazing systems with and without SCF throughout experimental campaigns. Conduct experimental campaigns, in real life conditions, in typical residential houses in Lisbon with high ratio of window-to-wall façades;
2. Identify and characterize optical and thermal parameters that influence the thermal, daylighting and energy performance of glazing systems with SCF;
3. Use the experimental data to calibrate the models in EnergyPlus (DOE – U.S Department of Energy) that depend on input parameters such as ambient parameters, material properties and occupants related factors;
4. Analyze the performance of different types of SCF for different: positions (inside or outside the window glass), orientations and climate;
5. Compare the results with shading devices;
6. Establish recommendations for professionals in the area for Portugal's climate.

This research work will deliver an extensive in-field experimental and numerical study of different types of SCF in different types of window glass, different positions, orientations and climate. This kind of approach will demonstrate the potential in terms of thermal, lighting and energy performance of SCF and compare the results with other solutions, e.g. shading devices. Review of the results

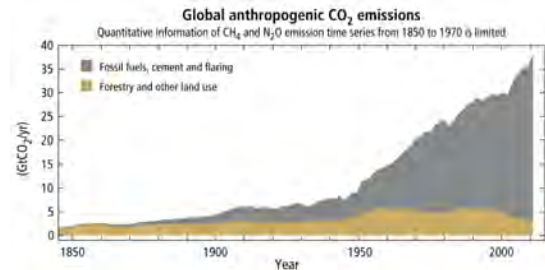

IPCC. (2014). *Climate Change 2014: Synthesis Report. Contribution of Working Groups I, II and III to the Fifth Assessment Report of the Intergovernmental Panel on Climate Change* [Core Writing Team, R.K. Pachauri and L.A. Meyer (eds.)]. IPCC, Geneva, Switzerland.



Experimental campaign in Instituto Superior Técnico, in two similar offices, one with SCF and the second without SCF

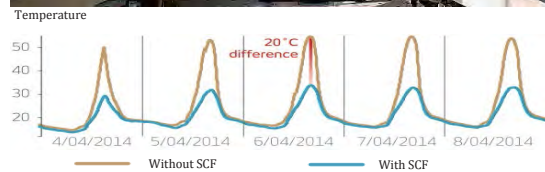

Hanita Coatings. (2014). *Skylight film installation upgrades Barcelona mall comfort – and saves on cooling costs.*

- **Researcher:** Júlia Oliveira Pereira
- **Supervisors:** Maria da Glória Gomes, Manuela Almeida, António Moret Rodrigues
- **Time span:** 2016 - 2020
- **Contact data:** julia_pereira_acores@hotmail.com
- **Associated Publications:**

► Elida Rios , University Polytechnic of Madrid UPM PhD in Architectural Heritage

► Research information

Introduction, Background to the Research

The objective of the research is to analyze the current developments in the use of materials on the facades in regards to historical buildings in heritage sites and its use of brick and Reinforced Concrete as a coating material . It also seeks to analyze its public spaces along with the materials used in outdoor flooring for better compatibility and accessibility to the historic building. To achieve this, it is proposed to explore the possibilities of new applications and, at the same time, assess the current state of some examples such as the project of urban recovery of HafenCity.

Research problem

The main problem is the adaptation of materials in historical buildings and that these are compatible with contemporary materials such as concrete that have a visual impact, or types of tile, the use of materials and the design of pavement in public spaces with patrimonial value.

Research Questions (Main Questions and sub question)

Main question

-"How or what kind of materials can be compatible and good in the restoration of buildings and spaces with patrimonial value?"

Sub-questions

1. "What are the main barriers for the use of concrete or brick facades of historic buildings?"
2. "How can outside spaces be treated so that the typology of local history is not lost?"
3. "What are the new intervention methods in the recovery of the architectural heritage, new methods and new products and building systems in buildings and public spaces?"

Research Objectives

Interventions in public spaces and buildings of historical value have not been investigated in detail regarding materials, functionality for greater efficiency in facades and replacing traditional materials formerly used.

This research focuses on options for finding design solutions and technical details that allow a more flexible design, and interventions in architectural heritage with contemporary materials.

This will be achieved through the following objectives:

1. Freeform coating forms.
2. Identify key problems that prevent or limit their architectural intervention
3. Existing solutions.
4. Identify key challenges that must be resolved to enable the loss of these buildings.
5. Examples of recovery buildings with desirable results.

Research Deliverables

1. Search coating solutions facades of Historic Buildings
2. Search of compatible materials in Public Spaces with history
3. Architectural heritage and regeneration of Public Spaces with contemporary materials.



- **Researcher:** Architect Elida Rios
- **Supervisors:** Jose Luis Garcia Grinda
- **Time span:** 2015-2016
- **Contact data:** luzelida14@gmail.com
- **Associated Publications:**

- Associated Publications: (Articles of paper at Congress 2016)
- Contemporary interventions in historic spaces: Hafencity Hamburg, Speicherstadt District in Hamburg Germany.
- Museums Interventions: International Maritime Museum of Hamburg and Tate Modern Museum of London
- Interventions analyses in Heritage Cities in South America: Public Spaces and Architectural Heritage in Cusco-Perú

Patent: Techniques and methods of intervention in Architectural Heritage Buildings and Public Spaces

Development of advanced computational support for Responsive Building Elements

► Hemshikha Saini, TU Eindhoven, Department of Built Environment, Unit Building Physics and Services

► Research information

Introduction, Background to the Research (Research theme)

The aim of this research is to investigate the potential of advanced decision-making support approaches for responsive building elements which reduce the time-to-market of such concepts, and promote adoption and their cost-effective replication in practice. A flexible framework will be proposed whose characteristics and application domain will be demonstrated through case studies in varying states of the product development process.

Research problem

Despite the high potential of RBE systems in terms of energy and comfort, as reported in scientific publications and technical documentation, the uptake of such dynamic, energy harvesting building components in actual buildings remains limited. Lack of information regarding expected effects of RBEs on whole-building performance and their associated risks have been prime impediments in their adoption in real buildings.

Research Questions (Main Questions and sub question)

Main question

“How can building performance simulation and decision-making tools translate potential RBEs at early developmental stage into successful and marketable products?”

Sub-questions

1. “What are the main barriers to adoption of responsive building elements into real buildings?”
2. “What are the indirect benefits of installing responsive building elements and how can they be quantified?”
3. “How can building performance simulation tools assist in R&D of new innovative RBEs?”

Research Objectives

The main objective of this project is to develop and test a computational performance framework that can be used to analyse the direct (e.g. energy, emissions, comfort) as well as indirect performance benefits (e.g. renewable energy integration and multivariate indoor environmental quality) of buildings with RBE systems. The application potential of this framework will be demonstrated using a series of case studies. Apart from this, in this project, concepts such as uncertainty and risk mitigation will also be analysed to explore the potential of RBEs as viable building components.

The following will be the three main elements of this research:

1. Simulation and optimization: Model development and co-simulation for integrated daylight and thermal performance of RBEs and integration of simulation with dynamic optimization algorithms
2. Probabilistic risk analysis: Sensitivity analysis and uncertainty propagation based on weather conditions and occupant’s influence will be used to investigate if RBEs lead to robust buildings
3. Post-optimization analysis: Mapping between design and performance aspects will be done using data mining and advanced data visualization techniques for identification of most influential design parameters

Research Deliverables

1. Multi-variate performance analysis of RBEs
2. Whole-building performance evaluation of RBEs
3. A flexible framework to assess risk versus opportunities associated with RBEs

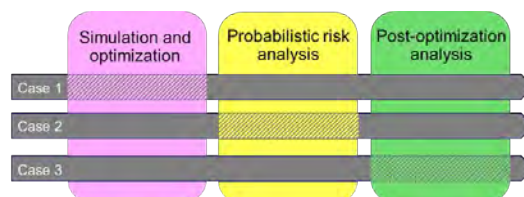
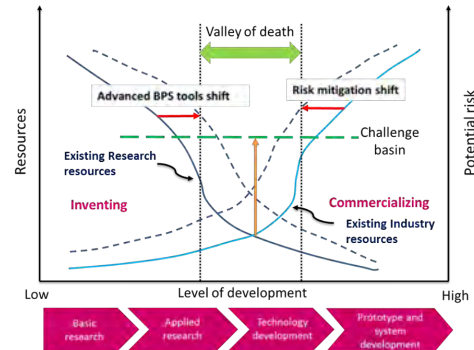

- **Researcher:** Hemshikha Saini
- **Supervisors:** Prof. J.L.M. Hensen
- **Time span:** 2016-2020
- **Contact data:** h.saini@tue.nl

Solar shutter, the shading system for DHW production

► Giulia Santoro, Politecnico di Milano – School of Architecture Urban Planning Construction Engineering, Department ABC

► Research information

Introduction, Background to the Research (Research Theme)

Nowadays, the gap between energy supply and demand leads us to deal with important energy challenges. Building sector, as responsible for one third of the total, primary energy demand, asks for research in energy efficiency focused on technologies that promote integration of responsive building elements with the building services and renewable energy systems. Among others, solar energy could be considered the most widespread renewable energy source, characterized either by passive and active strategies depending on how solar energy is captured, distributed or converted into thermal energy.

Research problem

Among active solar technologies, solar thermal collectors are heat extracting devices that convert solar radiation into thermal energy through a flowing fluid and are generally used for domestic hot water (DHW) heating. To being technically and structurally efficient, solar thermal collectors, like the other renewable energy technologies, must satisfy requirements for architectural integration. It consists on replacement of conventional building elements, parts of the building envelope, with systems able to enhance energy building efficiency, while maintaining innovative design and consistency to the context of the building. Building integrated solar thermal collectors have a great potential for future development, but they still have some weaknesses to deal with: large size, dimension inflexibility, dark irregular looking make building integration difficult.

Research Questions (Main Questions and Sub Questions)

Main question

1. How to make solar thermal collectors suit for building integration in high quality architecture?

Sub-questions

1. How to integrate functional and constructive aspects with aesthetics?
2. How to deal with the low flexibility of solar thermal collectors, in terms of size, dimension and shape?
3. How to reduce thickness and weight of solar thermal collectors?
4. Solar thermal collectors could be mounted only on opaque areas of the building envelope. How to deal with the opacity of these systems? Or how to increase their translucency?
5. How to enhance production, storing heat produced by solar thermal collectors close to where it is to be used?

Research Objectives

The shortage of solar technologies that really suits for building integration, along with lack of knowledge among architects, leaves the research opened to future development. In order to address these issues here is presented a possible new alternative solution for building integrated solar thermal collector that would allow for the use of these technologies on building façades. The goal is to make them invisible, aesthetically appealing and appearing as an architectural concept.

Research Deliverables

Solar shutter is a roller shutter that works as a solar thermal collector. It exploits the overheating of shading systems, otherwise lost or re-irradiated to the building, providing shadow and thermal insulation at the same time.

The shutter is made of different layers:

- Water-filled gap: water, heated thanks to conductive, convective and radiative processes, will serve as DHW;
- Absorber: water, in contact with the absorber (dark-coated surface with high emissivity) increases its temperature thanks to conductive processes;
- Solar radiation: solar rays hit the water, producing convection currents; heat is transferred through the entire thermal mass much quicker than in other materials;
- Insulation: a flexible (non-rigid) insulated layer is placed behind the absorber to avoid the heat to be re-irradiated where undesired (toward the window);
- Air-gap: a non-ventilated air gap protects water-filled gap from heat losses toward the exterior;
- Low-E coating: applied on the outer internal surface of the water-filled gap, it prevents heat from re-irradiating out, greatly reducing the amount of heat loss.

The system is thought to use thermosyphon circulation, adopted in passive direct solar water heating systems, which is based on natural flux convection, which circulates water without the necessity of a mechanic pump. The collector must be installed below the storage tank so that warm water will rise into the tank. The storage tank will be located inside the insulated roller shutter box, much closer to where DHW is needed than in common hot water supply. When needed, water, coming from the storage tank to the collector, will unroll the shutter by gravity. In summer, system's efficiency decrease, when the requested hot water temperature is lower. In winter, solar rays could reach the best orientation to enhance system's efficiency. The research is still at an embryonic stage and needs for further development.

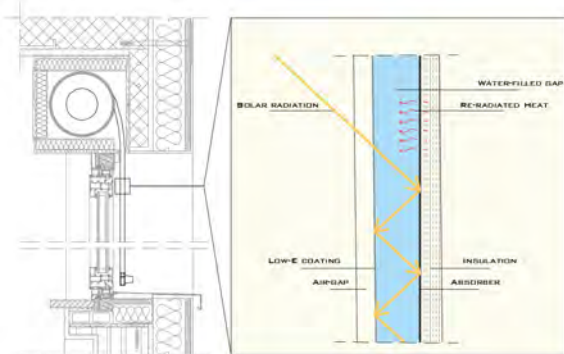

► Fig. 1: System's components and thermodynamic processes

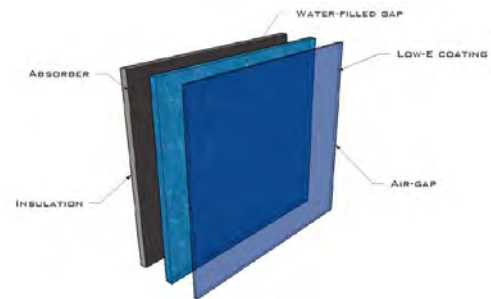

► Fig. 2: System's layers

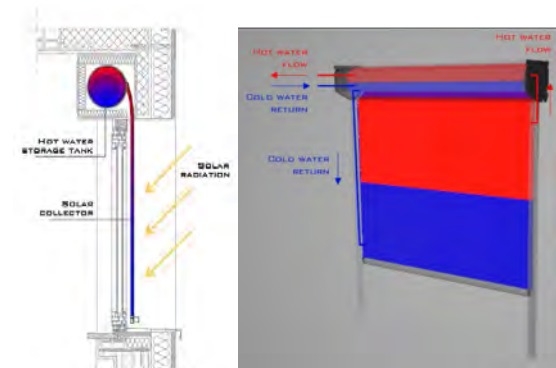

► Fig. 3: Thermosyphon water circulation

- **Researcher:** Giulia Santoro
- **Supervisors:** Prof. Enrico Sergio Mazzucchelli
- **Time span:** ongoing
- **Contact data:** giulia.santoro.mi@gmail.com
- **Associated Publications:**

G. Santoro, *Systems integration for the exploitation of renewable sources in the requalification of the Queensway, in New York City, Bachelor thesis, School of Architecture Urban Planning Construction Engineering, Politecnico di Milano, A.A. 2013-2014*

► Leonie Scheuring, TU Dresden Faculty of Civil Engineering, Institute of Building Construction

► Research information

Introduction, Background to the Research

The building sector is responsible for about 40 % of the global energy consumption. In order to reduce the global energy consumption, the European Directive 2010/31/EU on the energy performance of buildings targets the nearly zero-energy building standard in European countries. To achieve this target adaptive façade systems get more and more in the design focus. The façade changes the form, the geometry or the material properties in order to adapt to changing climate conditions and to reduce energy demand of cooling, heating and lighting systems. However, most of today's adaptive façade systems needs the supply of external energy to achieve adaptability. By combining the use of smart materials and integrated photovoltaic panels, an energy autonomous transparent adaptive façade system can be established.

Research problem

The façade system developed in the research, which is composed of various small openings, shall control the indoor air temperature and the indoor CO₂ level. This leads to the main problem in the research. The design of e.g. shape-memory alloy systems and PV-panels does not just have to satisfy constructive requirements, it also deals with indoor climate changes, which largely depend on weather conditions, user behavior, building properties, architecturally desired façade openings, etc. The interaction between façade and the aforementioned elements in combination with an yet unresearched application field for shape-memory alloy systems and PV-panels will be the main challenge of the research.

Research Questions (Main Questions and sub question)

Main question

"How do the innovative components of the system, including the shape-memory alloy and the PV-panel, have to be dimensioned and integrated into the system to achieve an energy-autonomous adaptive façade system for different weather conditions and building properties?"

Sub-questions

What are the potentials and limits of shape-memory alloy systems used in this façade system?
How can the best PV yield be achieved despite using an highly transparent PV-panel?
How many opening cycles are needed to achieve comfortable room conditions?
How much energy is necessary to guarantee the required opening cycles?
How should the energy storage system be dimensioned?
How can the energy storage system, the PV-panels, the control system be integrated into the façade system?

Research Objectives

- Simulations to define the number of opening cycles depending on the opening dimensions in order to guarantee comfortable room conditions
- Identify a shape-memory alloy system which satisfies the requirements of the façade system
- Simulations to define the PV yield and the needed energy storage system
- Design of a prototype
- Experimental analyses of the prototype

Research Deliverables

- A prototype of the façade system including the design of an opening drive
- Monitoring results

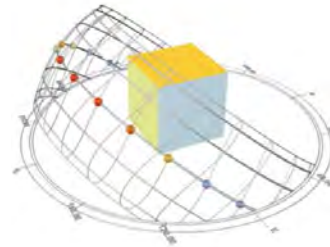

- **Researcher:** Leonie Scheuring
- **Supervisors:** Prof. Bernhard Weller
- **Time span:** 2016-2018
- **Contact data:** leonie.scheuring@tu-dresden.de

Face Wythe Made Of Unreinforced UHPC For Sandwichwalls With GFRP Connectors

► Milan Schultz-Cornelius, TU Kaiserslautern, Institute of Concrete Structures and Structural Engineering

► Research information

Introduction, Background for the Research

Recent developments in the field of innovative materials in construction enable to build filigree, energy efficient and sustainable architectural concrete façades with only a few centimeters thickness. Due to removal of reinforcement materials, it is possible to build economic and completely recicleable façades of Ultra High Performance Concrete (UHPC). Remarkable characteristic of the used UHPC is its high > 20 Mpa bending tensile strength. It allows to build filigree façades with large dimensions. Other resulting advantages are: saving of CO₂, reduction of transportation costs and increase of the building's living space.

Motivation

Realistic description of the structural behavior of pin-supported, unreinforced UHPC façade panels is a challenging task. Therefore more research is required on material and structural system level. The resistance of the façade is limited by the tensile and flexural tensile strength of the concrete, which is crucial for the design of a façade and its support system in form of a grid of connectors. The currently existing calculation concept is based on a mechanical behaviour of natural stone façades.

Research Questions (Main Questions and sub questions)

Main question

How to design an economic, unreinforced, filigree UHPC façade?

Sub-questions

1. What influence have the component dimensions and the stiffness of the supporting structure on the load-bearing behavior?
2. How to determine the mechanical properties of the material and what effects must be considered?
3. How to calculate the internal forces?

Objectives

The objective is to examine the realistic load-bearing behavior of unreinforced, filigree UHPC façades. In order to do that a special test set-up, including Digital Image Correlation system, had to be developed.

Deliverables

Based on the results, a design model will be derived.



Sandwich panel with a UHPC face wythe UHPC face wythe
GFRP connector
support structure



The developed test set-up: 1- specimen, 2- steel frame, 3- vacuum pump for wind load simulation, 4- controller, 5- measurement amp., 6- manometer, 7- safety glass, 8- high-speed camera, 9- 3D measurement system



The façade after failure and results from optical measurement

- **Researcher:** Milan Schultz-Cornelius
- **Supervisors:** Prof. Dr.-Ing. Matthias Pahn
- **Time span:** since 2013
- **Contact data:** milan.schultz-cornelius@bauing.uni-kl.de
- **Associated Publications:**

- Pahn, M.; Schultz-Cornelius, M.: Hochleistungsbetonfassade mit energieeffizienter Verankerung, in: 60. BetonTage Neu-Ulm, Tagungsband, 2016, S. 102–103.
- Schultz-Cornelius, M.; Pahn, M.: Investigation of Filigree (U)HPC-Facades with an Innovative Experiment Set-Up, in: "Architecture-Civil Engineering-Environment journal – ACEE", Schriftenreihe der Silesian University of Technology, Band 8, Gliwice, 2015, S. 87-90.
- Pahn, M.; Schultz-Cornelius, M.: Filigree (U)HPC-Facades, 8th Analytical Models and New Concepts in Concrete and Masonry Structures Conference, Wrocław, Poland Juni 2014, Book of Abstracts, Full Paper on CD, Paper ID 30.

Glass-metal building envelopes with composite structural behavior by adhesive bonding

► Vlad Alexandru Silvestru, Graz University of Technology, Institute of Building Construction

► Research information

Introduction, Background to the Research (Research Theme)

The perception of transparency in building envelopes is often limited by structural elements supporting the glazing, which are generally made of opaque materials. A reduction of the cross section dimensions of these linear structural elements by activating a composite structural behavior between the glass panes and the metal framing could increase the transparency and result in more elegant transparent building envelopes with filigree opaque framing and highly efficient material use. The aim of this research is to investigate the possibility of using adhesive bonding to obtain this kind of composite structural behavior. Possible concepts with structural silicones as well as with stiffer acrylate adhesives are investigated for this purpose in close collaboration with Waagner-Biro Stahlbau AG and with additional funding from the Austrian Research Promotion Agency (FFG).

Research problem

A composite system aims to activate the advantages of its components in order to obtain more efficient properties. In the case of the glass-metal elements with composite structural behavior this can be obtained by joining the metal framing with the glass pane with suitable load transfer mechanisms and materials. Although a significant amount of knowledge and data is available for the structural behavior of the different materials, the interaction of these materials in a composite element has yet to be investigated regarding manufacturing, structural and functional performance.

Research Questions (main questions and sub-questions)

Main questions

1. How can adhesive bonding be used to connect a glass pane with a filigree metal framing in order to obtain an element with composite structural behavior?
2. What are the structural performance and the failure limitations of glass-metal elements with composite structural behavior by adhesive bonding?

Sub-questions

1. What are the limitations (mechanical properties, durability, compatibility, etc.) of existing adhesives which are used for structural glass applications with respect to the use in glass-metal elements with composite structural behavior?
2. How can structural silicones be used in glass-metal elements with composite structural behavior?
3. What is the overall performance of a glass-metal element with composite structural behavior by adhesive bonding under multiple loading directions and how does the adhesive behave in this system?
4. How can the modelling and the structural design of glass-metal elements with composite structural behavior by adhesive bonding be simplified for the use in engineering offices?
5. How can the investigated glass-metal elements with composite structural behavior be further developed to fulfil functional façade requirements?

Research Objectives

The structural behavior of in-plane loaded glass panes as well as the mechanical properties of several structural adhesives were investigated in previous research projects, but the structural performance of a combined application of these two together with a filigree metal framing has not been approached yet. The following objectives will bring a significant contribution for this topic:

1. Define possible application situations for glass-metal elements with composite structural behavior
2. Identify suitable adhesives for this application and their limitations
3. Analyze different load transfer possibilities between glass pane and metal framing
4. Develop and assemble a glass-metal element with composite structural behavior
5. Perform experimental testing on the glass-metal element with composite structural behavior under combined in-plane and out-of-plane loading
6. Develop simplified modelling techniques and design recommendations

Research Deliverables

1. Review of completed research on in-plane loaded glass panes as well as on the mechanisms and materials used to transfer in-plane loads into glass panes
2. Extensive results on the structural performance of adhesive joints between glass and stainless steel with different joint geometry under tensile and shear loading
3. Findings from manufacturing large-scale glass-metal elements with composite structural behavior as well as results on the mechanical performance of such elements under combined in-plane and out-of-plane loading
4. Recommendations for simplified modelling and structural design of glass-metal elements with composite structural behavior by adhesive bonding



Glass façade with metal bracings at the John Joseph Moakley U.S. Courthouse in Boston, Massachusetts, United States

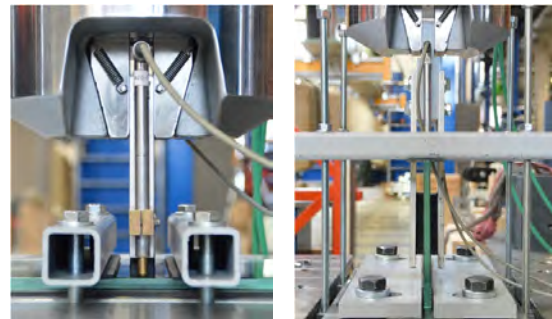

Linear adhesive joints with structural silicones and acrylates tested under tensile loading (left) and under shear loading (right)

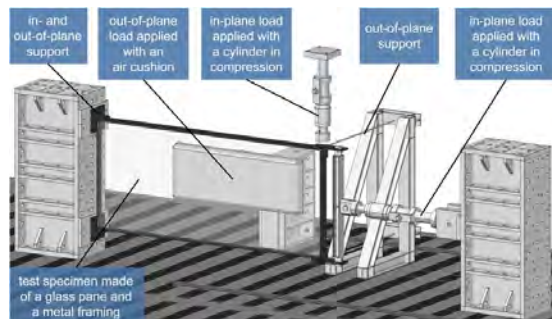

Test setup for experimental investigations on a 3.5 x 1.5 m large glass-metal element with composite structural behavior under multiple loading directions

- **Researcher:** Vlad Alexandru Silvestru
- **Supervisors:** Oliver Enghardt
- **Time span:** 2013-ongoing
- **Contact data:** silvestru@tugraz.at

► Associated Publications:

- V.A. Silvestru, G. Kolany, O. Enghardt, *Glass Building Skins – Presentation of the Research Project and Intermediary Findings, Advanced Building Skins Conference 2015, Graz, Austria*
- V.A. Silvestru, O. Enghardt, *Adhesion of a two-part structural acrylate to metal and glass surfaces, engineered transparency 2016, Düsseldorf, Germany*

► Christoph de Sousa, University of Minho, Institute for Sustainability and Innovation in Structural Engineering

► Research information

Introduction, Background to the Research

Reinforced concrete (RC) construction accounts for approximately 50% of the Portuguese building stock. The biggest rise on the construction of RC buildings took place between 1960 and 1990. This corresponds to a period of time when: (i) the available structural design codes considered only overly simplified earthquake provisions and (ii) thermal regulation was not yet available. The aim of this research is to develop a multifunctional rehabilitation solution for the structural and thermal retrofit of RC frame buildings, built during the referred time period (target buildings).

Research problem

The main problem is to develop a reliable and cost competitive prefabricated solution that allows for both structural (vulnerable buildings when subjected to lateral/seismic actions) and energetic (buildings with inadequate/absent thermal insulation and susceptible to the occurrence of thermal bridges) refurbishment of existing buildings.

Research Questions

Main question

"Can facade panels with sandwich configuration constitute a valuable solution for the structural and thermal retrofit of existing multi-storey RC frame buildings, built during the 1960-80 decades?"

Sub-questions

1. "What is the best synergetic configuration of materials and components for ensuring both structural and thermal insulation requirements?"
2. "What is the most suitable option to ensure reliable panel-building connectivity?"
3. "How is the behaviour of the proposed facade panel solution when subjected to fire exposure?"
4. "What are the main barriers to the manufacture of precast sandwich panels using fibre reinforced cementitious composites (FRCC) and an insulation core layer?"
5. "What are the main barriers concerning the installation of the proposed facade panel solution in the construction site, during the rehabilitation process?"
6. "How can Building Information Modelling (BIM) platforms be applied to assist a multi-criteria design/decision method?"

Research Objectives

The main objective consists on the development of a multifunctional composite sandwich panel, specifically designed for structural and thermal retrofitting of identified target buildings, through intervention on their envelope (refurbishment of building facades).

The main goal is to be achieved through the partial objectives that are listed below:

1. Definition of the structural and thermal requirements for the facade panels;
2. Selection of the most adequate synergetic configuration of materials (e.g. FRCC and polymeric foam insulation) and other components (e.g. panel-building connectivity and connectors within the panel itself);
3. Analyse the fire resistance of the proposed sandwich panel solution (facade panel as a protection against fire exposure conditions);
4. Thorough analysis of casting/assembly and installation on site: the prefabricated panel should be easy to assemble during fabrication and on construction site;
5. Direct application of Building Information Modelling (BIM) methodologies (interoperability between BIM platforms and simulation software).

Research Deliverables

1. Assessment of the degradation condition of target buildings: Literature review dedicated to the characterization of the built patrimony;
2. Review of both structural and/or thermal retrofit solutions adopted in the construction industry for the rehabilitation of existing RC frame buildings;
3. Survey on existing target buildings: identification of their limitations in terms of structural behaviour and thermal comfort;
4. Assembly of sandwich panel prototypes and evaluation of material properties by experimental tests;
5. Assessment of the structural performance of the sandwich panels when subjected to in-plane and out-of-plane loading conditions;
6. Characterization of the sandwich panels in terms of building physics criteria (thermal and acoustic insulation performance);
7. Execution of fire resistance tests (in accordance with the standard EN 1365-1) for evaluation of the fire resistance of the proposed facade panels.

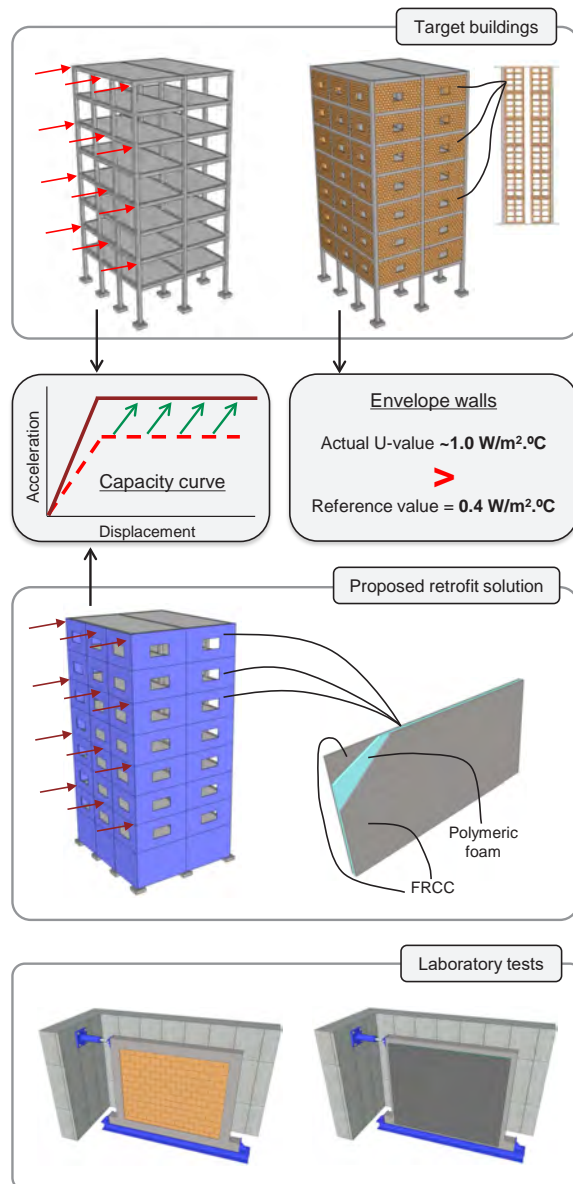

- **Researcher:** Christoph de Sousa
- **Supervisors:** Joaquim A. O. Barros; João Ramôa Correia
- **Time span:** 2014-2018
- **Contact data:** christoph@civil.uminho.pt

► Associated Publications:

- C. de Sousa, Joaquim A. O. Barros, M. Azenha, R. Lameiras, "Polymer and cement-based fiber-reinforced composite materials for sandwich slabs", 2014, *BFT International: Concrete Plant + Precast Technology*, Vol. 80, pp. 64-73

Adaptive shading devices for high performance envelope

► Alberto SPERONI, Politecnico di Milano - Architecture, Built environment and Construction engineering Department

► Research information

Introduction, Background to the Research

Sunlight is a natural resource which we need to allow into our buildings through glazed apertures as daylight for visual tasks. The sunlight energy density varies over a huge range, and it has to be controlled to prevent overheating but, at the same time, a vital connection with the world outside should be maintained (feeling of users of external environment) [1]. A large proportion of buildings' energy consumption is due to lighting (37% of total energy usage for commercial buildings) and cooling (25% of total energy usage for commercial buildings) [2], so it is important to modulate sunlight [3], and possibly to re-distribute it spatially to supply a glare-free working illuminance for a minimum summer heat gain. This is what solar control should address, and it is achieved by elements (shading devices) in or close to the window opening that, if efficiently designed, can reduce commercial building energy requirements for lighting and cooling of 10-20% [4,5].

Research problem

The use of dynamic shading devices gives a further added value to the system increasing both the systems performance and the users comfort. Nowadays these systems reach its dynamism through engines. The direct consequence is a higher risk of failure (due to the intrinsic complexity of the system and an high number of components) and higher costs for maintenance. A current school of thought is trying to solve these problems replacing the engines with smart materials. The results are promising (Fig.1 a/b/c/d) but still need to be further developed (complex, expensive).

Research Objectives

The aim of my PhD research is to develop a passive-dynamic shading system that could be tailored to respond to standard project parameters, complemented by behavioral models that describe its performance characteristic profile (in term of both energy performance and daylighting). These results can be achieved designing a shading system that integrates Smart Materials (SM) connected to 3D micro-geometry materials. Both of these have particular properties: Smart Materials change their shape in response to external stimuli (temperature, electricity and light) while 3D micro-geometry materials are characterized by solar transmittance properties that have a wide variation depending on the incident angle of solar radiation. Their combination within a shading system allows to exploit their particular features better than the individual use of the two: this produces a variation of the solar transmittance in response to the external stimuli. The integration and application of these new shading systems within buildings' context should:

- reduce or remove the energy need for the shading system movement, while ensuring adequate daylight performance, fulfilling users' requirements;
- minimize system's complexity through an optimization of the number of components reducing the risk of failure and considering the aspects of maintenance and management;
- Optimize the integration (increasing the produced movement of the shading device) and use (reducing the amount of the used alloy) of the smart material .

Research Deliverables

In order to define the parameters (input) required for the development new shading device components, I performed three main activities: Energy and daylighting simulations, optical measurements for shading materials (Fig.3 a/b) and smart materials tests (Fig.4).

The Energy and daylighting simulations allowed me to define the parameters related to geometry, finishing and arrangement of shading devices that mainly affect the system performance in terms of lighting, cooling and heating. The optical measurements for 3D micro geometry materials, performed using an integrating sphere, were necessary for me to identify the shading material that maximizes the system performance.

Results of the tests that I performed on SMs suggested that Shape Memory Alloys, in the form of wires, are the most promising. This is due to the higher specific force (ratio between force and mass) that they can generate as a consequence of an applied stimulus. Basing on their operational principles, I defined functional models (Fig.2) and, among these, I selected the one showing better performances (Fig.2-a). For this model I built a preliminary prototype (Fig.4) which was necessary to perform a more focused and detailed set of tests. This prototype was useful to define the required working current, the produced stress and strain and the design life of the system.

References

- [1] International Energy Agency, Daylight in Buildings - A source book on daylighting systems and components.
- [2] U. D. of Energy, Energy Efficiency Trends in Residential and Commercial Buildings, 2008.
- [3] ES-SO, Energy efficiency watch, 3.
- [4] A.I. Palmero-Marrero, A.C. Oliveira, Effect of louver shading devices on building energy requirements, Appl. Energy. 87 (2010) 2040–2049. doi:10.1016/j.apenergy.2009.11.020.
- [5] G.F. Menzies, J.R. Wherrett, Windows in the workplace: examining issues of environmental sustainability and occupant comfort in the selection of multi-glazed windows, Energy Build. 37 (2005) 623–630. doi:10.1016/j.enbuild.2004.09.012.

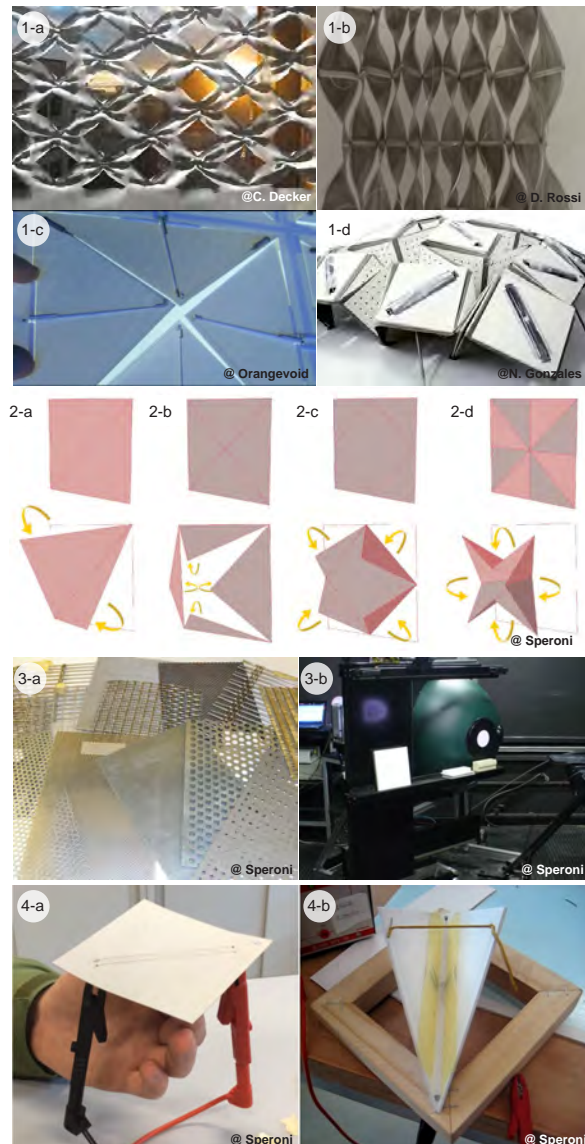

- **Researcher:** Eng. Alberto SPERONI
- **Supervisor:** Prof. Tiziana POLI
- **Time span:** 2013-2016
- **Contact data:** alberto.speroni@polimi.it
- **Associated Publications:**

- A. G. Mainini, T. Poli, M. Zinzi, A. Speroni (2015). Metal mesh as shading devices and thermal response of an office building: parametric analysis.
- R. Paolini, A. G. Mainini, T. Poli, A. Speroni, A. Zani (2015). Optical and radiative properties of textiles used for light temporary structures: performance assessment and decay over time.
- A. G. Mainini, G. Avantaggiato, A. Zani, A. Speroni (2015). Metal mesh shading devices optimization by parametric approach design.
- A. Speroni, T. Poli, A.G. Mainini, R. Paolini, M. Zinzi, I. Renzi, et al. (2014). Shading devices with 3D geometry: Characterization of optical and radiative properties and evaluation of energetic efficacy for different exposures. Istea.

► Bert Van Lancker, Ghent University, Faculty of Engineering and Architecture, Department of Structural Engineering

► Research information

Introduction

In the second half of the twentieth century, Double Skin Façades (DSF) were developed to improve the thermal and acoustic performance of traditional glass envelopes. This system of building, consisting of two skins, combines aesthetic value with good thermal and acoustic performance. However, with cavity widths varying from 50 cm up to 2 m, DSFs are rather space-consuming and conflict therefore with the number one requirement of tremendous economic importance in most building projects, namely maximum net usable floor area. For this purpose a Closed-Cavity Façade (CCF) was developed as a specific DSF system. A CCF consists of an outer single glass layer, an inner insulating glass unit (IGU) and a fully sealed cavity in between. This cavity is pressurized with dry and clean air to prevent condensation at all times and to minimise cleaning operations. As a result, the width of the closed cavity is only determined by the wind load acting on the façade and can therefore be reduced, typically to about 20 cm.

Research problem

Closed-cavity façades are characterised by a reduced cavity width compared to traditional double skin façades. However, a true optimisation in terms of reducing cavity width in favour of net usable floor area is still possible if the structural performance of the glass-framing system is optimised. This optimum can be achieved by using stiffer materials, such as cold-formed stainless steel, and/or by utilising the load-bearing capacities of the glass, by making it integrally part of the structural unit. The connection between steel and glass has to ensure a durable and reliable transfer of the occurring loads and also to absorb constraining forces (e.g. from temperature loads). Therefore, structural adhesives are considered. The innovative result is a Structural Closed-Cavity Façade (SCCF), which is the main topic of this research.

Research Questions

Main question

"How can the development of an innovative structural closed-cavity façade unit that complies with contemporary energy requirements and environmental standards, enable a real optimisation of net usable floor area?"

Sub-questions

1. How can the structural behaviour of a closed-cavity façade unit be optimised by utilising the load-bearing capacities of glass and by using cold-formed stainless steel?
2. What are the fundamental parameters influencing the structural behaviour (i.e. stiffness, strength and failure modes) of a basic structural closed-cavity façade unit?
3. How can a basic unit be adapted to comply with contemporary energy requirements and environmental standards?
4. What is the economic profit and the environmental impact of a structural closed-cavity façade unit compared to traditional solutions?

Research Objectives

The main objective of this research is developing innovative façade technology in terms of structural closed-cavity façade units that comply with the most strict energy requirements and environmental standards, enabling a real optimisation of net usable floor area, the number one concern in most building projects.

1. Defining structural closed-cavity façade units and determination of possible adhesive candidates for structural linear adhesive glass-metal connections.
3. Identification of fundamental parameters, influencing the translational and rotational stiffness, and the strength of structural linear adhesive glass-metal connections.
4. Identification of environmental influences (e.g. humidity, temperature, etc.) on durability and long-term behaviour of linear adhesive glass-metal connections.
5. Determination of the structural behaviour (i.e. stiffness, strength and failure modes) of an elementary hybrid glass-steel unit under wind pressure or suction.
6. Investigation of the effect of measures taken to comply with energy requirements (e.g. thermal brake) on the structural behaviour of the basic hybrid glass-steel unit.
7. Determination of the economic profit and assessment of the environmental impact of a structural closed-cavity façade unit.
8. Fabrication of a prototype of a structural closed-cavity façade unit.

Research Deliverables

1. A review of state-of-the-art façade design concepts, structural glass, adhesive glass-metal connections and building physics.
2. An overview of the fundamental parameters for the design of a structural glass-metal façade unit.
3. An assessment of the economic profit and environmental impact of a hybrid unit.
4. A prototype of a structural closed-cavity façade unit.



Figure 1: Roche Bau 5 with the first CCF in Basel .

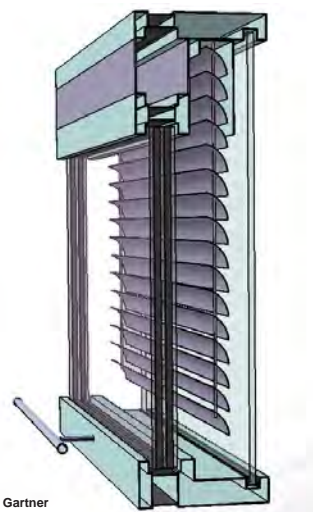

Figure 2: Closed-Cavity Façade (CCF) unit.

- **Researcher:** ir. Bert Van Lancker
- **Supervisors:** Wouter De Corte, Jan Belis
- **Time span:** 2014-2019
- **Contact data:** Bert.VanLancker@UGent.be
- **Associated Publications:**

- Van Lancker, B., Dispensyn, J., De Corte, W., Belis, J. (2016). "Durability of adhesive glass-metal connections for structural applications". *Engineering Structures*, 126(2016), 237-251.
- Van Lancker, B., De Corte, C., Belis, J. (2016). "Material properties of a structural silicone for linear adhesive glass-metal connections". *Proceedings of Challenging Glass Conference 5*, 16-17 June, Ghent, Belgium.
- Van Lancker, B., Dispensyn, J., Martens, K., De Corte, W., Belis, J. (2015). "Translational stiffness of adhesive connections between cold-formed steel members and glass panels." *Proceedings of the Glass Performance Days*, 26-29 June, Tampere, Finland. 291-296.
- Van Lancker, B., Belis, J., De Corte, W. (2014). "Rotational stiffness of linear adhesive connections between cold-formed steel members and glass panels." *2014 GlassCon Global Conference Proceedings*, 7-10 July, Philadelphia, PA. 729-746.

► Manikanta Raghu Sagar Vanapalli, Institute for Membrane and Shell Technology, Hochschule Anhalt

► Research information

Introduction, Background to the Research

Curved Pliable folding is the act of folding a flat sheet of material along a curved crease to develop a three dimensional shape. Although a lot of curved folded paper models have been explored, very little has been focused on contemporary designs due the complexity of the topic. Also an interesting subject of this topic is the kinematic connection that exist between the surfaces linked through a curved fold. As one surface area is bent, the other deforms elastically. Using this elastically deformed surface a kinetic façade can be developed which is the aim of the research.

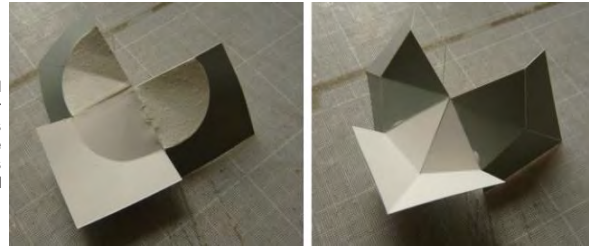

Research problem

The complexity of the curved folding lies in Form Finding but thanks to the advance 3d modelling software's which help in visualising the form. Another important research problem is to materialise the models from a prototype scale to a real time usable scale. Since the behaviour of the thin sheet in a small scale differs widely upon increasing the scale.

Research Questions (Main Questions and sub question)

Main question

How to create a curved fold with a polymer sheet and to make it a possible application in building construction, either as a wall partition, fair stand, dynamic facade system ?

Sub-questions

- How to fabricate a curved fold?
- How is the stress distribution along the fold?
- If polymers are used as a façade panel, what properties have to be altered in order to make it more durable?

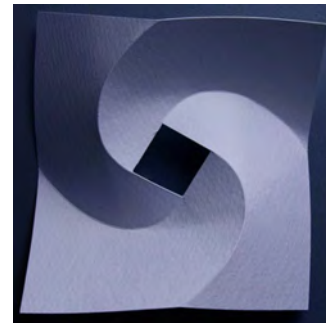

Research Objectives

- Defining appropriate material properties
- To describe different possibilities to obtain a curved fold
- Development of fabrication techniques
- Development of different geometric models
- Optimization of material properties with the required geometry
- Development of an end user prototype for manufacturing

Research Deliverables

- Definition of material criteria required for curved folding
- Different approaches for fabrication of curved folding
- End product from material selection to assembly of a building element which can either be wall partition or a façade system.



- **Researcher:** Manikanta Raghu Sagar Vanapalli; Henning Dürr
- **Supervisors:** Prof. Robert Off; Prof. Marijke Mollaert
- **Time span:** 2016-2018
- **Contact data:** m.vanapalli@afg.hs-anhalt.de

► Ana Cristina Villaca, CAPES, University of Wollongong / Sustainable Buildings Research Centre (SBRC)

► Research information

Introduction, Background to the Research

Retrofits can benefit existing buildings by providing energy savings, reducing greenhouse gases and improving both thermal comfort and quality of the built environment. Measuring building performance is the first step to understand the potentialities and constraints of a specific building during the retrofit process. To date, the potential within the commercial building sector to retrofit high-rise office buildings and shopping centres has been extensively investigated, but the retrofitting of smaller scale commercial and retail buildings still needs attention, particularly in regional centres where these buildings are ageing.

Research problem

While there is a plethora of rating tools and certification schemes, and some government incentives, to address different types and uses of buildings, a review of the literature shows that very little research has been done on the environmental performance of and retrofitting process for smaller scale commercial and retail buildings. Therefore, this research aims to achieve a better understanding of the retrofit dynamics in this building sector, including the identification of drivers, potentialities and limitations to the upgrading process, to ultimately identify the barriers that may prevent retrofitting of these buildings.

Research Questions (Main Question and Sub-questions)

Main question

How can the uptake of the retrofit process by the smaller scale commercial and retail buildings in regional centres be improved to comply with the new environmental standards?

Sub-questions

1. What are the main drivers, constraints and potentialities to retrofit identified in this building sector?
2. How do the existing rating tools fail to accommodate this building sector?
3. Which is the best strategy to measure and control the environmental performance of buildings in this sectoral and regional context?
4. What are the 'most effective' retrofit techniques, strategies or actions for this building sector in regional centres?

Research Objectives

1. Identify the drivers, constraints and potentialities for the upgrading process;
2. Develop a method to assess building performance in the research context;
3. Apply the method in a pilot study area to characterize the smaller retail building stock performance;
4. Validate the method by replicating it in another regional centre;
5. Identify the most effective upgrading strategy in this context; and
6. Identify opportunities for improvements to the existing commercial and retail building stock, considering the inherent characteristics of this sector.

Research Deliverables

1. Create a method to assess the building's environmental performance;
2. Potentially, create a benchmark for commercial and retail buildings;
3. Develop a tool to support the decision making process during the early stages of the upgrade design;
4. Blueprint guidelines for future policies to enhance the uptake of buildings' upgrades.



Fig. 1 Aerial view of the pilot study area. Adapted from Google Maps. Accessed: 05-08-2016



Fig. 2 Facades on Crown Street. Source: Google Maps. Accessed: 05-08-2016



Fig. 3 Commercial building before (above) and after (below) upgrading.

- **Researcher:** Ana Cristina Villaca Coelho
- **Supervisors:** Prof. Dr. Paul Cooper , Prof. Dr Tim McCarty
- **Time span:** July/2014 to June/2017
- **Contact data:** acvc600@uowmail.edu.au

► Research information

Introduction, Background to the Research

Few architectural works take aesthetic advantage from technical aspects; they are often seen as constraining requirements limiting creativity rather than inspiring principles triggering design concepts and being integral part of the design identity. Due to the current urgency of sustainability, technical aspects related to energy use deserve special attention. While advocating the use of technical performances as integral part of the design identity, this research focuses on a system for passive climate control.

Research problem

The research will focus on a specific demonstrator: a novel type of Trombe wall. It consists of a new system that passively improves thermal comfort using new lightweight and translucent materials for latent heat storage, like phase change materials. We will use novel production techniques, like 3D printing, to explore their potential for creating high quality translucent and highly performative products. Our approach is unique in that we aim for a system with high levels of adjustability to the specific conditions at hand and that we aim for a system in which the functioning will be part of the identity of the product. This latter aim will be realized by a.o. the adjustability and shape of the system and by the materials that have a changing appearance depending on their physical state (solid or liquid).

Research Questions

Main question

How can we design a building product for passive climate regulation in which its engineering performances are part of its identity?

Design component:

A system in which the functioning of thermal mass is part of the identity of the product

Technological component:

A system that is lightweight, translucent and has high levels of adjustability to tune it to the specific conditions and needs at hand

Research Method:

Research through design with a novel Trombe wall as case.

Research Objectives

The research will be performed based on the initial development of 3 innovative design concepts for the system. A combination of intuitive design and evolutionary and form-finding computer algorithms will be used to generate and select design alternatives within the 3 concepts. These alternatives will be evaluated and further elaborated upon soft and hard variables. Key soft variables are: design identity, usefulness and applicability in buildings. Key hard variables are: thermal and daylight performance. Secondary criteria are: manufacturing possibilities and structural performance.

The soft variables will be assessed in a series of workshops with architects and industrial designers or users respectively. The hard variables will be assessed based on physical tests and simulations. Continuous feedbacks from the workshops and computational assessments will be used in an iterative manner to feed the design process and to generate improved concepts.

Research Deliverables

While dealing with the use of engineering performances as principles to trigger design creativity, ultimately, this research will result in a set of design concepts and in general knowledge on thermal performances.

- Three innovative design concepts for the system
- Final design + prototype
- Extracting scientific knowledge from creative design as such informing the learning process of the designer
- Report and papers

This research is funded by STW.

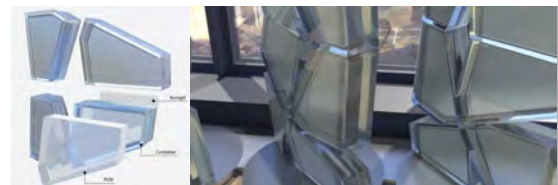
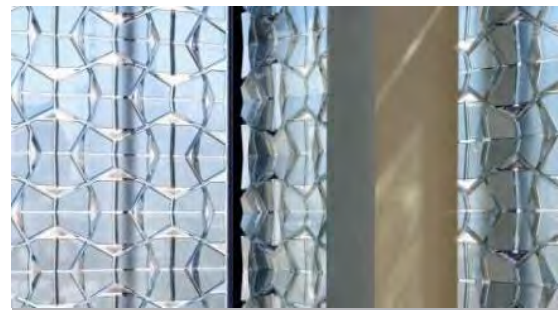
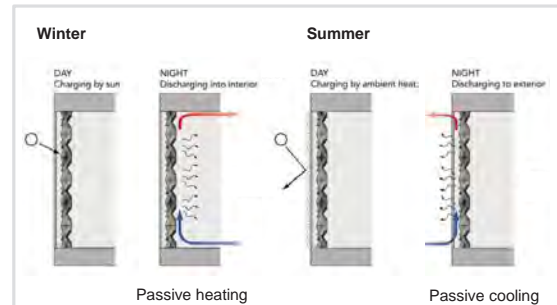

- **Researcher:** Tudor Cosmatu & Yvonne Watzek
- **Supervisors:** Dr. MScArch. Michela Turrin, Dr. ir. Martin Tenpierik.
- **Time span:** 2 years
- **Contact data:** t.cosmatu@tudelft.nl, y.c.m.watzek@tudelft.nl
- **Associated Publications:**

Video of the 3TU.Bouw project Double Face:
<http://www.3tu.nl/bouw/en/lighthouse2014/doubleface/>.
This video shows the development of the Double Face project which was the starting point of this proposal.



Solo Sokos Hotel Tornii / Sampo Valjus (image: M. Brzezicki)

ESR / ECI Support Session Belgrade 2018

Participants

Ahmed Felimban, TU Delft
Ali Aghazadeh Ardebili, University of Trieste
Anka Mirković, University of Belgrade
Ashal Tyurkay, University of Antwerp
Berk Ekici, TU Delft
Magdalena Patrus, University of Bath
Martina Di Bugno, University of Pisa
Tinatian Du, TU Delft
Valentina Frighi, University of Ferrara
Valerie Vyvial, Royal Danish Academy of Fine Arts
Zein Al-Doughmi, Cardiff University
Aleksandra Ugrinović, University of Belgrade
Kontić Ana, University of Belgrade
Ariadna Carrobé, University of Lleida
Paolo Bonato, Eurac Research, Institute for Renewable Energy
Cecilie Gry Jacobsen, The Royal Danish Academy of Fine Arts
Dijana Savanović, University of Belgrade
Federico Bertagna, University of Pisa
Jorge Luis Aguilar-Santana, University of Nottingham
Juanma Cruz, Norwegian University of Science and Technology
Michalis Michael, University of Cambridge
Mariana Velasco-Carrasco, University of Nottingham
Marina Bagarić, University of Zagreb
Milan Varga, University of Belgrade
Milica Petrović, University of Belgrade
Miroslav Vulić, Faculty of Mechanical Engineering, Department of Thermotechnics
Mohataz Hossain, University of Nottingham
Neda Džombić, University of Belgrade
Nevena Lukić, University of Belgrade
Nikola Macut, University of Belgrade
Yesim Keskinel, Izmir Institute of Technology
Yorgos Spanodimitriou, University of Campania 'Luigi Vanvitelli'
Mirjana Miletić, University of Belgrade

► Ahmed Felimban, TUDelft, Faculty of Architecture, Department of Architectural Engineering and Technology

► Research information

Introduction, Background to the Research

The aim of the research is to investigate the needed building envelope techniques in managing the solar effect on building energy consumption as using the envelope (material, construction, design) as a layer of managing the solar effect for the current residential building in Saudi Arabia. In close understanding, testing and stimulation several typical residential buildings to discover advance possibilities and evaluate the current state of residential building energy consumption.

Research problem

The main problem in retrofitting residential building envelope is the initial cost and time payback with respect of the end product quality. Many alternatives are published but not tasted and stimulated in business model yet

Research Questions (Main Questions and sub question)

Main question

“How can retrofitting residential building envelope strategy be advanced to meet the building owner budget and as of today’s architectural requirements?”

Sub-questions

1. “What are the main causes of high energy consumption in the current typical residential building envelope”
2. “How do the different building construction methods and material use effect of application of this strategy”
3. “What are the constrains of this strategy when applying in current situation”

RESEARCH Objectives

Envelope solar management strategy application has not been investigated enough after the new movement “2030 vision”, the building owners are subject to pay taxes and the government stop subsidising utilities. A new strategy should be implemented to recover the gap. This research looks into possibilities to find design strategy options and technical solutions which allow more use of renewable energy in the building envelope.

This will be done through the following objectives:

1. Defining current issue of residential building energy consumption.
2. Identify key factors of that energy consumption
3. Identify current design and construction application
4. Analyse similar cases in other areas has similar context.
5. Appraise existing typical residential building and other type in same region.
6. Develop a retrofitting strategy.
7. Identify key challenges that must be implemented for application.
8. Validate desirable option with building owners.

RESEARCH Deliverables

(Clear description of the deliverables for the research work)

1. Review of current residential building
2. A summary of all possible strategy alternatives.
3. Building envelope retrofitting strategy



- **Researcher:** Ahmed Felimban
- **Supervisors:** Ulrich Knaack, Tillmann Klein
- **Time span:** 2018-2021
- **Contact data:** a.a.m.felimban@tudelft.nl
- **Associated Publications:**

- None

Design a method for risk management decision-making in resource allocation and an index for measuring the “risk-taking capability”

► Ali Aghazadeh Ardebili, industrial Engineering and Information, Department of Engineering and Architecture

► Research information

Introduction, Background to the Research (Research Theme)

The main theme is engineering risk management., there is a big gap in current literature and the methods to accept the opportunities that could have links to some threats in the projects. Nowadays Companies are looking for any opportunity to have privilege in existing competitive markets, to distribute the business, increase expected value of project or shortening the expected time of the project. The new method is heading to introduce in this PhD research project that empower project managers to pursue the new steps and gain the positive effects of a risky opportunity to open up new lines and could be a management tool to support sustainability strategies, continuous development and use innovative ways to reach objectives.

Research problem

A risk could have positive effects on the project objectives. this positive effects could be associated with new threats and decision makers avoid The risk for threats. But avoiding the risk will concurrently avoid positive effects. Therefore, this risks defined as “risky opportunity” in this project. The Problems is the shortage of an efficient index to illustrate the risk taking capability of a company and the procedure that enable decision makers to choose a risky opportunity to accept. On the other hand there is no index to evaluate the resource consumption during accepting a risk.

Research Questions (Main Questions and sub question)

Main question

1. “How the risk-taking capability could be assessed and increased?”
2. “Is it possible to use a quantitative tool to support decision-making with the aim to accept the risky opportunities and take only the positive effects?”
3. “Which resource should be chosen and how much of that resource should be employed to accept a risk?”

Research Objectives

Main objectives

1. Design a method for evaluating (or measuring) the ‘risk-taking capability’ of an organization.
2. Design a method to support decision-making with the aim to accept a risky opportunity and abatement of the negative effects of the risks .
3. Identify the most efficient resource and the amount of resource consumption to make the project ready to accept a risk.

Secondary objectives

1. Introduce a method to motivating the companies in all sectors with the idea of using the positive effects of uncertainty.

Research Deliverables

Theoretical: Theoretically 3 new concept considered to fill the gaps of existing methods in accepting the risky opportunities

Methodological: Methodologically A group of curves will be the main result of this analysis that is illustrated in previous slide. To create these curves we need to consider the new terms risk taking capability, stress, and strain and follow a new process that could evaluate the opportunities and risks together in a network.

Practical: Practically with this method project managers could use an index for evaluating (or measuring) the ‘risk-taking capability’ of an Organization or project; Also, this method is a tool to support decision-making to support sustainability strategies simultaneously accept the risks of changes and continuous improvements. Moreover, this method could help to identify the most efficient resource and the amount of the resource consumption to get the company ready to accept a risky opportunity.

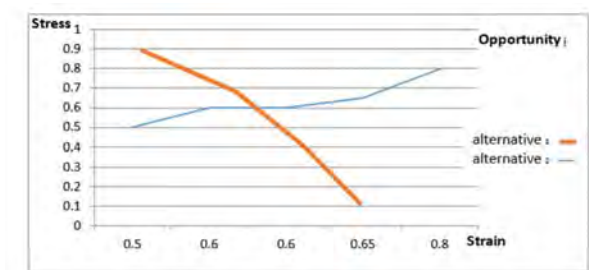
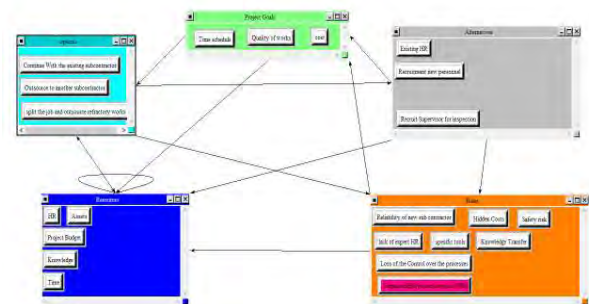
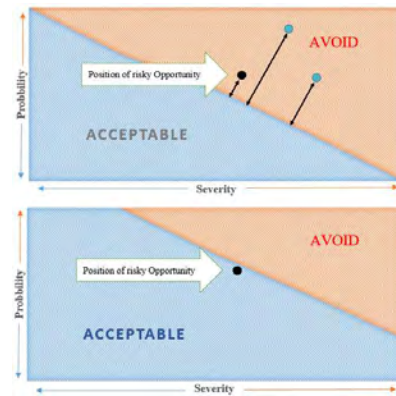

- **Researcher:** Ali Aghazadeh Ardebili
- **Supervisors:** Elio Padoano
- **Time span:** 2016-2020
- **Contact data:** ali.aghazadehardebili@phd.units.it
- **Associated Publications:**

- A.A. Ardebili, E. Padoano, F. Harsej (2017), Prepare Organizations to Accept risks: A Feasible Risk management, 7th international conference – Production engineering and management For Industry Sustainability, Pordenone Sep. 2017, University Consortium of Pordenone
- JURECSKA Laura, KIŠ Maja, TUMPA Andrea, AGHAZADEH ARDEBILI Ali, GAJSKI Goran, (2017) PlantPower – Phytoremediation of Contaminated Soils in Former Minefields of the Western Balkan Area, Krems, July 2017, Danube Future Training Capacity Building Proceeding.

► Ashal Tyurkay, University of Antwerp, Faculty of Design Sciences

► Research information

Introduction, Background to the Research (Research Theme)

Post-war technology encouraged multi-layered light-weight constructions in building façade systems. Either from aesthetics point of view, or from technical functionality perspective, the incorporation of different plastics and composites in the light weight systems is almost inevitable and is done in any of the following ways: as a finishing material (exterior or interior), as a protective layer, as a joint or connection element, or as a core element (Fig. 1). The increase and variety of exterior applications in residential buildings' envelope systems is shown in Fig. 2 and is due to the improvement of weather proofing and energy savings.

Research problem

Despite all efforts to reduce the energy demands of buildings, the EU is facing an acute lack of efficient renovation of the existing building stock. Most approaches are singular and focus on adding insulation or on exchanging windows while growing amounts of building waste by composite materials – mainly polymer modified (plastic) materials – are ignored. A holistic approach is missing that considers the potentials of existing constructions, in particular the building envelope, as a crucial element in the energy savings and efficiency discussion.

On the other hand, the use of plastics raises concerns due to high embodied energy, its effects on health and safety, low levels of resistance against ageing, and consequential shorter life expectancy than of buildings and reduced possibilities for recycling. For these reasons, appropriate application and maintenance procedures should be applied to plastic components in building envelopes at construction/operation/post-use stage.

Research Questions (Main Questions and sub question)

Main question

How can the information about the performance and the embodied energy in the building envelope system context affect the maintenance process? How do we make decisions to maintain plastic components or systems of façade constructions? Why do we decide whether it should be replaced or repaired?

Sub-questions

- How is the durability and life span of plastics affected?
- How can the relation between material performance and material's embodied energy be improved?
- What are the challenges that must be resolved in order to unlock the opportunities of circular economy?
- What would be the economic benefits if plastic building components were redesigned for recycling and reusing?

Research Objectives

Holistic approaches in the context of circular economy that take into account the potentials of the existing constructions are still quite limited in research and even more limited in practice.

In this research, it is aimed to develop sustainable strategies for maintenance (repair, renovation and recycling) of plastic building (envelope) components in post-war heritage in Belgium. Typical facade constructions and plastic building components will be identified (1). Link between performance, embodied energy and economy will be established by categorising "ageing" characteristics (2), evaluating their effects on facade performance, interpreting the performance analysis results in relation to plastic components' lifecycle before and after use stage (3), and elaborating the economic impacts of existing conditions the plastic building components are in (4). To reinforce the 'circular construction', strategies will be proposed for reintegrating the plastic building components into the lifecycle after the use stage.

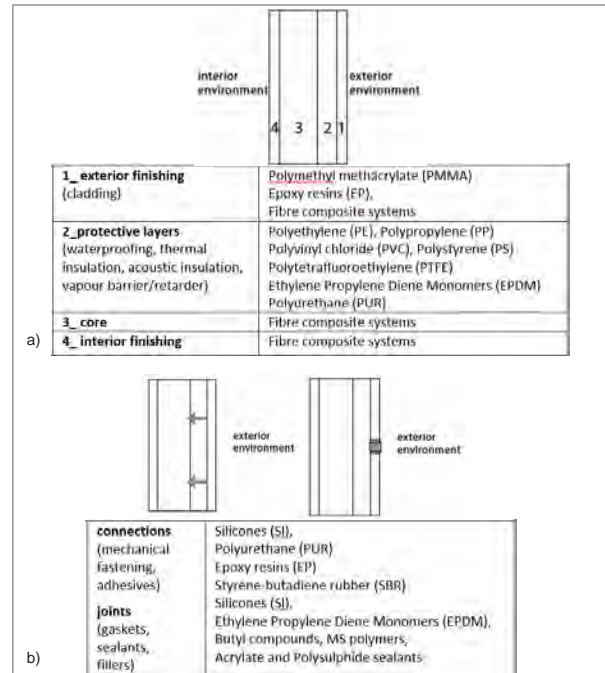

► Fig. 1: Typical plastics components in the "generic layer model" (a) and the "construction techniques" (b)



► Fig. 2: Typical exterior applications of plastic based materials in contemporary buildings (Source: Inoutic, 2018)

Research Deliverables

- Inventory of building facade constructions in Belgian post-war buildings of Flanders Region
- An integrated qualitative (performance) and quantitative (embodied energy) model to evaluate building façade systems
- Optimised strategies and business models for maintenance and re-use/recycling procedures

► **Researcher:** Ashal Tyurkay
 ► **Supervisors:** Prof. Dr. Ing. Uta Pottgiesser
 ► **Time span:** 2018 - 2022
 ► **Contact data:** ashaltyurkay@gmail.com

Computational Model for Self-Sufficient High-Rise Buildings

► Berk Ekici, TU Delft Faculty of Architecture, AE+T Department, Design Informatics Chair

► Research information

Introduction, Background to the Research (Research Theme)

The purpose of this research is to develop a computational model for designing self-sufficient high-rise buildings. Therefore two main research domains are involved. These are high-rise buildings and computational intelligence. In order to develop the computational model, three main steps are considered. These are developing parametric high-rise form generation, implementing self-sufficient criteria to evaluate the building performance, and make use of the power of computational intelligence to deal with complex design task. Within this framework the façade of high-rise buildings is one of the most important aspect to focus.

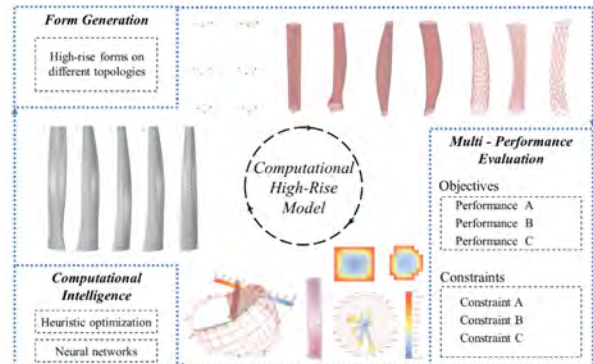

Research problem

There is no doubt that high-rise buildings suggest new habitation alternatives in metropolitan cities to cope with the urbanization trend and population growth. However, these buildings are not environmental friendly, because of their massive body. Potentials of computational intelligence can be exploited in order to design self-sufficient high-rise buildings in future.

Research Questions (Main Questions and sub question)

Main questions

- Why do we need self-sufficient high-rise buildings in metropolitan cities?
- How can the adequate decision be provided for self-sufficient high-rise buildings in the conceptual design phase using computational intelligence?

Sub-questions

- What are the essential parameters for self-sufficient high-rise buildings?
- Which objective functions and constraints should be integrated in the decision making process to reach self-sufficiency in high-rises?
- How can we develop performance criteria to evaluate the final model?

Research Objectives

In spite of current studies, which focus on how to decrease energy demand of high-rise buildings in the literature, this research is taking into account self-sufficient concept, which can be an important aspect for future urbanization. In this regard, objectives of the research are listed as follows:

- Defining design parameters and performance indicators of self-sufficient high-rise buildings
- Investigating computational intelligence techniques to deal with complexity
- Developing parametric self-sufficient high-rise model
- Developing objective functions and constraints for optimization
- Testing the model by means of case studies

Research Deliverables

- Review on performance based design using computational intelligence
- Framework of self-sufficient high-rise buildings
- Validated computational model

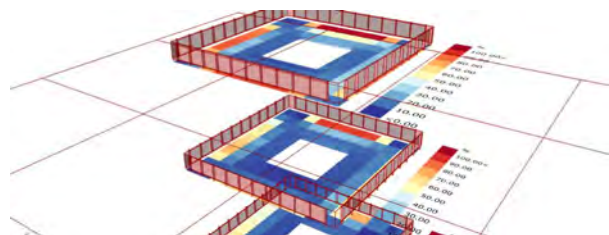
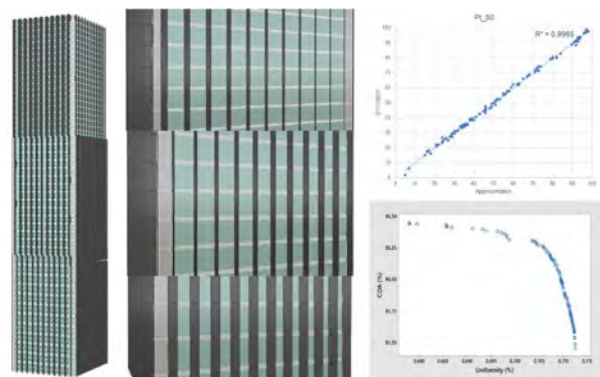

- **Researcher:** Berk Ekici
- **Supervisors:** I. Sevil Sariyildiz, M. Fatih Tasgetiren, Michela Turrin
- **Time span:** 2016-2020
- **Contact data:** B.Ekici-1@tudelft.nl
- **Associated Publications:**

B.Ekici, I.Chatzikonstantinou, I.S.Sariyildiz, M.F.Tasgetiren, O.K.Pan
'A Multi-Objective Self-Adaptive Differential Evolution Algorithm for Conceptual High-Rise Building Design'. IEEE World Congress on Computational Intelligence 2016, Vancouver, 2272-2279.

Optimal specification of Active Glazing when trying to avoid External Shading Devices

► **Magdalena Patrus, University of Bath, Department of Architecture and Civil Engineering**

► **Research information**

Introduction, Background to the Research (Research Theme)

The aim of this research is to investigate the current developments in the active glazing technology, its performance and adaptability on the market. Additionally, the study aims to assess the viability of specifying active glass for commercial developments in the northern maritime climate as an alternative to external shading devices which are often visually disturbing to building's occupants.

Working alongside smart glass manufacturers, it is proposed to explore the existing products and evaluate the current state of technology and industry's readiness to apply the technology in practice.

Research problem

Extensive research in active glazing technology has been carried out for the past few decades. Progressive advancement in materials sciences boosts its performance potential and proves its effectiveness in solar control and the likeliness to tackle existing limitations of external shading devices (i.e. view, user-control, operation and maintenance issues). Nevertheless, there are very little examples of its application in practice, and in the U.K in particular, not a single case study yet.

Research Questions (Main Questions and sub question)

Main question

How feasible as an alternative to visually disturbing external shading devices can active glazing be?

Sub-questions

- What is the performance gap between external solar shading and active glazing technology available today?
- What are the main barriers to application of active glazing in practice?
- How can operation of active glazing be optimized to satisfy user-control and building's energy performance?

Research Objectives

- A. Determine the gaps in the knowledge (lit. review & industry survey)
- B. Identify the reasons for the lack of practice despite numerous studies emphasising high potential of the application of active glazing as a form of solar control (industry survey).
- C. Create active glass products database.
- D. Develop a Toolbox enabling optimal specification of active glazing.
- E. Test the Toolbox on a commercial case study building located in London
- F. Analyse and compare the performance and capital cost of both solutions

Research Deliverables

- A summary of all key limitations related to external solar shading, active dynamic glazing and summary of desirable performance parameters.
- Review of the active glazing technology and products currently available on the market (Database).
- Toolbox enabling an optimal specification of the active glass with reference to an input project's constraints.

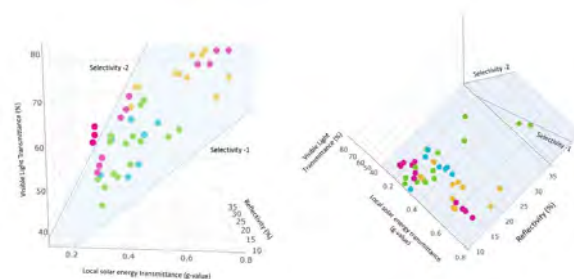
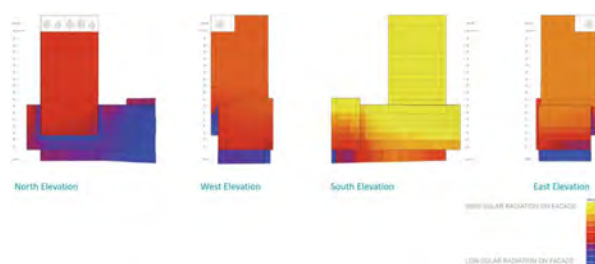

- **Researcher:** Magdalena Patrus
- **Supervisors:** Dr Steve Lo
- **Time span:** June - November 2018
- **Contact data:** mp2071@bath.ac.uk

Public School requalification: Building energy analysis and facade redevelopment

▶ **Martina Di Bugno, University of Pisa, Master degree in Building Engineering and Architecture**

▶ **Research information**

Introduction, Background to the Research (Research Theme)

The aim of the project is to improve energy performances of an old school building by working on its façade system. The research started from a specific case study with the aim of creating a standard model which is applicable to similar buildings. In fact, most of Italian school buildings were built between 1960 and 1980, and by now they have lack of energy efficiency. One of the most important aspects of energy redevelopment is how to modify the existing facades by using new technology, in order to gain higher energy performances.

Research problem

The main problem is to redevelop a system which involves many architectural features, like energy efficiency, economical sustainability, maintenance problems, realization, architectural identity.

Research Questions (Main Questions and sub question)

Main question

“What is the smartest way of façade and building regeneration of existing public buildings and what kind of project guidelines we should follow?”

Sub-questions

1. What kind of features should we consider when we talk of re-thinking facades?
2. How to combine architecture and energy efficiency?
3. How to make an easy maintenance facade system?
4. To adapt redeveloping system to each case- study

Research Objectives

The first step is to analyze the entire building in order to find every structural and energy weakness. After that, it's possible to focus on what the building needs: the most relevant issue is related to energy dispersion, so the main theme of the study is to research the better system to improve façade energy performances.

The thesis aim is to link façade design with sustainable building strategy as well as LEED certification: the chosen solution agrees with those requirements. In fact, the façade project includes the use of thermic panels, energy efficient windows and sun shading system, which provides an higher level of energy performances, with a reasonable economic impact.

Research Deliverables

1. Building energy analysis – energy performances and heat bridges
2. New performing facade research, final result
3. Technologies involved in energy efficiency improvement. The new building envelope is composed by thermic panels, energy efficient windows and doors, and sun shading system.

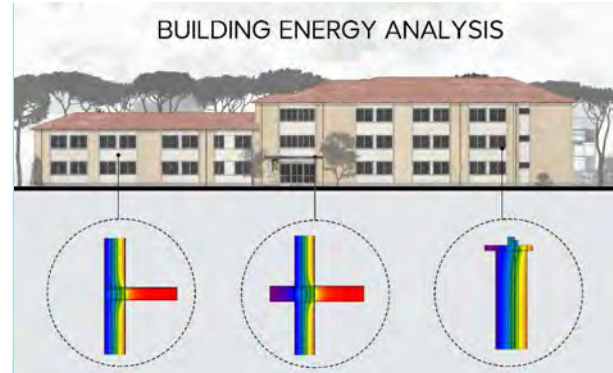

- ▶ **Researcher:** Martina Di Bugno
- ▶ **Supervisors:** Prof. Michele Di Sivo
- ▶ **Time span:** 2017 - 2018
- ▶ **Contact data:** martina.dibugno@hotmail.it
- ▶ **Associated Publications:**

- Retrofit tecnologico e funzionale delle scuole Lenci a Viareggio. Intervento secondo i protocolli di sostenibilità ambientale ed I nuovi indirizzi pedagogici (Tesi di laurea), Martina Di Bugno, Pisa, 2018

Smart Architecture

Adaptive (transparent) components for the improvement of building envelope performance

► **Valentina Frighi**, Department of Architecture, University of Ferrara

► Research information

Introduction, Background to the Research (Research Theme)

The aim of the research is to investigate the domain of Smart Adaptive Building Envelopes, identified as models able to respond to current architectural requirements.

Within this scope, Transparent Building Components have been analysed as major responsible for building energy consumption and end-users' comfort.

Research problem

Since the most of technological innovations employed in Smart Buildings addresses glazed components, due to their shortcomings in building systems, this research aims at develop a novel concept of Smart Window able to face current building needs as well as to solve a still existing lack of guidance on how such innovative glazing technologies could be integrated in buildings in a way that maximises their performance.

Research Questions (Main Questions and sub question)

Main question

How can Transparent Building Component be advanced to become "Smart" and meet the demands of today's architectural requirements?

Sub-questions

1. How building envelope concept has evolved over time? And, accordingly, what are today building (materials, etc....) requirements?
2. What can be defined SMART in current architecture?
3. How architectural technologies have evolved accordingly and innovated building practices as well?

Research Objectives

The main objective is to provide an insight in the applications and design of Smart Adaptive Building Envelope systems, focusing the attention on Transparent Building Components.

Other related objectives are:

1. to understand how innovative technologies have "shaped" architecture over years, becoming technological answers to current critical needs;
2. to provide a systematic characterization of Smart Buildings, recognizing which technologies provided building envelope with adaptive features, developing a mapping of adopted strategies and identifying common patterns to help further development of high-potential innovative smart, adaptive building components;
3. to provide a supporting database of different technological solutions and applications of adaptive smart buildings, as a first stage to evaluate current and future trends of adaptive facades;
4. to classify existing glazing technologies to reach for the development of a novel concept of Smart Window, able to overcome the shortcomings of existing technologies;
5. to define strategical addresses for building application of systems and glazed component with adaptive features, though the development of guidelines and recommendations.

Research Deliverables

1. New concept of SMART in architecture.
2. Database of Smart Adaptive Buildings.
3. Review of Advanced Glazing Technologies, through the development of a Matrix for the definition of compliant solutions.
4. Smart Window concept/prototype
5. Strategical addresses for building applications of systems and components with adaptive features.

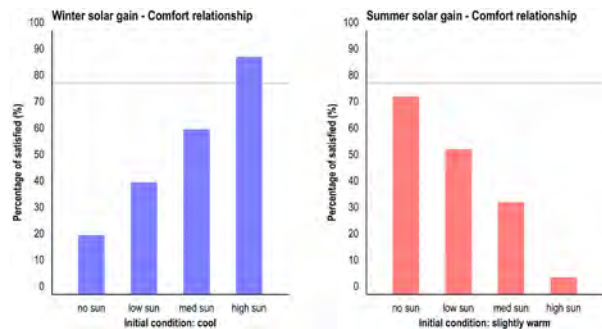
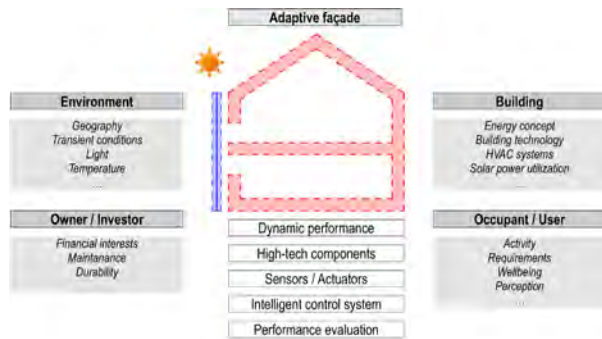

► **Researcher:** Valentina Frighi

► **Supervisors:** Giovanni Zannoni, Fabio Conato, Arben Shtylla

► **Time span:** 2016 - 2019

► **Contact data:** frgvnt@unife.it

► **Associated Publications:** just mentioned a few for space's reasons

Frighi V. (2017), "Glass in building sector: does the ideal window exist? [...]", in (Eds.) S. Brown, S. Larsen, K. Marrongelle, and M. Oehrman, *Proceedings of The 5th International Virtual Conference on Advanced Scientific Results (SCIECONF-2017)*, Vol.5, pp. 233-238 Zilina, Slovakia [elSSN 1339-9071] [cdlSSN: 1339-3561] [ISBN: 978-80-554-1337-2]

Frighi V. e Conato F. (2017), *Smart Architecture in Digital Revolution*, in MD JOURNAL, vol. 4/2017, pp.170-179, Ferrara: Laboratorio Material Design, Media MD [online - ISSN 2531-9477] [print - ISBN 978-88-85885-00-4] (double blind-peer review).

Frighi V. e Conato F. (2018), *Smart Materials. Innovazione tecnologica per un nuovo linguaggio architettonico*, in L'UFFICIO TECNICO, vol. 1-2/2018, pp. 7-15, Sant'Arcangelo di Romagna (RN): Maggioli Editore [ISSN 0394-8293] (scientific committee).

Main Title Research Title

► **Valerie Vyvial, Royal Danish Academy of Fine arts, Institute of architecture and technology**

► **Research information**

Introduction, Background to the Research (Research Theme)

The aim of the research is to investigate the current developments in the use of a vegetated facade as a cladding material in extreme conditions as climate change poses a real risk to society and the built environment. As temperature continue to rise and as cities across Europe develop rapidly, the need for facades that cope against such heat is needed. Vegetated facades offer the process of evapotranspiration, where water evaporates from the vegetation reduces the adjacent air temperature.

The aim of this study is to look into exploring its application with regards to the geolocation of different vegetation and its efficiency and its possible execution in different cities across Europe with different profiles. I would like to extend the research into exploring façades that can work in application in Alaska, where I will be doing field work for 5 weeks in November.



Research problem

The main problem is the lack of specific local diversity and research into the most efficient use of vegetated facades in the Europe. The problem extends to Alaska where research into the biodiversity can be researched and applied to its location.



Research Questions (Main Questions and sub question)

Main question

“ How can vegetated facades be optimised in the region of Europe to meet the acceleration of climate change in developed cities? Can this research be applied to Alaska where climatic conditions are colder?

Sub-questions

1. What are the limitations and barriers for manufacturing that prevent the development of such sort?
2. What are the downside of using such façade systems ?

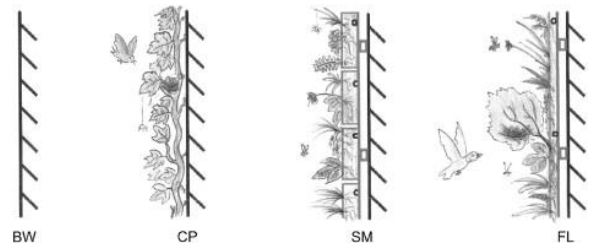

Research Objectives

Vegetated facades has the possibility to transform cities into greener cities yet it has not been implemented to the scale as other countries do such as Singapore. This research looks into options to find design solutions and technical details which enable more flexible design that can be implemented in Europe as well as Alaska in where I will have the opportunity in November to potentially conduct first hand field work.

- **Researcher:** Valerie Vyvial
- **Supervisors:**
- **Time span:**
- **Contact data:** vavy1765@edu.kadk.dk
- **Associated Publications:**

Research Deliverables

1. Review of vegetated facades and its efficiency in reducing solar gain
2. A summary of different types and varieties of vegetation that is applicable and easily used depending on locality – Alaska and Europe

Post-Occupancy and Performance Evaluation of Climate Adaptive Façades

► **Zein Al-Doughmi, Welsh School of Architecture, Cardiff University**

► **Research information**

Introduction, Background to the Research (Research Theme)

The increase in energy prices as a result of the energy crisis and the emerging perspective of related environmental complications opened an eye to the importance of façades in the triangle of architecture, energy and comfort, paving the way for Climate Adaptive Building Envelopes (CABS). Façade adaptation holds many forms, variations and terms, many of those types fall under the characteristics of one another but this study will deal with dynamic façades specifically. The research will look into the efficiency of dynamic adaptive façades as a vital part of the building. Efficiency in this research will include three main cores: energy consumption, occupant comfort and satisfaction and Indoor Environmental Quality (IEQ). Studies have shown the influence of the three elements on each other and eventually on the building's efficiency. The efficiency assessment will be conducted through a Post-Occupancy evaluation method on a number of buildings with dynamic façades..

Research problem

Although there are many studies that analysed the theory of Climate Adaptive Façades (CAF), the research in the efficiency assessment of such façades is limited and constrained to the analysis of computer simulation models. A few number of papers looked into occupant satisfaction of CAF. The assessment was done through the use of questionnaires as a qualitative form of POE. Due to the façade's complexity and interactive nature with the surrounding environment and occupants, a lack of performance benchmarks were found in the field of adaptive façades. Also, little to no studies have investigated evaluation methods and protocols for such façades.

Research Questions (Main Questions and sub question)

Main question

"How do Dynamic Adaptive Façades influence buildings in regards to energy consumption, IEQ and occupant comfort and satisfaction?"

Sub-questions

- "How suitable are the current POE methods in evaluating Climate Adaptive Façades?"
- "How does IEQ, occupants and energy consumption effect one another?"
- "What effect do automated façades and controlled environment in workspaces have on occupants satisfaction?"
- "Are current IEQ factors enough to investigate the IEQ in adaptive spaces?"

Research Objectives

- To evaluate the performance of Climate Adaptive Façades in regards to energy and occupant satisfaction
- To investigate the potentials of CAF as an energy efficiency solution in buildings
- To compare CAF potentials to static and conventional façades
- To assess the effect CAF has on occupants in workspaces
- To find the performance gap by comparing a performance simulation model to the data collected from the monitoring of the case studies
- To develop an initial evaluation method suitable for CAF
- To compare IEQ factors in conventional spaces with IEQ factors in spaces affected by CAF

Research Deliverables

- Initial POE method to evaluate CAF
- Occupant behaviour and satisfaction with adaptive façades
- A strategy to determine the conditions to use CAF instead of static facades



Q1, Thyssenkrupp Quarter, Essen, Germany



Kolding Campus, South of Denmark University, Denmark

- **Researcher:** Zein Al-Doughmi
- **Supervisors:** Prof. Chris Tweed, Dr Simon Lannon
- **Time span:** 2018-2022
- **Contact data:** AL-DOUGHMIZO@CARDIFF.AC.UK
- **Associated Publications:**

AL-DOUGHMI, Z. (2016). Investigating the Potentials of Climate Adaptive Façades as a Solution for Energy Efficiency in Buildings: Practitioners' Perspective. Masters dissertation. University of Liverpool

The use of modern technologies and materials for the purpose of presenting archeological sites

► Aleksandra Ugrinović, PhD student University of Belgrade, Faculty of Architecture

► Research information

Introduction, Background to the Research (Research Theme)

The thematic area I am researching is the application of interactive technologies and materials in the reconstruction and presentation of cultural heritage with the goal of revitalizing the abandoned and ruined parts of cities. The topic of the research is based on the study of the principles of design in protected areas with a focus on the ways of presenting archaeological sites *in situ* in urban and surrounding areas, pointing to the observed problems in practice. A special accent was put on the study and monitoring of the impact of climate change on the devastation of archaeological sites and the assessment of the degree of its vulnerability.

Research problem

The topic of the research was initiated by the use of protective, balloon constructions above archaeological sites in Serbia on which the protection services have been insisting, which permanently devastate the findings and cultural landscape and do not allow the museological presentation of architectural findings. The concept of the application of protective balloon structures above archaeological sites has come from the Restoration Theory of Cesare Brandi in order to present them *in situ*. The consequences that followed the installation of protective balloon structures above archaeological sites are manifested in the form of a greenhouse effect and cause a variety of other problems. Climate change contributed to the problems arising from the coverage of archaeological sites by balloon constructions even more drastic. Due to this situation, in order to prevent further devastation, many architectural findings have been buried, with the presentation not being realized. Therefore, it is important to research the application of modern materials and technologies for the renovation, adaptation and improvement of implemented solutions by replacing the used materials to cover the site with new ones in order to mitigate the adverse effects of climate change.

Research Questions (Main Questions and sub question)

Main question

How to present archaeological sites in urban and non-urban settlements in moderate-continental climate and enable tourist offer throughout the year?

Sub-questions

1. What are the ways / opportunities for presenting archaeological sites *in situ*?
2. What are the advantages and disadvantages of the application of protective balloon constructions in order to present the archaeological sites *in situ*?
3. What technological procedures / methods are necessary to apply in order to solve the problems?

Research Objectives

The objectives of the research are to:

1. Investigate the design skills of presentation of archaeological sites *in situ*.
2. Identify constraints in design in protected environments.
3. Identify the key problems arising from the installation of protective balloon structures.
4. Refine the mechanisms for remedying the problem.
5. Recommend and specify materials that can be applied when designing in environments.
6. Develop design strategies in protected areas that will enable archaeological sites to be opened for visitors to promote their publicity and enable sustainability through use.

Research Deliverables

The research will include:

1. A case study of the implemented solutions for the protection and presentation of archaeological sites *in situ* in domestic and foreign practice.
2. Overview of key issues
3. Investigation of the influence of constructive solutions, applied material and the impact of climate change on the preservation of archaeological sites (Monitoring of changes in architectural findings; Experiment: measurement of temperature and humidity before and after replacement of the materialization of the protective structure).



Presentation of the Villa Romana del Casale, author Franco Minissi



Presentation of the Villa Romana del Casale, author Giuseppe Cascino



Archaeological site of Mediana, author of the protective, balloon construction Mile Veljković

- **Researcher:** Aleksandra Ugrinović
- **Supervisors:** -
- **Time span:** 2017 -
- **Contact data:** a.ugrinovic92@gmail.com
- **Associated Publications:**

Ugrinović, A. Protective constructions in the function of presenting the remains of antique heritage, in the Proceedings of the Seventh Conference on Cultural Heritage "Cultural Landscape", Institute for the Protection of Cultural Monuments of the City of Belgrade, Belgrade, 2016, 116-127.

Thermal behavior of earth rammed constructions built in cooperation projects.

► Ariadna Carrobé, Sustainable Energy, Machinery and Building research group, University of Lleida

► Research information

Introduction, Background to the Research (Research Theme)

Earthbag and superadobe are low-cost and environmentally friendly building techniques that use raw earth to build structural walls, usually in dome shape. This research analyzes the thermal performance and comfort of an earthbag building located in Mediterranean continental climate by experimentation in real conditions. Previous research held a construction of a prototype in the University of Lleida Campus followed by the Training Medical Center in Burkina Faso by the Emsission NGO. Currently we are working with the Western Sahara government in order to find a constructive system that satisfies their thermal comfort needs.

Research problem

The biggest problem we had is the lack of legislation. There is no current legislation where we can base our developments on earth construction. Nowadays, people is aware of the Earth extinction and sustainable issues, so they are going back in time, copying the way our ancestors used to build so as to be more environmentally friendly, but there is no support from the big companies or government to invest more in this kind of techniques.

Research Questions (Main Questions and sub question)

Main question

How do earth rammed buildings perform in terms of thermal behavior in arid climates?

Sub-questions

- How do these buildings perform thermally in different seasons?
- What is the impact of sunlight?

Research Objectives

To develop this research, the next research objectives have been defined:

1. Monitoring of the prototype dome in University of Lleida.
2. Free-floating and inside controlled temperature experiments.
3. Validation of the model using Energy Plus.
4. Comparison of different models changing parameters such as the dimension of the window, the location...
5. Calculate the U-Value of the earth walls.
6. Determine the hours of thermal comfort.

Research Deliverables

- Earth construction in Burkina Faso and Western Sahara.
- Numerical models with Energy Plus to contrast thermal behavior of earth buildings.
- State of the art in earth construction

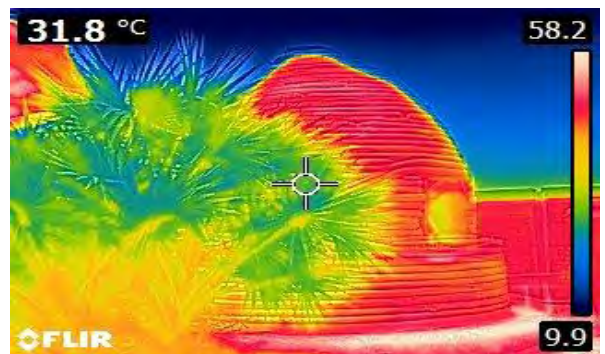

- **Researcher:** Ariadna Carrobé Montalvo
- **Supervisors:** Lúdia Rincón and Ingrid Martorell
- **Time span:** Since december 2017
- **Contact data:** ariadnacarrobe6@gmail.com
- **Associated Publications:**

- Article: Improving thermal comfort of earthen dwellings in sub-Saharan Africa with passive design. (Under development)
- EUROSUN 2018 paper: Thermal monitoring on an earthbag building in Mediterranean continental climate. (Under development).

Architecture and Extreme Environment (Alaska)

► **Cecilie Gry Jacobsen, The Royal Danish Academy of Fine Arts Schools of Architecture, Design and Conservation, Master program: Architecture and Extreme Environments**

► Research information

Introduction, Background to the Research (Research Theme)

Through a site-specific approach, this master program aims to respond to present and future global challenges through research by design and community engagement in form of active expeditions to remote areas of the world. The research is going to focus on developing solutions that can address the global environmental challenges the world is facing by using Tanzania (2017-2018) and Alaska, USA (2018-2019) as stepping stones for the research.

It is the intention to investigate the design potential in working with technology by producing a 1:1 prototype and testing it on-site. It is going to be tested by performance orientated design parameters, but also as a process charged with aesthetic potential and cultural implications with sustainable aims, from building scale all the way to detail.

Research problem

As a consequence of the climatic change the temperature is rising in Alaska faster than in other parts of the world, and because of this the permafrost in the underground, the sea ice and glaciers are melting, and that leads to vulnerability for more and more communities and the need to rethink housing and building design.

Research Questions (Main Questions and sub question)

Main-question:

“What are the artistic potentials of working with technology not only as a performance orientated design parameter, but also as a process charged with aesthetic potential and cultural implications with sustainable aims in Alaska’s environmental settings?”

Sub-question:

1. “How to address and test the environmental difficulties in Alaska in form of an architectural prototype both technically but also ethically?”
2. “How can this prototype design and expedition to Alaska be the key stone in a site specific building design?”

Research Objectives

Through a site-specific approach, the aim is to respond to Alaska’s climatic challenges through direct on-site involvement in the form of active expeditions where prototypes are put to the test and buildings are designed. This is to explore the intersection between architecture, technology, culture and environment in Alaska.

The process of the study will be:

1. Production of infographics and collecting knowledge about Alaska’s geological, cultural, environmental and economic background.
2. Research and production of an architectural prototype.
3. Expedition to Alaska with engagement in local community and testing of prototype.
4. Dissertation and reflections of expedition work.
5. Creation of a site specific building design placed in Alaska.

Research Deliverables

1. Architectural site-specific prototype of building component or building strategy.
2. Work dissertation of prototype technical and aesthetic performance in the specific environment, this year in Alaska.
3. Prototype upscaled in building design.



- **Researcher:** Cecilie Gry Jacobsen
- **Supervisors:** David A. Garcia, Thomas C. Bøjstrup
- **Time span:** September 2017 – Juni 2019
- **Contact data:** Stud5724@edu.kadk.dk
- **Associated Publications:**

Textile membrane structures in refurbishment of built heritage, case study: The Medieval fortified towns in Serbia (Smederevo, Ram, Maglič*)

► **Dijana Savanović, University of Belgrade - Faculty of Architecture, Department of Architectural Technology**

► **Research information**

Introduction, Background to the Research

The aim of the research is to investigate the current developments in the use of textile membranes in architecture. More precisely this research is focused on usage of **textile membrane structures in refurbishment of built heritage**. The main goal is reaffirmation of built heritage. The research will be organized as a case study: the Medieval fortified towns in Serbia (Smederevo, Ram, Maglič) are considered to be the part of this study.

The idea is based on using this space for open air theaters and music events. Reaffirmation of Medieval fortified towns in Serbia would be significant part of their presentation and further usage.

Research problem

As the idea is to define set of requirements that textile membrane structures should carry out in refurbishment of Medieval fortified towns in Serbia at one side, but should also fulfill acoustic requirements for music events and open air festivals at the other side, parametric formfinding of textile membrane structures would be complex. The main goal of the research is finding a typology of solutions, that would be suitable for different types of built heritage, which can be identified as a simplification or abstraction, but choosing relevant requirements from less important ones is complex.

Research Questions

Main question

"How can the parametric modeling of textile membrane structures be advanced to meet the demands of built heritage presentation but also today's architectural requirements?"

Sub-questions

1. "What are the main barriers to the application of this type of structures in specific historical and urban landscape?"
2. "How does the abstraction of requirements affect on geometry of textile membrane structures and does it restrict the application of this type of structures?"
3. "What are the potential problems of integration of this type of structures in specific historical context like Medieval fortified towns are?"
4. "How does the integration of this type of structures in Medieval fortified towns affect on landscape design and does such interventions require rethinking of the orchestra?"
5. "Finally which textiles would be suitable for application considering all the requirements?"

Research Objectives

This research looks into options to find solutions which enable affirmation of historical places and their new further usage by applying textile membrane structures. This will be done through the following objectives:

1. Defining textile membrane structures, systematization of cases and finding typology
2. Defining set of requirements that these structures in refurbishment of built heritage have to carry out
3. Segregating acoustic requirement from other ones
4. Case study: 3D modeling of these structures (applied on Smederevo, Ram and Maglič) using defined set of requirements
5. Identifying key problems that hinder or limit their application
6. Developing a structure prototype for each group of requirements that could be applied for as many different types of built heritage as possible

Research Deliverables

This would be 3-part research:

1. research of textile membrane structures and its application, resulting with typology of textile structures
2. research of principles of built heritage protection and presentation of Medieval fortified towns in Serbia, resulting with set of requirements that textile membrane structure should carry out
3. case study: application of textile membrane structures in refurbishment of Medieval fortified towns in Serbia, resulting with typology of solutions

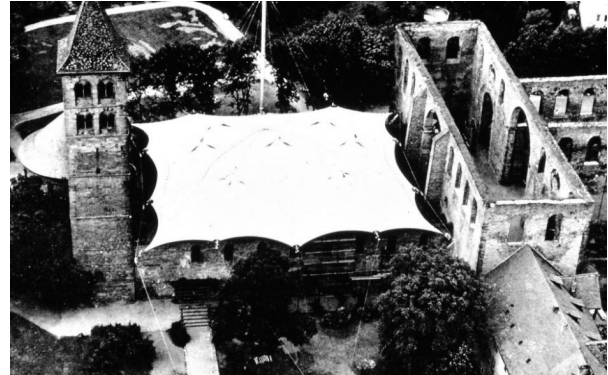

- **Researcher:** Dijana Savanović
- **Supervisors:** Prof. dr Aleksandra Krstić -Furundžić
Doc. dr Ana Nikezić
- **Time span:** January – July 2018.
- **Contact data:** dijana.savanovic@arh.bg.ac.rs
- **Associated Publications:**

**the author hasn't published this study yet, but related publications that inspired the research are in text below*

Kronenburg, Robert. "Introduction: the development of fabric structures in architecture", *Fabric Structures in Architecture*, Josep Llorens, ed. (Cambridge: Woodhead Publishing, 2015)
Llorens, Josep and Zanelli, Alessandra. "Structural membranes for refurbishment of the architectural heritage" u *Procedia Engineering 155* (New York: Elsevier, 2016), 18-27.

Bending-Active Shading Elements for Building Skin Retrofitting

► **Federico Bertagna, Department of Civil and Industrial Engineering, School of Engineering, University of Pisa**

► **Research information**

Introduction

The use of fully glazed facades for office buildings presents the advantage of allowing daylight into the indoor spaces, improving the comfort and well being of the occupants. However, transparent facades can also represent a hazard for the comfort of the users as the penetration of solar radiation inside the building increases the internal thermal loads and leads to overheating during the summer. Moreover, in areas under direct solar radiation, the glare risk will also increase. The inclusion of a suitable shading system on the facade is a method to mitigate these issues, providing effective protection of glazed surfaces throughout the whole year.

This master thesis is carried out in collaboration with the Chair of Structural Design at ETH Zürich, whose headquarters (Fig. 1) is used as a case study. In order to improve the current thermal and lighting conditions inside the fully glazed building, a lightweight external shading structure is being developed as part of a more extensive research on bending-active structures. The combination of bending-active beams, whose structural behavior is based on elastic deformations, with tensile elements – such as cables or membranes – creates a lightweight yet sufficiently stiff structures that can be used as facade components.

Research Problem

An external shading system can represent an effective solution to mitigate both overheating and daylight glare issues as it prevents direct solar radiation from entering the building through glazed facades. However, thermal comfort and glare risk are not the only parameters that have to be taken into account. The preservation of a good visual connection with the outdoors and an effective use of daylight as an alternative to artificial light are both aspects that cannot be neglected in the design process. However, fulfilling these different requirements demands conflicting configurations of the shading system. The search for an optimal solution in terms of shape and layout of the elements consists of finding a reasonable compromise between the various parameters investigated.

Research Questions

Main Question

How can facade shading elements be designed in order to improve the energy performance of a building skin without compromising visual comfort?

Sub-questions

- What is the optimal strategy to define the geometry of the shading elements taking into account all the conflicting demands?
- How can the evaluation of visual comfort aspects such as daylight glare be included in the process?
- How can these design strategies be extended to adaptive facades?

Research Objectives

The objective of this master thesis is to provide an effective and multidisciplinary design approach, incorporating the geometrical and structural demands of the shading elements as well as their performance in facade retrofitting.

Research Deliverables

- Analysis of the current state of the building in terms of solar exposition
- Development of new metrics and evaluation tools to guide the design of the shading system defined as part of digital parametric models
- Strategies and guidelines for the design of the shading system resulting from a negotiation of geometric, structural, thermal and visual comfort demands



Fig. 1 – Case study building, South-West facade

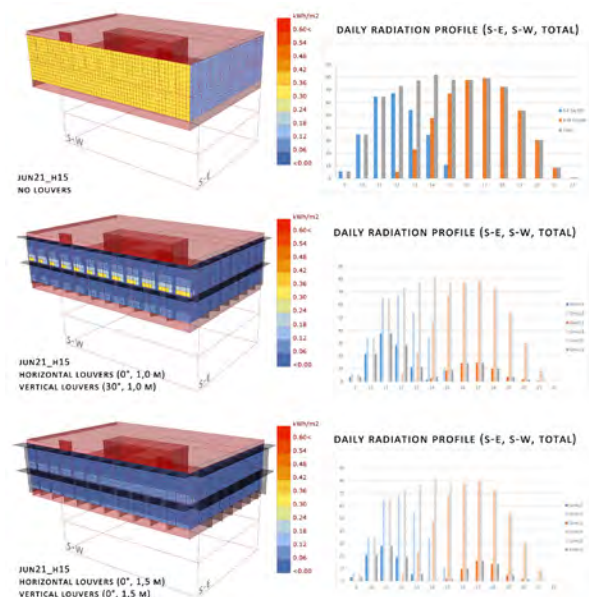

Fig. 2 – Sample of solar radiation studies considering different shading systems, South-West and South-East facades

- **Researcher:** Federico Bertagna
- **Supervisors:** Eng. F. Leccese (University of Pisa)
Arch. Eng. P. D'Acunto (ETH Zürich)
Arch. Eng. L. Boulic (ETH Zürich)
- **Time span:** June 2018 – December 2018
- **Contact data:** f.bertagna@outlook.it
- **Associated Publications:**

- Boulic L, Schwartz J, Design strategies of hybrid bending active systems based on graphic statics and a constraint force density method, IASS Symposium 2018, Boston, 2018.
- Carlucci S, Causone F, De Rosa F, Pagliano L, A review of indices for assessing visual comfort with a view to their use in optimization processes to support building integrated design, Renew Sust Energy Rev 47 (2015), 1016-1033

Integration of Dynamic Window Technologies for Reducing Heat Transfer and Energy Harvesting

► Jorge Luis Aguilar-Santana, Department of Architecture and Built Environment, The University of Nottingham

► Research information

Introduction, Background to the Research (Research Theme)

Heat transfer through building envelope occurs mostly due to window interaction with environmental conditions; nowadays fenestration in buildings accounts for more than 40% of energy consumption in household buildings in the UK.

The aim of this research project is to develop an integrated ultra thin glazing to achieve thermal control in buildings, using a series of dynamic fenestration technologies (such as thermochromic, photochromic, Low-E and vacuum). The goal is to reduce the “centre-of-glazing” U-value for window with multipane composition which in recent years has been stagnated (reporting 2.5 and 0.9 W/m²K for Double and Triple Glazing respectively).

Research problem

Optimising window heat transfer by conduction and convection introducing a highly insulated glazing material integrating static and dynamic technologies for solar energy harvesting in Net Zero Carbon Buildings.

Research Questions (Main Questions and sub question)

Main question

What is the impact of windows in the overall heat gain/loss of buildings?

Sub-questions

- What are the novel technologies integrated in the window manufacturing process?
- Which are the optimal technologies to tackle heat transfer through windows?
- What is the optimal technology for electricity harvesting in glazing?

Research Objectives

Analyse and generate mathematical models to predict the optical and thermal performance of active and passive fenestration technologies and the modelling of these windows in a FEM model (Using ANSYS and E+), with a glimpse on experimental testing to measure the U-value of windows and the interaction of these integrated in a PV module.

- Research on novel technologies for glazing systems.
- Design and develop a novel fenestration technology for heat transfer reduction.
- Analyse the integration of dynamic technologies of windows for temperate and tropical conditions.

Research Deliverables

- Market research evaluation of current fenestration technologies.
- Report on optical, thermal and energy characteristics of glazing materials.
- The impact of windows in the energy consumption of buildings.
- Develop a mathematical model to predict the thermal behaviour of glazing materials for industrial commercialization.

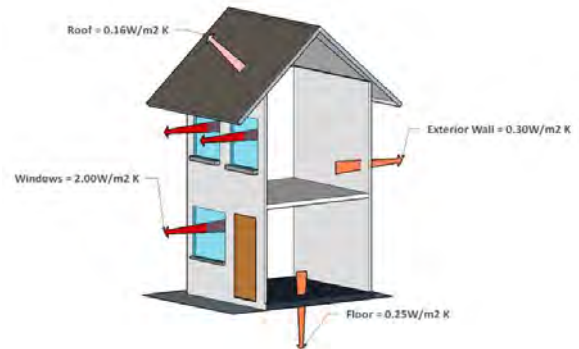

Typical U-values for traditional materials in building components. Adapt. from (Jelle, et al., 2012)

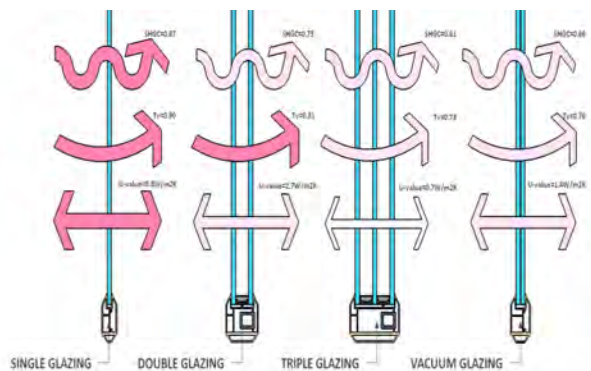

Conventional U-values, SHGC's and Visible Transmittances for SG, DG, TG and VG.

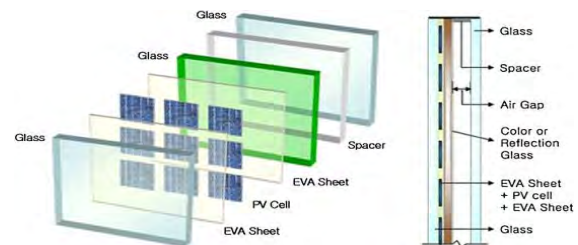

Diagram of c-Si PV window model. (Park, et al., 2010).

- **Researcher:** Jorge Luis Aguilar-Santana
- **Supervisors:** Prof. Saffa Riffat
- **Time span:** 2017-2020
- **Contact data:** jorge.aguilarsantana@nottingham.ac.uk
- **Associated Publications:**

- *Review on window technologies and Future Prospectus. A comprehensive state of the art analysis. 17th International Conference on Sustainable Energy Technologies, Wuhan China 2018.*

► Juanma Cruz, Norwegian University of Science and Technology, Faculty of Architecture and Design

► Research information

Introduction, Background to the Research (Research Theme)

Nowadays, the building sector aims to accurately simulate and foresee the energy needs of a building according to a certain number of parameters such as thermal conductivities, cooling and heating loads or HVAC systems performances. In addition, the interest in integrating Thermal Energy Storage systems (TES) such as Phase Change Materials (PCM) in buildings has increased significantly over the last few decades, becoming a potential application to increase thermal mass in buildings.

This research analyzes the behaviour of an office building located in two different scenarios, Barcelona and Trondheim, when PCM are introduced to the building elements and when they are not.

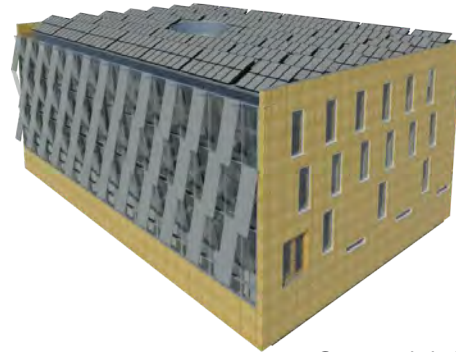

Case study building

Research problem

The use of TES can overcome the lack of coincidence between the energy supply and its demand; its application in active and passive systems allows the use of waste energy, peak load shifting strategies, and rational use of thermal energy.

However, it is not easy to determine whether these systems can work in accordance with the predicted simulation or the results will differ significantly.

Research Questions (Main Questions and sub question)

Main question

Which are the saving potentials of PCM for different climate such as the Mediterranean and the Nordic when they are applied in the building envelope and other construction elements?

Sub-questions

Could Latent Heat storage systems such as PCM be the tool to avoid installing cooling plants in heating demand climates such as Trondheim or heating plants in cooling demand climates such as Barcelona?

How the behaviour of passive systems of intrinsic control can be affected by factors difficult to predict and which are the factors influencing the most the activation-deactivation cycle of phase change materials?

Research Objectives

The research aims to find if there are benefits of using PCMs, to analyze the behaviour of the building, when parameters difficult to predict affect the building and eventually, to see if, using PCMs, it is possible to reduce the heating in Barcelona and the cooling demand in Trondheim, so that there is the possibility of avoiding installing a heating and a cooling plant respectively.

Research Deliverables

Summary of results obtained after running the simulations for all the parameters analyzed.

Graphical results showing the benefits, when there are, of using PCM in different situations in comparison with the same building when PCMs are not incorporated.

Graphical results showing the behavior PCM when some parameters, like internal or external gains are different of the predicted ones.

Diagrams showing the main factors affecting the behavior of PCM when incorporated in the building elements for different situations.

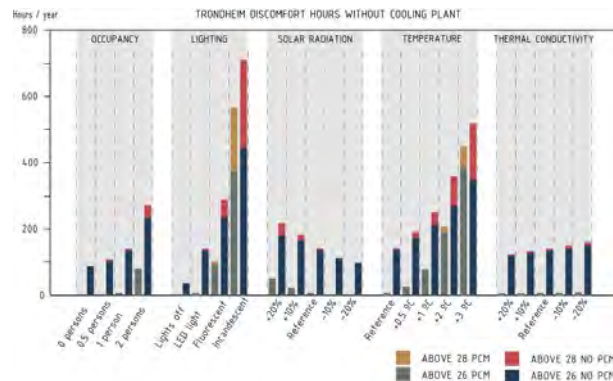
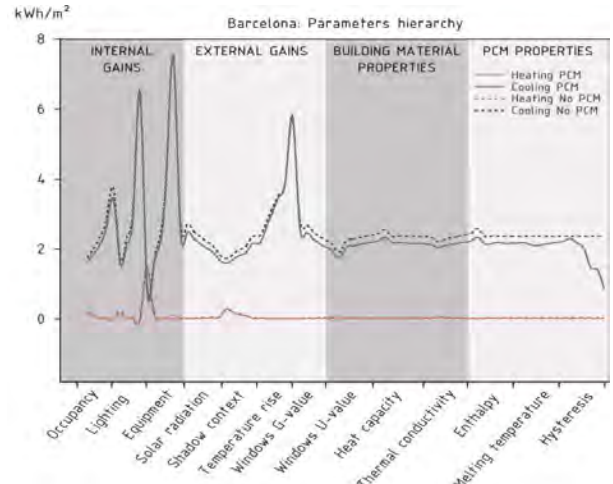

- **Researcher:** Juanma Cruz
- **Supervisors:** Francesco Goia and Albert Castell
- **Time span:** Spring semester 2018 - Extendible
- **Contact data:** juanma.cg.88@gmail.com
- **Associated Publications:**

The Impact of Façade Technology on the Building Energy Performance

► **Mariana Velasco-Carrasco, Department of Architecture and Built Environment, Faculty of Engineering, The University of Nottingham**

► **Research information**

Introduction, Background to the Research (Research Theme)

The building envelope remain as one of the most important exterior elements for building functionality. While the façade is an elegant component that helps to define the unique architectural aesthetics of the building, it also has the critical role related to energy performance and interior function of a construction.

Façades not only shape the appearance of building, they also determined the indoor climate, energy consumption and operating costs of a building. They directly influence the heating and cooling loads, and indirectly influence on lighting loads when daylighting is considered. In addition to being a major determinant of annual energy use, they can have significant impacts on the cooling system and electrical demand. Various façade types will lead to different energy performance of buildings, especially in respect of energy consumption and thermal comfort.

Research problem

- How to evaluate the facade technology?
- Which factors determine the best performance of a technology?

Research Questions (Main Questions and sub question)

Main question

How can we improve the energy performance of a building through the façade?

Sub-questions

1. How does the different façade technology impact on the energy consumption?
2. How does the climate conditions affect the suitability of the façade technologies?

Research Objectives

1. Determine the effect of the façade in the total building energy performance.
2. Measure the performance of different facades technologies, this can be by testing or computational simulation.
3. Analyse the performance under different weather conditions.
4. Propose improvements based on the tested results.
5. Develop an innovative energy efficient façade technology suitable for climate adaptation.

Research Deliverables

1. Review the existing façade technology.
2. Do computational and experimental testing to measure the impact of the façades technologies on the building energy performance.
3. Develop an innovative façade technology with improved energy performance.



Student Villa Retrofit Project

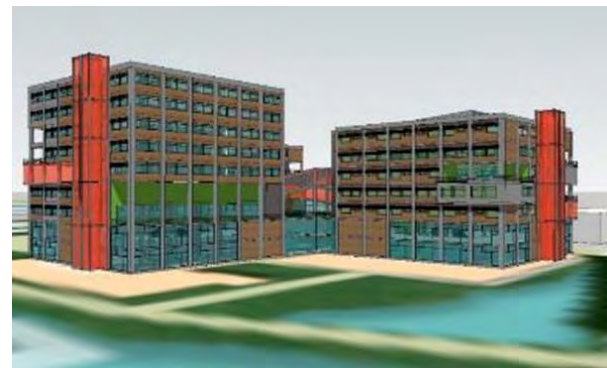

Facade materials

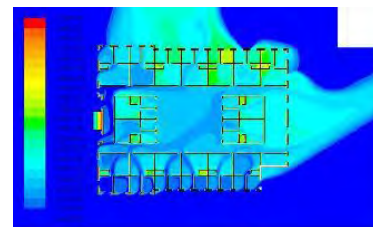

CFD Analysis

- **Researcher:** Mariana Velasco Carrasco
- **Supervisors:** Prof. Saffa Riffat
- **Time span:** 2017-2020
- **Contact data:** mariana.velasco@nottingham.ac.uk

HYGROTHERMAL PERFORMANCE OF A VENTILATED HEAVYWEIGHT BUILDING ENVELOPE

► Marina Bagarić, University of Zagreb Faculty of Civil Engineering, Department of Materials

► Research information

Introduction, Background to the Research (Research Theme)

The aim of the research is to investigate dynamic hygrothermal performance of a ventilated heavyweight building envelope under real climate conditions. Observed type of building envelope consists of novel prefabricated sandwich wall panels. The specificity of those panels lies in utilisation of recycled construction and demolition waste. It is proposed to explore the possibility of upscaling recycled aggregate concrete (RAC) from laboratory experiments at material scale to full-scale construction product implementation, which requires proof-of-concept of RAC's suitability for energy high-performing, moisture safe, durable and sustainable building envelopes.

Research problem

Novel prefabricated construction product was developed using recycled aggregate from construction and demolition waste. Theoretically this product is applicable for constructing low-energy buildings, however this has not yet been experimentally confirmed at full-scale in real outdoor and indoor environment conditions.

Research Questions (Main Questions and sub question)

Main question

„Can high-performance building envelopes be achieved with ventilated prefabricated heavyweight panels made from recycled aggregate concrete?“

Sub-questions

1. „How different orientations and indoor environments (use of occupants) effect the hygrothermal performance of observed RAC panels?“
2. „What is the effect of ventilated air layer on the hygrothermal performance of observed RAC panels?“
3. „What are the potentials limits of observed ventilated heavyweight RAC building envelope for different climate conditions and different terms of building use?“

RESEARCH Objectives

Ventilated heavyweight RAC building envelope has not been researched in a detail experimental and numerical hygrothermal performance characterization.

This will be done through the following objectives:

1. Hygrothermal characterisation of two different RACs (recycled concrete and recycled brick as aggregate) at material level.
2. Full-scale hygrothermal characterisation of ventilated prefabricated RAC sandwich wall panels under real outdoor and indoor environment.
 - 2a) Design a real-time field monitoring system.
 - 2b) Investigate the effect of different orientation and indoor environment, as well as the influence of ventilated air layer.
3. Set-up the benchmark numerical model and validate it with experimental results – perform parametric analysis of boundary and initial conditions which should result with recommendations for design process of this envelope type.
4. Quantify basic parameters of thermal inertia and evaluate thermal comfort.

RESEARCH Deliverables

1. Review of hygrothermal performance of heavyweight building envelopes (with conventional and recycled aggregate concrete).
2. Installation of sensors, construction of family house with RAC panels, commissioning of field monitoring system.
3. Validation of numerical model. Recommendations for design process.

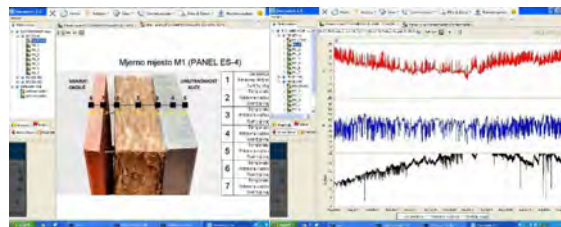

- **Researcher:** Marina Bagarić
- **Supervisors:** Prof. Ivana Banjad Pečur, PhD
- **Time span:** 2014-2020
- **Contact data:** mbagarić@grad.hr
- **Associated Publications:**

- M. Bagarić, I. Banjad Pecur, B. Milovanovic, Preliminary monitoring results of ventilated heavyweight building envelope from recycled aggregate, IBPC2018, Syracuse, USA
- I. Banjad Pecur, M. Bagarić, B. Milovanovic, I. Carevic, Construction and demolition waste as a resource for sustainable, very low-energy buildings, HISER2017, Delft, The Netherlands
- M. Alagusic, I. Banjad Pecur, Experimental investigation of hygrothermal performance of recycled aggregate concrete, Young Researchers' Forum III 2016, London, UK

Design principles for structures made of short wooden elements

► **Milica Petrović, University of Belgrade - Faculty of Architecture, Department of Architectural Technology**

► **Research information**

Introduction, Background to the Research (Research Theme)

The aim of this research is to set up criteria for the analysis of structures made of short wooden elements that would show their aesthetic, functional and technological advantages. With the advance in computer technology, the numerical analysis of complex geometries became much easier and opened new opportunities for architectural design. The subject of this presentation are structures made of short wooden elements which are created using design processes such as structural optimization and complex modeling. Structural optimization is based on form-finding principles which take into consideration static characteristics of structures and make them primary criteria for design, while complex modeling deals with the relation between real and digital models in an infinite loop between material, simulation and design.

Research problem

Since this topic became an architectural reality no more than ten years ago, it still isn't fully developed. These new design methods are investigated through architectural pavilions in only a number of institutes, so the information is limited.

Research Questions (Main Questions and sub question)

Main question

>> Does computer design help establish a new methodology for forming structures made of short wooden elements? <<

Sub-questions

- Are complex geometries a new approach in architectural design and if so, can they be the basis for designing structures made of short wooden elements?
- Is it possible to use complex modeling as a tool in everyday architectural practice?
- Can structural optimization be used by architects as the key component of structural design and is it necessary?
- Does new design methodology change the aesthetics of a building and in what way?

Research Objectives

To define a methodology for designing structures made of short wooden elements, the following objectives must be fulfilled:

1. proposing a theoretical discourse regarding structures made of short wooden elements that would help determine the criteria for their analysis
2. the analysis of material characteristics which are used for building these structures
3. the analysis of structural typology
4. the exploration of possibilities for building structures made of short wooden elements through complex modeling and structural optimization
5. validation of aesthetic, functional and technological advantages of these structures

Research Deliverables

The contribution of this research is first and foremost the expansion of theoretical discourse regarding design methodology of structures. The idea is to build a prototype pavilion which would follow all the design principles defined in the research so that conclusions about the advantages and of these structures can be made.



*all the figures are from Martin Tamke's workshop at KADK, presented in the article "Generated lamella"

- **Researcher:** Milica Petrović, MArch
- **Supervisors:** dr Nenad Šekularac, Associate Professor
- **Time span:** February 2016 -
- **Contact data:** milica.petrovic.ml@gmail.com
- **Associated Publications:**

Tamke, Martin, Jacob Riiber, and Hauke Jungjohann. "Generated lamella." *Acadia in:formation* (2010): 340-347.

Bletzinger, Kai-Uve, Roland Wüchner, Feraß Daoud, and Natalia Camprubi, "Computational methods for form finding and optimization of shells and membranes." *Computer methods in applied mechanics and engineering* 194 (2005): 3438-3452.

Popovic Larsen, Olga, and Andy Tyas. *Conceptual Structural Design: Bridging the gap between architects and engineers*. London:Thomas Telford Limited, 2003.

Building Façade and Ventilation Strategy: Improving Environmental Condition of Workspaces of Garment Factories in Bangladesh

► Mohataz Hossain, Department of Architecture and Built Environment, The University of Nottingham, Nottingham, UK

► Research information

Introduction, Background to the Research (Research Theme)

In the tropical climatic context of Bangladesh, most of the workers in garments factories suffer from discomfort in their workspaces and a range of health problems due to the high indoor temperature and poor air distribution. These workspaces, with a deep floor-plate and low ceiling heights, usually employ forced cross-ventilation using extract fans located on the external walls. However, the existing active ventilation strategy is unable to provide the workers with necessary thermal comfort. This research aims to identify viable design strategies that can improve the indoor thermal comfort within the workplaces of existing multi-storey garment factories in Bangladesh.

Research problem

There is an absence of studies based on field evidence from garment factories that quantify the issues surrounding existing thermal conditions in different production workspaces during various climatic seasons. Moreover, no previous research identified the feasible solutions designed to improve the indoor thermal performance of both existing and new garment factory workspaces.

Research Questions (Main Questions and sub question)

Main question

“What are the viable design strategies that can improve the thermal comfort and indoor environmental condition of workspaces within existing RMG factories in the tropical climate of Bangladesh?”

Sub-questions

- What are the factors that influence the thermal environment within workspaces in RMG factories and how do these vary between the seasons of Bangladesh?
- What are the thermal comfort guidelines and the workable design strategies to minimise the environmental issues within these workspaces?
- To what extent are the workable design strategies beneficial in terms of improving workers' thermal comfort within the workspaces?

Research Objectives

- To identify the environmental design parameters that influence the indoor thermal comfort of workspaces, including those of RMG factories, in a tropical climate.
- To identify and assess the feasibility of passive design strategies in existing multi-storey RMG factories of Bangladesh.
- To identify the key parameters that influence the thermal environment of workspaces in existing RMG factories during the climatic seasons in Bangladesh.
- To identify thermal comfort guidelines and workable design strategies to minimise the issues (based on Objective 3) within RMG workspaces.
- To explore the environmental benefits of applying the workable design strategies in existing RMG factories.

Research Deliverables

- Review of suitable thermal comfort guidelines and design strategies.
- The key design parameters influencing the indoor thermal comfort of garment factory workspaces.
- Adaptive thermal comfort guidelines and workable design strategies to minimise the existing issues based on field survey.
- Quantifiable effect of retrofitting existing building facades and changing ventilation strategies on indoor thermal environment.

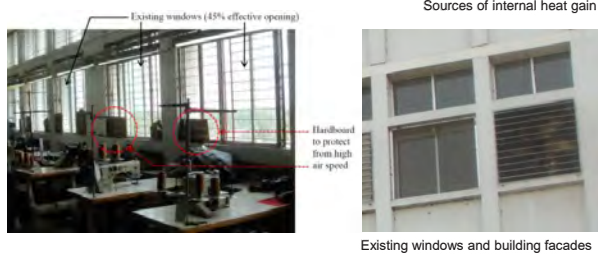
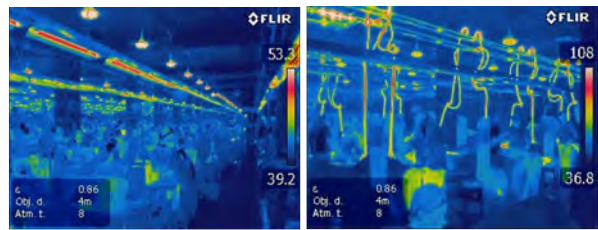
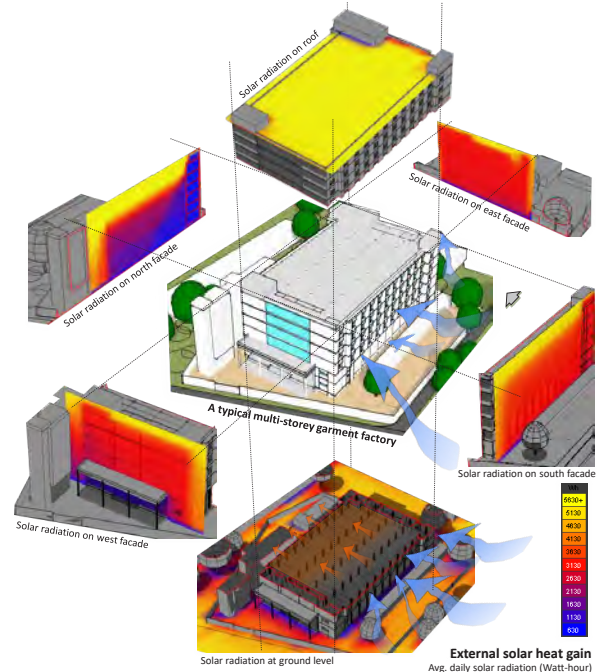

- **Researcher:** Mohataz Hossain
- **Supervisors:** Dr Robin Wilson, Benson Lau, Brian Ford and Dr Yupeng Wu
- **Time span:** 2013-2019
- **Contact data:** mdmohataz.hossain@nottingham.ac.uk
- **Associated Publications:**

- M.M. Hossain, B. Lau, R. Wilson & B. Ford. Effect of Changing Window Type and Ventilation Strategy on Indoor Thermal Environment of Existing Garment Factories in Bangladesh, *Architectural science review*, 60(4), 299-315, 2017.
- M.M. Hossain, B. Lau, R. Wilson & B. Ford. Air Temperature vs Energy Efficiency of Workspaces: A field investigation in garment factories during cool-dry season, *SET 2016*, Singapore, 2016.
- M.M. Hossain, B. Lau, R. Wilson & B. Ford. Evaluating Ventilation Performance of Work-Spaces in Ready-made Garment Factories: Three case studies in Bangladesh, *PLEA 2015*, Bologna, Italy, 2015.
- M.M. Hossain, B. Ford & B. Lau. Improving Ventilation Condition of Labour-intensive Garment Factories in Bangladesh, *PLEA 2014*, Ahmedabad, India, 2014.

Investigation of composite plywood material as element of Exoskeleton structure

► **Neda Džombić, PhD student, University of Belgrade, Faculty of Architecture**

► **Research information**

Introduction, Background to the Research (Research Theme)

Plywood is one of the important wood-based composites produced from different species of trees, made by bonding together pieces of wood in perpendicular direction between each other. Current application of plywood panels in architecture primarily is non-structural application, that is application for coating elements, constructive application as secondary elements of structure (horizontal and vertical diaphragms). In order to expand their application, methods for improving the quality of veneer panels are being examined today. The most common method is the reinforcement of veneer sheets by materials based on polymer reinforced fibers (FRP). This reinforcement creates new composite products whose constructive characteristics are significantly improved.

The aim of the research is to investigate possibilities and needs of use and application of new composite plywood material as primary structural elements, elements of spatial structures or the entire structure of architectural objects.

Keywords: plywood, engineered wood, FRP, spatial structures, structural elements

Research problem

Problem of research is observation behavior of the new constructive material and its advantages, disadvantages and limitations. This material is new one, and its application is being tested on small objects and pavilions. However, production of complex geometry or curved elements has not been tested yet.

Research Questions (Main Questions and sub question)

Main question

- What are the potential limits of composite plywood material and can we use it for entire structure of architectural objects?
- For widening its application panel shear strength is important mechanical characteristic, how can we improve it?

Sub-questions

- How can we produce panels of curved geometry, without damaging the structure of panels?
- What are the potential limits of this products?

Research Objectives

Application of composite plywood panels is not investigated. Previous research is based on experimental testing its mechanical properties. This research should analyse previous research of mechanical properties and find possibility of application this panels in architecture.

- Analyse mechanical properties of panels reinforced with glass or carbon polymers.
- Comparative analysis of products different reinforced.
- Experimental research of panels mechanical properties.
- Identify key problems that hinder or limit their architectural application.
- Examine the possibility of forming free forms of this material.

Research Deliverables

- A summary of all key problems prioritised by importance.
- Summary of desirable performance parameters.
- Make prototype model of object in small scale to test structural behaviour.



ICD-ITKE Research Pavilion 2011. ICD-ITKE University of Stuttgart. Photo by Roland Halbe.



Ryuichi Ashizawa Architects. Folded structure at Aqua Metropolis Osaka Event Photo by RAA.

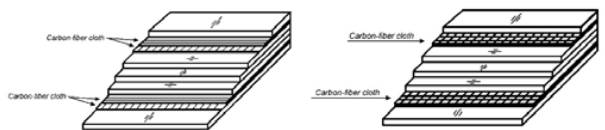

- **Researcher:** Džombić Neda, M.Arch
- **Supervisors:** Nenad Šekularac, Associate Professor
- **Time span:** 2015-
- **Contact data:** dzombic.neda@gmail.com
- **Associated Publications:**

Bal, Bekir Cihad, Ibrahim Bektaş, Fatih Mengeloğlu, Kadir Karakuş, / H. Ökkeş Demir. 2015. „Some technological properties of poplar plywood panels reinforced with glass fiber fabric.“ *Construction and Building Materials* 101 (Part 1): 952-957.

Bal, Bekir Cihad, / Ibrahim Bektaş. 2012. „The effects of wood species, load direction, and adhesives on bending properties of laminated veneer lumber.“ *BioResources* 7 (3): 3104-3112.

Davalos, Julio F., Pizhong Qiao, / Brent S. Trimble. 2000. „Fiber-Reinforced Composite and Wood Bonded Interfaces: Part 1. Durability and Shear Strength.“ *Journal of Composites, Technology and Research* 22 (4): 224-231.

Problems of reconstruction of reinforced concrete façades

► **Nikola Macut, University of Belgrade, Faculty of Architecture, Department of Architectural Technology**

► Research information

Introduction, Background to the Research (Research Theme)

Research theme is related to the analysis of possibilities of reconstruction and energy renovation of façades of residential multifamily buildings in New Belgrade (Serbia), built since late 1950s until the late 1970s, which today present architectural heritage. Buildings were constructed by the use of prefabricated and semi-prefabricated systems and reinforced concrete was the main applied material. Today after approximately 50 years of exploitation those buildings are not in the good condition and façades have various types of damages so they need large scale reconstruction and also energy renovation.

Research problem

The basic research problem presents the affects of applied reconstruction and renovation principles on the protection of original appearance of reinforced concrete façades which have to be reconstructed and energy renovated.

Research Questions (Main Questions and sub question)

Main question

-“How is it possible to reconstruct or repair elements of façades and do energy renovation without changing the original appearance of those elements?”

Sub-questions

1. “How do the geometries of façade elements affect to the possible applied principles of reconstruction and energy renovation of analysed façades?”
2. “How do the applied finishing layers (coatings, exposed concrete, coulier, ceramic or glass tiles) of façade elements affect to the possible ways of reconstruction and energy renovation?”
3. “How do the types of façade damages affect to the scales of reconstruction?”
4. “What are the main principles for preventing the original appearance of façades during the processes of their reconstruction and energy renovation?”

Research Objectives

This research was done throughout specific steps in case of creating possible methodologies for reconstruction and energy renovation of reinforced concrete façades:

1. Field research and taking photos of buildings and their facade damages,
 2. Mapping of present damages,
 3. Analysis of technical drawings of selected buildings,
 4. Analysis of different types of literature which are related to research topic,
 5. Creating typology of present damages,
 6. Analysis of possible measures for reconstruction and energy renovation,
 7. Creating possible methodologies for reconstruction and energy renovation in case of selected residential buildings.
- Note: Steps 2., 3. and 4. were done parallel.

Research Deliverables

1. Creation of typology of present facade damages of analysed buildings.
2. Creation of methodologies for facade reconstruction and energy renovation.
3. Results of analysed applied methodologies for reconstruction and energy renovation in case of preventing original appearance of façades.

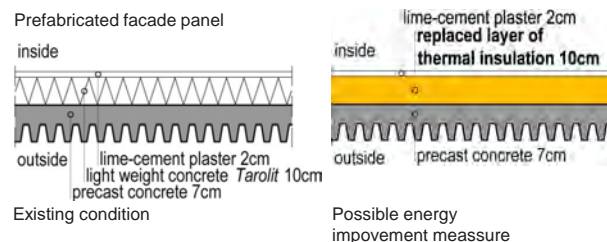

- **Researcher:** Nikola Macut
- **Supervisors:** Ana Radivojević
- **Time span:** 2013-2019
- **Contact data:** nikola.macut@arh.bg.ac.rs
- **Associated Publications:**

- *N. Macut, A. Radivojević, Prefabricated concrete facade and their existing condition: case study of New Belgrade's residential buildings, SAHC 2016, Leuven, Belgium*
- *N. Macut, A. Radivojević, Problem of protection of original appearance of prefabricated concrete facades and energy improvement measures-example New Belgrade, P&T2016, Belgrade, Serbia*
- *N. Macut, A. Radivojević, Preservation of original appearance of exposed concrete facades, case study: Residential block 23, New Belgrade, P&T2018, Belgrade, Serbia*

Multi-objective Optimization in Adaptive Facade Design

► **Yesim Keskinel, Izmir Institute of Technology Faculty of Architecture, Architecture Department**

► **Research information**

Introduction, Background to the Research (Research Theme)

The aim of this research is finding the best alternative adaptive façade design by comparing single oriented and double oriented façades to obtain low energy consumption and high illumination values in an office room. The process consists of three main title. These are designing two different oriented adaptive facade, simulate them in terms of their illuminance value of horizontal working plane and evaluate their building performance in multi objective way .

Research problem

The key point of the designing adaptive facade is creating balance between different performance aspects, such as solar radiation energy consumption and useful daylight illumination value in office room. To reach the minimum in energy consumption while reaching maximum in effective daylight usage is the challenge of this study.

Research Questions (Main Questions and sub question)

Main question

- Why do we need multi objective optimization in adaptive facade design?
- What is the role of adaptive facades on building performance?

Sub-questions

- Which type of adaptive facade is more convenient to requests?
- Do double oriented facade use daylight more effective way?
- What are the significant differences between single and double oriented façades in terms of building performance.

Research Objectives

Different oriented façades have not been researched in a detail in current studies. On the other hand, multi objective optimization in adaptive facade design has a significant role to evaluate their performance. The research objectives would be as follows;

- Designing the parametric models of adaptive façades.
- Simulate their useful illuminance value.
- Evaluate them in terms of different performance aspects.
- Understanding the role of multi-objective optimization in adaptive facade design.

Research Deliverables

- Comparison of different oriented adaptive facade designs
- Evaluate multi-objective optimization in adaptive facade design

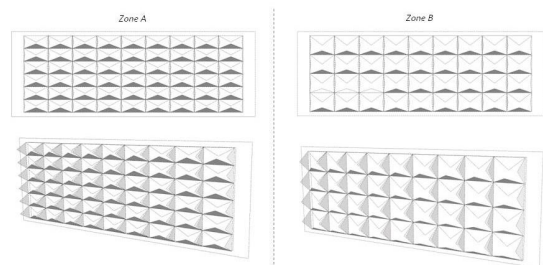
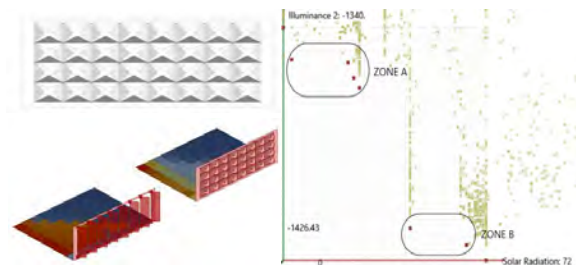
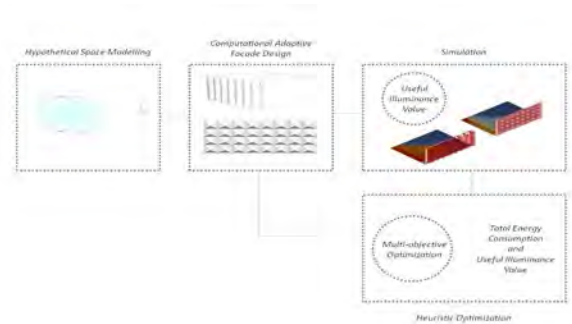

- **Researcher:** Yesim Keskinel
- **Supervisors:** Mustafa Emre İlal
- **Time span:** 2017-2019
- **Contact data:** yesimkeskinel@iyte.edu.tr
- **Associated Publications:**

WALLED: Smart Module for Lighting and Media-Building

► **Yorgos Spanodimitriou, University of Campania ‘Luigi Vanvitelli’, Department of Architecture and Industrial Design**

► **Research information**

Introduction, Background to the Research (Research Theme)

The research is aimed at developing an innovative smart module capable of combining the advantages of a double skin façade with those of a media façade. In order to reach this objective, the module will be a smart element capable of combining the possibility to improve the thermal performance of opaque and transparent building façades with the characteristics of dynamic lighting, in which different technologies (LED, OLED, sensors...) will be integrated. Many modules could be connected to each other in order to realize complex compositions. In the architecture field, these complex compositions can be used as an external “technological second skin” of a building.

Research problem

The main problem in the integration of the two façade systems is to guarantee the desired optical and thermal performance despite the integration of complex plant systems, as well as the possibility to integrate the module into existing double skin façade systems. To overcome this problems, accurate design and testing of the prototypes is required.

Research Questions (Main Questions and sub question)

Main question

- “How is possible to integrate into a single module the components to realize a double skin façade and a media façade?”

Sub-questions

- “Which are the performance parameters to follow in the design phase?”
- “Which kind of content can be displayed?”
- “What is the commercial potentiality for this technology?”

Research Objectives

To answer the questions and achieve a functioning product, the research will be lead through five main objectives:

1. Define a state of the art of innovative materials and brief design;
2. Prototype a WALLED module;
3. Experimental characterization through laboratory measurements;
4. Calibration and validation of simulation models;
5. Development of full-scale demonstrators.

Research Deliverables

The research will deliver a functioning prototype of the WALLED module and a viable methodology to design, test and simulate this kind of technology, based on state of the art analysis, laboratory experiments and on-field surveys. The aim is also to realize a solid research method for other future projects in this field.

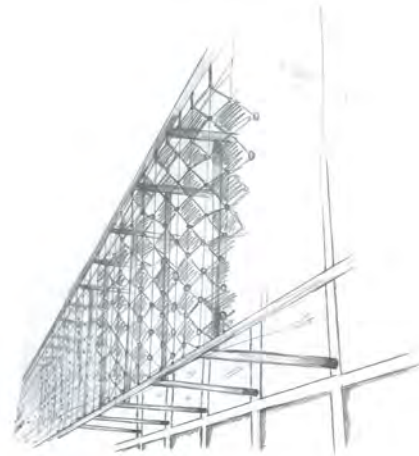

Sketch showing the development of a concept module on an entire façade.

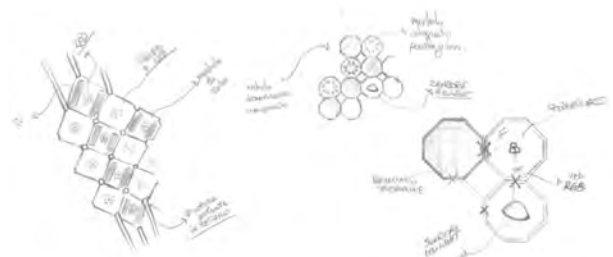

Sketches for the module from the concept stage.

- **Researcher:** Yorgos Spanodimitriou
- **Supervisors:** Prof. Ing. Sergio Sibilio
- **Time span:** 2018-2021
- **Contact data:** yorgos.spanodimitriou@unicampania.it
- **Associated Publications:**
 - Sibilio et al., *Adaptive and dynamic facade: a new challenge for the built environment, Le vie dei Mercanti 2018, Napoli, Italy*



Kyoto National Museum / Yoshio Taniguchi (image: M. Brzezicki)

Short Term Scientific Missions (STSMs)



Table 1 - Overview of Granted STSMs

Visitor	Country	Host	Country
1st call – April 2015:			
1. José Miguel Rico Martinez, <i>University of the Basque Country</i>	ES	Tillmann Klein, <i>TU Delft</i>	NL
2. Marcin Brzezicki, <i>Wroclaw University of Technology</i>	PL	Ulrich Knaack, <i>TU Delft</i>	NL
3. Fabio Favoino, <i>University of Cambridge</i>	UK	Francesco Fiorito, <i>University of Sydney</i>	AU
4. Alejandro Prieto, <i>TU Delft</i>	NL	Thomas Auer, <i>TU Munich</i>	DE
2nd call – October 2015:			
5. Mira Conci, <i>TU Darmstadt</i>	DE	Tillmann Klein, <i>TU Delft</i>	NL
6. Komnen Zizic, <i>University of Belgrade</i>	RS	Ulrich Knaack, <i>TU Delft</i>	NL
7. Susanne Gosztonyi, <i>Lund University</i>	SE	Jens Böke, <i>Hochschule Ostwestfalen-Lippe</i>	DE
8. Filipe Fimo, <i>University of Coimbra</i>	PT	Chiara Bedon, <i>University of Trieste</i>	IT
9. Bert van Lancker, <i>Ghent University</i>	BE	Paulo Santos, <i>University of Coimbra</i>	PT
3rd call – February 2016:			
10. Chiara Bedon, <i>University of Trieste</i>	IT	Mauro Overend, <i>University of Cambridge</i>	UK
11. Sandra Persiani, <i>Sapienza University of Rome</i>	IT	José Miguel Rico Martinez, <i>University of the Basque Country</i>	ES
4th call – May 2016:			
12. Philipp Molter, <i>TU Munich</i>	DE	Tillmann Klein, <i>TU Delft</i>	NL
13. Emanuela Giancola, <i>CIEMAT</i>	ES	Valentina Serra, <i>Polytechnic University of Turin</i>	IT
14. Rosa Romano, <i>University of Florence</i>	IT	Laura Aelenei, <i>LNEG</i>	PT
15. Giulio Cattarin, <i>Politecnico di Milano</i>	IT	Francesco Goia, <i>Norwegian University of Science and Technology</i>	NO
16. Pascal Vullo, <i>EURAC Research</i>	IT	Philippe Thony, <i>CEA</i>	FR
5th call – April 2017:			
17. Stefano Fantucci, <i>Polytechnic University of Turin</i>	IT	Francesco Goia, <i>Norwegian University of Science and Technology</i>	NO
18. Claudio Aresta, <i>TU Munich</i>	DE	Daniel Aelenei, <i>Universidade Nova de Lisboa</i>	PT
19. Gabriele Pisano, <i>University of Parma</i>	IT	Jens Schneider, <i>TU Darmstadt</i>	DE
20. Nitisha Vedula, <i>Hochschule Ostwestfalen-Lippe</i>	DE	Laura Aelenei, <i>LNEG</i>	PT
21. Luigi Giovannini, <i>Polytechnic University of Turin</i>	IT	Mauro Overend, <i>University of Cambridge</i>	UK
22. Aleksandar Andjelkovic, <i>University of Novi Sad</i>	RS	Vlatka Rajcic, <i>University of Zagreb</i>	HR
23. Miren Juaristi, <i>University of Navarra</i>	ES	Ulrich Knaack, <i>TU Delft</i>	NL
24. Marcin Brzezicki, <i>Wroclaw University of Technology</i>	PO	Laura Aelenei, <i>LNEG</i>	PT
25. Matthias Friedrich, <i>HafenCity Universität Hamburg</i>	DE	Olena Larsen, <i>Aalborg University</i>	DK
6th call – February 2018:			
26. Marcin Kozlowski, <i>Silesian University of Technology</i>	PL	Chiara Bedon, <i>University of Trieste</i>	IT
27. Francesco Causone, <i>Politecnico di Milano</i>	IT	Mauro Overend, <i>University of Cambridge</i>	UK
28. Theoni Karlessi, <i>National and Kapodistrian University of Athens</i>	GR	Gianluca Ranzi, <i>University of Sydney</i>	AU
29. Aleksandar Petrovski, <i>Ss. Cyril and Methodius University</i>	MK	Aleksandra Krstic-Furundzic, <i>University of Belgrade</i>	RS
30. Chiara Bedon, <i>University of Trieste</i>	IT	Daniel Honfi, <i>RISE</i>	SE
31. Michael Drass, <i>TU Darmstadt</i>	DE	Jan Belis, <i>Ghent University</i>	BE

Short Term Scientific Missions (STSMs)

Christian Louter

Introduction

Short Term Scientific Missions (STSM) are institutional visits aimed at supporting individual mobility, fostering collaboration between individuals. Short-Term Scientific Missions (STSMs) allow scientists to learn from an institution or laboratory in another COST country - a concept of particular interest to young scientists.

STSMs can vary from one week to three months and up to six months for Early Stage Researchers. Applicants must be engaged in a research programme in an institution from a COST country which must have accepted the Memorandum of Understanding (MoU) of the COST Action. Both home and host institution should be in a COST country which has accepted the MoU and has participated in the COST Action [http://www.cost.eu/media/cost_stories/Short-Term-Scientific-Missions].

EU COST Action TU1403 'Adaptive Facades Network' has issued about twice per year a call for STSMs. Within each call, the aim was to relate the topics of the STSMs to specific deliverables that are described in the MoU and which are related to the different Working Packages. In addition, the STSM visitor and host were requested to provide input for the Education Pack (EduPack) on the topic of the STSM and on their own specific expertise.

To evaluate the STSM applications, an STSM review panel was installed. This STSM review panel evaluated the STSM applications on the following criteria:

- Quality and feasibility of the Workplan
- Quality and feasibility of the Prospected Outcome
- Suitability of the applicant to execute the Workplan and to reach the Prospected Outcome
- Benefits of the STSM for the applicant (visitor)
- Benefits of the STSM for the COST Action TU1403

Successful applications were granted and resulted in an STSM.

In total, EU COST Action TU1403 'Adaptive Facades Network' has issued 6 calls for STSMs and has granted more than 30 STSM applications for a total budget of about € 65.000. In these STSMs, 46 individuals, 16 EU countries, 1 near neighbour country (AU) and 34 different institutions have been involved, many of them Early Stage Researchers (ESR) / Early Career Investigators (ECI). An overview of all STSM visits is provided at http://tu1403.eu/?page_id=154 and a summary of the STSM visits is included in this book.

The STSMs have contributed to the MoU deliverables and have resulted in joint journal and conference publications, new collaboration initiatives and active contributions to the Education Pack (EduPack).

Elaboration of Teaching Units for Members of the Adaptive Facade Network

DURATION	09/06/2015 - 27/06/2015
VISITOR	Prof. José Miguel Rico Martínez
HOME INSTITUTION	The University of the Basque Country, School of Architecture
HOME COUNTRY	Spain
HOST	Prof. Dr.-Ing. Tillmann Klein
HOST INSTITUTION	Delft University of Technology, Faculty of Architecture
HOST COUNTRY	The Netherlands
RELEVANT WORKGROUP(S)	WG1
INVOLVED RESEARCHERS	R.C.G.M. Loonen, TU Eindhoven; F.Favoino, UCambridge; C.Menezes, USMB; G. La Ferla, Universidad Politecnica de Madrid; L.Alenei, LNEG.

Adaptive facades provide opportunities for significant reductions in building energy use and CO₂ emissions, while at the same time having a positive impact on the quality of the indoor environment. Many different types of adaptive façade concepts (materials, components and systems) have already been developed, and an increase in emerging, innovative solutions is expected in the near future. The goal of this paper is to contribute to these developments by describing activities of EU COST Action TU1403 aiming at the classification of adaptive façade concepts. It presents an analysis of existing classification approaches to identify requirements and challenges that are faced in this process. Based on an analysis of strong points in these approaches, they propose a new matrix that can be used to characterize adaptive façade concepts in a comprehensive way. The elements of this matrix are explained with the use of three case studies: dynamic exterior shading facades, glazing with phase change materials and BIPV double-skin facades. They conclude the paper by providing directions for future extension of the characterization matrix and an outline of planned follow-up research activities. The activities in the COST Action are organized in four working groups. Martínez took part as a member of Working Group 1: Adaptive Technologies and products. The main objective of his mission was to make progress in the tasks of the working group with the help and collaboration of the Facade Research Group from TU Delft. He focused on the analysis of existing research about adaptive envelopes to achieve a robust common base of knowledge and this work was expressed in the resulting article he wrote in collaboration with other members of the COST action for Energy Forum 2015.

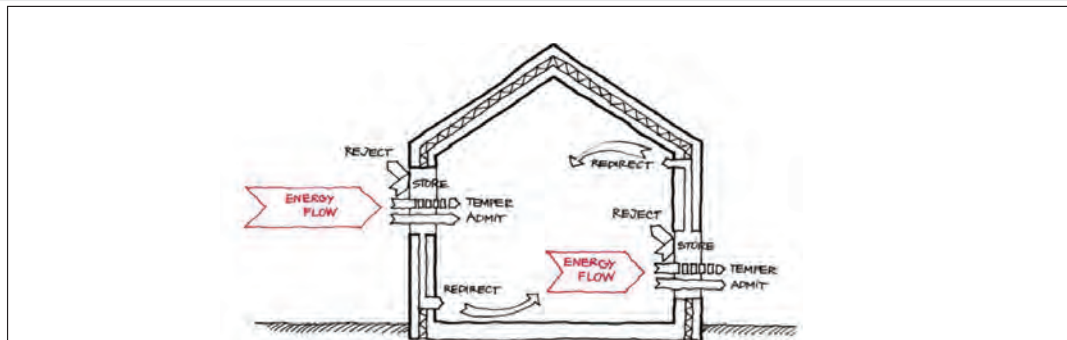

Fig.1. Illustration of the dynamic energy flows and interactions in buildings with adaptive/responsive facades

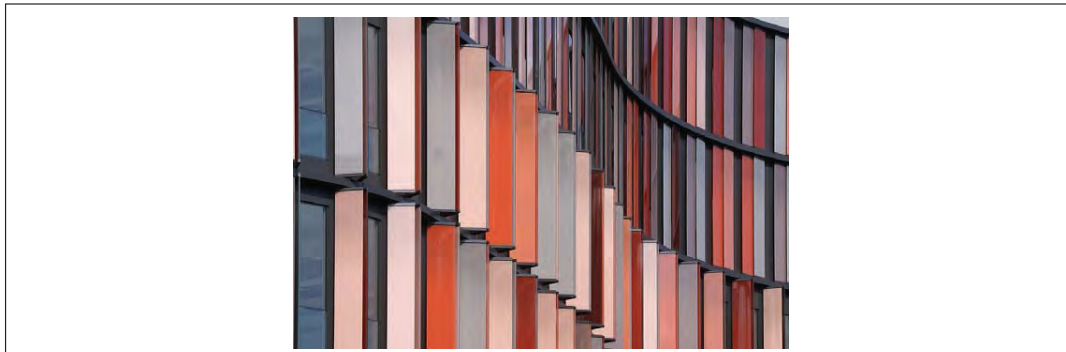

Fig. 2. Vertical axis glazed sun louvers serve the purpose of light regulation, and simultaneously, perform as outstanding architectural facade element, Cologne.

Sharing the Experience in Visions, Material Technology, Façade Design of the Future Building Envelope

DURATION	31/08/2015 - 25/09/2015
VISITOR	Dr. Marcin Brzezicki
HOME INSTITUTION	Wroclaw University of Technology, Faculty of Architecture
HOME COUNTRY	Poland
HOST	Prof. Dr.-Ing. Ulrich Knaack
HOST INSTITUTION	Delft University of Technology, Faculty of Architecture
HOST COUNTRY	The Netherlands
RELEVANT WORKGROUP(S)	WG1, WG4
INVOLVED RESEARCHERS	Facade Research Group, TU Delft

To make a contribution to Task 4.4. - Database of research project and experimental facilities in the domain of the Action and Task 4.4. - Database of research project and experimental facilities in the domain of the Action, as being the first objective of this STSM, over 40 posters prepared by the Action members have been collected, printed and presented during the COST TU 1403 Autumn Meeting in Delft, 16-17 September 2015. In parallel to that, 3 additional documents have been prepared: a poster map (Fig. 1) – showing the research areas of the facades presented in the posters, a keyword list – presenting the most frequent keywords, and a list of posters – indicating the geographical locations of the contributing institutions.

The second objective of the STSM was contributing to the WG1's database of case studies. In this regard, an Excel database has been created and filled in with over 60 adaptive building entries and 15 adaptive technology entries. At the end, this database has been proposed in a form of web-survey (Fig. 2) to the WG1 members and WG leaders which served the discussion of future structure and contents of the database.

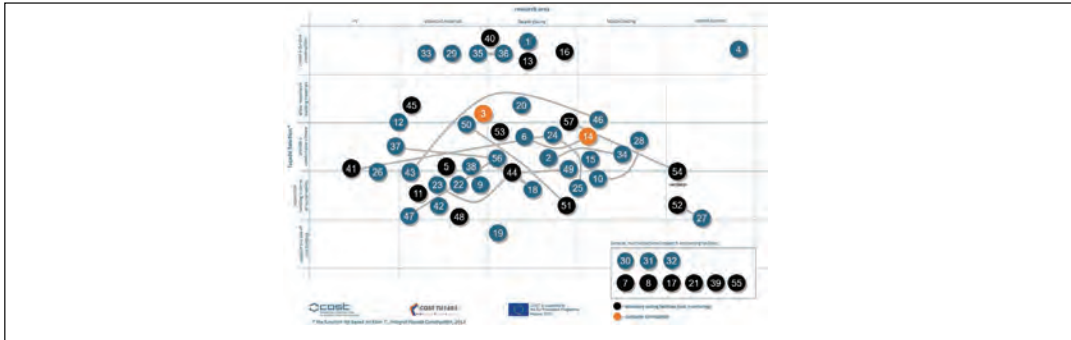

Fig. 1. New poster map – façade function vs. research area. Map prepared based on the contents of the posters, COST TU 1403, WG 4

COST TU 1403 WG 1 Database Survey - 97

2- Basic level of information

Collection of adaptive facade product facts:

Product: a material can be or different types of influences such as rays, individual or coupled. Also materials which and inseparable combined, such as in metals, siding or the category: transparent, translucent, thermal, sound, smoke, flame, change material.

Component: is composed to an assembly of different part of elements. It forms a complete construction or functional unit or part of a facade. For example an horizontal glass unit that also a window frame including glazing or a unit shading device.

Sub-component: a facade (or roof) system is composed of different transparent or opaque (structural or technical) components. It fulfills all basic technical facade functions such as insulation, rain and wind shelter.

Building: the COST Action analyses adaptive facade cases and here information about the building level described the context in which a facade is placed. In many cases, the performance of adaptive materials, component or facades can only be judged on the building context.

*1. Adaptive facade (AF) study case type:

facade component facade system

*2. Case study name (material/component/facade system), research project title, building name (max 20 characters):

3. Building location (if applicable)

Location name: _____

Latitude: _____

Longitude: _____

4. Year of construction (for built solutions) or date of proposal/realisation:

5. Main author / Group:

6. Keyword parties (more detailed information)

Designer / Developer / Researcher: _____

Structural Engineer: _____

Optical Engineer: _____

Facade Consultant: _____

Manufacturer: _____

Contractor: _____

Building / project owner: _____

Other party involved: _____

Fig. 2. Case-study survey prepared by COST TU 1403, WG 1 (partial contribution by the Grantee)

Development of Innovative Simulation Strategies Enabling to Assess the Behaviour of Smart Glazing Technologies

DURATION	21/09/2015 - 01/11/2015
VISITOR	Fabio Favoino
HOME INSTITUTION	University of Cambridge, Faculty of Engineering
HOME COUNTRY	The UK
HOST	Dr Francesco Fiorito
HOST INSTITUTION	The University of Sydney, Faculty of Architecture, Design & Planning
HOST COUNTRY	Australia
RELEVANT WORKGROUP(S)	WG2
INVOLVED RESEARCHERS	-

Current Building Performance Simulation (BPS) tools have limited capability at evaluating the performance of adaptive building envelope technologies. In order to overcome the limitations different modelling approximations are typically adopted which can lead to gross errors in the simulation results. Therefore, there is a need to develop new simulation strategies and tools. The main objective of the STSM is to develop and test a simulation strategy enabling the performance evaluation and the optimisation of innovative building integrated smart glazing technologies. To this objective, after the effects of different parameters on daylight metrics were analysed, a parametric daylight tool was designed using MatLab interface, in such a way to be later integrated in the simulation strategy with EnergyPlus. The tool was tested for different office configurations, in different climates, according to the thermo-optical properties of the photo-volta-chromic glazing (PVCG) adopted for the case study. Also, a thermal model was built to fit the purpose of this case study with EnergyPlus, whose control of the adaptive façade could be optimised according to the results of both the daylight and thermal simulations. Then, the two parametric models were integrated into a unique simulation strategy. The architecture of the integrated simulation strategy is shown in Figure 1. Finally, the performance of the PVCG technology integrated in an office building was evaluated according to different control strategies and in different temperate climates (Sydney, London and Rome). In particular, this tool can be really useful in filling the gap between technology driven and performance driven product development in the context of adaptive facades. In fact, it enables the evaluation of adaptive technologies which are still under development, but it also enables to evaluate the highest performance of an adaptive façade achievable, according to different objectives, if optimally controlled.

The work carried out during the STSM resulted in the following open access research paper: Favoino F., Fiorito F., Cannavale A., Ranzi G., Overend M., Optimal control and performance of photovoltachromic switchable glazing for building integration in temperate climates, Applied Energy 178, 2016, Pages 943-961, ISSN 0306-2619, <https://doi.org/10.1016/j.apenergy.2016.06.107>.

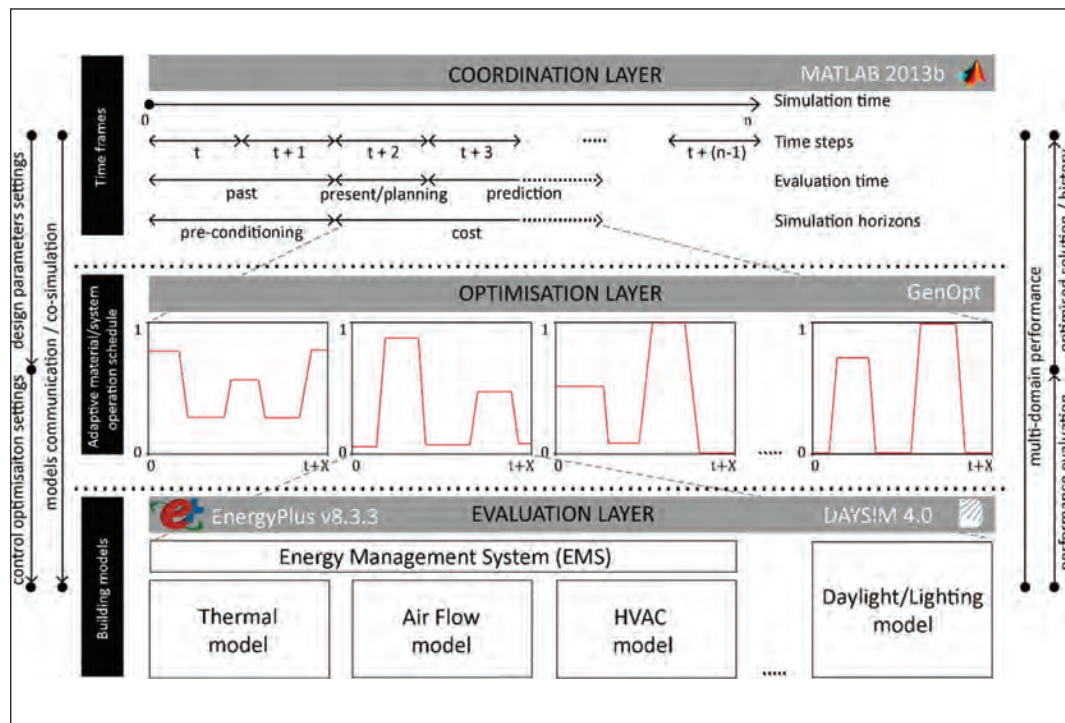

Fig. 1. Integrated simulation strategy for design and control optimisation in multiple physical domains for adaptive/material systems (Favoino et al., 2016)

Architectural Integration of Solar Driven Cooling Strategies into Facade Systems

DURATION	18/10/2015 - 16/11/2015
VISITOR	Alejandro Prieto
HOME INSTITUTION	Delft University of Technology, Faculty of Architecture
HOME COUNTRY	The Netherlands
HOST	Prof. Dipl.-Ing. Thomas Auer
HOST INSTITUTION	Munich University of Technology, Faculty of Architecture, Design & Planning
HOST COUNTRY	Germany
RELEVANT WORKGROUP(S)	WG1
INVOLVED RESEARCHERS	-

During this STSM available solar driven cooling technologies were reported and compared in terms of performance and feasibility for façade integration. Selected technologies to review are sorption cooling (absorption & adsorption), desiccant cooling (solid & liquid), and thermoelectric cooling, including vapour compression heat pumps coupled with PV cells.

Within the review activity, descriptive schemes were developed for each cooling technology, considering energy inputs, functioning principles and required components, as well as minimum requirements to consider while evaluating integration possibilities. A sample scheme for an absorption heat pump is given in Fig. 1. A database of 270 entries of prototypes and new developments was generated with basic information after an initial review (Fig. 2). Although the framework (Fig. 3) and methods for the evaluation of solar cooling technologies were defined, the evaluation parameters still needed to be tested and validated.

Additionally, research projects related with solar cooling development and/or façade integration of building services were reviewed and a database of relevant research projects and researchers was made. Also, results of the developed survey to gather information about the main problems and barriers for the integration of building services in facades were analysed descriptively. Similarly, two interviews were conducted with the experts and provided valuable input for the project.

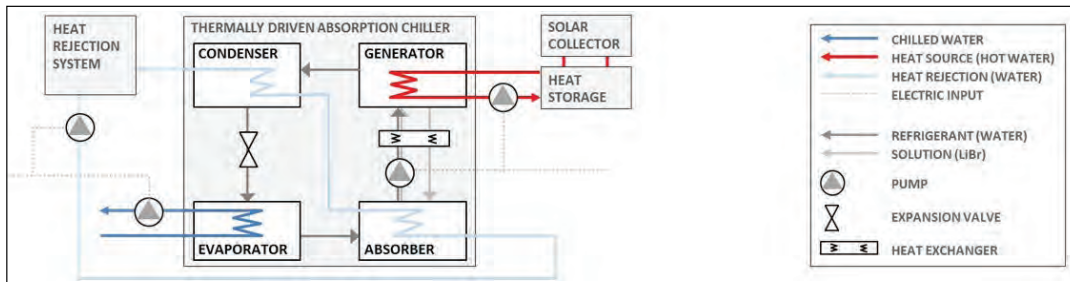

Fig. 1. Scheme of working principle and components of an absorption heat pump

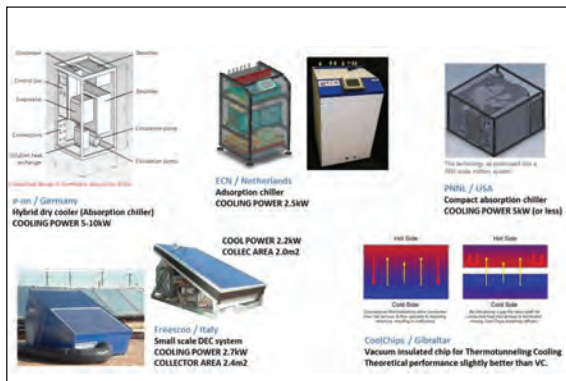

Fig. 2. Examples of some prototypes and new developments using several solar cooling technologies

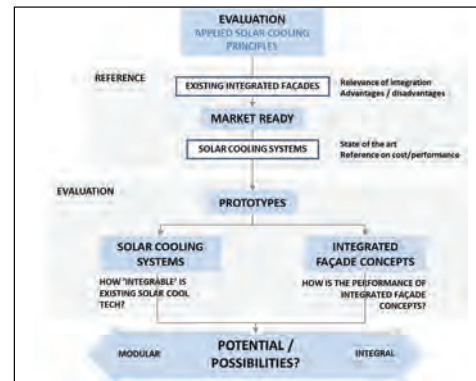

Fig. 3. Framework for the evaluation of solar cooling integration possibilities

Ownership Models to Accelerate Integral Energy Renovations

DURATION	02/11/2015 - 20/11/2015
VISITOR	Mira Conci
HOME INSTITUTION	TU Darmstadt, Institute for Structural Mechanics and Design
HOME COUNTRY	Germany
HOST	Prof. Dr.-Ing. Tillmann Klein
HOST INSTITUTION	Delft University of Technology, Faculty of Architecture
HOST COUNTRY	The Netherlands
RELEVANT WORKGROUP(S)	WG3
INVOLVED RESEARCHERS	Juan Azcarate, Thaleia Konstantinou, Alejandro Prieto, Alexandra den Heijer, David Peck, Andy v.d. Dobbelsteen, Michela Turrin, Job Schroen, Marcel Bilow / TU Delft

This STSM was framed into the activities developed as part of the visitor's PhD research and the EnEff:Stad pilot project "SWIVT: District energy modules for existing residential areas - Impulses for linking energy efficient technologies". The objective of the STSM is the delivery of a scientific paper on the requirements for building integration and user interaction for adaptive and multifunctional facades, and it served the authors to define the boundaries and set the working method. The identified structure of the paper will investigate the adaptive façade under the themes of integrations (structural, architectural and building services), interaction (user and component), and multidisciplinary perspective (stakeholders, socio-political decision-making, business cases). Key contacts are identified from the visitor university and the host university for each theme.

Besides, with the aim of enriching knowledge on these topics, an edX course "Circular Economy: an introduction" is completed, a design session of a TU Delft ongoing research project "Integrated Facades as a Product-Service System" (IFPSS) is attended where also representatives from the companies were present with their façade-integrated products, and it is participated in a Climate-KIC Event "Innovation Building Block – Leadership for Sustainability".

The STSM enabled to create a shared body of knowledge between specific scientific researches, which constituted a necessary framework for the writing of the paper. This exchange was successfully accomplished and already resulted in the TU Delft application for a 3TU Lighthouse project proposal entitled "A digital integration platform for multifunctional façades".

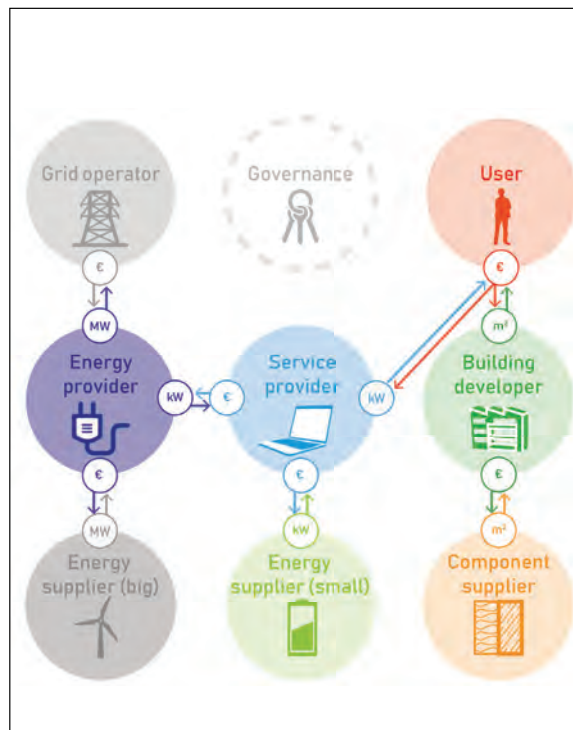

Fig. 1. Stakeholders interactions defined during the STSM, introducing a service provider as facilitator for the acceleration of energy renovations



Fig. 2. Multidisciplinary topics investigated during the STSM

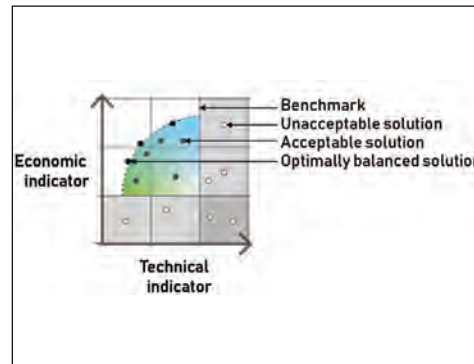

Fig. 3. Economic and technical evaluation model for the assessment of design solutions for integral energy renovations

Digital Tools for Performance Assessment of an Adaptive Façade in the Early Phase of Design

DURATION	09/11/2015 - 20/11/2015
VISITOR	Kommen M. Zizic
HOME INSTITUTION	University of Belgrade, Faculty of Architecture
HOME COUNTRY	Serbia
HOST	Prof. Dr.-Ing. Ulrich Knaack, Prof. Dr.-Ing. Tillmann Klein
HOST INSTITUTION	Delft University of Technology, Faculty of Architecture
HOST COUNTRY	The Netherlands
RELEVANT WORKGROUP(S)	WG2, WG3
INVOLVED RESEARCHERS	Facade Research Group; Computation and Performance Group / TU Delft

The objective of the STSM was to further develop methods and techniques for modelling adaptive facade with expert assistance from TU Delft. A framework and a conceptual model of the research has been defined by reviewing articles, research papers, PhD theses and books, and also in discussions, conversations and meetings with experts.

Since there is a lack of methods for assessing and evaluation the performance of the adaptive envelope at component and whole building scale, the research focused on component level and on integration adaptive system with the building. The scope of research has been narrowed down to exterior shading systems that can adapt to changeable circumstances. Also, there is little guidance how to model the adaptive envelope system and how to simulate in a suitable way. Therefore, within the area Computer-Aided Architectural Design (CAAD), performance, early phase of design, digital tools and adaptive envelope were defined. Current modelling and simulation techniques of adaptive façade for prediction and performance evaluation were collected and classified. This eventually served to define the possible future research directions: a) Multi objective optimization of the adaptive envelope in the early phase design to make efficient decisions; b) Relations between BIM and parametric model in the early phase of design; c) User interaction with adaptive facade predicted by simulation. The research results were planned to be published in two international conferences.

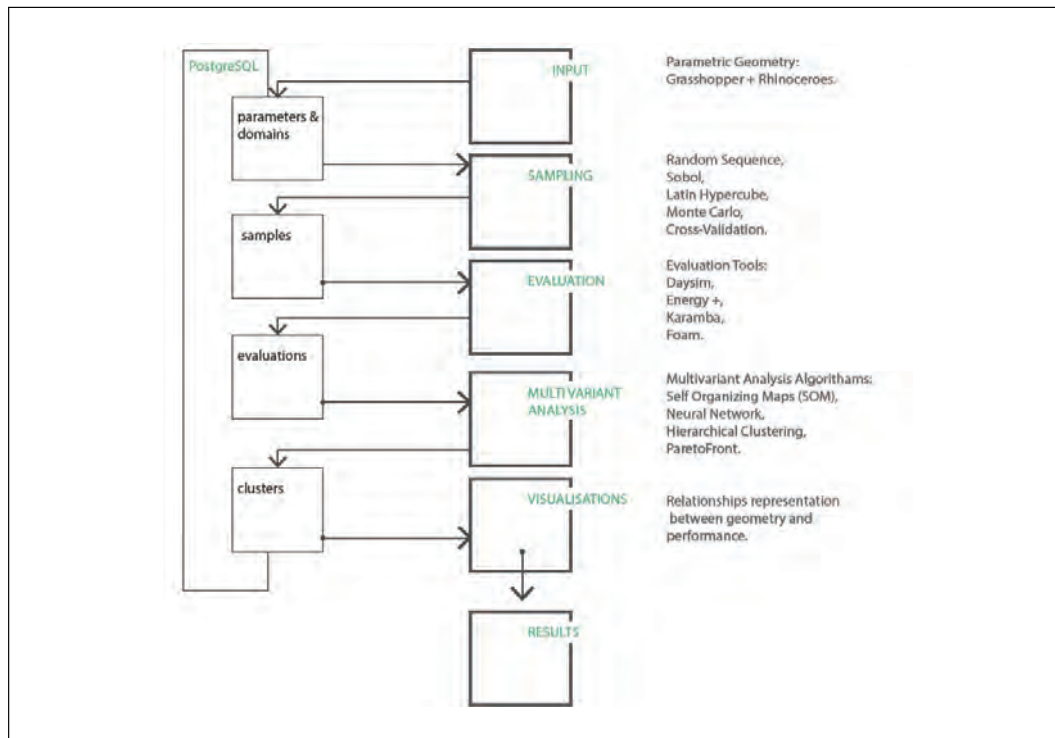

Fig. 1. Framework for performance prediction and evaluation of adaptive envelope system in the early phase of design

Kick-Off for Investigation and Publication on Functional and Architectural Characteristics of Adaptive Facades Targeting at the Term “Intelligence”

DURATION	26/11/2015 - 05/12/2015
VISITOR	Susanne Gosztanyi
HOME INSTITUTION	Lund University, Faculty of Engineering
HOME COUNTRY	Sweden
HOST	Dr. Uta Pottgiesser, Jens Böke
HOST INSTITUTION	Hochschule Ostwestfalen-Lippe
HOST COUNTRY	Germany
RELEVANT WORKGROUP(S)	WG1
INVOLVED RESEARCHERS	-

This STSM focused on the initiation of a joint investigation in regards to “intelligent” measures and architectural criteria for adaptive facades, which shall result in contributions to the WG1 database that displays technological solutions and applications for adaptive facades (Fig. 1). Since there is no definition yet existing on “adaptive facades”, the investigation targets at a common view of criteria and a meaningful description of the function “intelligence” and “adaptive facades” that considers different needs from architectural engineering, system engineering and architectural design.

As a preliminary work to the STSM, a draft concept has been developed for an integrated design approach to functional and formal requirements for adaptation of facades, merging technological (functional) and architectural (formal) measures. The concept has been presented at the conference facade2015 in Detmold and served as a basis for feedback discussions at the conference and later for the literature survey. The results of the STSM are a first listing of key criteria for the terms “adaptation” and ‘intelligence’ in connection with adaptive facades in order to formulate a taxonomy. Reviewed descriptions and examples for the terms in the fields architectural engineering, computational sciences and biomimetics revealed that both terms have different meanings, but are discussed in parallel in the same context. To link their meanings, a drafted concept of extended criteria for adaptive facades.

A clear definition that combines “adaptation” and “intelligence” is a required development. For example, “intelligence” is applied in architecture with varying intentions and meanings which leads to misunderstanding, particularly when used as a criterion for defining adaptive functions. To define intelligent adaptive facades in the context of architectural design, a joint investigation in the fields of system engineering, sustainable building design and passive design concepts, and biomimetics led to extended criteria for adaptive facades, as shown in Fig 2. These criteria shall combine adaptive functionalities, which are targeting technical features (actuators, sensors, controls), with architectural aspects, such as spatial, formal and visual features (Fig. 2).

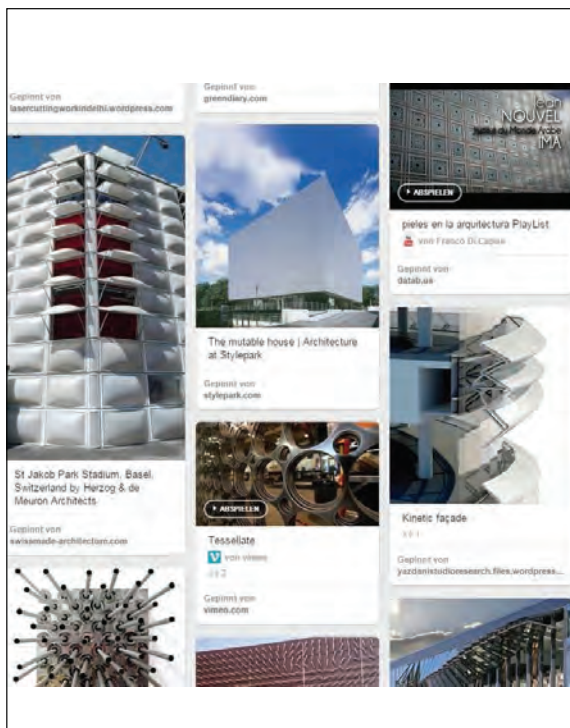

Fig. 1. Collection of adaptive facades serving as the investigation basis in the STSM, Pinterest collection by S. Gosztanyi (Status: 15.10.2015)

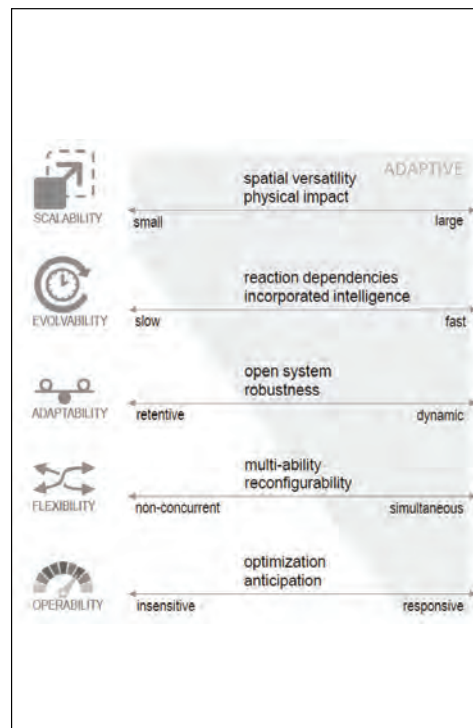

Fig. 2. Draft concept focusing on extended criteria to evaluate adaptability in facades

Numerical Modelling of a Structural Adhesive Used for Bonding Hybrid Steel-Glass Beams

DURATION	30/11/2015 - 05/12/2015
VISITOR	Filipe Firmo
HOME INSTITUTION	University of Coimbra, Department of Civil Engineering
HOME COUNTRY	Portugal
HOST	Dr. Chiara Bedon
HOST INSTITUTION	University of Trieste, Department of Engineering and Architecture
HOST COUNTRY	Italy
RELEVANT WORKGROUP(S)	WG2
INVOLVED RESEARCHERS	-

In the last few years, technological developments of the glass industry have increased the use of glass with load bearing purposes. Glass brittle behaviour and its low tensile strength is being overcome by different approaches. This STSM is within the framework of the development of adhesive connections to achieve an efficient composite behaviour between glass and the supporting elements, or to combine glass with ductile materials in order to achieve an extra level of structural redundancy. The adhesive connections are gaining popularity because of their assembling potential, since an efficient composite behaviour between glass and the supporting elements may be achieved since it ensures a uniform load transfer, unlike the bolted connections that weaken the glass near the bolt holes. Therefore, as expected, the load bearing characteristics of the facade significantly depend on the composite behaviour of the system, and subsequently, on the adhesive performance. Thus, it is of the utmost importance to be able to accurately characterize it.

The main objective of the proposed STSM addressed this topic and consisted in the characterization of the behaviour of structural adhesives of common use and the selection of the appropriate model to deal with it using Abaqus software. This STSM goal was in line with the COST Action TU1403 objectives, and specifically with the activities of its sub-group "Structural Glass".

It was intended to develop a Finite Element model in order to simulate the mechanical behaviour of the adopted polyurethane, under uniaxial tension and shear independency at the laboratories of the University of Coimbra before the short-term scientific mission. However, the numerical study was performed by taking into account 3 different models: Uniaxial tension model, Push-Out shear test model, Simple shear test model (Fig. 1-3). Test results of uniaxial tension model were then extrapolated to model the adhesive properties in a situation of tension plus shear (push-out shear test) and only shear (simple shear). Those results were then used to choose the most appropriate hyper-elastic model and to establish their corresponding parameters.

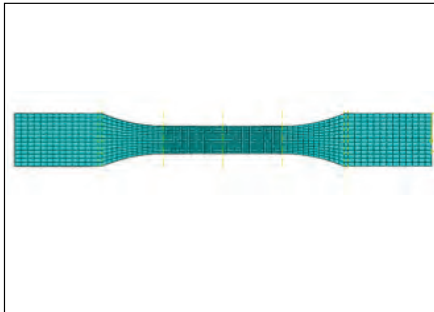

Fig. 1. Uniaxial tension model

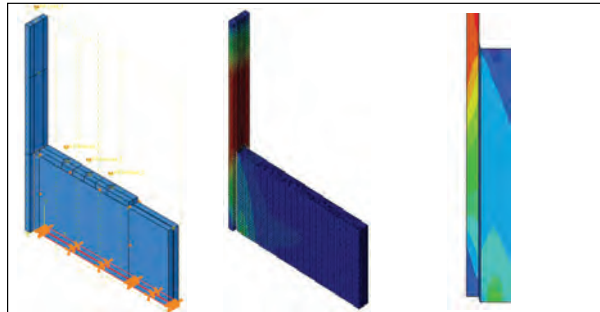

Fig. 2. Push-Out shear test model

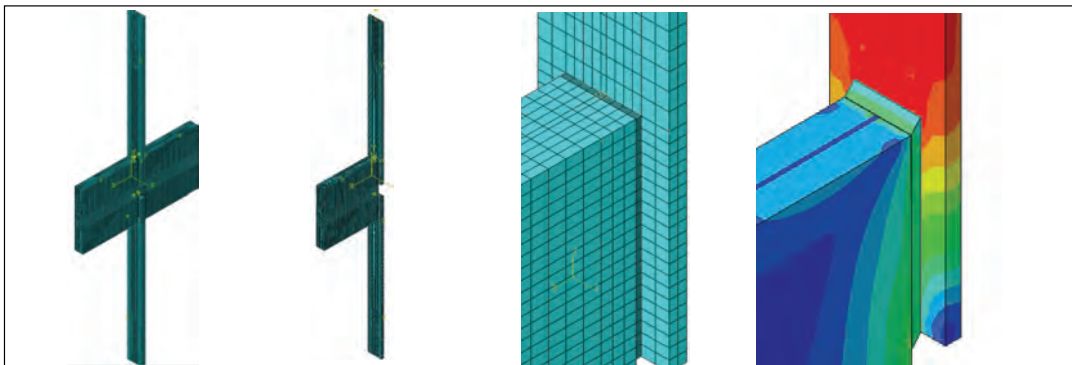

Fig. 3. Simple shear test model

Thermal Performance of Adhesively Connected Cold-Formed Steel-Glass Panels

DURATION	14/12/2015 - 18/12/2015
VISITOR	ir. Bert Van Lancker
HOME INSTITUTION	Ghent University
HOME COUNTRY	Belgium
HOST	Prof. Paulo Santos
HOST INSTITUTION	University of Coimbra, Department of Civil Engineering
HOST COUNTRY	Portugal
RELEVANT WORKGROUP(S)	WG2
INVOLVED RESEARCHERS	-

Developing adhesive connections to increase the involvement of the glass as a load-bearing material resulting in an innovative structural closed-cavity façade (SCCF) unit, complying with the strictest environmental standards and guidelines, being the main focus of the author's PhD, this STSM serves for a preliminary research on the thermal behaviour of a basic functioning structural body of SCCF (Fig. 1).

The thermal properties of the structural adhesive, i.e. Sikasil® SG-500, were determined by using Hot Disk TPS 2500 S equipment (Fig. 2). The measured thermal conductivity " λ " value was implemented in the two-dimensional finite element software THERM to evaluate the thermal performance of a SCCF reference unit (Fig. 3). Numerical investigations confirmed the hypothesis of that the glass is the major contributor to the overall thermal performance of the hybrid cold-formed steel-glass façade unit. On the other hand, changing tubular cold-formed steel sections to open C-sections, decreasing the thickness of the sections, increasing the cavity width do not result in a significant decrease of the U-value of the unit. Thus, the thermal performance of the façade unit can be more efficiently enhanced by improving the thermal performance of the glazing. Therefore, a simulation was performed in which the inner single glazing was replaced by a double glazing unit and the result was an astonishing decrease in the U-value.

Other possible configurations using these solutions are still under investigation. Furthermore, possible connections between multiple hybrid cold-formed steel-glass façade units have to be designed and assessed for their mechanical and thermal performance. However, from this research it is assumed that the effect of properly designed connections on the thermal performance of the façade will be minimal and that the contribution of the thermal transmittance of the glazing will be decisive, given the large glass area and the very reduced steel thickness and frame area. Further research will be performed to confirm these suppositions and quantify with values.

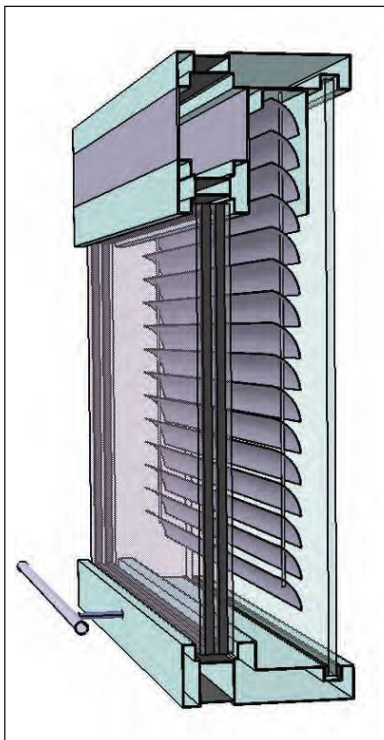

Fig. 1. Closed-cavity façade unit (© Gartner)



Fig. 2. Hot Disk TPS 2500 S (© Hot Disk AB)

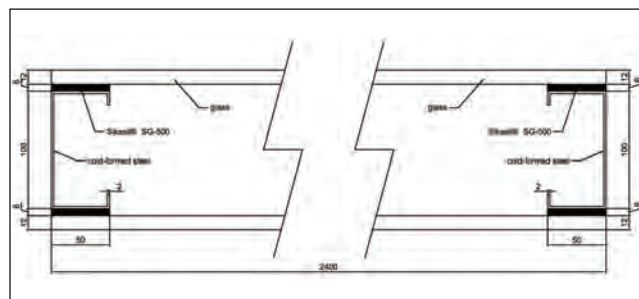

Fig. 3. Horizontal section of a reference unit

Coupled Structural & Thermal Optimization of a Multifunctional Building Skin

DURATION	11/04/2016 - 16/04/2016
VISITOR	Dr. Chiara Bedon
HOME INSTITUTION	University of Trieste, Department of Engineering and Architecture
HOME COUNTRY	Italy
HOST	Dr. Mauro Overend
HOST INSTITUTION	University of Cambridge, Faculty of Engineering
HOST COUNTRY	The UK
RELEVANT WORKGROUP(S)	WG2
INVOLVED RESEARCHERS	Mr. Fabio Favoino (UCam), Dr. Carlos Pascual (UCam)

The main objective of this STSM consisted in the analytical and Finite Element (FE) numerical analysis of a multifunctional building skin. Particular attention was dedicated, through the exploratory analyses, to the thermal and structural performance of a case study under investigation at the University of Cambridge (UCam). The reference system is a novel GFRP-glass sandwich solution where glass panels are joined to GFRP frames via adhesive layers (Figure 1).

During the STSM, a FE parametric study was performed by taking into account several configurations of technical interest, i.e. including variations in geometrical, mechanical and thermal properties (see for example Figure 2). The full investigation was focused on a single curtain-wall modular unit, with $B= 1.5\text{m} \times H= 3\text{m}$ the overall dimensions, composed of two 10 mm thick monolithic external glass layers, a middle 5 mm thick monolithic glass panel (non-structural), a GFRP frame, and a set of adhesive joints. The selected geometrical configurations were then compared with the structural and thermal performance of traditional curtain-wall panels, supported by metal tubular mullions and transoms. The assessment and optimisation approach was hence carried out by accounting for the best structural & thermal performances of minimised GFRP cross-sectional frames.

Related publications:

- Chiara Bedon, Carlos Pascual Agullo, Alessandra Luna-Navarro, Mauro Overend, Fabio Favoino (2018). Thermo-mechanical Investigation of Novel GFRP-glass Sandwich Facade Components. Challenging Glass Conference Proceedings, v.6, p. 501-512, may 2018. ISSN 2589-8019
- Chiara Bedon, Fabio Favoino, Mauro Overend (2018). Thermo-mechanical analysis of GFRP-glass sandwich facade components. Proceedings of FACADE 2018 - Final conference of COST TU1403 "Adaptive Facades Network" (in print)

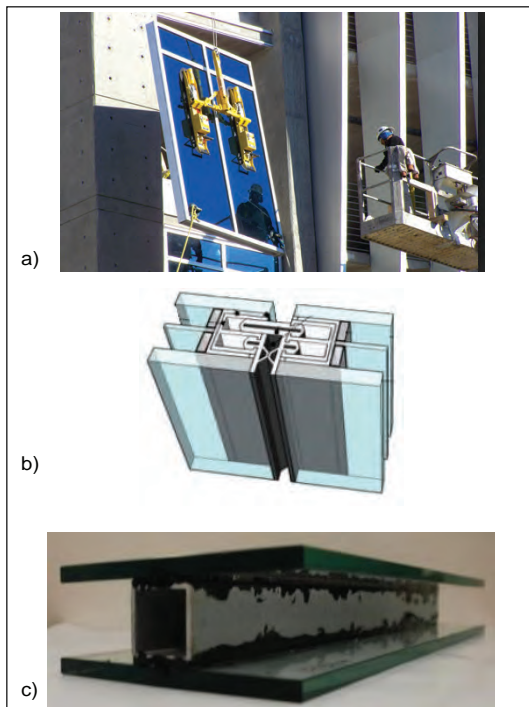

Fig. 1. a) Installation of traditional non-integrated frame utilised panels for curtain wall systems, with b) connection detail between adjacent facade modular units and c) GFRP-glass design concept

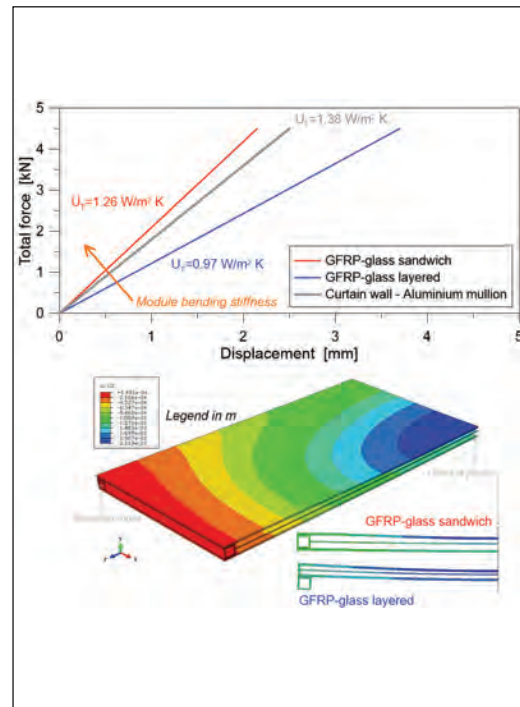

Fig. 2. Force-displacement response of the selected facade systems, including total U-values (ABAQUS)

Review of the Adaptive Facade Database, Development of the Educational Pack Draft Plan and Teaching Material WG1

DURATION	13/03/2016 - 24/03/2016
VISITOR	Sandra Persiani
HOME INSTITUTION	Sapienza University of Rome, Department of Planning, Design, and Technology of Architecture + Munich University of Technology, Department of Architecture
HOME COUNTRY	Italy + Germany
HOST	Prof. José Miguel Rico Martínez
HOST INSTITUTION	The University of the Basque Country, School of Architecture
HOST COUNTRY	Spain
RELEVANT WORKGROUP(S)	WG1
INVOLVED RESEARCHERS	-

The main objective of this STSM was to set up a draft of the teaching material for the educational pack in the context of mapping different adaptive technologies, providing an overview about their performance, collecting and analysing facades and technologies already adopted in practice towards a proper characterization, and definition finding.

The existing survey on adaptive facades developed by WG1 has been reviewed and a final draft of the survey has been structured. Key concepts, case studies of adaptive components, materials, technologies and building/architectural integration methods towards adaptability gathered through this survey has been developed into a systematic output of detailed and summarized fact-sheets for each analysed example (Fig. 1). This has been achieved by dividing the different aspects into parts ranging from general to specific features. The structure of the survey has been organised in three levels of detail: basic level, building level and detailed level, which is further structured into metrics, characterization, economical aspects, references, pictures and contact data.

In the scope of structuring the survey, questions have been developed for the main definition(s) and subsequent subcategories, and the validity of the survey has been tested by feeding the database with a few examples in each category.

The material developed during the STSM would not only be a valuable input for an introduction and description of adaptive facades in educational packs, but also can be directly used in the Industry Workshops.

The image shows a detailed fact-sheet for the 'Cyclebowl' adaptive facade system. It includes the following sections:

- Project Information:** ATELIER BRUCKNER GmbH, 2000, Hannover Expo.
- Characteristics Table:**

Keywords	Pneumatic; Sun shading; ETFE Cushion; Pattern	Subcategory	Yes	Reference case	Exhibition pavilion
Type	Facade system	Building phase	New built	Building type	Other
TR... (Technical Reference)	5 Commercial product/Existing building	Building principle of the facade system	1 component / 1 material		
- Function / goal:** Thermal comfort, Visual comfort, Energy management (heating, cooling, supply), Mass and on the outer layer of the cushions. When the middle layer overlaps with transfer control (e.g. condensation control), Appearance (aesthetic quality), Biomimetic Facades (BF).
- WOC (Classification):** External skin, Polymers.
- Actuator (type):** Mechanical.
- Control (type):** External (remote control), Manual.
- Response (type):** gradual, Centimeters.
- Medium (type):** Medium curtain walls, ventilated facades, etc.

The right side of the image contains a series of numbered questions and their corresponding answers, structured into levels of information:

- Question 1: Basic level of information:** Description of the facade system, its components, and its function.
- Question 2: Building level of information:** Information about the building, its location, and the facade's integration.
- Question 3: Detailed level of information:** In-depth technical details, materials, and performance metrics.

Fig. 1. Developed fact-sheet for adaptive facade cases

Presentation Master: Development of a Series of Lectures and Teaching Material WG1

DURATION	04/07/2016 - 08/07/2016
VISITOR	Dr. Philipp Molter
HOME INSTITUTION	Munich University of Technology, Department of Architecture
HOME COUNTRY	Germany
HOST	Prof. Dr.-Ing. Tillmann Klein
HOST INSTITUTION	Delft University of Technology, Faculty of Architecture
HOST COUNTRY	The Netherlands
RELEVANT WORKGROUP(S)	WG1
INVOLVED RESEARCHERS	-

The objective of this STSM was to make contribution to the assessment of WG1's database in order to develop a detailed layout of the lecture series at the training school as well as a design teaching concept in Hamburg Summer School. In this regard, the structure and the content of the first two lectures have been developed.

Lecture 1 is a systematical introduction to adaptive facades which highlights definitions, types, general requirements to allow young architects and students to get an overview on diverse approaches and case studies at different product levels, including adaptive components, materials, technologies and building/architectural integration methods towards adaptability. Teaching material on the history of adaptive facades has also been prepared and the evolution from 'wall' to 'facade' has been explained.

Lecture 2 elaborates the state-of-the-art of adaptive facades by providing ground for active learning where students work with the adaptive facade database. The state-of-the-art is explained through the categorization of adaptive facades and components.

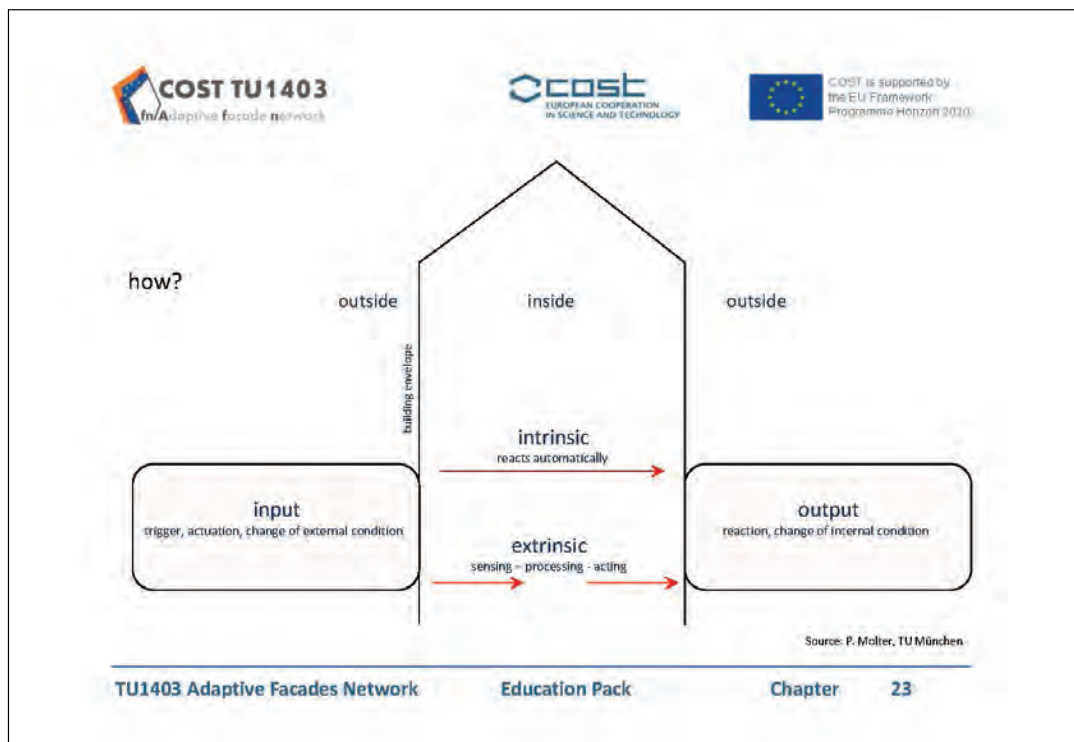

Fig. 1. An example of Education Pack Training slides showing how the adaptive facades work

Parametric and Generative Tools for Performance-Based Design

DURATION	08/07/2016 - 29/07/2016
VISITOR	Emanuela Giancola
HOME INSTITUTION	CIEMAT, Research Unit of Energy Efficiency in Buildings
HOME COUNTRY	Spain
HOST	Prof. Valentina Serra
HOST INSTITUTION	Polytechnic University of Turin, Department of Energy
HOST COUNTRY	Italy
RELEVANT WORKGROUP(S)	WG2
INVOLVED RESEARCHERS	-

The studies carried out on the performance prediction of Adaptive Façades are mostly focused on the use of Building Performance Simulation (BPS) as a tool for analysis. Recently, however, there is a growing interest in the use of parametric and generative tools for performance-based generative design and architectural form.

The main objective of the STSM was to bring together and analyze the existing information in the field of parametric and generative tools for building performance, to study the full potential of parametric design integrating the simulations over different interrelated physical domains using different coupled tools, to evaluate emerging technologies for compatibility between models and BPS tools.

During the STSM, visual comfort and energy efficiency were analysed through an integrated approach. A thermal model of a building with thermochromic window was analysed in EnergyPlus, then integrated with a parametric tool (HoneyBee/Grasshopper) by means of Python language to optimize the control of the model according to one or more objective functions. The integration of the two parametric models (daylight model in HoneyBee/Grasshopper and thermal model in EnergyPlus) into a unique simulation tool enables to evaluate the highest performance of an adaptive façade achievable.

The architecture of the developed integrated simulation tool consists of the coordination layer (the interface), designed in Python/Grasshopper, and the evaluation layer, constituted by EnergyPlus (Thermal model) and Daysim (Daylight model) (Fig. 1). The coordination layer is used to enable the communication between the different evaluation models. In particular, this tool can be very useful in filling the gap between technology-driven and performance-driven product development in the context of adaptive facades.

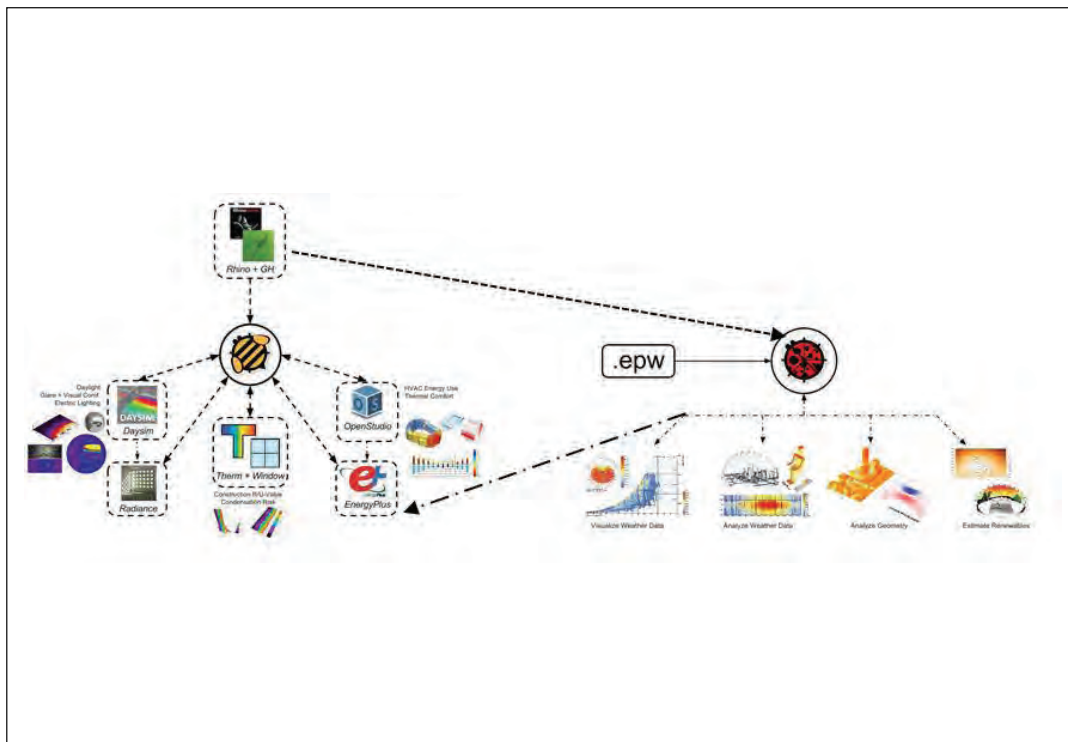

Fig. 1. Components of the integrated simulation tool designed in Grasshopper

Adaptive Facades Towards Med Area: The Analysis of an Innovative Scientific Approach

DURATION	17/07/2016 - 22/07/2016 & 01/08/2016 - 06/08/2016
VISITOR	Rosa Romano
HOME INSTITUTION	University of Florence, Department of Architecture
HOME COUNTRY	Italy
HOST	Prof. Laura Aelenei
HOST INSTITUTION	National Laboratory of Energy and Geology (LNEG), Energy Efficiency Unit
HOST COUNTRY	Portugal
RELEVANT WORKGROUP(S)	WG1
INVOLVED RESEARCHERS	-

This STSM has been focused on the state-of-the-art of dynamic facade systems and the investigation of technological, functional and qualitative aspects of these systems. Dynamic facade systems for hot and temperate climate have been analysed and mapped out which are available either on the market, or as prototypes or concepts. In particular, a new datasheet has been prepared to collect the information on adaptive facades analysed during the course of research activities of COST (Fig. 1).

Literature review has been done and case studies have been collected with the aim of building a new definition for 'adaptive façade'. This work has based on the state-of-the-art and survey analysis. As the term 'adaptive' is used interchangeably with a multitude of different terms and creates confusion to its specific meaning and its conceptual relationship to building performance and design, the work done to tackle this problem provides a provisional lexicon of descriptive, behavioural and methodological terms to assist researchers and designers in navigating the field of high-performance skins that incorporate materially innovative and feedback-based systems.

With the goal of dissemination of expertise to Early Stage Researchers a first review of teaching material has been prepared for the annual training school. The prepared material provides a systematic characterization of the adaptive facade for future trends of design and development of novel adaptive technologies.

The host institution has also provided the opportunity to analyse the innovative technologies which have already been integrated to the institution buildings. In the end, not only new knowledge has been developed, but also the written reports on this STSM would be used for starting a new publication.

Fig. 1. Datasheet developed to collect the information on adaptive facades analysed during the course of STSM

Validation of a Developed Thermal Model and Guideline Development for Experimental Determination of the Solar Factor of Transparent Façade Components

DURATION	01/09/2016 - 24/09/2016
VISITOR	Giulio Cattarin
HOME INSTITUTION	Politecnico di Milano, Energy Department
HOME COUNTRY	Italy
HOST	Prof. Francesco Goia
HOST INSTITUTION	Norwegian University of Science and Technology, Faculty of Architecture and Design
HOST COUNTRY	Norway
RELEVANT WORKGROUP(S)	WG2
INVOLVED RESEARCHERS	Christian Schlemminger, Steinar Grynning

The first main objective of the STSM was to validate the lumped-parameter thermal model developed in Matlab by means of an experimental campaign. For this purpose, after setting up the necessary instrumentation, one of the ZEB Test Cells has been run in free-floating mode for five days while exposed to external weather conditions (Fig. 1, 2). A thermal model has been created which describes the test cell and simulations have been ran using the measured boundary conditions. The thermal model was able to predict the profile of internal temperatures. Also, it was investigated which parameters and inputs are most influential on the thermal behaviour of the test cell by means of a local sensitivity analysis to measure the highest ranking variables with high accuracy when performing the heat balance of the test cell.

The second main objective was to develop guidelines for the experimental determination of the solar factor of transparent façade components under real weather conditions. By this, it has been aimed to offer a practical support to research centres that are either planning to design a new outdoor test cell facility or working to improve the accuracy of calorimetric tests carried out in existing facilities.

According to obtained results, the thermal model is able to predict the evolution of the internal air temperature and the envelope's surface temperature with good accuracy. The validation work has been summarised in a 34-page report. The guidelines, on the other hand, suggest amendments to the American standard proposed by the National Fenestration Rating Council for the measurement of the solar factor in indoor and outdoor solar calorimeters. On a longer term, the guidelines might constitute the base of discussion for the development of a European standard for outdoor test cell calorimetry.



Fig. 1. The ZEB Test Cells Laboratory external view

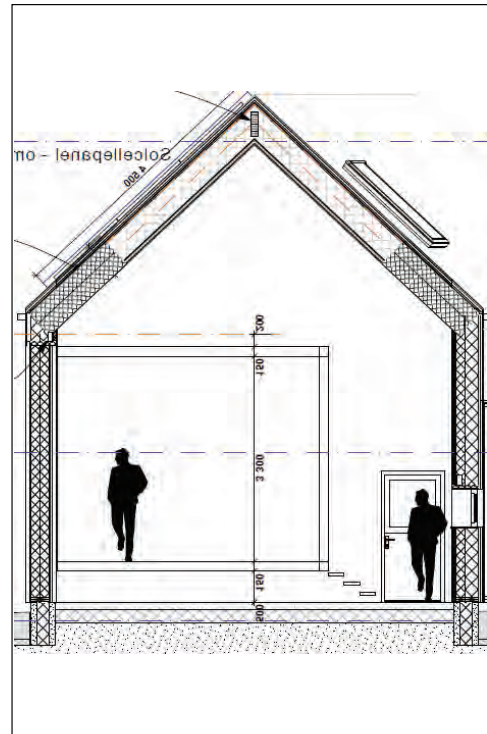

Fig. 2. Section drawing of the ZEB Test Cells

The Experimental Assessment of Adaptive Facades Under Real Outdoor Conditions: The Case Study of ADAPTIWALL (7th FP)

DURATION	14/11/2016 - 16/12/2016
VISITOR	Pascal Vullo
HOME INSTITUTION	EURAC Research, The Institute for Renewable Energies
HOME COUNTRY	Italy
HOST	Philippe Thony
HOST INSTITUTION	CEA, The French Alternative and Atomic Energy Commission
HOST COUNTRY	France
RELEVANT WORKGROUP(S)	WG2
INVOLVED RESEARCHERS	-

With the aim of developing test procedure and performance indicators for adaptive façade systems, the testing facilities of the host institution, namely, PASSYS, INCAS and FACT, were analysed and their characteristics were reported. The outcomes were then integrated as data sets into the manual and the freemind mindmap, and the deliverable was enriched with an extra data set of the ADAPTIWALL test procedure.

The concept of ADAPTIWALL is based on the consideration that retrofitting attempts by increasing envelope thickness bring negative consequences like too high airtightness, over-heating, poor ventilation and loss of space due to voluminous retrofit units. ADAPTIWALL solves this problem by using nanotechnology to develop a multifunctional and climate adaptive panel for energy-efficient buildings which consists of lightweight concrete, adaptable polymer materials for switchable thermal resistance and a total heat exchanger with nanostructured membrane for temperature, moisture and anti-bacterial control.

Using ADAPTIWALL as a case study, four performance indicators were defined, calculated and visualized in form of graphs: Daily energy to the room, latent heat thermal energy storage efficiency, usable heat efficiency, and total heat efficiency. The analysis was based on the experimental testing of four small-scale prototypes with an additional cladding made of 4 mm clear float glass leaving a 15 mm cavity which was conducted at Algete Demo Park of ACCIONA Infraestructuras in Spain (Figure 1).

According to the experimental results, the calculated indicators are not able to show an improvement of the performance of the system due to the use of phase change material. Also, the losses of the storage to a ventilated cavity and consecutively to the outside are negligible. However, further investigations are needed to verify the experimental data and to further adapt the indicators to ADAPTIWALL.

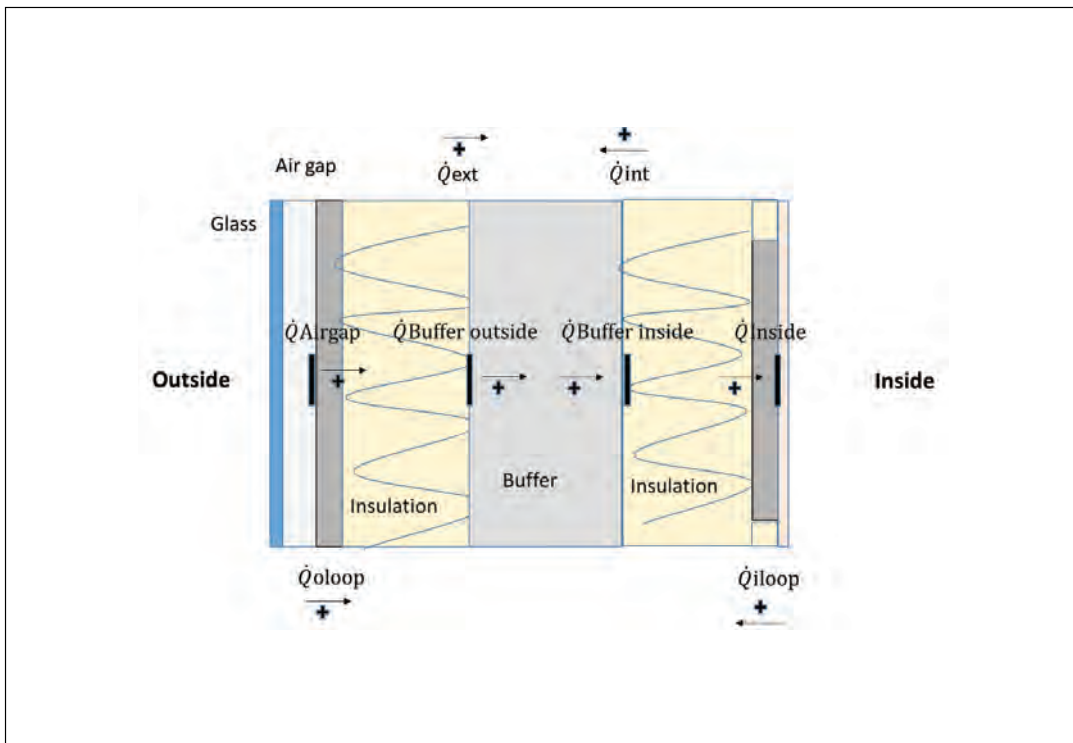

Fig. 1. Scheme of the ADAPTIWALL's, heat flows and the positioning of all heat fluxmeters

Simulation and Experimental Analysis of Adaptive Component Making Use of PCM

DURATION	20/04/2017 - 18/07/2017
VISITOR	Stefano Fantucci
HOME INSTITUTION	Polytechnic University of Turin, Department of Energy
HOME COUNTRY	Italy
HOST	Prof. Francesco Goia
HOST INSTITUTION	Norwegian University of Science and Technology, Faculty of Architecture and Design
HOST COUNTRY	Norway
RELEVANT WORKGROUP(S)	WG2
INVOLVED RESEARCHERS	Gaurav Chaudhary

The purpose of the STSM activities is to reduce the mismatch between actual and predicted thermal behaviour of PCM components. Therefore, it is aimed to develop an experimental procedure, specifically oriented to the validation of Building Performance Simulations (BPS) codes that implements algorithms for the simulation of PCMs, the developed procedure was aimed at characterising and analysing the bulk-PCM thermal behaviour by means of Dynamic Heat Flow Meter Apparatus (DHFM). Another goal of this research is to provide experimental datasets for empirical validation of BPS tools.

Experiments were carried out on two commercially available PCM substances (PCM-a) and (PCM-b) which are characterised by different hysteresis behaviour and which represent the most adopted bulk PCMs used for building envelope components. PCM-a is an organic paraffin based PCM and PCM-b is an inorganic salt hydrates based PCM. The measurements were done on a polycarbonate alveolar container filled with bulk PCM. The experimental results were used to test the accuracy of two commercial BPS software (WUFI pro and EnergyPlus). Moreover, a new developed algorithm for the simulation of hysteresis phenomena of PCM by using the EMS of EnergyPlus was verified against experimental data.

The comparison between simulations and experimental data demonstrates the reliability of the proposed approach. The developed approach to simulate hysteresis phenomena in adaptive building component implementing PCM is also suitable to take into consideration sub-cooling effect since both the phenomena can be addressed if different enthalpy vs. temperature curves are used by the simulation tool. Moreover, the developed experimental procedure can be even used to perform specific experiments aimed to investigate the sub-cooling phenomena and validate numerical codes. The above mentioned can be an input for further research collaborations in the field of simulations and in the improvement of experimental procedure for PCM adaptive envelope components, which are presently under discussion.

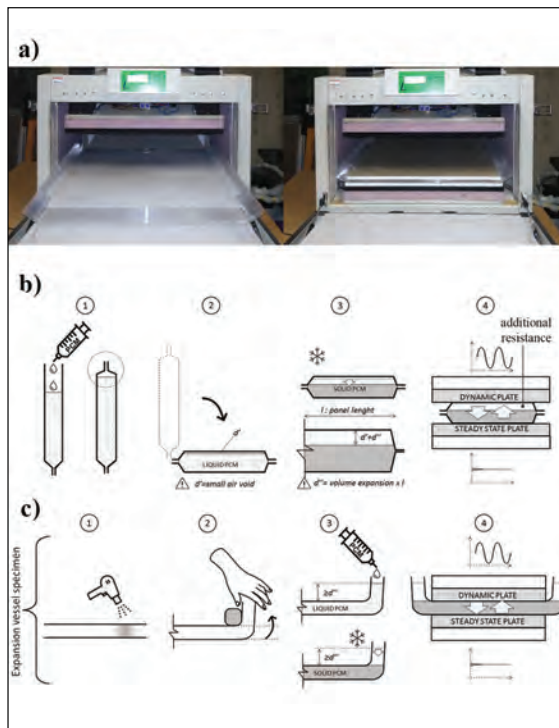

Fig. 1. a) The DHFM apparatus; b) The existing procedure; c) The developed procedure.

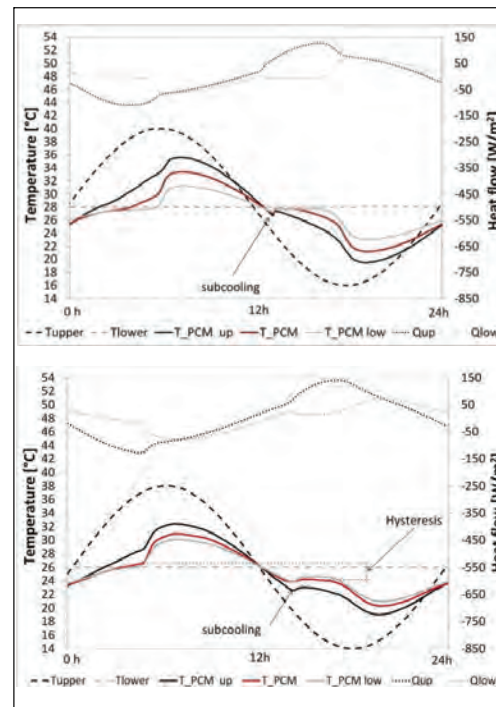

Fig. 2. experimental DHFM results: a) Test-1 (PCM-a): sinusoidal solicitation amplitude of 12°C; b) Test-1 (PCM-b): sinusoidal solicitation amplitude of 12°C

Contribution Towards Development of Current State-of-the-Art Adaptive Façade Materials and Systems

DURATION	28/05/2017 - 10/06/2017
VISITOR	Claudio Aresta
HOME INSTITUTION	Technical University of Munich, Department of Architecture
HOME COUNTRY	Germany
HOST	Prof. Daniel Aelenei
HOST INSTITUTION	Universidade Nova de Lisboa, Department of Civil Engineering
HOST COUNTRY	Portugal
RELEVANT WORKGROUP(S)	WG1
INVOLVED RESEARCHERS	Prof. Laura Aelenei

The aim of COST Action 1403 is, amongst others, to map out existing and future technologies and provide a quantitative overview of the performance of each of them. WG1 has developed a survey to collect examples of adaptive façade technologies on materials and component. During this STSM, different aspects of cataloguing adaptive components have been discussed and the number of analyzed case studies have been increased.

Additionally, two draft papers for the NEXT Façade Conference were prepared with other WG1 members. The first reports the results of the research project "adaptive/auto-reactive". It introduces the passive adaptation as a form of decentralized adaptation, which do not involve any kind of external energy. What makes this art of adaptivity unique is the material itself. The second paper deals with the terminology of adaptivity in the recent literature. Various authors have applied terms to describe many slightly different concepts - or aspects of adaptivity.

Kalziumchloridhexahydrat (Salzhydrat)

Bezeichnung
Phasenveränderbares Material

Salzhydraten werden für ihren Wärmespeicherungsfähigkeiten in unterschiedlichen Bereiche angewendet. Während der Phasenumwandlung nimmt das Material viele thermische Energie auf, ohne sich dabei merklich selbst zu erwärmen.

kennzeichnende Eigenschaften

- Schmelztemperatur bei 30°C
- hohe Wärmeleitfähigkeit
- sehr gutes Wärmespeichervermögen

actuator code **#10**

chemische Formel CaCl2.6H2O

Input



Output



Reaktionsauslöser	Temperatur
Aggregatzustand	fest-flüssig
TTL	5
TTL_Fassadenbau	5

Umwandlungstemperaturen	0°C 130°C
Hysteresis	-
Reaktionszeit	mittelmäßig
Reaktionsverhalten	linear
Kraft	-
Formänderungsarten	volumetrische Ausdehnung

Stabilität	sehr hoch
Recycling	sehr gute
Kosten	niedrig
Verfügbar als	flüssig oder fest

Anwendungen
Latentwärmespeicher, Verglasungselemente

notes
große Volumenänderung beim Phasenübergang

Installation des Materials durch Temperatursteigerung
<http://www.bauitinka.de/>



adaptiv / autoreaktiv 51

Fig. 1. Sample of datasheet of passive systems ("Adaptiv/Autoreaktiv" research project)

New Concepts for the Mechanical and Statistical Strength Evaluation of Heat-Treated Glass in Adaptive Facades

DURATION	01/07/2017 - 29/08/2017
VISITOR	Gabriele Pisano
HOME INSTITUTION	University of Parma, Department of Engineering and Architecture
HOME COUNTRY	Italy
HOST	Prof. Dr.-Ing. Jens Schneider
HOST INSTITUTION	Technical University of Darmstadt, Institute of Structural Mechanics and Design
HOST COUNTRY	Germany
RELEVANT WORKGROUP(S)	WG2
INVOLVED RESEARCHERS	-

The demand for thinner glass components with higher mechanical strength has been growing more and more, but the statistical analysis of the bending test data for heat-treated glass lacks an in-depth mechanical and statistical analysis of the interference between the pristine material strength and the permanent residual compressive stress due to the heat treatment. The main goal of this STSM is to experimentally validate and optimize a new model for the mechanical and statistical strength evaluation of heat-treated glass based on a micro-mechanically-motivated statistical method. To achieve this goal, data obtained from experiments at the host institution were statistically analyzed, and the statistical model able to interpret the variability of residual stresses was investigated. Optical measurements were made for the annealed and fully-tempered glass plates which were supplied for mechanical strength testing. Then the ability of the statistical model to interpret the fully-tempered glass variability was investigated.

The resulting partial factors for pre-stress are lower than the ones generally suggested by international standards and guidelines. This demonstrates that the standard practice may lead to redundant design in most cases. The results of the experimental campaign have shown that the benefic contribution to heat-treated glass strength given by the crack healing is not negligible, albeit for what concerns fully-tempered glass. The development of a refined mechanical model able to interpret the effects of the crack healing on the micro-crack lengths distribution would allow to safely take into account this adding contribution, so as to optimize the design of components made of heat-treated glass. Furthermore, glass strength is governed by the opening of surface cracks, which are only active in the fracture mechanical mode I. Thus, a number of cracks will remain always inactive when the stress state is uniaxial, contrarily to in the case of equibiaxial state of stress, approximately reached by performing a coaxial double ring test. Hence, further experiments could be performed on glass specimens under 4-point-bending configuration, so as to check the influence of stress state upon the heat-treated glass strength distribution in comparison to the performed equibiaxial tests.

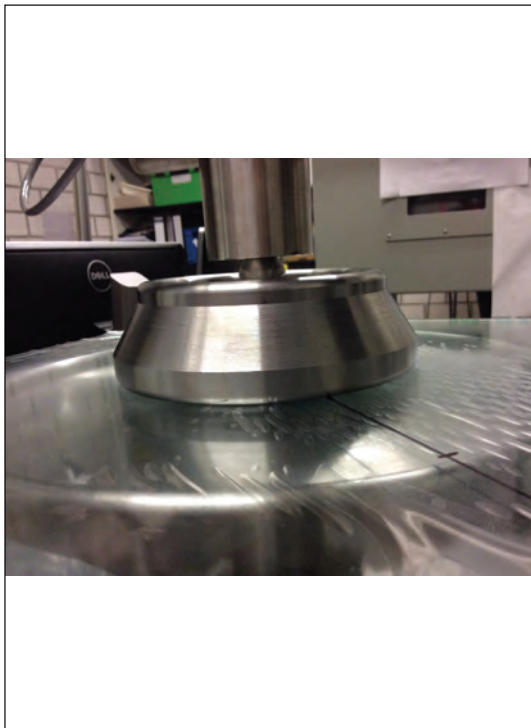

Fig. 1. Experiment conducted to validate and optimize a new model for mechanical and statistical strength evaluation - before the test

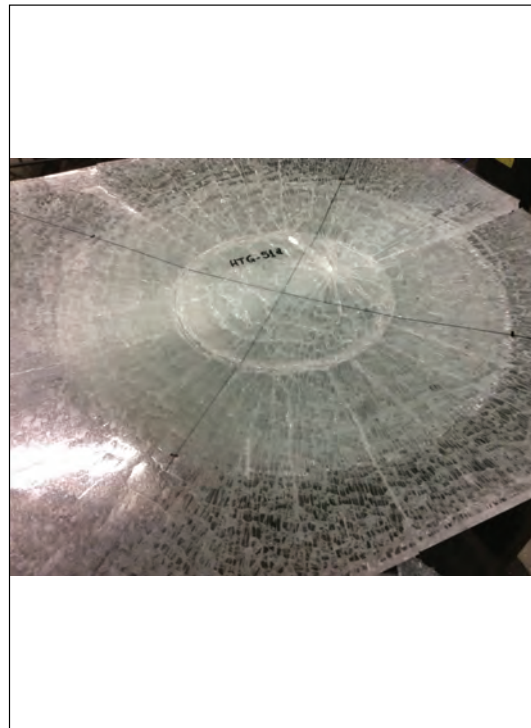

Fig. 2. Experiment conducted to validate and optimize a new model for mechanical and statistical strength evaluation - after the test

Eco-Designed Approach – Designing Adaptive Facades with A Unified and Systematic Characterization

DURATION	11/07/2017 - 26/07/2017
VISITOR	Nitisha Vedula
HOME INSTITUTION	Ostwestfalen-Lippe University of Applied Sciences
HOME COUNTRY	Germany
HOST	Prof. Laura Aelenei
HOST INSTITUTION	National Laboratory of Energy and Geology (LNEG), Energy Efficiency Unit
HOST COUNTRY	Portugal
RELEVANT WORKGROUP(S)	WG1
INVOLVED RESEARCHERS	-

This STSM deals with understanding the sustainability targets for the performance of the adaptive building skin. 45 adaptive façade projects of the database (Fig. 1) from Cost Action TU 1403 are analysed in relation to external factors and user comfort inside the building. To understand the future sustainable targets, Eco-designed approach is studied. A new holistic approach is developed with the understanding of the future sustainable targets of adaptive systems and analyzing its sustainably efficient elements with the help of already existing and scattered classification schemes. This approach attempts to develop a novel matrix (Fig. 2) for re-analyzing the Adaptive Façade Projects with an Eco-designed approach. The aim of this approach is to examine whether the Adaptive Façade projects are able to seamlessly integrate with their natural environment. Therefore, in this approach the functions of the adaptive façade projects are analysed as an eco-system; characterized in a matrix as the Biotic components of Eco-system (Producer, Consumer & Decomposer) and Abiotic components of Eco-system (Air, Soil, Water, Temperature, Pressure, inorganic substances, etc.) which work in support of the natural sources of energy in the form of Conduction, Indirect-solar, Direct-solar and Ventilation. Adaptive facade projects are evaluated under the matrix developed with this new holistic approach.

A second objective of the STSM is to contribute to the content of Educational Pack. This is achieved by using the developed matrix which enhances eco-designed approach for designing adaptive facades with a unified and systematic characterization, using the evaluation results and additional Adaptive Façade Projects compiled for the Educational Pack, such as, "Living Architecture" project coordinated by Newcastle University and "eco-friendly bricks with sand and bacteria" developed by the start-up company BioMason.

In future work it will be possible to analyse the other case studies under the derived matrix with an eco-designed approach and also, the database of Adaptive Façade Projects can be updated targeting the building materials or Façade design and construction systems which could be related with the theory of eco-designed approach.



Fig. 1. Selected projects from the database where sought for achieving the final outcome for future sustainable targets

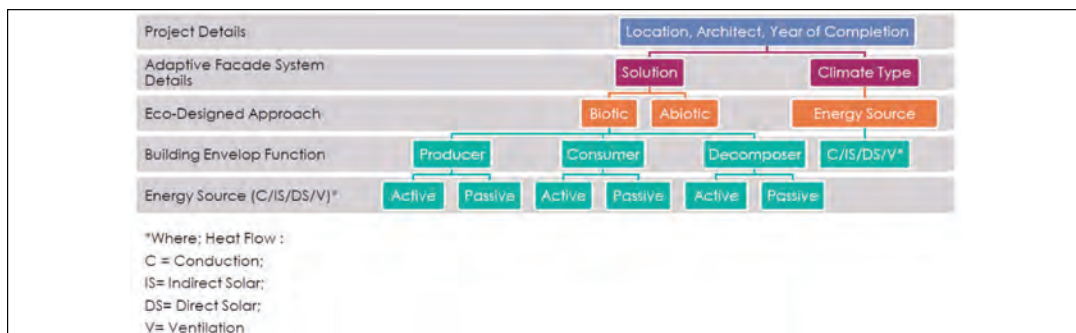

Fig. 2. Matrix developed for ECO-DESIGNED APPROACH – Designing Adaptive Facades with a unified and systematic characterization

An Advanced Integrated Simulation Procedure to Evaluate the Overall Performance and Control Strategy of an Active Adaptive Transparent Façade Component

DURATION	17/07/2017 - 14/10/2017
VISITOR	Luigi Giovannini
HOME INSTITUTION	Polytechnic University of Turin, Department of Energy
HOME COUNTRY	Italy
HOST	Dr. Mauro Overend
HOST INSTITUTION	University of Cambridge, Faculty of Engineering
HOST COUNTRY	The UK
RELEVANT WORKGROUP(S)	WG3
INVOLVED RESEARCHERS	-

Due to limitations in simulation tools when assessing the performance of façade components, it is proposed a novel simulation tool, which manages thermal and lighting simulations, with a particular focus on user interface.

A review was carried out to select the most suitable technologies to be analysed and the most common performance objectives are highlighted along with the ways how they are reached. A novel methodology to evaluate glare throughout a space by means of the vertical illuminance measured in a single point was devised in order to reduce the computational time and at the same time being able to comprehensively assess the glare condition. Different control strategies, reviewed in the literature, were tested in order to select the one which allowed the highest visual performance. A simulation framework was developed which allows to run the tasks of the different simulation softwares, building performance metrics to be calculated in each phase of the simulation process, and to define the workflow of the analysis to achieve accurate building performance results. Eventually, the simulation tool (Fig. 1) was implemented, partly in a flexible parametric environment (through Rhinoceros parametric plugin Grasshopper) and partly by means of a series of Python scripts. The proposed simulation methodology was used to test the validity of the control strategy conceived for the different active transparent adaptive technologies selected. An enclosed office located in Turin, South-oriented and with a Window-to-Wall Ratio (WWR) of 50% was chosen as a case study. Case study analysis results are given in Figure 2.

From the results obtained it is possible to say that the methodology, for the enclosed office case study considered, is reliable for evaluating the glare conditions of a whole space by means of the vertical illuminance measured at eye level in only one point of the room. Apart from the fact that it is finally possible to assess glare in a spatial way, the methodology proposed has also the great advantage of reducing exponentially the computational time required, being necessary the annual glare evaluation only for one point.



Fig. 1. The simulation tool created in Grasshopper with the indication of the different sections composing it and the software used in each of them

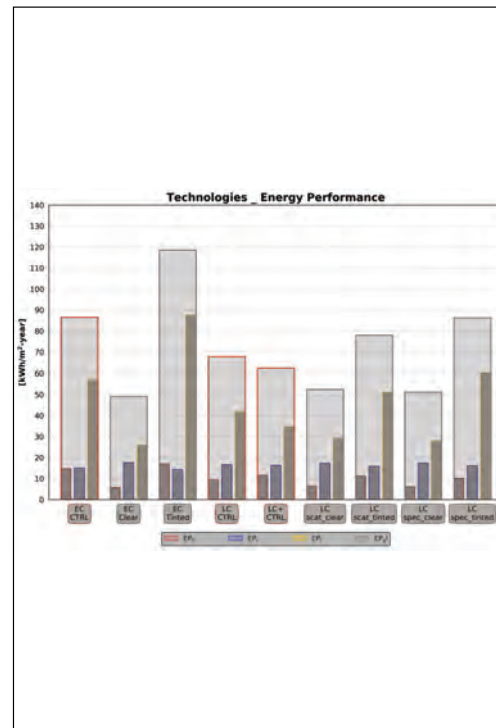

Fig. 2. Chart summarising the final annual energy performance results relative to the case studies considered in this analysis

Holistic Investigation and IEQ Assessment of Building Integrated Hybrid Façade Element

DURATION	06/09/2017 - 20/09/2017
VISITOR	Prof. Aleksandar Andjelkovic
HOME INSTITUTION	University of Novi Sad, Faculty of Technical Sciences
HOME COUNTRY	Serbia
HOST	Prof. Vlatka Rajcic
HOST INSTITUTION	University of Zagreb, Faculty of Civil Engineering
HOST COUNTRY	Croatia
RELEVANT WORKGROUP(S)	WG2
INVOLVED RESEARCHERS	-

Main idea of this STSM was to combine and integrate two ongoing projects. A building integrated hybrid façade element is being developed in the project entitled VETROLIGNUM. In order to achieve the goal of upgrading the energy efficiency properties of structural glass – timber element, full size mock-up building is constructed for several years of examination of energy efficiency of selected hybrid façade elements. Modelling and parametric analysis are done in Design Builder software (Fig. 1). For parametric simulation four panel types are used (from A to D, Fig. 2).

On the other side, with this STSM an intelligent and affordable IEQ (Indoor Environmental Quality) data logging system (SENSO) is developed within the ASHRAE international project with the aim of improving quality of performed measurement. The SENSO consists of inexpensive measuring units for all of the necessary IEQ parameters and is a cloud based software that aggregates and visualizes environmental data in user friendly browser environment for all gadget platforms. Conclusion was that this device can be an added value for VETROLIGNUM project in sense of additional IEQ measurements. Also, the VETROLIGNUM project will enable to test the device properties and behaviour in real environment.

Additionally, during this STSM, experiences in building performance simulations are shared young researchers at University of Zagreb who are involved in project VETROLIGNUM through series of lectures and practical exercises, and a presentation was prepared for educational pack.

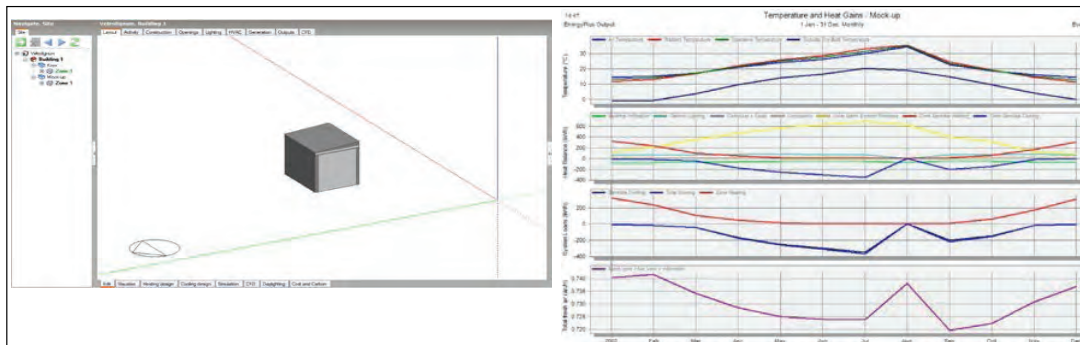

Fig. 1. Design Builder Mock-up model and panel D simulation results

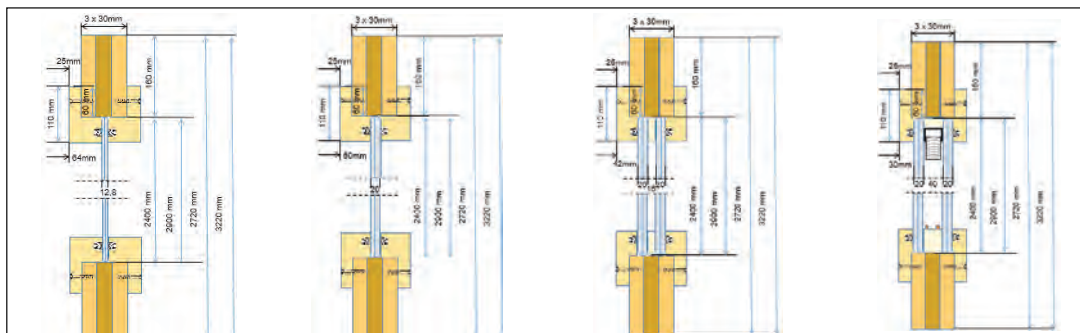

Fig. 2. Panel types (from A to D)

The State-of-the-Art of Adaptive and Multifunctional Materials

DURATION	11/09/2017 - 11/12/2017
VISITOR	Miren Juaristi Gutiérrez
HOME INSTITUTION	University of Navarra
HOME COUNTRY	Spain
HOST	Prof. Dr.-Ing. Ulrich Knaack
HOST INSTITUTION	Delft University of Technology, Faculty of Architecture
HOST COUNTRY	The Netherlands
RELEVANT WORKGROUP(S)	WG1
INVOLVED RESEARCHERS	-

This STSM was framed into the on-going PhD project “Adaptive Opaque Facades: A Design and Assessment Method” and aimed at filling the gap in the state-of-the-art of adaptive and/or multifunctional materials information. It is necessary to provide shipshape information about adaptive/multifunctional materials from a Building Science approach to enable their new applications and to scope future researches. Potential performance in façades needs to be highlighted, and threats and weakness in the building environment to be detected. An approach to the availability in the current market was done, so that the technical feasibility was sighted.

Detected smart materials (SM) and multifunctional materials (MM) were added to the database. Fig. 1 shows the information that was uploaded to the database for each material (when found). In order to analyze future applications of SM/MM in adaptive façade, their possible role in façade components was scoped (Fig.2). Besides, the dynamic operation of the material was evaluated, so mechanism, reaction, adaptation range, scale of adaptability, adaptation speed, control and operational scenario was studied. Possible geometries, thickness, width, length, assembly method and manufacturing process were analyzed. Physical properties were also analyzed, when sufficient data could be found. Future researches on the topic should consider to search the physical information of these materials using as an example a static material that could be part of a similar façade element, to understand properly the physical properties that play a role in the fulfillment of technical requirements.

Fig. 1. Provided general information in the WG1. Database of Adaptive Facade VS needed information to understand Smart Materials (SM) and Multifunctional Materials (MM)

Possible Adaptive Facade Component	Role	Autoreactive facade element	Smart Material
Smart window	Self Shading	A. film B. special chemical composition/ nanotechnology	Electrochromics
		A. film B. ink/pigments C. Dyes	Thermochromic
		A. film B. special chemical composition/ nanotechnology	Photochromic
		A. film	Thermotropic
	Heating effect	A. film	Thermoelectrical

Fig. 2. Possible application of SM/ MM in an adaptive facade element and its role – an example

Mapping Out Existing and Future Technologies – Harmonizing, Sharing and Disseminating

DURATION	12/09/2017 - 23/09/2017
VISITOR	Dr. Marcin Brzezicki
HOME INSTITUTION	Wroclaw University of Technology, Faculty of Architecture
HOME COUNTRY	Poland
HOST	Prof. Laura Aelenei
HOST INSTITUTION	National Laboratory of Energy and Geology (LNEG), Energy Efficiency Unit
HOST COUNTRY	Portugal
RELEVANT WORKGROUP(S)	WG1
INVOLVED RESEARCHERS	-

Throughout the span of the action WG1 gathered a lot of valuable information including database entries and state of the art on the subject of adaptive systems. This information is available in various databases and formats, the entries were made by different bodies and from different perspectives. The abovementioned information needs verification, master processing, harmonization and generalization. It should be reviewed, double checked and presented in the graphic format in the statistical form as well as in the form of the Case-Study Sheets.

The primary objective of the mission was to contribute to the WG1's database of case studies, and to elaborate on case studies, map them and consolidate the database. Those excel databases were build and filled with the entries (over 10 additional adaptive buildings including publishable photographs – with the copyrights to publish). The database was prepared, edited and uploaded to batchgeo.com mechanism to prepare professionally working location map (Fig. 1) of case-studies (encoded with location) or technologies (encoded with inventor's location) with possible grouping options: type; year; climate.

The change of the character of the Mid-Conference and the scope of the planned publication (abstracts instead of papers) affected planned WG1's contribution. The Grantee contributed abstract titled "Desired morphology in energy capture and storage advanced facades" co-authored with M. Alston, L. Aelenei, S. Mazzucchelli, U Pottgiesser.

The secondary objective of STSM was the contribution to the Edu-Pack. The lecture titled "Kinetic architecture and its relations with adaptiveness of the façade" was prepared with approx. 45 slides (Fig. 2). The main topic of the lecture is to show the possibilities of kinetic structures in architecture, the typologies of motion of rigid and flexible façade elements.



Fig. 1. CASE STUDY MAP produced during STSM by Grantee, COST TU 1403, WG 1

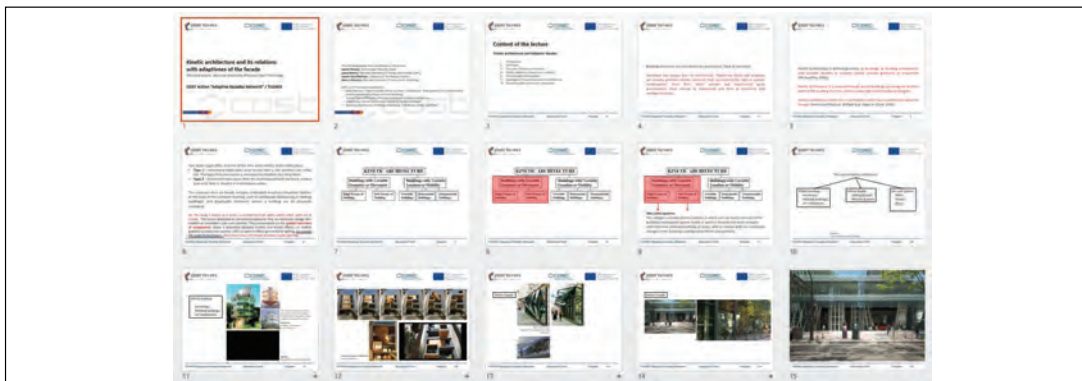

Fig. 2. Kinetic architecture and its relations with adaptiveness of the façade, lecture for EduPack by Grantee, COST TU 1403, WG 1

Improving Experimental Methods for Performance Evaluation of Double Skin Facades

DURATION	17/09/2017 - 24/09/2017
VISITOR	Matthias Friedrich
HOME INSTITUTION	HafenCity Universität Hamburg
HOME COUNTRY	Germany
HOST	Assoc. Prof. Olena K. Larsen
HOST INSTITUTION	Aalborg University, Department of Civil Engineering
HOST COUNTRY	Denmark
RELEVANT WORKGROUP(S)	WG3
INVOLVED RESEARCHERS	-

According to the energy efficiency requirements for buildings, naturally ventilated double facades can provide a considerable reduction of energy needed for building operation. However, poorly planned double facades may lead to significant increase of energy use as user discomfort.

The proposed STSM is focused on experimental procedures to determine the air exchange rate in double skin facades and in the related rooms. These will be based on the research emphasizes of the host and the visitor, different methods for tracer gas measurements as well as direct determination of a velocity profile by using hot sphere anemometers.

Firstly, a comprehensive study about the state of the art in air flow measurements focused on applications in double skin facades is done. The different tracer gas methods applied at HCU and AAU were discussed. 'The Cube', an outdoor test facility located at the main campus of Aalborg University, was visited.

Building on that, a measurement plan for the comparison of experimental methods of measurements of the airflow in naturally ventilated double skin facades was developed. In front of the Civil Engineering department laboratory a second skin of glass towards the outside shall be installed. This double skin façade is exposed to unobstructed wind conditions and facing south. This new facility shall be used to investigate and compare different methods for measuring the naturally induced air mass flow.

Ultimately, a guideline to improved measurement accuracy of naturally incused airflow in double-skin façades is crucial to be developed.



Fig. 1. Double Skin Façade built in Aalborg (© Aalborg University)

Coupled Thermo-Mechanical Model for Structural Glass

DURATION	13/02/2018 - 28/02/2018
VISITOR	Dr. Marcin Kozłowski
HOME INSTITUTION	Silesian University of Technology
HOME COUNTRY	Poland
HOST	Dr. Chiara Bedon
HOST INSTITUTION	University of Trieste, Department of Engineering and Architecture
HOST COUNTRY	Italy
RELEVANT WORKGROUP(S)	WG2
INVOLVED RESEARCHERS	-

There is a strong need for unified design rules, numerical simulation methods, new in-situ performance test requirements, experimental facilities and future product standards for adaptive building envelopes. It is especially critical to have the knowledge about behaviour of glass at elevated temperatures and fire conditions, not only at material level, but also at component and entire system levels.

The aim of the STSM was to collect and extend the existing knowledge about behaviour of monolithic and laminated glass at elevated temperatures and fire conditions. These included literature study on the properties of glass and interlayers at elevated temperatures. Moreover, the STSM was focused on simulation tools regarding modelling of glass at elevated temperatures and fire scenarios, in particular thermo-mechanical model for glass based on the results of experiments carried out at RISE Research Institutes of Sweden (monolithic and laminated glass panes exposed to radiant heating).

The STSM resulted in conference/journal contributions:

- Chiara Bedon; Daniel Honfi; Marcin Kozłowski, Numerical Modelling of Structural Glass Elements under Thermal Exposure Proceedings of The 3rd International Electronic Conference on Materials Sciences, 1 (doi: 10.3390/ecms2018-05241)
- Kozłowski, M.; Bedon, C.; Honfi, D. Numerical Analysis and 1D/2D Sensitivity Study for Monolithic and Laminated Structural Glass Elements under Thermal Exposure. Materials 2018, 11, 1447.
- Chiara Bedon; Marcin Kozłowski; Dániel Honfi, Thermal assessment of glass facade panels under radiant heating - Experimental and numerical studies (submitted to FACADE 2018 Final conference of COST TU1403 "Adaptive Facades Network" Lucerne, November 26/27 2018)

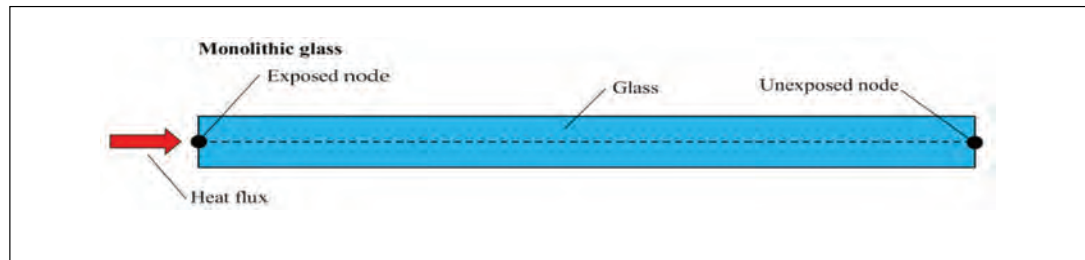

Fig. 1. Schematic representation of reference 1D heat transfer model

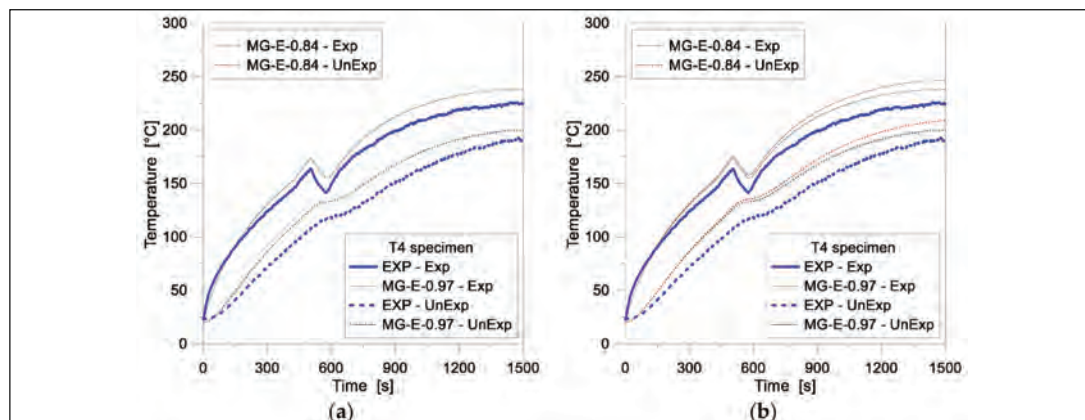

Fig. 2. Temperature history comparisons for monolithic glass specimen T4 (15 mm), as obtained from FE parametric analyses and past experimental test. FE results from (a) reference 1D model and (b) sensitivity study.

An Integrated Vertical Greenery Systems (VGS) Assessment for the Development of a Classification Methodology

DURATION	20/03/2018 - 15/04/2018
VISITOR	Theoni Karlessi
HOME INSTITUTION	National and Kapodistrian University of Athens, Department of Environmental Physics and Meteorology
HOME COUNTRY	Greece
HOST	Prof. Gianluca Ranzi
HOST INSTITUTION	University of Sydney, School of Civil Engineering
HOST COUNTRY	Australia
RELEVANT WORKGROUP(S)	WG1, WG2, WG4
INVOLVED RESEARCHERS	-

Due to increasing interest in vertical greenery systems (VGS) and their multiple benefits at different scales, the present work aims to provide an analysis of vertical greenery systems through a holistic approach. VGS systems for buildings can be classified in two main categories (Fig. 1) where a distinction is made based on whether the plants are ground based or wall based (Fig. 2). The investigated aspects are the engineering systems and techniques, the appropriate plant selection, climate factors and the VGS performance at building and microclimatic level.

Summarized results of different cases studies and existing experience are provided to set the basis of the investigation. Energy and environmental benefits are quantified to produce a solid synopsis in order to provide the main points of consideration for the most efficient solutions. The quantification refers to the external wall temperature reduction, and where available the temperature reduction of indoor air, outdoor air close to the VGS and energy reduction.

The prestigious case study of One Central Park building complex in Sydney is presented. The interrelation of the parameters that determine the application and efficiency of vertical greenery require an overall research that will define the most appropriate solutions for the indoor and outdoor environment.

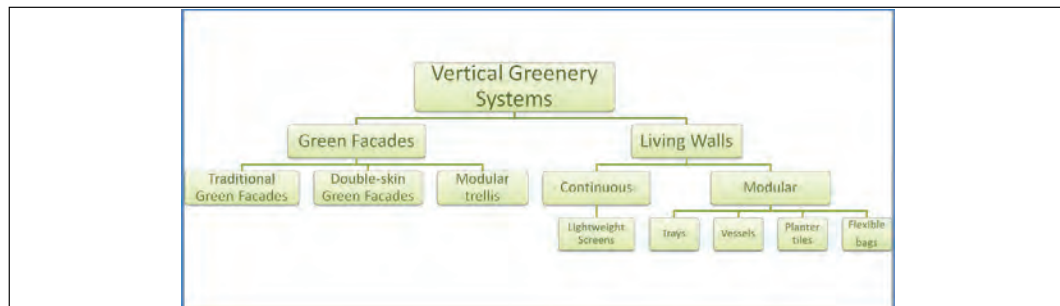

Fig. 1. Categories of VGS

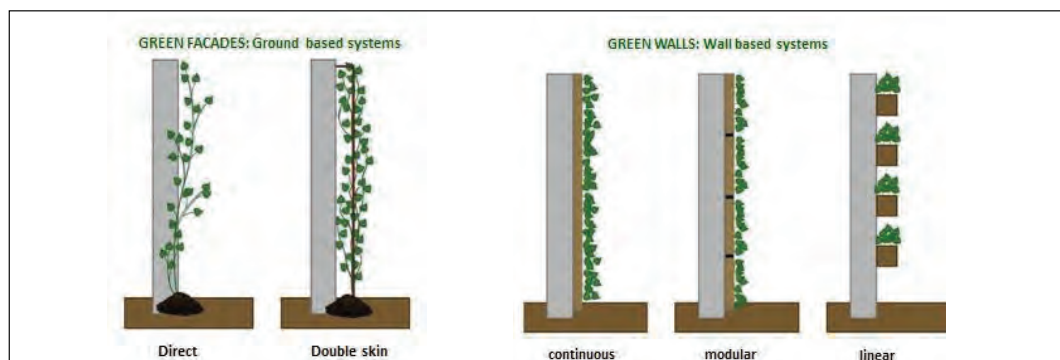

Fig. 2. Green facades and living walls

Analysis and Comparison of Adaptive and Conventional Façade Types: Increasing Application of Adaptive Facades in Macedonia

DURATION	22/03/2018 - 15/04/2018
VISITOR	Aleksandar Petrovski
HOME INSTITUTION	Ss. Cyril and Methodius University, Faculty of Architecture
HOME COUNTRY	Macedonia
HOST	Prof. Dr. Aleksandra Krstic-Furundzic
HOST INSTITUTION	University of Belgrade, Faculty of Architecture
HOST COUNTRY	Serbia
RELEVANT WORKGROUP(S)	WG2, WG3
INVOLVED RESEARCHERS	-

The STSM's main purpose was to explore the possibilities of the adaptive facades, the means of software simulation, to compare different types of facades and to contribute towards increase of the application of adaptive facades in buildings' design and to contribute to the goals of the COST TU 1403 Adaptive Facades Network.

An extensive review of the state-of-the-art literature has been undertaken on adaptive facades, typologies, their characteristic, types of control of the adaptivity and materials used. In order to test different types of façades and compare them a case study of an existing office building has been developed as a software model. Further, market analysis was made on types of façades, their availability and techno-economic aspects and it was decided to use following materials for façade glazing: double glazing (reference model), double glazing electrochromic and triple glazing with Low-E glass panes. The concept of adaptiveness of the façade has been implemented in the software models by using electrochromic glass, external screens and switchable glazing.

A survey was conducted among different stakeholders on different issues regarding the application of adaptive facades in the construction practice in R. of Macedonia. The architects, investors and construction companies are more familiarized with the concept of adaptive facades, opposite the users. Further, the most common types of adaptive elements that have been used are external movable screens, followed by internal screens and movable louvres. Among the stakeholders there is high compliance for the design aspects with high importance, such as: costs, maintenance, durability, interior comfort and energy savings.

Also, during the STSM I was involved in architectural design studio in the 1st year of Master, led by the host of this STSM, Prof. Aleksandra Krstic-Furundzic at the Faculty of Architecture in Belgrade, to train the students on designing and performing energy analysis of an adaptive façade.

	Glazing type	Control type	WWR
1	Double glazing	-	46%, 66%, 100%
2	Double glaz. electrochromic	extrinsic	
3	Triple glazing	-	
4	Triple glaz. and louvres	-	
5	Triple glaz. and exterior screen	extrinsic	
6	Triple glaz. and switchable glass	extrinsic	

Fig. 1. Description of the 18 models (each of the 6 glazing types is analysed with three WWR)

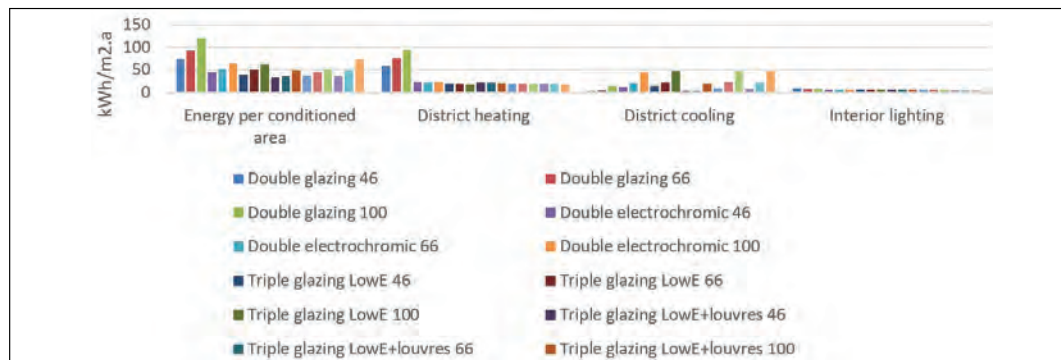

Fig. 2. Results of 18 models for energy consumption for heating, cooling and lighting (to be published in Luzern conference, 2018)

Thermo-Mechanical Numerical Modelling of Adaptive Facade Assemblies Under High Temperatures and Fire

DURATION	08/04/2018 - 14/04/2018
VISITOR	Dr Chiara Bedon
HOME INSTITUTION	University of Trieste, Department of Engineering and Architecture
HOME COUNTRY	Italy
HOST	Dr. Daniel Honfi
HOST INSTITUTION	RISE Research Institutes of Sweden AB
HOST COUNTRY	Sweden
RELEVANT WORKGROUP(S)	WG2
INVOLVED RESEARCHERS	Dr Marcin Kozłowski (Lund University, Sweden & Silesian University of Technology, Poland)

The current lack of standardised procedures to evaluate adaptive facades' mechanical performance by means of Finite Element numerical models represents a barrier towards their optimal structural design. The primary aim of this STSM consisted, therefore, in the numerical modelling of adaptive façade assemblies under high temperatures and fire.

A literature review was preliminary carried out, to properly describe the input properties of materials (glass and interlayers), as well as the expected thermal boundary and loading conditions. Comparative studies and sensitivity analyses were hence performed on selected structural glass specimens, so to explore the potential and reliability of the so assembled and calibrated numerical models, with respect to the past experimental observations (Figures 1 and 2). Major issues, for example, were found to derive from uncertainties in material properties, including the degradation of both thermo-physical and mechanical features with temperature, hence resulting in key influencing parameters for the full numerical study. In any case, based on a critical assessment of the collected comparisons, some general recommendations of interest were derived, so as to provide possible modelling guidelines of practical use for structural glass assemblies under high temperature and/or fire.

Related publications:

- Chiara Bedon, Marcin Kozłowski, Dániel Honfi (2018). Thermal assessment of glass facade panels under radiant heating - Experimental and preliminary numerical studies. *Journal of Facade Design and Engineering* (in print)
- Marcin Kozłowski, Chiara Bedon, Dániel Honfi (2018). Numerical Analysis and 1D/2D Sensitivity Study for Monolithic and Laminated Structural Glass Elements under Thermal Exposure. *Materials* 2018, 11(8), 1447; <https://doi.org/10.3390/ma11081447>

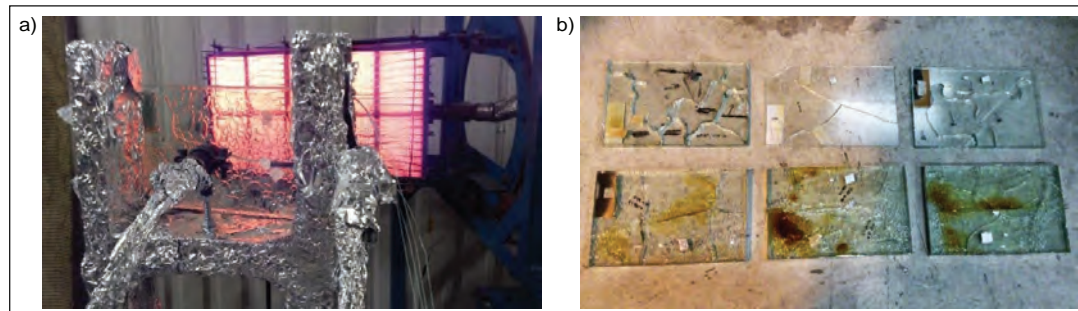

Fig. 1. Thermal experiments on MG and LG specimens: (a) test setup (with an exposed LG sample) and (b) typical damage scenarios for the failed specimens, at the end of the radiant heating tests (Copyright @ Dániel Honfi).

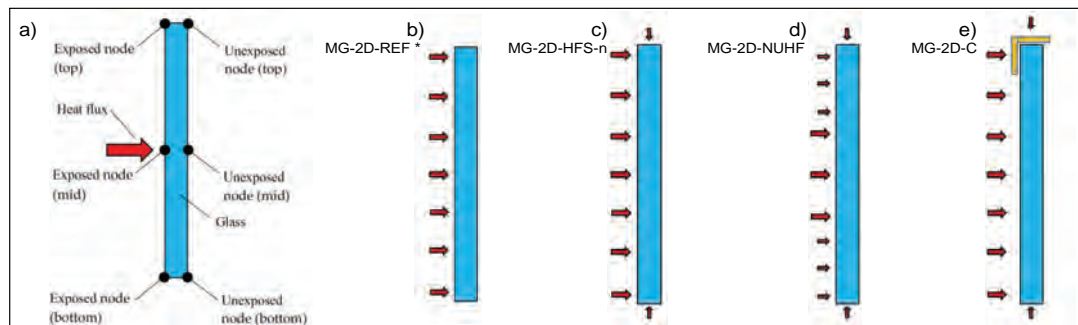

Fig. 2. Schematic representation (front view) of 2D heat transfer models (ABAQUS): (a) location of the reference control points for the thermal performance assessment, with (b–e) different boundary and loading configurations for the FE parametric study. * = reference 2D model for the parametric study.

Review on Structural Silicone Adhesives in Façade Design

DURATION	15/04/2018 - 21/04/2018
VISITOR	Michael Drass
HOME INSTITUTION	Technical University of Darmstadt, Institute of Structural Mechanics and Design
HOME COUNTRY	Germany
HOST	Prof. Dr. Ir.-Arch. Jan Belis
HOST INSTITUTION	Ghent University, Department of Structural Engineering
HOST COUNTRY	Belgium
RELEVANT WORKGROUP(S)	WG1, WG2
INVOLVED RESEARCHERS	Prof. Christian Louter, Prof. Jens Schneider

This STSM deals with the preparation of a review article which gives an overview of the ongoing studies on hyperelastic adhesive connections in façade engineering and provides guidance for structural engineers how to overcome difficulties in experimental, analytical and numerical modelling of these connections.

Experimental data of collaborating researchers were collected and prepared for material parameter identification. Based on the collected experimental material data basis, different hyperelastic material models were implemented in ANSYS FE Code and calibrated with the experimental data. Hence, isochoric hyperelastic material models including optimized material parameters were proposed for Dow Corning DC 993, Sika Sikasil SG 500 and Dow Corning TSSA. Since classical hyperelastic material models fail trying to simulate the H specimen in accordance to ETAG 002, a novel hyperelastic material was implemented in ANSYS FE Code via userhyper subroutine. With the help of the novel proposal, experimental results of the H test specimen for Dow Corning DC 993 and Dow Corning DC 993 could be validated. Additionally, a material model from literature was implemented in ANSYS FE Code to account for stress softening effects in hyperelastic materials. The material model was calibrated with experimental results of pancake tests for all three structural silicones. The obtained results have been directly implemented into the review paper.

An open problem in the numerical treatment of hyperelasticity is the right choice of a constitutive model, since conventional FE Codes provide many isochoric hyperelastic material models. Hence, strategies were proposed within the review paper to choose the right hyperelastic material model.

Furthermore, based on erroneous material parameter identification, the inherent material stability cannot be ensured during the numerical calculation, hence the calculation can diverge. Therefore, a short literature review was performed concerning the topic of polyconvexity. By ensuring the criterion of polyconvexity, a stable material behaviour during numerical calculations can be guaranteed. Within the review paper, an example was given to proof polyconvexity.

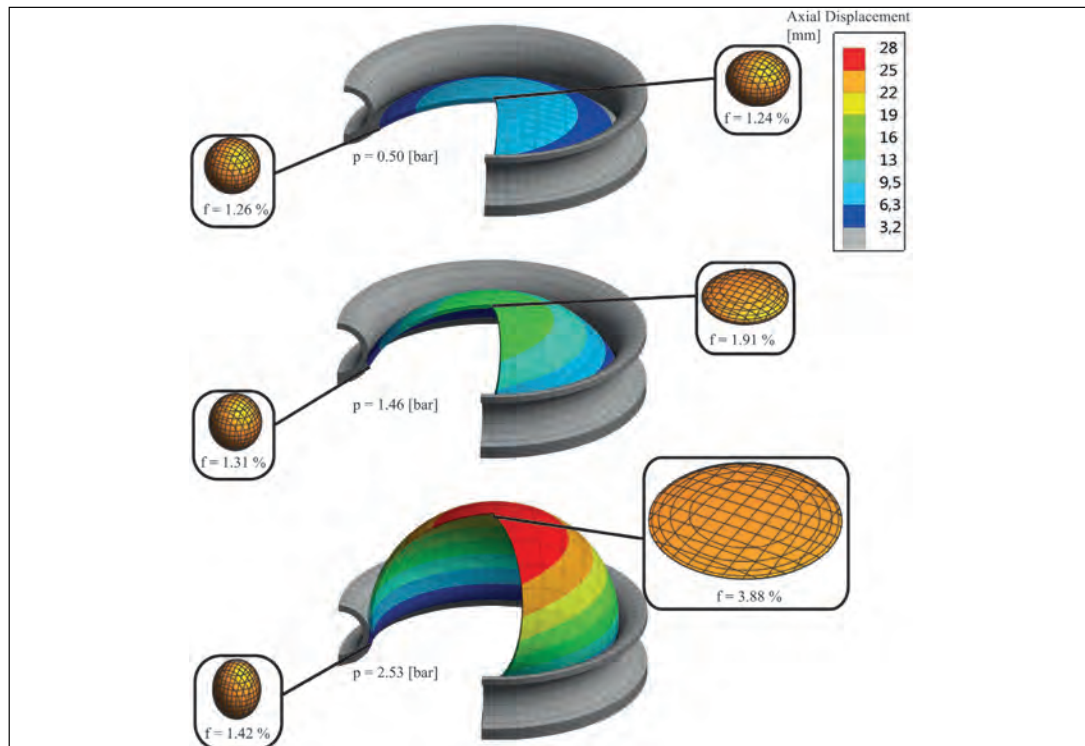

Fig. 1. Material modelling of the structural silicone connections



RICOLA HERB CENTER / Herzog & De Meuron (image: M. Brzezicki)

Industry-Workshops and Research Roadmap

The image features a landscape with a lush green field in the foreground and a plain, tan-colored wall in the background. The text 'Industry-Workshops and Research Roadmap' is overlaid in white, sans-serif font in the upper portion of the image.



Figure 1 - Geographical distribution of the participating Institutions.

Industry Workshops and Research Roadmap

Uta Pottgiesser, Daniel Aelenei, Ulrich Knaack

Research and Collaboration today

At the beginning of this COST-Action the participating institutions were mapped (Fig. 1) and published in a first publication (Luible et. al., 2015). The purpose of the map and comparisons was to visualize research areas that COST-Action members actively participate in, while illustrating current research areas that offer potential for further development (Fig. 2). The distribution shows increased activities in the areas of **advanced materials**, **façade glazing** and **façade shading** while the areas of simulation, monitoring and control systems seems to be less represented in the research. Regarding the façade functions the focus on **comfortable climate** and **sustainability** is very obvious, followed by activities to create durable constructions. Less attention is paid to the functions reasonable building materials and the support of the use of building.

Looking at the journal publications made during the COST-Action a similar pattern can be seen with a strong focus in assuring a comfortable climate – most of them related to technical applications and systems. But in this context, we can observe that the areas of simulation, monitoring and control systems have gained in importance – which is also represented and documented in Booklet 3.2 on Performance Simulation and Characterisation of Adaptive Facades.

Industry Workshop Delft 2015

This first Industry Workshop was hosted by the Faculty of Architecture and Built Environment, TU Delft, Julianalaan 134, 2628 BL Delft and brought together 62 participants. The objective of the meeting was to involve the industry and the façade associations in the activities of the COST-Action in order to build up a strong link between research and industry. Besides some representatives from the industry, which are already participating in the COST Action, four renowned experts have been invited to give a lecture about their view on adaptive facades and on future trends in building envelope design (http://tu1403.eu/?page_id=160). The active discussions demonstrated and highlighted the importance of a strong collaboration and knowledge exchange between all different disciplines and actors. This publication summarizes the key statements of the four lecturers with selected quotes:

Rudi Scheuerman, Arup Fellow und Global Leader Building Envelope Design, Arup Berlin. In his speech on 'About the Range of Responsive Facades' Rudi Scheuermann addresses "Envelope Design" instead of "constructive facade planning". From his perspective, the challenge is more towards the green building envelope which should be understood as a technical infrastructure, which has to achieve more than just technical performance. The task should be to deliver efficiency coupled with comfort for the human being – and to allow the person, using it, to adjust and define the individual comfort.

As a second theme, he defines digitalization of our design processes and production procedures. Here the topics like GIS and BIM but also the automation of productions, generation of detailed

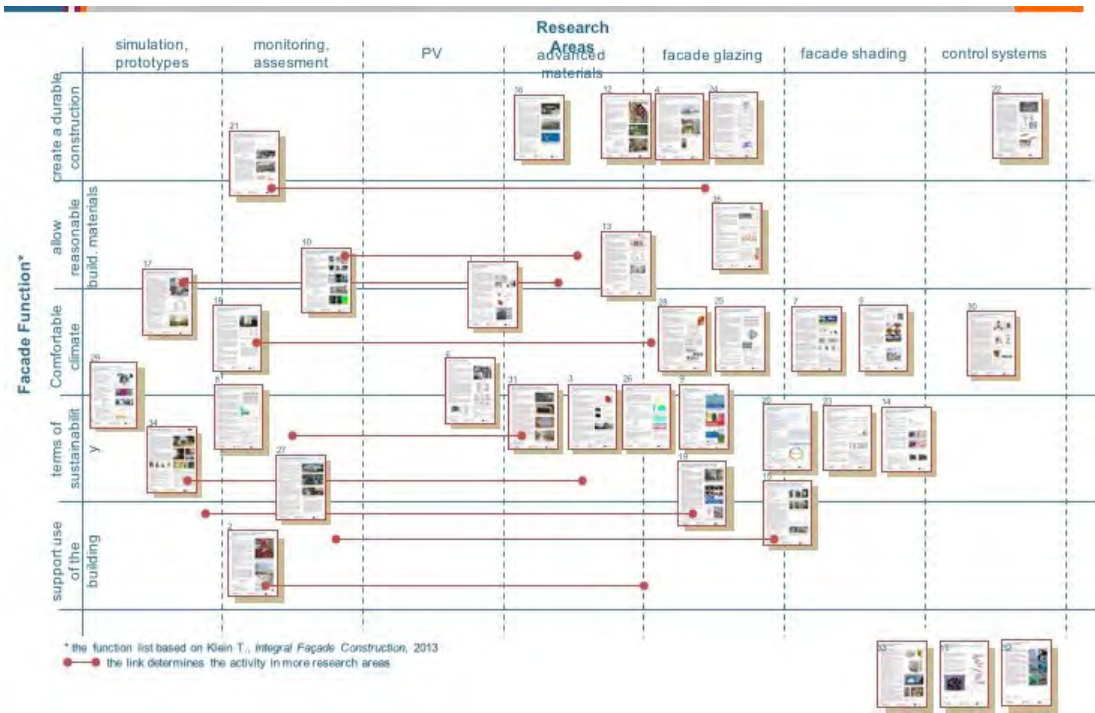

Figure 2 - The poster map with façade function vs. research areas has been produced at the beginning of the Action to clarify the activities and research areas of the participating institutions.



Figure 3 - Participants of the meeting and Industry Workshop in Delft 2015

execution and even automated construction will play a key role in the future of building envelope design, engineering construction and use.

Bert Lieverse, Managing Director at VMRG (Dutch Facade Association). As head of the Dutch facade Industry Bert Lieverse stated that he is impressed by the great interest of academia to link with industry. He comments that industry will need the influence of academia – but also academia needs to adjust its orientation, following the needs of industry and practice. It is not only about what can be developed and designed, but also the functional, technical and financial needs and demands have to be taken into account.

In his lecture Bert Lieverse addresses that digitalisation of workflows and production will play a key role in the future development of the industry – next to user satisfaction with the delivered comfort and functionality. To reach this, he defines communication between the players as well as an open technical and financial environment as key factors for innovation.

Winfried Heusler, Senior Vice President Global Building Excellence, Schüco International KG. In his presentation on 'Advanced façade design and technology. Industry view and where to go with research' Winfried Heusler identified two huge trends that to his opinion will radically transform the competence profiles of all involved parties: firstly, the continuous digitalization of the process chain and cyber-physical systems (CPS), which will involve and connect all stakeholders from architects and engineers to contractors, system suppliers, facade and maintenance companies. Secondly, the convergence of different trades to produce modularly designed facades with scalable functional groups, optimized interfaces and standardized functional principles.

Stephen Selkowitz, Leader, Windows and Building Envelope Materials Group, Senior Advisor for Building Science, Building Technology and Urban Systems Division, Lawrence Berkeley National Laboratory (LBNL). As experienced researcher Stephen Selkowitz gave a talk on 'Advancing Façade Performance: Technologies, Systems, Simulation and Field Testing', an overview of actual research at the Windows and Daylighting Group at LBNL. He described the difficulties in optimizing different requirements within one design and in real measured building performance. He also gave an outlook to achievable goals and research visions related to adaptive facades, such as Net Zero Windows that Outperform Insulated Walls or designs that replace electric lighting with daylight while preventing glare. He promoted an ideal of an 'Integrated approach' to facade-lighting-HVAC building systems to achieve optimum energy efficiency and comfort and proved with different examples that these holistic approaches are complicated to achieve.

Industry Workshop Lisbon 2018

The second Industry Workshop was hosted at Faculty of Science and Technology of NOVA University in Caparica, Portugal, with 60 participants. The six invited stakeholders from architecture (Sua Kay Architects), consultancy (Jofebar, University of Lisbon), production (BASF) and fabrication (Martifer, Pentagonal). The experts were asked to share their opinions about the following topics that were identified as upcoming and necessary questions for research, education and practice:

- How do you address the complex planning process? Who takes which role (generalist – specialist) and how come things together in the end?
- How to foster and increase the implementation of innovations in building design and construction?



Figure 4 - Discussion during the Industry Workshop in Delft 2015



Figure 5 - Final round table at the Industry Workshop on Lisbon 2018. From left to right, Uta Pottgiesser (moderator), Pedro Rodriguez (Martifer), Mário Sua Kay (Sua Kay Architects), Frederico Figueiredo (Pentagonal), Guilherme Carriho da Graça (University of Lisbon), and Nikolaus Nestle (BASF).

- What are the next steps for holistic building design and construction (such as BIM, RFID, monitoring, Circular Economy aspects)?
- What is the role of the user in the adaptivity-discussion?
- Is adaptivity the right approach or may simplicity be an alternative?

Mário Sua Kay, Head of Sua Kay Architects, concluded in his presentation 'Design challenges of facades - Past, Present and Future' that wood is the future trend for facades. He also called to keep things simple and to ensure buildings with quality details and include practical aspects and psychological domestic gestures.

Pedro Rodriguez, Technical Director at Martifer, presented 'Structural design of glass facades – highlights from projects' expressed that facade companies are permanently challenged to extend the limits of materials and constructions, such as huge glazing dimensions in combination with minimized profiles, which can lead to zero-tolerances and 'too much perfection'. He also believes that "facades that can adapt through the users" are a key issue of adaptive facades.

Nikolaus Nestle, Researcher at BASF Advanced Materials and Systems Research division, presented a research project on 'Adaptive wall elements with switchable U-value: the WaMaFat project and beyond' and explained the long way from laboratory research to implementation and application in the market. He defines adaptive envelopes as "facades that have passive and moderately active systems in order to supply comfort to end user" and to control the complexity.

Frederico Figueiredo, Project Engineer at Pentagonal, spoke about 'Innovative glass point fixing facades' and stressed the fact of new glass retrofitting for historic buildings and the importance of the security of glass. In his opinion, "digital building operation models and their connection to other digital infrastructure such as smart grids will be a key challenge for making full use of the potential of adaptive facades as well."

Guilherme Carrilho da Graça, Professor at the Faculty of Sciences, University of Lisbon and Sérgio Martins, Jofebar, shared a presentation on the 'Project FPM41 Office Building' on 'Designing for optimal use daylight and solar energy' and on the 'Technological solutions for optimal use of daylight and solar energy'. In their interdisciplinary approach, they explained the importance of adapting to individual user comfort.

In the final round table, moderated by **Uta Pottgiesser**, the industry panel and the audience had a chance to discuss current issues and challenges of adaptive facades. For the **further implementation of adaptive facades** different main challenges could be identified. Designers emphasized the challenge to integrate innovative, new and sustainable materials and that 'no perfection with new materials' is possible. All participants stated that the **speed of technology development** in the construction industry needs to improve and that there is a '**lack of innovation**'. They also called attention to user-behaviour and to the fact that people like to change their building.

The round table considered the following main **future trends** related to Facade Design and Technology:

- balance user needs vs. building technology;
- take into account circular economy aspects (e.g. no composites, materials fit for purpose);
- integrate digital design (e.g. BIM, Smart Grids).

The following needs regarding **Education and Training** in the field of facades were mentioned:

- the increase of competence in technology and of application orientation, in terms of sustainable construction knowledge, design for circularity and disassembly and increased awareness of details and constructability;



Figure 6 - Participants of the meeting and Industry Workshop in Lisbon 2018 at Library Auditorium of Faculty of Science and Technology of NOVA University

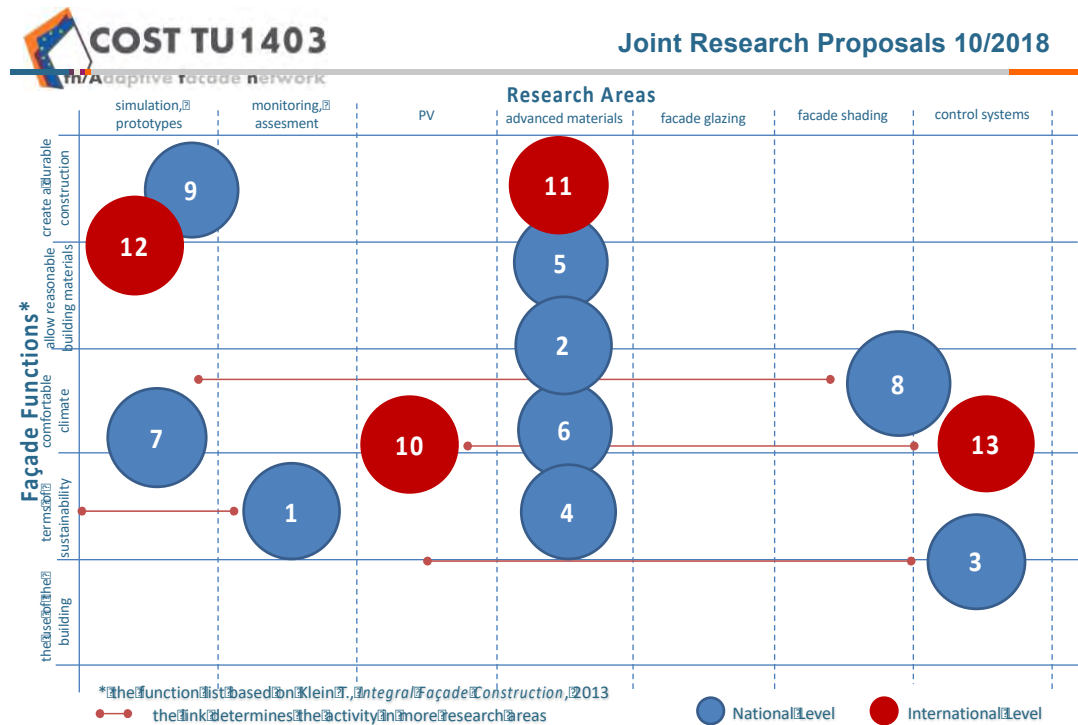

Figure 7 - Thematic focus of the submitted joint proposals on national and international level compared to the original distribution of current research activities, visualized at the beginning of the Action.

- communication competences and the ability to work in teams;
- The architects demanded for ‘better engineers’ able to collaborate with designers.

When it comes to **research** in the field of facades, the experts highlighted the following topics:

- facade materials and security of glass;
- improve planning processes: participation in design, digital design;
- foster innovation by the creation of spin-offs.

Networking and joint Research Proposals

From the final survey, we also got a feedback related to the networking that have been established besides the official COST-meetings, events and missions. One indicator is the submission of joint research proposals among different researchers and institutions of the Action. From the survey, we could identify 13 submitted proposals, certainly more are in preparation.

Table 1 - Submitted joint proposals on national and international level until September 2018.

National Level	International Level
1 Circular Construction	10 Solar Building Envelopes
2 Prefabricated wooden facades	11 AMforBE (ITN)
3 Buildings Energy Retrofit IoT	12 FAB Facades (ITN)
4 SPONG3D	13 ASTRAEUS
5 Convective Concrete	
6 Active Insulation	
7 ODYSSEUS	
8 AdaptoDIN	
9 InStep	

Comparing the submitted research proposals with the participant’s activities at the beginning of the Action (fig. 2), it becomes obvious that new research areas have been activated, such as the control systems, simulations and sustainable construction (fig. 7).

Research Roadmap

To verify the particular activities in this COST-Action, Working Group 4 also did a survey among the 270 members to better map the functions of the researchers and their current and future research interests. We also wanted to know which specific potentials the individual researchers see for the future of adaptive facades. This is also expressed through the concrete joint research proposals that were submitted during this COST-Action on national or European level. In total, 72 members participated in the survey – most of them from academic or research institutions (fig. 8-10).

The question, which fields of interest will trigger the future research of the research involved in the COST action was answered intensively and can be structured in the following themes:

Energy and comfort. Obvious a leading field in the research interest is the question, how to deal with the energy consumption and the potentials for reduction. This defines the question of

consumption during use but also the total life costs in the means of material embodied energy. To reach this goal, instruments like comfort control, active and passive control as well as system definition toward self-adaptation and dynamic systems are named. Finally, solar energy in the means of solar thermal or photovoltaic are addressed as energy resources to be used more and more efficiently in building envelopes.

Structural performance. In the field of structural performance of the building envelope it is obvious, that the potential for development is less intensive than in the field of energy and comfort – building envelopes are mostly subcomponents of the global structure of the building and by this less intensive investigated. Keywords named in the evaluation are adaptive and structurally flexible systems. Both fields imply the potential for flexible and by this adjustable building envelope systems, which would be able to interact with functions and climate demands.

Technology, materials and costs. The area of technology and materials is closely linked to building and energy-initiated costs. This leads to the key aspect of life cycle costs. And as a consequence of this, an interest in renewable materials and the potential for recycling and reuse is addressed. Next to this fields of interest like organic systems and robust systems are addressed. Especially the last aspect can be seen as an answer towards the increasing complexity of the construction and the by this imbedded risk of failure.

Design and engineering. The last field of interest is the process of designing and engineering the building envelope: tools and instruments available, are improving the quality and results of our design and engineering but a potential for improvement is seen in the fields like design for energy performance improvement, design and engineering strategies including simulation and the potentials of low cost / low tech were addressed. This finalizes in smart and intelligent buildings and the use of building integrated modeling - BIM

Observing the addressed fields of interest of the participating researches, it is obvious, that the current trend towards energy as key aspect for research is still active. Limitations in interest can be identified in the field of design. Here not the design engineering but the functional and aesthetical design is meant – a field of huge influence for the decision making and the use. Also, the field of system developments and site construction are entirely missing, which addresses a limitation in the link to industry. The needs for this kind of research and innovation were, however, clearly formulated in the industry workshops. We thus consider as a remaining objective for future research to connect more to implementation and measured and experienced performances to ensure that laboratory success stories find their way to the real built environment.



Westside (Bern) / Daniel Libeskind (image: M. Brzezicki)

Biographies



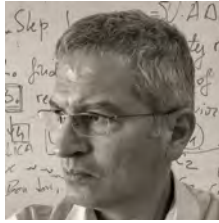

Daniel Aelenei

Daniel Aelenei is a professor of building physics and building technical services at Department of Civil Engineering and researcher at Center of Technology and Systems at Nova University of Lisbon, Portugal. He is responsible for taught graduate and postgraduate courses in energy efficiency of buildings and for coordinating the Postgraduate Course on Façade Engineering. He is co-author of more than 50 peer reviewed publications (journal, book or conference proceeding) and he has supervised 4 PhD theses. The research of Daniel Aelenei is focused on the low-energy buildings. He is Member of Committee of COST Actions TU1403 “Adaptive Facades Network”, co-subtask leader of Annex 67 – “Energy Flexible Buildings” of the International Energy Agency Energy in Buildings and Communities Programme (EBC), member of EU Interreg Project “SUDOKET – Mapping, consolidating and disseminating Key Enabling Technologies (KET) for the building sector in the SUDOE area”. He is also the principal investigator of the MIT Portugal Project – “FIRST - Mapping flexibility of urban energy systems” (MITEXPL/SUS/0015/2017).



Thomas Henriksen

Technical director for Kingspan façades, joining in 2018. Previous roles include Technical director and global façade leader at Mott MacDonald Ltd (2016-2018), technical director at Waagner Biro (2011-2015) and Seele (2010-2011), project manager façade package at IAV Construction (2007-2010), senior structural façade engineer at Arup (2004-2007).

A high level of experience in design across a wide range of buildings and infrastructure projects including; architectural competitions, direct liaison with clients, interpreting the clients’ requirements, developing and presenting design proposals; Contract negotiations; design development and detailing; coordinating interfaces between subcontractor packages and overseeing construction onsite; reviewing progress against contractors’ programmes and maintaining onsite quality.



Ulrich Knaack

Professor Dr. Ing. Ulrich Knaack (1964) was trained as an architect at the RWTH Aachen / Germany. After earning his degree he worked at the university as researcher in the field of structural use of glass and completed his studies with a PhD.

In his professional career Knaack worked as architect and general planner in Düsseldorf / Germany, succeeding in national and international competitions. His projects include high-rise and offices buildings, commercial buildings and stadiums. In his academic career Knaack was professor for Design and Construction at the Hochschule OWL / Germany. He also was and still is appointed professor for Design of Construction at the Delft University of Technology / Faculty of Architecture, Netherlands where he developed the Façade Research Group. In parallel he is professor for Façade Technology at the TU Darmstadt / Faculty of Civil engineering/ Germany where he participates in the Institute of Structural Mechanics + Design. He organizes interdisciplinary design workshops and symposiums in the field of facades and is author of several well-known reference books, articles and lectures.



Thaleia Konstantinou

Dr.- Ing. Thaleia Konstantinou studied Architecture at the National Technical University of Athens. Since 2006, she has been a certified architect as a member of the Technical Chamber of Greece. In 2008, she graduated with distinction from the Master of Science programme on Environmental Design and Engineering at The Bartlett School of Graduate Studies, University College London. During and after her studies, she has worked as an

architect in greek and international practices.

In September 2014 she concluded her PhD research at the Faculty of Architecture, Delft University of Technology, The Netherlands. Her research on the topic of façade refurbishment strategies was part of the research programme “Green Building Innovation”.

She is currently an Assistant Professor in the Department of Architectural Engineering and Technology of the Faculty of Architecture, Delft University of Technology. Her activities are related to research and education, focussing on energy efficiency, façade design and building products.



Aleksandra Krstić-Furundžić

Dr. Aleksandra Krstić-Furundžić, Professor at the University of Belgrade, Faculty of Architecture and several times head of the Department of Architectural Technology and a visiting professor at the Faculty of Architecture, University of Banja Luka, BiH. Professional experience as an educator, architectural design practitioner, researcher, and editor.

Expert domains: Architectural constructions, Innovative façade and

roof technologies, Energy efficient buildings, Passive and active solar systems, Industrialized construction, Building refurbishment technologies. She participates in the National Energy Efficiency and Technological Development Programs, and was a member, lecturer and trainer in Training Schools within several COST Actions, such as TU1205, TU1104 and TU1403, and for some she was the organizer. She is Co-Founder and Technical Director of International Academic Conference on Places and Technologies, recognized at the regional level and beyond. Member of the Editorial Board of two international journals, and several professional associations. Author of several books, and a significant number of chapters in international and national monographs and scientific papers published in Energy and Buildings Journal, Renewable & Sustainable Energy Reviews and other international journals.



Christian Louter

Dr. ir. Christian Louter is Assistant Professor on Structural (Glass) Design at the Faculty of Architecture and the Built Environment at the TU Delft. Christian obtained his PhD Cum Laude from TU Delft in 2011 and has worked as a post-doctoral researcher at EPFL in Switzerland before returning to TU Delft in 2015. Next to his research and teaching activities, Christian is Research Coordinator at the

Department of Architectural Engineering and Technology, an Editor-in-Chief of the Glass Structures & Engineering journal, an Organizer of the Challenging Glass Conference series and a Core Group member of the European COST Action TU1403 on Adaptive Facades.



Andreas Luible

Since 2010 Andreas Luible is head of the Competence Center for Building Envelopes CCGH and responsible for the field of study on building envelopes at Lucerne University of Applied Science and Arts in Switzerland. He studied civil engineering at the Technical University Munich and received his diploma in 1999. In 2004 he finished his doctorate at the EPF Lausanne. From 2004 until 2010, he was working as a senior façade engineer for the international façade companies Schmidlin Fassaden Technologie AG, Josef Gartner Switzerland AG and YUANDA Europe Ltd. He is an active member of several national and European standards commissions on curtain walling and glass. His research investigates glass design, new façade technologies and materials, design of energy efficient building envelopes and adaptive facades. Since 2014 Andreas Luible is the chairman of COST Action TU1403 “Adaptive Facades Network”.



David Metcalfe

David Metcalfe is a physics graduate with a Master’s degree in Façade Engineering. As Director of CWCT he is responsible for all of the Centre’s technical and training output. David lectures extensively on the subject of building physics, glass and fire. Past research has included collaborating with industry on many building physics related topics including thermal bridging, facilitating natural ventilation with double-skin facades and the practical implementation of automated facades. Recent work has included guidance on fire and facades, the writing of a comprehensive guidance document on the use of built-up walls in modern construction, and establishing a new Master’s course in Façade Engineering at the University of the West of England. He is part of the Construction Products Association technical expert panel following the fire at Grenfell Tower. He is a board member of the Society of Façade Engineering and is currently chairing the Society’s fire committee.



Uta Pottgiesser

Since 2004 Professor of Building Construction and Materials at the Detmold School of Architecture and Interior Architecture at Technische Hochschule Ostwestfalen-Lippe (TH-OWL), Germany. 1984 - 91 studies of architecture and diploma at Technical University Berlin (TU Berlin), Germany; 1998 - 2004 research assistant at Technical University Dresden (TU Dresden), Germany, at the Institute of Building Construction where she obtained her PhD (Dr.-Ing.) in 2002 in the field of “Multi-layered Glass Constructions”. Since 2017 Professor for Interior Architecture at the University of Antwerp (Belgium) and since 2018 Chair of Heritage & Technology at TU Delft (The Netherlands). Since 1994 practicing architect for office, administration and high-rise buildings and a member of the Berlin Chamber of Architects and with a multidisciplinary background in architecture, civil engineering and interior architecture; as a vice-chair of DOCOMOMO Germany and member of DOCOMOMO she is concerned with the protection, reuse and improvement of the built heritage and environment, since 2016 she is Chair of the International Specialist Committee of Technology (ISC-T). Numerous national and international research projects and teaching and research stays, including the Getty Conservation Institute (GCI) in Los Angeles; she is a member in juries of architectural competitions and PhD commissions and a reviewer and author of international journals and book publications, in particular on constructive and heritage topics.



Frank Wellershoff

Frank Wellershoff (*1967) is since 2011 a full professor at the HafenCity University, Hamburg (Germany). His research is focused on the structural and building physical performance of façade systems and building envelopes.

He received his diploma degree in civil engineering from the University of Bochum in 1994 and started his professional career as a project engineer for steel and concrete structures at CSK Engineers, Bochum. From 1997 to 2005 he researched at the Institute of Steel and light-weight Structures, RWTH Aachen University. Here he conducted several projects in the fields of wind engineering, structural glass application, and façade systems. He received his Ph.D. in 2006 with the topic of stabilization of building envelopes with the use of the glazing.

From 2005 to 2011 he was team leader engineering at Permasteelisa/Gartner, a global operating façade contractor. In this function he was responsible for the engineering design of more than 30 high end façades.