

Using dedicated EV charging areas to resolve grid violations caused by renewable energy generation

Vasan Ashok, Vijay; Chandra Mouli, Gautham Ram; van der Burgt, Jos; Peýate Vera, Santiago; Huibers, Martijn; Ramirez Elizondo, Laura; Bauer, Pavol

DOI

[10.1109/ITEC.2016.7520231](https://doi.org/10.1109/ITEC.2016.7520231)

Publication date

2016

Document Version

Accepted author manuscript

Published in

2016 IEEE Transportation Electrification Conference and Expo (ITEC)

Citation (APA)

Vasan Ashok, V., Chandra Mouli, G. R., van der Burgt, J., Peýate Vera, S., Huibers, M., Ramirez Elizondo, L., & Bauer, P. (2016). Using dedicated EV charging areas to resolve grid violations caused by renewable energy generation. In *2016 IEEE Transportation Electrification Conference and Expo (ITEC)* (pp. 1-6). IEEE. <https://doi.org/10.1109/ITEC.2016.7520231>

Important note

To cite this publication, please use the final published version (if applicable).
Please check the document version above.

Copyright

Other than for strictly personal use, it is not permitted to download, forward or distribute the text or part of it, without the consent of the author(s) and/or copyright holder(s), unless the work is under an open content license such as Creative Commons.

Takedown policy

Please contact us and provide details if you believe this document breaches copyrights.
We will remove access to the work immediately and investigate your claim.

Using Dedicated EV Charging Areas to Resolve Grid Violations Caused by Renewable Energy Generation

Vijay Vasanth Ashok¹, Gautham Ram Chandra Mouli¹, Jos van der Burgt², Santiago Peñate Vera²,
Martijn Huibers², Laura Ramirez Elizondo¹, Pavol Bauer¹

¹Dept. of Electrical Sustainable Energy, Delft University of Technology, The Netherlands

²New Energy Technologies, DNV GL - Energy, The Netherlands

Jos.vanderBurgt@dnvgl.com, P.Bauer@tudelft.nl

Abstract- EV Charging is expected to be a significant load on the grid in the future. But they can also be a part of the solution to grid violations. As the amount of renewable energy generation increases, there is a large amount of power flowing in the reverse direction in the distribution network, which is undesirable. To reduce this, EVs can charge at strategically located "Grid Management Parking Lots". Here the EV charging power level varies in accordance with the amount of capacity available in the grid. This is a win-win situation for both parties, the grid operator and the EV owner, as the grid operator reduces the amount of violations in the grid and the EV owner has his/her vehicle charged sooner.

I. INTRODUCTION

There are violations caused in the grid by incorporation of renewable energy sources (RES) and electric vehicle (EV) charging, but their large scale use is inevitable in the near future [1]–[5]. There is a possibility to use this to an advantage by combining the pros of RES and EV Charging. One of the ways of doing it is by using the excess RES generation for charging of EVs [6]–[8]. There may be cases when not many EVs are available for charging at the moment of peak RES generation. This is a unique circumstance where high charging powers help reduce grid violations. Therefore, it becomes important to study these situations and ways in which it can be effectively used. The first step is to identify the duration when this is possible and realize the potential for improvement, which is done earlier in this report. This section explores the possibility of varying the EV charging power level with an aim to reduce grid violations.

The focus here is a car park with 25 spots, located near the main train station in Mainz, Germany. The case here is that a small group of EVs, both private and commercial, can enter the area to charge. Currently the car park has a very weak electrical supply infrastructure and reinforcement will be needed. It is assumed that the parking will be used by a car sharing fleet (CSF), which is dependent on the train schedule, and short term EV parking users (STPU). As the EVs will have to be fully charged in a short span of time, fast charging can be considered during the day and regular slow charging at night. The charging poles are installed permanently. The neighboring city grid, Fig. 2, is identified and it has the capability to support (part of) the parking lot demand. The loads on the other nodes are Residential and Business in

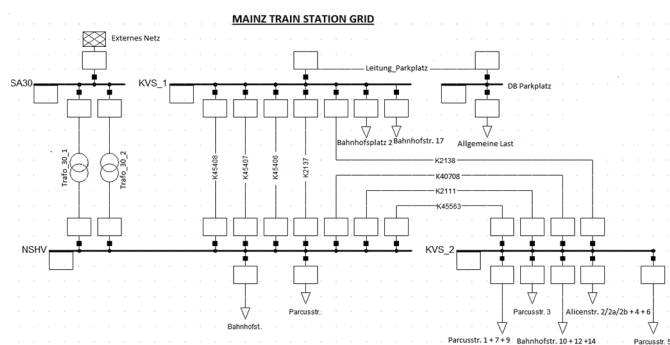

Fig. 2. Mainz Hauptbahnhof Grid

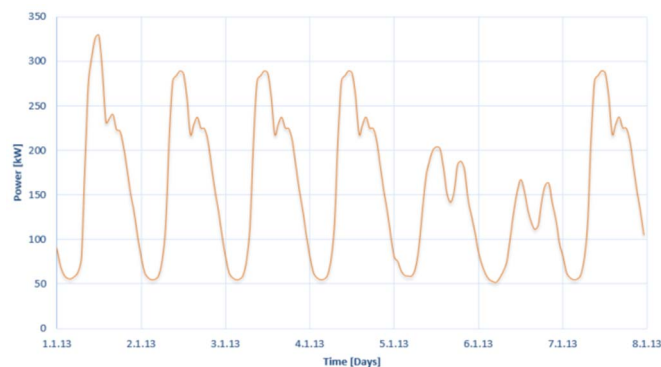

Fig. 1. Aggregated Base Load Profile

nature. There is a renewable energy generation in the form of rooftop PV and small wind turbines in the neighborhood [9].

The variation of the base load can be seen in Fig. 1. This load data is collected by Fraunhofer ISE, Germany. The PV and Wind generation profiles are extracted from the software Energy PRO, developed by EMD, Denmark.

II. INTEGER LINEAR PROGRAMMING

Integer Linear Programming is a conglomeration of two different programming concepts – Linear and Integer Programming. Linear Programming is a way of realizing the most favorable outcome in a model whose requirements are defined by linear relationships [10]. Several optimization problems can be defined as linear inequalities / equalities. It generally consists of three parts – Linear function which is to

be maximized or minimized, Problem Constraints and Non-negative variables, though this may vary from case to case. Integer Programming is a method of optimization where some or all of the variables are restricted to be integers. In most cases the two go hand in hand and is referred to as Integer Linear Programming (ILP) or Linear Integer Programming.

The term *Grid space* is introduced here, which refers to the power from the grid that is available for EV charging purposes based on the capacity of the line and local generation and loads, as shown in Equation (1).

The relation between the free Grid Space (the amount of power available in the grid) and the constructed EV Charging profile is linear. The EV Charging profile has to be maximized but with the constraint that it is less than the Grid Space at all times. The number of EVs that can be charged is restricted to being an integer only. Hence, this is a favorable case to use ILP to design this algorithm.

III. ALGORITHM AND METHODOLOGY

The algorithm is designed using a flow chart and is implemented on MATLAB. The flow chart, shown in Fig. 3 and Fig. 4, describes the behavior of the algorithm. The procedure followed is to first calculate the grid space, following which the EV Charging profile is built.

The EVs can be charged at two possible charging power levels - high charging power level (*ev_high_power*) and low charging power level (*ev_low_power*). At the start of the algorithm, the total number of EVs (*no_ev_total*), low and high charging power level and the grid capacity (*grid_capacity*) are defined. Grid capacity is the power rating of the weakest link between the parking area and the distribution transformer, as this power is the maximum that the distribution line can handle without overloading. The PV, wind and base load profiles are read as inputs from collected data and are indicated by the terms (*pv_profile*), (*wind_profile*), and (*base_profile*) respectively.

Using this data, the Grid Space (*grid_space*) available for EV charging at each time instant is calculated using the following formula,

$$total_power(t) = grid_capacity(t) + pv_profile(t) + wind_profile(t) \quad (1)$$

$$grid_space(t) = total_power(t) - base_profile(t) \quad (2)$$

Once this is calculated, the following computations are made on each array cell, which requires a loop. The beginning of the loop is shown by the yellow circle, A. The first step within the loop is to reset the vehicle count (*ev_count*) to the maximum. This is done to ensure that there are maximum number of EVs are possible to be charged at the start of each iteration. The idea is to start with the maximum number of EVs and reduce the number of EVs charging at the higher power if it exceeds the space available in the grid. If the number reached does not exceed the grid space, this is the maximum number of EVs that can charge at the higher power level. If the EV count reaches 0, it means

that there is not enough space in the grid for any of the EVs to charge at the higher power.

This process is repeated for each time instant. At the end of the loop, the number of EVs charging at high power, at each instant is known, given by (*no_ev_high*).

With this data, the new grid space can then be calculated, after deducting the capacity used by the EVs charging at high power. This is the space available for the EVs to charge at the lower power, i.e. if all EVs are already not charging at high power. The procedure followed is the similar to the one described earlier for the higher power. The only difference being that the initial number of EVs are the ones that are not charging at high power. At the end of the iterations, the number of EVs that can charge at low power in the remaining grid space is obtained, given by (*no_ev_low*).

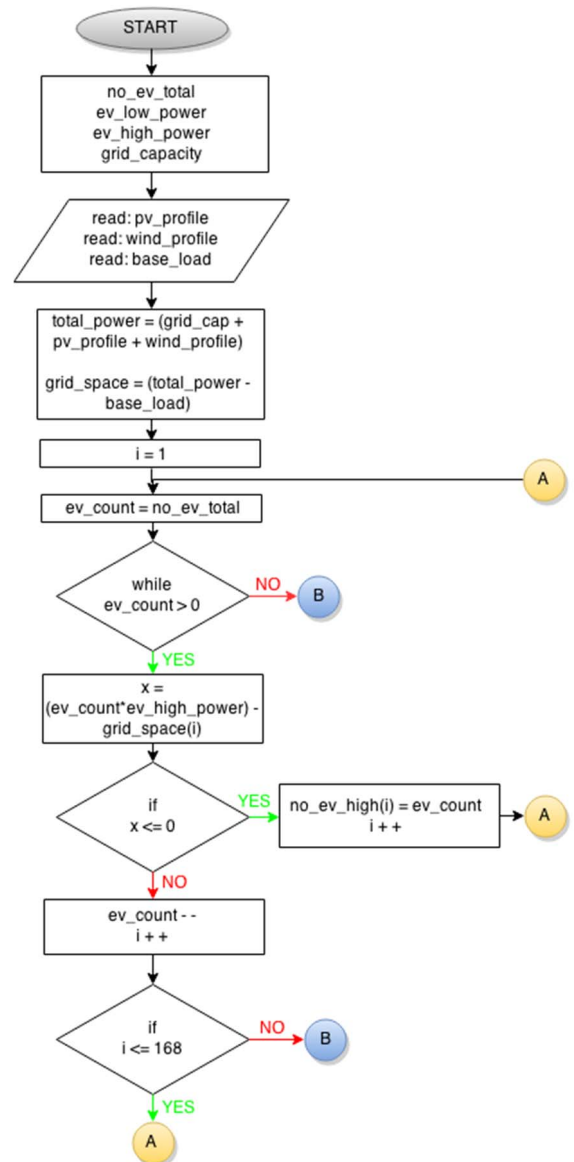

Fig. 3. Flow Chart Describing the Dynamic Charging Algorithm

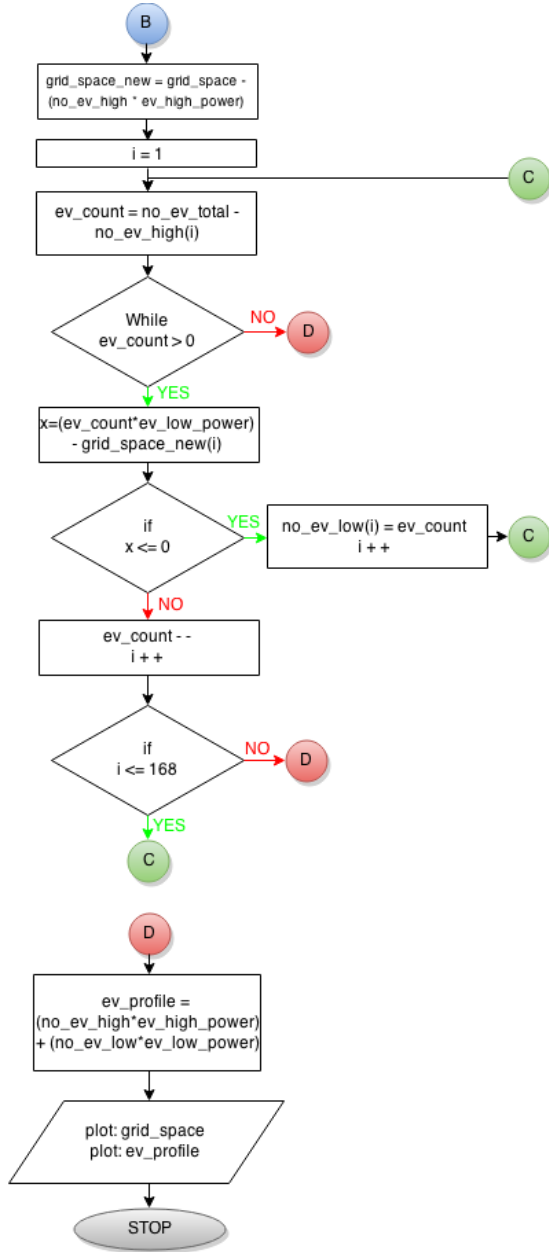

Fig. 4. Cntd.: Flow Chart Describing the Dynamic Charging Algorithm

The high power charging profile is given by,

$$\text{High Power Charging Profile}(t) = ev_high_power * no_ev_high(t) \quad (3)$$

The plot of the equation above shows the variation of the amount of power demanded by the EVs charging at high power at each instant. The next part shows how the EVs charging at low power behave. The low power EV charging profile is built using the following equation.

$$\text{Low Power Charging Profile}(t) = ev_low_power * no_ev_low(t) \quad (4)$$

Just as in the previous case, the plot of the above result gives the behavior of EVs charging at low power. The objective function in this algorithm is to maximize 'High

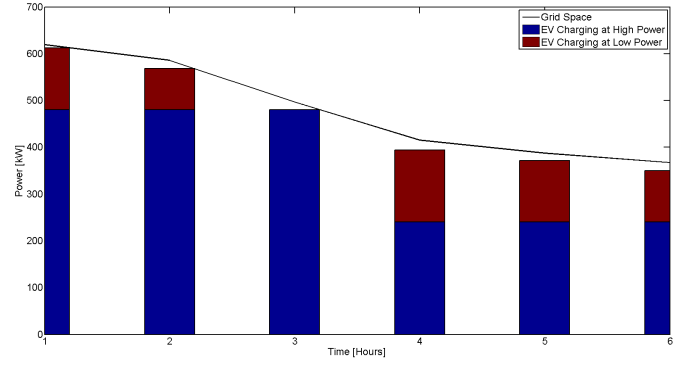

Fig. 5. The Working of the Dynamic Charging Algorithm

'Power Charging Profile' first and following that to maximize 'Low Power Charging Profile'. The constraint being that the combination of low and high charging power profiles must always lie on or within the grid space. The combined EV Charging profile is computed using Equation (5).

$$\begin{aligned} \text{EV Charging Profile}(t) &= \text{High Power Charging Profile}(t) \\ &+ \text{Low Power Charging Profile}(t) \end{aligned} \quad (5)$$

The algorithm is coded and modelled in MATLAB as array operations can be done easily on it and the results can be displayed effectively using detailed plots.

Fig. 5 shows the principle behind the working of the algorithm. The black line in the graph shows the grid space. The idea is to first fill in the blue rectangle and maximize its area below the grid space curve. Once that is done and no more blue rectangles, synonymous to EVs charging at high power, can fit in the algorithm starts filling in EVs charging at low power.

Various charging power combinations are used and the variation of the result is observed in the next section. It is important to note that grid losses are not taken into account in this simulation, an ideal scenario is assumed. The simulation is conducted for the 1st week of January 2013. The EV Charging Profile is plotted along with the Grid space on a single graph to verify the algorithm outcome and compare the effect of various charging power combinations.

IV. SIMULATION AND RESULTS

The algorithm described in the previous section is run for various combinations of charging powers. The priority is for as many cars to charge at high power and as many of the remaining cars to charge at low power, at every instant. These functions are maximized with the constraint that the total power consumed at high and low power put together is lower than the available grid space. The results obtained at the end of simulations for each charging power combination is described in this section.

A. Charging Powers of 22kW and 3.7kW

The first simulation uses a high power of 22kW and a low power of 3.7kW. This corresponds to a three phase 400V, 32A and a single phase 230V, 16A connection respectively.

Fig. 6 shows the Grid Space, number of EV charging at high and low power and the combined EV charging profile for 22kW and 3.7kW. As seen in Fig. 6, there are several instances where all EVs are charging at the higher power. At least 10EVs are charging at the higher power at all times. A large number of EVs charging at high power on most occasions is beneficial. It is seen that that the number of EVs charging at 22kW follows the pattern of the grid space curve. The remaining EVs charge at 3.7kW to fill in the gaps. Though the number is quite low, with a maximum of 5 EVs charging at low power at any instant.

Looking at Fig. 7, the crests in the grid space curve and the EV Charging profile are almost identical. This is what the algorithm aims to achieve. Unfortunately, the performance is not as good when the peak grid space is considered. The high charging power is not high enough to reach the peak available grid space.

The high charging power level needs to be raised to accommodate this shortfall and to use the available grid space more efficiently. Bearing this in mind, the higher charging power level is increased to 240kW DC.

B. Charging Powers of 240kW DC and 3.7kW

As a result of the previous case, a combination of 240kW DC charging is combined with 3.7kW in order to closely

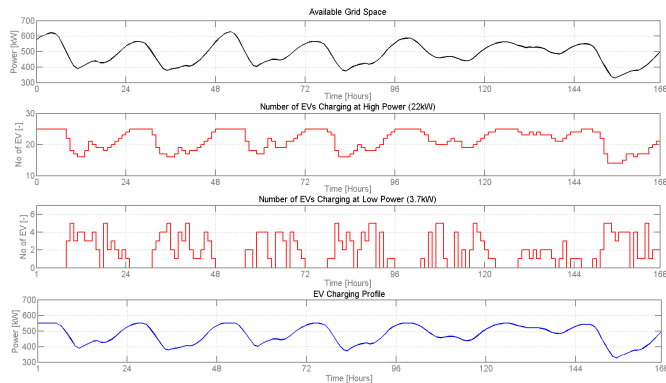

Fig. 6. Grid Space, No. of EV Charging at High Power, No. of EV Charging at Low Power and Combined EV Charging Profile for 22kW and 3.7kW

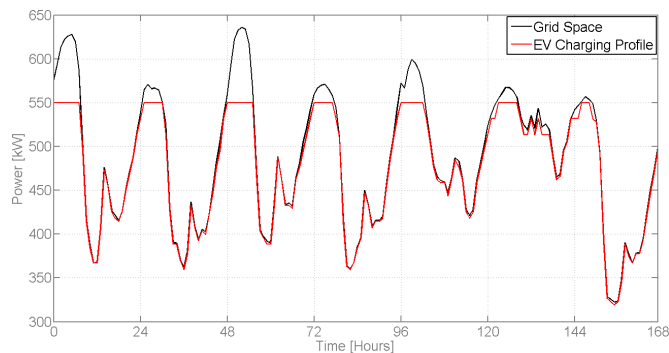

Fig. 7. Comparison of the Available Grid Space and Combined EV Charging Profile for 22kW and 3.7kW

match the EV Charging curve and the available grid space. Similar graphs are obtained, as in the previous case as seen in Fig. 8 and Fig. 9.

As seen in Fig. 8, the grid space remains the same as the other profiles are unchanged. Surprisingly, there is only a maximum of two cars that charge at 240kW DC and the remaining cars charge at 3.7kW. There are occasions where the cars charging at 3.7kW follow the grid space. Fig. 9 shows the comparison of the grid space and EV charging profile. As can be seen, except on a couple of occasions, the two curves are very different. This is because the integral multiple of the higher charging power level is too high and the lower charging power is too low to make up for the created voids. Hence, there is a very large gap between the peak of the EV charging profile and the peak of the grid space curve, which is too large for the EVs charging at the lower level to make up. A similar phenomenon is observed when the crests are studied. Often, only 1EV can charge at 240kW and the remaining EVs charging at 3.7kW and this is simply not enough to cover the deficit. This calls for a reduction of the higher charging power level and the increase of the lower charging power level. The next section examines the use of 22kW and 55kW as the two charging powers.

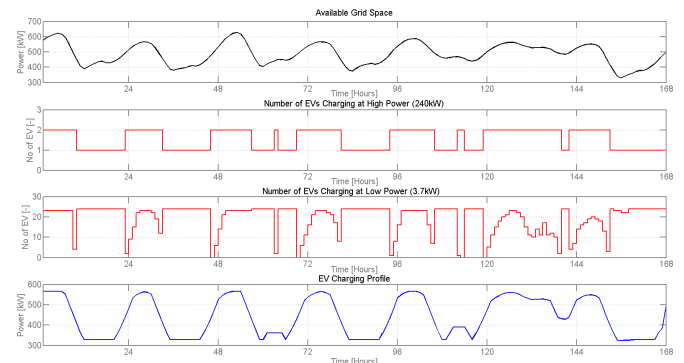

Fig. 8. Grid Space, No. of EV Charging at High Power, No. of EV Charging at Low Power and Combined EV Charging Profile for 240kW DC and 3.7kW

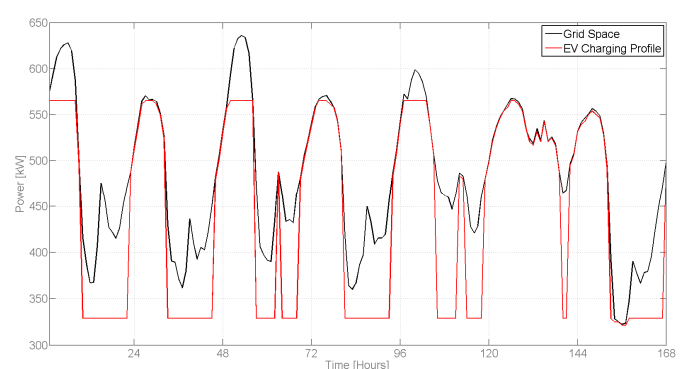

Fig. 9. Comparison of the Available Grid Space and Combined EV Charging Profile for 240kW DC and 3.7kW

C. Charging Powers of 55kW and 22kW

The charging power combination used in the previous case does not satisfy the need of closely matching the grid space. Therefore a combination of 22kW and 55kW is used in this case. Fig. 10 shows that there are a maximum of 11 EVs charging at 55kW and 2 EVs charging at 22kW. This proves that there is no instance where all the EVs are charging. Therefore, to include more EVs into the charging pool, the power level can be reduced. When looking at Fig. 11, it is very evident that this combination of charging powers has a positive influence in matching the EV Charging and grid space curves.

Both the curves follow the same trend and the gap between both the curves is minimal. Hence, this combination of powers is the best so far. The only drawback being that only a fewer number of EVs can charge at a time. This may be used in cases where the EV charging demand is low. To include a larger EV charging pool into this solution, a combination of 55kW and 3.7kW is studied next.

D. Charging Powers of 55kW and 3.7kW

This section uses a charging power combination of 55kW and 3.7kW. The number of EVs charging at 55kW is unchanged from the previous case, as it is the higher power and the algorithm maximizes this first. The difference lies in the number of EVs charging at the lower power level, as seen in Fig. 12.

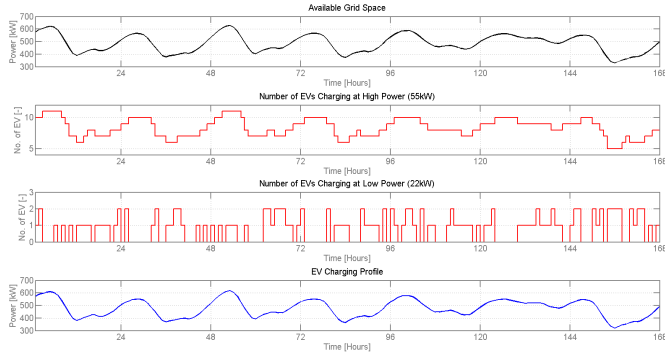

Fig. 10. Grid Space, No. of EV Charging at high power, no. of EV Charging at low power and combined EV charging profile for 55kW and 22kW

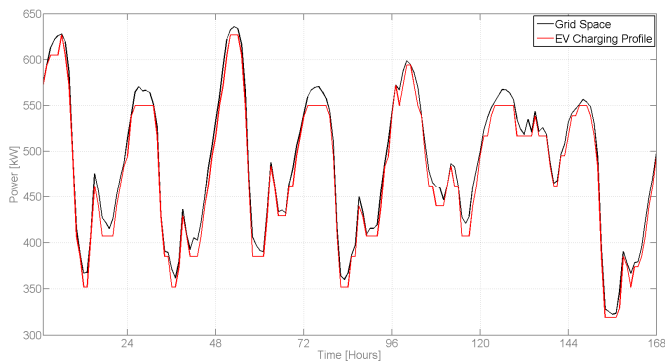

Fig. 11. Comparison of the Available Grid Space and Combined EV

A maximum of 14 EVs charge at the lower power level. On the whole, there are more number of EVs being charged at a given moment of time. There is another large benefit of charging with this combination of charging powers, which is seen in Fig. 13. The EV charging profile and the grid space curve are identical. This goes to show that the given grid space can be ideally packed with this combination of EV Charging powers. This emphasizes the importance of choosing the right combination of charging powers.

E. Key observations

This section shows that the power from RES can be used by EVs to charge and that it can increase the grid utilization. In the case with EVs charging at 55kW and 3.7kW, the grid utilization is almost 100%. This is developed from a grid operator's perspective, where EVs can be used to minimize grid violations. The two optimal charging power levels will vary on case-by-case basis. The two power levels are dependent on the local grid configuration and local renewable energy generation. The approach shown in this paper can be used to determine the two power levels. Based on the SoC and energy demand of all the EV, the charging profile can be

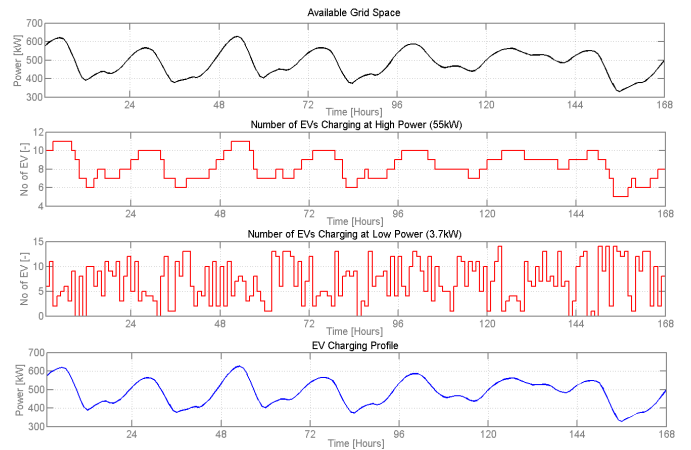

Fig. 12. Grid space, No. of EV charging at high power, No. of EV charging at low power and combined EV charging profile for 55kW and 3.7kW

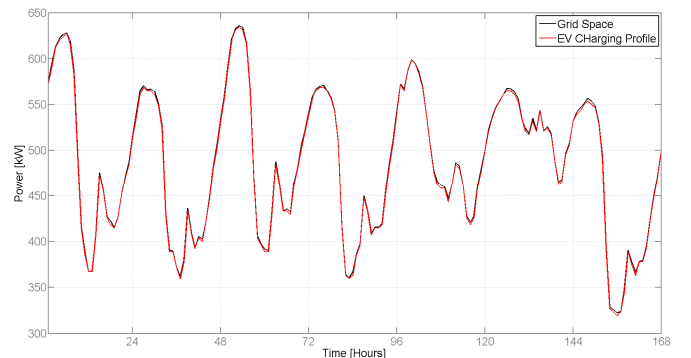

Fig. 13. Comparison of the Available Grid Space and Combined EV Charging Profile for 55kW and 3.7kW

developed using the two power levels in such a way that it uses the available grid space and not exceed the capacity of the grid.

The key is to use EV as flexible loads so as to both charge them as per user requirements and absorb as much RES as possible. A fixed number of EVs constantly charge at each power level, which is determined from the graphs above, and the number of EVs is the minimum number of EVs charging at each power level for the chosen combination. The remaining EVs will have to switch between the two power levels depending on the available grid space. Different tariffs can be used for each customer as the variation of charging power is controlled by the grid operator. In this way, the EVs themselves can be used to resolve a lot of grid violations.

It is important to mention here that dynamic charging using continuously variable EV charging power is an equally good solution to utilize available grid space and match renewable production [7], [11], [12]. Conversely, this would require additional hardware and/or communication with EV. With our proposed method, conventional EV chargers with complementary power levels will be sufficient. Secondly, the use of three or more power levels can be considered. However, it has been shown in this paper that the use of two power levels is sufficient to fill the available grid space. Therefore the use of multiple power levels would be unnecessary to fill the grid space and would result in the need for additional charger hardware at the charging station.

V. CONCLUSIONS

It is important to immediately consume the energy from renewables that cannot be stored. If it is not consumed, it can cause violations in the grid at high penetration levels of renewables. This issue can be avoided by cutting off the PV and Wind generation, but it is an inefficient method. Therefore, if EVs can charge faster, at a higher power level, the PV and Wind energy that would have otherwise gone to waste can be effectively used. This can be achieved by varying the EV charging power level in accordance with the available grid space.

There are more EVs that can charge at a given time with the use of multiple charging power levels. Consider the combination of 55kW and 3.7kW charging, where the maximum number of EVs that can charge is more than 20. Whereas, if only 55kW charging was used, the number of EVs that can charge in the same grid space reduces to 11EVs. The maximum number of EVs that can charge with a combination of 55kW and 22kW is 12EVs. At the same time, the maximum is 23EVs for a combination of 55kW and 3.7kW. This shows the importance of choosing the right combination of power levels for a given grid. Also, the latter has higher grid utilization as the available grid space is fully used up. In situations where there is excessive RES generation, the EVs can switch to high power charging to use up some of the power. This reduces the amount of reverse power flow in the grid.

REFERENCES

- [1] P. Bauer, N. Stembridge, J. Doppler, and P. Kumar, "Battery modeling and fast charging of EV," in *Proceedings of 14th International Power Electronics and Motion Control Conference EPE-PEMC 2010*, 2010, pp. S11–39–S11–45.
- [2] P. Bauer, Yi Zhou, J. Doppler, N. Stembridge, and Y. Zhou, "Charging of electric vehicles and impact on the grid," in *Proceedings of 13th International Symposium on Mechatronics, MECHATRONIKA 2010*, 2010, pp. 121–127.
- [3] S. Bhattacharya and P. Bauer, "Requirements for charging of an electric vehicle system based on state of power (SoP) and state of energy (SoE)," in *Proceedings of The 7th International Power Electronics and Motion Control Conference*, 2012, vol. 1, pp. 434–438.
- [4] J. van der Burgt, S. P. Vera, B. Wille-Haussmann, A. N. Andersen, and L. H. Tambjerg, "Grid impact of charging electric vehicles; study cases in Denmark, Germany and The Netherlands," in *2015 IEEE Eindhoven PowerTech*, 2015, pp. 1–6.
- [5] G. R. Chandra Mouli, P. Bauer, T. Wijekoon, A. Panosyan, and E.-M. Barthlein, "Design of a Power-Electronic-Assisted OLTC for Grid Voltage Regulation," *IEEE Trans. Power Deliv.*, vol. 30, no. 3, pp. 1086–1095, Jun. 2015.
- [6] G. R. Chandra Mouli, P. Bauer, and M. Zeman, "Comparison of system architecture and converter topology for a solar powered electric vehicle charging station," in *2015 9th International Conference on Power Electronics and ECCE Asia (ICPE-ECCE Asia)*, 2015, pp. 1908–1915.
- [7] G. R. Chandra Mouli, P. Bauer, and M. Zeman, "System design for a solar powered electric vehicle charging station for workplaces," *Appl. Energy*, vol. 168, pp. 434–443, Apr. 2016.
- [8] G. R. Chandra Mouli, M. Leendertse, V. Prasanth, P. Bauer, S. Silvester, S. van de Geer, and M. Zeman, "Economic and CO2 emission benefits of a solar powered electric vehicle charging station for workplaces in the Netherlands," in *2016 IEEE Transportation Electrification Conference and Expo (ITEC)*, 2016.
- [9] "NEMO-Project," <http://www.nemo-project.eu/>.
- [10] T. Ferguson, "Linear programming: A concise introduction," *UCLA [online] http://www.math.ucla.edu/~tom/LP.pdf*, 2000.
- [11] B. V. E. Bakolas, P. Bauer, and D. Prins, "Testing of Smart Charging Controller for dynamic charging from solar panels," in *2014 IEEE Transportation Electrification Conference and Expo (ITEC)*, 2014, pp. 1–4.
- [12] G. R. Chandra Mouli, J. Kaptein, P. Bauer, and M. Zeman, "Implementation of dynamic charging and V2X using Chademo and CCS/Combo DC charging standard," in *2016 IEEE Transportation Electrification Conference and Expo (ITEC)*, 2016.