

Robustness of hinterland container transportation
A scenario study into merchant haulage and terminal haulage

Bonnie van Vuure
Faculty of Technology, Policy and Management
Master thesis – 7 August 2015



Technische Universiteit Delft

Graduation committee:

Chairman: Prof.dr.ir. A. Verbraeck

First supervisor: Dr. H.K. Lukosch

Second supervisor: Dr. S.W. Cunningham

ABSTRACT

Containerisation has dramatically changed international transportation; it has affected the speed and costs of the transportation of goods. The largest share of costs of container transportation is related to inland transportation. The performance of the container transportation chain as a whole determines its competitive position. Disruptive events occur in the transportation chain, and if they are not mitigated effectively, the disruptions will be propagated through the chain. Robustness of the container transportation chain is key to acquiring and maintaining a good competitive position. This research investigates to what extent the hinterland network configuration, like merchant haulage and terminal haulage, influences the robustness of the hinterland container transportation chain. During this research a discrete event simulation model has been developed for the hinterland transport chain between Rotterdam and the Ruhr district. Three different disruption scenarios are studied during the simulation runs: delay of a vessel, low water levels in the Rhine River, and a combination of both. This research shows that changing hinterland network configuration of the transport chain from merchant haulage to terminal haulage is an effective way of increasing the transport chain's robustness, thereby increasing the competitive position of the terminal. The model results can be used to support container terminal operators with the strategic decision of whether or not to invest in terminal haulage.

Key words: robustness, scenario study, disruptions, hinterland container transport, terminal haulage, merchant haulage, discrete event simulation.

CONTENTS

Abstract.....	2
Summary.....	5
1. Introduction.....	8
1.1 General introduction.....	8
1.2 Problem description.....	8
1.3 Scope.....	9
1.4 Research questions.....	10
1.5 Research methodology.....	10
2. Hinterland container transport.....	13
2.1 Introduction hinterland transport.....	13
2.2 Intermodal transport.....	13
2.3 Hinterland network configuration.....	15
2.4 Disruptions & Robustness.....	19
2.6 Shared Situational Awareness & Information sharing.....	21
3. Conceptualisation.....	23
3.1 System boundaries.....	23
3.2 Model structure.....	25
3.3 Assumptions.....	27
4. Model Specification.....	29
4.1 Building block description.....	29
4.2 Scenario study.....	32
4.3 Key Performance Indicators.....	35
5. Verification.....	37
6. Results.....	40
6.1 Merchant haulage.....	40
6.2 Terminal haulage.....	43
6.3 Deviated arrival times and overcapacity.....	45
7. Discussion & Conclusions.....	49
7.1 Discussion.....	49
7.2 Conclusions.....	51
7.3 Reflection.....	54
8. References.....	56

Appendix A: Dwell time.....	59
Appendix B: Key Performance Indicators	60
Appendix C: Data table	62
Appendix D: MH rescheduling probability	65
Appendix E: Verification tests	68
Appendix F: Results.....	73
MH – S0 run	74
MH – S1 run	77
MH – S2 run	81
MH – S3 run	85
TH – S0 run.....	89
TH – S1 run.....	92
TH – S2 run.....	96
TH – S3 run.....	100
Appendix G: Deviated arrival times and overcapacity.....	105
Appendix H: Image of MH discrete event simulation model.....	111
Appendix H: Image of TH discrete event simulation model	114

SUMMARY

Since their introduction 50 years ago, containers have dramatically changed international transportation. With the container it became possible to transport cargo in unitised loads, which brought enormous benefits. The largest share of costs involved in door-to-door service on many international trade routes is related to the inland transport mode rather than to ocean voyage (Vasiliauskas & Barysiene, 2008, p. 313). The success of a port not only depends on its own performance, but also on the performance of the hinterland transport chain to which it is connected. The quality of a port's hinterland access depends on the behaviour of many actors: terminal operators, freight forwarders, port authority and container operators (De Langen, 2004 in (Van der Horst & De Langen, 2008, p. 109)). Ports have become links in global supply chains and competition between ports has moved to competition between transport chains (Robinson, 2002 in (Van der Horst & De Langen, 2008, p. 109)).

Disruptive events challenge the cooperation within the hinterland transport chain and when not mitigated well, they could threaten the competitive position of the transport chain. Disruptions are unplanned and unanticipated events that disrupt the normal flow of goods and materials within a supply chain or transport network (Craighead, Blackhurst, Rungtusanatham, & Handfield, 2007, p. 132). Due to interconnectedness of the transport chain, the effect of a disruption can easily be propagated throughout the chain affecting other actors' activities and eventually lowering overall performance. In order for the hinterland transport system to acquire or maintain a good competitive position it has to be robust against disruptions. A system is robust if it is able to perform its intended function well with respect to uncertain future conditions. The hinterland network configuration, for example merchant haulage (MH) and terminal haulage (TH), is expected to have a large impact on the robustness of the hinterland transport chain.

In merchant haulage many different actors have to cooperate for the transportation of the containers, and each actor is responsible for its own part of the chain. In terminal haulage the sea-side container terminal develops inland terminals and takes responsibility over the hinterland transport leg. There is more emphasis on coordination and control of the container flows in the multimodal hinterland network. Instead of waiting for containers to be picked up by truck, rail or barge, seaport terminals are able to push blocks of containers into the hinterland. Terminal haulage, is supposed to have the ability to create benefits in modal shift and logistics performance while alleviating congestion in the sea-side terminal. Most of the hinterland container transportation is done in merchant haulage and only a small part in terminal haulage. The influence of merchant haulage and terminal haulage on the robustness of the transportation chain have not been studied before. In this research a discrete event simulation model has been developed to answer the following research question.

The research questions is: ***“What is the influence of the hinterland network configuration on the robustness of a hinterland container transportation chain?”***

Method

For this study the hinterland intermodal transport system is represented by a discrete event simulation model made with Arena software. The hinterland transport chain for import containers is modelled from the Port of Rotterdam via the inland terminal in Duisburg to the customer's warehouse in the Ruhr district. Figure 1 shows a schematic overview of the hinterland transport chain for import containers as

it is modelled. Per day 208 TEU arrive at the sea-side terminal, where they are stored and later on picked up by one of the three hinterland modalities: rail, barge and truck. Trucks transport the containers directly to the customer's warehouse, while barges and trains go to an inland terminal from where the container is picked up by truck to be transported to the customer. Two models are developed, one for merchant haulage and one for terminal haulage. The scenarios are used to study the robustness of merchant haulage and terminal haulage. A scenario describes a possible future. The scenarios are:

0. Non disruptions
1. Delay of a vessel
2. Low water level in Rhine River
3. Combination of scenario 1 and 2

The results of the simulation runs of the two models are compared based on the three key performance indicators (KPIs):

1. Number of containers in stack at sea-side container terminal
2. Number of containers that have to be rescheduled
3. System recovery time after disruption

The results are summarized in Tables 11, 12 and 13. The answers on the sub questions are the following:

1. What is the effect of the delay of one vessel on the performance of the hinterland transport chain?

When a vessel arrives at the sea-side terminal while it is delayed by 7 days, part of its containers will miss their hinterland modality. Those containers have to be rescheduled, either by their own modality or by truck. The disruption's effect was more severe in MH than in TH. The recovery time of MH was longer than that of TH. The number of containers that have to be rescheduled in case of a delayed vessel is in MH much higher than in TH.

2. What is the effect of a low water level in the Rhine on the performance of the hinterland transport chain?

The low water level in the Rhine River causes problems for barges: only 25% of the barge transport capacity. Whereas MH struggles with this loss of barge capacity, TH has no difficulties at all in dealing with this disruption. In MH a large part of the containers had to be transported by truck instead of barge. However, in TH there is a lot more flexibility with as result that the customer does not experience any negative effect of the disruption.

3. How does overcapacity of hinterland modalities influence the ability of the transport chain to deal with vessel arrival times that deviate from planning?

The results of the simulation runs showed large differences between the hinterland transport capacities needed in MH and TH. TH is able to deal with vessel arrivals deviating from planning even with no overcapacity. MH, however, needed at least 20% overcapacity to perform well.

The scenario study shows that TH performs better on the key performance indicators under almost all scenarios. It can be concluded that the hinterland transport network configuration does have an influence on the robustness of the hinterland container transportation chain. The transportation chain

with TH is more robust than with MH. For TH less area is needed at the sea-side terminal for the stack-yard, since in TH containers are transported faster to the inland terminal and are stored over there. In TH the disruptions are mitigated faster and with lower costs. A robust transport chain has a better competitive position. Nowadays it is not the sea-side terminals that compete with each other to attract transport flows, but it is transportation chains as a whole that compete with each other. A terminal operator that wants to improve its competitive position definitely has to increase the robustness of the whole transportation chain. This research shows that changing hinterland network configuration of the transport chain to TH is an effective way of increasing the transport chain's robustness, thereby increasing the competitive position of the terminal.

The discrete event simulation model can easily be adapted to be used for other locations where there is a sea-side terminal connected to an inland terminal. The simulation model could serve as a tool to support the terminal operator in the decision making of strategic issues, such as whether or not the terminal should expand its business into the hinterland by applying TH. From the point of view of robustness, it would be wise for terminal operators to do so. However, investments for inland terminals have to be done and the organisation has to be designed in such a way that it allows for good information sharing between the departments. Only then TH can be a success.

1. INTRODUCTION

1.1 General introduction

The emergence of containers 50 years ago has dramatically changed international transport. With the container it became possible to transport cargo in unitised loads, which brought enormous benefits. Containerisation has made transportation cheaper and faster, because goods do not need to be unpacked at each point of transfer. Transport volumes increased and economies of scale made it profitable to transport containers with large sea vessels (Frémont & Franc, 2010). Containerisation can be seen as the backbone of globalisation, since it made international transport faster and more affordable, thereby increasing international trade. Vessels and terminal equipment have been adapted to the use of containers. The increasing size of container vessels meant larger cargo volumes per port call and shorter handling time per volume of freight. Vessels only call at a limited number of terminals, which increases competition between terminals for serving large vessels (Notteboom, 2008, p. 4). In addition to ensuring its competitive position the port community also has to deal with congestion, pollution, delays due to administrative burdens, instability of hinterland connections and a search for the relationship between added value activities and the cargo handling process (Veenstra, Zuidwijk, & van Asperen, 2012). Many of these issues have been subject to scientific research, such as: coordination problems (Van der Horst & De Langen, 2008), extended gate concept and intermodal transport (ULTIMATE Research project), supply chain disruptions (Craighead, Blackhurst, Rungtusanatham, & Handfield, 2007) and inland terminals (Rodrigue, Debie, Fremont, & Gouvernal, 2010).

1.2 Problem description

Transport systems for cargo fulfil a key role for the economy and they are important to society. A large share of the cargo is transported in containers; more than 60% of the world's deep-sea general cargo transport is done with containers (Vasiliauskas & Barysiene, 2008, p. 311). Customers more and more expect higher flexibility, reliability and precision, and they want their products at maximum speed, with supreme delivery reliability and at the lowest possible cost (Notteboom, 2008, p. 6). Clearly it is an enormous challenge to meet these high expectations all at the same time. This thesis focuses on intermodal transport, which is the transport of goods by the coordinated use of more than one transport mode, such as train, barge and truck. The ocean leg of the transport chain is done by large sea-vessels that carry up to 8000 containers. After unloading in a deep-sea terminal the containers are transported to the customer by truck, train or inland barge. The largest share of costs involved in door-to-door service on many international trade routes is related to the inland transport mode rather than to ocean voyage (Vasiliauskas & Barysiene, 2008, p. 313). Due to the relative importance of hinterland transport, the choice of port and hinterland modality has a high impact on overall costs, speed and reliability.

In intermodal transport the advantages of the modes are maximised and the transport chain should be guided as one unity (Panayides, 2002, p. 401). In practice, however, many different actors have to cooperate to realise the door-to-door transport. Logistics actors and transport operators have designed complex networks that need a high level of reliability, which depends on the synchronisation of different geographical scales (Notteboom, 2008, p. 7). The success of a port not only depends on its own performance, but also on the performance of the hinterland chain to which it is connected. The quality of a port's hinterland access depends on the behaviour of many actors: terminal operators, freight forwarders, port authority and container operators (Van der Horst & De Langen, 2008, p. 109). However,

it is not the individual behaviour of actors that counts; all actors of the transport chain are involved when it comes to the performance of the network. The overall performance highly defines the extent to which the customer's requirements are met. The interconnectedness of the hinterland transport chain and the interdependencies among actors increase the complexity of the transport system. Since actors do not always have the same interests, cooperation might be hampered in cases where operations do not go according to plan, such as in the case of unexpected disruptions.

Disruptions such as breakdown of transport modality or equipment, accidents or blocked routes have a high impact on transport operations. Due to interconnectedness of the transport chain, the effect will be propagated throughout the chain affecting other actors' activities and eventually lowering overall performance. To ensure a good competitive position, transport chains need to be robust against disruptive events. The goal of this research is to study the influence of the hinterland network configuration, either merchant haulage or terminal haulage, on the robustness of the hinterland container transport chain. In merchant haulage the container transport into the hinterland is done by many different companies, whereas in terminal haulage it is the sea-side container terminal operator that takes the responsibility over the hinterland transport of the containers. The extended gate concept is an example of terminal haulage where the transport flows between the sea-side container terminal and the inland container terminal are controlled by the sea-side container terminal operator. According to literature, terminal haulage has the ability to create benefits in modal shift, logistics performance and alleviating congestion in the sea-side terminal (Veenstra et al., 2012, p. 14).

Whether terminal haulage is also more robust against disruptions has not been studied yet. In this research the robustness of the transport chain in terminal haulage and in merchant haulage is investigated by means of a scenario study applied on a discrete event simulation. The two models are compared based on three performance indicators. This study contributes to science by coming up with new insights about robustness of merchant haulage and terminal haulage and by the creation of a new discrete event simulation model in which the effect of scenarios upon the performance of the transport chain can be tested. For sea-side terminal operators the results of this study are valuable in the decision whether or not to expand their business and apply terminal haulage (or extended gate concept).

1.3 Scope

This research focuses on hinterland transport for import containers. The geographical scope is defined by the transportation corridor between Rotterdam and Duisburg, which is located in the Ruhr district. The choice for the DeCeTe terminal in Duisburg is made since it is a trimodal inland terminal: it is connected with the Rotterdam terminal through the Rhine River, through road, and through rail. Per year around 800.000 TEU is transported from several sea-side container terminals in Rotterdam to Duisburg. The containers are transported by truck, rail and barge. They are transported from the inland terminal in Duisburg to the industrial areas in the Ruhr district by truck. Figure 1 shows the Netherlands and part of Germany. Both the sea-side terminal in Rotterdam and the inland terminal in Duisburg are indicated. The simulation model is built based on these two terminals, but if the numbers are changed the model can be used to analyse any other transport chain for import containers. The triangles in Figure 1 each represent an inland terminal, that all compete with each other.

The internal processes in the sea-side and inland container terminals, like customs services, are considered to be outside the scope of this research.

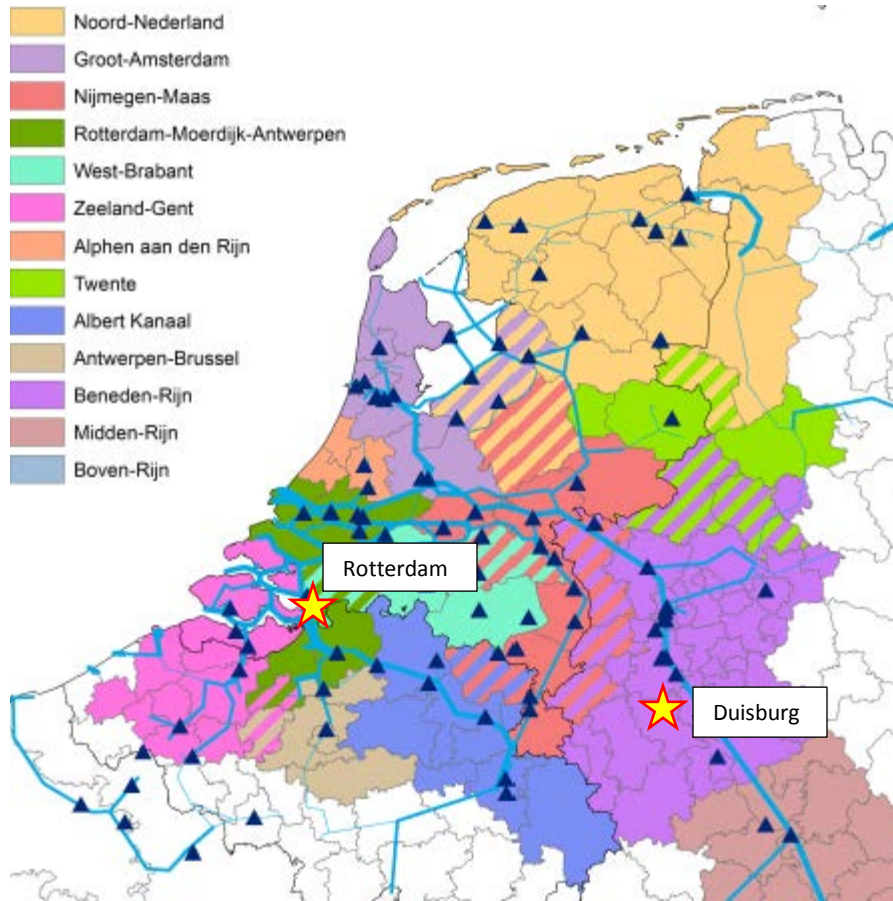

Figure 1: Locations of Port of Rotterdam and Duisburg terminal (IDVV, 2012, p. 25). Each triangle represents an inland terminal.

1.4 Research questions

According to the problem description and the scope of this research, the following research question has been formulated.

What is the influence of the hinterland network configuration on the robustness of a hinterland container transportation chain?

Subquestions

1. What is the effect of the delay of one vessel on the performance of the hinterland transport chain?
2. What is the effect of a low water level in the Rhine on the performance of the hinterland transport chain?
3. How does overcapacity of hinterland modalities influence the ability of the transport chain to deal with vessel arrival times that deviate from planning?

1.5 Research methodology

This section explains the methods that are used during this research.

Literature study: Literature provides insight into the scientific knowledge available on the topics of intermodal transport, disruptions, the extended gate concept, terminal haulage and merchant haulage. Literature increased the understanding of transport operations and the role of actors in the transport system.

Interviews: In addition to information from literature, interviews with experts were done to gain a better understanding of the practical aspects of container transport and the challenges that are present in hinterland transport. The interviews were semi-structured: the interview topics are prepared in advance, but new ideas and questions topics could emerge during the interview, based on the interviewee's answers. The interviewees are: Rob Zuidwijk (Rotterdam School of Management/TU Delft), Albert Veenstra (TNO), Marcel Ludema (TU Delft), and Stefano Fazi (TU Eindhoven).

Discrete Event Simulation: A computer simulation model is made to simulate the intermodal transport chain and to demonstrate the influence of disruptions on the performance of the chain. The intermodal transport chain is a socio-technical system. Robinson (2004) states that with a simulation study the system performance can be predicted, in order to compare alternative system designs and to determine the effect of alternative policies on the performance of the system. Variability, interconnectedness and complexity play an important role in the hinterland transport chain. Performance of a system that is subject to one or more of these aspects can hardly be predicted without use of a simulation model. The simulation model should be able to show the influence of disruptions on intermodal transport and allow for comparing the robustness of merchant haulage and terminal haulage. Simulation is appealing since it is more intuitive and an animated representation of the system can be created, which gives non-experts greater understanding of, and confidence in, the model (Robinson, 2004).

It would impossible to investigate the influence of disruptions by testing them in the real world; this would be too costly, time consuming, and it will hardly be possible to find companies that are willing to participate in any experiment. Simulation models provide a safe environment in which experiments can be conducted. Discrete event simulation is used to simulate the intermodal transport chain. Within discrete event simulation, a system consists of discrete units of traffic (containers in this case) that move from point to point in a system, while competing with each other for the use of scarce resources (Schriber & Brunner, 2006, p. 118). There still are, however, some drawbacks that should not be overlooked, like the amount of data needed for the model. Much data in the transport world is confidential or not easily accessible, and this could have an influence on the validity and usability of the simulation model.

Scenario study: A scenario describes a possible future situation. A common use of scenario derives from system models. The results of computer simulation models depend on assumptions about the extrinsic drivers, parameters and structure of the model. Variations in the assumptions used to create such models are often described as scenarios (Peterson, Cumming, & Carpenter, 2003, p. 360)). Scenario differ from forecasts since scenarios emphasise uncertainties that cannot be reduced by decision-makers (Peterson et al., 2003, p. 360). In this research a number of scenarios are defined that each represent a disruption that could occur in the transport chain. In reality is it uncertain when exactly a disruption occurs and how severe its effect is.

The scenarios are used to test the robustness of the hinterland container transport chain, either with merchant or terminal haulage. Robustness of the transport chain is about the performance of the system when unexpected events occur. Robustness is about uncertain future events, for which research

with scenarios is suitable. Scenarios offer the opportunity to study different future events in a structured way; by isolating one specific event and testing its influence on the system. Testing robustness without defined scenarios would mean that all kind of disruptions occur in a randomised way to the system. Even this would be called a scenario. However, it will be difficult to analyse and draw useful conclusions from tests with unstructured and not well defined scenarios. It is possible to define the scenarios well for this research because it is known what kind of disruptions occur in the hinterland transport chain. Based on this knowledge scenarios can be well defined, and the influence of individual or combined disruptions can be studied well. Although to the choice and exact definition of the scenarios has a subjective aspect, the results the study with the simulation model provide are objective results.

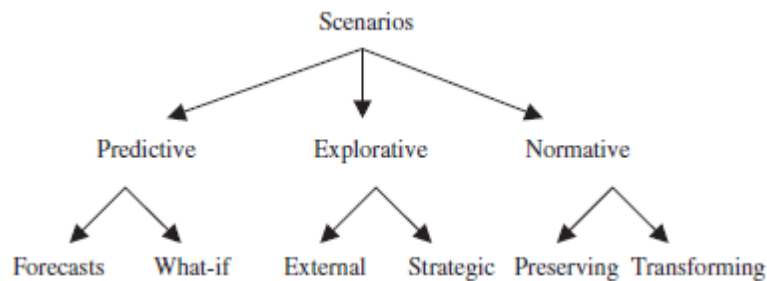

Figure 2: Scenario typology with three categories and six types (Börjeson, Höjer, Dreborg, Ekvall, & Finnveden, 2006, p. 725)

Börjeson et al. (2006) created a scenario typology with three categories and six types, see Figure 2. The scenario study that is done in this research fits best in the “what-if” type which is a sub category of predictive scenarios. What-if scenarios investigate what will happen on the condition of some specified events. This research investigates what will happen on the condition of disruptive events in the hinterland transport chain. The “strategic” scenario type compares policy measures to cope with the issues at stake. They answer the question “What can happen?” If merchant haulage and terminal haulage were rather large policy measures, comparing these would be possible with the strategic type of scenarios. However, strategic scenarios are used to study long-term effects, whereas in this research a maximum of 60 days is simulated. Predictive scenarios answer the question “What will happen?” and explorative scenarios answer the question “What can happen?” The current simulation model is rather deterministic and helps to answer “what will happen”, therefore the “what-if” scenario type fits best on the scenario for this study. In 4.2 Scenario study, the scenarios in his research are defined. Section 4.3 Key Performance Indicators describes the KPIs that are measured during each simulation run.

Research steps

1. Literature search
 - a. Hinterland container transport
 - b. Extended gate/terminal/merchant haulage
 - c. Actors
 - d. Disruptions
 - e. Robustness
2. Interviews
3. Identification of disruptions
4. Model building

5. Model running & Interpretation of results
6. Conclusions

2. HINTERLAND CONTAINER TRANSPORT

2.1 Introduction hinterland transport

Ports fulfil the functions of business support around the terminals; they provide internal infrastructure such as port road and rails, security and safety functions such as customs services. The terminal is the superstructure that is involved in the commercial operation of the port, namely the movement and processing of cargo such as containers (Berle, Rice Jr., & Asbjørnslett, 2011, p. 4). Containers are transported over sea by deep-sea vessels of which the largest have a loading capacity of up to 8000 containers (Voss, Stahlbock, & Steenken, 2004, p. 7). When import containers arrive at the terminal of a sea-side port they are transhipped to smaller barges, trains or trucks, or they are temporarily stored before being transported further into the hinterland. The containers are transported to the customer via an inland terminal by barge or train or directly to the customer's warehouse by truck. Container handling systems in container terminals have a big impact on the waiting time of incoming trucks, trains and barges. Shipping lines are not concerned if there is a poor terminal productivity, as long as their vessels sail on time. Terminal operators aim to maximise profit by efficiently using the resources (Henesey & Törnquist, 2002, p. 26).

Part of the transport flows have the hinterlands of a sea-port as their destination. Other flows have a destination further into the hinterland and, as a consequence, there is competition between different seaports to attract those transportation flows. Ports have become links in global supply chains and competition between ports has moved to competition between transport chains. (Robinson, 2002 in (Van der Horst & De Langen, 2008, p. 109)). The competitive position of a transport chain depends on many actors: for example the port authority, freight forwarders, sea-side and inland terminal operators, hinterland carriers and shipping lines. Together they determine the hinterland accessibility that is crucial to attract transportation flows.

2.2 Intermodal transport

This research focuses on intermodal transport. The following figure shows what the difference is between intermodal transport, co-modal transport and synchronodal transport. Location A is in this case the sea-side container terminal, B the inland terminal and C the customer's warehouse. The transport leg between A and B is done by either train or barge, and between B and C containers are transported by truck.

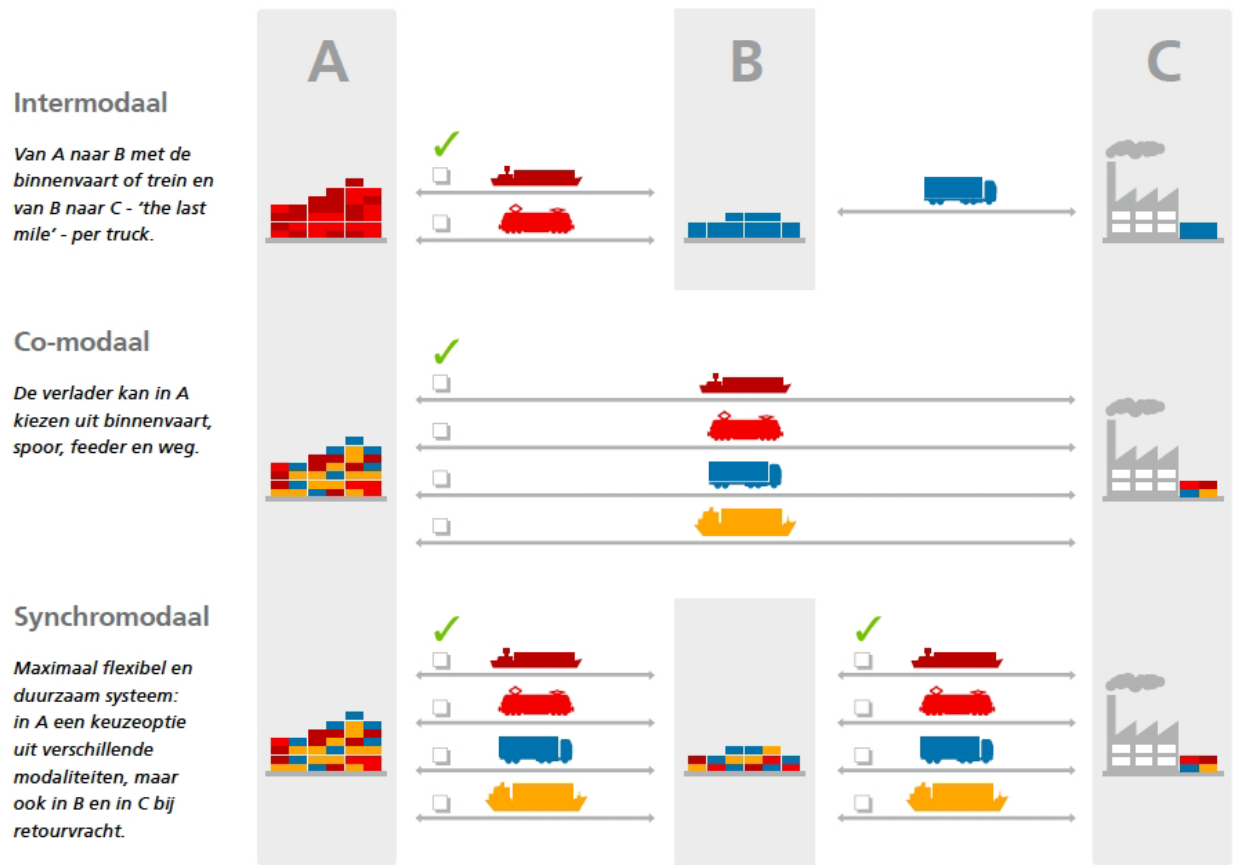

Figure 3: Hinterland container transportation (European Container Terminals, 2011)

Inland terminals and dry ports

Inland terminals are an essential part of the intermodal container transport chain. A specific type of inland terminal that has a direct connection with one or several seaports with high capacity transport means are captured in the term 'dry port' (Leveque and Roso (in (Veenstra et al., 2012, p. 20)). In dry ports, customers should be able to leave or pick up their containers as if directly to a sea-port. Although the term 'dry' may indicate differently, dry ports are reachable by barge, railway or trucks. A dry port is mostly a purely infrastructural extension of the sea port, established with the purpose of unlocking an extended hinterland for the sea port (Veenstra et al., 2012, p. 21). Full service dry ports could offer extra services in addition to the basic service of transshipment, such as storage, consolidation, depot-storage of empty containers, maintenance and repair of containers and customs clearance (Roso, Woxenius, & Lumsden, 2009, p. 341). The use of barges and railway services will decrease the use of trucks and a dry port therefore has the opportunity to relieve congestion on roads. In addition it will also decrease the congestion within the sea side terminal by transferring some activities from the sea terminal to the dry port. The services provided in a dry port will also save space in the sea port, where land will most probably be more expensive than in more remote areas. The quality of sea-side terminal performance is determined by the quality of access to a dry port and the quality of the road/rail/waterway interface (Roso et al., 2009, p. 341). It is therefore necessary to have reliable transport by high capacity modes between the dry-port and the sea-port.

2.3 Hinterland network configuration

A number of actors are active in hinterland transportation. First of all, the shipper or consignee is the organisation or person initiating the container transportation or owning the shipped goods (Douma, 2008, p. 32). The container transportation is mostly not arranged by the shipper itself, but this is done by a freight forwarder on behalf of the shipper. A shipping line takes care of the ocean part of the container transport, whereas a barge/truck/rail operator offers container transportation in the hinterland part. Terminal operators, either at the sea-side terminal or inland terminal, provide transshipment and storage services.

Depending on the hinterland network configuration, different parties have the responsibility over part of the container transportation. In general this can be divided into three types that are visualised in Figure 4.

- **Merchant haulage:** A third party (often a freight forwarder or logistics service provider) will take care of inland transport and delivery of the container to a customer's warehouse (Veenstra et al., 2012, p. 23).
- **Carrier haulage:** The shipping line will assume the responsibility of delivering the container to a customer's warehouse, but they will often contract it out to a local party (freight forwarder or logistics service provider) (Veenstra et al., 2012, p. 23).
- **Terminal haulage:** The sea-side container terminal develops inland terminals and takes responsibility over the hinterland transport leg. The container terminal operator either owns shares in companies that already deploy these activities or develops subsidiaries.

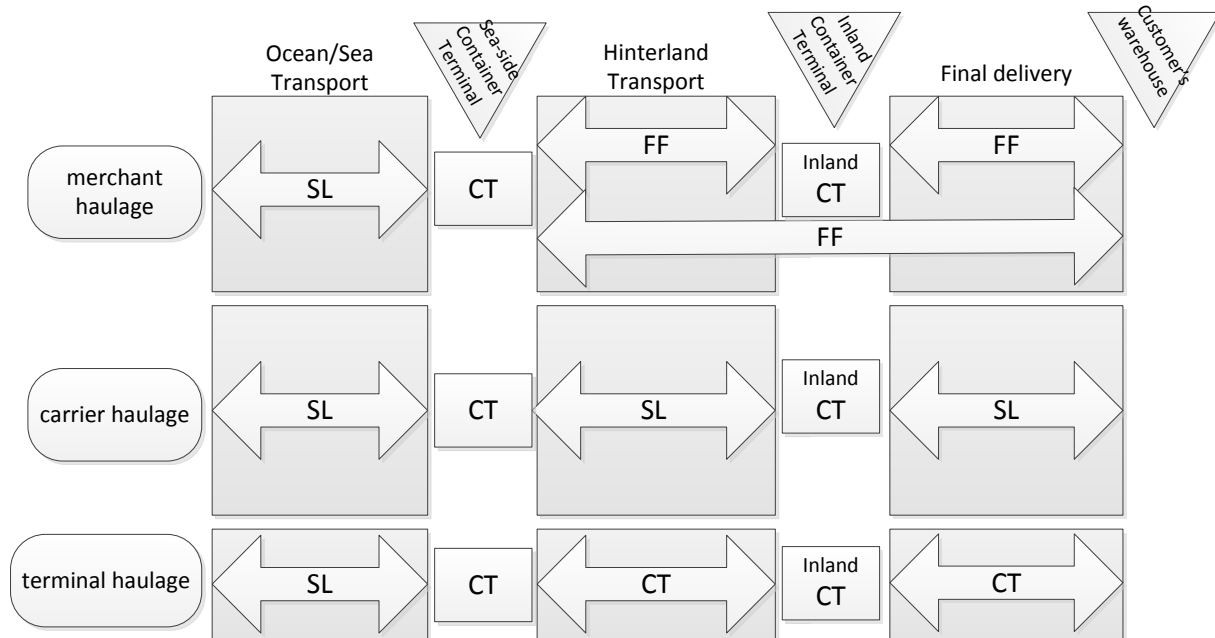

Figure 4: Responsible parties in hinterland container transport. SL=Shipping Line, FF=freight forwarder, CT=container terminal operator.

Merchant haulage

In merchant haulage, a freight forwarder or a logistics service provider manage the inland transport of the container until delivery at the customer's warehouse. The transport itself is mostly done by different companies. Freight forwarders are specialised in moving containers and they work for the shipper that wants his goods to be transported, logistics service providers add extra services to transportation activities. A company's decision whether or not to outsource logistics activities depends on a number of factors: e.g. economic considerations, demand fluctuations and availability of personnel and equipment (Alagheband, 2011, p. 83). Instead of organising transport themselves, companies often outsource it to third parties, so-called Third Party Logistics service providers (3PL). According to Berglund et al. (1999 in (Alagheband, 2011, p. 73)) Third-Party logistics activities include at least management and execution of transportation and warehousing. A wide variety of additional activities could be performed, such as: "freight consolidation and distribution, product marking, labeling and packaging, inventory management, traffic management and fleet operations, freight payments and auditing, cross docking, product returns, order management, packaging, reverse logistics, carrier selection, rate negotiation, and logistics information systems" (Alagheband, 2011, p. 74).

Carrier haulage

Traditionally, shipping lines in carrier haulage and freight forwarders in merchant haulage fulfilled the role of organising transport between the sea-side terminal and the hinterland (Frémont & Franc, 2010, p. 561). Shipping lines (carriers) are traditionally involved in the long-distance transport of containers in sea vessels. They have to deliver frequent services with high punctuality, reliability and large geographical coverage (Slack et al., 1996 in (Franc & Van der Horst, 2010, p. 561)). They have to deal with difficulties to warrant future revenues, and since economies of scale at sea reach their limits, shipping lines have to find new ways of increasing their revenues (Cullinane and Khanna, 2000 in (Franc & Van der Horst, 2010, p. 560)). A shipping line could expand its activities to the hinterland by either getting involved with an inland terminal or with intermodal transport, both are examples of vertical integration. A shipping line that owns a dedicated inland terminal will convince shippers more easily that it has the ability of securing container flows and offering reliable services. A more integrated transport chain also makes it easier for shippers, since the number of parties they will have to deal with is smaller.

Cargo owners that have a strong relation with a shipping line may also want to deal with this same firm in inland transport, instead of having to deal with third parties. They will prefer a "one-stop shop" rather than dealing with many different actors (Franc & Van der Horst, 2010, p. 561), which means that a shipping line that offers all of these services will have a competitive advantage. Vertical integration into the hinterland allows the shipping line to minimise logistics costs and increase competitiveness through differentiation. It will have the capability to discriminate in price and to better meet market requirements. Shipping lines adopted more 'aggressive' strategies in the hinterland and developed into much more demanding actors towards container terminal operators. There are fewer and bigger shipping lines and other cargo controlling parties in the hinterland.

Terminal haulage

Shipping lines develop inland transport services mainly to cope with unreliable services. Container terminal operators try to deal with the scarcity of space in their terminals as well as the lack of coordination with transport service providers (Frémont & Franc, 2010, p. 562). Shipping lines mostly integrated vertically, but container terminals particularly expanded their business by horizontal integration; reproducing their own core services at various geographical locations all over the world.

Terminal operation is increasingly done by multinational companies (Frémont & Franc, 2010, p. 561). Horizontal integration, getting involved with (multimodal) hinterland transport or with inland terminals, also offers container terminals new opportunities. Although traditionally shipping lines and freight forwarders organise the hinterland transport, horizontal integration also offers opportunities to container terminals. Terminal haulage is when the container terminal operator expands its activities into the hinterland and takes responsibility for the transport of the container from the transshipment in the side-side terminal to the delivery at the customer's warehouse. A main reason for a container terminal to expand activities to the hinterland is to find solutions for dealing with scarcity of storage capacity in the sea-terminal. It will be able to push containers towards the hinterland terminal, thereby liberating space in the sea-terminal. The organisation and control of transport flows into the hinterland and the development of inland terminals allows container terminals to commercialise transport. A container terminal could either own shares in companies that already deploy these activities or develop subsidiaries.

Extended Gate concept

The extended gate concept is an example of how a terminal operator can extend its activities into the hinterland. Here it is explained:

In the dry port concept there are several parties that could organise the transport to and from the hinterland terminal, however, in general this is not the sea-side terminal operator (Veenstra et al., 2012, p. 23). The extended gate concept, or extended container terminal gate concept, is based on the concept of a dry port and is like an inland terminal with extra customs facilities (Roso et al., 2009). The main difference between a dry port and an extended gate is the fact that in the latter concept it is the terminal operator who is in charge of the flow between the sea terminal and the hinterland terminal (Veenstra et al., 2012, p. 23). The definition of an extended gate is: "an inland intermodal terminal directly connected to seaport terminal(s) with high capacity transport mean(s), where customers can leave or pick up their standardised units as if directly with a seaport, and where the seaport terminal can choose to control the flow of containers to and from the inland terminal" (Veenstra et al., 2012, p. 21). It means that the delivery or pick up point, from the point of view of the shipper/receiver, is moved from the sea-terminal along a corridor to an inland terminal. It is as if the gate of the sea terminal has moved to the inland terminal. With the extended gate concept there is more emphasis on coordination and control of the container flows in the multimodal hinterland network. Transport flows towards inland terminals that act as an extended gate are more controllable which results in improved access to the sea-terminal.

The extended gate concept is supposed to have the ability to create benefits in modal shift, logistics performance and regional development (Veenstra et al., 2012, p. 14). Instead of waiting for containers to be picked up by truck, rail or barge, seaport terminals should be able to push blocks of containers into the hinterland, thereby alleviating congestion within the terminal (Veenstra et al., 2012, p. 15). Shortage of space in their sea-side terminal was a reason for sea-port terminal ECT to develop the extended gate concept. Often, clients let their container stay in the terminal for months before picking it up thereby causing full stacks. For clients the pick-up point changes from Rotterdam to Duisburg, which could be beneficial in two ways: the inland terminal is further inland, thus closer to the warehouse and it is likely that there is less congestion on the roads around the inland terminal than near the sea-terminal (Veenstra, personal communication, February 3, 2014).

The sea-side container terminal has a unique position in the transport chain which gives it an advantage over other actors in the hinterland transport chain. The container terminal has access to a lot of information to which other carriers do not have access. The terminal knows two days in advance when a vessel arrives, and it knows what containers are on the vessel and where. Inland carriers will normally know about the arrival of their container at a very late moment in time. Therefore they will start organising the inland transport at the moment the vessel has left the port, and valuable hours are lost. These problems can be omitted if the container terminal organises the transport leg between the sea-terminal and the hinterland terminal. This will give the terminal operator a strategic advantage, since it expands its activities and at the same time delivers more reliable services.

Merchant haulage and terminal haulage

On average 30% of the container transport in Europe is done with carrier haulage, the vast majority of the transport is done in merchant haulage (Transport Research Centre, International Transport Forum, & Organisation for Economic Co-operation and Development, 2009, p. 56). Merchant haulage is very dominant in the Benelux, and therefore it is part of this research. Terminal haulage is a relatively new concept, and since it is said to have some clear advantages that make it worth to research. Carrier haulage is not being studied in this research mainly because it represents only a small part of container transport. The disruptions scenarios that are studied are very relevant to MH and TH, but less relevant to carrier haulage. The first scenario is the delay of a sea vessel. In MH and TH, hinterland transport has to deal with the disruption, but the parties responsible for the hinterland transport do not always have the information about the delay. If the delay happens in carrier haulage, the shipping line know about its own delay and can adapt its own hinterland modalities to it. This makes the disruption less interesting to study.

For hinterland transport in merchant haulage, many different actors have to coordinate their actions to transport the containers. Within terminal haulage, the deep-sea container terminal operator has the responsibility over the hinterland transport and should have more flexibility in transport between the deep-sea container terminal and the inland terminal. This table shows the differences between terminal haulage and merchant haulage.

Table 1: Differences between TH and MH

	Terminal haulage (TH)	Merchant haulage (MH)
Customs	Customs facilities, in some cases, is transferred to inland terminal (Veenstra et al., 2012, p. 22).	Customs facilities situated in sea-side container terminal.
Modal split	Focus on multimodality, mostly train and barge, since these are cheaper than truck.	Trucks, barges and trains are used. The modal split from the Port of Rotterdam is T/R/B = 54/17/29% (IDVV, 2012, p. 27)
Inland terminal	Transport via inland terminal, since it has the function of storing containers.	Transport not necessarily via inland terminal.
Responsible party for inland transport	Transshipment and hinterland transport done by the container terminal operator, who controls the flows from the deep-sea container terminal to the inland terminal (Veenstra et al., 2012, p. 21). It can decide to transport the containers by	Transshipment and hinterland transport is done by different actors.

	either rail or barge and is more flexible	
Push or pull	Deep-sea container terminal operator “pushes” containers into the hinterland, i.e. it decides when containers are transported into the hinterland rather than waiting for the containers to be picked up (European Container Terminals, 2011, p. 17)	Containers are picked up by carriers that are not controlled by the deep-sea terminal operator. The containers are “pulled” into the hinterland by third parties instead of “pushed” by the terminal operator

2.4 Disruptions & Robustness

Containers that arrive by ocean vessels are transported from the terminal in the Port of Rotterdam into the hinterland. During the transport or during operations in the terminal all kind of disruptions can occur. Disruptions are unplanned and unanticipated events that disrupt the normal flow of goods and materials within a supply chain or transport network (Craighead, p132 in Svensson, 2000; Hendricks & Singhal, 2003; Kleindorfer & Saad, 2005). Some examples are the influence of severe weather conditions, accidents within the terminal, or breakdown of inland transport modes. There can be diverse causes for a disruptions and it can have different types of impact on the transport system. The intermodal container transportation system is a highly interconnected system where consecutive processes depend on each other. Different actors have to work together in order to transport the containers from point to point. Due to mutual dependencies between actors, their cooperation is crucial for ensuring efficient container transport. Delays in port operations, such as delays in container loading and discharging and vessel berthing, could cause delays further downstream the transport chain.

The intermodal transport system should not just be seen as a set of nodes in a supply chain, since it rather consists of integrated components. Transportation and logistics activities are often performed by different actors, all taking responsibility over their own activity. Disruptions that occur during sea transport or in the port will most likely have an impact on transport in the hinterland, and could even have worse and unwanted effects further down de supply chain (Loh & Thai, 2012). Due to the dependency on just-in-time supplies, global businesses have become vulnerable to disruptions. Even short disruptions may have considerable consequences. The transport chain is part of larger supply chains and therefore disruptions in transportation will also be visible in the rest of the supply chain.

Robustness and resilience

The success of a sea-port, including that of its terminals, no longer exclusively depends on the internal weaknesses or strengths. It is determined by the ability of all actors in the transport community to fully exploit synergies with other transport nodes and other actors within the logistics network (Notteboom, 2008, p. 7). The synchronisation of operational activities and improved efficiency in capacity utilisation will benefit the whole supply chain.

The extent to which the transport chain is able to perform when faced with disruptions is determined by its robustness. In general a system is robust if it is able to perform its intended function well with respect to uncertain future conditions. In relation to this research robustness of the intermodal transport system is about the system’s ability to continue its transport activities in case of unforeseen disruptions. In a broader sense, robustness is referred to solutions that perform well across a range of scenarios (Snyder, Peng, Lim, & Liu, 2011, p. 1192). A robust transport system is able to continue its activities under different scenarios of disruptions. Robustness is increased by the right design and

management of the system. Next to robustness, there is the term resilience that means ‘the ability of the system to return to its original state after a disruption’ (World Economic Forum / Accenture, 2013, p. 19). Resilience is defined by the ability of a system to change its operations and adapt itself to the new situation.

For the intermodal transport system to be robust, it needs to be designed and managed in the right way. The container transport system consists of a large number of actors. Even though they are aware of the disruptions occurring in the system, a single actor on its own is not able to increase the system’s overall robustness. According to Berle (2012, p. 48) actors in ports and in the maritime supply chain have a very operational perspective on supply chain vulnerability; their focus is mostly on frequent events rather than events with a low frequency but a high impact. And they focus on prevention rather than on response to disruptions. Prevention of disruptions is a first step, and the second step is to increase the robustness of the system. The severity of a disruption can be influenced by the way actors respond to it. An event disrupting a transport chain that has the capability to quickly detect and disseminate information on the event, is less likely to be severe than the same event happening in a transport chain that does not have the capability to warn (Craighead et al., 2007, p. 148). Due to the interconnectedness of the transport system and due to low cooperation among actors, the disruptions can have some negative consequences for the transport chain as a whole. Three main overall consequences are: loss of reputation, loss of profitability, and loss of reliability of the port or transport chain entities (Loh & Thai, 2012, p. 329).

Identification of disruptions

Disruptions differ in their cause and severity of impact. Gurning (2011, p. 40) defines four stages of severity of disruptions, which are explained here:

- *Delay*: focus is on recurrent changes displayed by performance of a service operation in the supply chain and the cancelation of previous planning by its institutions.
- *Deviation*: Deviation risks in supply chain services are mainly related to operational changes in service scheduling, upstream delivery processing, and the total quantity of cargo handled. It is about changes within the system boundaries.
- *Stoppage*: Some existing services become unavailable due to direct and indirect factors interrupting the services provisions
- *Loss of service platform*: The service platform is damaged and as a consequence, service operators in the supply chain are unable to provide their services due to the destruction of their logistic platforms or the unavailability of transport facilities.

The following table shows different disruptions that could occur during sea transport, sea-side terminal operations, inland transport and inland terminal operations. Certain disruptions can cause other disruptions. An attempt is made to separate disruptions that can be purely seen as a cause, and disruptions that are themselves an effect of a preceding disruption. Table 2 shows disruptions divided according to where they occur in the transport chain.

Table 2: Disruptions table, with input from (Loh & Thai, 2012), (Gurning, 2011, p. 50) and (Van der Horst & De Langen, 2008, p. 115).

	Sea transport	Sea-side terminal	Hinterland transport	Inland terminal
--	---------------	-------------------	----------------------	-----------------

Disruptions (causes)	<ul style="list-style-type: none"> - Severe weather conditions - Damage to vessel - Vessel accident - Maritime piracy 	<ul style="list-style-type: none"> - Cargo detainment - Customs IT system breakdown - Damage to/ breakdown of terminal equipment - Damage to terminal infrastructure - Fire - Electrical outages - Terrorist attack 	<ul style="list-style-type: none"> - Severe weather conditions: ice, extremely low/high tide - Damage to/ breakdown of barge/truck/train - Barge/train/truck accident - Damage to rail/truck infrastructure/locks/waterways 	<ul style="list-style-type: none"> - Damage to/ breakdown of terminal equipment - Damage to terminal infrastructure - Fire - Electrical outages
Disruption (causes & effects)	<ul style="list-style-type: none"> - Change or delay in sea vessel schedule - Loss of container during transport - Deviation of vessel routes - Vessel does not call at terminal 	<ul style="list-style-type: none"> - Delay in customs activities - Waiting lines for sea vessels - Barges: waiting time, due to vessels having priority for berths - Not enough tug & pilots boats available - Rail/Truck: Peak load on terminals; spread of terminal slots is not realised - Rehandling of containers (delay) - Insufficient storage space at container terminal yard 	<ul style="list-style-type: none"> - Congestion on roads/waterways - Delay in hinterland schedule rail/truck/barge - Deviation in cargo inland routes - Change in type of hinterland modality - Shortage of barge/truck/train - Rail/barge is full 	<ul style="list-style-type: none"> - Barges: waiting time for berth space - Rail/truck: Peak load on terminals; spread of terminal slots is not realised - Insufficient storage space at inland terminal
General disruptions	<p>Security issues, strikes, severe weather conditions, earthquake (but this is extremely rare in Netherlands), congestion (roads, waterways, within the terminal), Telecommunication/IT system down, no equipment/vehicle available due to bad planning, delay in sharing right documents/PIN of container. Increased costs: changing hinterland transport modality, higher dwell time.</p>			

2.6 Shared Situational Awareness & Information sharing

Disruptions in hinterland container transport chain are not mitigated efficiently due to a lack of coordination and cooperation among actors. Situational awareness – which is an actor’s correct understanding of the situation – is crucial for improving performance and reducing error (Naderpour, Lu, & Zhang, 2014, p. 325). In situations with a lot of actors and conflicts of interests, decision making is more complex and which makes it impossible for a single actor to understand the situation in its entirety (Kurapati et al., 2012, p. 47). This lack of ‘common operational picture’, or a lack of shared situational awareness (SSA), is the underlying problem of poor disruption mitigation. The coordination of actors and the efficiency of operations can be improved by being aware of the decisions and actions taken by other actors, so by increasing shared situational awareness (Joys, 2014, p. 7). This awareness of disruptions and the awareness of other actors’ decisions and actions also leads to better disruption mitigation capabilities (Craighead et al., 2007, p. 144).

Information sharing between actors is a major factor that contributes to shared situational awareness (Bolstad & Endsley, 2000). SSA emerges when parts of a system exchange information that is relevant to the situation (Sorensen & Stanton, 2013, p. 72). A high level of information sharing is linked with a high level of SSA and better performance of the system (Sorensen & Stanton, 2013, p. 72). The current poor performance in disruptions mitigation in hinterland transport can be improved by increasing the level of SSA, for which information sharing is important. Information that is needed to coordinate the transport chain plays a key role in controlling the propagation of disruptions through the transport chain (Li,

Veenstra, Yu, Zhao, & Zuidwijk, 2010, p. 264). Examples of the sort of information are: estimated time of arrival of transport modes, import declaration, container ID and details of the inland carrier.

The quality of information depends on the completeness, timeliness and reliability (Li et al., 2010, p. 265). Timeliness is about the delay of information exchange; when is the information available and when is it shared with actors that need the information for their activities? In a situation without disruptions the deviations in information delay may lead to physical delays of containers. Timely exchange of information can have a positive impact on counteracting the propagation of disruptions through the transport chain. Therefore the delay of information sharing plays an important role in case disruption occur.

3. CONCEPTUALISATION

The previous chapters provide an overview of hinterland container transportation and they explain different types of hinterland network configuration to transport containers from the sea-side terminal in the Port of Rotterdam to the customer. Inland container terminals play an important role in intermodal transport. These terminals are the connection between barge and rail transport and the last transport leg to the customer by truck. In merchant haulage, the organisation and responsibility is in hands of different parties. In terminal haulage the terminal operator takes the responsibility over the hinterland container transport.

A robust transport system is able to continue its activities under different scenarios of disruptions. To test the robustness of the two hinterland network configurations, the transport chain is simulation by means of a discrete event simulation model. Several scenarios of disruptions are used to gather results on the performance of both systems, and to compare them. This chapter explains what the system boundaries of the modelled system are, and describes the system as it is modelled in Arena and the differences between the TH and MH model, and it clarifies the assumptions that are made. Any disruption mitigating actions are not simulated in the simulation runs, since only the systems as such are to be compared.

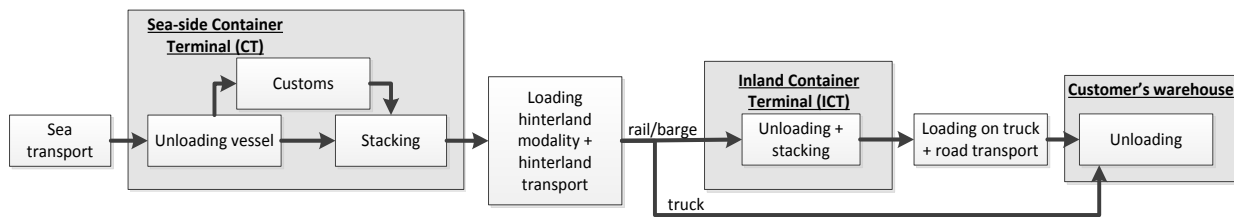

Figure 5: Hinterland container transport chain

3.1 System boundaries

1. General

The real-life system of intermodal transport of import containers from the Port of Rotterdam to the inland container terminal in Duisburg is simulated in a discrete event model in the software tool Arena. In a simulation model only parts of all aspects of the system can be built in, so the scope and boundaries of the model have to be chosen. The current model is based on the intermodal corridor from Rotterdam to Duisburg. Duisburg is chosen since it is in the Ruhr district and since it is a trimodal terminal where containers can be transported to by barge, rail and truck. If the values of parameters in the model are changed, the model can be used to simulate the transport system of any other intermodal corridor between any sea-side terminal and any trimodal inland terminal.

The transport chain is modelled from the arrival of the sea vessel until the unloading of the containers at the customer. There are two models, one for terminal haulage and one for merchant haulage, which are different in a number of aspects. The differences are explained in Section 3.3 Model structure. Some aspects of the system are left outside of the scope since they are the same in both the merchant haulage and the terminal haulage model and they will not make a difference in the results of the simulation runs. An example of such an aspect is customs activities.

In the model, the sea-side terminal as well as the inland terminal are operational 24 hours per day and 7 days per week, so there is no difference between day and night operations. The arrival day of a container is planned on a certain day, with disregard of the exact arrival time. This day is already planned at the moment the containers enter the model, and is not changed during the simulation run. The transport time of the container on the ocean is not modelled, only the time of delay, if any, is modelled.

2. Sea-side container terminal

A container enters the model by being unloaded at the sea-side terminal. In reality several vessels arrive on different moments during the day, each time carrying a different number of containers. In the model this is simplified to the arrival of one vessel per day with a fixed number of containers. After the arrival the vessel is unloaded and the container are placed in the right stack. Certain processes are not modelled: customs activities, moving containers within the stacks, and the activity of placing containers in the stacks. The focus of the research is on the hinterland transport network and therefore the processes within the terminal have not been modelled into detail. No attention is paid to capacity of quay cranes, terminal vehicles (such as rubber tired gantry cranes, RTGs) and container stacks, and no time is calculated for loading and unloading of hinterland modalities. However, the overall terminal capacity is taken into account through the fact that per day only a certain number of containers can be picked up and transported to the hinterland.

3. Hinterland transport

The containers are picked up by truck, barge or train from the sea-side terminal. There is no waiting time for vessels or for hinterland modalities: as soon as a modality arrives, the containers that it has to transport are assigned and directly picked up. After that, the modality departs with all containers that were assigned to it. Although loading of barges, trains and trucks takes some time in reality, it is not modelled. The difference between flexibility of the departure schedule of barges and trains is not modelled either. Barges are more flexible than trains. Once a train is loaded it has to wait for its specific time slot before it leaves, due to a tight schedule of the railway slots. Barges have a lot more flexibility; there might be other terminals where they have to call, but their schedule is less strict than for trains. However, these details for hinterland transport modalities are not modelled. Barges and trains arrive at the sea-side terminal, pick-up the containers that are assigned to them and leave for the inland container terminal. In practice there might not be enough capacity at the terminal to load and unload both vessels and barges. However, this is considered to be outside the scope of this research and is therefore no part of the model. The schedule of barges and trucks are not modelled, but instead the containers are picked up once a day (MH) or a number of times per week (TH). In MH several hinterland transport companies transport containers, but in the model the containers are not assigned to a certain transporting company. They are picked up once a day, regardless of which company transports them. Deviations in transport time from the sea-side terminal to the inland terminal are not taken into account.

4. Inland container terminal & transport to customer's warehouse

Containers arrive per barge or train at the inland container terminal, while containers that are transported by truck go directly to the customer's warehouse. In the inland terminal there are no stacks simulated, in reality there are stacks with a certain capacity, but this is not modelled. After arrival at the

inland terminal containers experience a fixed delay for their dwell time and a fixed delay for the transport by truck to the customer. In terminal haulage the container terminal operator decides when to 'push' blocks of containers to the hinterland terminal. There the containers will be stored instead of in the sea-side container terminal. However, the terminal haulage model only contains stacks at the sea-side terminal instead of the inland terminal. When during a simulation run a container arrives in advance at the customer's warehouse it would normally have been stored at the inland terminal until the trucks pick it up. Therefore in the TH model a container's early arrival means in reality that it arrives in time at the customer. For both MH and TH models the containers leave the model as soon as it arrives at the customer's warehouse.

3.2 Model structure

The two models used for this research differ in a number of aspects from each other, however, their basis is the same. This section describes the basic model and explains where MH deviates from TH. These differences are summarized in Table 1.

Before entering the sea-side container terminal

The model contains a "Day counter" that counts the number of the day, starting with number 1 on the first day. For gathering results of the simulation runs the model contains a module that writes the value of a number of variables to an Excel file. At the end of every day, an entity is created that first writes all variables to the Excel file before resetting them to zero. In this way all variables are recorded per day and refreshed daily.

In the model the vessels are created according to the vessel arrival schedule. Specific information, like for instance delay during sea transport and planned arrival day, must be assigned to vessels and containers. The information is assigned in two steps: first some information for the vessel, and later some information to individual containers. The following two attributes are assigned just after creation of the vessels:

- Creation day: the number of the day on which the vessel is created. This is elsewhere used to assign information to the container.
- Delay at the ocean: amount of delay with which the vessel will arrive.

Then the vessel physically arrives at the sea-side container terminal, where the containers are separated from the vessel. The following information is assigned to every container:

- Dwell time: the time that the container will dwell at the sea-side terminal is assigned by picking a value from the dwell time distribution, see details in Appendix A.
- Planned departure day from the terminal (only in MH): the day the container is scheduled to be picked up by a hinterland transport modality. This day is calculated by: creation day + dwell time + maximum unloading time.
- Hinterland transport modality: According to the modal split in MH and TH, every container is assigned to be shipped by either train, rail or barge.
- Unloading time: From a uniform distribution the value is picked that indicates the moment of unloading of the container after arrival of the vessel.

If a delay is assigned to the container, it will wait before being unloaded. After the containers are unloaded from the vessel, and before they are placed in the right stack according to their hinterland

modality, to each container (both MH and TH) the planned arrival day at the customer's warehouse is assigned. This is calculated as the departure day from the terminal + number of days needed for inland transport. The number of days that are needed depend on the hinterland modality. The specification of this can be found in Appendix C.

At the sea-side terminal

The container is placed in a stack according to the hinterland modality that it has been assigned. In the TH model the containers for barge and rail transport are placed in one single stack, while the MH model one individual stack for each modality. The pick-up procedures for MH and TH are also different:

MH: For the barge and train stacks the container can only be picked up on the planned day of departure from the sea-side container terminal. If the container is delayed and the planned day of departure has already passed, the container will either be rescheduled to be picked up by a different train or barge (based on a certain probability), or it will be rescheduled to be picked up by a truck. The probability of rescheduling a container to be transported by another train or barge depends on an assumption of how much barge and rail space is not utilised (see Appendix D). If the container is rescheduled, it is placed in the 'stand-by' stack for rail and barge. If not, it is picked up by a truck to be transported directly to the customer.

TH: In the TH model there is no planned day of departure from the sea-side terminal assigned to the container. The hinterland transport is organised by the terminal operator and this allows for more flexibility in the planning of hinterland transport. The containers are assigned a planned day of arrival at the customer's warehouse, rather than a planned day of departure from the sea-side terminal. The barges and trains operated by the sea-side terminal run according to a fixed schedule. Every time they arrive at the sea-side terminal, they pick up as many containers as possible from the stack. The most urgent containers – of which the planned arrival day at the customer is the soonest – are picked up first from the stack. The stack is composed of containers that will be transported by either train or barge. The specific modality by which a containers will be transported is not assigned in advance.

Both in MH and TH the container experiences a dwell time that each container gets assigned before entering the sea-side terminal. A container in MH can only depart from the terminal after this dwell time has elapsed, since that is the planned departure day from the terminal. In TH, however, the container can be picked up as soon as it is placed in the stack, and at the latest just before its dwell time is over. The dwell time that is used can be found in Appendix A.

Hinterland transport

Every time a truck, train or barge arrives at the sea-side terminal a separate search-mechanism creates an entity that searches through the corresponding stack and picks up the containers that are planned to leave the terminal according to the search criterion. These containers, both on time and delayed, are temporarily placed in virtual departure stacks.

Since there is a maximum capacity of the container terminal, the search entity first searches for the non-delayed containers, and then searches for delayed stand-by containers until the maximum capacity of that day is reached. Before picking up the containers, the modality entity waits 1 minute to make sure that the search entity has placed all containers in the right virtual departure stack. After pick-up of the

container, there is a transport delay after which the containers are dropped-off at the inland terminal or the customer's warehouse. MH and TH differ in their pick-up procedure.

MH: In MH, several companies are responsible for hinterland transport. They all have different schedules for their barges and trains, and every barge and train transports a different number of the containers from the terminal in Rotterdam to Duisburg. Instead of modelling separate trucks, barges and trains that each pick up their own containers, one single entity is modelled that picks up all containers for that day. This has been simplified because if the system works as supposed, containers will be picked up according to their schedule. Therefore there is no need to model each modality separately, and it is sufficient to model a system that picks up all the containers every day. The sea-side container terminal has a maximum capacity per day for each type of hinterland modality. After arrival at the inland terminal the containers are dropped off and the truck, barge or train is disposed. All containers will dwell for a certain period of time in the inland container terminal. After this they experience a delay that is equal to the time of transport from the inland terminal in Duisburg to the customer's warehouse in the Ruhr district. Upon arrival at the customer's warehouse, the containers are disposed from the model.

TH: Every day an entity is created that represents all trucks that pick up containers from the sea-side terminal. The pick-up procedure by truck is modelled in the same way as in the MH model, but the pick-up procedure by barge and train differs. In the TH model the containers arrive in the one stack from which both barges and trains pick up containers for hinterland transport. This stack is ordered according to the day of planned arrival at the customer's warehouse. The containers leave this stack to be picked up by rail, barge or truck. Rail and barge transport regular containers while trucks only transport containers that are behind on schedule.

In this case the container will be transported to the customer by truck. In TH barges and trains depart from the terminal according to a pre-planned schedule. Upon creation of a barge or train entity a search mechanism starts to search and pick up containers from the barge/rail stack, until the maximum number of container on the train or barge is reached or until the stack is empty. The barge or rail entity picks up its containers and drops them off at the inland container terminal, after which the transport entity is disposed from the model. In TH there is a maximum terminal capacity for the truck terminal, but not for the barges and trains, because they are restricted by their capacity per train or barge.

Throughout the model there are several modules for gathering data that are written to an Excel file. These modules are explained in Section 4.3 Key Performance Indicators.

3.3 Assumptions

The boundaries of the system indicate what the scope of the model is. While building the model, assumptions are made, which are clarified in this section.

General and Sea-side terminal

- In TH all containers are assumed to be planned for transport to the inland terminal by barge and train, whereas in MH there is a different modal split and a large share is transported by truck.
- The dwell time is used to calculate each container's planned departure day and planned arrival day. This dwell time distribution that is used is from the research of Jie Lu (Appendix A), where it is based on the Actual time of arrival (ATA) of containers at the terminal. However, in this model the dwell time is used for the Expected time of arrival (ETA).

- In case of a delayed container that has to be changed from barge or train to truck, the container has an additional delay of 1 day due to extra planning efforts.

Hinterland transport

- In this model there is no limitation to the number of trucks available for container transport. Whenever a truck is needed, it will be available. There is, however, a maximum to the number of containers that can be picked up per day due to the maximum terminal capacity.
- If a container is transported by truck from the sea-side terminal, it will go directly to the customer's warehouse (not via de inland terminal).

4. MODEL SPECIFICATION

This chapter elaborates on the description of the model structure from Section 3.3. It explains in detail how some specific parts of the model are built, and from what sources the input data are derived (Section 4.1). The three scenarios that are used to test the performance of TH and MH are described in Section 4.2 while the key performance indicators are described in Section 4.3.

4.1 Building block description

This section clarifies how parts of the model are built. Appendix C presents with the used data, like the number of containers that are shipped per day and the number of barges and trains, along with some formulas from the model.

Dashboard

A dashboard is created to allow for easy on and off switching of the scenarios in the simulation model. By means of switching a delay module on and off a scenario is activated or not. The dashboard also controls the number of containers arriving at the terminal each day and whether or not the arrival of ocean going vessels is randomised.

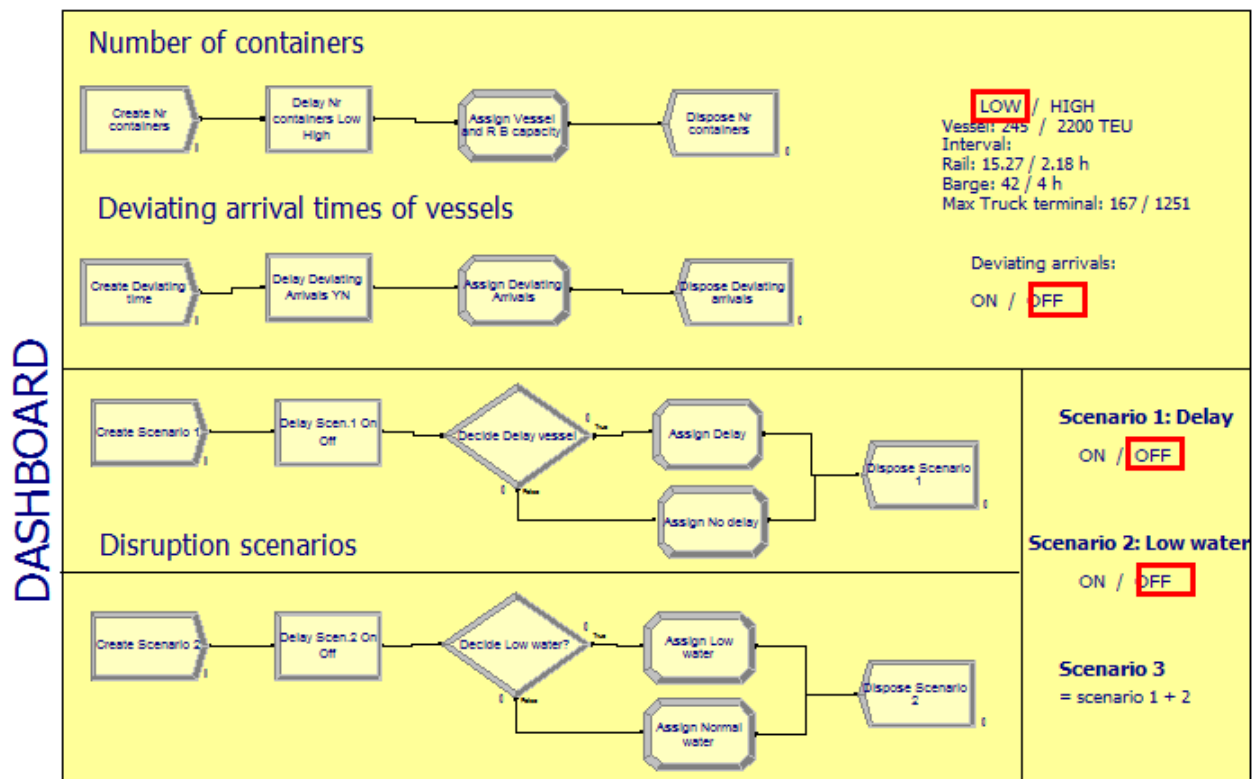

Figure 6: Image of Dashboard

Internal processes at sea-side container terminal

The MH and TH model are similar until the containers are placed in the stacks. Containers are unloaded with a duration that is uniformly distributed between 0 and 24 hours. According to the planned modality the container is assigned its planned arrival day, and is placed in the right stack. In the MH model there

are three stacks, one for each modality and in the TH model there are two stacks of which only one is used for combined storage of rail and barge containers. The last pick-up day for both TH and MH is the last day on which containers can still arrive on the planned arrival day at the customer. This depends on the time the modality needs for the transport of containers from the sea-side terminal to the hinterland. In MH the containers can be picked up only on the planned day of departure, in TH the pick-up can be done from the day that a container is placed in the stack.

In MH, if containers are not picked-up on the planned departure day, they go through a decision module where each container has a certain probability of being rescheduled to a train or barge the next day. In TH there is no such mechanism, and if containers are not picked up in time, they are transported by truck directly to the customer.

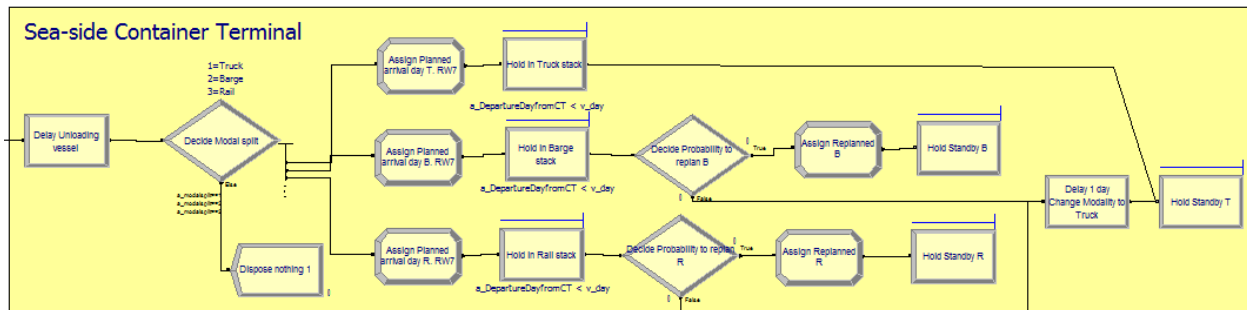

Figure 7: Image of processes at sea-side container terminal in MH model

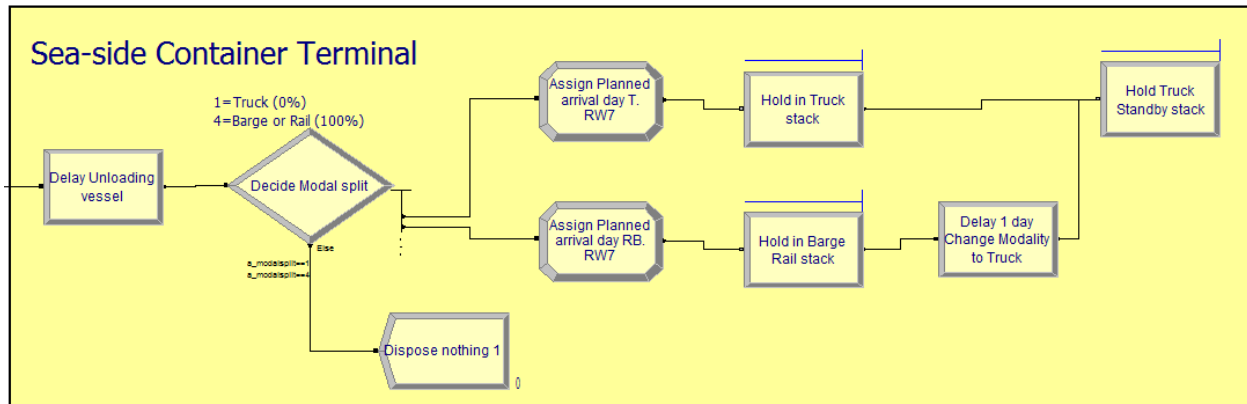

Figure 8: Image of processes at sea-side container terminal in TH model

Pick-up of containers and transport by hinterland modality

Every day trucks, trains and barges arrive at the terminal to pick up containers. Upon arrival a search entity is created that searches for the right containers to be picked up by, in the case of Figure 9, a train. This search mechanism is explained in the next paragraph. While the search entity is searching, the train has to wait a virtual time of 1 minute to make sure it will pick up the containers after the search entity has finished its work. The train picks up the 'normal' and stand-by containers from the two stacks, these numbers are recorded in a variable that will be written to an excel file. After transport to the inland terminal the containers are dropped off. The final hinterland modality is assigned to each container, to

be able to calculate the number of containers that is transported per modality. Upon arrival at the inland terminal the hinterland modality is disposed from the model.

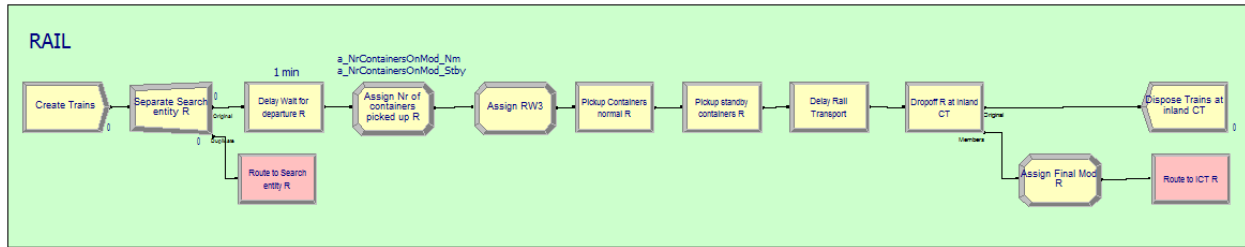

Figure 9: Example of pick-up processes for Rail

Container search mechanism

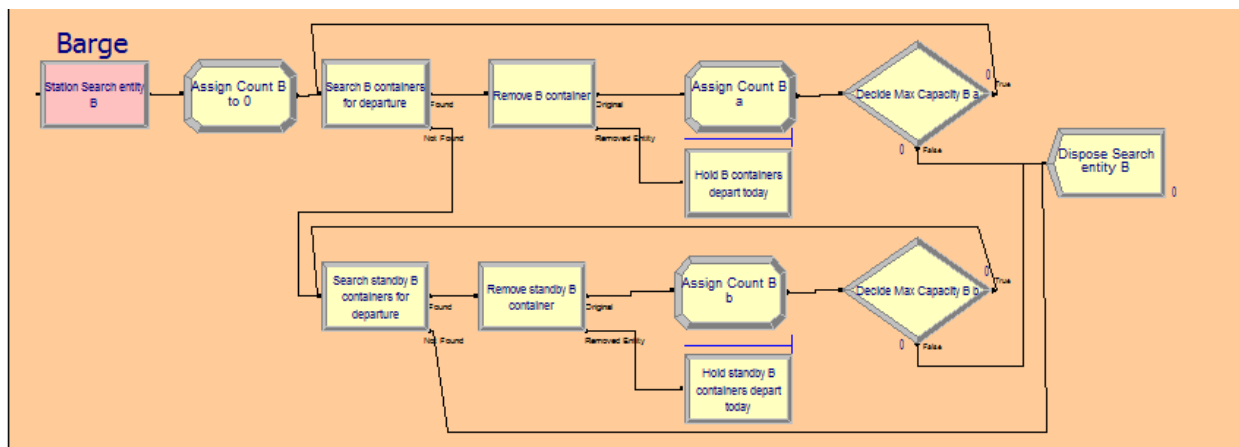

Figure 10: Container search mechanism

In the model a mechanism is built in that searches for the right containers to pick-up. The search entity is created as soon as the hinterland modality arrives at the terminal: barge, train or truck. The barge search mechanism is taken as an example. In the merchant haulage model all containers that need to be picked-up today are searched for. The variable for the number of containers to be searched for is set to 0 before the searching starts. Then the barge stack is searched for containers of which the departure day is today (MH) or for any container in the rail and barge stack, starting with the container of which the planned arrival day at the customer is the soonest (TH). The container is removed from the stack and placed in the Hold for departure today. One container is added to the counter after which the decide module checks whether the number for that day is already reached or not. If so, the search entity is disposed from the model, and if not, the searching starts again. This process repeats itself until there are no more containers that fulfil the search criteria, the search entity starts searching through the stand-by stack with delayed containers. In TH only the trucks can search through a truck stand-by stack, as this does not exist for barge and train. This searching goes on until either the maximum number is reached, or the stacks are empty. If scenario 2 (low water level) applies, the maximum number of containers that can be picked up is only 25% of the normal value.

4.2 Scenario study

Merchant haulage and terminal haulage will be compared based on their robustness for disruptions. A scenario describes which disruption occurs and under what circumstances. From the three different scenarios that are formulated, scenario 3 is a combination of scenario 1 and 2. The following aspects are described for each of the three scenarios:

- Background information
- Expected effect
- How it is modelled

For each of the three scenarios the disruptions the following is described: some background information, what could be the effect of the disruption and how it is modelled in the simulation model.

The tables with details of the scenario runs can be found in Appendix C.

Scenario 0: No disruptions

This is the basic scenario where no disruptions occur.

Scenario 1: Ocean: Delay sea vessel

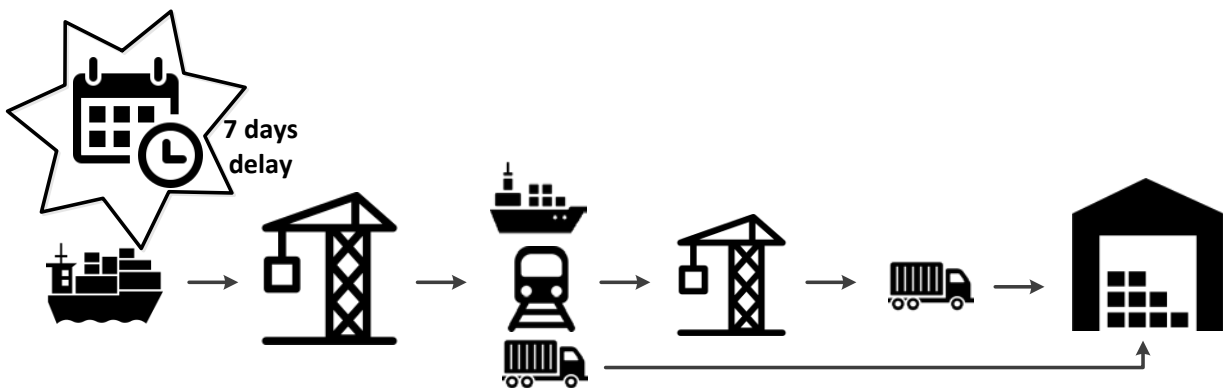

Figure 11: Scenario 1

Background

During normal operation of the sea-side terminal, it is very common that vessels arrive with some deviation from the planned arrival time. For example, at the carrier MOL, vessel arrival within 24 hours of the scheduled arrival is even considered to be “on time” (MOL, 2015). A group of carriers is never on time and delays of 2 or 3 days are no exception (Lang & Veenstra, 2010, p. 478). The top-20 carriers are mostly in the category that is on time 50-60% of the time. Delays of 70 hours on arrival at major European ports such as Rotterdam, Hamburg and Antwerp have been reported (Gateway Logistics Group, 2014). Delays of 70 hours or more are seen as typical for ports in northern Europe.

The effect of delay of vessels on merchant and terminal haulage has to be investigated, because in practice little joint planning is done by the terminal and shipping line. Shipping lines announce their expected arrival time without reference to the schedule that has been pre-agreed on by the container terminal and the shipping line during the contract negotiation stage (Lang & Veenstra, 2010, p. 478).

Expected effect

The effect of this disruption depends partially on how many days the vessel is delayed. The containers that are unloaded from the vessel will dwell for a certain period of time until they are picked up from the sea-side terminal by one of the three hinterland modalities. If the container arrives with a delay that is longer than the assigned dwell time of the container, it will miss its hinterland modality. If that modality is either train or barge the container will be rescheduled to be transported by truck to the inland container terminal. The overall modal split changes towards a larger share for truck transport. Nothing will happen in the model if the delay that a certain containers has is shorter than its assigned dwell time; it will just dwell shorter than planned.

Model

Vessel delay is assigned just after creation of the vessel in the model. The vessel experiences a delay module before it arrives at the terminal where the containers are unloaded. The delay could either apply to one vessel to test the effect of one delayed vessel (of 7 days), or all vessels could arrive with each a different delay.

Scenario 2: Rhine: Low water level

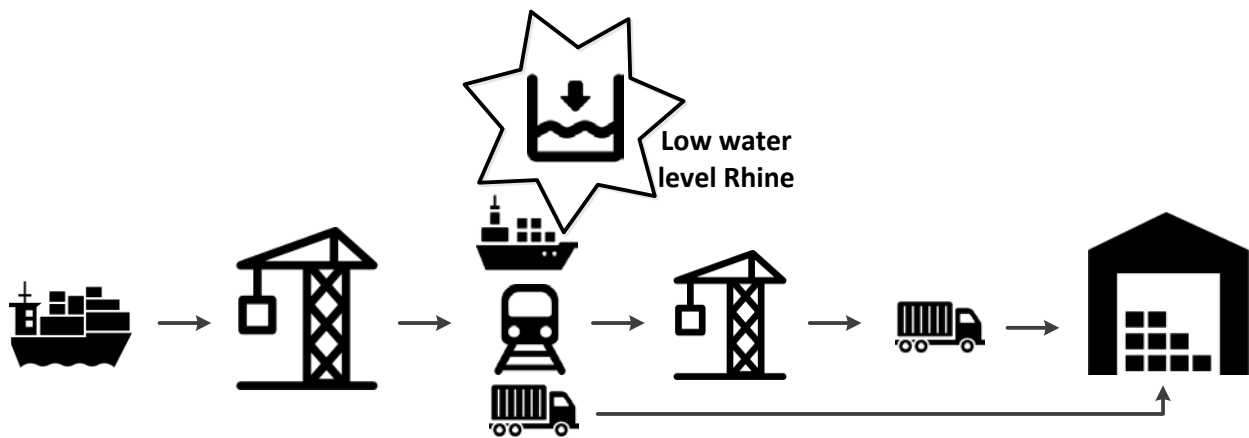

Figure 12: Scenario 2

Background

Barge transport via inland waterways is much affected by the level of water in the inland waterways. The Duisburg container terminal is situated along the Rhine, which is the main waterway between Rotterdam and Duisburg. Both an extremely low and high water level cause sailing restrictions. This scenario is about low water levels in the Rhine. According to Bosschier (2005, p. 41) there are four possible effects of a low water level of the Rhine: no sailing is allowed, sailing at a later moment in time, sailing a different route, or sailing is only allowed with capacity restrictions. Depending on the conditions and the exact water level the effect can be different. This scenario sailing with capacity restrictions: barges that sail to Germany can only be loaded with 25% of maximum load.

More barge movements to Germany would be needed to transport the same number of containers. In reality barge owners have to be

compensated financially, so for them this situation is not necessarily negative, since it could mean an increase of turn-over (Bureau Voorlichting Binnenvaart, 2015). Low water level therefore causes the transport prices to fluctuate (Menkveld, 2013). In this scenario the number of barges that sail stays the same during the disruption, to be able to test the influence of capacity restrictions.

Expected effect

In case of a low water level, depending on the actual level, barges are either allowed not to sail or to sail with less than their maximum capacity. In this scenario barges are allowed to sail with a maximum capacity of 25%, for as long as the water level is low. In the simulation model less containers are transported by barge. In the merchant haulage model this means that the rest of containers have to be transported by truck, instead of by barge as originally planned. The terminal haulage model is more flexible: part of the containers that cannot be transported by barge are automatically transported by trains. If the maximum capacity of the trains is reached the rest will rescheduled to be transported by truck. The expected effect of the low water level in both cases is a large change in modal split.

Model

MH: In the merchant haulage model all containers that are planned to be picked for a specific day are picked up all at once. Separate barges, trains and truck schedules are not modelled, but all the containers are picked up once a day from the terminal. In a non-disrupted situation, the maximum number of container to be picked-up per modality is calculated by: ‘the number of containers entering the terminal’ × ‘modal share of modality’. In case of the low water level, this number of containers for barge is multiplied by 0.25 to calculate the current number of containers that can be picked up by barge.

TH: In the terminal haulage model the separate barges and trains are modelled according to their schedules, each individual barge and train has its capacity defined. During the low water level every barge can only transport 25% of its maximum capacity of 208 TEU.

Scenario 3: Combination scenario.
Combination of scenarios 1 & 2.

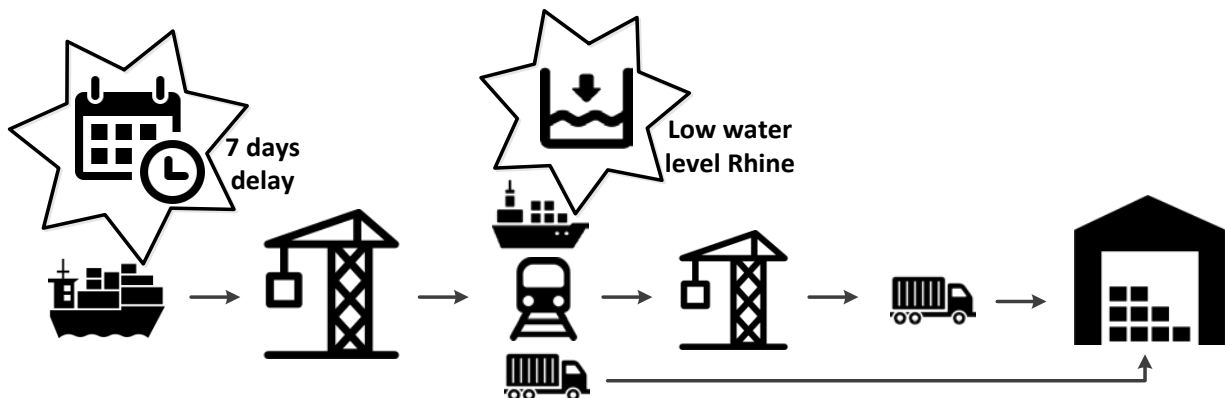

Figure 13: Scenario 3

4.3 Key Performance Indicators

The key performance indicators (KPIs) are used to measure the performance of the system and to make it possible to compare merchant haulage with terminal haulage. The key performance indicators are measured during multiple runs of the model, under different circumstances. The following key performance indicators have been identified.

1. Number of containers in stack at sea-side container terminal
2. Number of containers that have to be rescheduled
3. System recovery time after disruption

In Appendix B the overview of what is measured during the simulation runs can be found.

1. Number of containers in stack at sea-side container terminal

Description

In reality the sea-side container terminal has a maximum capacity for its stacks. This maximum capacity is not part of the model, but the number of containers in the terminal stacks is an indicator of how well the system performs. If vessels arrive, transporting container into the terminal, but the containers are not picked up in time by hinterland transport modalities, the stack will grow until there is a shortage of space in the terminal. The sea-side container terminal also functions as a decoupling point between the ocean transport and hinterland transport. Thereby it could help minimise the effects of a disruption, but this has its limits.

Measurement/calculation

The number of containers in the stacks of the sea-side container terminal is measured every day at the end of the day at 23.59h.

Merchant haulage model:

- Truck/Train/Barge normal stacks
- Truck/Train/Barge stand-by stacks

The values of these 6 stacks have to be added to calculate the total number of containers in the terminal.

Terminal haulage model:

- Truck and Train/Barge normal stacks
- Truck stand-by stack.

2. Number of containers rescheduled to truck

Description

In both models, MH and TH, the modal split has been predefined. The number of containers that is transported by train, truck, and barge has been planned in advance. However, in case of a disruption containers could have to be rescheduled to be transported by truck instead of barge or train. If a container is delayed, or if it is not picked up in time it will be rescheduled to a later train or barge, or to truck. In the MH model to be 'not picked up in time' means the container was not picked up on the planned pick-up day. In TH there is no such planned day but if the container exceeds the day on which it

has to be picked up to be delivered on time, it is rescheduled to truck. Containers in de model will in most cases not arrive with a delay at the customer's warehouse, since they are transported by truck which is much faster, but more expensive. The lower the number of containers that is rescheduled, the lower the overall costs will be.

Measurement/calculation

The modal split is measured by recording by which modality each container was transported. This is recorded upon arrival of a container at the customer's warehouse. Every day the number of containers that is transported via the three modalities is recorded. However, just the modal split does not give much information about the situation. A disruption on one day does not change the modal split that is calculated from day 25 to 60. Therefore the number of containers that have to be rescheduled, either to their own modality or to truck, is recorded. This number gives better information on the magnitude of the disruption than just the modal split. These values are measured:

- The total number of containers that has to be rescheduled
- The number of container that is transported by truck instead of rail/barge

3. System recovery time after disruption

Description

This research is on the robustness of hinterland container transport. Disruptions in the transport chain have an impact on the performance of the transport chain for a certain period of time. In some cases the effect of the disruption might be visible for a longer time than in other cases. Therefore this indicator provides insight into how well the system performs in case of a disruption.

Measurement/calculation

The number of days is counted from the end of the disruption until the transport system is working as it was until the moment a disruption occurred. The parameters that indicate whether the system performance is back to normal, are the following:

- The number of containers in sea-side terminal stacks
- The number of rescheduled container transported by truck/barge/train.
- Average delay per container

5. VERIFICATION

Verification is done to ensure that the model has a logical structure, and to eliminate mistakes and errors. Validation of the model is difficult due to a lack of reference data. Validation of the model is not performed due to a lack of reference data.

Simulation time and warm-up period

The model runs for 60 days and the first 25 days are considered to be the warm-up period. The results of the model during the warm-up period are not taken into account for analysis. This period is needed because at the start of a simulation run the stacks at the sea-side container terminal are empty. After some period of time the number of containers in the stacks increases until it stabilises.

Figure 14 shows the number of containers in the sea-side terminal stack in MH, while Figure 15 shows the stacks in the TH model. At the beginning of the simulation run the stacks are empty. In MH the stacks grow until they reach a more or less stable number of containers. In TH the number of containers in the stacks is much lower and deviates more, due to the barge and train pick-up scheme. The repetitive nature shows a stable behaviour.

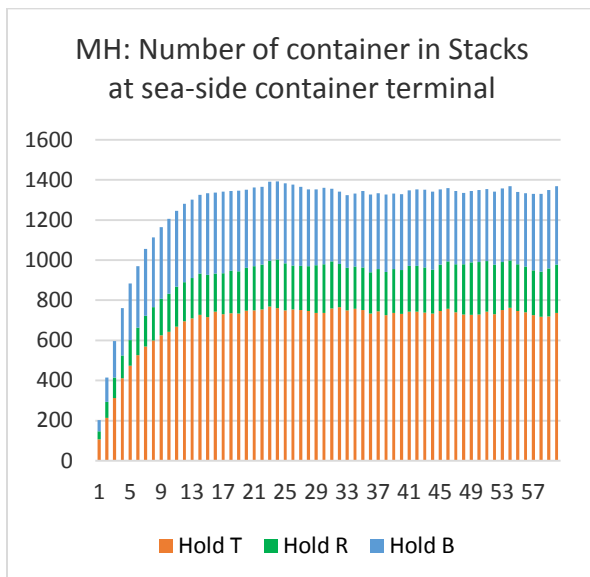

Figure 14: Sea-side container terminal stacks (MH)

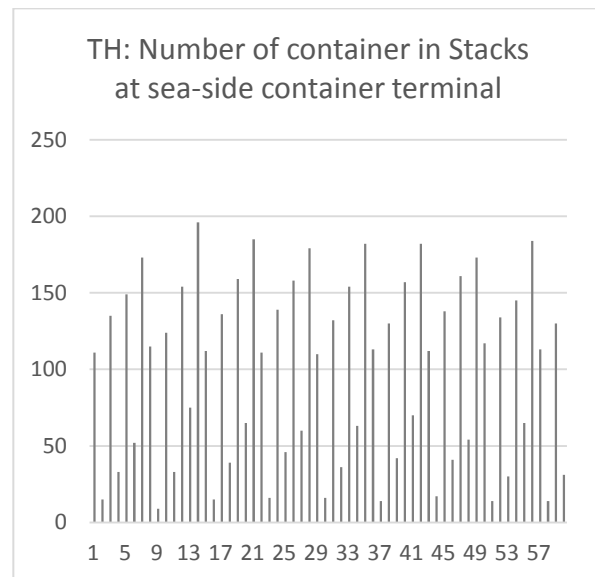

Figure 15: Sea-side container terminal stacks (TH)

This section describes the results of the structured walkthrough that was performed for the verification of the model. The structured walkthrough is done in two ways: during the process of modelling errors were found, and after finishing the model it was checked step-by-step.

Structured walkthrough

Some mistakes were made during copying parts of the model. For example when a certain structure that was built for trains to pick up containers was copied to be also used for container pick-up by barges. Since variables are often the same for rail, truck and barge, they have names such as `v_TransporttimeRail`, `v_TransporttimeBarge`, `v_TransporttimeTruck`. It happened that while copying these names were accidentally not changed. In some cases this would lead to an error from Arena, in other cases the model would still function, however, not with the right values. An example is the

variable “Hold B containers depart today.Queue” that was copied wrongly to the rail pick-up part of the model, although B stands for barge. The train would pick-up the containers from the barge container stack instead of its own rail container stack, which inevitably leads to errors in the model. Elsewhere in the model the variable “v_Modalsplit Rail” was erroneously used instead of “v_TransporttimeRail”.

Since they are the input for search mechanisms for container pick-up, formulas need to be defined correctly. A formula defines from when till when a container can be picked up for transportation. Miscalculation caused the barges and train to leave without any containers. Wrong formulas are an example of a human mistake, but other mistakes were caused by the way Arena software works. On some days a hinterland modality did not pick any containers, although it was scheduled to do so every day at 0.0h. It turned out that on one day the modality picked up nothing and on the other days it picked up twice the load. Changing the pick-up time to 0.1h solved the problem.

In this research the performance is tested of the transport chain under 4 scenarios. Comparison of the scenarios is only possible if in each scenario the random values that are assigned to some variables are the same. In four modules of the simulation model the seeds were defined to make sure that in every scenario run the same values would be assigned to the variables and attributes. The four modules are: deviated arrival times of vessels, assigning modality to containers, assigning unloading time to containers, assigning dwell time to containers. Without these fixed seeds each simulation run has slightly different results, which make comparison difficult.

The simulation model without its results would be useless. For gathering the values of the model’s parameters, “Read-write” modules write the requested information to the Excel file every time an entity passes by the module. After the Read-write modules were added to the model it ran for about 1:15 hour. This was much longer than when no data was written to the Excel file. It turned out that it was too time consuming to write the data of every single container to Excel, because Arena would open a large file again every single time it had to write data. The solution was not to write data for every single container, but to first calculate the aggregated data before writing to Excel. The model was changed and now calculates the average delay of the container of 1 day before writing it, or it calculates the total number of containers transport on that day.

The Read-write modules did not work perfectly in some cases. For example when the recorded results in Excel would show that no container was transported by rail or barge, although the containers did arrive at the customer via the inland terminal. It was clear that something was wrong with the recording of the values. The number of containers recorded in the Excel sheet was that of the last barge and train of the day, not the accumulated number of all barges and trains of that day. If the last barge or train was empty, the number 0 was recorded in the Excel sheet. This has been changed so the correct number of containers is recorded.

The Read-write modules record the data at the end of the day, the time was set on 0.00h. Just as with the arrival of barges and trains, on some days Arena would record twice and on others day not at all. Changing the time the Read-write modules would write their data to Excel to 23.59h solved this problem and the data are now recorded daily.

Extreme values test

The extreme values tests that were performed, are elaborated on in Appendix E: Verification tests. These are the tests:

- A. High number of containers arrive with each vessel at the sea-side terminal: 2000 per day.
- B. Transportation time for rail containers is extremely long: 30 days.
- C. No trucks available during scenario 1 (delay of 1 container)
- D. Only 1 container enters the simulation model.

In addition to the extreme values tests, Appendix E shows that in the S0 scenario runs without disruptions, operations go according to plan.

6. RESULTS

This chapter shows the simulation results that are generated by running both models, merchant haulage and terminal haulage, in combination with the following scenarios:

Scenario 0: No disruptions.

Scenario 1: Vessel delay of 7 days: vessel arrives on day 43 instead of 36.

Scenario 2: Low water level in Rhine from day 30 to 36.

Scenario 3: Combination of scenarios 1 and 2: delayed vessel arrives on day 36 instead of 29, and low water level from day 30 to 36.

This chapter presents the analysis of the influence of the scenarios on merchant haulage (Section 6.1), and on terminal haulage (Section 6.2). Section 6.3 looks at the differences in ability of terminal haulage and merchant haulage to deal with vessel arrival times that deviate from planning.

All simulation runs have a warm-up period of 25 days, only after the warm-up period the disruptions are simulated. Per day 208 containers arrive by vessel at the sea-side container terminal. For each scenario its influence on the performance of the model is explained, and this will be summarized for each of the 3 KPIs, as is explained in Section 4.3:

1. Number of containers in stack at sea-side container terminal
2. Number of containers rescheduled to truck
3. System recovery time after disruption

The graphs to which is referred to in this chapter can be found in Appendix F.

6.1 Merchant haulage

Scenario 1 (S1) – delay of a vessel

Graph 13 shows the delay of the vessel that arrives 7 days late. In the container stack (graph 17) are temporarily less containers, but this number is back to normal on day 44 which is the day after the arrival of the vessel at the terminal: the unloading of containers takes between 0 and 24 hours. Part of the containers that arrive on day 43 will arrive too late for their planned pick-up day, to be more precise: only the containers that have a dwell time of 7 days and shorter cannot be picked-up on their planned day by the planned hinterland modality. They are placed in the stand-by stack (graph 18). All other containers experience no delay.

If there is spare capacity, part of the stand-by containers are rescheduled and transported by the originally planned modality. For rail and barge containers, the percentage of delayed containers that can be rescheduled is set to 20%. The number of rail containers that are rescheduled by rail can be seen in graphs 15 and 27, and for barge this is in graphs 16 and 28. The numbers are low; 5 and 7 containers. The rest of the containers have to be transported by truck, see graphs 14 and 26.

The average delay upon arrival of containers at the customer is longer for containers transported by barge and rail (via the inland terminal) than for those directly transported by truck. In total 128 container have to be rescheduled (see Table 3), of which 47 containers changed from barge or rail to truck.

It takes about 7 days for the system to return to normal operation after the delay of the vessel. Graph 21 shows that the last rescheduled containers by truck arrive on day 50. Calculated from the day of arrival of the delayed vessel, the recovery time is $50-43=7$ days.

Table 3: Overview KPIs for MH scenario 1

S0	Number of container in stacks in Scenario 0	Normal stack Average: 1347		Stand-by stack Average: 0	
KPIs	1 Containers in stack	Normal stack		Stand-by stack	
		Deviation	max. 209 less	Nr. in stack	max. 104
	Recovery time	N/A	Recovery time	4 days	
	2 Rescheduled containers	Not transported by		Rescheduled to	
		Barge	41	Barge	7
Rail		18	Rail	5	
Truck		69	Truck	116	
<i>Total</i>	<i>=128</i>	<i>Total</i>	<i>=128</i>		
3 System recovery	7 days				

KPI 1: During the 7 days delay, there are less containers in the normal stack that has an average of 1347 in scenario 0. At the maximum in scenario 1 there are 209 container less. As soon as the vessel arrives, the delayed containers are placed in the stand-by stack that contains at its maximum 104 containers. This stack becomes smaller in the next days since the containers are rescheduled and transported by their original modality or by truck.

4 days after the arrival of the vessel the stand-by stack returned to be empty.

KPI 2: In total 128 containers are rescheduled, of which 47 changed from barge or train to truck.

KPI 3: The overall system recovery time is 7 days, calculated from the arrival day.

Scenario 2 (S2) – low water level inland waterways

During 7 days the water level of the Rhine is low, so the capacity of barges is restricted to a maximum of 25%, as can be seen in graph 32. During this period the number of containers in the stack grows (see graph 33), which is best visible in graph 41 that shows the difference between S2 and S0. There are about 35 to 45 more containers in stack per day than in the S0 scenario. The stand-by stack (graph 34) grows until the last day of the low water level, then the stack size decreases. For rail and barge containers, the percentage of delayed containers that can be rescheduled is set on 20%. The number of barge containers that are rescheduled by barge can be seen in graphs 32 and 44. Since this scenario only affects barges, there should not be any difference between the number of rail containers transported in S0 and in S2. However, graph 43 shows a very small difference, but that is most probably due to values being rounded by Arena. The number of containers that is rescheduled and transported by truck is shown in graphs 30 and 42. The numbers per day fluctuate since transportation of stand-by containers depends on the available capacity. Between 1 and 36 containers are transported per day by truck during the recovery period of the system.

The modal split for T/R/B is 58/17/25%, whereas the planned modal split was: 54/17/29%, so less containers are transported by barge, and more are transported by truck. Of the 265 barge containers that had to be rescheduled, 203 were rescheduled to be transported by truck instead of barge. The last

day of the disruption is day 36. It takes until day 44 (see graph 39) for the system to be performing the same as before the disruption. The recovery time is 44-36=8 days.

Table 4: Overview KPIs for MH scenario 2

S0	Number of container in stacks in Scenario 0	Normal stack Average: 1347		Stand-by stack Average: 0	
KPIs	1 Containers in stack	Normal stack		Stand-by stack	
		Deviation	max. 45 more	Nr. in stack	max. 178
		Recovery time	N/A	Recovery time	6 days
	2 Rescheduled containers	Not transported by		Rescheduled to	
		Barge	265	Barge	59
Rail		0	Rail	0	
Truck		0	Truck	203	
	Total	=265	Total	=265	
3 System recovery	8 days				

KPI 1: On average in scenario 0, the normal stack has 1347 containers, in scenario 2 this number increases by 45 containers. The stand-by stack keeps growing from the beginning of the disruption (until it contains 178 containers), and only starts to decline when the low water level returns to normal. It takes the stand-by stack 6 days to become empty after the water level in the Rhine River is back to normal.

KPI 2: The number of containers that was planned to be transported by barge, but is transported by truck is 203. The total number of rescheduled containers is 256.

KPI 3: The overall system recovery time is 8 days, calculated from the day the water level returns to normal.

Scenario 3 (S3) – combined scenario

In this scenario the two previous scenarios are combined. The vessel, delayed by 7 days arrived on day 36, while the low water in the Rhine is between days 30-36.

Table 5: Overview KPIs for MH scenario 3

S0	Number of container in stacks in Scenario 0	Normal stack Average: 1347		Stand-by stack Average: 0	
KPIs	1 Containers in stack	Normal stack		Stand-by stack	
		Deviation	max. 164 less	Nr. in stack	max. 193
		Recovery time	N/A	Recovery time	6 days
	2 Rescheduled containers	Not transported by		Rescheduled to	
		Barge	309	Barge	65
Rail		18	Rail	3	
Truck		69	Truck	328	
	Total	=369	Total	=369	
3 System recovery	10 days				

KPI 1: When comparing graph 50 (stand-by stack S3) to graph 34 (stand-by stack S2), the stand-by

stack in S3 is smaller during the week of the low water level than in S2. This is due to the fact that the delayed vessel will arrive on day 36, which is also the last day of low water. The stand-by stack reaches a higher number during S3 (193 containers) than during S2 (178 containers). There are 164 containers less in the normal stack (graphs 49 and 57) than during S0.

It takes the stand-by stack 6 days to return to an empty state, after the disruption is over.

KPI 2: In total 369 containers had to be rescheduled. Of the 327 delayed containers that were planned to be transported by rail and barge, 259 were rescheduled to be transported by truck.

KPI 3: Day 36 is the last day of both disruptions, day 46 is the last day on which rescheduled containers are delivered to the customers by truck, see graph 55. The system recovery time is $46-36 = 10$ days.

6.2 Terminal haulage

Scenario 1 (S1) - delay of a vessel

The vessel that is supposed to arrive at the terminal on day 36 arrives 7 days later on day 43. Graph 76 shows the number of containers in the stand-by stack. The containers are placed in the stand-by stack if it is not possible to deliver them on the planned arrival day at the customer by rail or barge. Therefore all containers in the stand-by stack will be transported by truck. The normal stack (graphs 75 and 83) contains less containers during the period that the vessel is delayed. During the two days following the arrival of the delayed vessel, the number of containers in the stacks is higher than in the S0 scenario. On day 45, the number of containers in the stand-by stack is 94 containers. This is the number of containers that should be transported by rail or barge, but is transported by truck. In total 101 containers are rescheduled to be transported by truck. Since they have a negative delay, the containers that are transported by rail and truck all arrive in advance at the customer's warehouse (see graphs 77 and 78). If these containers stayed longer in the inland terminal, they would have arrived according to schedule. Therefore, containers arriving in advance (with a negative delay), would in practice arrive right on time. For this scenario the recovery time is calculated as the difference between the day of arrival of the delayed vessel and the last day that containers are transported by truck. It arrives on day 43, and the last stand-by containers by truck are delivered on day 47 (as is shown in graph 79). The recovery time is therefore 4 days.

Table 6: Overview KPIs for TH scenario 1

S0	Number of container in stacks in Scenario 0	Normal stack Average: 98		Stand-by stack Average: 0	
KPIs	1 Containers in stack	Normal stack		Stand-by stack	
		Deviation	max. 25 more max. 16 less	Nr. in stack	max. 94
		Recovery time	3 days	Recovery time	2 days
	2 Rescheduled containers	Not transported by		Rescheduled to	
Barge/Rail		101 	Truck	101	
	3 System recovery	4 days			

KPI 1: During the period that the delayed vessel is underway, there is a lower number of

containers in the normal stack in the S1 run (maximum of 16 container less) than in the S0 run. During two days after arrival of the vessel the number of containers in the normal stack (increased by 25 containers) and in the stand-by stack (maximum of 94 container) is higher compared to the S0 scenario.

The normal stack and the stand-by stack need respectively 3 and 2 days to return to the size they has before the disruption.

KPI 2: In total 101 containers had to be transported by truck instead of barge and train, due to the delay of the vessel.

KPI 3: The overall system recovery time is 4 days, calculated from the day the delayed vessel arrives.

Scenario 2 (S2) – low water level inland waterways

In this scenario the barges can only transport up to 25% of their maximum capacity due to restrictions related to the low water level in the Rhine River. The number of containers that arrive at the terminal per day is the same in both the S0 and S2 run. This is directly visible in graphs 90 and 98 that show the number of containers in de normal stack. Even though during 7 days there is less barge capacity available (graph 89), the stand-by stack stays empty in this scenario. The spare capacity available in trains is used to the fullest during and after this period. Graph 96 shows that during the low water period (day 30-36) as well as right after, the trains transport more compared to the S0 scenario. During the disruption relatively more containers are transported by rail than barge. Transport by rail is one day faster than barge, so on average the containers arrive earlier than in the S0 run (see graph 92). Graph 97 shows that during the disruption barges transport less containers. Right after the disruption, they use their spare capacity to transport extra capacity to the inland terminal. Therefore no container have to change from barge to truck. The containers transported by barge arrive on average in advance, but less early than is the case in the S0 run (see graphs 93 and 100). The modal split (graph 95) has changed, since more containers are transported by train instead of barge. In S0 the modal split during day 25-60 for B/R is: 38/62% compared to S2 36/64%. More importantly, no container has to be rescheduled and transported by truck. The recovery time is 0 days, since in fact the disruption is not felt at the end of the transport chain. When the disruption does not cause need to reschedule containers to truck, it means that the system itself is capable of mitigating the disruption without hiring extra trucks or without the customer experiencing any delay of the containers.

Table 7: Overview KPIs for TH scenario 2

S0	Number of container in stacks in Scenario 0	Normal stack Average: 98		Stand-by stack Average: 0	
KPIs	1 Containers in stack	Normal stack		Stand-by stack	
		Deviation	max. 261 more	Nr. in stack	0
	Recovery time	4 days	Recovery time	N/A	
	2 Rescheduled containers	Not transported by		Rescheduled to	
Barge/Rail		0 	Truck	0	
	3 System recovery	0 days			

- KPI 1: During 11 days the normal stack is larger than in S0, reaching at its maximum 261 containers more than in the S0 scenario. It takes 4 days after the disruption to return to normal. The stand-by stack remains empty during the disruption.
- KPI 2: The modal split changes from the planned 38/62% (B/R) for S0 to 36/64% for S2. However, no containers have to be rescheduled and transported by truck.
- KPI 3: No containers have to be rescheduled, and no containers arrive with a delay, so the recovery time is 0.

Scenario 3 (S3) – combined scenario

In this scenario, the previous two scenarios are combined. The vessel that is supposed to arrive on day 29 is delayed by 7 days and arrives on day 36. Meanwhile the water level in the Rhine River is low, so between day 30-36 barges can transport only 25% of their maximum capacity.

Table 8: Overview KPIs for TH scenario 3

S0	Number of container in stacks in Scenario 0	Normal stack Average: 98		Stand-by stack Average: 0	
KPIs	1 Containers in stack	Normal stack		Stand-by stack	
		Deviation Recovery time	max. 173 more 4 days	Nr. in stack Recovery time	max. 120 2 days
	2 Rescheduled containers	Not transported by		Rescheduled to	
		Barge/Rail	123 	Truck	123
3 System recovery	4 days				

- KPI 1: Due to the delay of the vessel on day 29, the normal stack contains less containers on day 30 and 31 (see graphs 105 and 113). During the disruption of the low water level, the number of containers in the normal stack increases by 173, compared to the S0 scenario. This is less than in S2, since in S3 it takes until day 36 for the vessel to arrive. Before the vessel arrives, there is more space for other containers to be transported by barge and rail. The stand-by stack (graph 106) is larger than in the S1 scenario, the highest number of containers it has is 120. It takes the normal stack and stand-by stand respectively 4 to 2 days to return to their state in which they were before the disruption.
- KPI 2: The total number of containers that have to be rescheduled and that are transported by truck is 123 containers.
- KPI 3: The delayed vessel arrives on day 36, which is also the last day of the low water level. On day 40 the last containers transported by truck arrive at the customer. The overall system recovery time is 40-36 = 4 days.

6.3 Deviated arrival times and overcapacity

Overcapacity has a great influence on the ability of a transport chain to recover from a disruption. The more spare capacity there is in barges and trains, the more room there is to transport potentially delayed containers. In Appendix G the results are shown of the simulation run on the TH and MH model with deviated arrival times for the vessels. Their arrival is delayed by the triangular distribution TRIA(-

1,1,3). For MH, the rescheduling probability is set to 0%. The average number of containers that can be picked up by barge/rail/truck per day is 260 TEU.

Table 9: Overcapacity calculation

Overcapacity	# containers arriving at CT	
5%	247	= 0.95 * 260
10%	234	= 0.90 * 260
20%	208	= 0.80 * 260

Graphs 116-127 in Appendix G show the stand-by stacks at the CT and the utilisation rate of trucks, trains and barges per day of the MH model. With arrivals of the vessels that are deviating from the planned schedule and just 5% overcapacity, the stand-by stacks are growing (Graph 116). Delayed containers are not rescheduled to be transported by their planned modality, but have to be transported by truck (graph 117) where there is also a limit to the capacity. With 10% overcapacity the stand-by stacks (graph 120) are not only growing, but can be emptied from time to time. The trucks are not running on their maximum capacity all the time (graph 121). With 20% overcapacity even less containers have to be rescheduled by barge and the stand-by stacks are smaller (graph 124).

Graphs 128-136 show the results for the TH model runs under the same conditions as the MH model. Even at only 5% overcapacity no containers have to be rescheduled by truck (graph 128) and the system is able to transport all the containers in time. At 10% and 20% there is more room to be used on barges and trains in case of disruptions. Although the system works fine with just 5% overcapacity, this is not enough to be able to mitigate a disruption such as described in scenario 2: low water level and low barge capacity. For that a larger buffer is needed.

Table 10 shows average the number of containers in the truck stand-by stack, depending on the overcapacity of hinterland modalities.

Table 10: Average number of containers in truck stand-by queue for rescheduled containers



			MH	TH
Deviated arrival times & overcapacity	5% overcapacity		119	0
	10% overcapacity		7	0
	20% overcapacity		2	0

Table 11 and Table 12 give an overview of KPIs for merchant haulage and terminal haulage.

Table 11: Overview KPIs for merchant haulage

Scenario	KPI	MERCHANT HAULAGE				
0: No disruption	1 Containers in stack	Normal stack		Stand-by stack		
		Average: 1347		Average: 0		
	1: Vessel delay	1 Containers in stack	Normal stack		Stand-by stack	
			Deviation	max. 209 less	Nr. in stack	max. 104
Recovery time		N/A	Recovery time	4 days		
2 Rescheduled containers	2 Rescheduled containers	Not transported by		Rescheduled to		
		Barge	41	Barge	7	
	Rail	18	Rail	5		
	Truck	69	Truck	116		
Total	=128	Total	=128			
3 System recovery	7 days					
2: Low water level	1 Containers in stack	Normal stack		Stand-by stack		
		Deviation	max. 45 more	Nr. in stack	max. 178	
	Recovery time	N/A	Recovery time	6 days		
	2 Rescheduled containers	2 Rescheduled containers	Not transported by		Rescheduled to	
Barge			265	Barge	59	
Rail		0	Rail	0		
Truck		0	Truck	203		
Total	=265	Total	=265			
3 System recovery	8 days					
3: Combi 1&2	1 Containers in stack	Normal stack		Stand-by stack		
		Deviation	max. 164 less	Nr. in stack	max. 193	
	Recovery time	N/A	Recovery time	6 days		
	2 Rescheduled containers	2 Rescheduled containers	Not transported by		Rescheduled to	
Barge			309	Barge	65	
Rail		18	Rail	3		
Truck		69	Truck	328		
Total	=369	Total	=369			
3 System recovery	10 days					
Deviated arrival times & overcapacity	Average number of containers in stand-by queue	5% overcap.	119	10% overcap.	7	
		20% overcap.	2			

Table 12: Overview KPIs for terminal haulage

Scenario	KPI	TERMINAL HAULAGE			
0: No disruption	1 Containers in stack	Normal stack Average: 98		Stand-by stack Average: 0	
1: Vessel delay	1 Containers in stack	Normal stack		Stand-by stack	
		Deviation	max. 25 more max. 16 less	Nr. in stack	max. 94
	Recovery time	3 days	Recovery time	2 days	
	2 Rescheduled containers	Not transported by		Rescheduled to	
	Barge/Rail	101 	Truck	101	
3 System recovery	4 days				
2: Low water level	1 Containers in stack	Normal stack		Stand-by stack	
		Deviation	max. 261 more	Nr. in stack	0
	Recovery time	4 days	Recovery time	N/A	
	2 Rescheduled containers	Not transported by		Rescheduled to	
	Barge/Rail	0 	Truck	0	
3 System recovery	0 days				
3: Combi 1&2	1 Containers in stack	Normal stack		Stand-by stack	
		Deviation	max. 173 more	Nr. in stack	max. 120
	Recovery time	4 days	Recovery time	2 days	
	2 Rescheduled containers	Not transported by		Rescheduled to	
	Barge/Rail	123 	Truck	123	
3 System recovery	4 days				
Deviated arrival times & overcapacity	Average number of containers in stand-by queue	5% overcap.	0	10% overcap.	0
		20% overcap.	0		

7. DISCUSSION & CONCLUSIONS

7.1 Discussion

Table 13 shows the performance of the hinterland container transport chain in MH and TH. Terminal haulage scores better than merchant haulage on practically all key performance indicators, under all scenarios. No matter what disruption occurred, the transport chain with terminal haulage had less containers in stack, less containers had to be rescheduled and the system recovery time was shorter for terminal haulage than for merchant haulage. Only for scenario 2 it can be debated which of the hinterland network configurations performed better for KPI 1.

Table 13: Comparison of performance of MH and TH (Table 11 and Table 12)

Scenario	KPI	MH	TH
0: No disruption	1 Containers in stack	-	+
1: Vessel delay	1 Containers in stack	-	+
	2 Rescheduled containers	-	+
	3 System recovery	-	+
2: Low water level	1 Containers in stack	+/-	+/-
	2 Rescheduled containers	-	+
	3 System recovery	-	+
3: Combi 1&2	1 Containers in stack	-	+
	2 Rescheduled containers	-	+
	3 System recovery	-	+
Deviated arrival times & overcapacity	Average number of containers in stand-by queue	-	+

In scenario 2 for merchant haulage during the low water levels of the Rhine River, the normal stack increases by a maximum of 45 containers and the stand-by stack by a maximum of 178 containers (see Table 11). The number of containers in terminal haulage shows a large deviation from the S0 scenario than merchant haulage, since the TH stack increases by a maximum of 261 containers (see Table 12). The TH 'normal' stack increases by 261 containers which is more containers than 45+178 containers for the MH stacks. However, in TH no containers are placed in the stand-by stack, whereas in MH the stand-by stack contains at its maximum 178 containers, which are all containers that have to be rescheduled. In addition to that, in the non-disrupted situation TH has on average much less containers in stack than MH: 1347 compared to 98. So even if in scenario 2 the absolute deviation of the stack size is larger for TH, the total number of containers is still much lower than in MH. And the fact that in TH no containers

are placed in the stand-by stack is positive. The recovery time of the stack in TH is shorter than in MH; 4 and 6 days respectively. So also for this key performance indicator can be said that TH performs better during scenario 1 than MH.

Table 13 shows that for this scenario study the overall performance of TH is better than that of MH. But what are the implications of that? The first key performance indicator is about the stack size, which is in all scenarios much smaller in the case of TH. For the terminal operator this is an advantage, since it means the stack yards in the sea-side container terminal can be smaller than with merchant haulage. The stack yard in the inland terminal has to be larger, but the price of the land in less densely populated areas is lower than near the Port of Rotterdam. The smaller the stack yard in the sea-side container terminal, the cheaper it is for the terminal operator. However, the terminal operator has to keep in mind that during a disruption in TH, such as low water level of the Rhine, the number of containers in stack might be double or triple as much as in a non-disrupted situation, although this is still much smaller than in MH. The current simulation model could be a tool in determining the minimum stack yard size required for when disruptions occur. For TH this would be 420 (Graphs 105 and 106 from Appendix F), and for MH this would be 1520.

In TH the containers are transported as soon as possible to the inland container terminal, where the containers dwell until they are picked up by truck and transported to the customer's warehouse. For a customer it is an advantage if the container is sooner in the inland terminal, since for an individual container it is less likely to experience any disruptions when it already arrived at the inland terminal than if it was still at the sea-side terminal. On the way from the sea-side terminal to the inland terminal it is more vulnerable to disruptions than from the inland terminal to the warehouse.

The second key performance indicator was about the number of containers that have to be rescheduled, either to the same modality, or to truck. In all three scenarios TH showed to be more flexible than MH, since much less containers needed to be rescheduled. In Scenario 2 not even a single container had to be rescheduled. Rescheduling containers brings extra effort and costs. Especially if containers need to be rescheduled to be transported by truck, the costs are higher than if the container was transported by rail or barge. Trucks are very flexible and fast, but are more expensive and more pollutant than the other modalities. In MH traditionally 54% of containers is transported by truck. TH proves to be able to transport all containers to the hinterland by barge and rail in case there are no disruptions, thereby decreasing overall costs and CO₂ emissions. If a disruptions occurs in TH, less containers need to be rescheduled and less containers need to be transported by truck than in MH. In addition to that, the scenario study shows that containers in TH arrive with less delay than the MH containers in a disrupted situation.

The third key performance indicator is the overall system recovery time that is calculated from the day the disruptive event came to an end. TH showed that in all three scenarios the system recovery time was much shorter than that of MH. In scenario 2 the customer does not experience any disruption, since it was not propagated through the transport chain. Therefore the system recovery time is equal to 0 days. The shorter the system recovery time, the less problems a customer experiences, and the higher the quality of the transport service is. For the terminal operator, a shorter recovery time means that less effort is needed to mitigate the disruption.

The three disruption scenario runs were done with the model in which the vessels arrive according to schedule. In reality, as is explained in Section 4.2, vessels often arrive with a delay of a few days. For

testing how much overcapacity of the hinterland transport modalities is needed, and how that is different for MH and TH, the models were run with vessel arrival times that deviated from planning. It is shown that MH needs in this scenario at least 20% overcapacity to have an acceptable performance, whereas TH already performs well with 0% overcapacity. Less overcapacity means less costs for the owner of the barges and trains. In MH the terminal operator does not own the barges and trains, so there would not be much difference if there is a lot of overcapacity or not. However, the more overcapacity there is in MH the less efficiently barges and trains are loaded, and the more of them are needed to transport the same number of containers. For the barge and train operator this means higher costs, and for the terminal operator this means that more barges and trains will call at the sea-side terminal which could cause congestion. TH performs well with no overcapacity in the case of vessel arrivals deviating from planning. However, to be able to mitigate disruptions, also in TH some overcapacity of barges and trains is needed.

This analysis shows that TH scores better than MH on the chosen key performance indicators. These indicators are chosen since they are a good way to measure the robustness of hinterland network configuration. Under the given circumstances and under the chosen disruption scenarios, it can be concluded that TH is more robust than MH. For a terminal operator to be able to compete with other terminal operators it is important that the transport chain as a whole performs well. Clients in the hinterland can choose to have their containers transported via different terminals. The performance of the transport chain is key to attracting future transport flows. The robustness of the transport chain to disruptions determines to a certain extent its performance.

Traditionally sea-side container terminal operators are not involved with hinterland container transport and hinterland terminals. If the terminal operator has the ambition to secure future transport flows, it has to increase the performance of the transport chain. TH will make the transport chain from the sea-side container terminal to the customer's warehouse more robust. For the implementation of TH a lot of organisational changes are needed, such as organising the additional services of barges and trains, and operating inland terminals. The hinterland transport services are no part of the traditional core activities of the terminal, and it will require additional effort and investments of the terminal operator. Cooperation between the parties in the transport chain in MH is not evident, information sharing is often said to be problematic. In MH shared situational awareness is lacking among the companies that are each responsible for their part of the transport chain. They only act in their own interest, instead of that of the whole transport chain which hampers the overall performance. In TH, all inland transport activities are done by one actor; the terminal operator. The different departments of the terminal operator share the overall goal of the organisation in terms of good performance for the customer. It should therefore be easier to reach a higher level of shared situational awareness in TH than in MH. Information sharing is a major factor that contributes to shared situational awareness. The information should be complete, shared in time and reliable. It is not evident that departments within one organisation share information that is needed to reach high performance levels. Especially in case of disruptions this is not always the case. For this to work well the terminal operator should design its organisation in such a way that the right information is shared at the right moment in time between the right departments. Only then TH will be able to perform better than MH.

7.2 Conclusions

Since their introduction, containers have dramatically changed international transportation. Ports in Europe that share the same hinterland compete with each other to attract container transport flows.

The performance of the whole hinterland transport chain determines its competitive position. This research focuses on the robustness of hinterland container transportation. Robustness is about the system's ability to perform well across a range of scenarios. The scenarios that are studied in this research describe disruptive events that are likely to happen. Due to the interconnectedness of the transport chain and a lack of cooperation among different actors, mitigation of the disruption is difficult, and as a result the effect of a disruption propagates throughout the chain.

For this research a discrete event simulation model is developed that serves as a tool to study the robustness of a hinterland container transportation chain. In the model the import container transport chain has been modelled from the sea-side container terminal in the Port of Rotterdam via the inland terminal in Duisburg to the customer's warehouse in the Ruhr district. There are two versions of the model: one for merchant haulage (MH) and one for terminal haulage (TH). In MH different parties are responsible for the consecutive processes of transshipment and storage in the sea-side terminal, transport by barge/rail/truck, transshipment in the inland terminal and transport by truck to the customer. In TH these processes are managed by one actor: the sea-side container terminal operator. According to the literature study, terminal haulage offers a number of benefits. Most of the hinterland container transportation is done in merchant haulage and only a small part in terminal haulage. The influence of merchant haulage and terminal haulage on the robustness of the transportation chain have not been studied before. In this research a discrete event simulation model has been developed to answer the following research question.

What is the influence of the hinterland network configuration on the robustness of a hinterland container transportation chain?

The three sub questions are the following:

1. What is the effect of the delay of one vessel on the performance of the hinterland transport chain?

When a vessel arrives at the sea-side terminal with a delay of 7 days, part of its containers will miss their planned slot on a hinterland modality. Those containers are planned to be picked up within 7 days after arrival, but they have to be rescheduled, either by their own modality or to truck. In the scenario study this was the case in both MH and TH. The disruption's effect was more severe in MH than in TH, which is shown by the system recovery time and the number of containers that are rescheduled. In case of a delayed vessel, not only is the number of container that has to be rescheduled in MH much higher than in TH, but the recovery time of the system is also longer.

2. What is the effect of a low water level in the Rhine on the performance of the hinterland transport chain?

A low water level in the Rhine River causes problems for barges sailing from the Port of Rotterdam to the inland terminal in Duisburg. In the scenario study only a small part of the barge transport capacity was available in case of this disruption. Whereas MH struggles with the loss of barge capacity, TH has no difficulties at all in dealing with this disruption. In MH a large part of the containers that were planned to be transported by barge had to be transported by truck which is more expensive. However, in TH it is the terminal operator that decides when the containers are transported to the hinterland and whether they are transported by barge or train. The customer does not experience any effect of the disruptions as a result of the high degree of flexibility.

3. How does overcapacity of hinterland modalities influence the ability of the transport chain to deal with vessel arrival times that deviate from planning?

In reality vessels hardly ever arrive on time at the sea-side terminal. It is normal for them to be delayed by around 3 days. The results of the simulation runs showed large differences between the hinterland transport capacities needed in MH and TH. The transportation system has to be a lot more flexible when vessels do not arrive on the planned day. If the transportation system is not able to be flexible enough, many containers have to be rescheduled and transport by truck. TH is able to deal with vessel arrivals deviating from planning even with no overcapacity. MH, however, needed at least 20% of overcapacity to perform well.

The hinterland network configuration, TH and MH, does influence the robustness of a hinterland container transportation chain. The robustness can be determined by measuring the number of containers in the stack yard, the number of container that are delayed and have to be rescheduled, and the system recovery time. A hinterland container transportation chain, like that from the Port of Rotterdam to the Ruhr district, is more robust with TH than with MH. Under all scenarios in TH there are less containers in the stack yard at the sea-side container terminal, so the terminal surface can be smaller and less expensive. In case of disruptions less containers have to be rescheduled in TH than in MH, which saves costs and efforts of rescheduling. The customer benefits from this since there are less containers that arrives with a delay at the warehouse. After a disruption, it takes less time for TH to recover compared to MH.

TH is more robust since is a lot more flexible than MH. In MH containers have to be picked-up on a planned pick-up day, but in TH it is the terminal operator who decides which containers are transported to the hinterland and by what modality (train or barge). Less land is needed at the sea-side terminal for the stack-yard, since in TH containers are transported faster to the inland terminal. In TH the disruptions are mitigated faster and with lower costs. Nowadays it is not the sea-side terminals that compete with each other to attract transport flows but it is transportation chains as a whole that compete with each other. A terminal operator that wants to improve its competitive position definitely has to increase the robustness of the whole transportation chain. This research shows that changing hinterland network configuration of the transport chain to TH is an effective way of increasing the transport chain's robustness, thereby increasing the competitive position of the terminal.

The discrete event simulation model for this research has been developed to study the import container transportation chain from the Port of Rotterdam to the Ruhr district. The model can easily be adapted to be used for other locations where there is a sea-side terminal connected to an inland terminal. The simulation model could serve as a tool to support the terminal operator in the decision making of strategic issues, such as whether or not the terminal should expand its business into the hinterland by applying TH. From the point of view of robustness, it would be wise for terminal operators to do so. However, investments for inland terminals have to be done and the organisation has to be designed in such a way that it allows for good information sharing between the departments. Only then TH can be a success.

There are limitations to the current research. One limitation is that the current model is rather deterministic. In reality random events do occur, and the model would be closer to reality if those were included in all scenario runs. This has not been done, since a scenario study with less random events allows for studying the impact of individual disruptions on the transportation chain. Validation of the

research was not possible since data for terminal haulage are not publicly available, because they are considered to be too sensitive to disclose. Therefore this model is partly based on assumptions. More detailed data would make it possible to draw more accurate conclusions. Due to the lack of detailed data, it is not possible to use this model to draw conclusions on tactical and operational level. Still the model can be used very well on the strategic level; for example for terminal operators considering terminal haulage.

Recommendations for future research

Gathering more detailed data and adding them to the current model could be part of future research. The focus could thereby shift from the strategic level to the tactical and operational level. The research could then focus more on planning issues, such as what capacity is needed for sea-side and inland container terminals and with what frequency barges and trains need to run between the two terminals. The current model leaves operational processes within of the sea-side terminal out of scope, and these have an impact on the performance of the transport chain as a whole. Disruptive events such as congestion at the terminal could be propagated through the transportation chain. It would thus be worthwhile to also look at the processes within the terminal.

The current model simulation the hinterland transportation chain of import containers. Future research could be done into the export containers transportation chain, since there are slightly different challenges than for the import container chain. In reality the import and export containers transportation chain are connected to each other, so disruptions occurring at import process might also influence the export containers. It will therefore be interesting to study the robustness to disruptions of this combined system.

A last recommendation for future research is about mitigation plans. The current model can be used to study the impact of disruptions on TH and MH, only by looking at the ability of the system itself to deal with the disruption without taking active mitigation strategies into account. To diminish the effect of disruptions, an active mitigation strategy should be developed. This plan can be tested with the current model during future research. Since in MH different parties are each responsible for their own part of the transport chain, it is difficult to develop an overall mitigation plan. In TH the terminal operator is responsible over the full hinterland transportation chain and thereby has the ability to implement an overall disruption mitigation plan. Future research could support the development and evaluation of such mitigation plans.

7.3 Reflection

The discrete event simulation model combined with the scenario study is a good method to study the robustness of a hinterland network configuration. Once the model is built, results can be obtained very fast. This is a great advantage since it allows for evaluating a lot of different scenarios. It is now very easy to get some graphs with results. However, the difficult part is the interpretation of the results. For this the key performance indicators have to be defined very well. Initially the parameter 'costs' was considered to be an important indicator of the performance of TH and MH. Container transportation is business and needs to generate revenues. However, the level of detail of the current model does not allow for making detailed cost calculations. From the results of the simulation runs it can be said that it is more expensive to transport containers by truck instead of train or barge, and if these have to run with a larger capacity transport will also be more expensive. For detailed cost calculations, more

detailed data are needed. These calculations will be of interest to terminal operators considering terminal haulage.

Another parameter that could be considered to be important is the delay with which containers arrive at the customer in case a disruption occurs. It is positive if containers are delivered at the customer without or only with a small delay. However, when a container is delayed and therefore not picked up by its barge, it is rescheduled to truck which is much faster than barge. It turned out to be impossible to draw conclusions for the 'delay' parameter. Due to the truck's speed the containers arrive at the customer even before the planned arrival day, but at higher costs. It would have been good to have data on how important it is to the customer to receive the containers in time. Probably if the transport of the container is done by vessel, speed does not matter that much to the customer. Costs are probably a more important parameter, as explained before.

The deterministic nature of the model allows study the impact of a disruption on the container transportation chain very well. Random events could have been added to the model, but more detailed data would have been needed to do so. The random events make the interpretation of the results much harder. Since the goal of this research was to draw conclusions on the strategic level, the current level of detail in the model is sufficient. It is a generic model that can be used to study the robustness of hinterland container transportation chains other than the one between Rotterdam and the Ruhr district.

8. REFERENCES

- Alagheband, A. (2011). Logistics parties. In F. Reza, R. Shabnam, & K. Laleh (Eds.), *Logistics Operations and Management: Concepts and Models* (pp. 71–91). London: Elsevier.
- Berle, Ø. (2012). *Risk and resilience in global maritime supply chains maritime supply chains (Doctoral thesis)*. Norwegian University of Science and Technology, Trondheim.
- Berle, Ø., Rice Jr., J. B., & Asbjørnslett, B. E. (2011). Failure modes in the maritime transportation system: a functional approach to throughput vulnerability. *Maritime Policy & Management*, 38(6), 605–632.
- Bolstad, C., & Endsley, M. (2000). Shared displays and team performance. In *Human Performance, Situation Awareness and Automation Conference* (pp. 1–6). Savannah, GA, USA.
- Börjeson, L., Höjer, M., Dreborg, K. H., Ekvall, T., & Finnveden, G. (2006). Scenario types and techniques: Towards a user's guide. *Futures*, 38(7), 723–739.
- Bosschiet, C. G. (2005). *Klimaatverandering en binnenvaart: Effecten op de binnenvaart van meer extreem lage (en hoge) waterstanden op de Rijn*. Delft University of Technology.
- Bureau Voorlichting Binnenvaart. (2015). Laag water hinderlijk maar vooralsnog geen probleem voor de binnenvaart. Retrieved March 1, 2015, from <http://www.bureauvoorlichtingbinnenvaart.nl/actueel/laag-water-hinderlijk-maar-vooralsnog-geen-probleem-voor-de-binnenvaart>
- Craighead, C. W., Blackhurst, J., Rungtusanatham, M. J., & Handfield, R. B. (2007). The Severity of Supply Chain Disruptions: Design Characteristics and Mitigation Capabilities. *Decision Sciences*, 38(1), 131–156.
- Douma, A. M. (2008). *Aligning the Operations of Barges and Terminals through Distributed Planning*. Twente University of Technology.
- European Container Terminals. (2011). The future of freight transport. Retrieved from [http://myservices.ect.nl/SiteCollectionDocuments/Boek Visie ECT_NL.pdf](http://myservices.ect.nl/SiteCollectionDocuments/Boek%20Visie%20ECT_NL.pdf)
- European Gateway Services. (2015). DeCeTe Duisburg. Retrieved January 1, 2014, from <http://www.europeangatewayservices.com/terminal/duisburg>
- Franc, P., & Van der Horst, M. (2010). Understanding hinterland service integration by shipping lines and terminal operators: A theoretical and empirical analysis. *Journal of Transport Geography*, 18(4), 557–566.
- Frémont, A., & Franc, P. (2010). Hinterland transportation in Europe: Combined transport versus road transport. *Journal of Transport Geography*, 18(4), 548–556.
- Gateway Logistics Group. (2014). 70-hour ship arrival delays in northern Europe. Retrieved March 1, 2015, from <http://www.gateway-group.com/articles/70hour-ship-arrival-delays-in-northern-europe>
- Gurning, S. (2011). *Maritime disruptions in the Australian-Indonesian wheat supply chain: An analysis of risk assessment and mitigation strategies (Doctoral thesis)*. University of Tasmania, Australia.

- Henesey, L., & Törnquist, J. (2002). Enemy at the gates: introduction of multi-agents in a terminal information community. In *Third International Conference on the Management, Operation, Design and Building of Ports, Marinas and Other Maritime Works* (pp. 23–32). Rhodos, Greece: WIT Press.
- IDVV. (2012). Definitief Eindrapport: Multimodaal internationaal container netwerk (PowerPoint presentation).
- Joys, J. (2014). *A Shared Situational Awareness Model for Transportation Networks (Master thesis)*. Delft University of Technology.
- Kurapati, S., Kolfschoten, G. L., Verbraeck, A., Drachsler, H., Specht, M., & Brazier, F. M. T. (2012). A Theoretical Framework for Shared Situational Awareness in Sociotechnical Systems. In *Proceedings of the 2nd Workshop on Awareness and Reflection in Technology-Enhanced Learning. In conjunction with the 7th European Conference on Technology Enhanced Learning: 21st Century Learning for 21st Century Skills* (pp. 47–53).
- Lang, N., & Veenstra, A. (2010). A quantitative analysis of container vessel arrival planning strategies. *OR Spectrum*, 32(3), 477–499.
- Li, R., Veenstra, A., Yu, M., Zhao, L., & Zuidwijk, R. (2010). Information exchange in global logistics chains. In *IEEE International Conference on Service Operations and Logistics and Informatics (SOLI)* (pp. 264–269).
- Loh, H. S., & Thai, V. V. (2012). The Role of Ports in Supply Chain Disruption Management. In *International Forum on Shipping, Ports and Airports (IFSPA)* (pp. 325–340). Hong Kong.
- Lu, J. (2008). *An Analysis of Container Dwell Time Reduction at APM Terminals Rotterdam (Master thesis)*. Delft University of Technology.
- Menkveld, N. (2013). ABN AMRO: Visie op Binnenvaart. Retrieved March 1, 2015, from <https://insights.abnamro.nl/visie-op-sector/2014/visie-op-binnenvaart/>
- MOL. (2015). CHECK: Vessel On-time Performance. Retrieved March 1, 2015, from <http://www.countonmol.com/operations/vessel-on-time-performance/>
- Naderpour, M., Lu, J., & Zhang, G. (2014). An intelligent situation awareness support system for safety-critical environments. *Decision Support Systems*, 59, 325–340.
- Notteboom, T. (2008). The relationship between seaports and the intermodal hinterland in light of global supply chains: European challenges. In *Research Round Table OECD / International Transport Forum* (pp. 1–44). Paris, France.
- Panayides, P. M. (2002). Economic organization of intermodal transport. *Transport Reviews*, 22(4), 401–414.
- Peterson, G. D., Cumming, G. S., & Carpenter, S. R. (2003). Scenario Planning: a Tool for Conservation in an Uncertain World. *Conservation Biology Pages*, 17(2), 358–366.
- Port of Rotterdam. (2015). Bereikbaarheid: Ook in de toekomst goed bereikbaar. Retrieved April 1, 2015, from <https://www.maasvlakte2.com/nl/index/show/id/236/bereikbaarheid>
- Robinson, S. (2004). *Simulation. The Practice of Model Development and Use*. Chichester: Wiley & Sons Ltd.

- Rodrigue, J. P., Debie, J., Fremont, A., & Gouvernal, E. (2010). Functions and actors of inland ports: European and North American dynamics. *Journal of Transport Geography*, 18(4), 519–529.
- Roso, V., Woxenius, J., & Lumsden, K. (2009). The dry port concept: connecting container seaports with the hinterland. *Journal of Transport Geography*, 17(5), 338–345.
- Schriber, T. J., & Brunner, D. T. (2006). Inside discrete-event simulation software: how it works and why it matters. In *Winter Simulation Conference* (pp. 118–128).
- Snyder, L. V., Peng, P., Lim, A., & Liu, Z. (2011). Reliable logistics networks design with facility disruptions. *Transportation Research Part B*, 45(8), 1190–1211.
- Sorensen, L. J., & Stanton, N. A. (2013). Y is best: How Distributed Situational Awareness is mediated by organisational structure and correlated with task success. *Safety Science*, 56, 72–79.
- Transport Research Centre, International Transport Forum, & Organisation for Economic Co-operation and Development. (2009). *Port competition and hinterland connections*. Paris: OECD/ITF.
- Van der Horst, M., & De Langen, P. W. (2008). Coordination in Hinterland Transport Chains: A Major Challenge for the Seaport Community. *Maritime Economics & Logistics*, 10, 108–129.
- Vasiliauskas, A. V., & Barysiene, J. (2008). An economic evaluation model of the logistic system based on container transportation. *Transport*, 23(4), 311–315.
- Veenstra, A., Zuidwijk, R., & van Asperen, E. (2012). The extended gate concept for container terminals: Expanding the notion of dry ports. *Maritime Economics & Logistics*, 14(1), 14–32.
- Voss, S., Stahlbock, R., & Steenken, D. (2004). Container terminal operation and operations research - a classification and literature review. *OR Spectrum*, 26(1), 3–49.
- World Economic Forum / Accenture. (2013). *Building Resilience in Supply Chains*.

APPENDIX A: DWELL TIME

Dwell time is the time a containers spends in the stack yard of a container terminal. These data are derived from Lu's master thesis (2008). In her thesis there were no data available for terminal haulage, only merchant haulage and carrier haulage. These data are combined and depicted in the following graph. The graph shows that the majority of the containers has a dwell time of a few days, but some containers stay for even 21 days in the stack yard.

Note: This graph is based upon the actual time of arrival (ATA) of ocean going vessels at the sea-side terminal, which can deviate from the estimated time of arrival (ETA). The model works with ETA of a vessel to calculate per container its planned arrival day. Since there was no data available for ETA, the ATA data were used.

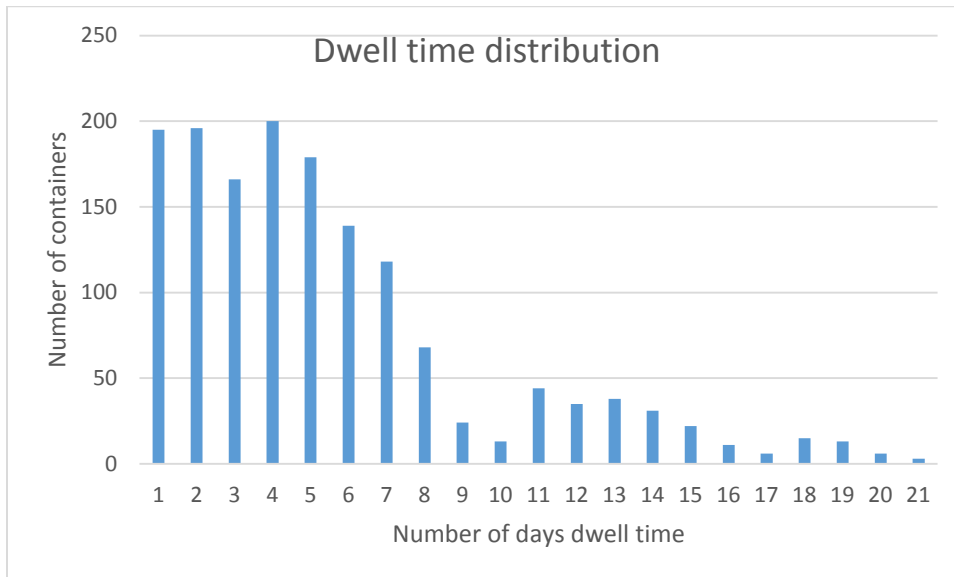

Figure 16: Dwell time distribution (Lu, 2008)

APPENDIX B: KEY PERFORMANCE INDICATORS

MH model

Table 14

Read-write module	Data
RW1	The current number of containers in the following stacks are recorded: <ul style="list-style-type: none"> - The three 'normal' stacks for truck, barge and train. - The three 'stand-by' stacks for the truck, barge and train.
RW2	The numbers of containers that are transported by truck each day are recorded in two categories: <ul style="list-style-type: none"> - Normal containers that are in time - Stand-by containers that are delayed (either originally planned for truck, barge or train)
RW3	The numbers of containers that are transported by train are recorded in two categories: <ul style="list-style-type: none"> - Normal containers that are in time - Stand-by container that are delayed, but they are rescheduled to be transported by train.
RW4	The numbers of containers that are transported by barge are registered in two categories: <ul style="list-style-type: none"> - Normal containers that are in time - Stand-by container that are delayed, but they are rescheduled to be transported by barge.
RW5	For containers that were transported per truck directly to the customer: Upon arrival by truck at the customer's warehouse, for each container its 'final delay' is calculated. A negative delay means the container arrived in advance. The containers are divided according to their originally planned modalities. The total 'final delay' is calculated per day, together with the number of containers, from which the average delay of that day can be calculated in Excel.
RW6	For containers that were transported per barge or train via the inland terminal: Upon arrival at the customer's warehouse by truck, for each container its 'final delay' is calculated. The containers are first divided according to the hinterland modality, to be able to calculate potential differences between train and barge. Then they are divided a flow of containers that are rescheduled and those that are not.
RW7	Number of containers that arrive per day at the stacks at the sea-side terminal, for truck, rail, and barge.

TH model

The key performance indicators of the model are measured by assigning values to the variables that are written to an Excel file. The variables are set to 0 every day, so the values are registered per day.

Table 15

Read-write module	Data
RW1:	The current number of containers in the following stacks are registered: <ul style="list-style-type: none"> - The two 'normal' stacks: one for truck, and one for barge & train. - The 'stand-by' stack for the truck.
RW2:	The numbers of containers that are transported by truck each day are recorded in two categories: <ul style="list-style-type: none"> - Normal containers that are in time - Stand-by containers that are delayed (either originally planned for truck, barge or train)
RW3:	The numbers of containers that are transported by train are recorded: <ul style="list-style-type: none"> - Normal containers that are in time
RW4:	The numbers of containers that are transported by barge are recorded: <ul style="list-style-type: none"> - Normal containers that are in time
RW5:	After arrival at the customer's warehouse, the 'final delay' per container is calculated. A negative 'final delay' means the container has arrived in advance. The containers are separated between those that are originally planned to be transported by train/barge and those by truck. The total amount of delay of that day is calculated and the total number of containers is count, so the average delay per day can be calculated with Excel.
RW6:	In the same way the 'final delay' is calculated per container that is transported per barge or train via the hinterland terminal to the customer.
RW7:	Number of containers that arrive per day at the stacks at the sea-side terminal, both for truck and rail/barge.
RW8:	Total capacity per day of barges and trains that left the sea-side terminal.

APPENDIX C: DATA TABLE

General

Table 16: General data table

	Current value	Source
Create vessels	1 per day	
# containers per vessel	245/2200	See
Delay at ocean	0 / 72h	(Gateway Logistics Group, 2014)
Delay unloading vessel	UNIF(0,24)	Verbraeck, 2015
Average unloading time	24 h	Maximum unloading time
Modal split	MH: 54/17/29% = T/R/B TH: 100% R&B	(IDVV, 2012, p. 27)
Dwell time	See Appendix A	(Lu, 2008)
Probability to reschedule barge/rail containers	20%	See Appendix D
Delay rail transport	12 h	Transport by rail from R'dam to Duisburg
Delay truck transport	12 h	Transport by truck from R'dam to Duisburg
Delay barge transport	24 h	Transport by barge from R'dam to Duisburg
Delay Dwell time at ICT	24 h	
Delay Transport by truck from ICT to Customer	12 h	See calculation under
Delay change to truck	1 day	
MH: max. terminal capacity T	135 TEU	20% overcapacity
MH: max. terminal capacity R	43 TEU	20% overcapacity
MH: max. terminal capacity B	73 TEU	20% overcapacity
TH: railsize	90 TEU	(Port of Rotterdam, 2015)
TH: bargesize	208 TEU	Marinetraffic.com The number of containers varies between 35 and 500, and 208 is a common capacity for barges.
Remaining barge capacity in case of low water level	25%	(Bureau Voorlichting Binnenvaart, 2015)

Vessel and hinterland modality schedules

Table 17: Number of containers per day that arrive at the terminal. For MH & TH

# TEU	Calculation/source
208 TEU per day	Based on the weekly number of trains and barges in the ECT schedules, the following number of container is calculated (European Gateway Services, 2015): Per week: 11x rail, 4x barge. $(11 \cdot 90 + 4 \cdot 208) / 7 = (990 + 832) / 7 = 260$ TEU. With 20% overcapacity in rail and barge (see Appendix G), 208 TEU arrive at

	the sea-side terminal per day.
--	--------------------------------

In both models the number of containers arrive at the terminal, all at once and every day at the same moment in time. In reality containers may be transported by several vessels, varying in size between 8.000-13.000 TEU (Marinetraffic.com), of which only part of the containers has Duisburg as their destination.

Table 18: Merchant haulage schedules

Departure	Schedule	# TEU
Truck	1x per day	All containers for today
Rail	1x per day	All containers for today
Barge	1x per day	All containers for today

Table 19: Terminal haulage schedules

Departure	Schedule High	Schedule Low	# TEU per modality
Truck	1x per day	1x per day	All containers for today
Rail	11x per day	11x per week	90 (Port of Rotterdam, 2015)
Barge	6x per day	4x per week	208 (Marinetraffic.com)

Table 20: Formulas in Model

Planned departure day from CT (only MH)	$a_CreationDay + a_dwelltime + v_Average_Unloadingtime$
Planned arrival day at customer	$a_CreationDay + a_dwelltime + v_Average_Unloadingtime + v_Modspec_Transp_time$
TH: R&B stack: when containers are planned to be shipped by truck	$(a_PlannedArrivalDayCustomer - v_Modspec_Transp_time_R/B) < v_day$
TH: T stack: when containers are planned to be shipped by truck	$(a_CreationDay + a_dwelltime + v_Average_Unloadingtime) < v_day$
MH: T,R,B stack: when containers are planned to be shipped by truck	$a_DepartureDayfromCT < v_day$
$v_Modspec_Transp_time$ (T/R/B)	Transport time from CT to ICT + (Dwell time at ICT + Transport time by truck from ICT to customer)

Scenario data

Table 21

S0	No disruptions
S1	Vessel delayed by 7 days planned arrival day: 36 Actual arrival day: 43
S2	Low water levels in Rhine River from day 30 to 36
S3	Combined scenario S1&S2: Vessel delayed by 7 days planned arrival day: 29 Actual arrival day: 36 Low water levels in Rhine River from day 30 to 36
Deviated arrival times of all vessels	TRIA (-1,-1,3)

APPENDIX D: MH RESCHEDULING PROBABILITY

The percentage of containers that can be rescheduled depends on two factors. First of all it needs to be in balance with the overcapacity on the barges and trains. If there is no space to transport stand-by containers, their stack will grow and this will not help mitigation of the disruption. Second, if a container misses its planned modality, e.g. a barge, rescheduling to a barge the next day can only happen if there is good cooperation among the freight forwarder and one or more barge operators.

In the following graphs the number of containers in the stand-by stack are depicted. The graphs are from runs with the MH model, with scenario 2 (low water level), an overcapacity of 20%, per day 208 containers arrive at the sea-side container terminal. The rescheduling probability ranges from 0 to 100%

With a rescheduling probability of 0% all containers that are delayed are rescheduled to be transported by truck. The rescheduling probability indicates the percentage of containers that, when delayed, are rescheduled to be transported by their originally planned modality (rail or barge). The transport per truck is faster than transport via barge, but the truck terminal has a maximum capacity, therefore some containers have to wait a few days before transport to the customer. The higher the rescheduling probability, the more containers are transported by barge. But the barge terminal also has a maximum terminal capacity, so if the rescheduling probability is too high compared to the overcapacity (which is 20%), the stand-by stack for rescheduled barge containers will be filled for a longer period of time. The recovery time (the period from the end of the disruption until the system is back to normal) stays the same for the graphs with 0-20% rescheduling probability. When the rescheduling probability is higher than the 20% overcapacity, the recovery period turns out to be longer. For the simulations runs the rescheduling probability was set on 20%.

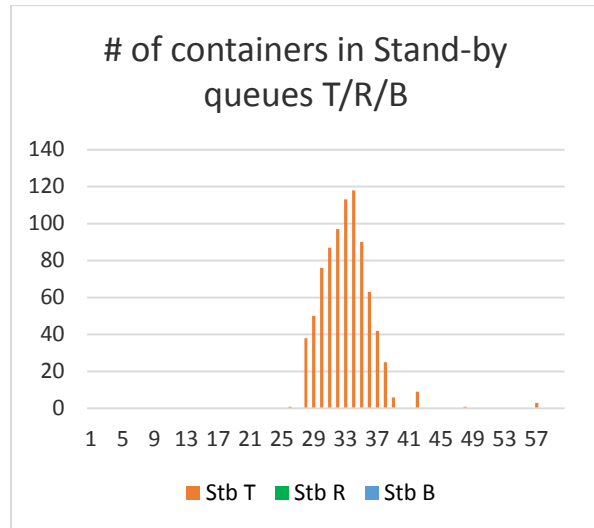

0%

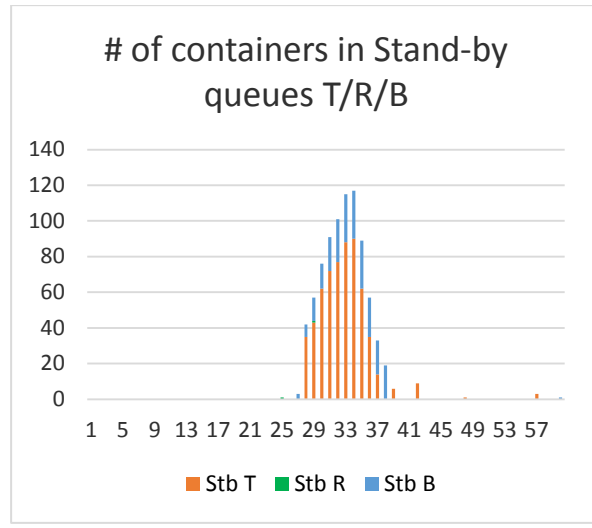

10%

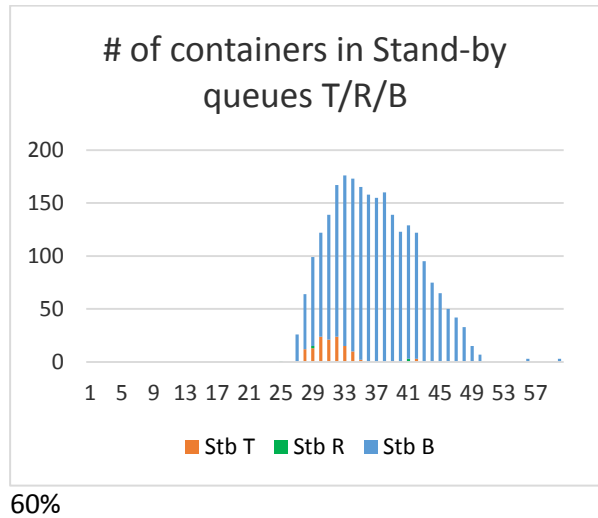
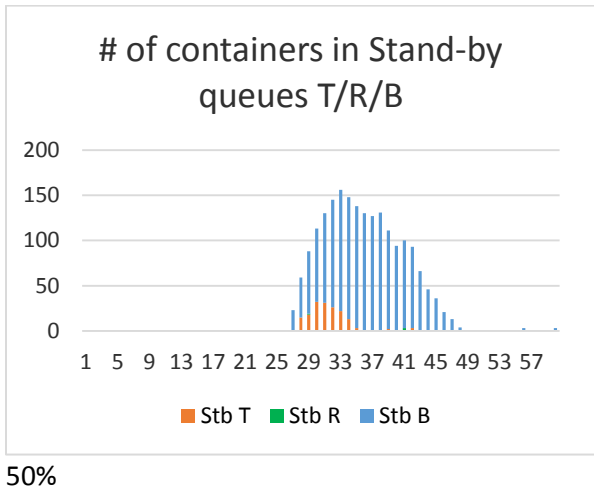
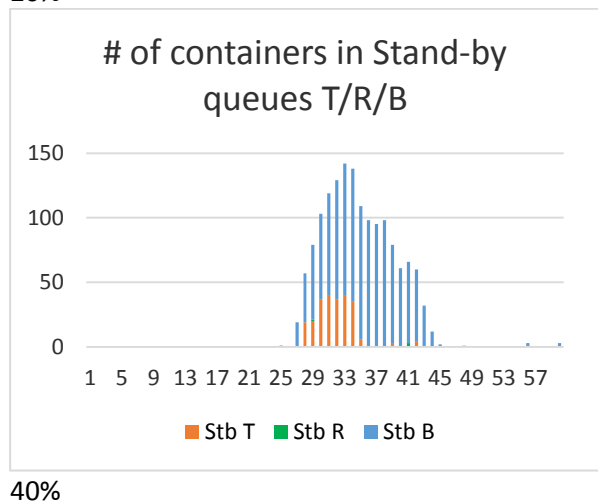
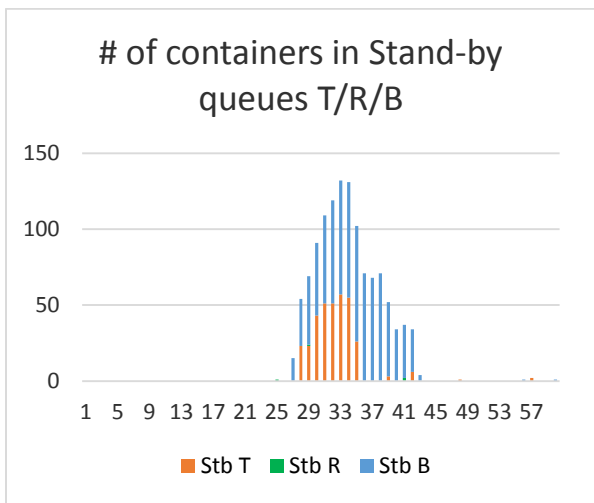
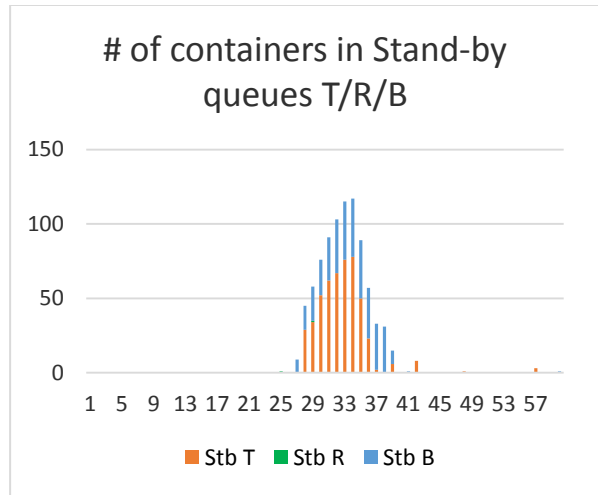
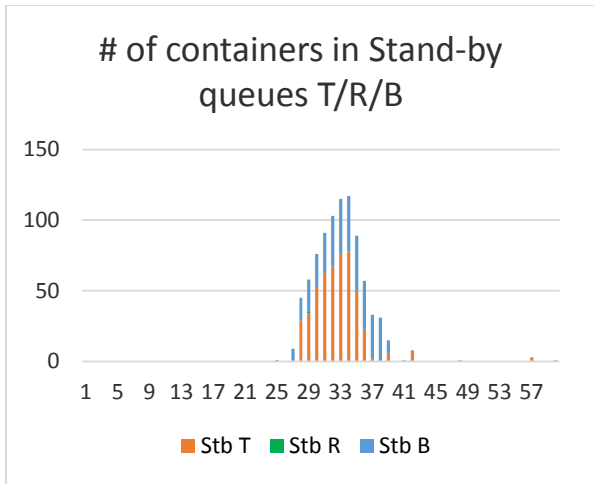

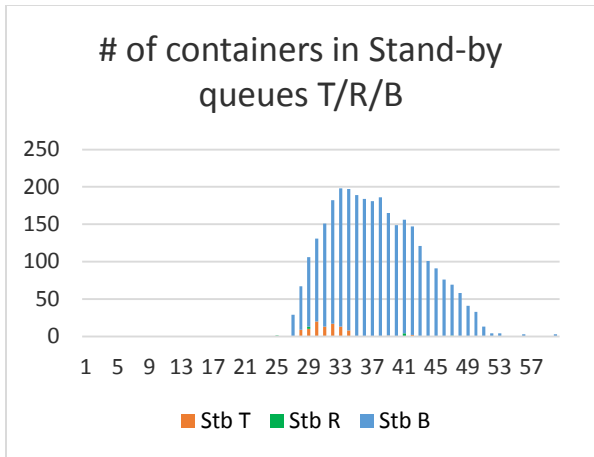

70%

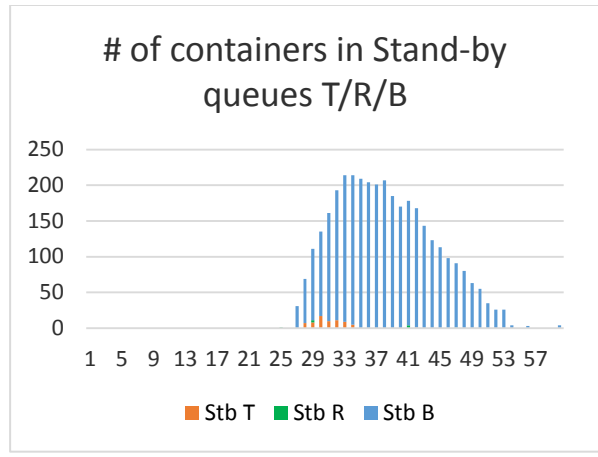

80%

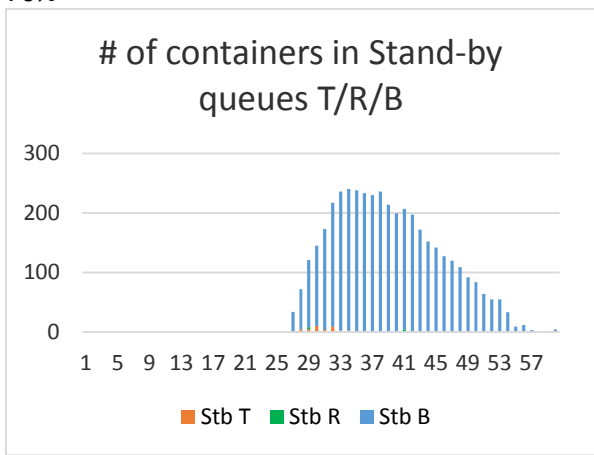

90%

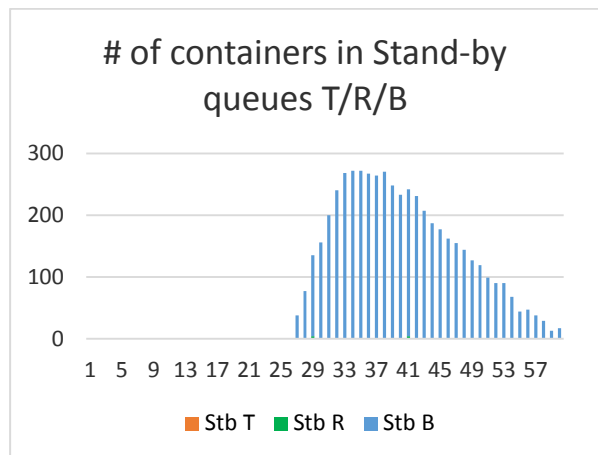

100%

APPENDIX E: VERIFICATION TESTS

The extreme values tests that are performed:

- A. High number of containers arrive with each vessel at the sea-side terminal: 2000 per day.
- B. Transportation time for rail containers is extremely long: 30 days.
- C. No trucks available during scenario 1 (delay of 1 container)
- D. Only 1 container enters the simulation model.

Scenario 0 results

(The numbers of the graph refer to Appendix G)

MH

Graph 6 shows that in non-disrupted situation some containers have to be rescheduled. This is not what would be expected from the non-disrupted situation, but can be very well explained based on how the model is built. The barge, truck and rail terminal each have a maximum capacity of containers that they can handle per day, which 20% more than the average number of containers per day. The modality by which a container is transported is assigned to it based on probability. Some days there are more containers assigned to one of the modalities. When that number exceeds the maximum capacity for that day, the containers have to be rescheduled. If the overcapacity was set on more than 20%, there would be less rescheduled containers.

TH

Graph 66 shows that in non-disrupted situation no container have to be rescheduled. That means that the inflow of containers into the sea-side container terminal and the capacity of barges and trains are well matched.

Extreme values test A: High number of containers arrive with each vessel at the sea-side terminal: 2000 per day

MH

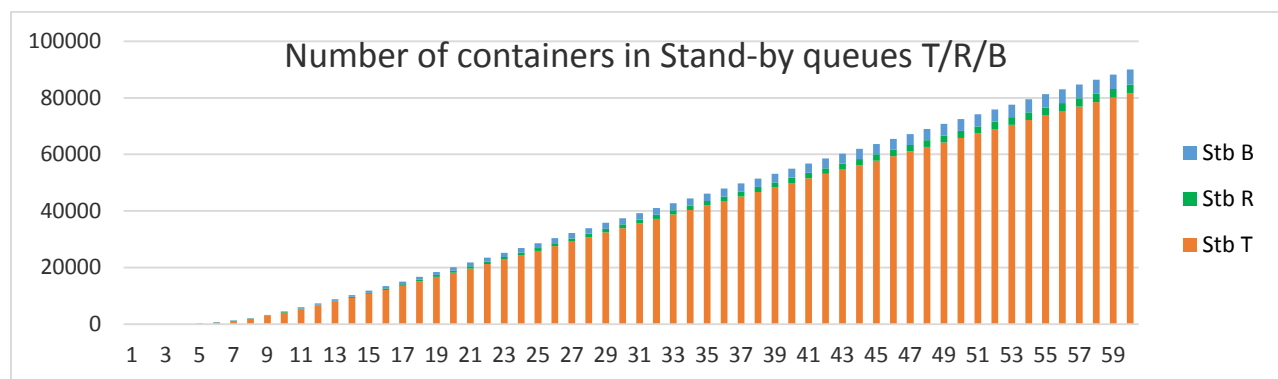

Figure 17

Per day 2000 containers arrive instead of 245 containers. The terminal still have their maximum daily capacity, so the surplus of containers that cannot be transported by their planned modality is rescheduled to be transported mostly by truck. But the truck terminal is also subject to a maximum

capacity. The stand-by stack keeps on growing (see Figure 17). This is what would be expected from a system where inflow and outflow of containers is not well matched.

TH

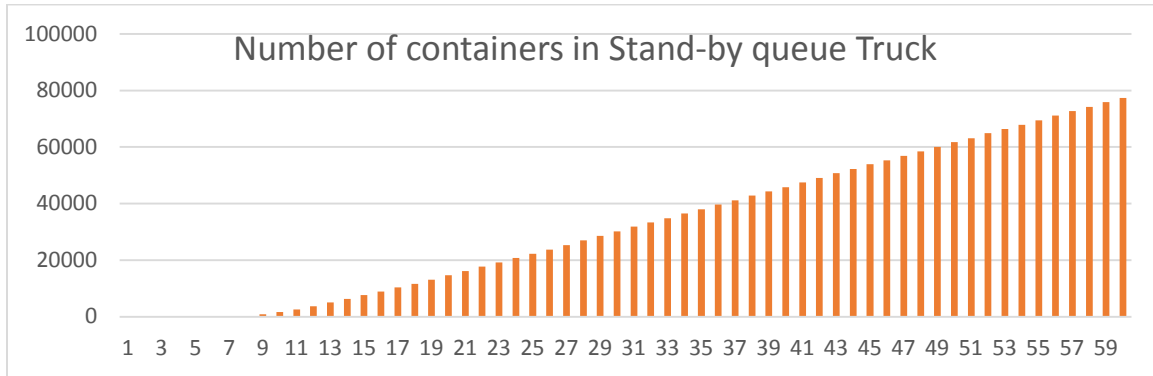

Figure 18

Figure 18 shows that in the TH model the stand-by stack with rescheduled containers keeps on growing due to the mismatch between the number of containers that enter the sea-side terminal (2000 containers) and the capacity of the trains and barges (daily average 245 containers).

Extreme values test B: Transportation time for rail containers is extremely long: 30 days

MH

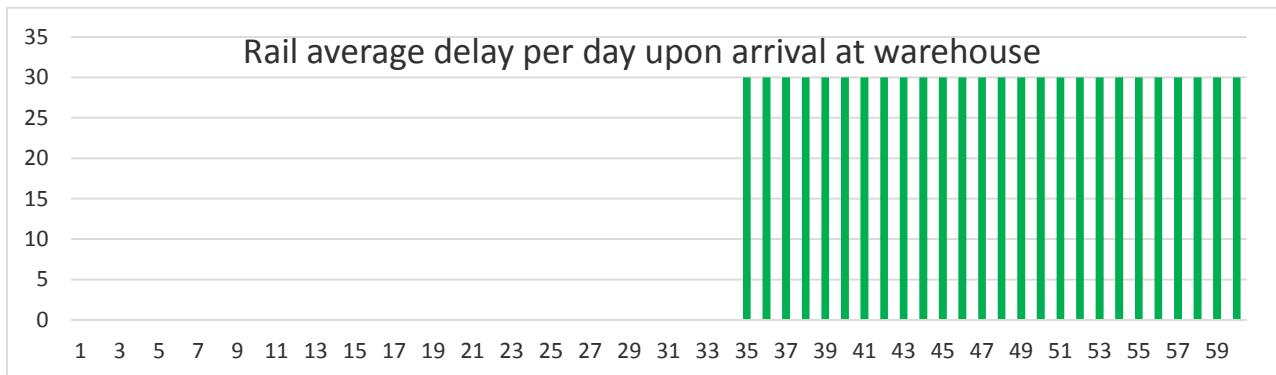

Figure 19

Figure 19 shows the average delay of containers that are transported via rail. The transport time of containers by train is 30 days, as is clearly visible.

TH

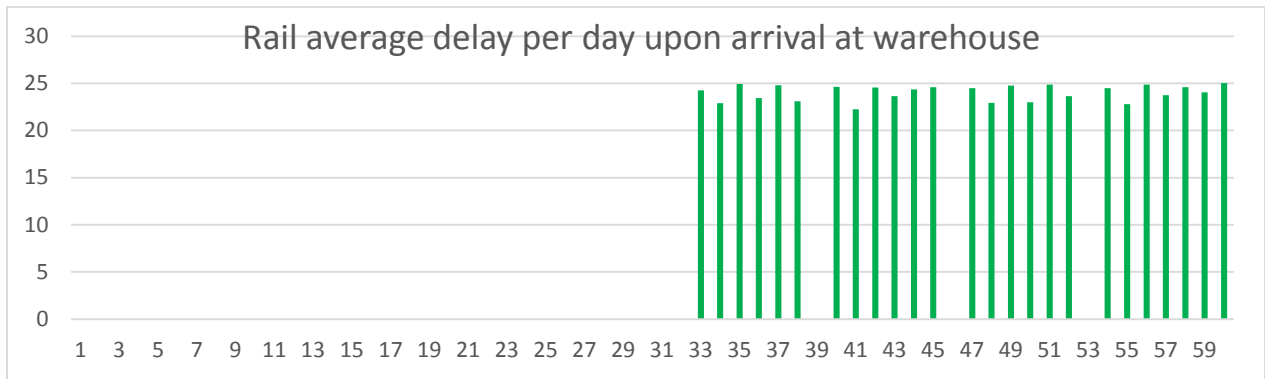

Figure 20

Figure 20 shows the same behaviour as the MH model: containers that are transported by rail arrive with a delay. This delay is less than 30 days, since in the normal situation (S0 run) containers arrive 5 to 7 days in advance.

Extreme values test C: No trucks available during scenario 1 (delay of 1 container)

MH

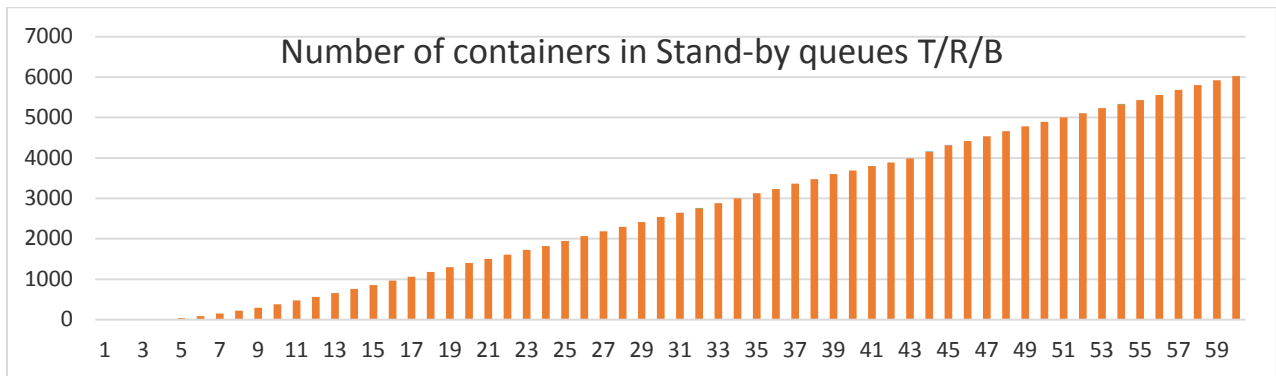

Figure 21

Figure 21 shows the growth of the stand-by stack. The model is run with scenario 1 (delay of a vessel), however, no trucks are available. The stand-by stack for containers that were planned by truck is growing, because the containers that were planned to be transported by truck are never picked up by a truck: they will stay in the stand-by stack for ever. The delay of the vessel on day 36 is not visible in the graph, since that number of containers is relatively small.

TH

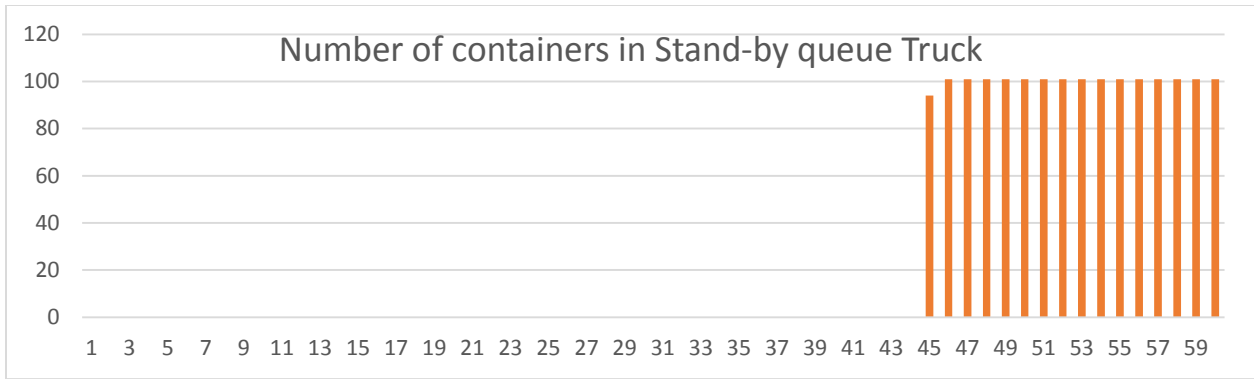

Figure 22

In the TH model the containers are planned to be transported by barge or rail. Trucks are only needed in case of a delay or disruption. Figure 22 shows the number of rescheduled containers in the stand-by stack. Part of the containers on the delayed vessel has to be rescheduled; 101 in total. The number of containers is stable since no containers are added to the stack and no containers are picked up by truck, since there are no trucks available.

Extreme values test D: Only 1 container enters the simulation model

MH

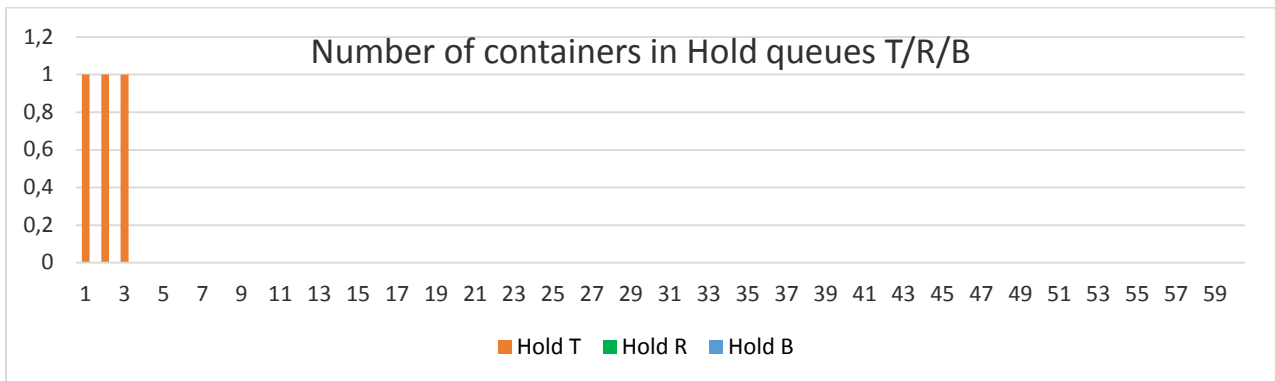

Figure 23

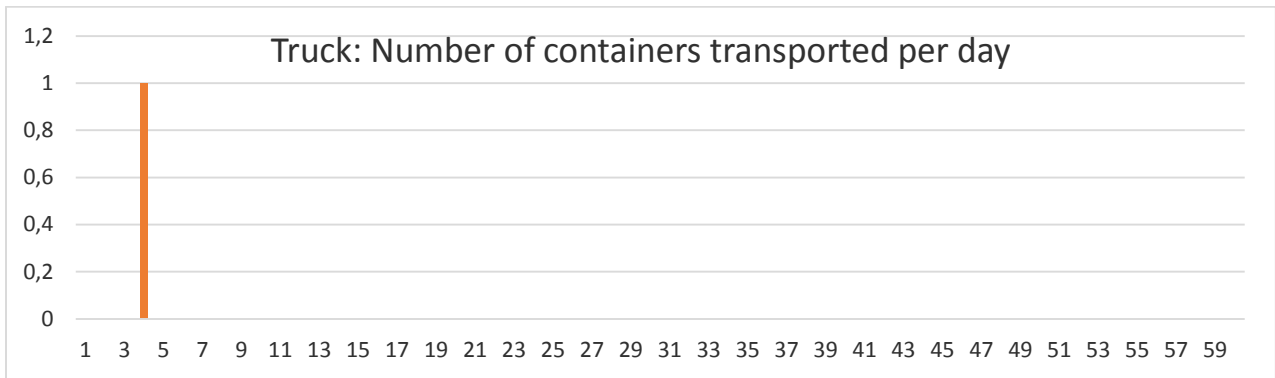

Figure 24

On the first day of the simulation only 1 container arrives at the sea-side terminal. By chance, the container is assigned to be transported by truck. The container stays for three days in the stack (Figure 23). On day 4 it is picked up by the truck and transported to the customer (Figure 24).

TH

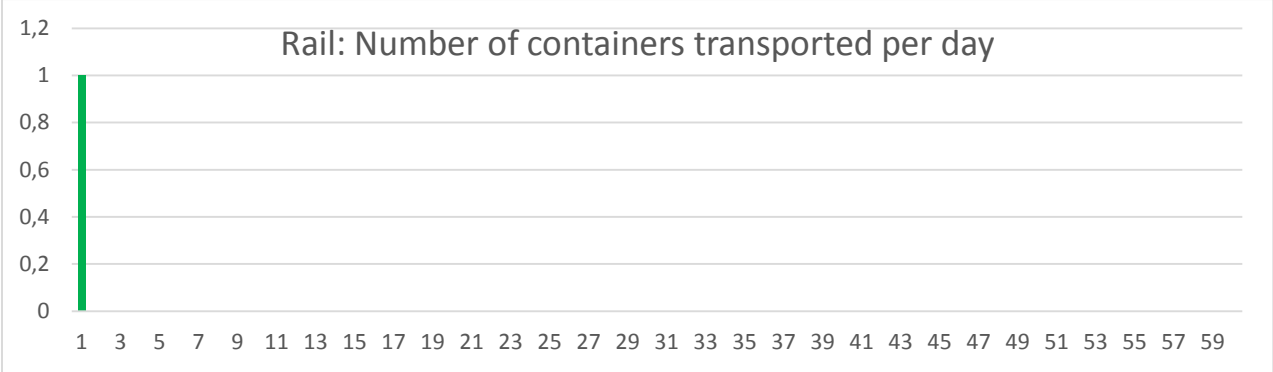

Figure 25

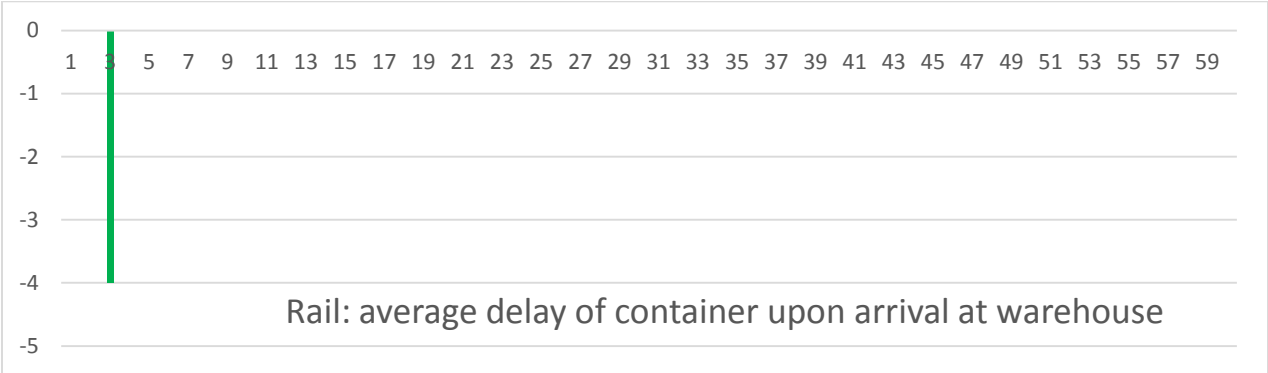

Figure 26

Figure 25 shows the single container that arrives at the sea-side container terminal. It arrives on the first day of the simulation run and it is immediately transported by train. It arrives on day 3 at the customer’s warehouse which is 4 days earlier than the planned arrival day (Figure 26).

Conclusions of the verification tests

From the four tests can be concluded that the model functions as it was designed. During the verifications tests no unexpected behaviour was discovered.

APPENDIX F: RESULTS

For all graphs accounts:

- **x-axis:** Number of the day (1-60)
- **y-axis:** Number of containers, except for the graphs that indicate the average delay that are measured in number of days deviation from planned arrival day. The delay-graphs are: graphs 7-11, 20-23, 36-39, 51-55, 67-69, 77-79, 84 & 85, 92-94, 99 & 100, 107-109, 114 & 115.

The graphs that compare the results of two simulation runs are probably not easy to understand. For example Graph 97 that shows the difference between the S2 and S0 run. The S0 and S2 graphs show the number of containers per day transported by barge from the sea-side container terminal to the inland container terminal. The S2-S0 graph is created to show how much the results of the S0 and S2 run differ. The values of the S0 run are deducted from those of the S2 run. The S2-S0 graph shows that from day 30-36 less containers were transported per day in the S2 run than in the S0 run. From day 37-41 more containers were transported in the S2 run than in the S0 run.

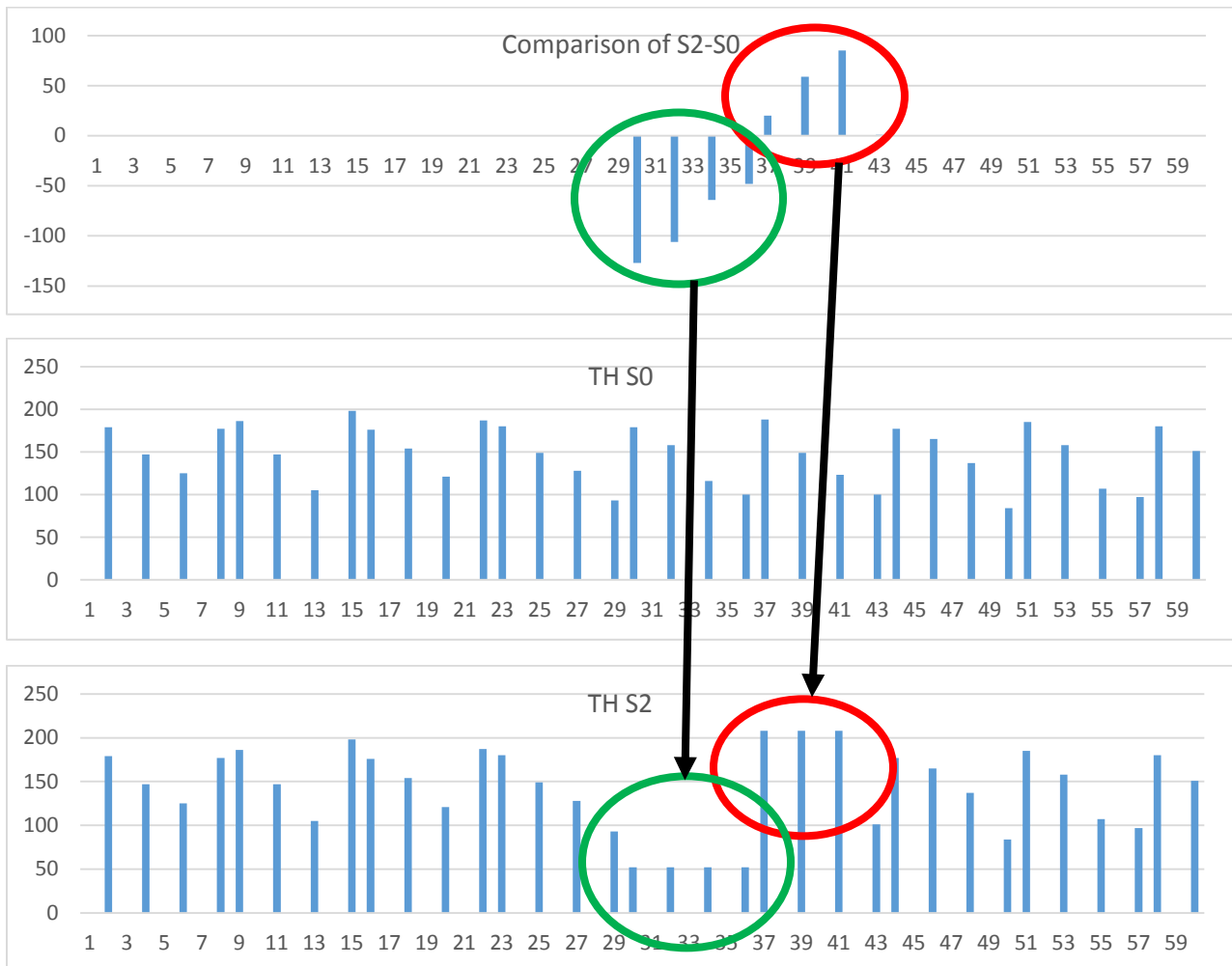

MH – S0 run

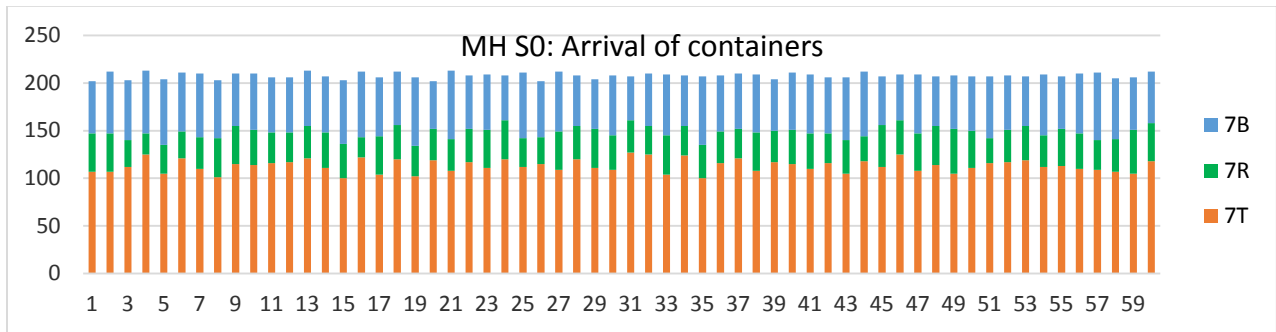

Graph 1: Number of containers per day arriving in stacks at sea-side container terminal

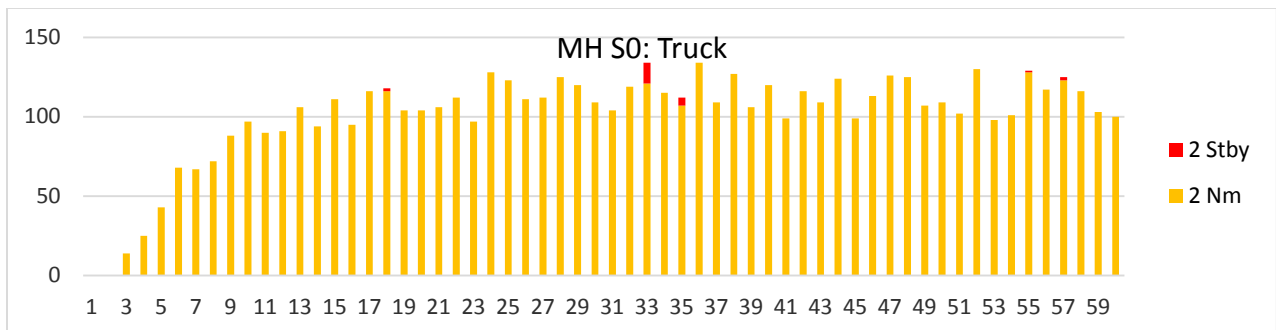

Graph 2: Number of containers per day transported by truck from sea-side container terminal to customer. Planned (Nm) and delayed (Stby) containers.

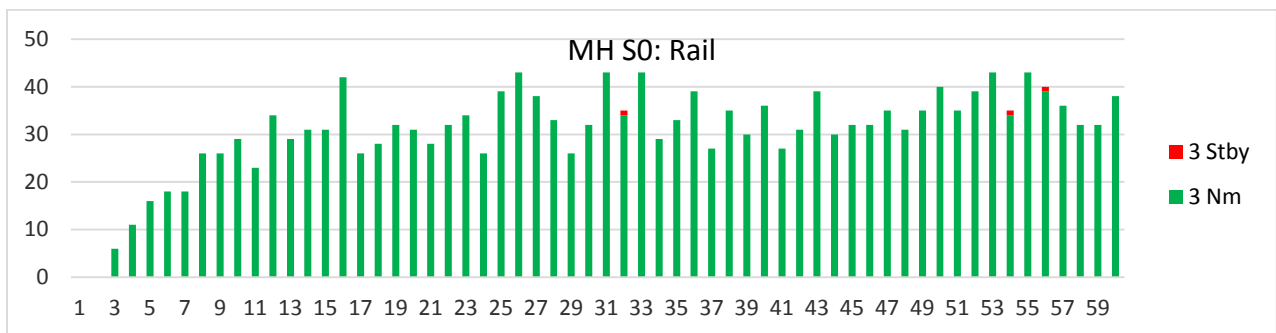

Graph 3: Number of containers per day transported by train from sea-side container terminal to inland container terminal. Planned (Nm) and delayed (Stby) containers.

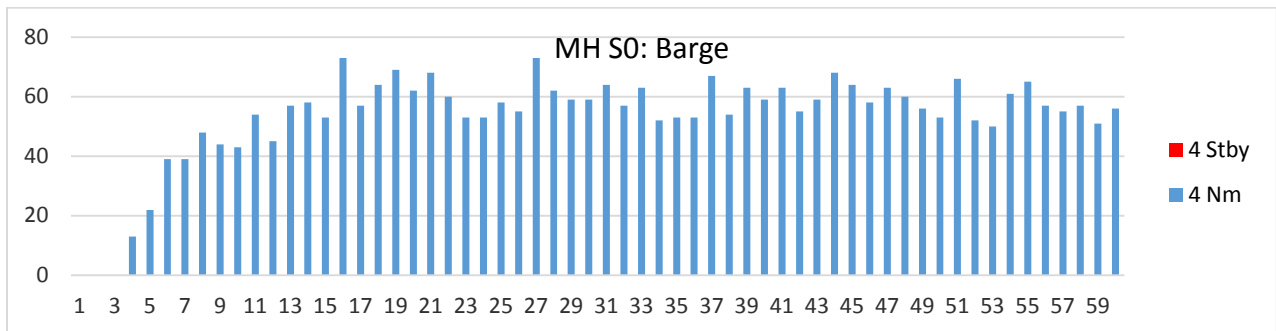

Graph 4: Number of containers per day transported by barge from sea-side container terminal to inland container terminal. Planned (Nm) and delayed (Stby) containers.

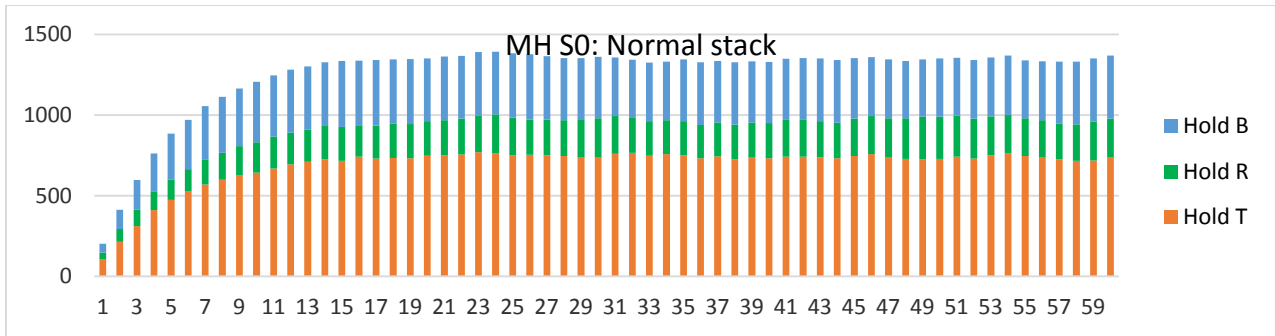

Graph 5: Number of non delayed containers in stack, divided according to planned hinterland modality.

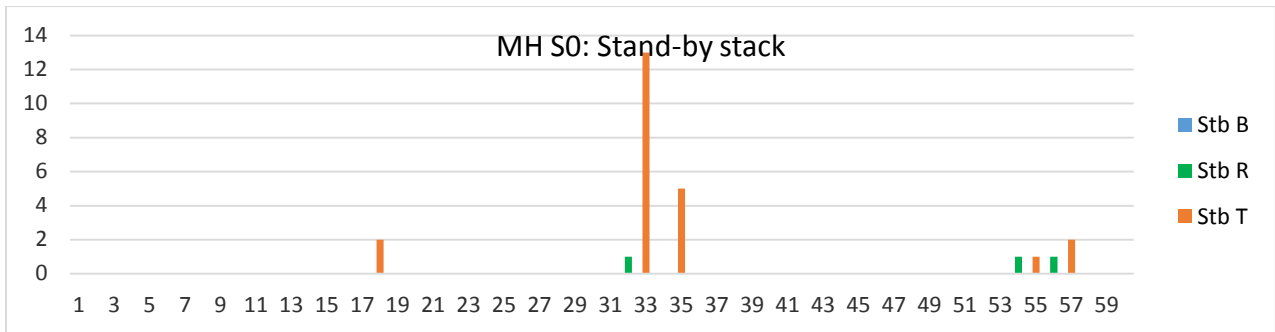

Graph 6: Number of delayed (stand-by) containers in stack, divided according to planned hinterland modality.

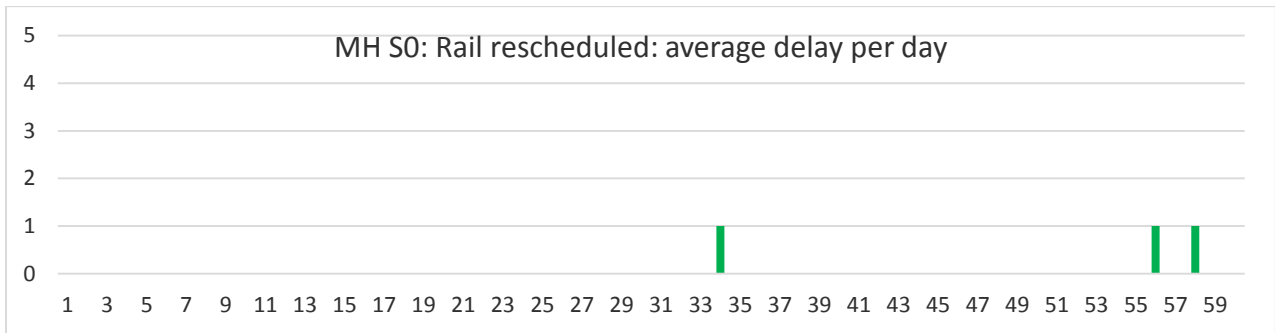

Graph 7: Number of containers that are delayed and rescheduled to be transported by rail.

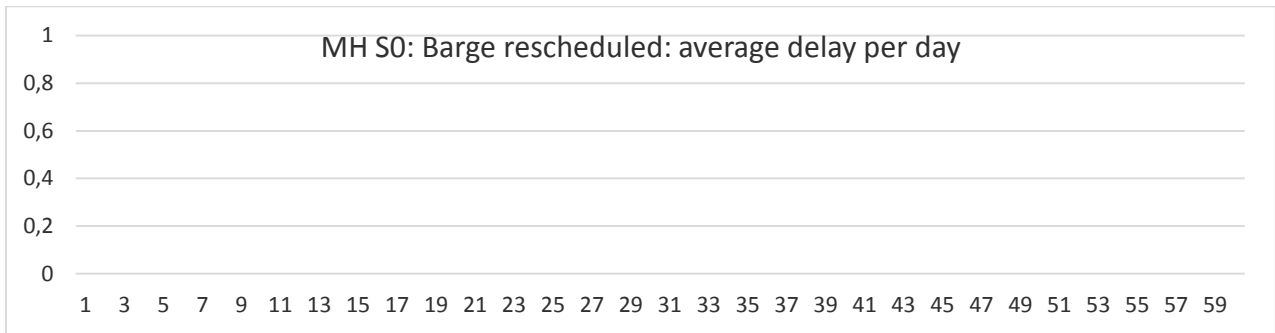

Graph 8: Number of containers that are delayed and rescheduled to be transported by barge.

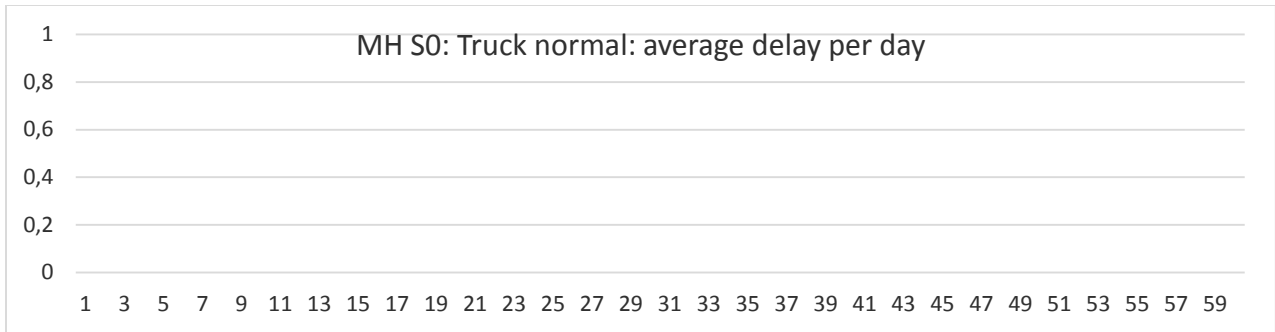

Graph 9: For containers planned and transported by truck: average delay per day of the containers upon arrival at the customer.

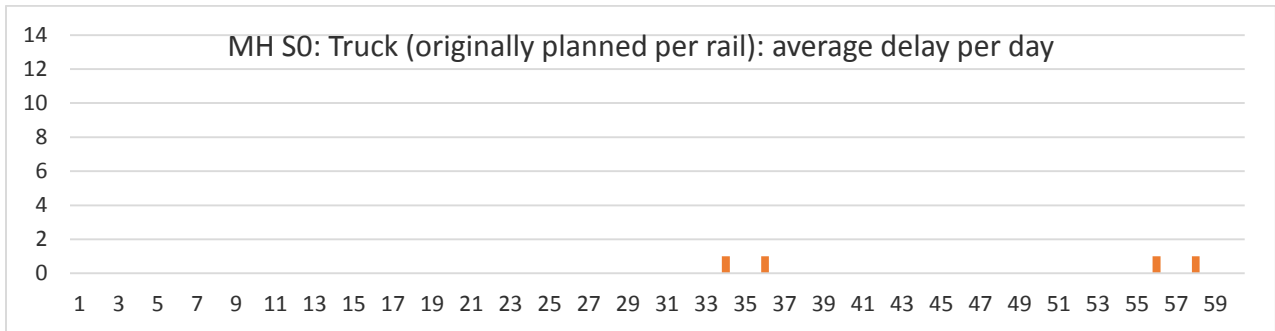

Graph 10: For containers planned by rail and transported by truck: average delay per day of the containers upon arrival at the customer.

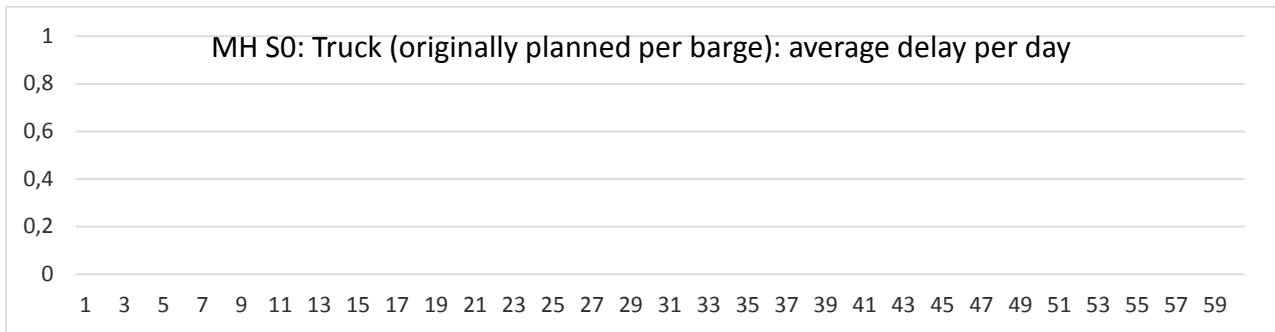

Graph 11: For containers planned by barge and transported by truck: average delay per day of the containers upon arrival at the customer.

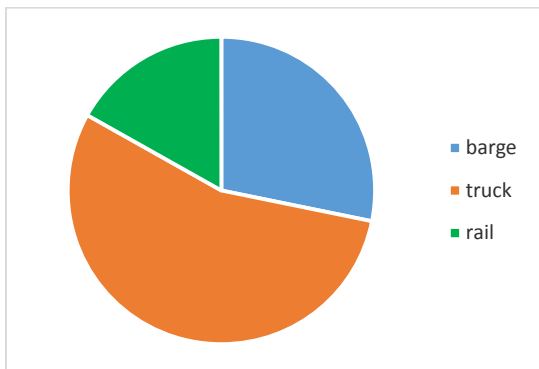

Modal split (day 25-60)

barge	truck	rail
28.21%	54.94%	16.85%

Graph 12: Modal split (day 25-60)

MH – S1 run

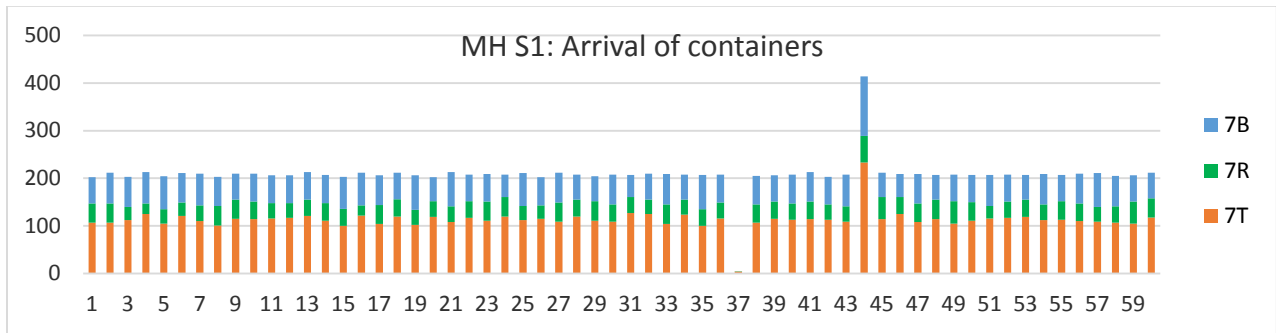

Graph 13: Number of containers per day arriving in stacks at sea-side container terminal

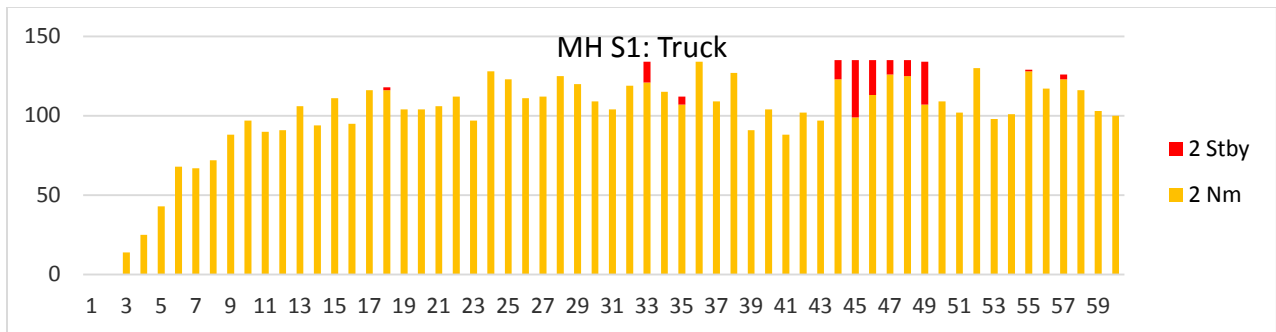

Graph 14: Number of containers per day transported by truck from sea-side container terminal to customer. Planned (Nm) and delayed (Stby) containers.

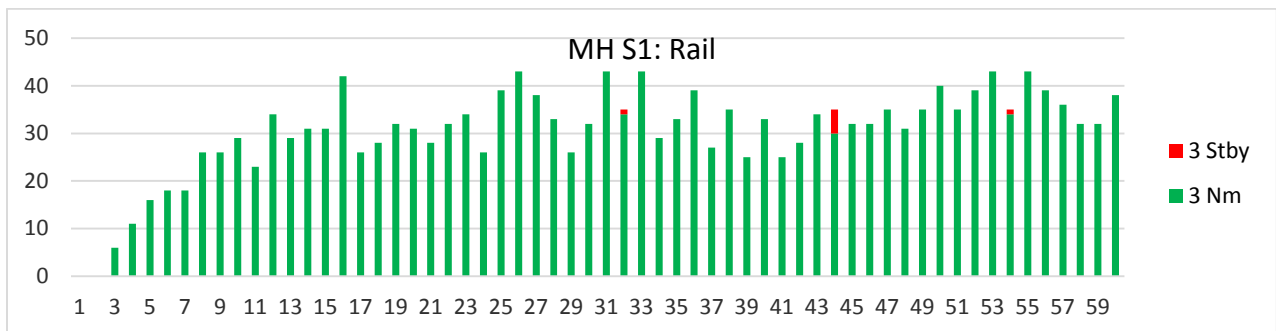

Graph 15: Number of containers per day transported by train from sea-side container terminal to inland container terminal. Planned (Nm) and delayed (Stby) containers.

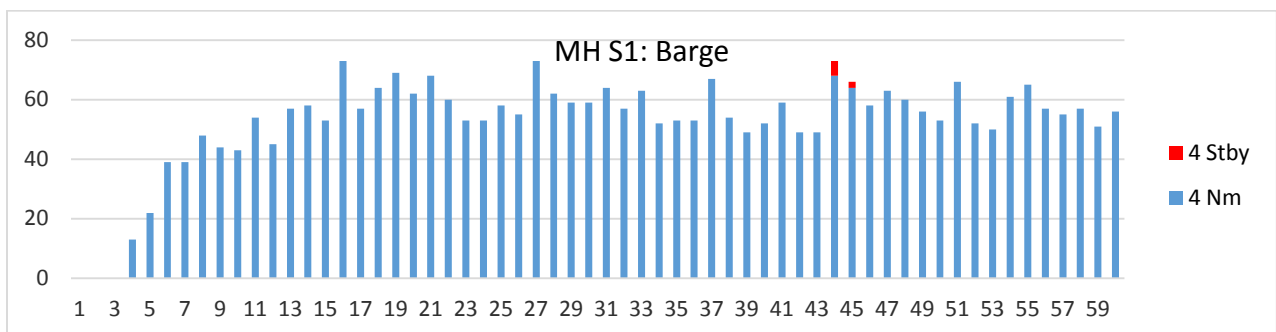

Graph 16: Number of containers per day transported by barge from sea-side container terminal to inland container terminal. Planned (Nm) and delayed (Stby) containers.

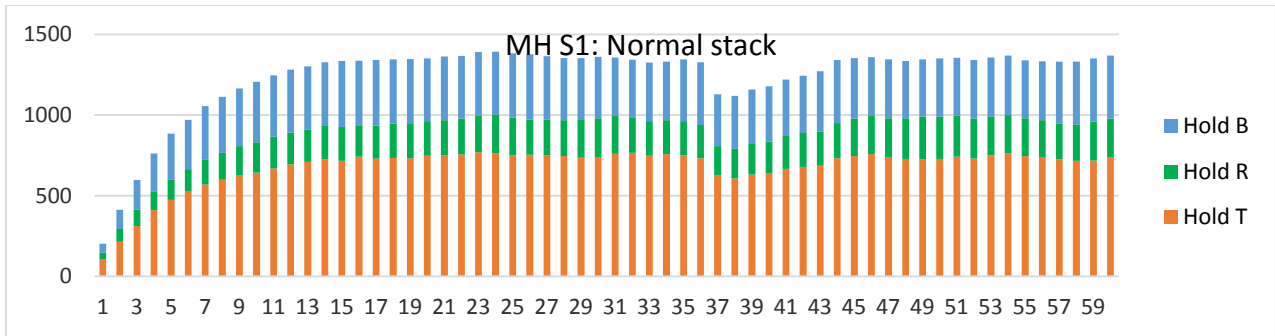

Graph 17: Number of non delayed containers in stack, divided according to planned hinterland modality.

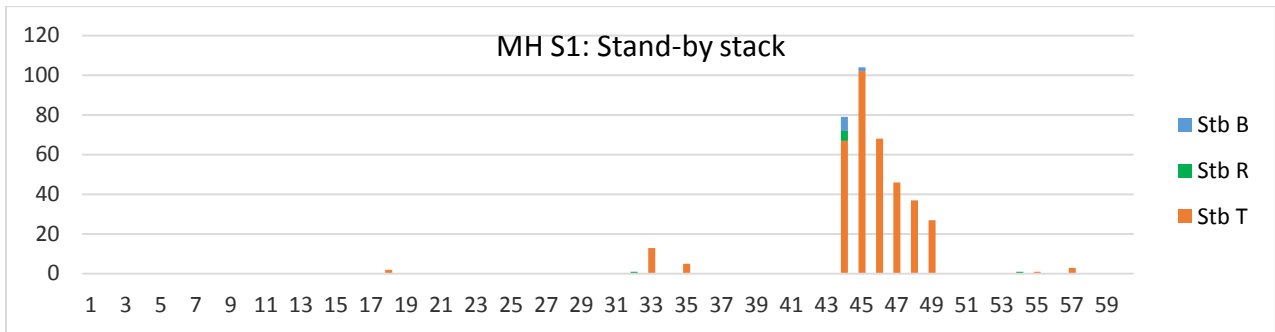

Graph 18: Number of delayed/stand-by containers in stack, divided according to planned hinterland modality.

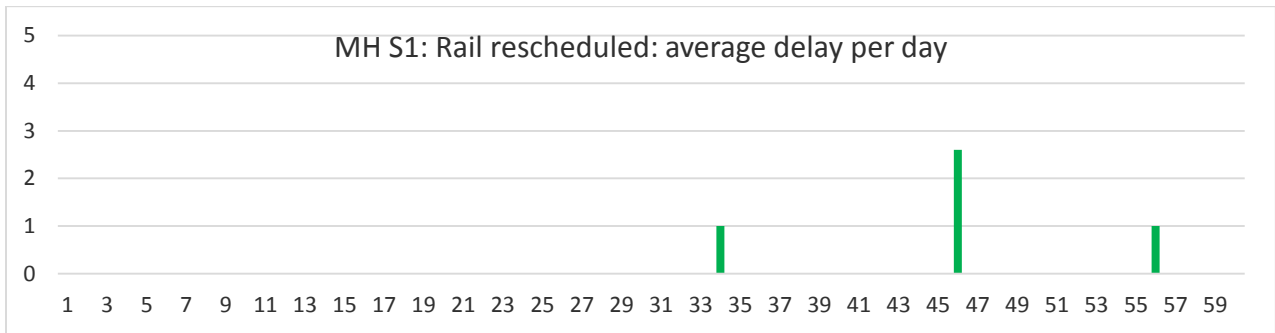

Graph 19: Number of containers that are delayed and rescheduled to be transported by rail.

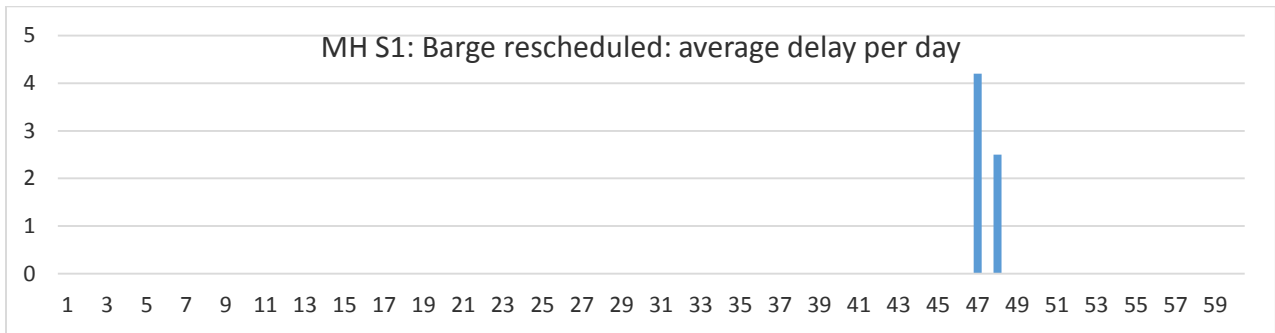

Graph 20: Number of containers that are delayed and rescheduled to be transported by barge.

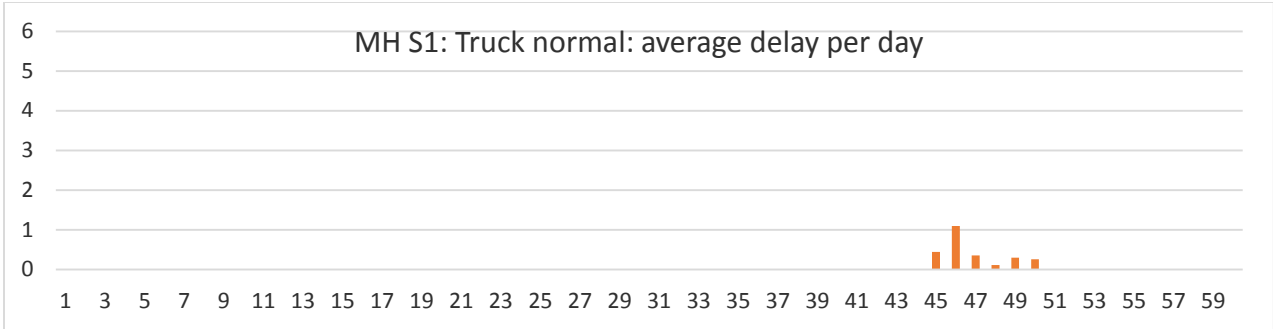

Graph 21: For containers planned and transported by truck: average delay per day of the containers upon arrival at the customer.

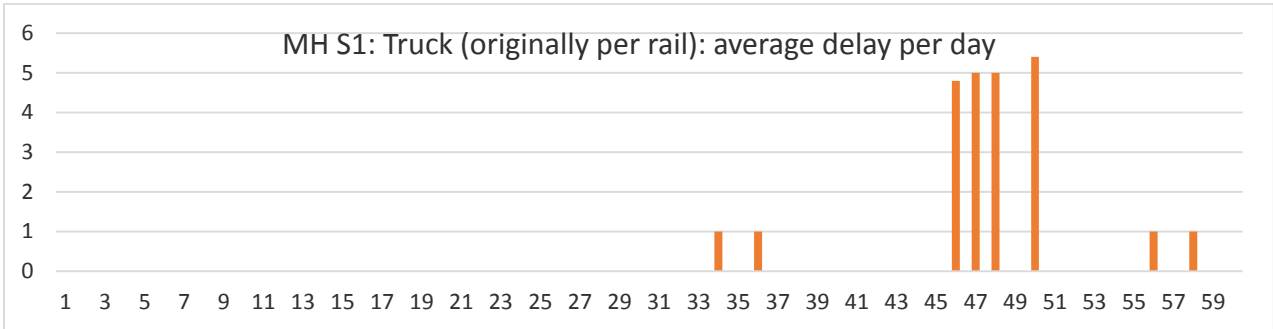

Graph 22: For containers planned by train and transported by truck: average delay per day of the containers upon arrival at the customer.

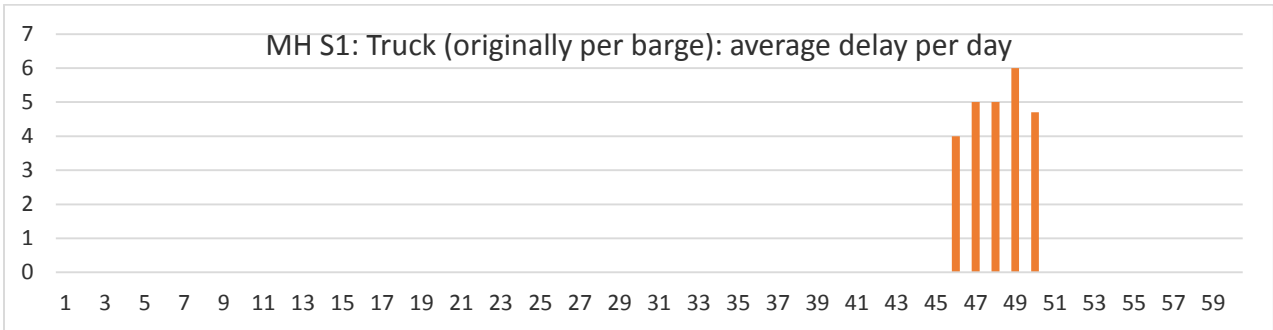

Graph 23: For containers planned by barge and transported by truck: average delay per day of the containers upon arrival at the customer.

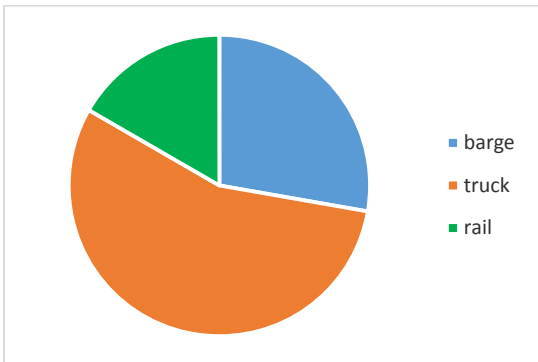

Modal split (day 25-60)

barge	truck	rail
27.76%	55.58%	16.66%

Graph 24: Modal split (day 25-60)

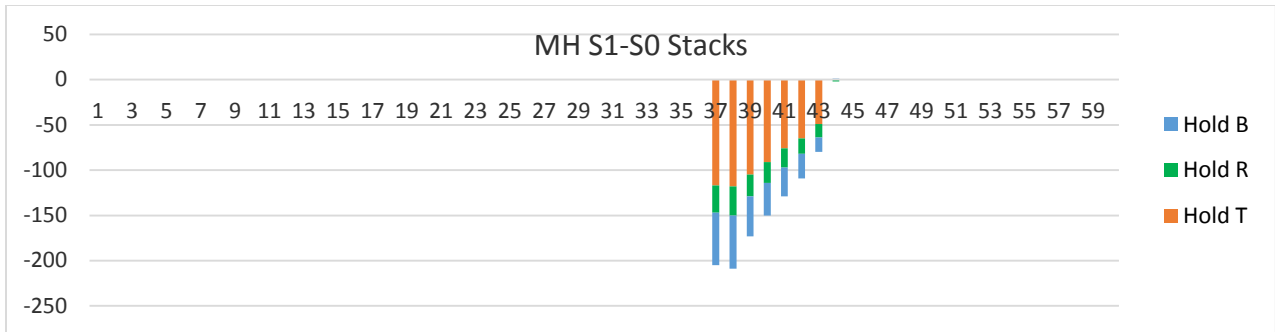

Graph 25: Difference between S1 and S0. Number of non delayed containers in stack, divided according to planned hinterland modality.

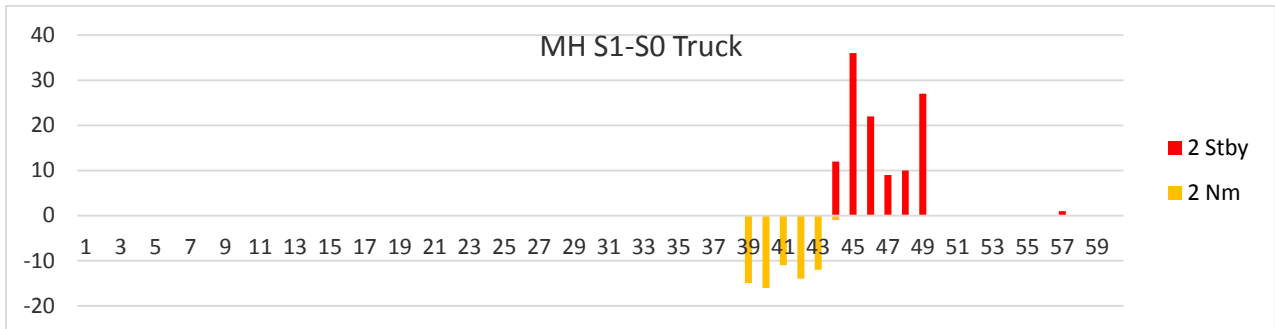

Graph 26: Difference between S1 and S0. Number of containers per day transported by truck from sea-side container terminal to customer. Planned (Nm) and delayed (Stby) containers.

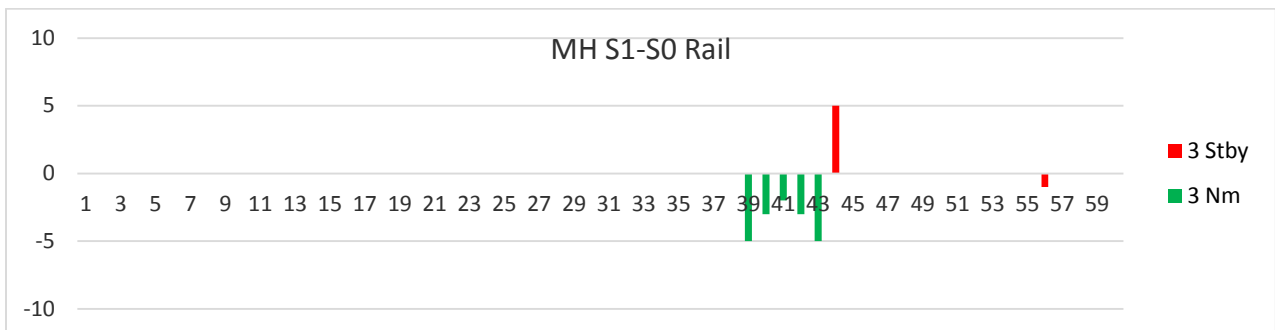

Graph 27: Difference between S1 and S0. Number of containers per day transported by train from sea-side container terminal to inland container terminal. Planned (Nm) and delayed (Stby) containers.

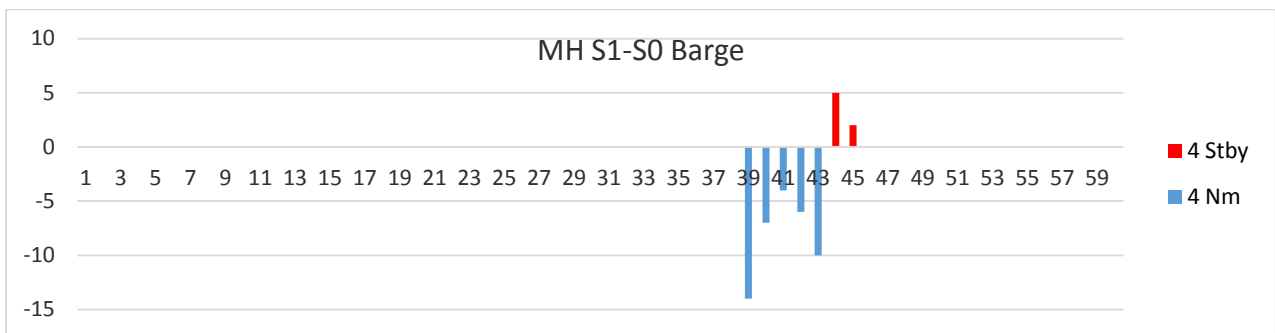

Graph 28: Difference between S1 and S0. Number of containers per day transported by barge from sea-side container terminal to inland container terminal. Planned (Nm) and delayed (Stby) containers.

MH – S2 run

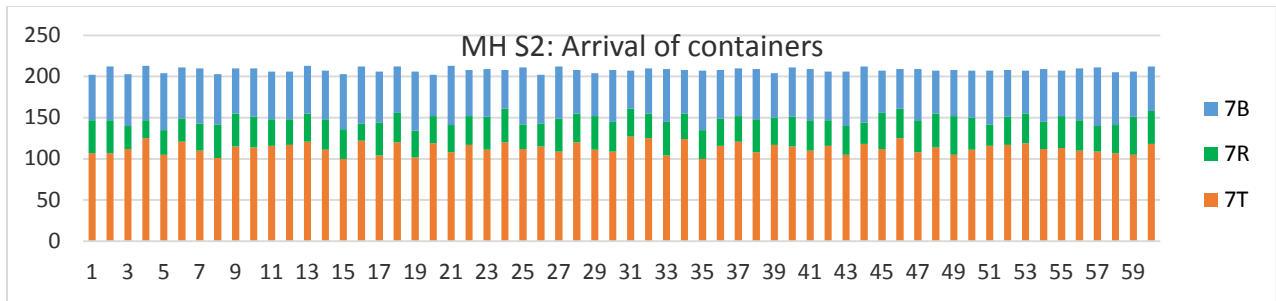

Graph 29: Number of containers per day arriving in stacks at sea-side container terminal

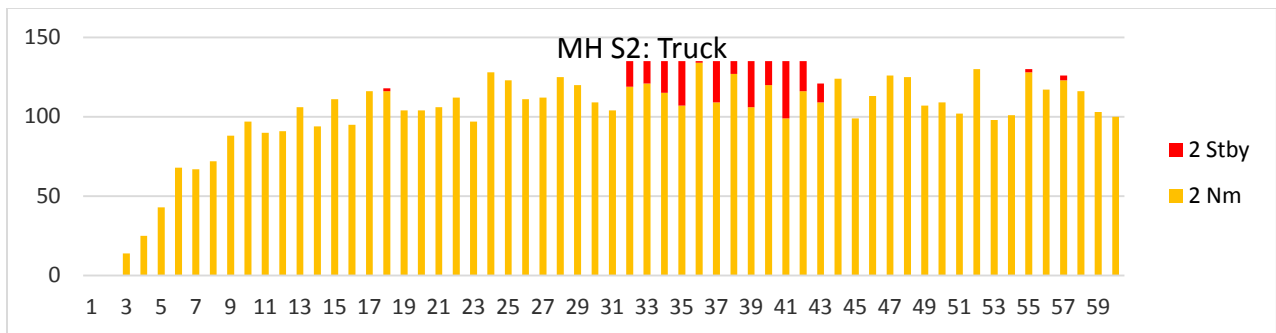

Graph 30: Number of containers per day transported by truck from sea-side container terminal to customer. Planned (Nm) and delayed (Stby) containers.

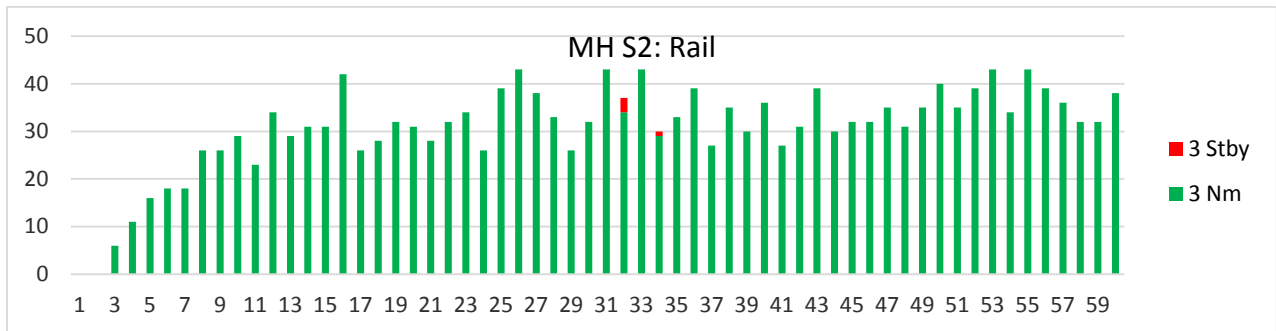

Graph 31: Number of containers per day transported by train from sea-side container terminal to inland container terminal. Planned (Nm) and delayed (Stby) containers.

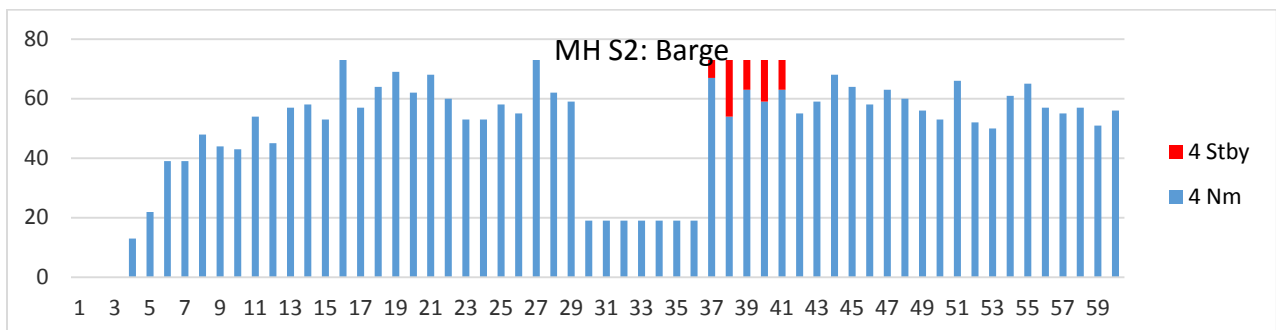

Graph 32: Number of containers per day transported by barge from sea-side container terminal to inland container terminal. Planned (Nm) and delayed (Stby) containers.

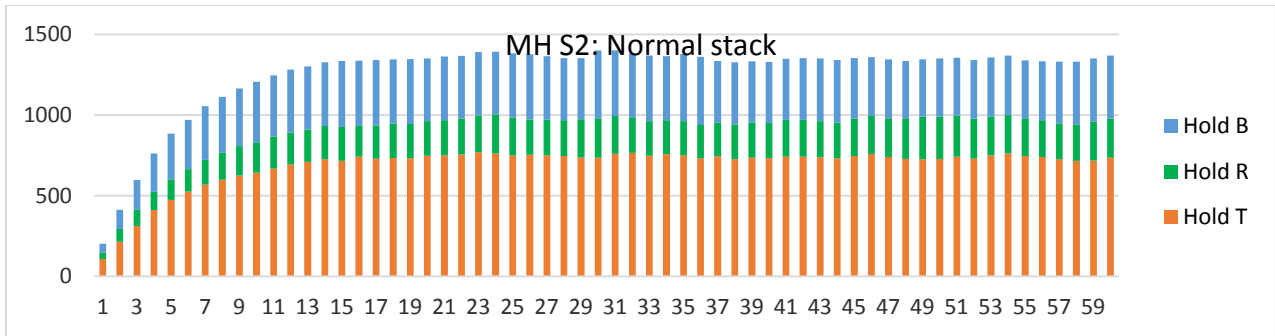

Graph 33: Number of non delayed containers in stack, divided according to planned hinterland modality.

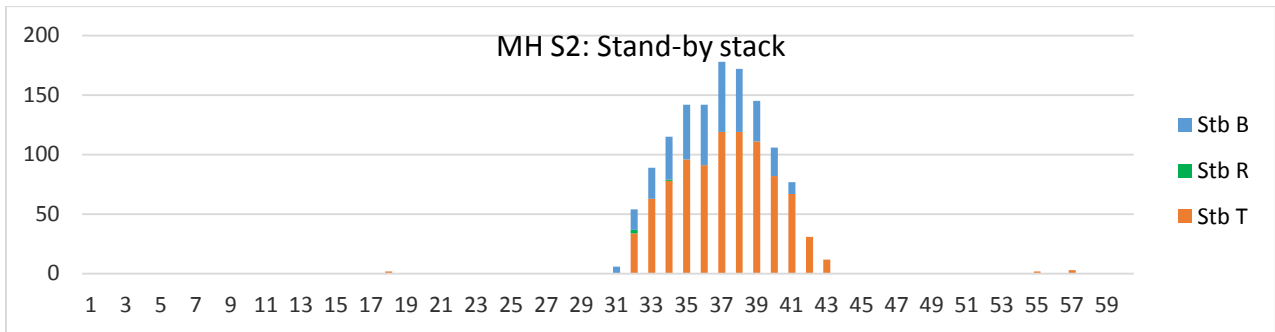

Graph 34: Number of delayed/stand-by containers in stack, divided according to planned hinterland modality.

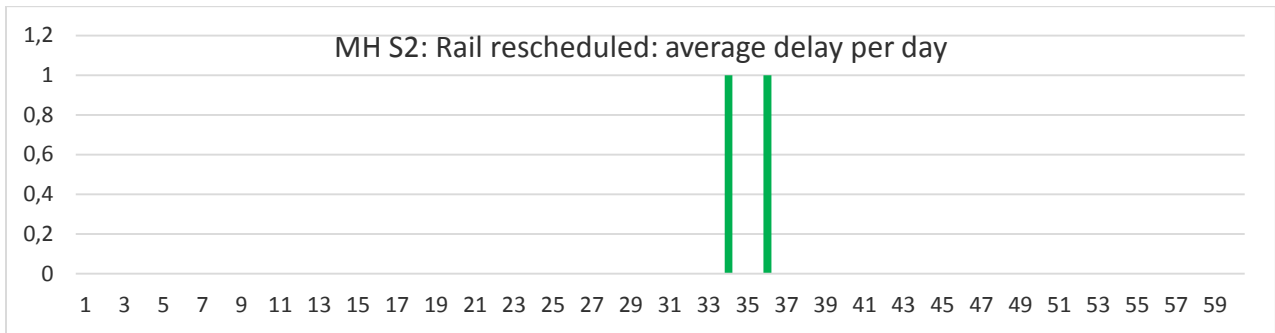

Graph 35: Number of containers that are delayed and rescheduled to be transported by rail.

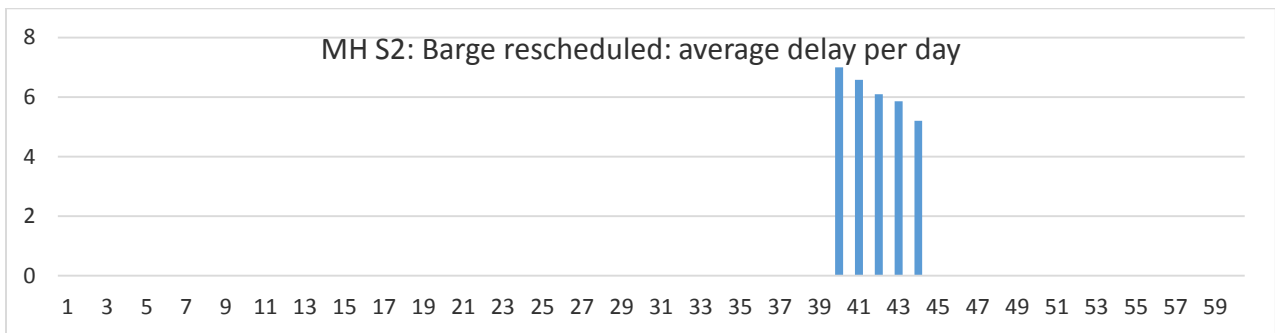

Graph 36: Number of containers that are delayed and rescheduled to be transported by barge.

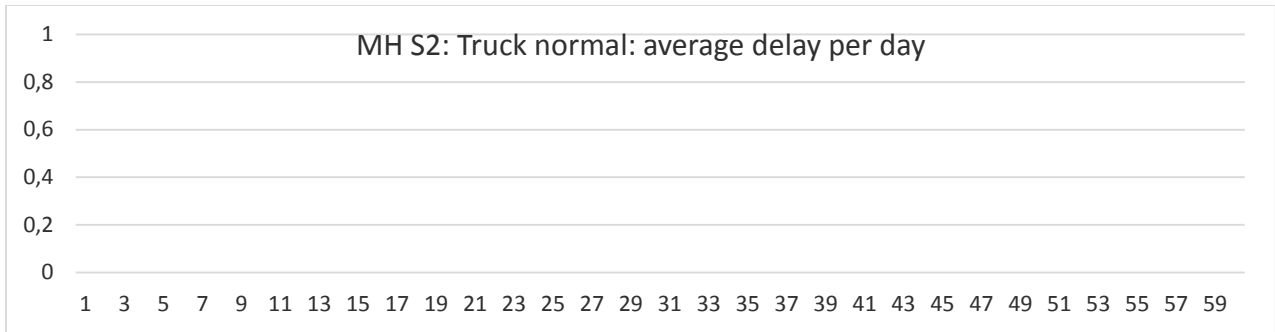

Graph 37: For containers planned and transported by truck: average delay per day of the containers upon arrival at the customer.

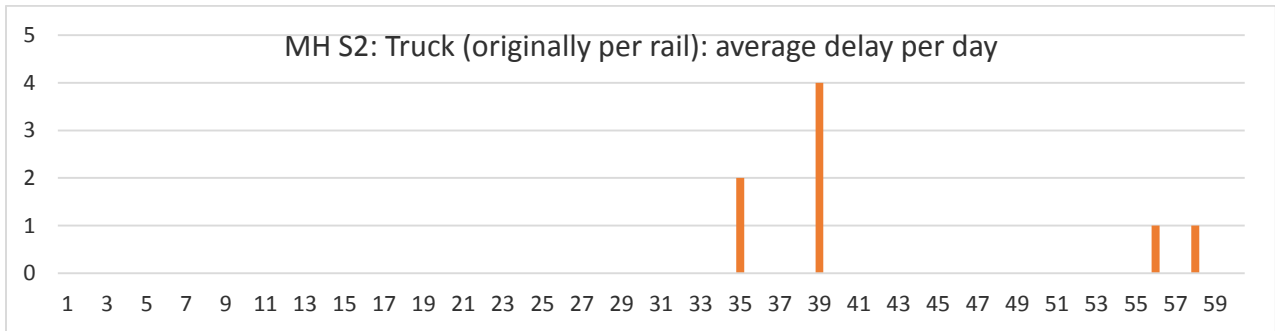

Graph 38: For containers planned by train and transported by truck: average delay per day of the containers upon arrival at the customer.

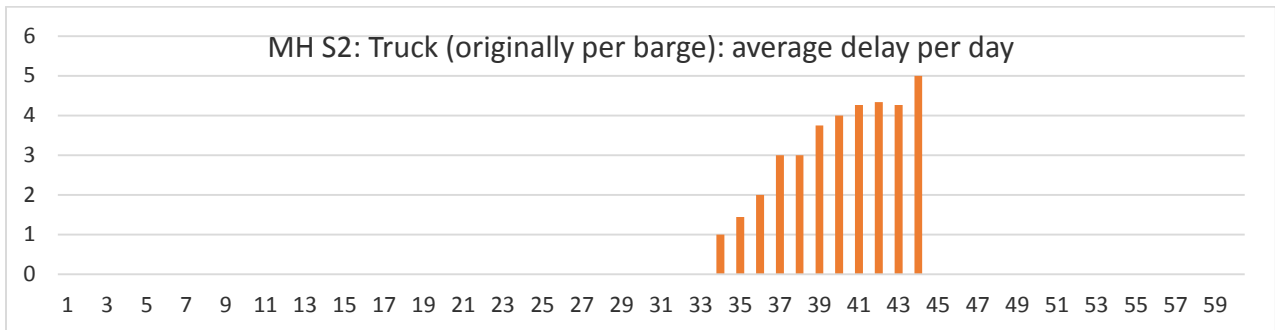

Graph 39: For containers planned by barge and transported by truck: average delay per day of the containers upon arrival at the customer.

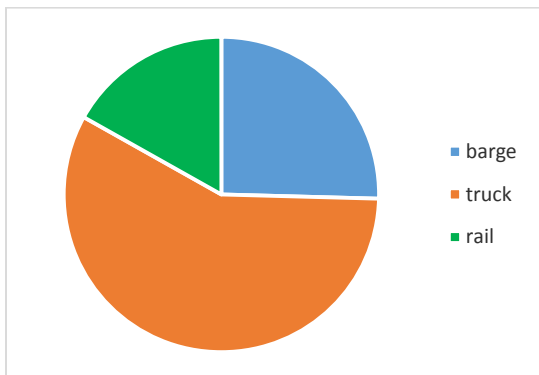

Modal split (day 25-60)

barge	truck	rail
25.43%	57.71%	16.86%

Graph 40: Modal split (day 25-60)

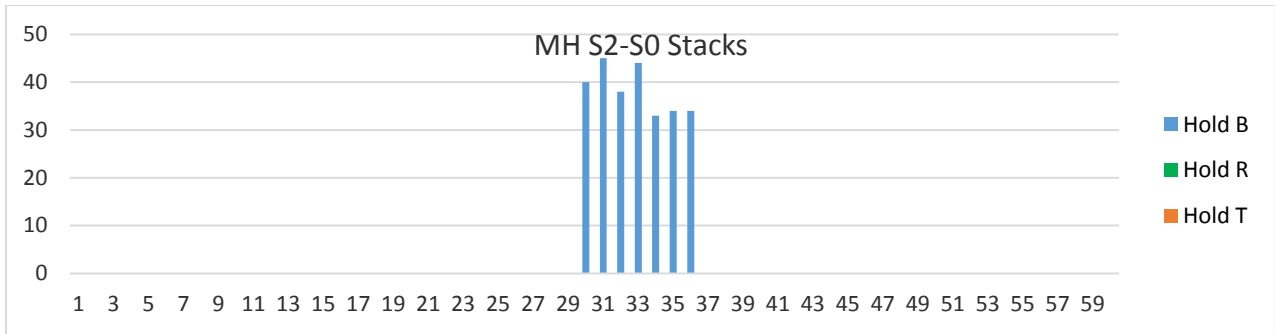

Graph 41: Difference between S2 and S0. Number of non delayed containers in stack, divided according to planned hinterland modality.

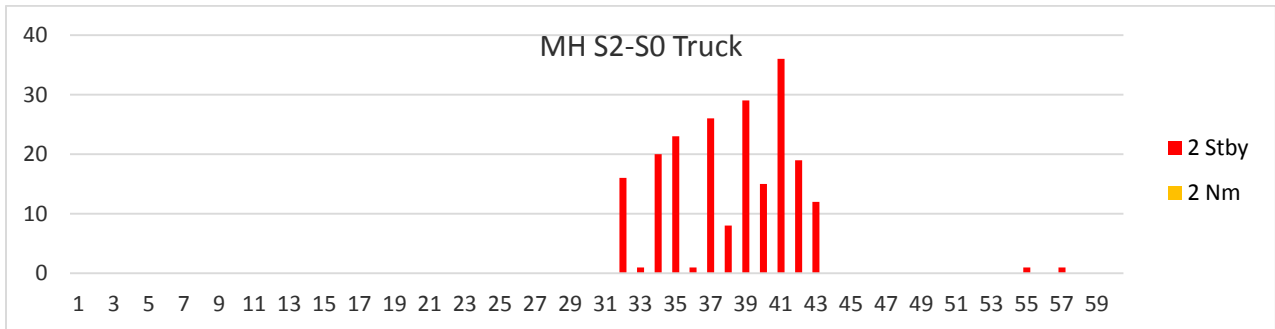

Graph 42: Difference between S2 and S0. Number of containers per day transported by truck from sea-side container terminal to customer. Planned (Nm) and delayed (Stby) containers.

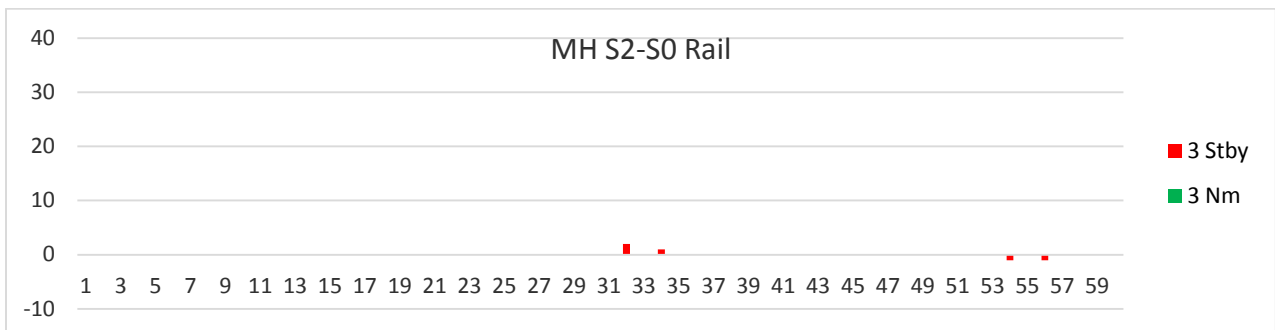

Graph 43: Difference between S2 and S0. Number of containers per day transported by train from sea-side container terminal to inland container terminal. Planned (Nm) and delayed (Stby) containers.

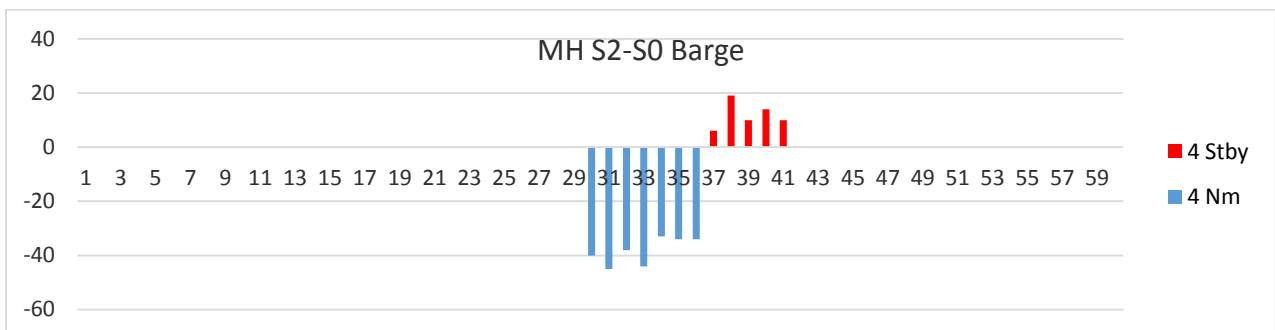

Graph 44: Difference between S2 and S0. Number of containers per day transported by barge from sea-side container terminal to inland container terminal. Planned (Nm) and delayed (Stby) containers.

MH – S3 run

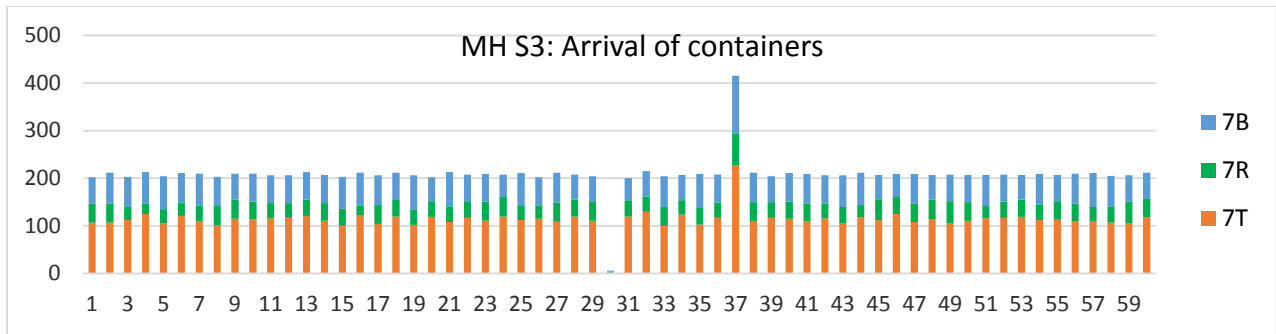

Graph 45: Number of containers per day arriving in stacks at sea-side container terminal

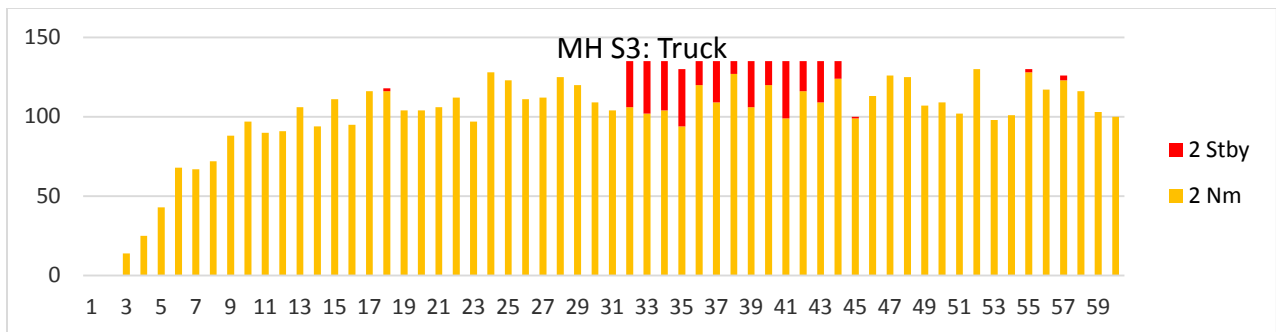

Graph 46: Number of containers per day transported by truck from sea-side container terminal to customer. Planned (Nm) and delayed (Stby) containers.

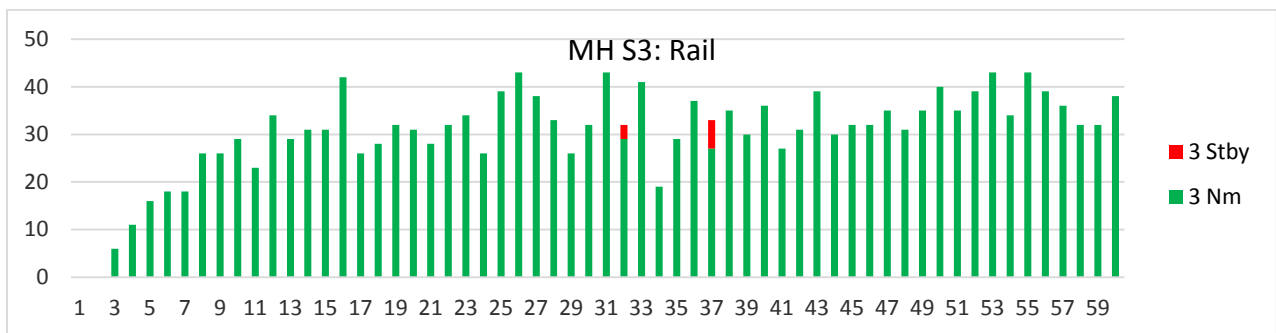

Graph 47: Number of containers per day transported by train from sea-side container terminal to inland container terminal. Planned (Nm) and delayed (Stby) containers.

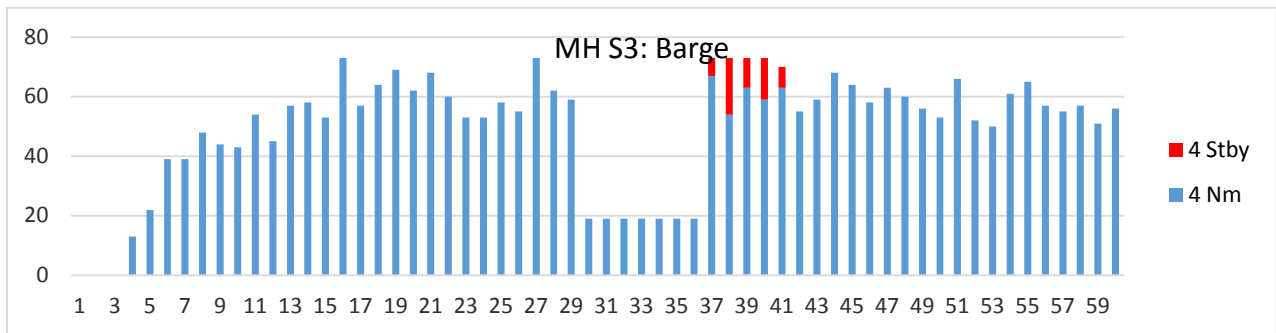

Graph 48: Number of containers per day transported by barge from sea-side container terminal to inland container terminal. Planned (Nm) and delayed (Stby) containers.

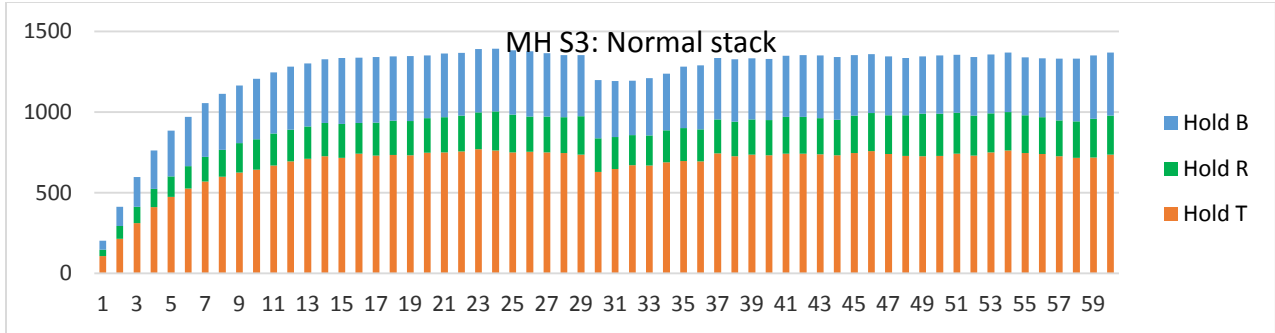

Graph 49: Number of non delayed containers in stack, divided according to planned hinterland modality.

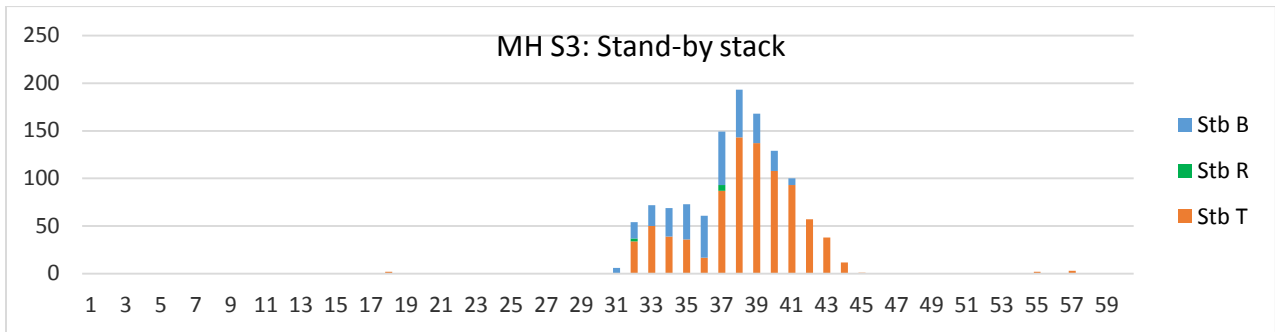

Graph 50: Number of delayed/stand-by containers in stack, divided according to planned hinterland modality.

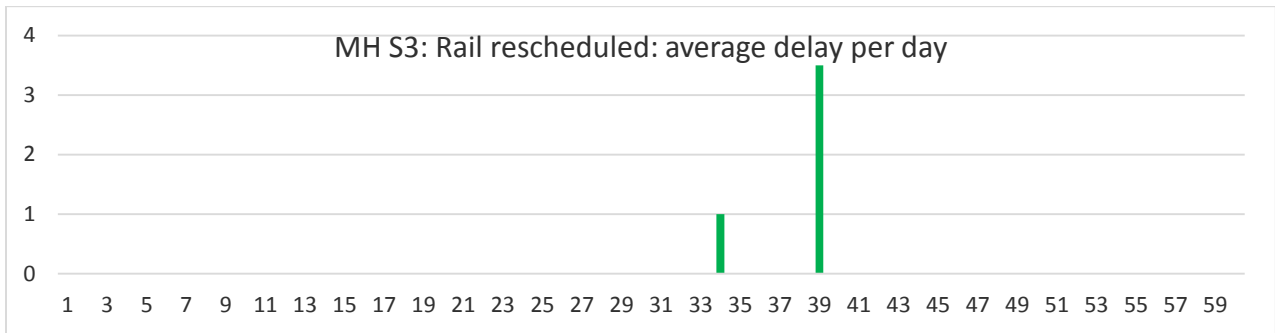

Graph 51: Number of containers that are delayed and rescheduled to be transported by rail.

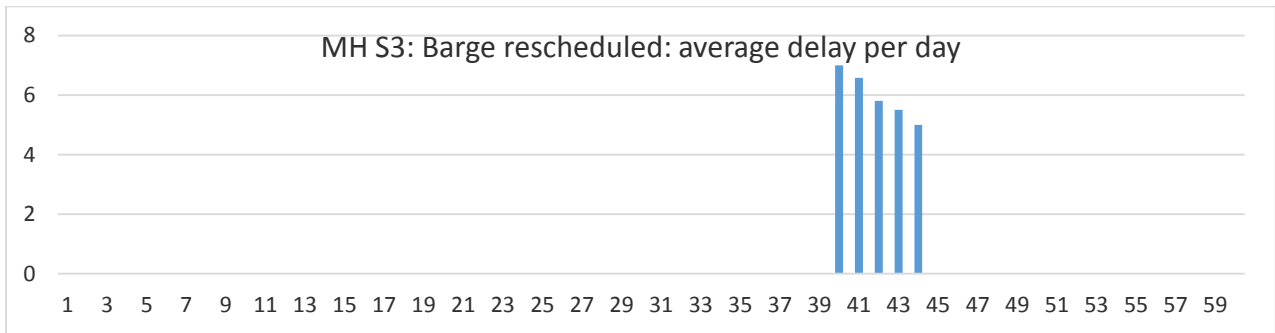

Graph 52: Number of containers that are delayed and rescheduled to be transported by barge.

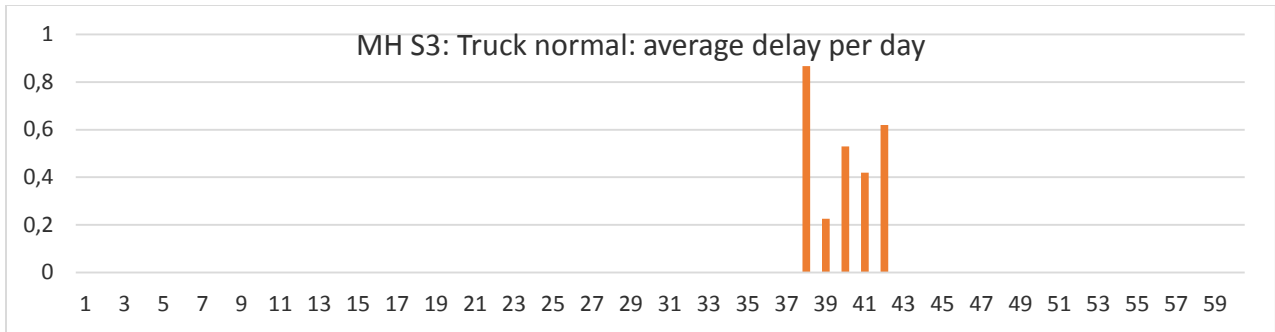

Graph 53: For containers planned and transported by truck: average delay per day of the containers upon arrival at the customer.

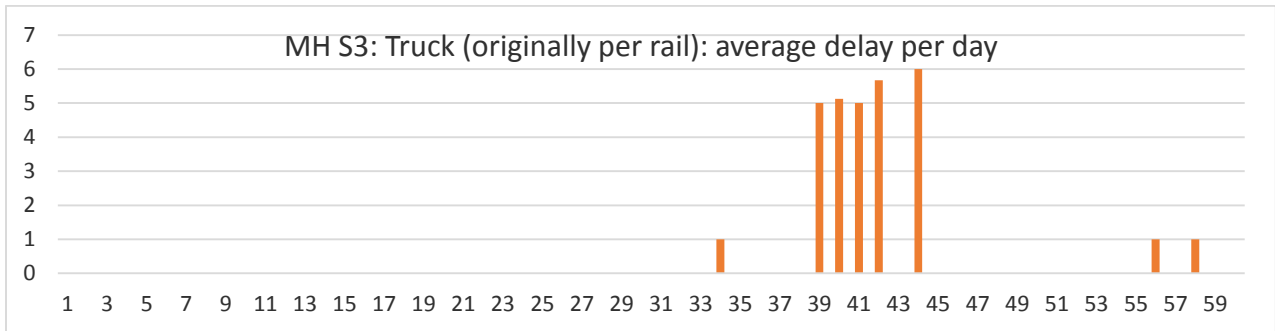

Graph 54: For containers planned by train and transported by truck: average delay per day of the containers upon arrival at the customer.

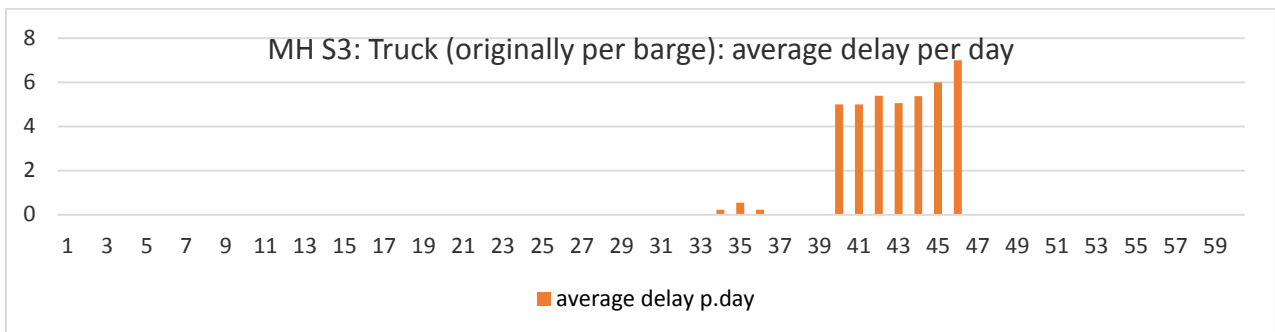

Graph 55: For containers planned by barge and transported by truck: average delay per day of the containers upon arrival at the customer.

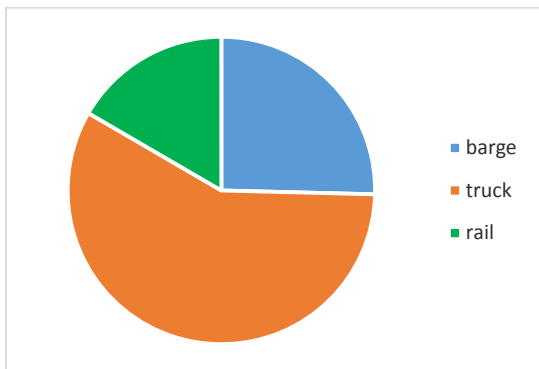

Modal split (day 25-60)

barge	truck	rail
25.39%	57.99%	16.62%

Graph 56: Modal split (day 25-60)

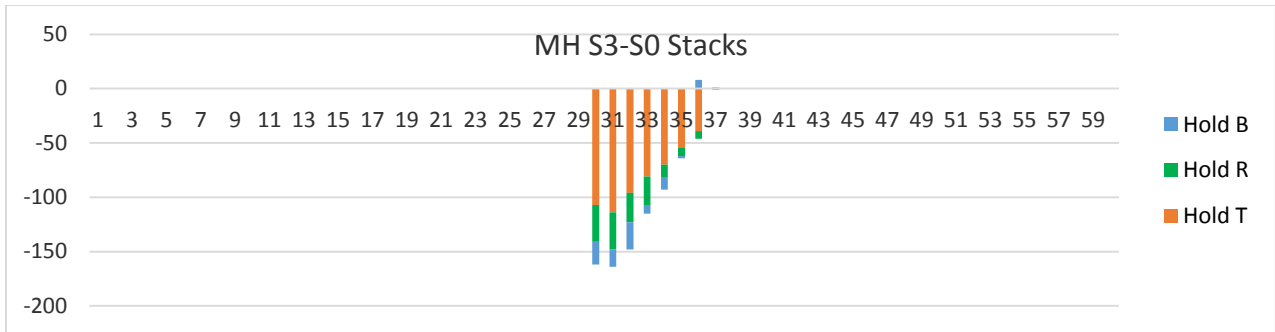

Graph 57: Difference between S3 and S0. Number of non delayed containers in stack, divided according to planned hinterland modality.

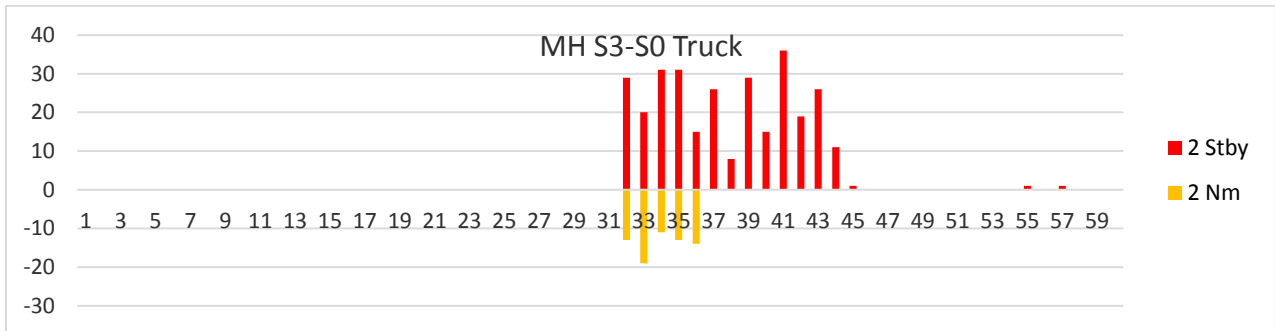

Graph 58: Difference between S3 and S0. Number of containers per day transported by truck from sea-side container terminal to customer. Planned (Nm) and delayed (Stby) containers.

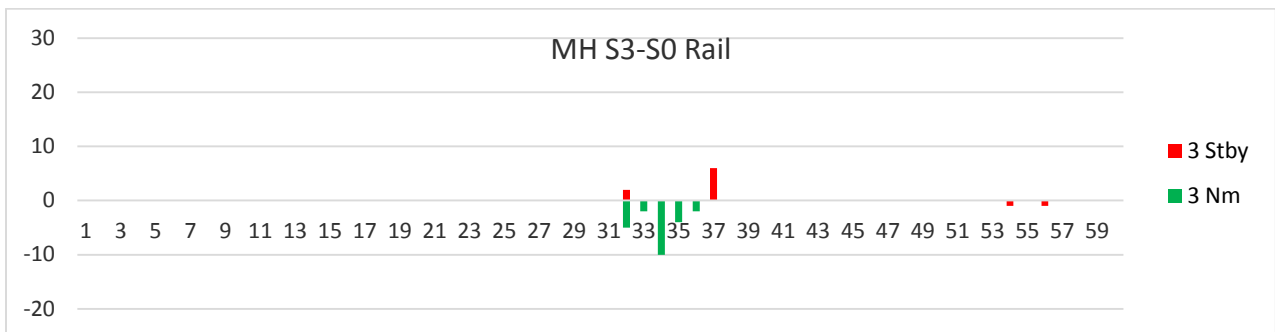

Graph 59: Difference between S3 and S0. Number of containers per day transported by train from sea-side container terminal to inland container terminal. Planned (Nm) and delayed (Stby) containers.

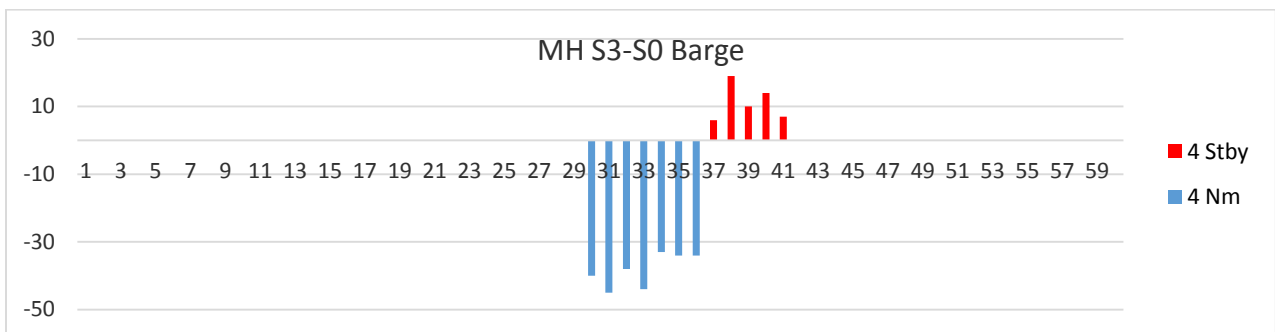

Graph 60: Difference between S3 and S0. Number of containers per day transported by barge from sea-side container terminal to inland container terminal. Planned (Nm) and delayed (Stby) containers.

TH – S0 run

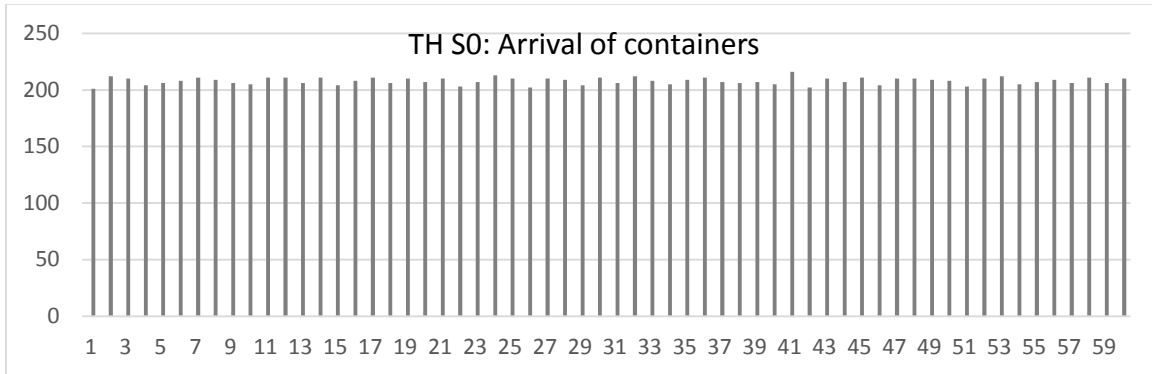

Graph 61: Number of containers per day arriving in stacks at sea-side container terminal

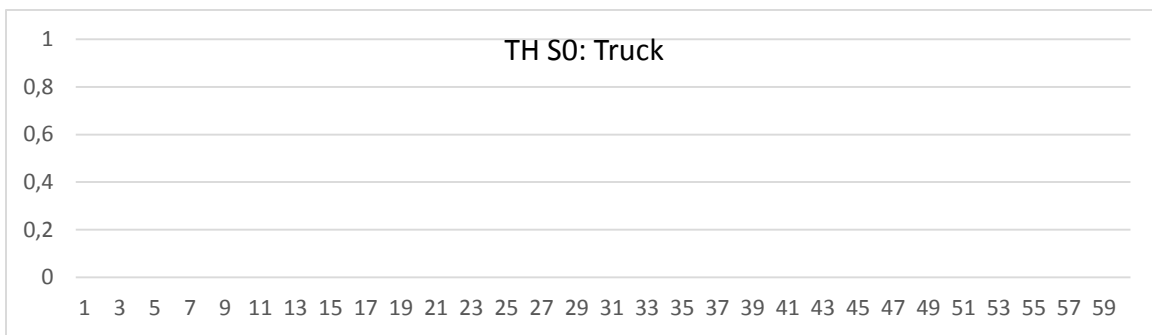

Graph 62: Number of containers per day transported by truck from sea-side container terminal to customer.

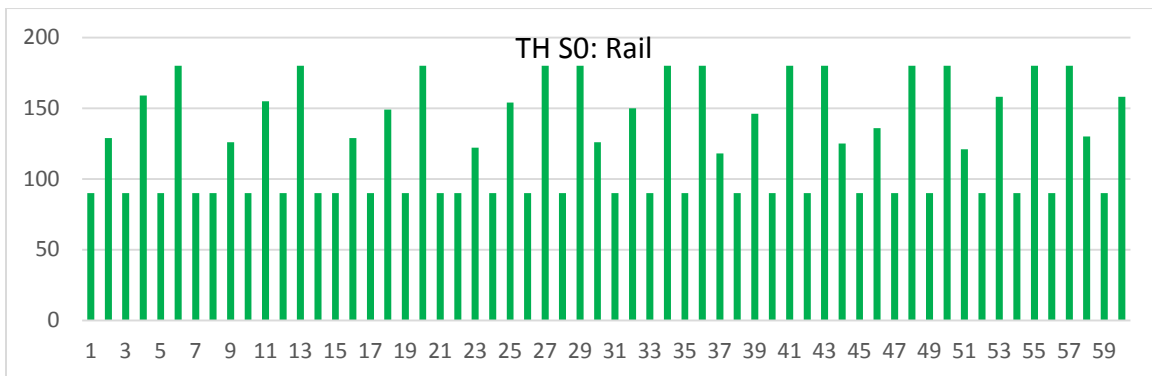

Graph 63: Number of containers per day transported by train from sea-side container terminal to inland container terminal.

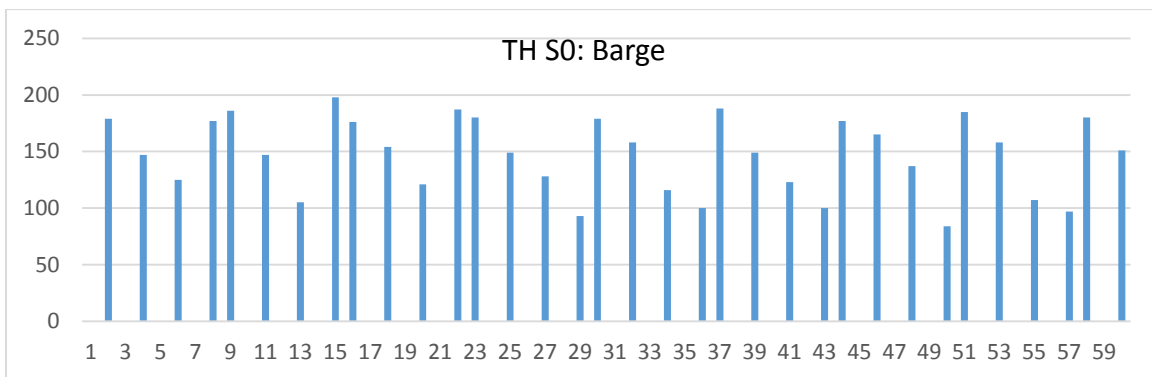

Graph 64: Number of containers per day transported by barge from sea-side container terminal to inland container terminal.

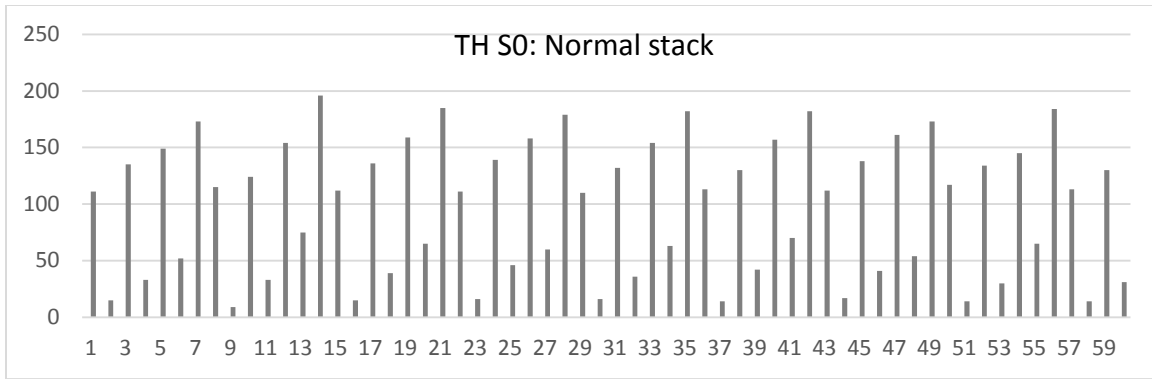

Graph 65: Number of non delayed containers in stack.

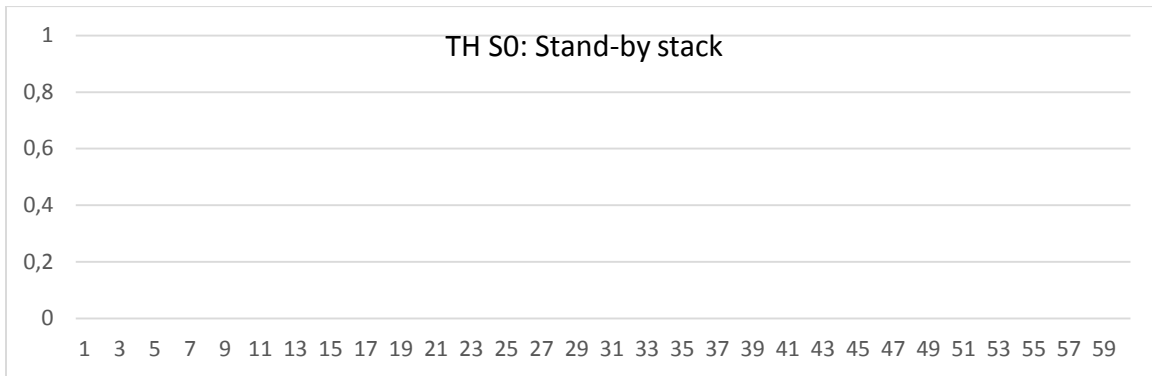

Graph 66: Number of delayed/stand-by containers in stack. To be transported by truck.

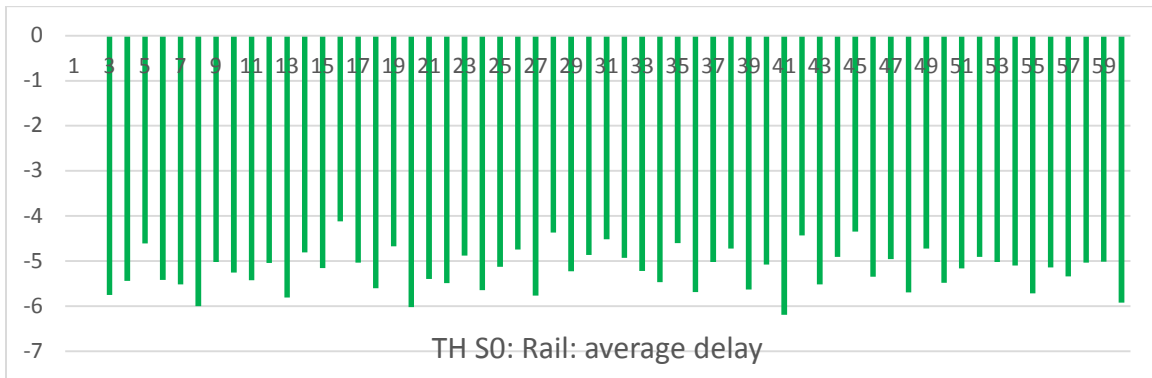

Graph 67: For train containers: average delay per day of the containers upon arrival at the customer.

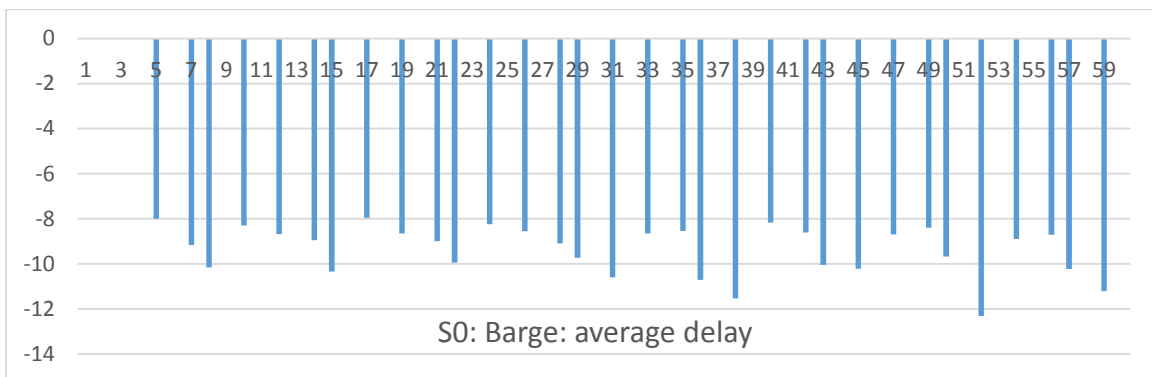

Graph 68: For barge containers: average delay per day of the containers upon arrival at the customer.

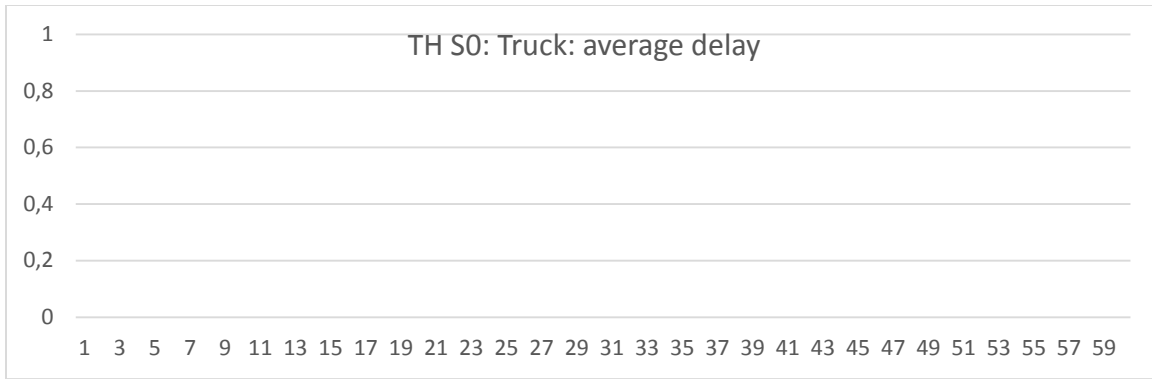

Graph 69: For containers planned by barge/train and transported by truck: average delay per day of the containers upon arrival at the customer.

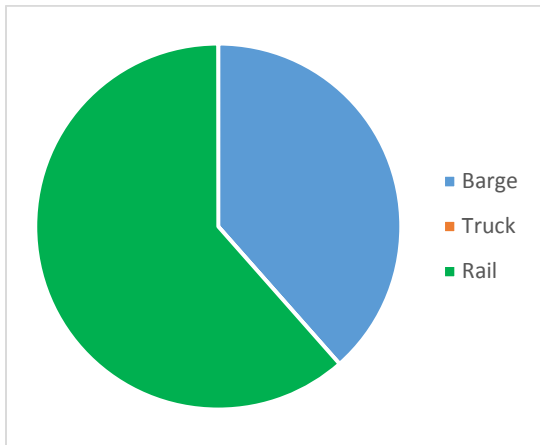

Modal split day 25-60

Barge	Truck	Rail
38.49%	0.00%	61.51%

Graph 70: Modal split (day 25-60)

TH – S1 run

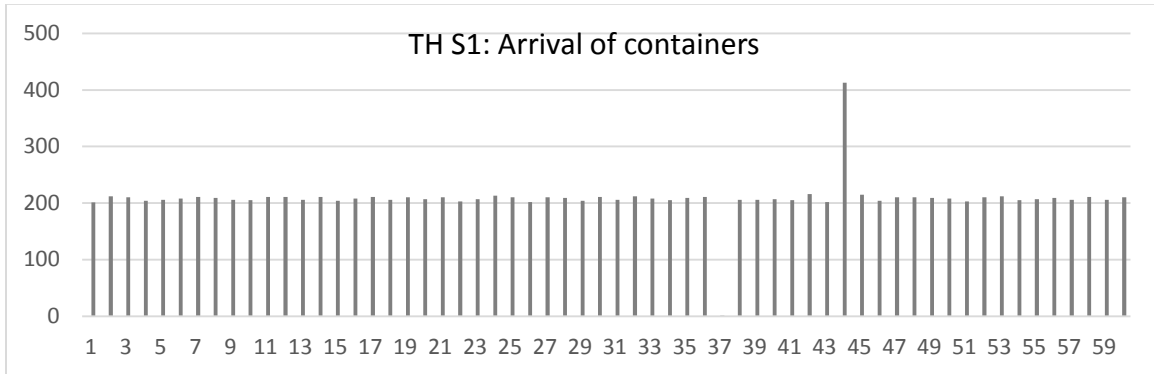

Graph 71: Number of containers per day arriving in stacks at sea-side container terminal

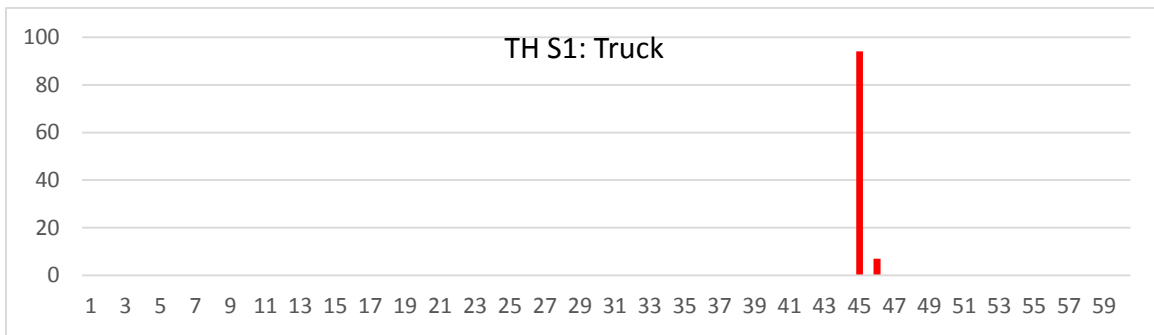

Graph 72: Number of containers per day transported by truck from sea-side container terminal to customer.

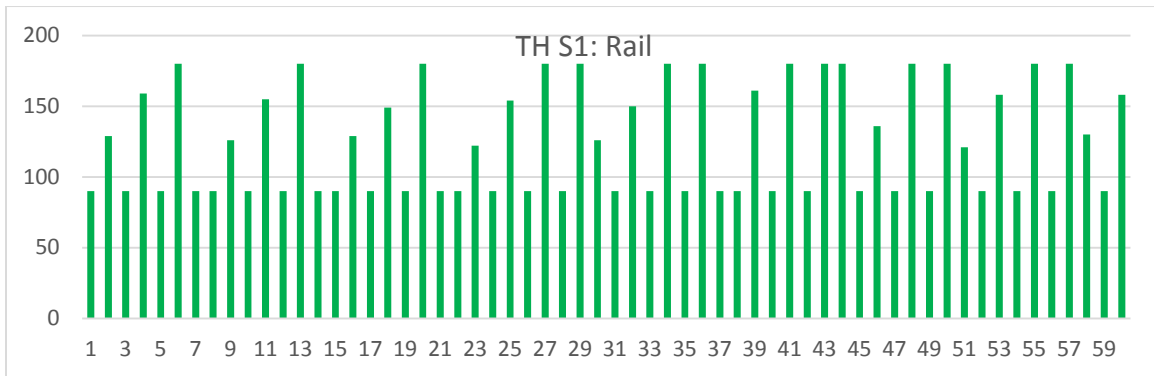

Graph 73: Number of containers per day transported by train from sea-side container terminal to inland container terminal.

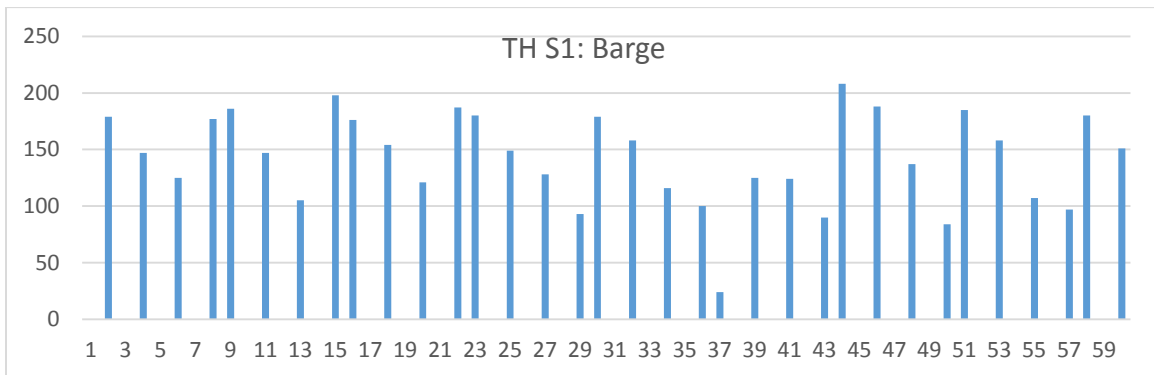

Graph 74: Number of containers per day transported by barge from sea-side container terminal to inland container terminal.

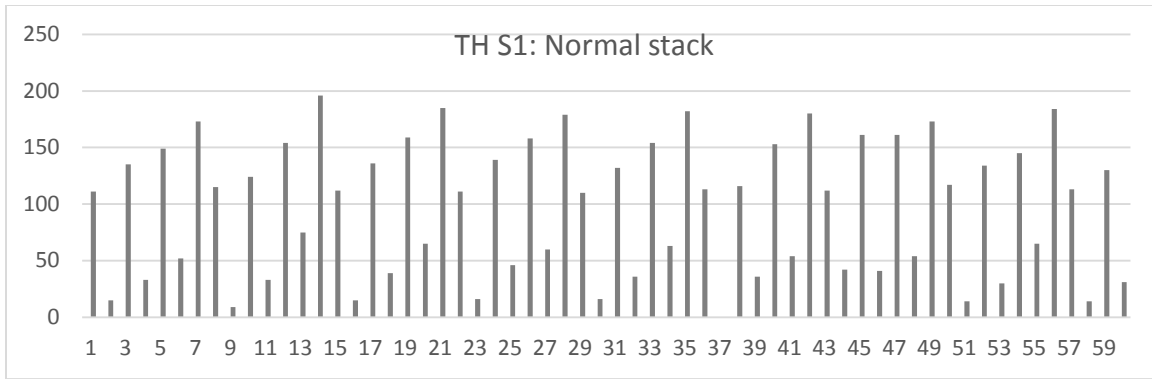

Graph 75: Number of non-delayed containers in stack.

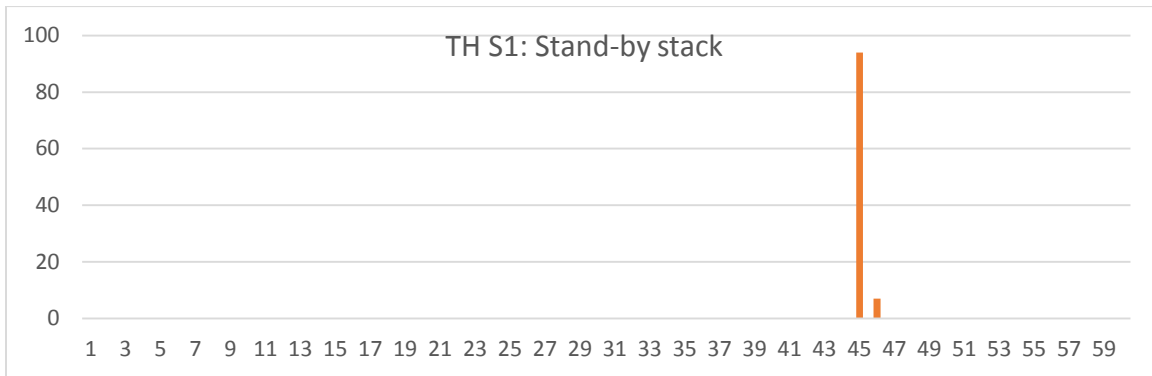

Graph 76: Number of delayed/stand-by containers in stack. To be transported by truck.

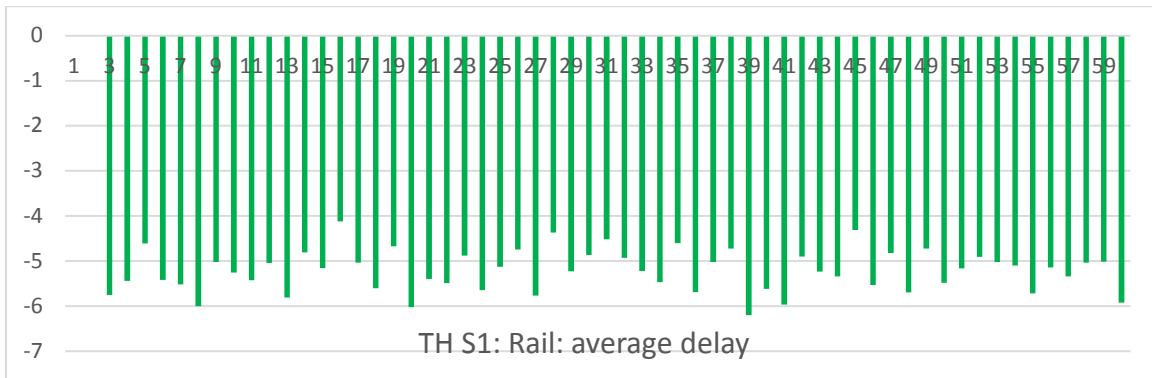

Graph 77: For train containers: average delay per day of the containers upon arrival at the customer.

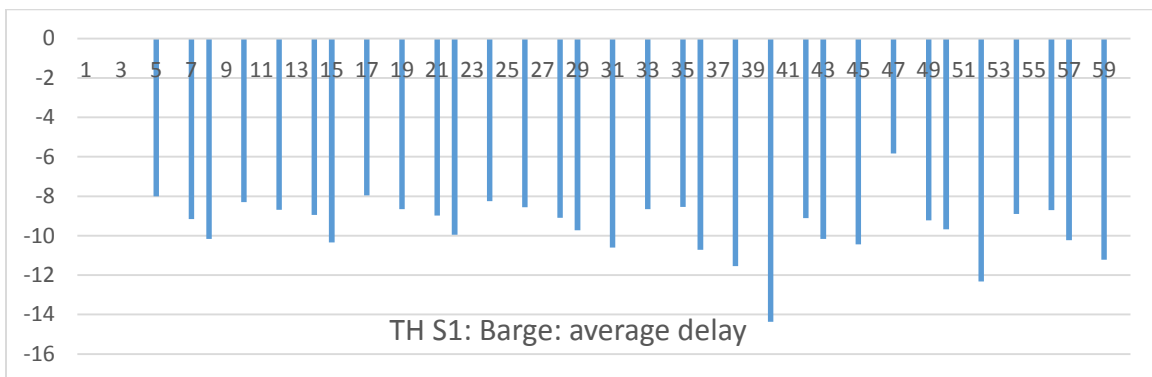

Graph 78: For barge containers: average delay per day of the containers upon arrival at the customer.

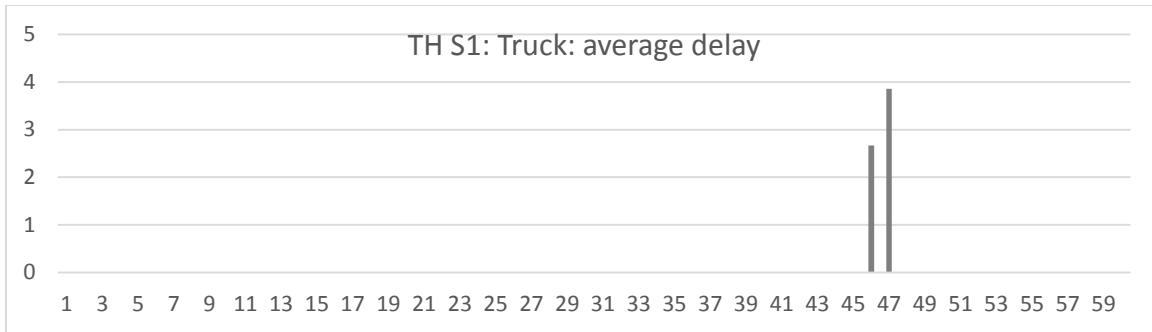

Graph 79: For containers planned by barge/train and transported by truck: average delay per day of the containers upon arrival at the customer.

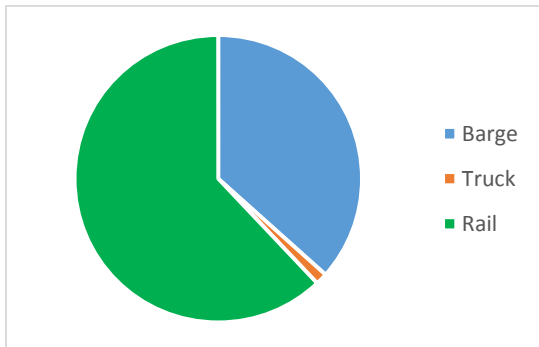

Modal split day 25-60

Barge	Truck	Rail
36.61%	1.33%	62.06%

Graph 80: Modal split (day 25-60)

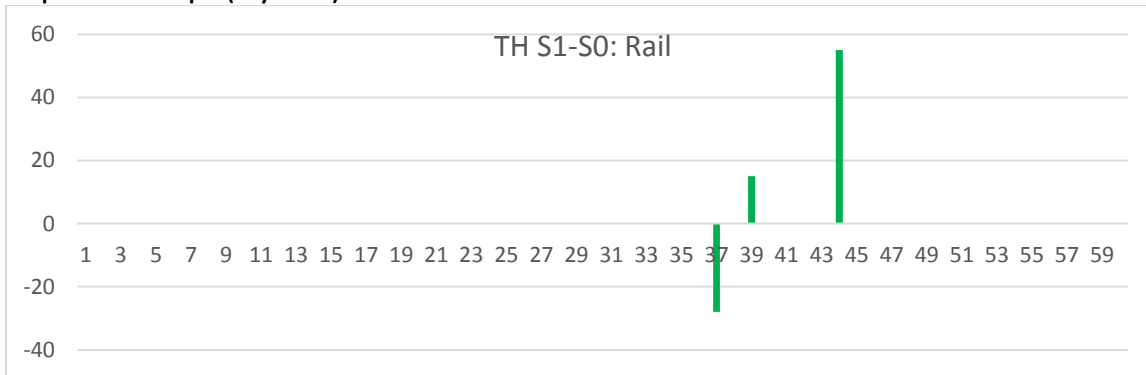

Graph 81: Difference S1 and S0. Number of containers per day transported by train from sea-side container terminal to inland container terminal.

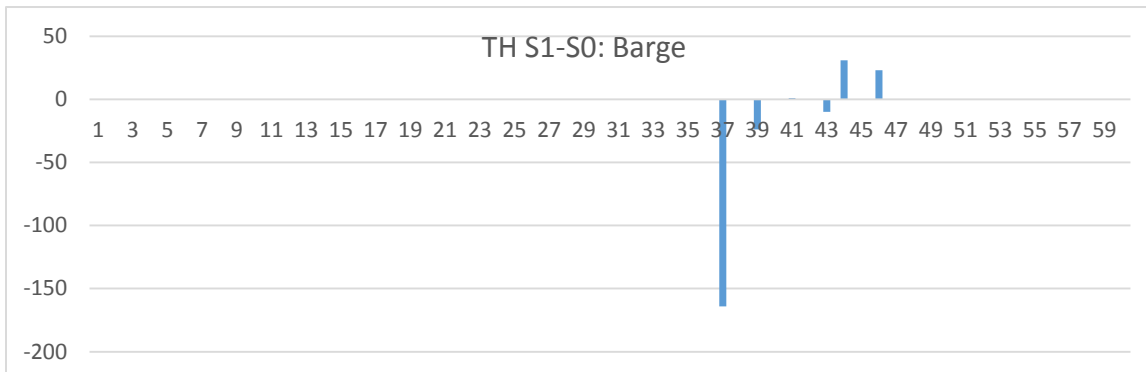

Graph 82: Difference S1 and S0. Number of containers per day transported by barge from sea-side container terminal to inland container terminal.

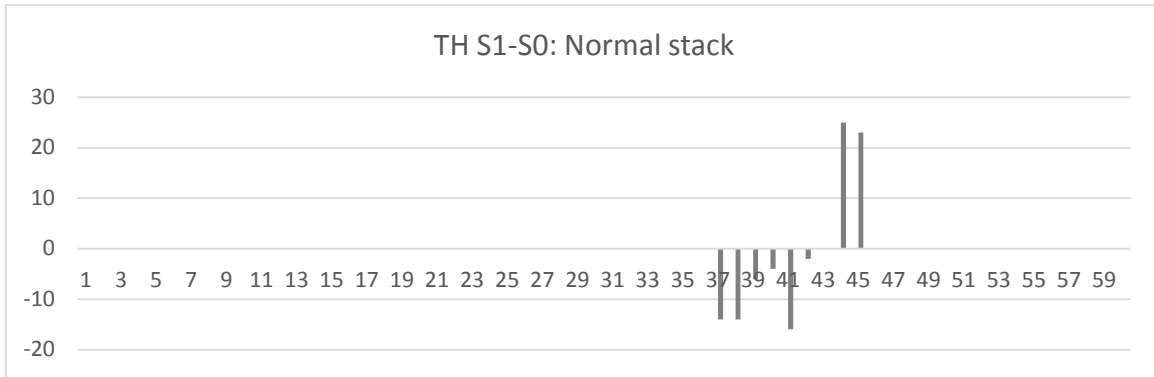

Graph 83: Difference S1 and S0. Number of non-delayed containers in stack.

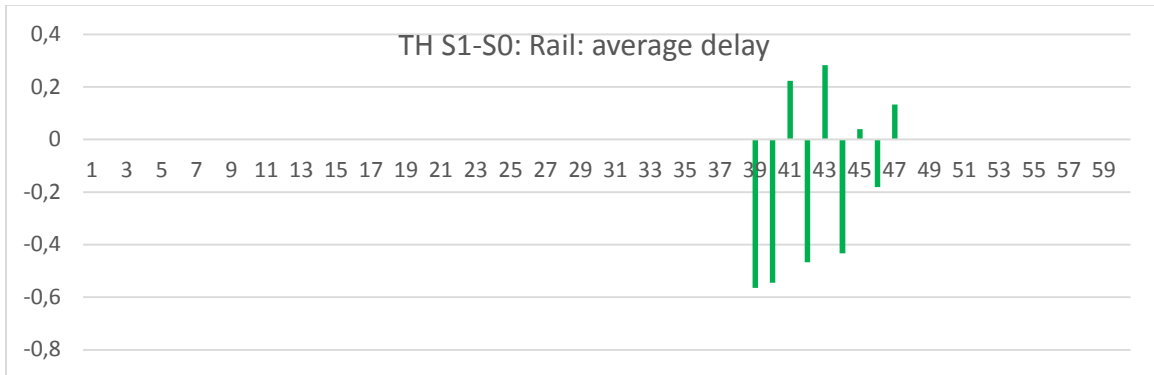

Graph 84: Difference S1 and S0. For train containers: average delay per day of the containers upon arrival at the customer.

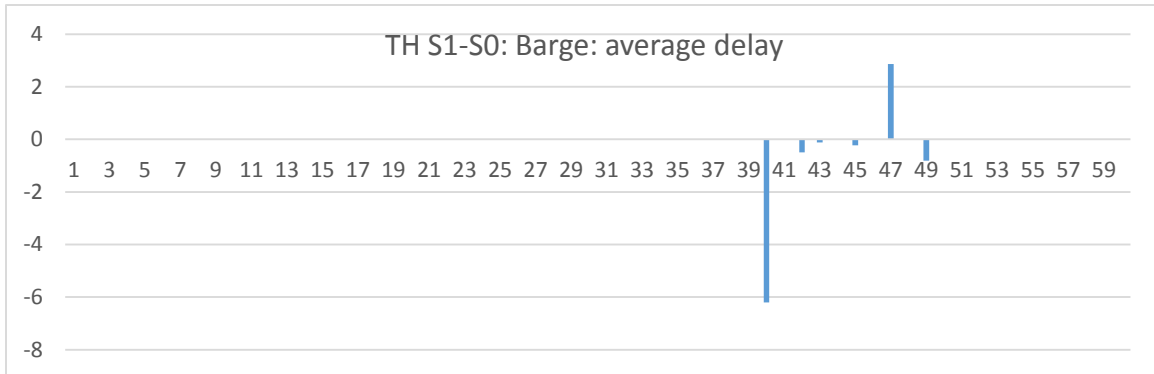

Graph 85: Difference S1 and S0. For barge containers: average delay per day of the containers upon arrival at the customer.

TH – S2 run

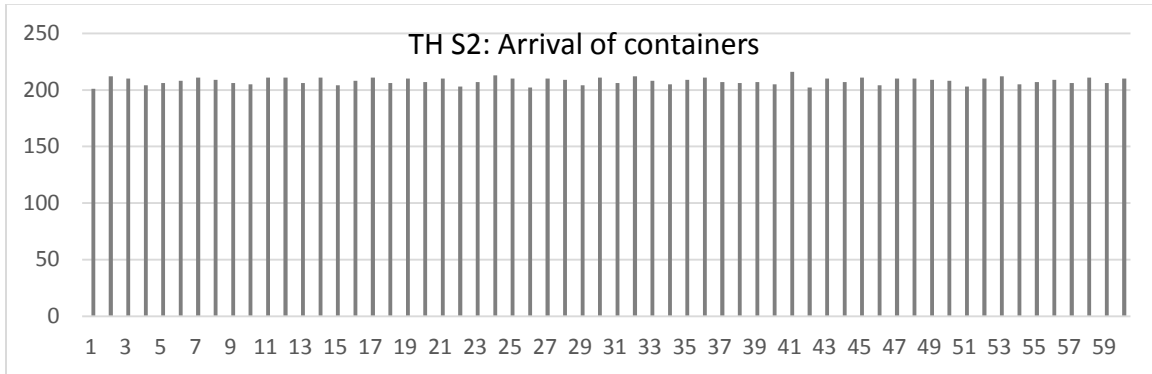

Graph 86: Number of containers per day arriving in stacks at sea-side container terminal

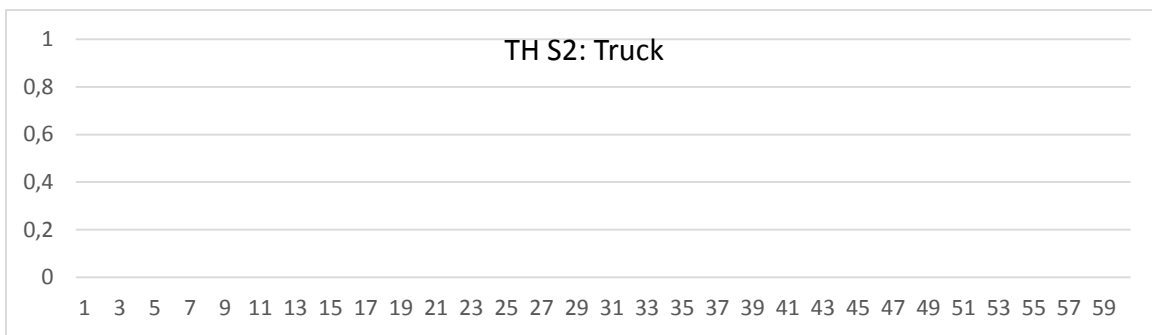

Graph 87: Number of containers per day transported by truck from sea-side container terminal to customer.

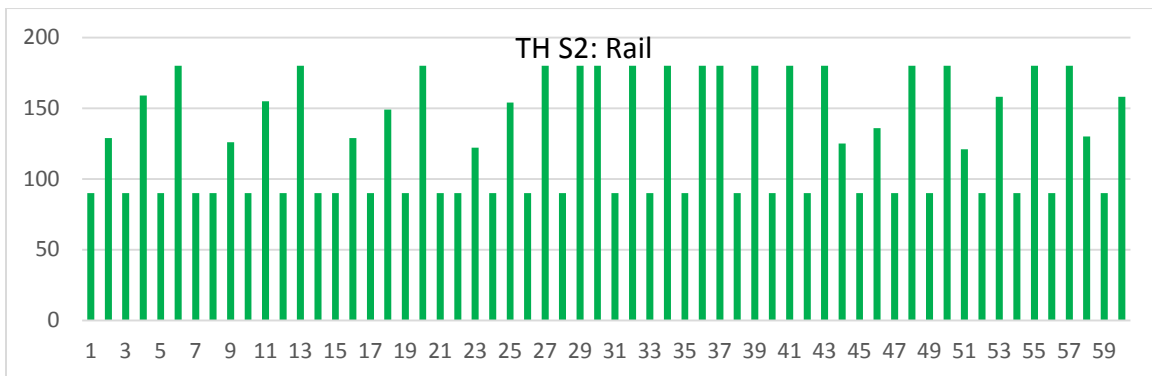

Graph 88: Number of containers per day transported by train from sea-side container terminal to inland container terminal.

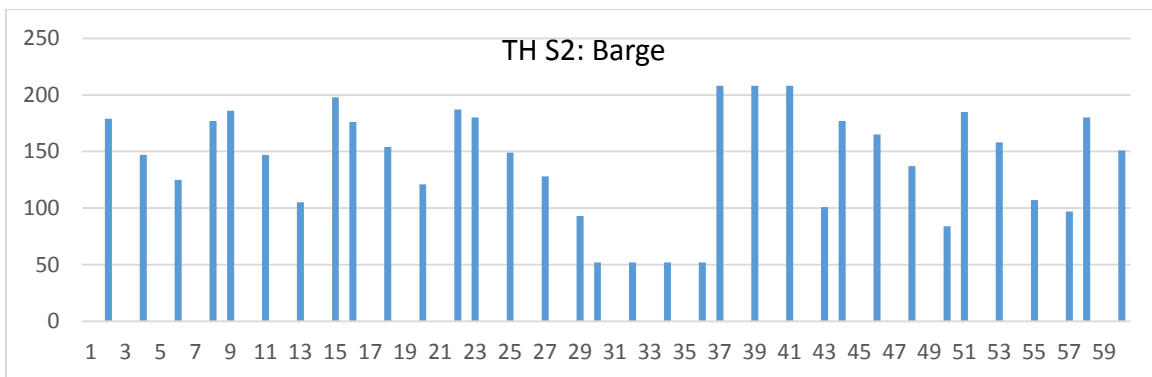

Graph 89: Number of containers per day transported by barge from sea-side container terminal to inland container terminal.

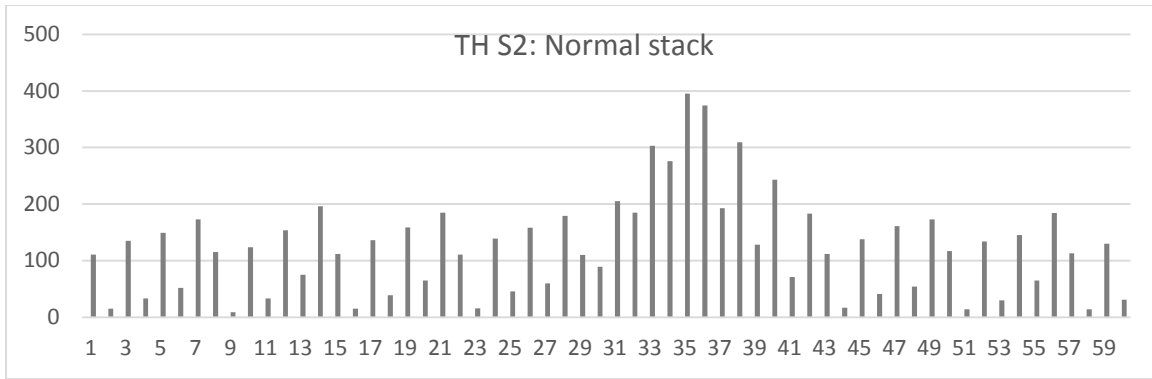

Graph 90: Number of non-delayed containers in stack.

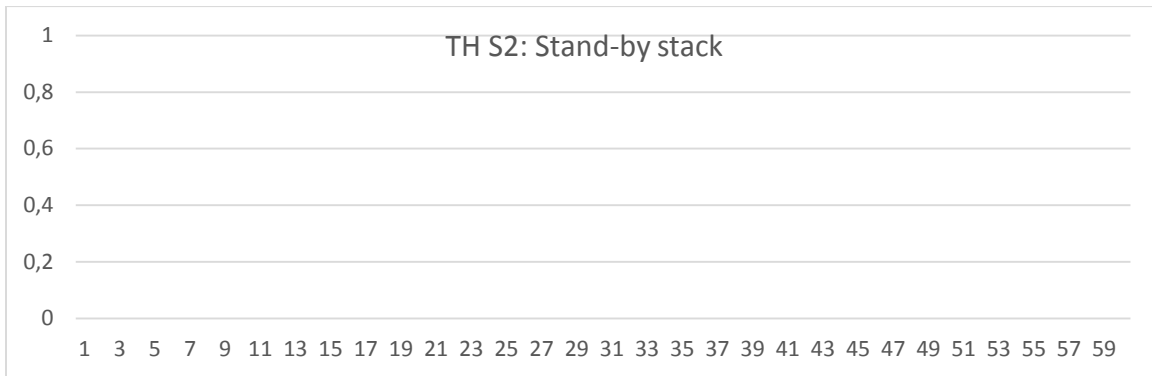

Graph 91: Number of delayed/stand-by containers in stack. To be transported by truck.

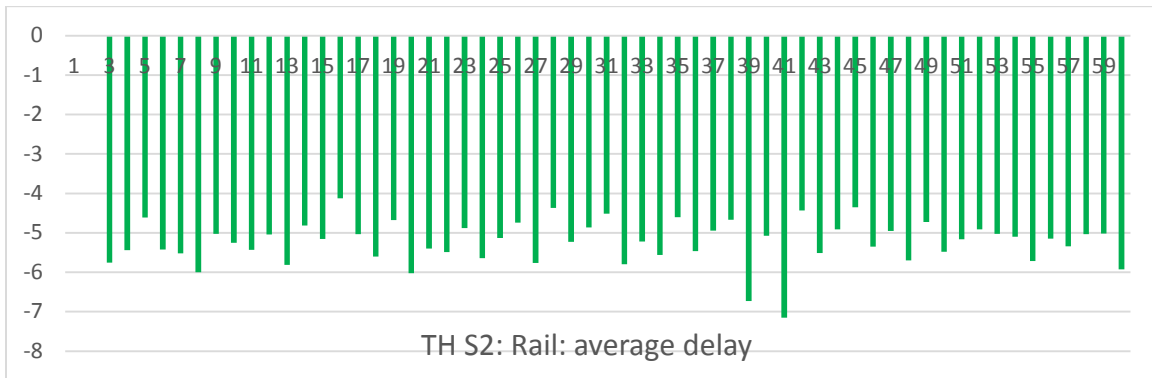

Graph 92: For rail containers: average delay per day of the containers upon arrival at the customer.

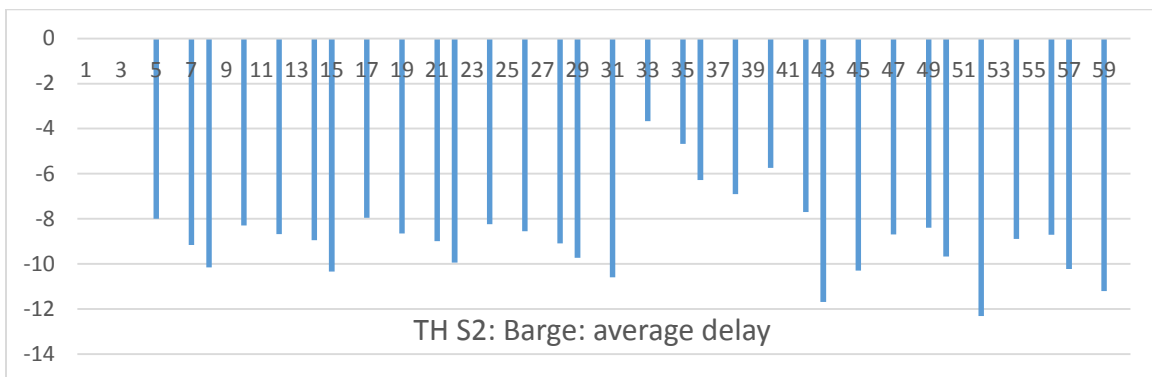

Graph 93: For barge containers: average delay per day of the containers upon arrival at the customer.

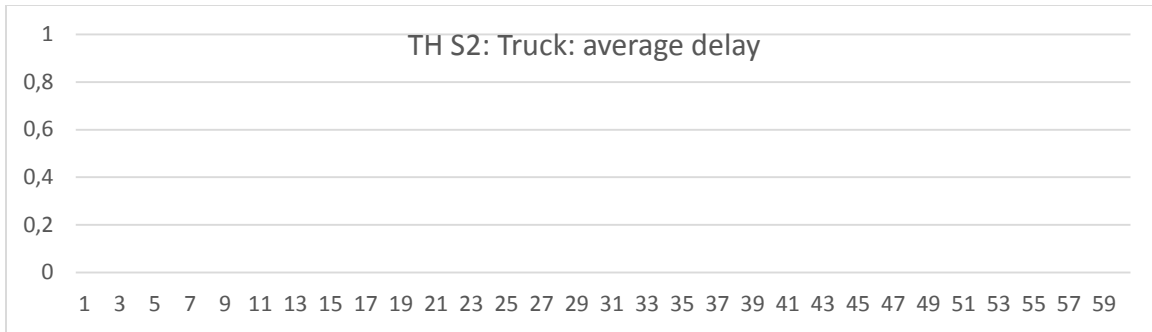

Graph 94: For containers planned by barge/train and transported by truck: average delay per day of the containers upon arrival at the customer.

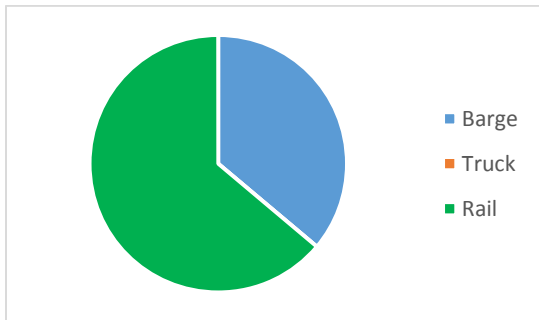

Modal split day 25-60

Barge	Truck	Rail
36.12%	0.00%	63.88%

Graph 95: Modal split (day 25-60)

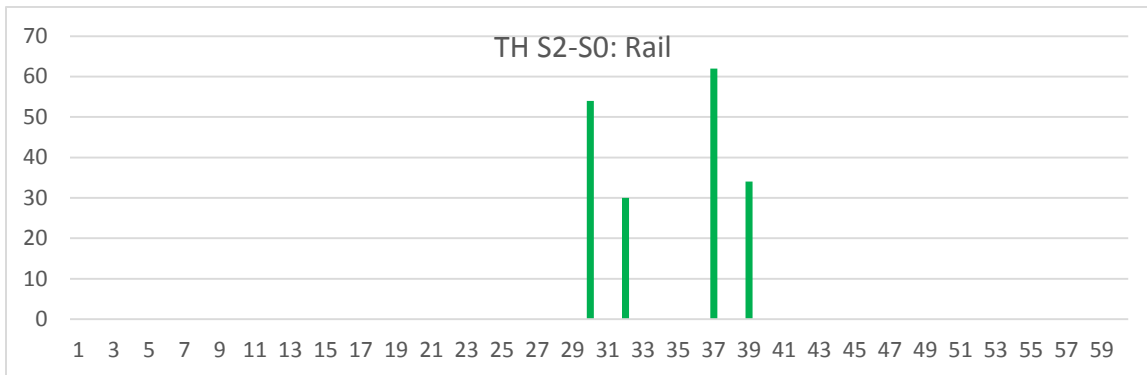

Graph 96: Difference S2 and S0. Number of containers per day transported by train from sea-side container terminal to inland container terminal.

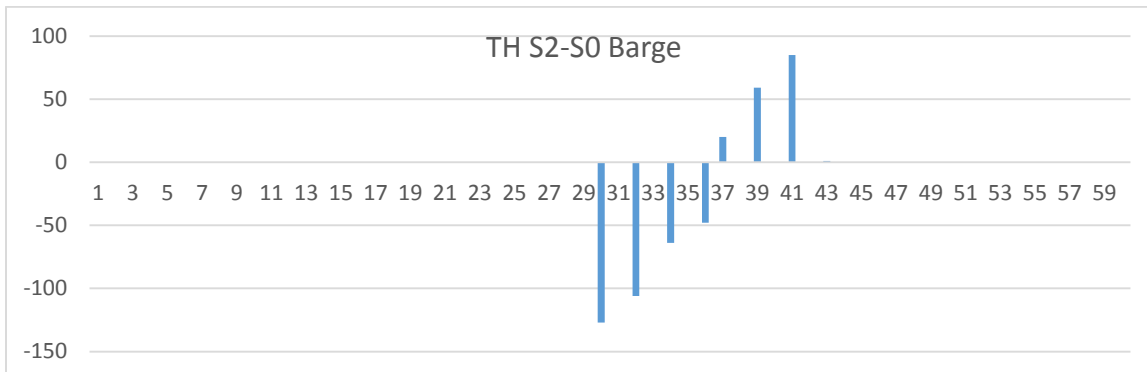

Graph 97: Difference S2 and S0. Number of containers per day transported by barge from sea-side container terminal to inland container terminal.

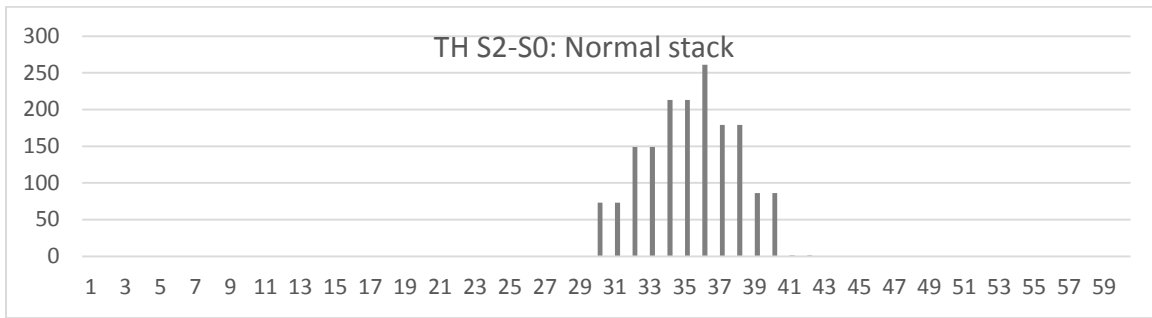

Graph 98: Difference S2 and S0. Number of non-delayed containers in stack.

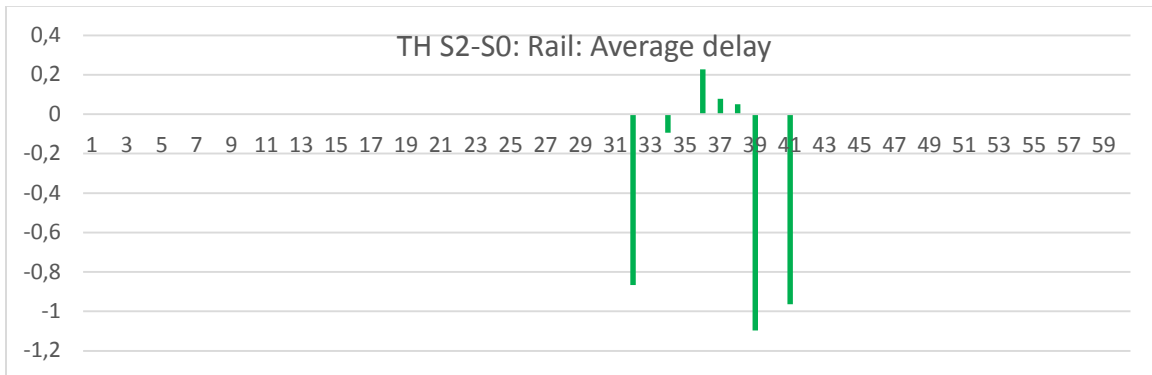

Graph 99: Difference S2 and S0. For train containers: average delay per day of the containers upon arrival at the customer.

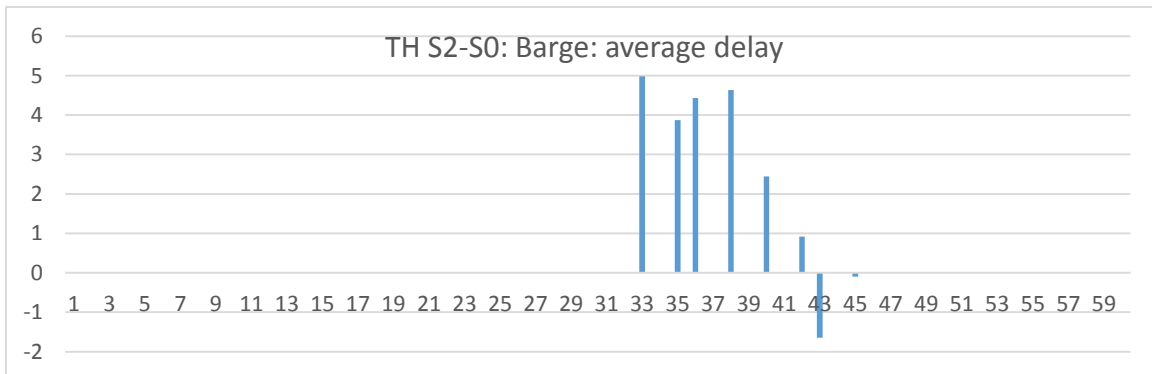

Graph 100: Difference S2 and S0. For barge containers: average delay per day of the containers upon arrival at the customer.

TH – S3 run

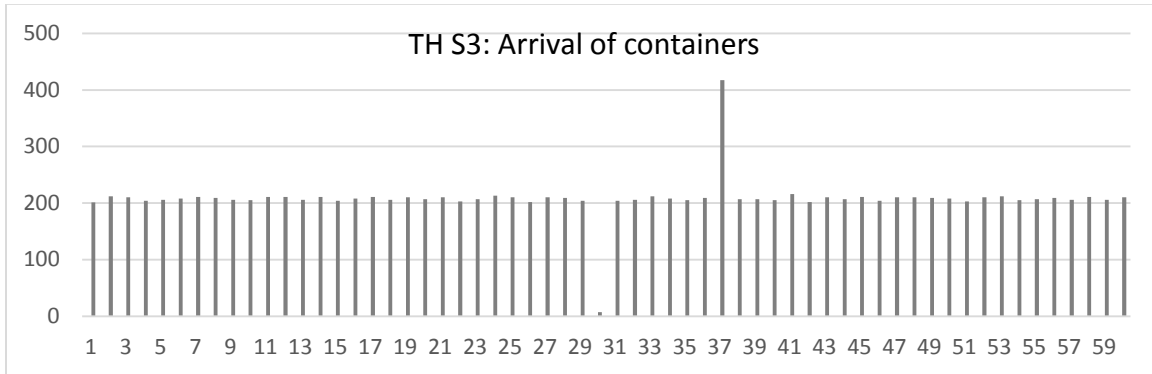

Graph 101: Number of containers per day arriving in stacks at sea-side container terminal

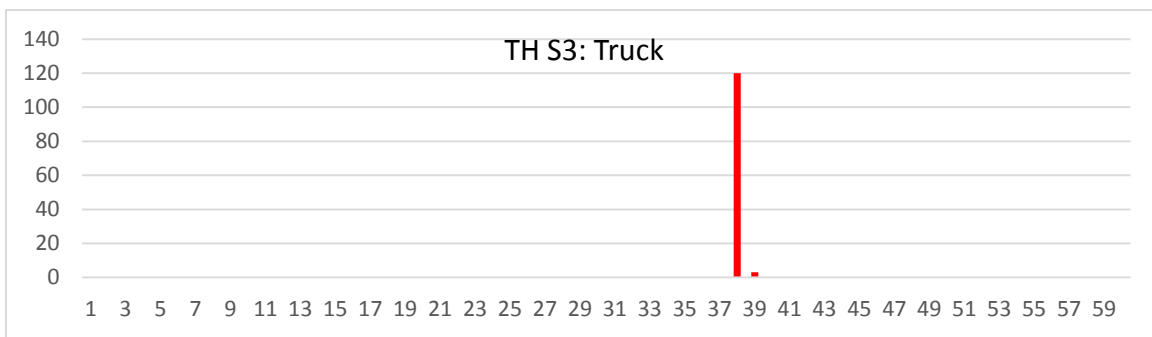

Graph 102: Number of containers per day transported by truck from sea-side container terminal to customer.

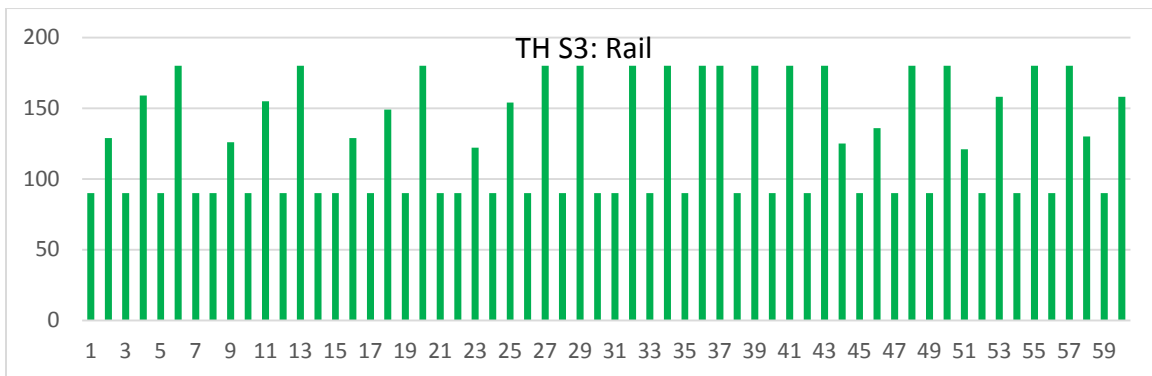

Graph 103: Number of containers per day transported by train from sea-side container terminal to inland container terminal.

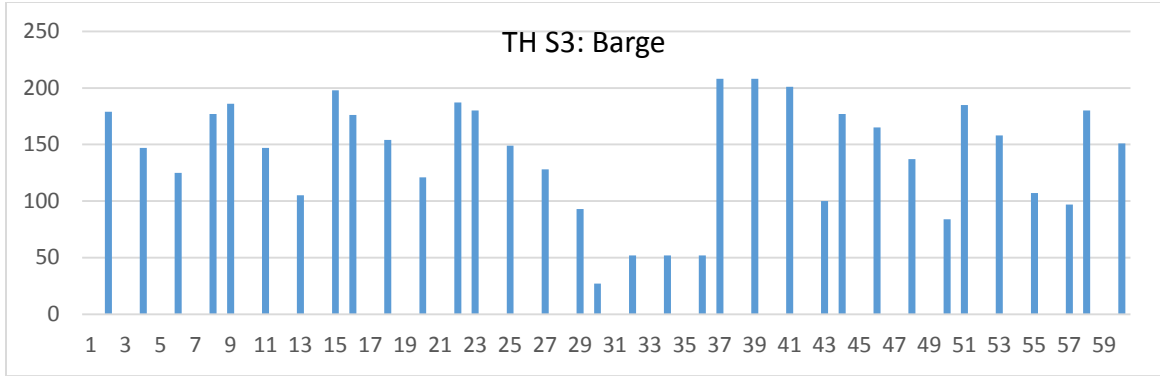

Graph 104: Number of containers per day transported by barge from sea-side container terminal to inland container terminal.

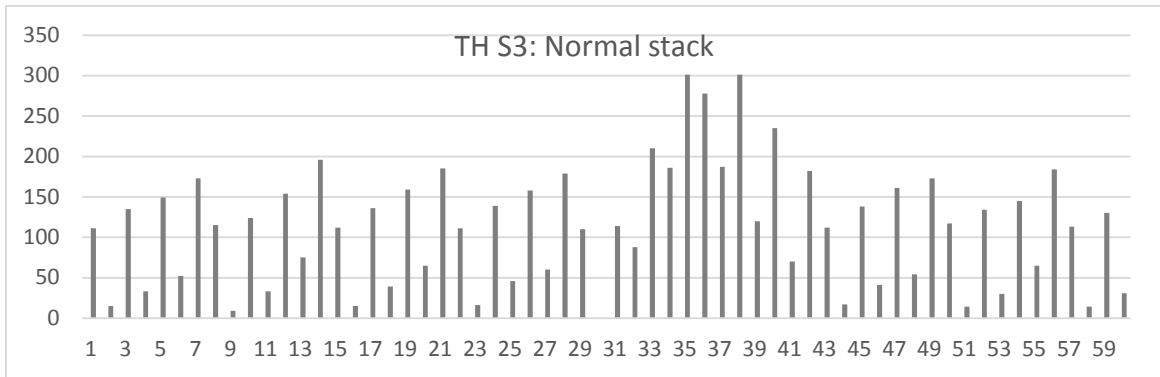

Graph 105: Number of non-delayed containers in stack.

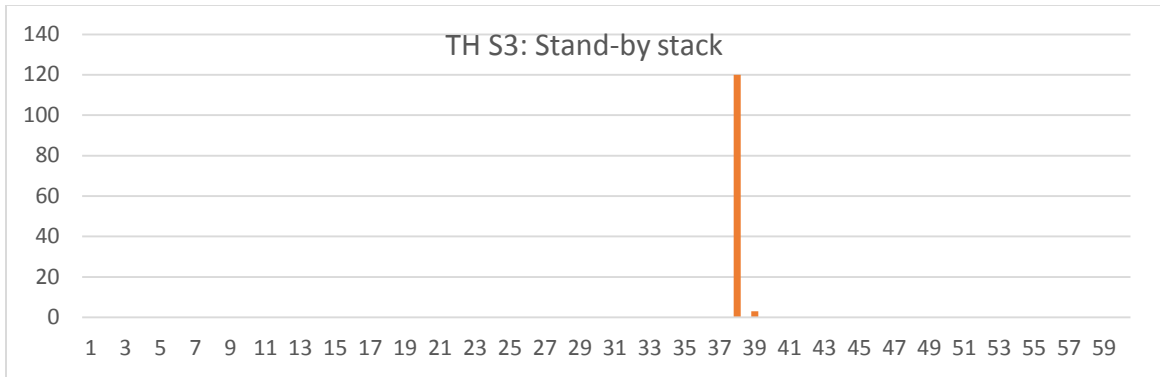

Graph 106: Number of delayed/stand-by containers in stack. To be transported by truck.

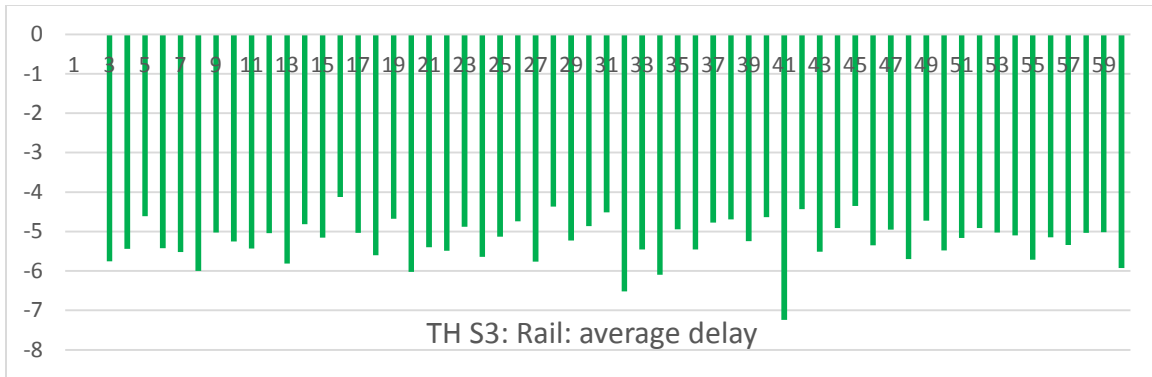

Graph 107: For train containers: average delay per day of the containers upon arrival at the customer.

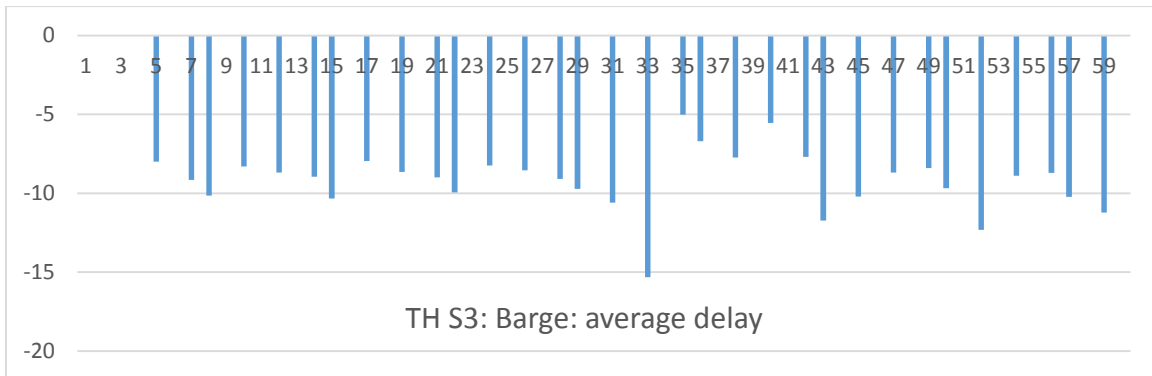

Graph 108: For barge containers: average delay per day of the containers upon arrival at the customer.

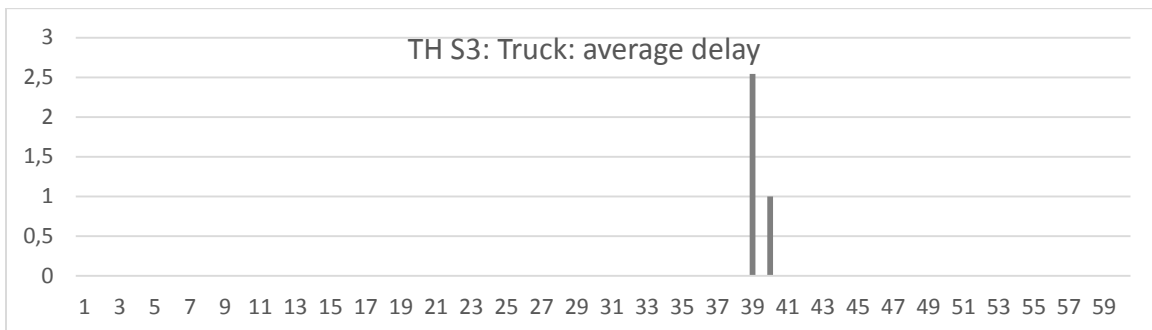

Graph 109: For containers planned by barge/train and transported by truck: average delay per day of the containers upon arrival at the customer.

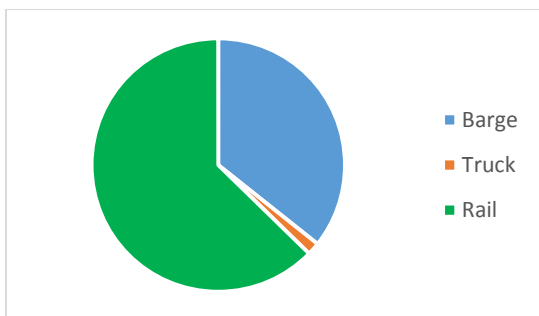

Modal split day 25-60

Barge	Truck	Rail
35.69%	1.62%	62.69%

Graph 110: Modal split (day 25-60)

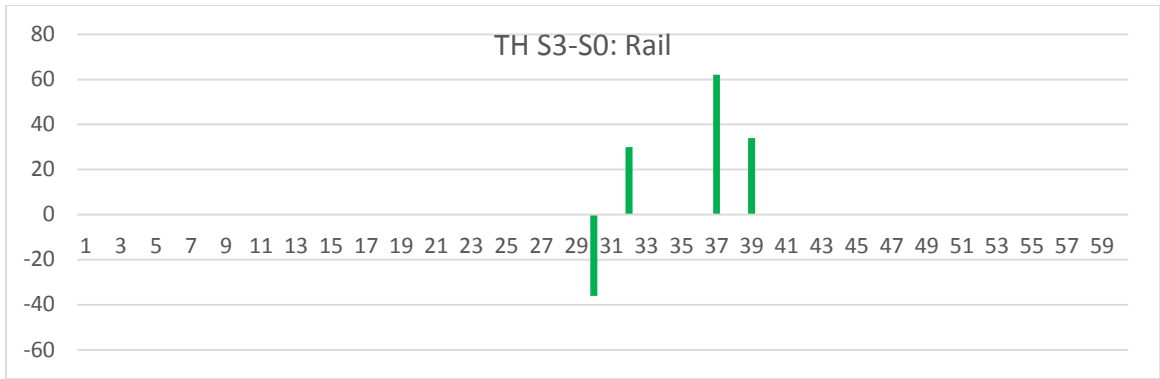

Graph 111: Difference S3 and S0. Number of containers per day transported by train from sea-side container terminal to inland container terminal.

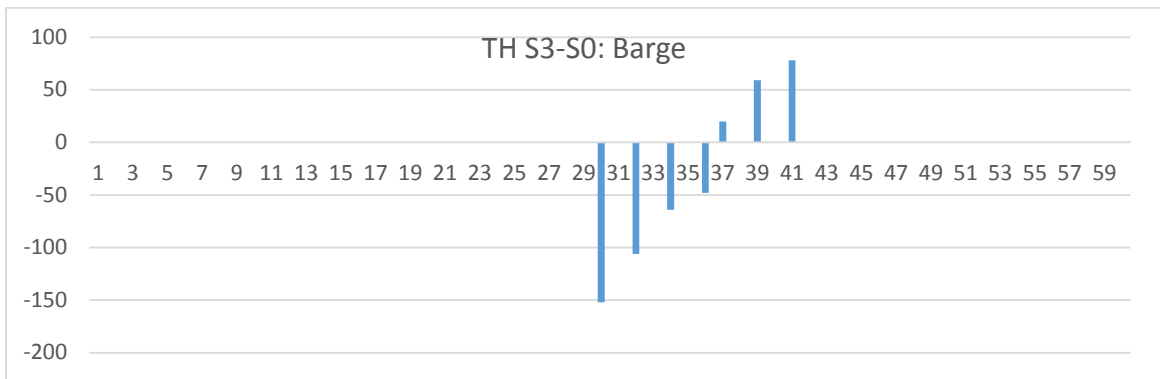

Graph 112: Difference S3 and S0. Number of containers per day transported by train from sea-side container terminal to inland container terminal.

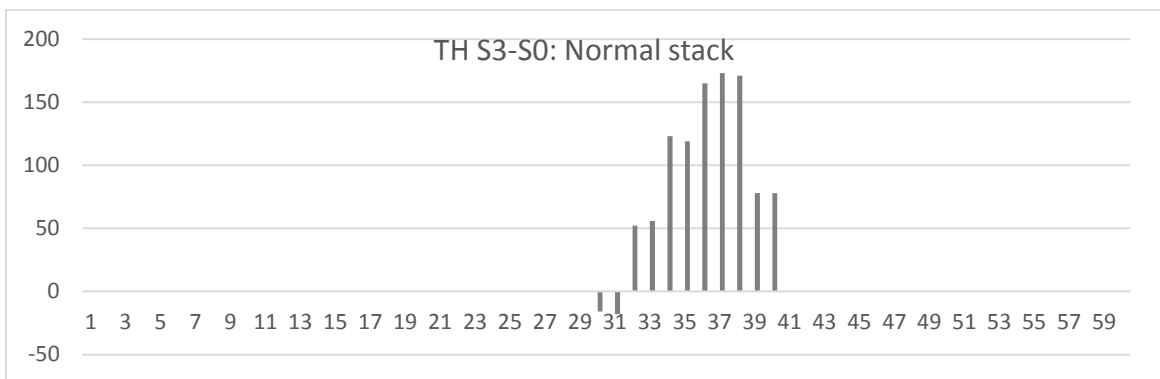

Graph 113: Difference S3 and S0. Number of non-delayed containers in stack.

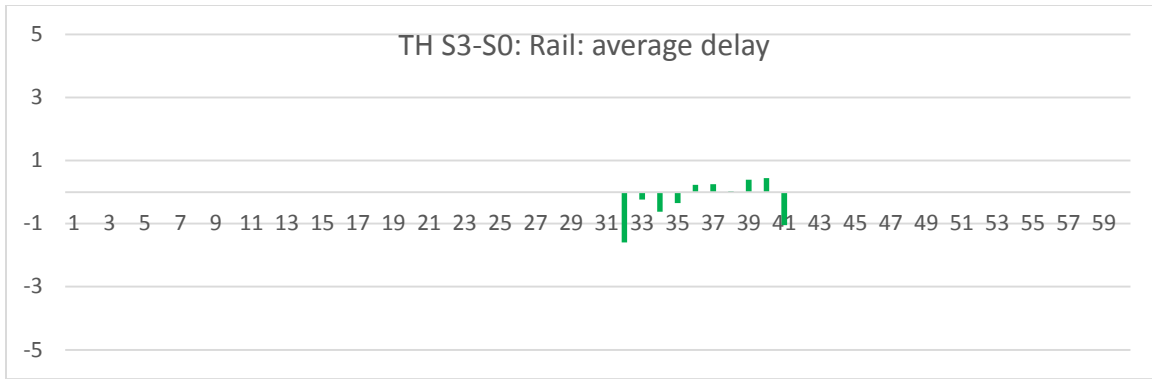

Graph 114: Difference S3 and S0. For train containers: average delay per day of the containers upon arrival at the customer.

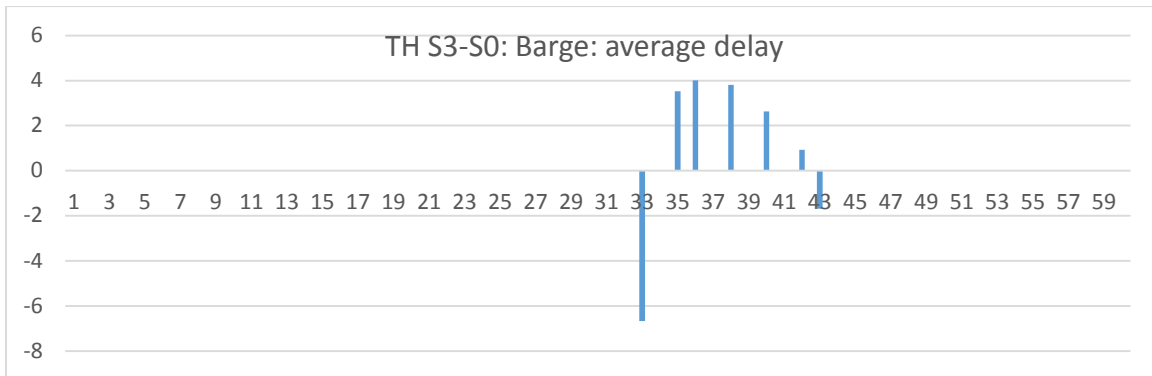

Graph 115: Difference S3 and S0. For barge containers: average delay per day of the containers upon arrival at the customer.

APPENDIX G: DEVIATED ARRIVAL TIMES AND OVERCAPACITY

MH model

MH: 5% overcapacity

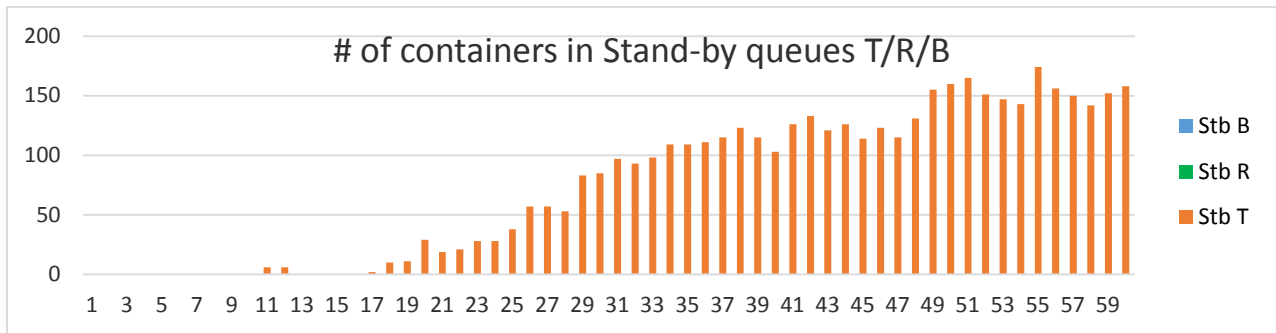

Graph 116

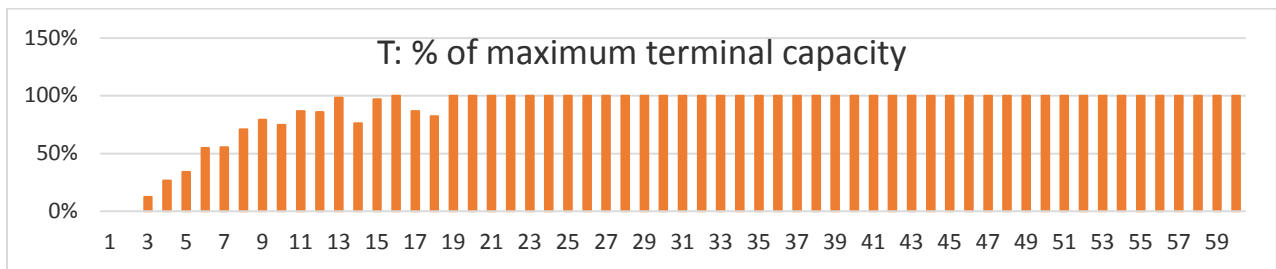

Graph 117

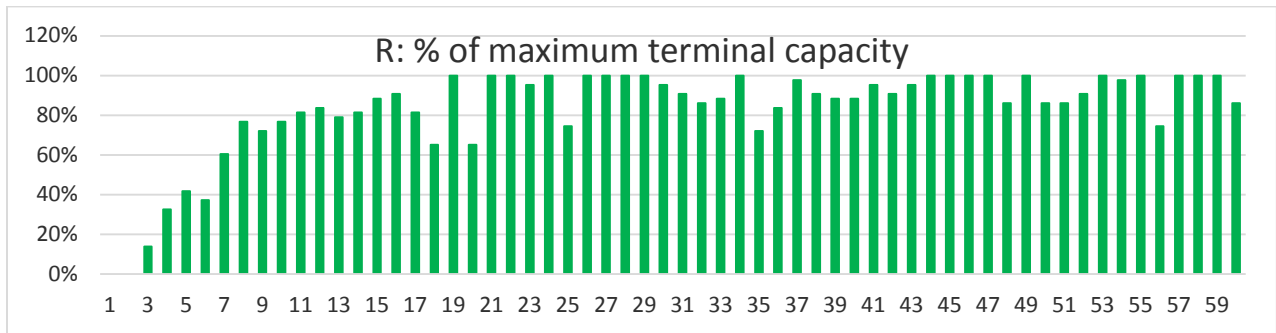

Graph 118

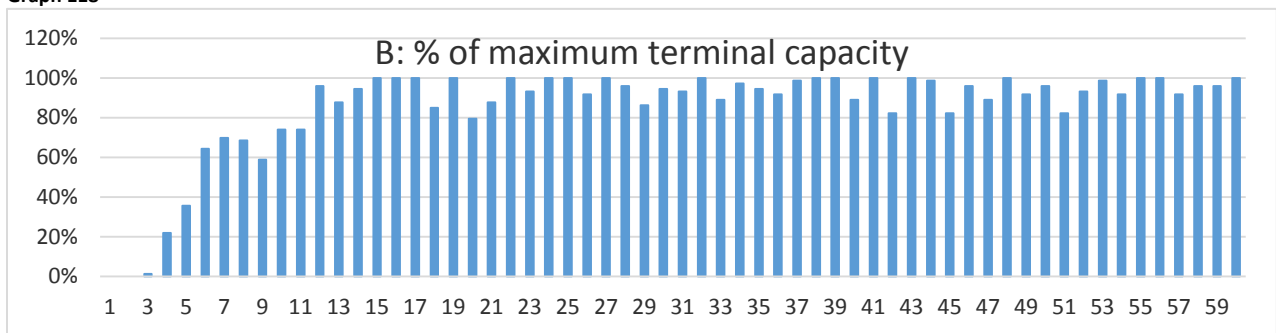

Graph 119

MH: 10% rescheduling capacity

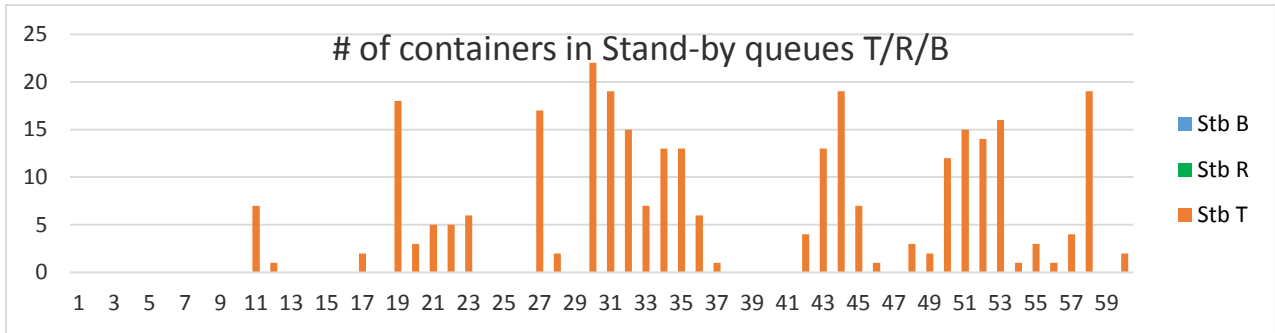

Graph 120

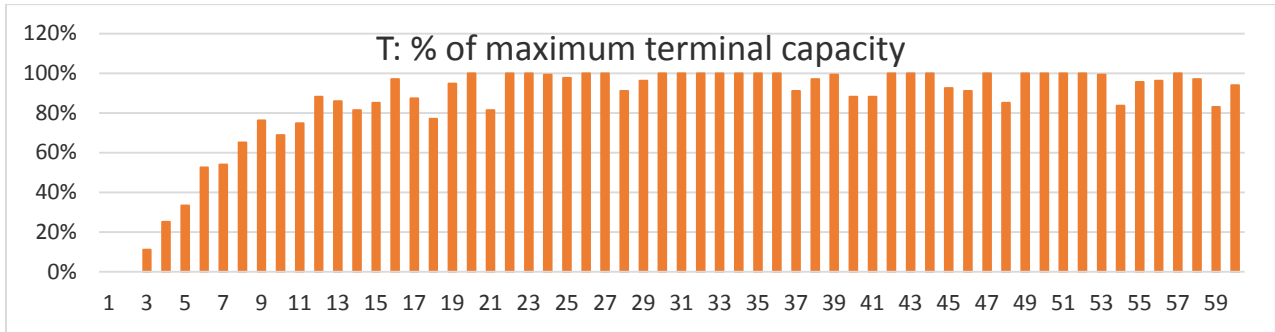

Graph 121

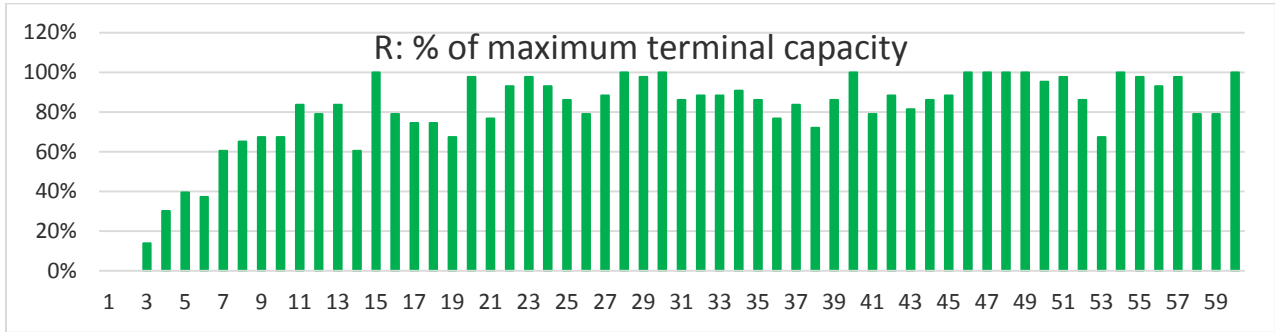

Graph 122

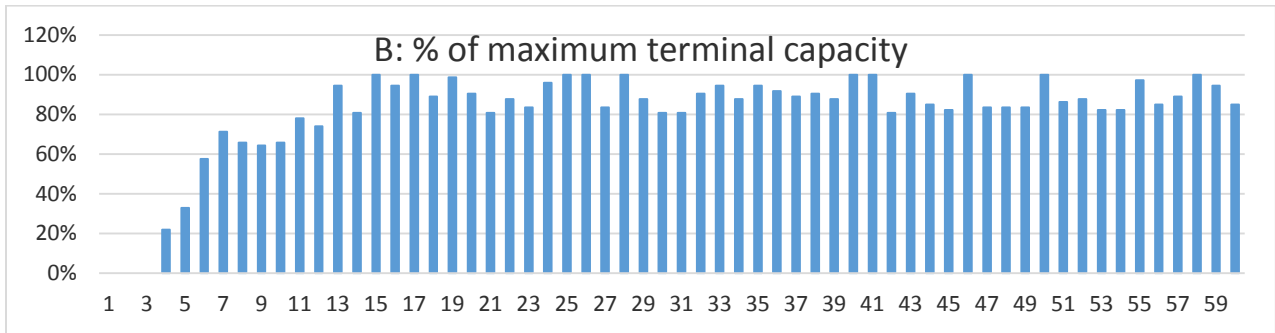

Graph 123

MH: 20% overcapacity

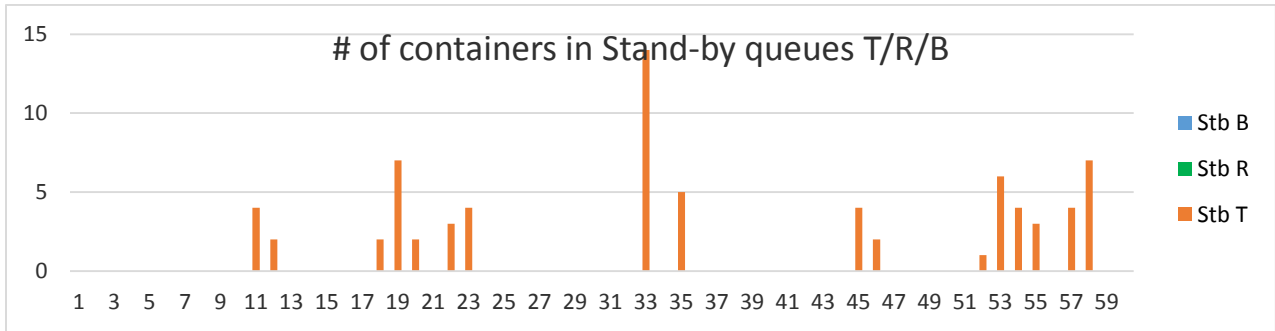

Graph 124

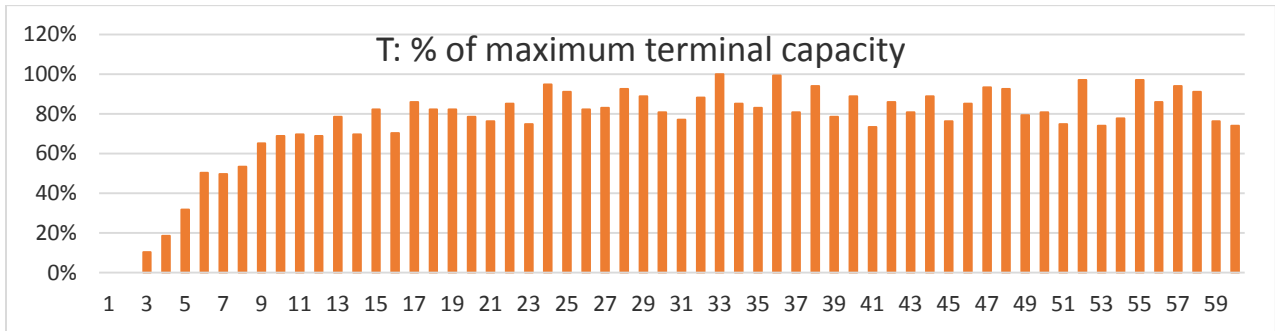

Graph 125

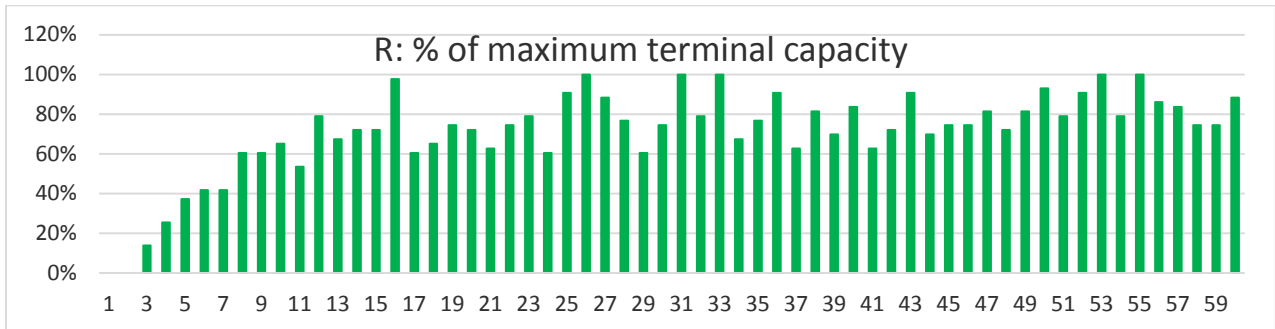

Graph 126

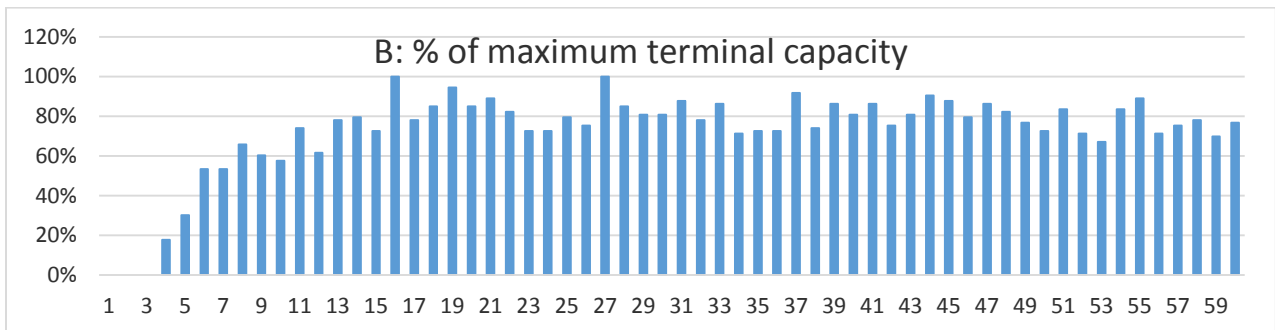

Graph 127

TH model
 TH: 5% overcapacity

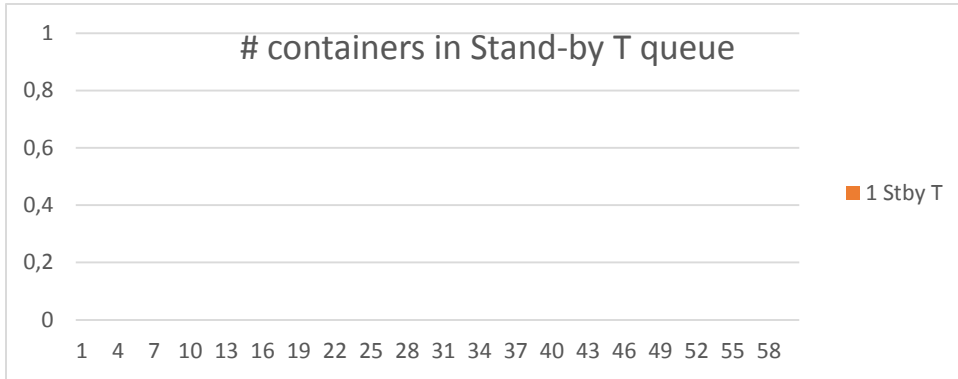

Graph 128

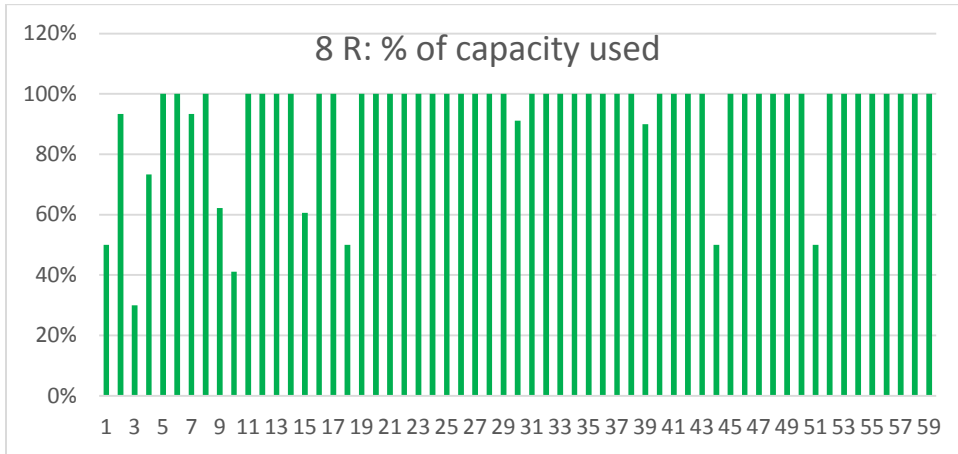

Graph 129

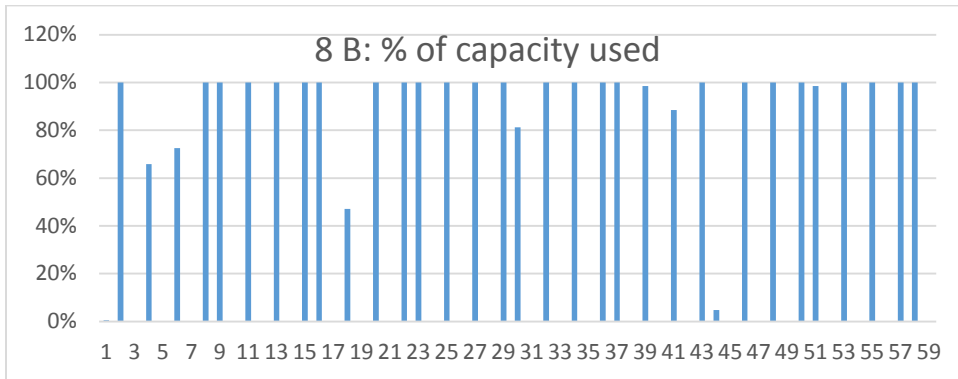

Graph 130

TH: 10% overcapacity

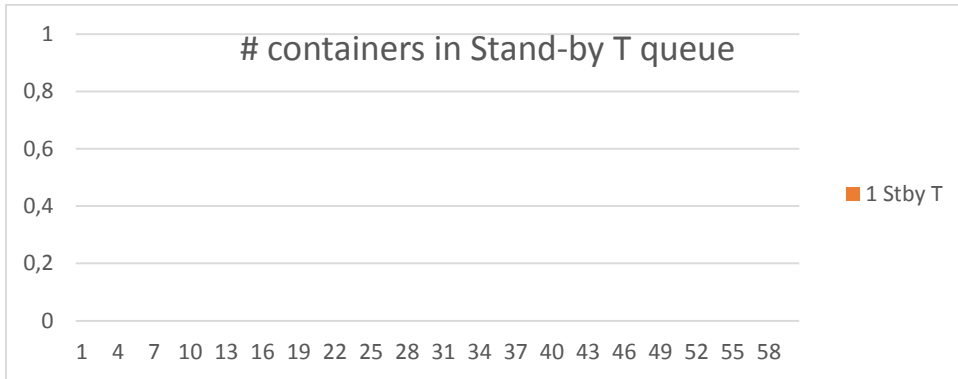

Graph 131

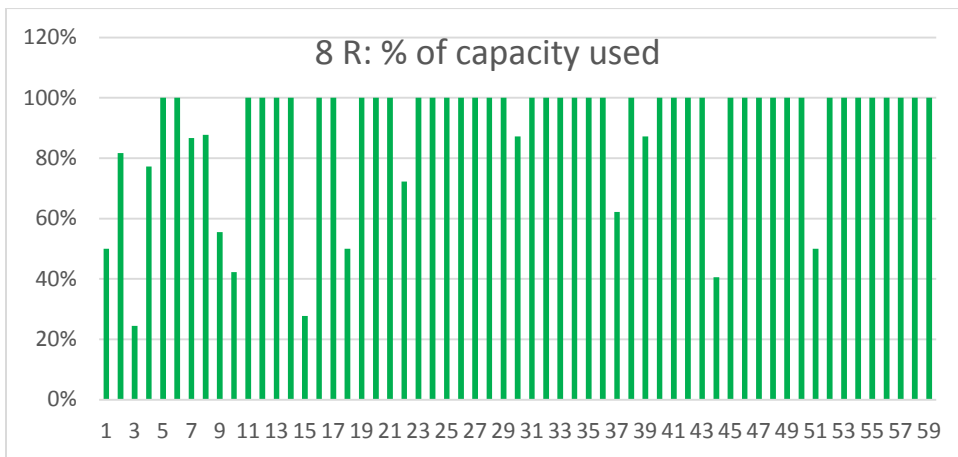

Graph 132

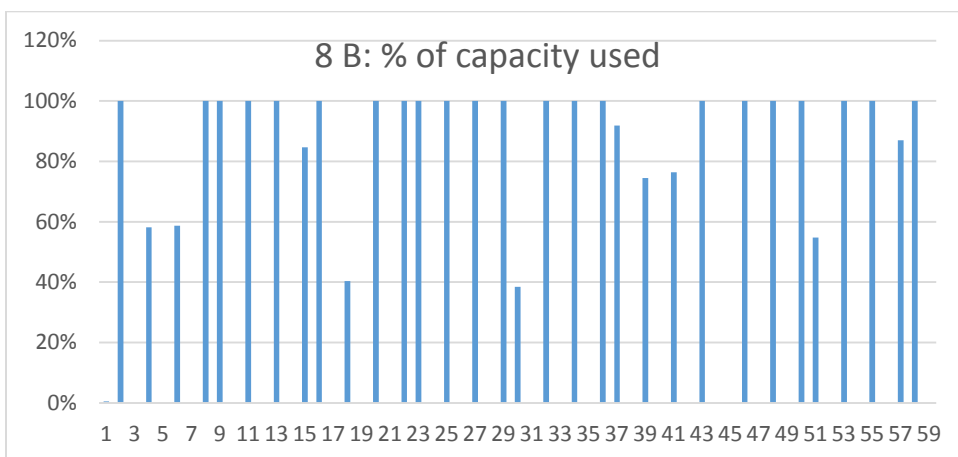

Graph 133

TH: 20 % overcapacity

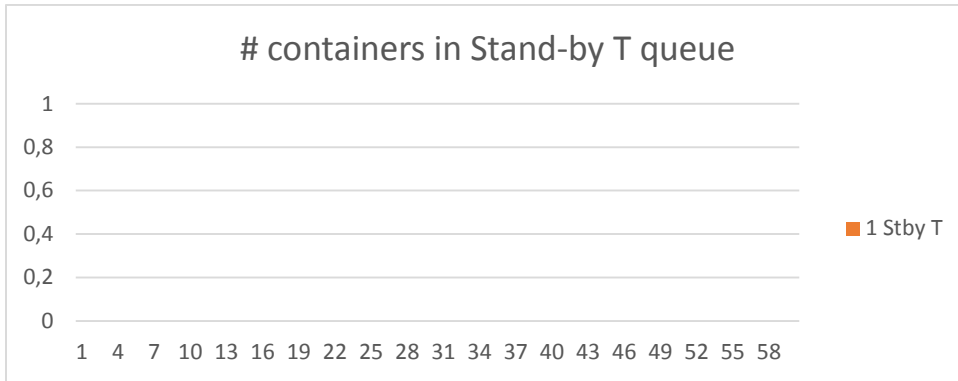

Graph 134

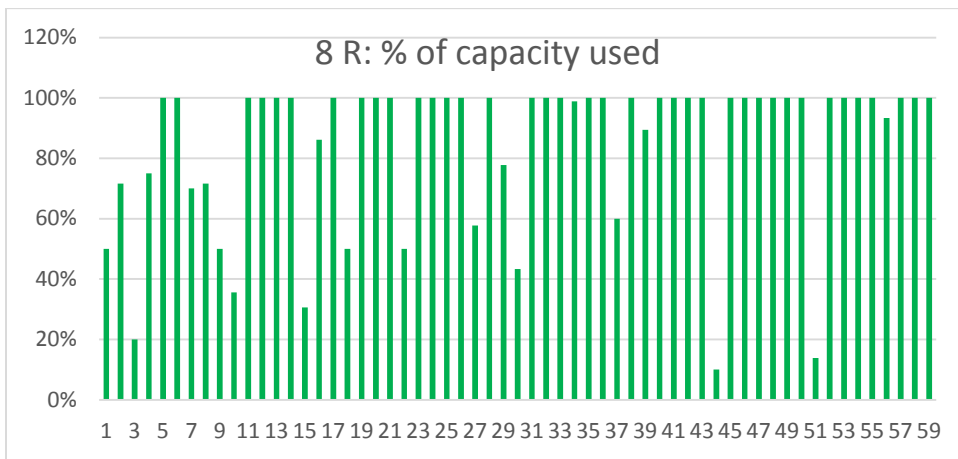

Graph 135

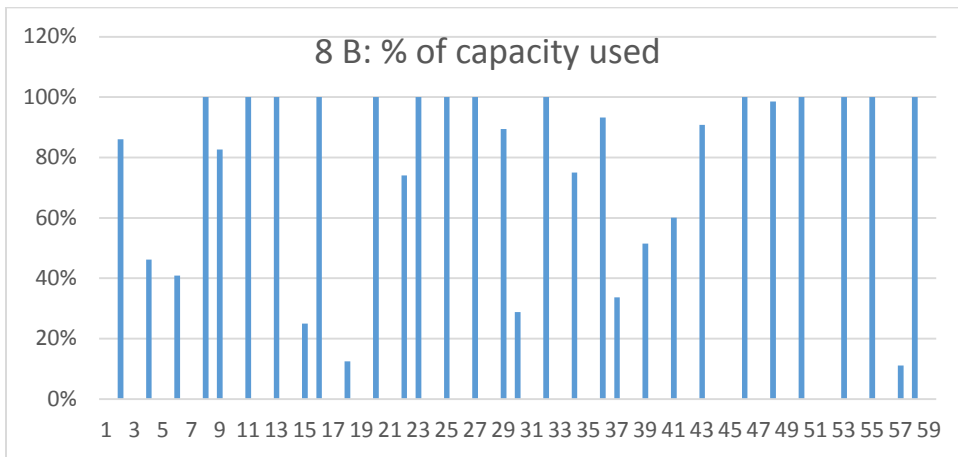

Graph 136

APPENDIX H: IMAGE OF MH DISCRETE EVENT SIMULATION MODEL

Merchant Haulage

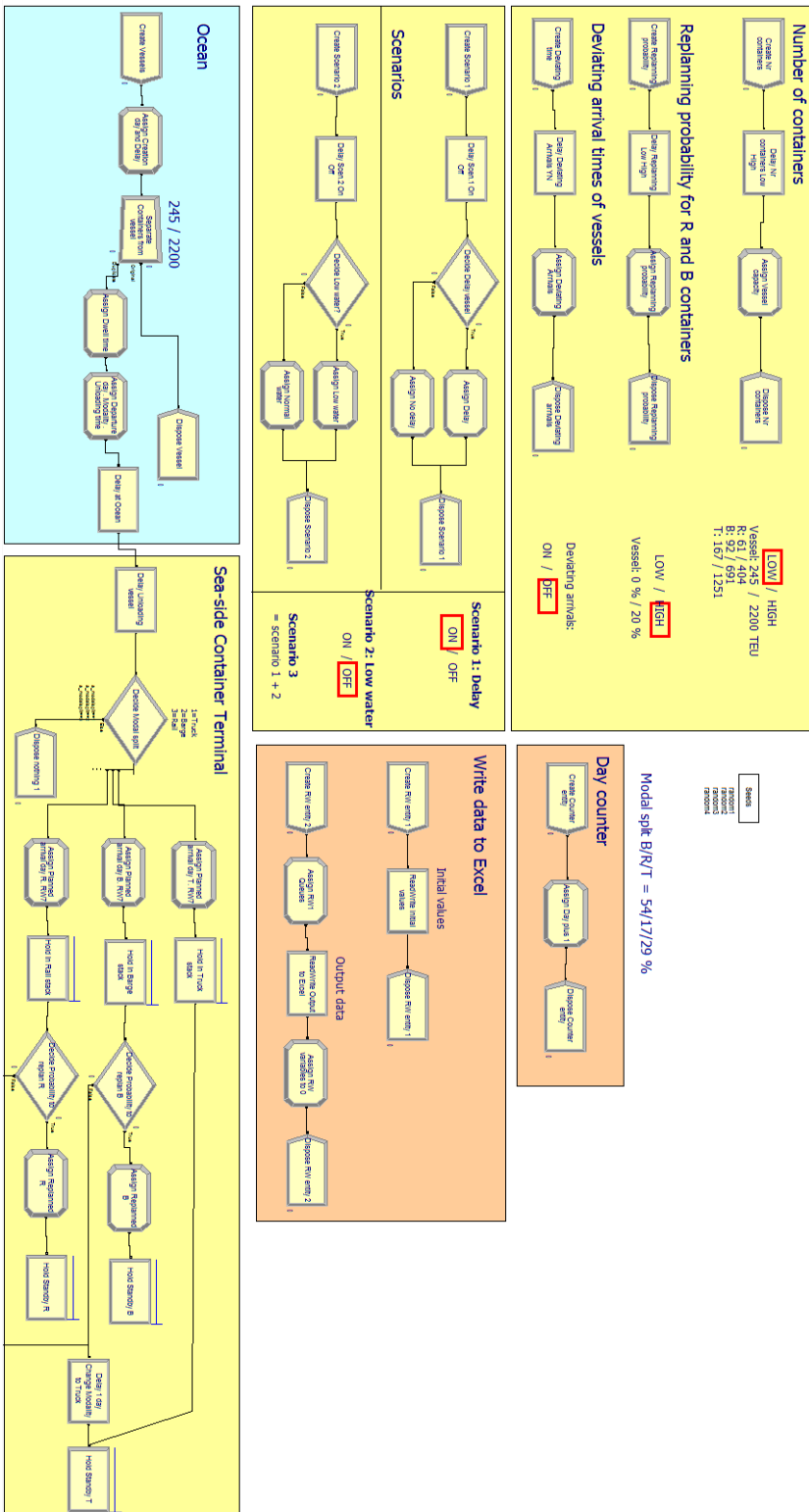

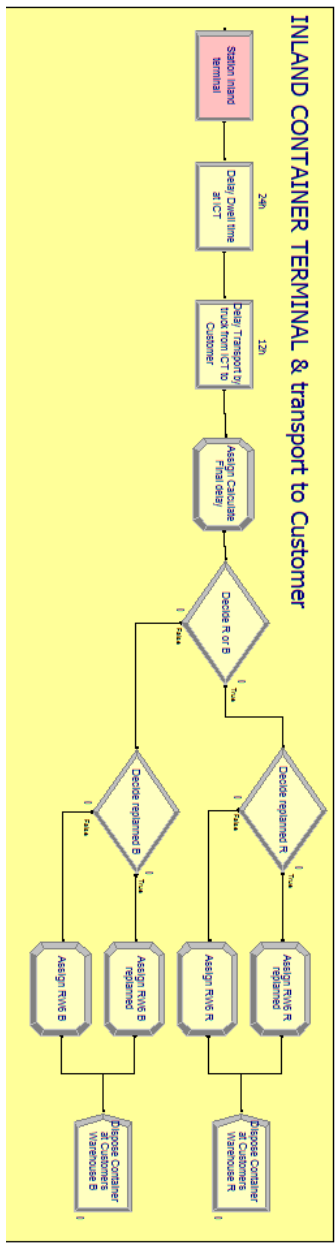
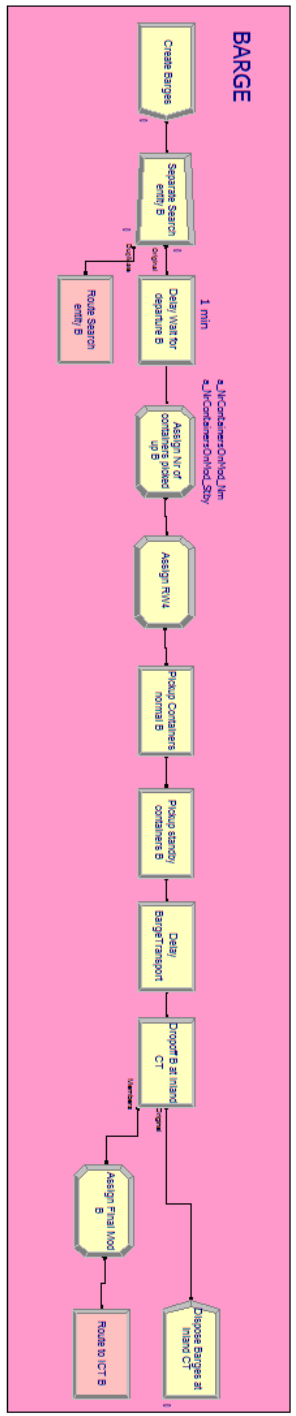
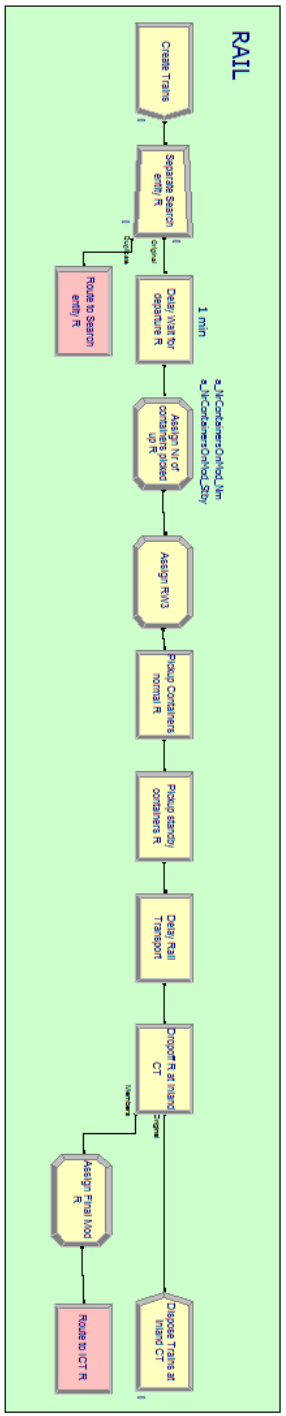
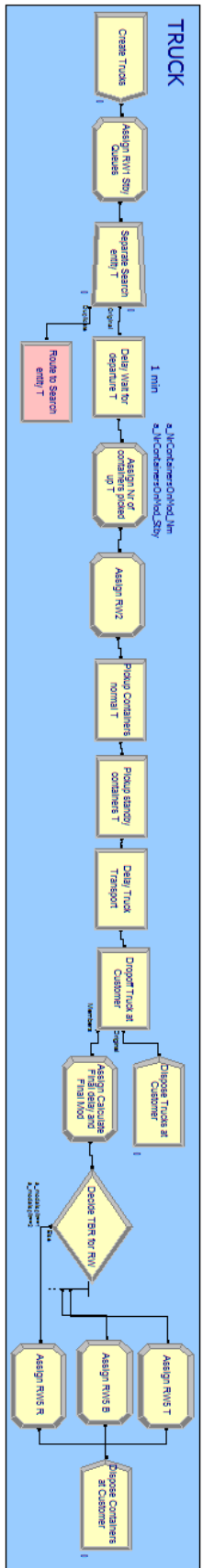

Search containers for transport today

Truck

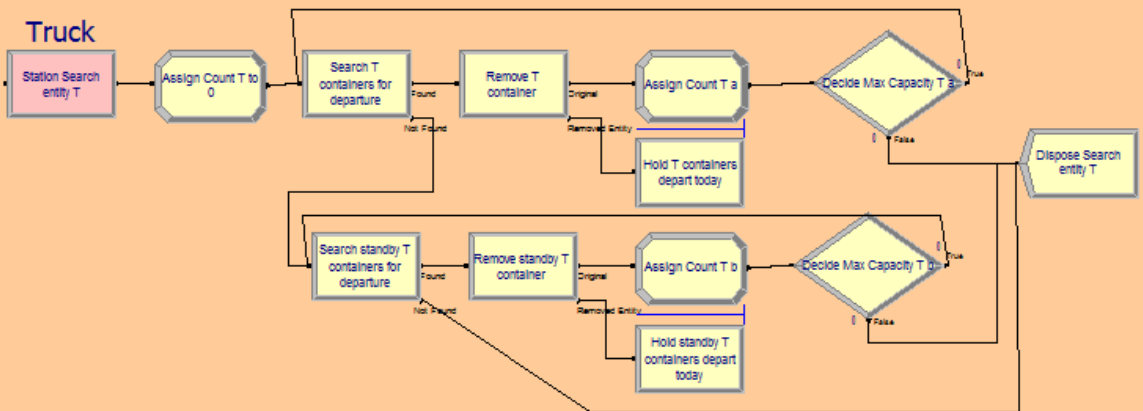

Rail

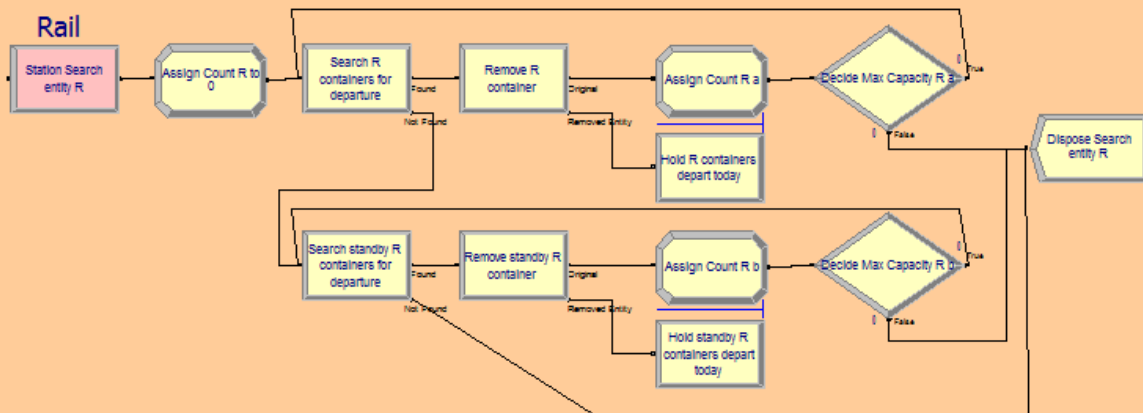

Barge

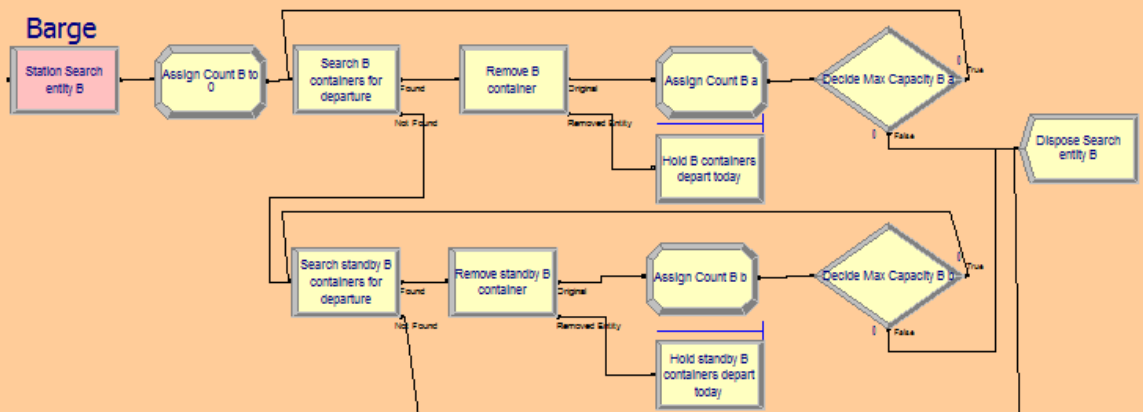

APPENDIX H: IMAGE OF TH DISCRETE EVENT SIMULATION MODEL

DASHBOARD

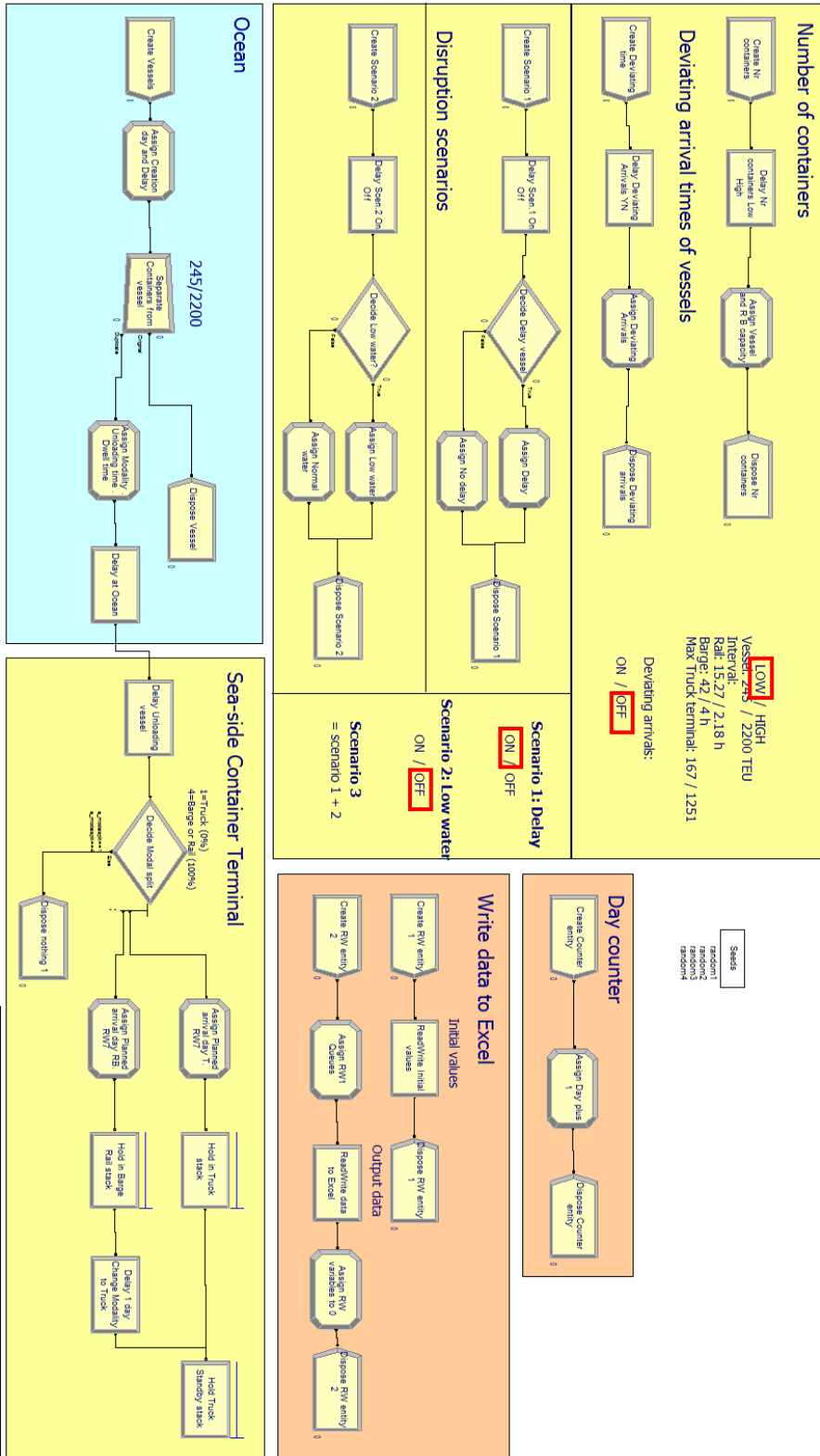

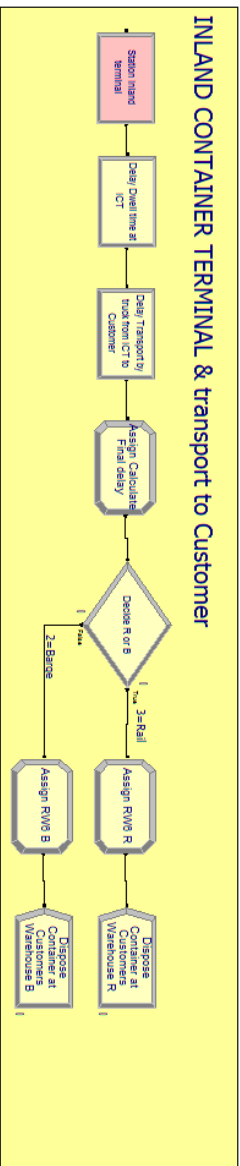
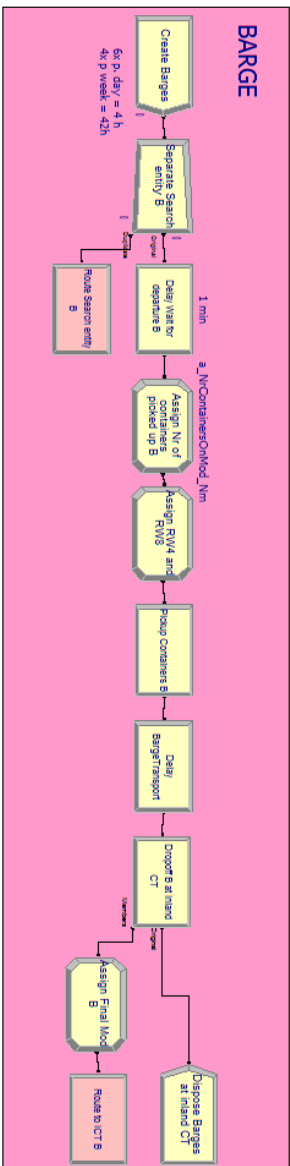
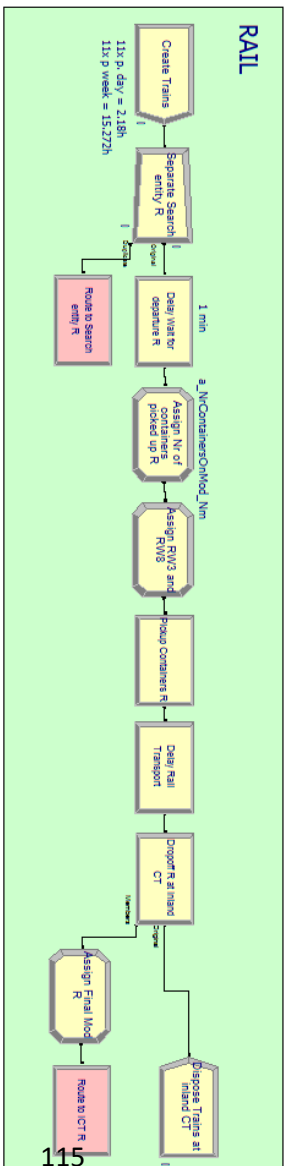
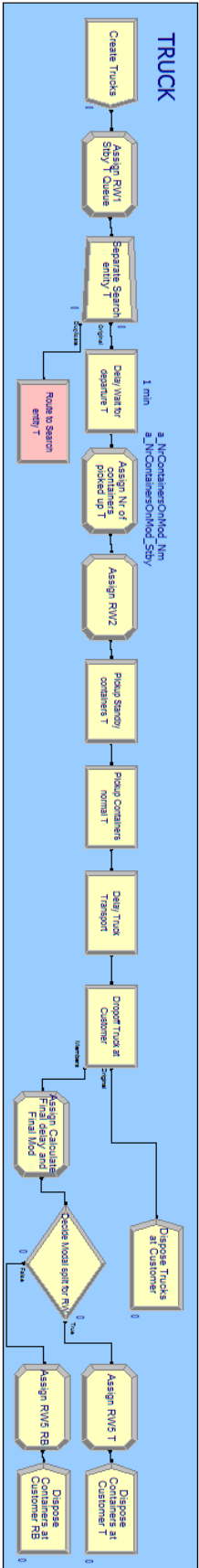

Search containers for transport today

TRUCK

167 / 1251

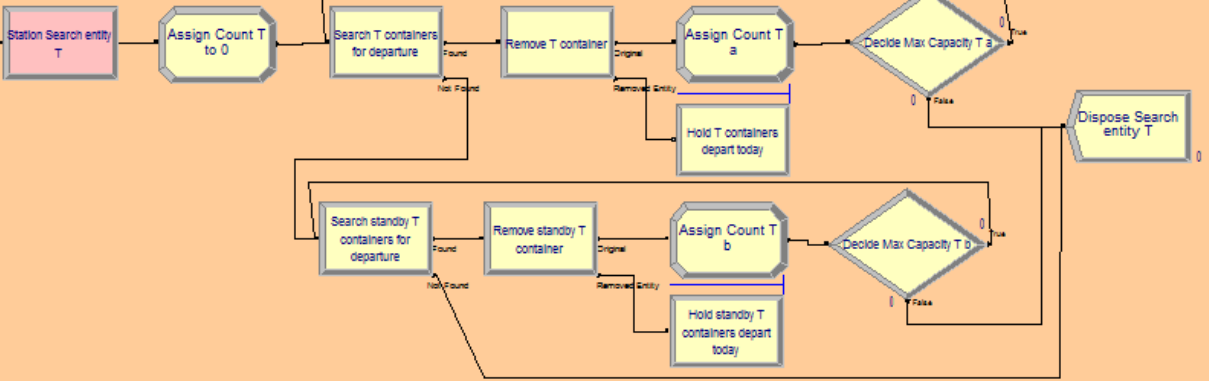

RAIL

90

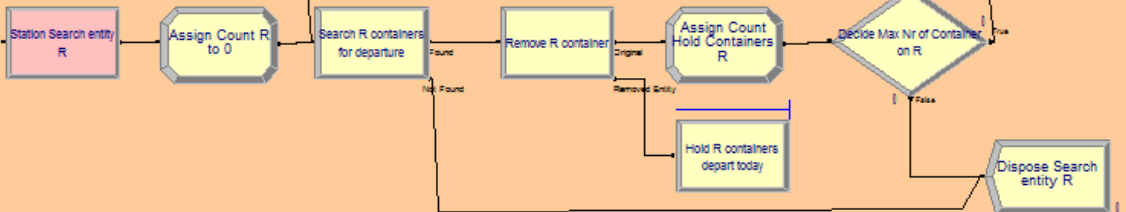

BARGE

208

