

50 mm concrete floor finish
250 mm poured concrete
175 mm insulation
earth

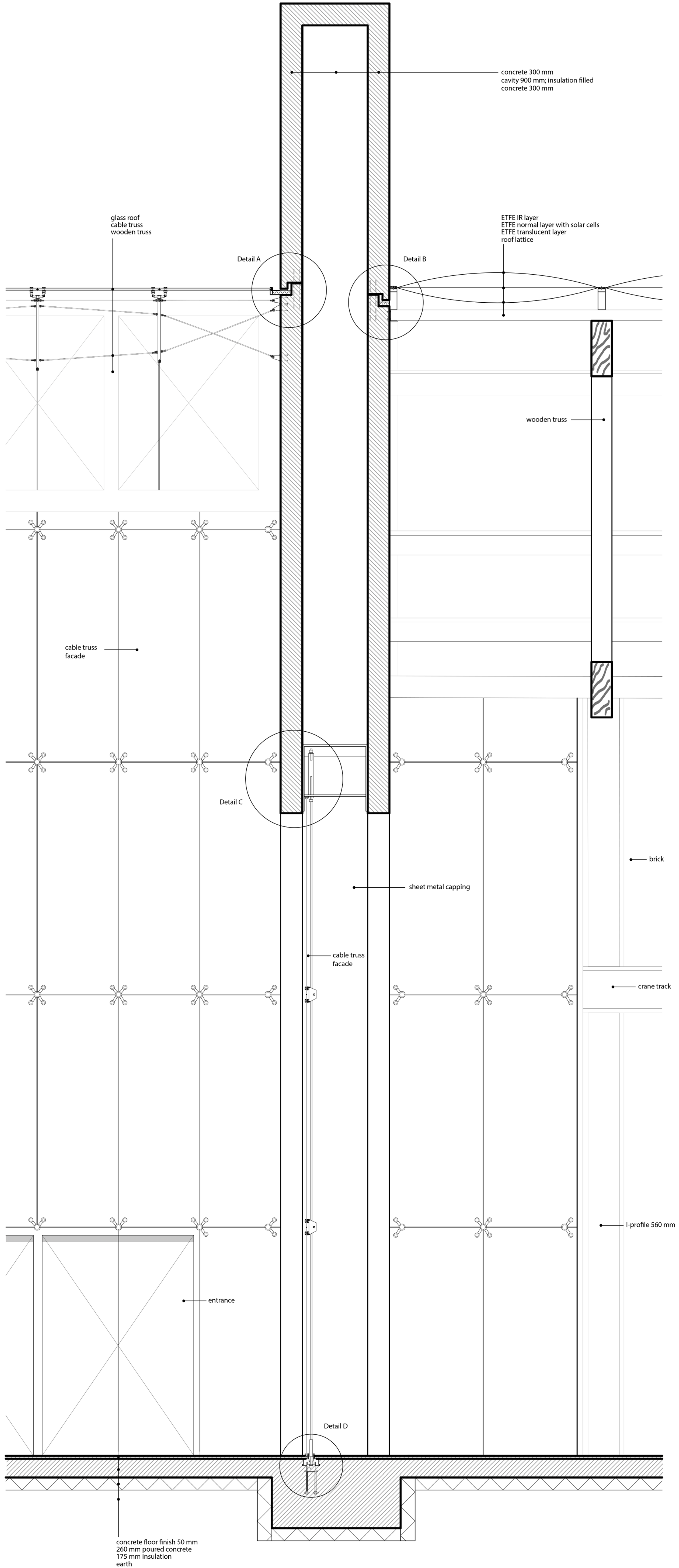

FRAGMENT 1:20

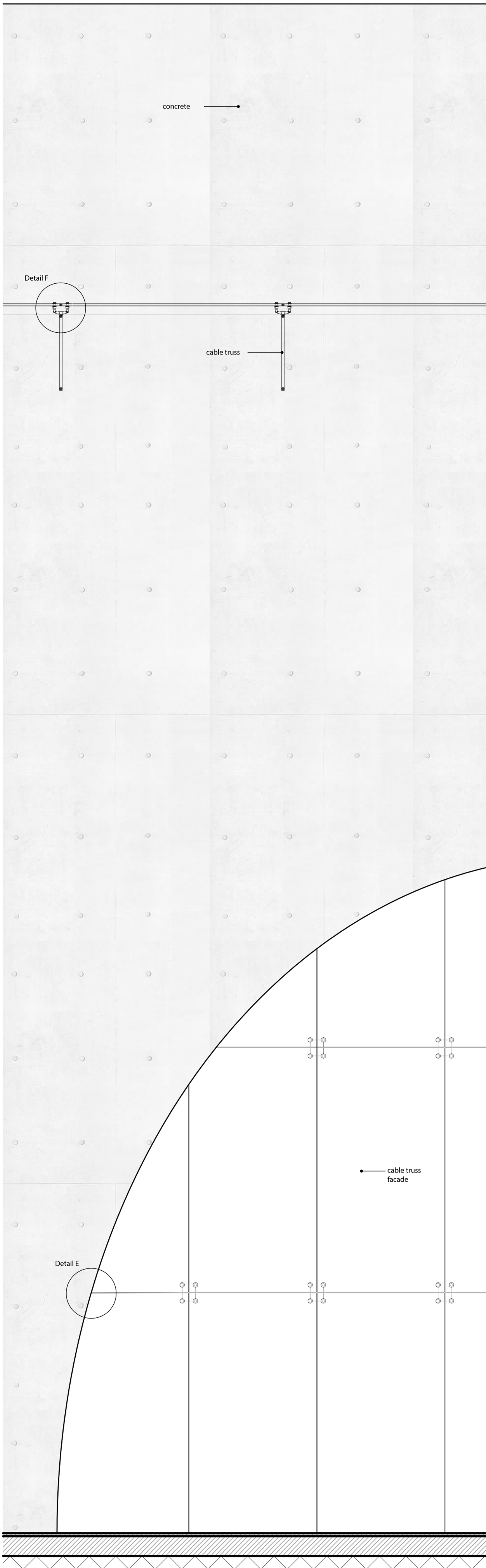

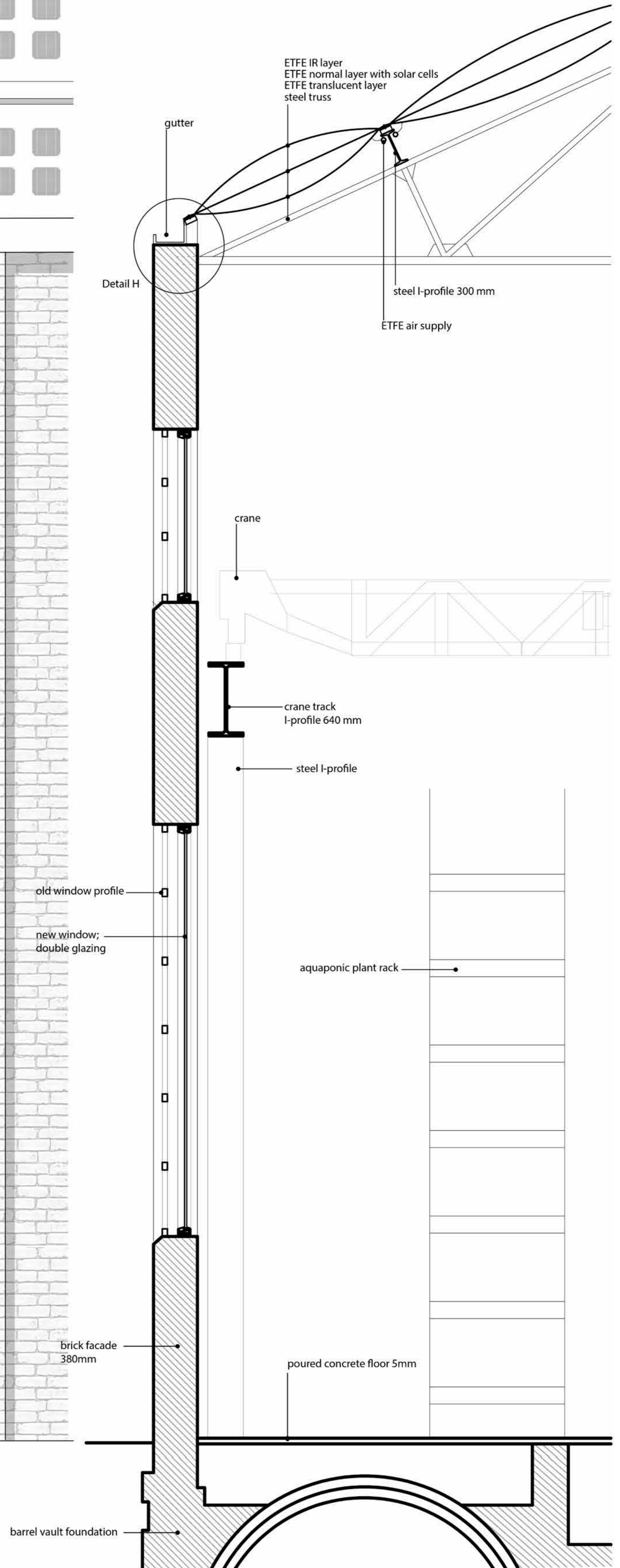
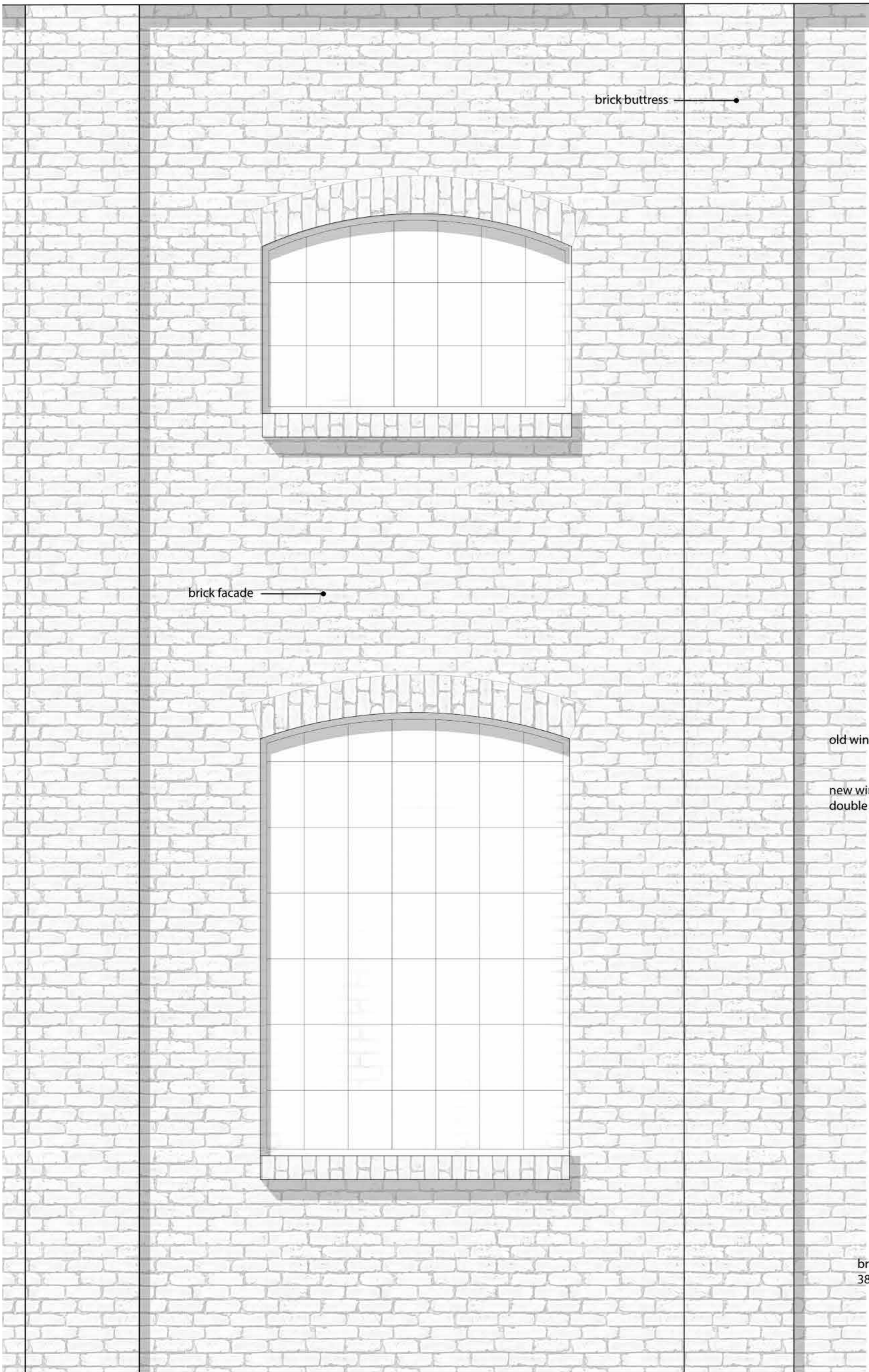
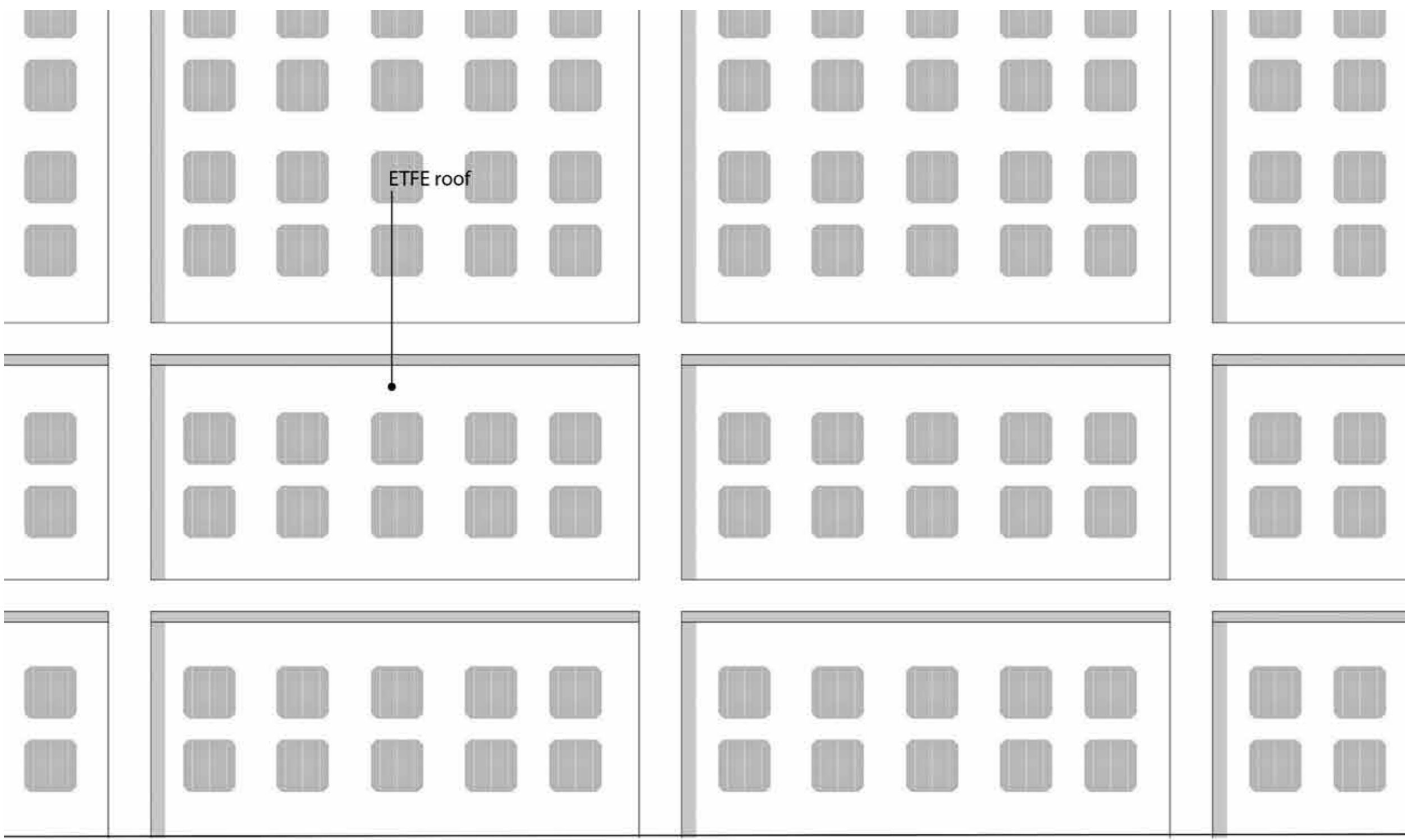
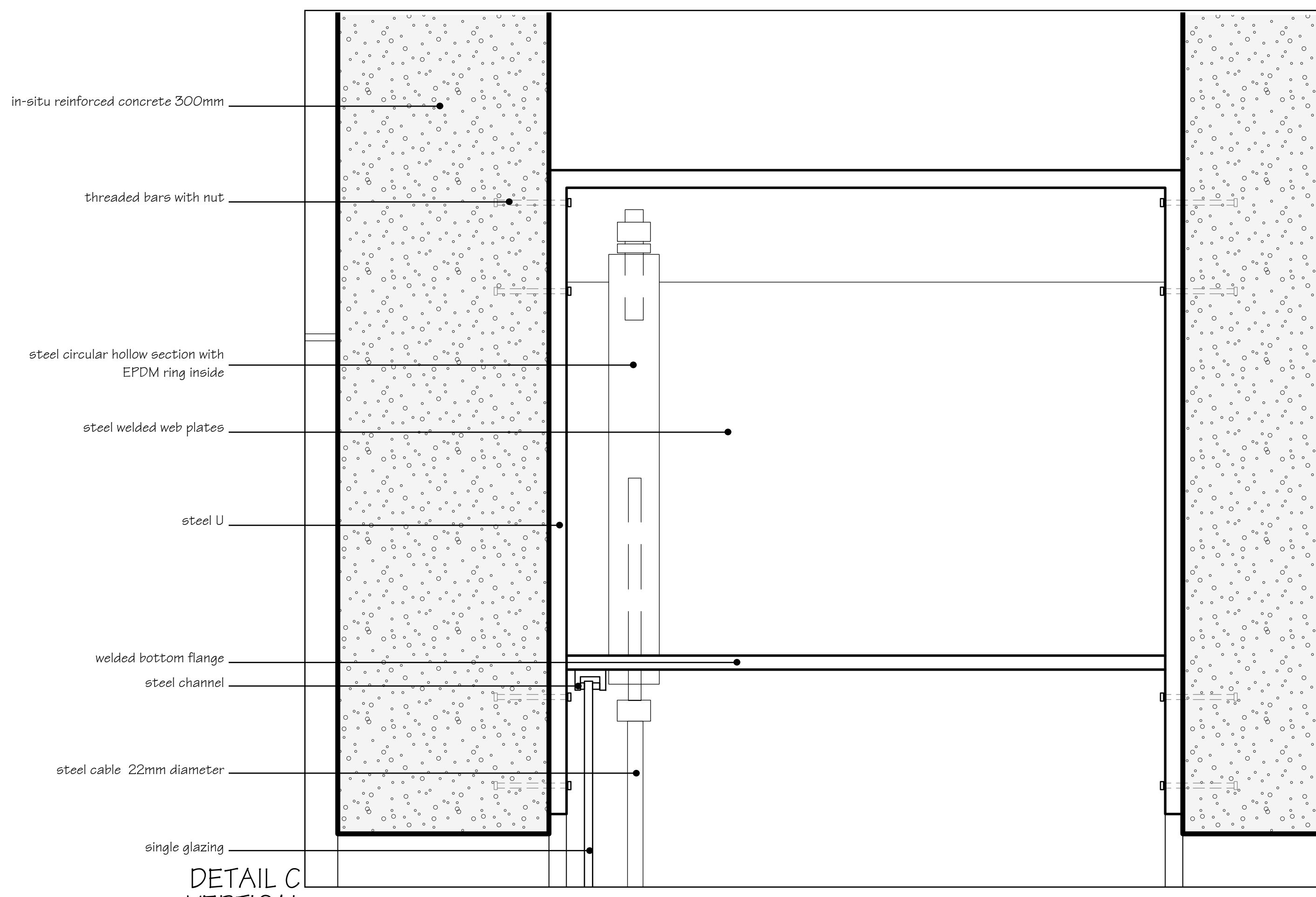

DETAIL C
VERTICAL

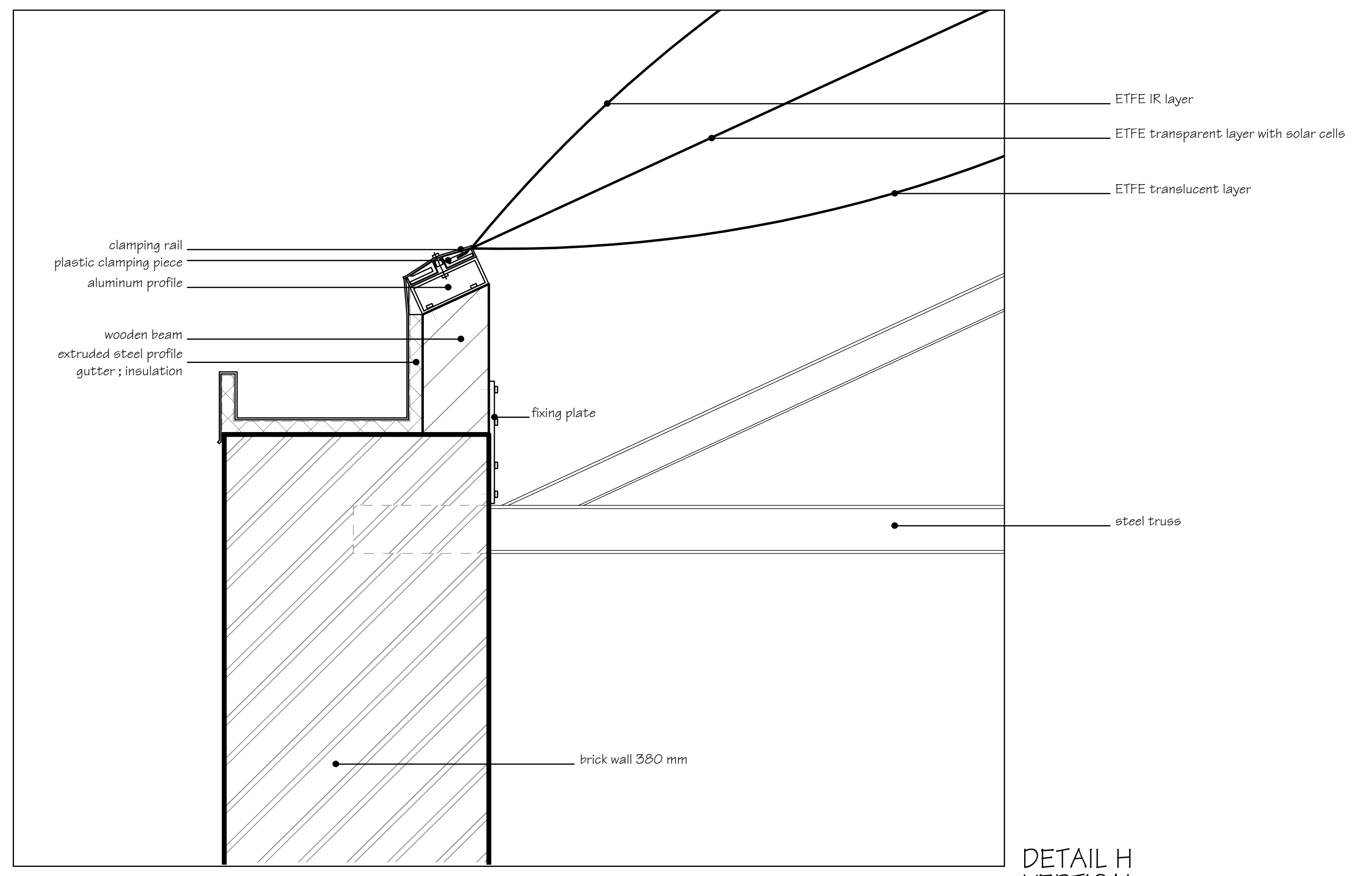

DETAIL H
VERTICAL

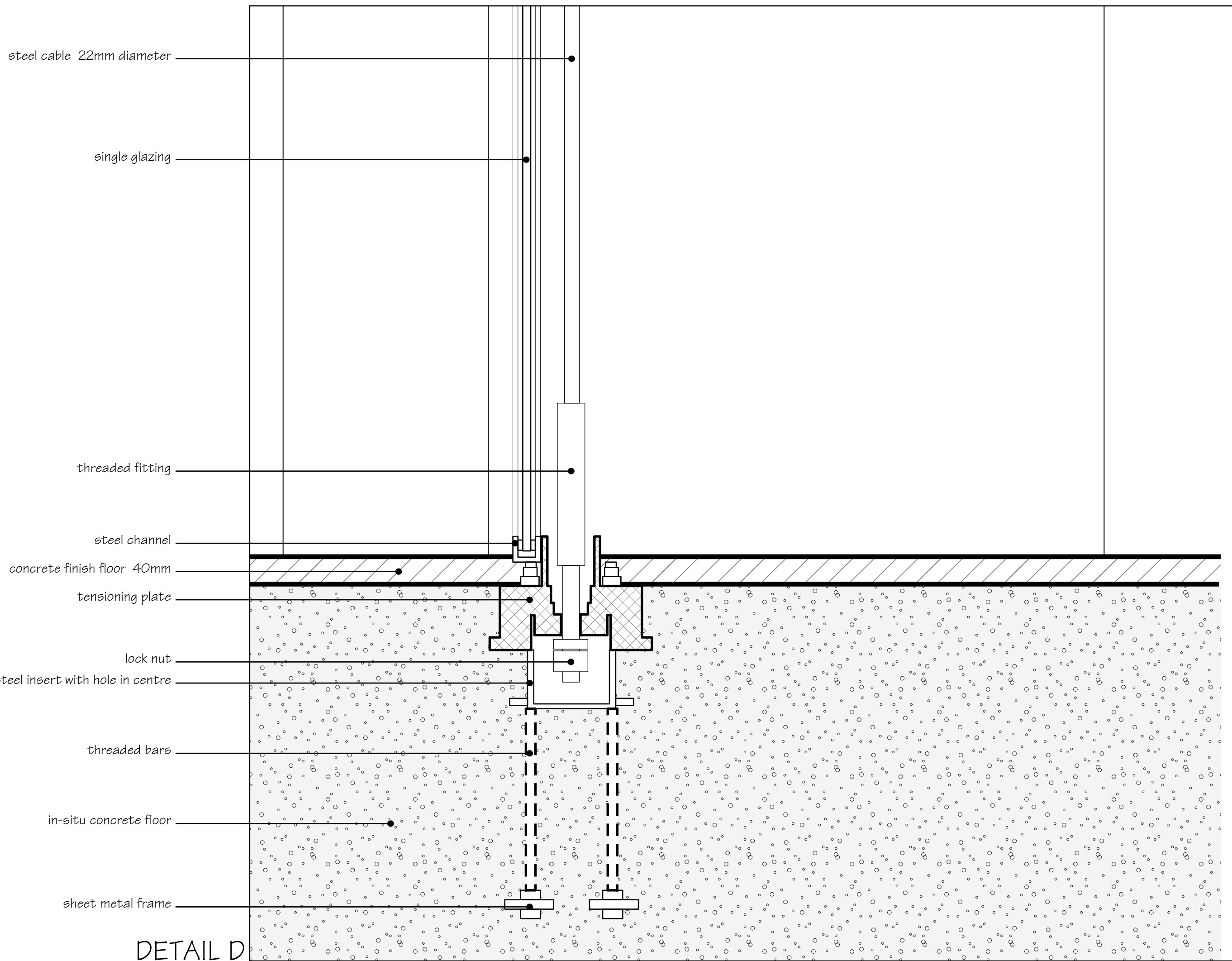

DETAIL D
VERTICAL

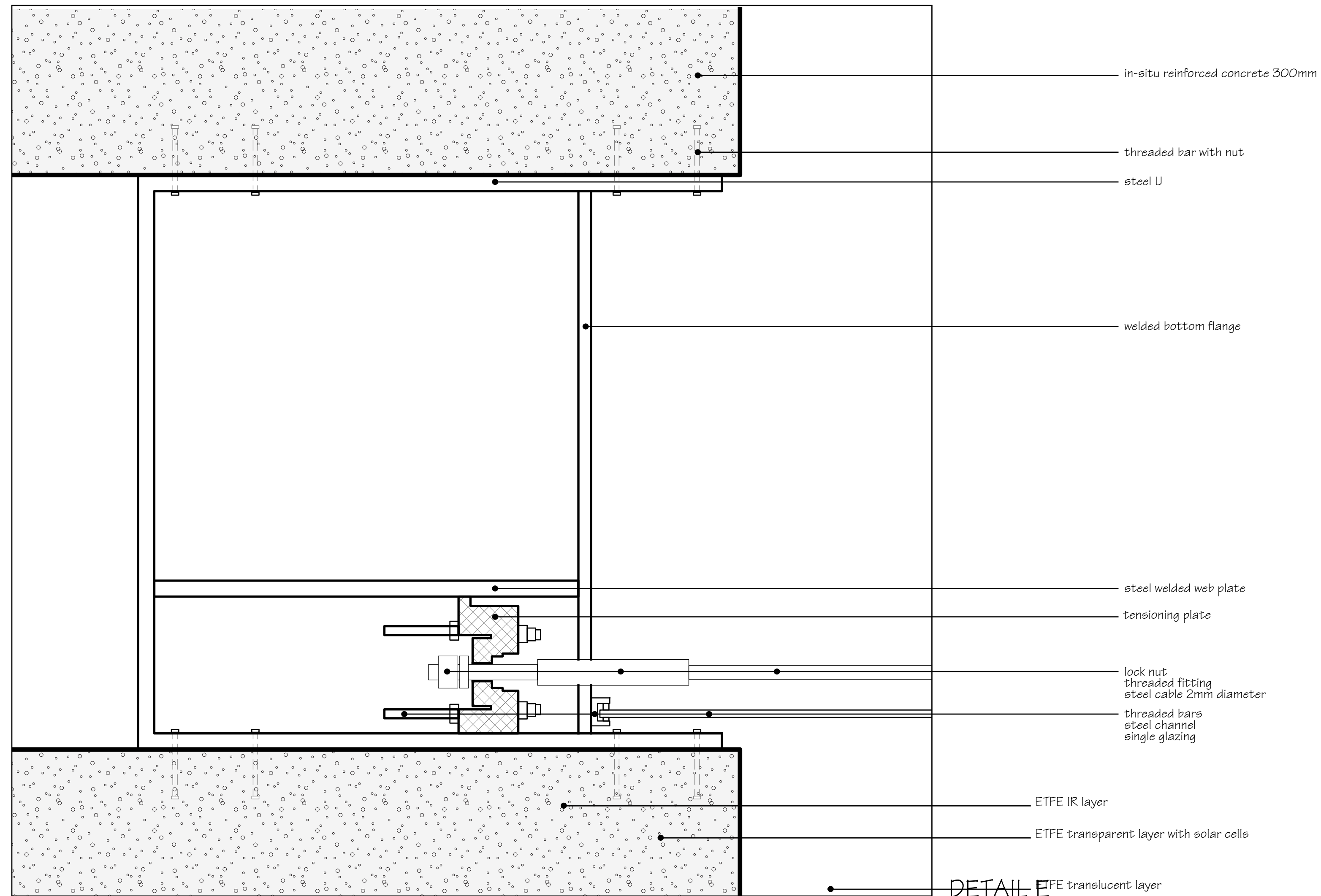

DETAIL E
HORIZONTAL

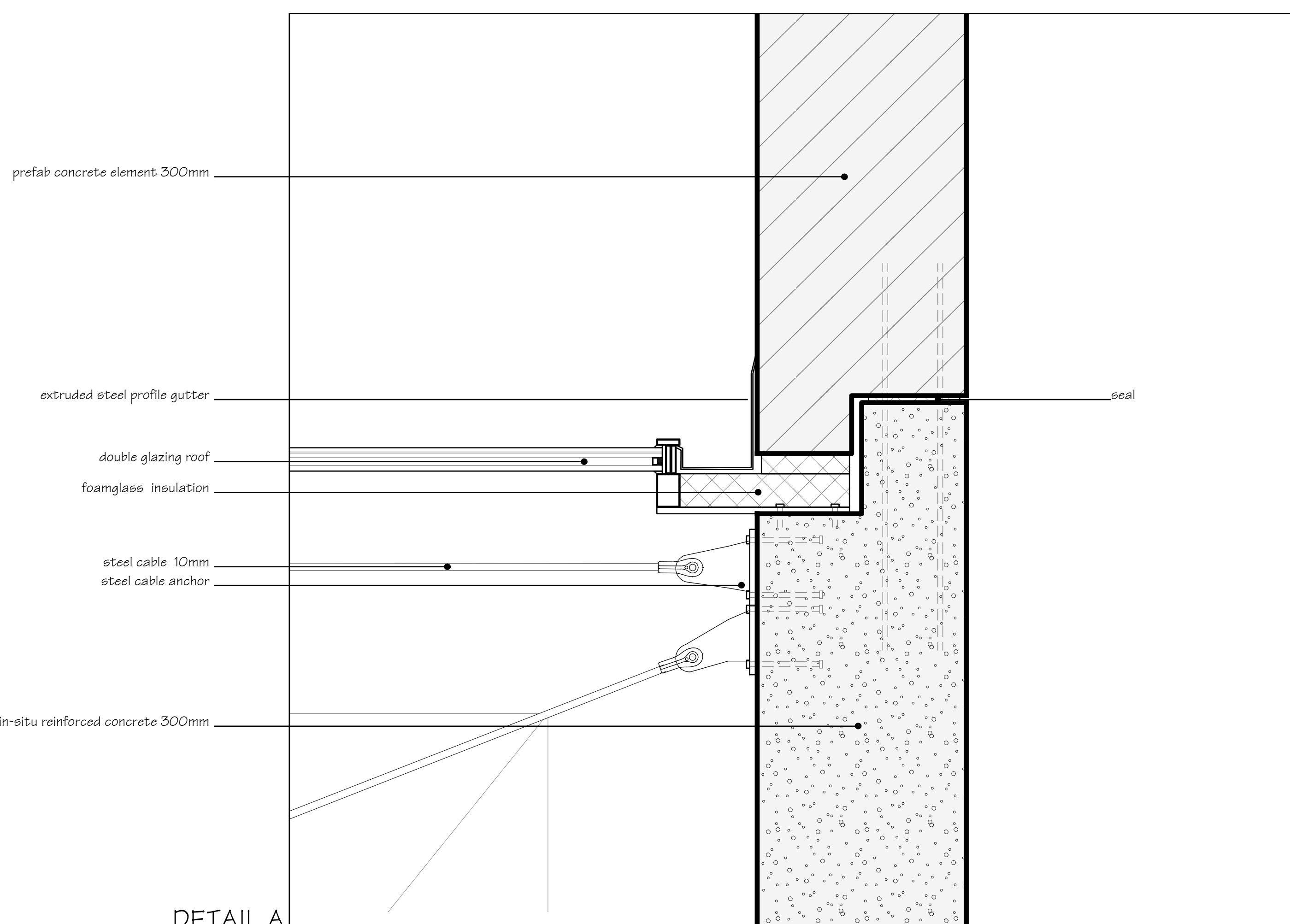

DETAIL A
VERTICAL

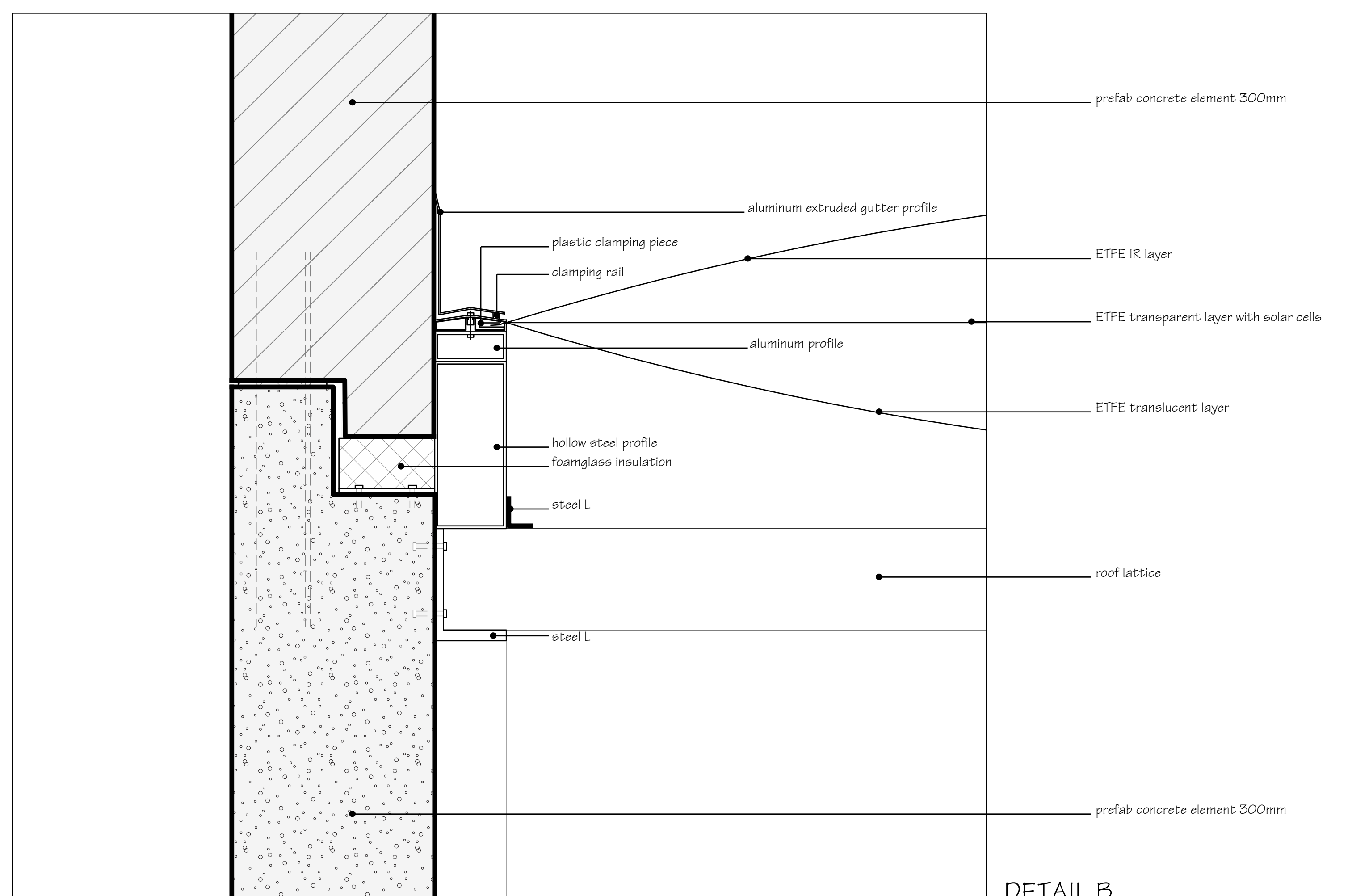

DETAIL B
VERTICAL

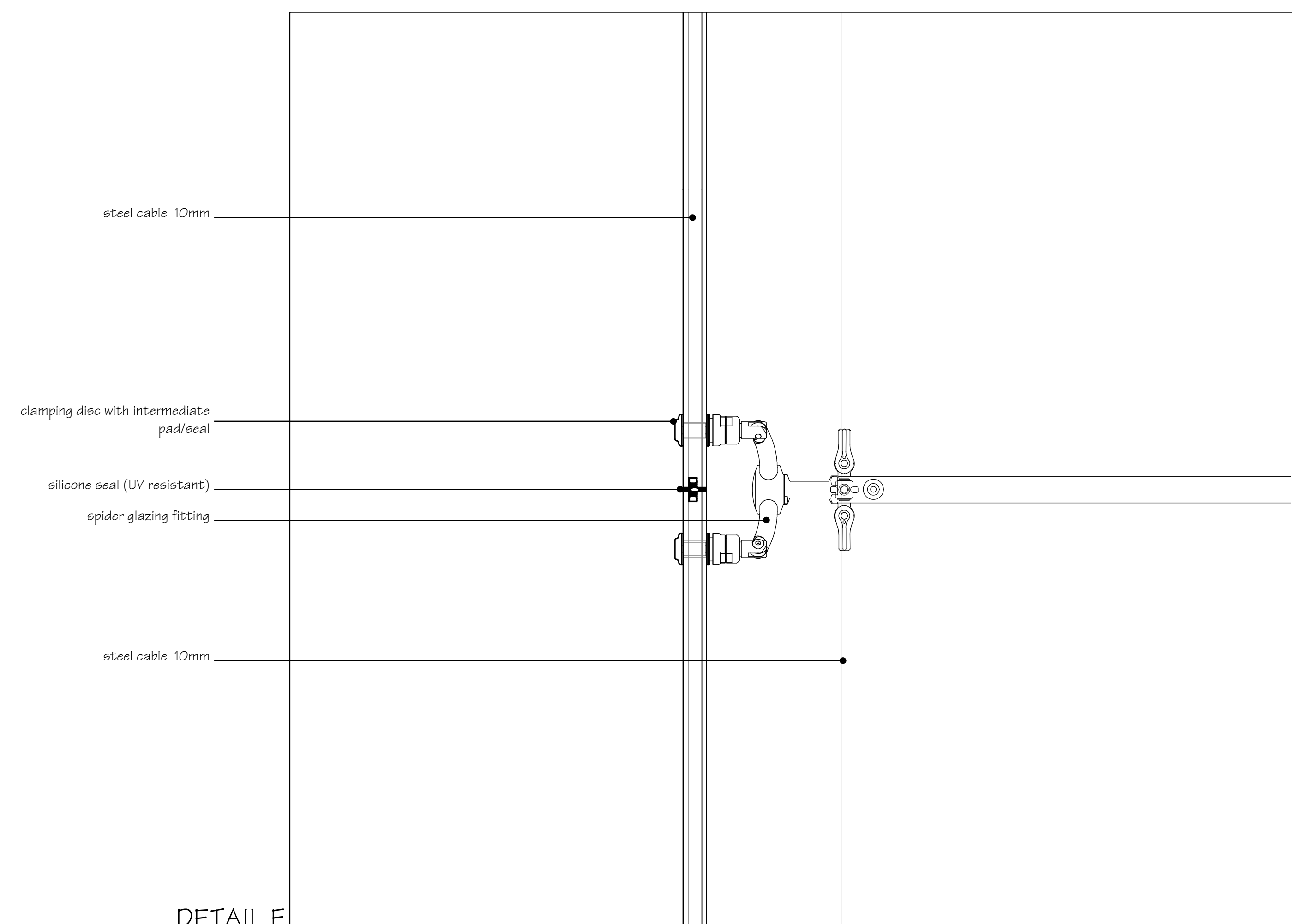

DETAIL F
VERTICAL

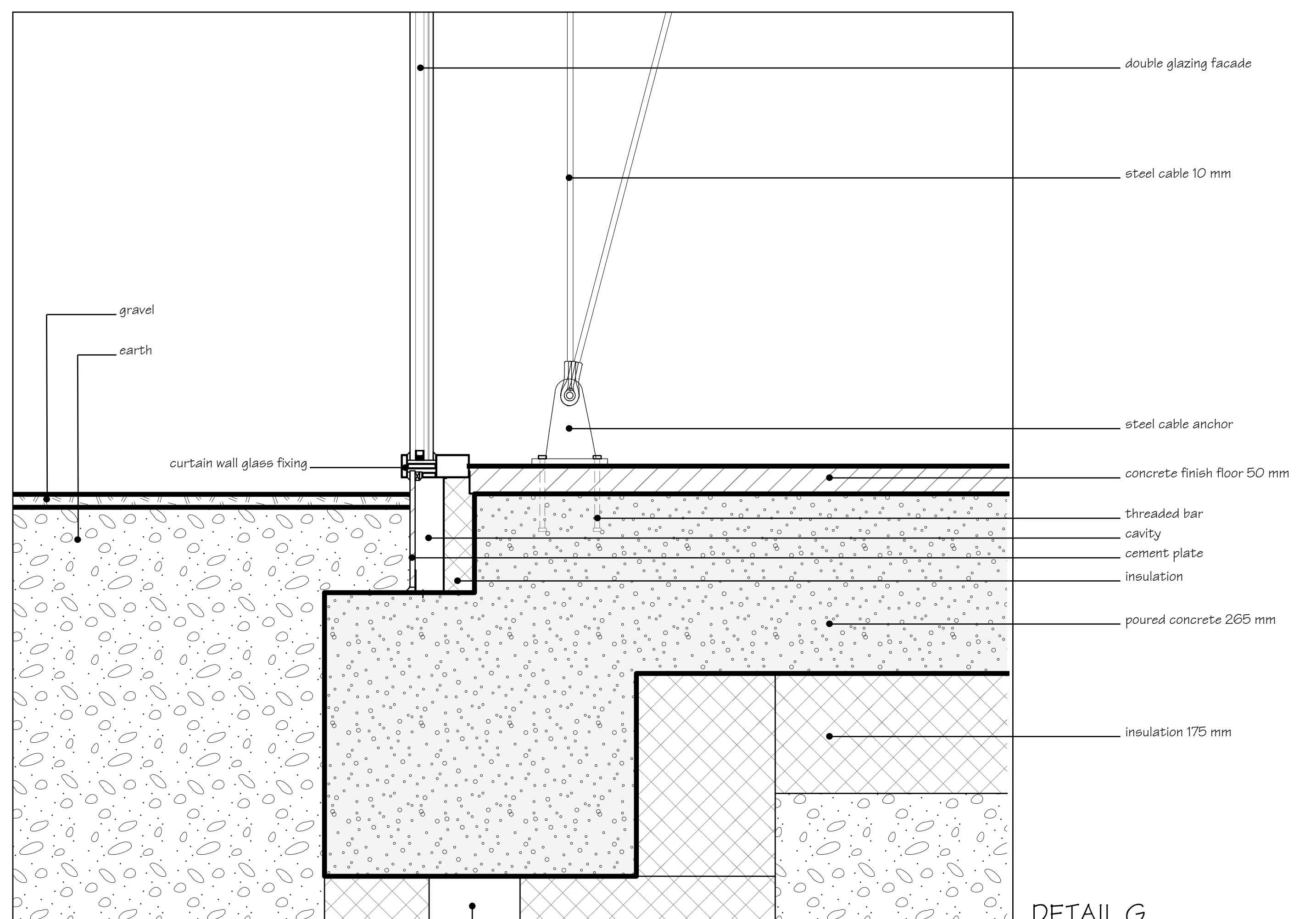

DETAIL G
VERTICAL