

Appendices

Activating household waste separation
behaviour in high-rise Rotterdam

Iris Groot Koerkamp

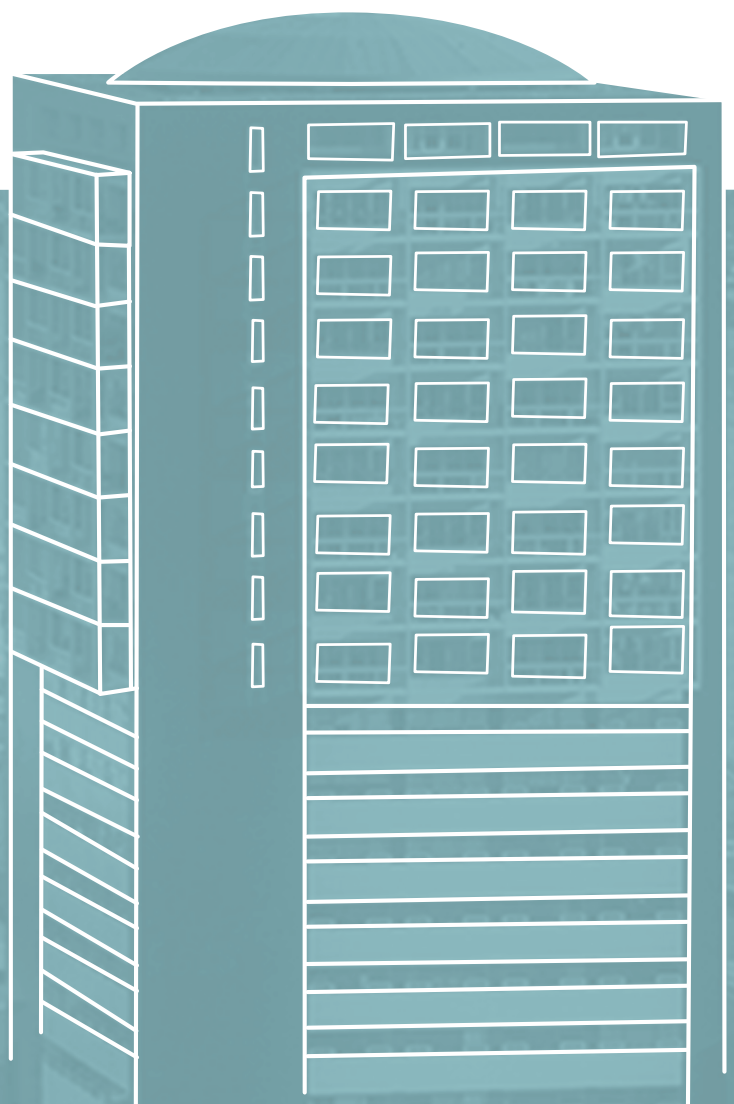

Appendices

Activating household waste separation
behaviour in high-rise Rotterdam
May 2019

*These appendices are complementary to the Master Graduation
Project “Activating household waste separation behaviour in high-rise
Rotterdam” by Iris Groot Koerkamp.*

Master Integrated Product Design
Faculty of Industrial Design Engineering
Delft University of Technology
The Netherlands

Supervisory team

Ir. R.J.H.G. van Heur (Chair)
Applied Ergonomics and Design
Department of Industrial Design, TU Delft

Dr. ir. J.I.J.C. de Koning (Mentor)
Design for Sustainability
Department of Design Engineering, TU Delft

In collaboration with

Ir. T.H. Wobbes (Hub coordinator)
Inclusive City Hub
Leiden-Delft-Erasmus Centre for Sustainability

Ir. S.G.M. Schuurmann (Company mentor)
Department of Urban Management
City of Rotterdam

Content

A: Graduation assignment	04	Q: Concept evaluation workshop with high-rise residents (2)	62
B: Definition of high-rise	12	R: Evaluation of concept ideas	65
C: Population in Rotterdam	13	S: Concept choice	67
D: Waste separation statistics in Rotterdam	14	T: Program of Requirements	68
E: Waste collection in Rotterdam	15	U: Delivery package	70
F: PMD collection in Rotterdam	17	V: Product inspiration	71
G: The value of waste	18	W: Paper prototyping	76
H: Interview guide high-rise residents in Rotterdam	19	X: Concept variations	78
I: Category cards photo study in-home waste management	20	Y: Evaluation of concept variations	84
J: Generative workshop with high-rise residents (1)	35	Z: Technical drawings of waste facilities	88
K: Existing solutions	43	AA: Form fitting small waste bin	92
L: Creative session	48	BB: Form fitting large waste box	93
M: Idea sheets	51	CC: Cost estimation	94
N: Idea clusters	56	DD: Locations of disposal points	97
O: Innovativeness, Feasibility, and Desirability for Urban Management	57	EE: Instruction booklet	98
P: Concept ideas	60	FF: Pilot test set-up	99
		GG: Evaluation form pilot test	101
		HH: Participants' use of <i>Schone start</i>	103
		II: Mailbox delivery of <i>Schone start</i>	104

2982

IDE_Graduation_Assignment_Groot_Koerkamp_Iris_4223012_15-11-2018

IDE Graduation Assignment (version 2017.09.21)
incl. the student's study progress (Appendix 3)

		Name student	I.M. (Iris) Groot Koerkamp
		Student number	4223012
		Address	Oost-Indiëplaats 13
		Zip- code, City	2611 BR, Delft
		Telephone	+31 6 42314563
		E-mail address	irisgrootkoerkamp@hotmail.com
		Start at IDE: 2012	Start at TU Delft: 2012
Bachelor¹	Master¹	Specialisation¹	
<input checked="" type="checkbox"/> TUD Bachelor IO <input type="checkbox"/> TU/e or UT Bachelor IO <input type="checkbox"/> TU Delft non-IO BSc <input type="checkbox"/> Other Dutch University Bachelor <input type="checkbox"/> HBO Bachelor <input type="checkbox"/> Foreign Bachelor	<input checked="" type="checkbox"/> IPD <input type="checkbox"/> DFI <input type="checkbox"/> SPD <input type="checkbox"/> = 2nd non-IDE master <input type="checkbox"/> Individual programme, date of approval ² <input type="checkbox"/> Master Honours Programme	<input type="checkbox"/> Medisign Annotation¹ <input type="checkbox"/> Techn. in Sustainable Design <input type="checkbox"/> Entrepreneurship	
Name Chair		Ir. R.J.H.G. (Ruud) van Heur	
1. Check study progress		<i>To be completed by the Shared Service Centre O&S after approval of the assignment by the chair. The study progress will be checked for a 2nd time just before the green light meeting.</i>	
Bachelor degree:		<input checked="" type="checkbox"/> Yes	<input type="checkbox"/> No <input type="checkbox"/> N.A.
Missing 1 st year Master courses	1. 2. 3.	4. 5. 6.	
Master electives, no. of EC credits accumulated:dec...	
Name:		Date: 10/12/2018	Signature: CB
2. Formal approval Graduation Assignment by the Board of Examiners		<i>To be completed by the Board of Examiners</i>	
Approval of the content of the Grad. Assignment:		<input checked="" type="checkbox"/> Approved	<input type="checkbox"/> Not Approved
Procedural approval:		<input checked="" type="checkbox"/> Approved	<input type="checkbox"/> Not Approved
Comments:	Only one company mentor is allowed ✓		
Name: A. Kuwae		Date: 8/1/2019	Signature: A

¹ Tick where appropriate.² Date of approval of your individual programme by the Board of Examiners.
TU Delft / IDE / E&SA Department (update 20170921)

IDE Graduation Assignment

GENERAL INFORMATION

Title Graduation Project ³	The future of household waste management in Rotterdam's high-rise buildings		
Chair of Supervisory Team ⁴	Ir. R.J.H.G. (Ruud) van Heur		
Department / Section	Department of Industrial Design (ID) / Applied Ergonomics & Design		
Mentor of Supervisory Team ⁴	Dr. ir. J.I.J.C. (Jotte) de Koning		
Department / Section	Department of Industrial Design (ID) / Design Conceptualization & Communication		
Project commissioned by ⁵	<input type="checkbox"/> Faculty	<input type="checkbox"/> Company	<input checked="" type="checkbox"/> Other, e.g. entrepreneurial
Project type ⁵	<input checked="" type="checkbox"/> Design	<input type="checkbox"/> Research ⁶	<input type="checkbox"/> Other, e.g. entrepreneurial
Company name, if applicable	Gemeente Rotterdam & Inclusive City Hub (ICH)		
City & Country	Rotterdam, the Netherlands		
Company Mentor	Nick van Barneveld (Gemeente Rotterdam) & Tjerk Wobbe (ICH)		
Start date	15/11/2018		
End date	02/05/2019		

CONTENT

Introduction

Give a sketch of the context of your assignment. Historical developments, if applicable relevant published scientific research results, new trends, status quo; materials, technologies, usage, etc.

- In case of a faculty project: describe how your assignment reflects the research portfolio of the IDE Faculty ⁶.
- In case of a company project: provide company information.
- If other, e.g. entrepreneurial: describe the future enterprise and how your assignment will be of value to the enterprise.

Include an illustration or visual which depicts the context of your assignment.

In case one or more extra parties are involved in your project, indicate which role they play.

The city of Rotterdam counts 638.181 inhabitants, of which 75% lives in high-rise buildings (Municipality of Rotterdam, 2018). In 2017 415,6 kg of household waste was produced per inhabitant, of which 297,4 kg (71,6%) is residual waste (CBS, 2018). Residual waste is incinerated (Municipality of Rotterdam, n.d.). This does not stroke with the ambition of the municipality to recycle 40% of the total household waste by 2020 (Municipality of Rotterdam, 2018). Separating waste into fractions has both environmental and economic benefits: recyclable resources can be saved from incineration, while yearly incineration costs for the municipality can be decreased (Midden, 2015). The goal of the European Union is even more ambitious: to recycle 65% of the waste by 2035 (Municipality of Rotterdam, 2018). This means Rotterdam needs to step up their game in order to reach the circular goals regarding household waste.

Especially high-rise areas form a big challenge, as inhabitants of high-rise buildings produce 150kg more residual waste per year than their fellow citizens living in low buildings (Design Innovation Group, 2015). This challenge will only grow, as plans are initiated by the municipality of Rotterdam to build 50.000 extra residencies by 2040, most of which will be built as high-rise within the urban area of the city (Liukku, 2017).

Let's zoom in from high-rise buildings to their residents and their households. To tackle the residual waste problem, it is essential to look at the waste separation behaviour at a household level. Midden (2015) identifies three main factors influencing waste separation behaviour: psychological and personal characteristics; social and cultural characteristics; and spatial and technical characteristics. High-rise districts can be distinguished from low-rise living areas within all three factors. High-rise living is (usually) characterized by smaller (outside) space and use of communal (instead of personal) containers (spatial and technical). The residencies (often) create a more anonymous culture, with less social control (social and cultural). The attitude towards separation

³ Keep the title compact and simple. Do not use abbreviations.

⁴ Avoid team members from the same section. In case a non-IDE mentor is preferred over an IDE-mentor, the Chair should request so for approval by the Board of Examiners (including a motivation letter and c.v. of the proposed non-IDE mentor).

⁵ Tick where appropriate. See the IDE Graduation Manual, paragraph 2.5. If necessary, explain at Introduction.

⁶ See webpage <http://www.io.tudelft.nl/en/research/>

behaviour is, for example, influenced by visible behaviour of neighbours (psychological and personal). Typical for high-rise buildings is the lack of routine in waste disposal and therefore a lack of insight in the amount of waste produced (Design Innovation Group, 2015). Currently several characteristics of high-rise buildings impede waste separation by residents. Questions that arise are: **What are the main barriers for waste separation at household level, in high-rise buildings? How to facilitate the desired behaviour of waste separation at household level, in high-rise buildings?**

Current interventions to stimulate the desired waste separation behaviour are not tailored to the specifics of the high-rise living 'sub-culture' and the needs of its actors (Midden, 2015). This forms the opportunity to design user-centred solutions to facilitate waste separation behaviour in this specific context. In accordance with the mission of the IDE faculty, this graduation project aims for a better future, where sustainable behaviour is part of everyday life, while balancing the interests of users, industry, society and the environment.

This graduation assignment is written by the graduation student within the case 'Circular Rotterdam: innovative solutions for waste collection and recycling in high-rise districts' of the Inclusive City Hub in collaboration with the municipality of Rotterdam. The Inclusive City Hub (<https://delftdesignlabs.org/inclusive-city/>) serves as a platform for master students from Leiden, Rotterdam and Delft to graduate individually within an interdisciplinary team, by facilitating meet-ups, workshops and a network of stakeholders. The municipality of Rotterdam serves as case-owner and can provide insights, data and feedback upon request.



Figure 1 | Context of the graduation assignment 'The future of household waste management in Rotterdam's high-rise buildings': households within the 'high-rise subculture' (Image sources: Rotterdam Tourist Information, Municipality of Rotterdam, 100-100-100.nu)

References:

- CBS, 2018. *Huishoudelijk afval per gemeente per inwoner*. Retrieved October 22, 2018, from <http://statline.cbs.nl/Statweb/publication/?DM=SLNL&PA=83452NED&D1=0&D2=a&D3=396&D4=a&HDR=T,G3&STB=G2,G1&VW=T>
- Design Innovation Group (2015). *Vuilnis in de flat*. Retrieved October 8, 2018, from <https://www.vang-hha.nl/@151170/onderzoeksrapport-3/>
- Liukku, A. (2017). *Rotterdam wil 50.000 woningen bijbouwen*. Retrieved October 22, 2018, from <https://www.ad.nl/rotterdam/rotterdam-wil-50-000-woningen-bijbouwen~ad0949e6/>
- Midden, C. (2015). *Verbetering afvalscheiding en inzameling hoogbouw*. Retrieved October 16, 2018, from <https://www.vang-hha.nl/@148641/literatuurstudie/>
- Municipality of Rotterdam (2018). *Pilot circular wastemanagement high rise building Rotterdam*. Presentation, Rotterdam.
- Municipality of Rotterdam (n.d.). *Plastic afval apart inzamelen*. Retrieved October 22, 2018, from <https://www.rotterdam.nl/wonen-leven/plastic/>

Problem definition

Indicate clearly, what should/could be improved compared to the present situation. When executing a research project: indicate the knowledge gap. What opportunities exist, what contradicting demands should be addressed, etc.

The challenge is to find how to stimulate and facilitate waste separation for residents of high-rise buildings, to minimize the residual waste fraction. Currently in Rotterdam only around 30% of the waste is separated into fractions: PMD (plastic packaging, cans and beverage cartons), GFT (bio waste), paper, glass, textile and chemical waste. This needs to increase to at least 65% by 2035 (Municipality of Rotterdam, 2018).

This challenge includes sub-challenges at different levels: optimization of the waste management system on municipality level including assessment of stakeholders; division of responsibilities and policies; suitable technical and logistical solutions for waste collection and distribution on city and building level; practical, behavioural and motivational concepts; and interventions at household level.

Assumed is that currently, for residents of high-rise buildings, the perceived (personal or communal) benefits of household waste separation do not sufficiently outweigh the limitations (e.g. small spaces, dirty smells or lack of (visible) social norms).

Assignment

Briefly and to the point, describe what you are going to design, create or generate to solve (part of) the problem. In case of a Specialisation and/or Annotation, address specifically how this is/these are included in the assignment.

This graduation assignment focusses on generating qualitative insights into the sub-culture of people living in high-rise buildings (household level, see problem definition), and specifically their behaviour regarding household waste separation and management (Figure 2). The broader context of waste separation and management can be used as exploration and inspiration space. When understanding the main barriers for waste separation in high-rise buildings, an innovative solution to support residents of high-rise buildings with waste separation at home will be created.



Figure 2 | Context, topic, scope and focus of the graduation assignment (Image sources: Rotterdam Tourist Information, Municipality of Rotterdam, 100-100-100.nu)

Approach

What will be the approach to deal with the complexity of the assignment? What has to be done to meet the challenges? Indicate the main methodologies to be used. Indicate the same project phases as you distinguish in your planning. If one or more extra parties are involved in your project, indicate which role they play. In case of a Specialisation and/or Annotation, address specifically how this is/these are dealt with.

Residents of high-rise buildings will be the main focus of intervention for this graduation assignment. A target group within the this group of people (e.g. low-income, families with children, seniors) will be defined in the first phase of the project. Through generative research their desires, needs and frustrations regarding household waste management and living in high-rise buildings will be identified, together with their dreams for the future. The qualitative insights, will enable the generation of multiple possible solutions, of which one will be selected. The selected solution will be further developed into a product (or product-service) concept and its use will be illustrated by a functional prototype. A first evaluation of the result will be carried out in conclusion of this graduation project.

Phases:

- Assignment + team (part-time): Set-up of graduation assignment and formation of supervisory team
- Research: generative design research with high-rise residents, consisting of observation studies, sensitizing assignments for participants, a generative workshop and interviews; literature study; observation and exploration of initiated solutions in other cities and other countries
- Ideation: ideation workshop together with residents of high-rise buildings, ideation workshop with students of the Inclusive City Hub
- Concept development: further development of chosen solution, while considering the feasibility, viability and desirability for both the residents and the municipality
- Concept evaluation: evaluation study of the final solution by means of a functional prototype, with residents of high-rise buildings; feedback of municipality
- Final reporting + poster: creation of conclusion and recommendations of the project, (finishing) documentation of the project in report and poster
- Graduation preparation: preparation of graduation presentation, logistics around graduation moment

Graduation Project results

1. Describe the expected results or outcome of your Graduation Project. For instance, a product, a product-service combination, a strategy illustrated through product or product-service combination ideas.
2. Indicate the expected scientific and/or societal and/or commercial significance of the outcome of your project.
3. In case of a Specialisation and/or Annotation, address specifically the relevant results to be expected.

1. The aim is to design a product (or product-service-system) to be used by residents of high-rise buildings to deal with their household waste in such a way that the fraction of residual waste is minimized, while taking their desired living culture into account.

2. The result of this graduation project will provide the municipality of Rotterdam with qualitative insights into the behaviour, barriers and motivations of residents of high-rise buildings, regarding household waste management. Next to that, it proposes a product solution tailored for high-rise residents, as starting point for further development, to help the municipality reach their circular ambitions. After this graduation project, this product can be further developed based on the provided recommendations, to make it ready for pilot testing. For high-rise residents in Rotterdam this project will result in a product proposition that supports their needs regarding waste separation at home, while maintaining or improving their context of living. When leaping forward to the implementation of the developed product, the benefit for the environment - facilitation of the reuse of material resources – becomes clear.

Deliverables

List the extra graduation deliverables, if any (apart from the mandatory deliverables being the thesis report, annexes if any, the poster and the representative pictures). For instance, a working prototype or a paper.

A functional prototype of the developed product solution.

Relation and relevance to the domain of Industrial Design Engineering, the chosen master direction and the IDE pillars

Explain the relation of your project with the domain of Industrial Design Engineering and your master direction IPD, DfI or SPD.

1. Relation of you project to the master IPD, DfI or SPD

Furthermore describe the interface of your project with each of the IDE pillars:

2. Business

3. Human Interaction

4. Technology

1. This graduation project will be carried out with a design research approach, in order to complement scientific and quantitative data with qualitative information. From the generated insights with users the step will be made towards solutions. A chosen product concept will be developed into a functional prototype, while keeping the context, users and other stakeholders into account. Recommendations will be provided for further development of the end result. The student will prove to be capable of managing a design project individually.

2. *Business*: this project will help the municipality of Rotterdam to create a better future city by supporting working towards their circular waste ambitions while maintaining or increasing the quality of life of her inhabitants. The qualitative insights from this project will increase the knowledge to facilitate easier decision making regarding (household waste related) municipal services, policies and campaigns.

3. *Human interaction*: this project is aimed at facilitating desired waste separation behaviour of high-rise residents, by taking into account their needs and desires. Based on qualitative insights the proposed product will be tailored to their level of motivation, knowledge, competence and physical characteristics (context and personal).

4. *Technology*: in the research phase current existing solutions, systems and technologies will be explored that are used to manage household waste. During concept creation, current and future technologies will be used to create solutions that match the world as it is today, and will be in the future.

Planning

Present your planning in a Gantt Chart, which can easily be made in Excel, see example underneath. Make sure a print in black and white is still readable. Mention the main phases of the project as described at Approach + number of weeks. Indicate only main activities, milestones, meetings. Take notice: 33 EC = 22 full-time weeks! Indicate periods of part-time graduation project activity and/or periods of not spending time on your graduation project, if any, for instance because of holidays⁷.

> See page 7

⁷ Only by approval of the Board of Examiners, a not yet passed course may be combined with the Graduation Project. In such case, show the approval to your Chair and indicate the period of not spending time on your Graduation Project for this reason.

IDE_Graduation_Assignment_Groot_Koerkamp_Iris_4223012_15-11-2018

		Parttime										Fulltime																						
Weeks	Calendar week	39	40	41	42	43	44	45	46	47	48	49	50	51	52	1	2	Weeks	3	4	5	6	7	8	9	10	11	12	13	14	15	16	17	18
	TU week	1.4	1.5	1.6	1.7	1.8	1.9	1.10	2.1	2.2	2.3	2.4	2.5	2.6	X	X	X		2.7	2.8	2.9	2.10	X	3.1	3.2	3.3	3.4	3.5	3.6	3.7	3.8	3.9	3.10	4.1
	Date	24/Sep	01/Oct	08/Oct	15/Oct	22/Oct	29/Oct	05/Nov	12/Nov	19/Nov	26/Nov	03/Dec	10/Dec	17/Dec	24/Dec	31/Dec	07/Jan	14/Jan	21/Jan	28/Jan	04/Feb	11/Feb	18/Feb	25/Feb	04/Mar	11/Mar	18/Mar	25/Mar	01/Apr	08/Apr	15/Apr	22/Apr	29/Apr	
	Project week	-	-	-	-	-	-	-	1	2	3	4	5	6	X	X	7	8	9	10	X	11	12	13	14	15	16	17	18	19	20	21	22	
	Holidays																			Break														
Milestones	Kick-off								Kick-off																									
	Green light																										Green							
	Graduation																																	Grad.
Deadlines	Supervisory team						Team																											
	Draft assignment							Draft																										
	Assignment									Assign.																								
	Draft report																																	
	Final report																																	
	Final poster																																	
	Presentation																																	
Meet	Inclusive City Hub			X					X	X		X	X				X																	
	Supervisory team								X!				X				X																X!	
Project phases	Assignment + team																																	
	Research																																	
	Design goal + vision																																	
	Ideation																																	
	Preliminary concept																																	
	Concept development																																	
	Final concept																																	
	Concept evaluation																																	
Final reporting + poster																																		
	Graduation preparation																																	

Brief explanatory remarks on the planning, if any.

Next to the three official meetings with the supervisory team (kick-off, greenlight and graduation), the student initiates to plan three more 'milestone meetings' with the supervisory team:

- Kick-off:** 15 November, 10:00-11:30 [Note: case-owner and coordinator invited]
Assignment, planning, approach
- Vision creation:** TBD (week of 10 Dec.)
Preliminary research outcomes, ideas for vision creation
- Vision + ideation phase:** TBD (week of 7 Jan.)
Created vision, planning and approach ideation phase
- Concept + concept development phase:** TBD (week of 18 Feb.)
Created solution, planning and approach for concept development phase
- Green-light meeting:** TBD (week of 18 Mar.) [Note: case-owner and coordinator invited]
General progress, final product, planning and approach for product evaluation
- Graduation:** TBD (week of 29 Apr.) [Note: case-owner and coordinator invited]
Final graduation presentation

IDE_Graduation_Assignment_Groot_Koerkamp_Iris_4223012_15-11-2018

Further comments and information

In case your Assignment needs further comments, please add any information you think is relevant.

Personal leaning ambitions:

- Gaining theoretical knowledge and practical experience with generative research methodologies, context mapping in specific

APPROVAL BY CHAIR

Date of approval	
Signature of Chair	

In general a high-rise building is a tall building, consisting of multiple storeys stacked upon each other. Various definitions exist for high-rise buildings, depending on the city and country, specified by either height in meters or storeys, the building's context, or its use.

In the Netherlands the term high-rise is used for buildings where an elevator is required, according to the Dutch building code. This applies to buildings of five storeys and higher. According to Buck Consultants International (2009) a building's height over 70m qualifies as high-rise. The study of Zandbelt&vandenBerg (2007) shows Tilburg, Delft, Utrecht, Den Haag and Rotterdam respectively use a height of 15m, 25m, 30m, 50m and 70m as lower limit to mark high-rise buildings.

According to Koek (2018) multiple Dutch high-rise visions name buildings high-rise, if they are at least three times as high as the average height of their surroundings. Two times the average height of the municipality's buildings qualifies, according to Zandbelt&vandenBerg (2007). Benchmark huishoudelijk afval (2017) defines high-rise buildings as residencies that are not "grondgebonden", meaning households without a private front door at street level.

According to Encyclopaedia Britannica (n.d.) and Designing Buildings Wiki (2018) a building high enough for residents to require a lift to reach their destination, is called high-rise. Craighead (2009) states buildings are high-rise when their height "can have a serious impact on evacuation" (p.1) or when it extends the reach of fire-fighting equipment. In contrast to the 70m lower limit, Buck Consultants International (2009) considers all high buildings in the Netherlands being high-rise, when counting the amount of households living in high-rise.

For this project high-rise buildings will be defined as "a set of stacked floors, with a minimum of five storeys in height, housing multiple households, without private front door at street level"

References

- Benchmark Huishoudelijk Afval (2017). *Handboek*. Retrieved November 20, 2018, from <https://www.bmha.nl/media/1205/bmha-handboek-april2017.pdf>
- Buck Consultants International (2009). *Wonen in hoogbouw*. Retrieved November 20, 2018, from <https://zoek.officielebekendmakingen.nl/blg-36643.pdf>
- Craighead, G. (2009). High-Rise Building Definition, Development, and Use. In *High-Rise Security and Fire Life Safety* (pp. 1-26). Butterworth-Heinemann.
- Designing Buildings Wiki (2018). *High-rise building*. Retrieved November 20, 2018, from https://www.designingbuildings.co.uk/wiki/High-rise_building
- Encyclopaedia Britannica (n.d.). *High-rise building*. Retrieved November 20, 2018, from <https://www.britannica.com/technology/high-rise-building>
- Koek, R. (2018). *Ingredienten voor rijke hoogbouw*. Retrieved November 20, from <https://rijnboutt.nl/articles/1219>
- Zandbelt&vandenBerg (2007). *Een studie naar de Nederlandse hoogbouwcultuur*. Retrieved November 20, 2018, from <https://www.stichtinghoogbouw.nl/publicaties/>

Figuur 2 Bevolkingspiramiden 2015 en 2035 Rotterdam (links) en Nederland (rechts)

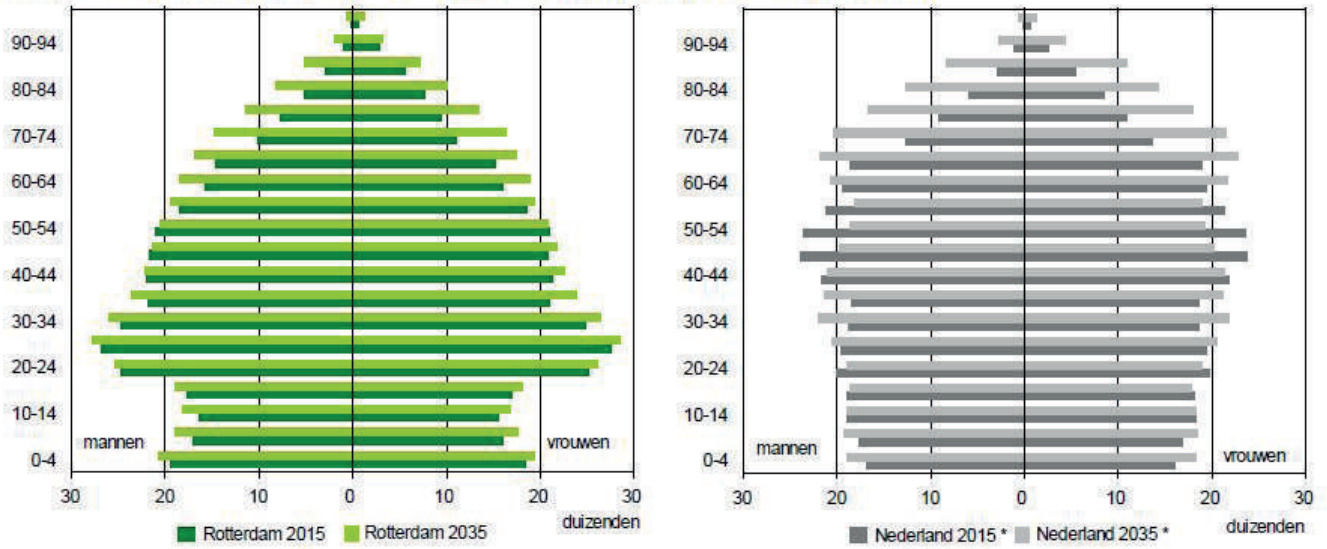

Bron: OBI

* Voor een goede vergelijking van de leeftijdsverdelingen is de bevolkingspiramide van Nederland (CBS 2014) per geslacht gewogen naar de totale geprognosticeerde bevolking per geslacht van Rotterdam.

FIGURE A.1 *The population pyramid of Rotterdam compared to the one of the Netherlands*

References

Gemeenteraad Rotterdam (2016). *Woonvisie Rotterdam*. Retrieved November 19, 2018, from <https://www.rotterdam.nl/wonen-leven/woonvisie/>

In 2017 a total of 415,6 kg household waste is generated per inhabitant of Rotterdam (CBS Statline, 2018). This adds up to a total over over 270 thousand tonne of household waste in Rotterdam in 2017 (N. van Barneveld, personal communication, October 12, 2018). 297,4 kg (71,6%) of this household waste per inhabitant is residual household waste (CBS Statline, 2018). This means only 28,4% of the household waste per inhabitant is separated into recyclable fractions (see Figure A.3).

Figure A.2 shows the average result of a waste sorting test carried out for the City of Rotterdam by De AfvalSpiegel (2018) in the spring of 2018. In this test, a sample of 250 kg of the fine residual waste was analysed for 13 neighbourhoods in Rotterdam.

Figure A.3 shows the potential of the different waste fractions in kg/person/year, when consumers optimally source separate their garbage. Source separation currently is far from optimal and does not reach its potential efficiency.

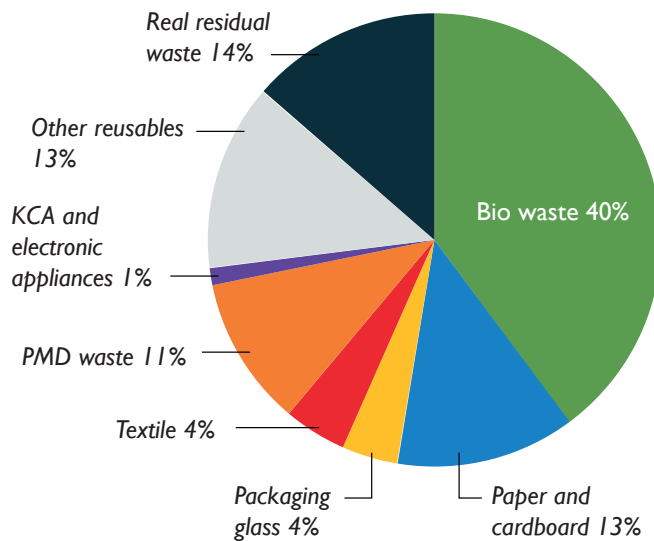

FIGURE A.2 Result in mass percentage of waste sorting of fine residual waste in Rotterdam (spring 2018) (De AfvalSpiegel, 2018, p. 4)

References

CBS Statline (2018). *Huishoudelijk afval per gemeente per inwoner*. Retrieved December 13, 2018, from <http://statline.cbs.nl/Statweb/publication/?DM=SLNL&PA=83452NED&DI=0&D2=a&D3=396&D4=a&HDR=T,G3&STB=G2,G1&VW=T>

De AfvalSpiegel (2018). *Sorteeranalyses fijn huishoudelijk restafval voorjaar 2018 Gemeente Rotterdam*. Tilburg: De AfvalSpiegel

FIGURE A.3 Potential mass of separated household waste when optimally separated into different fractions

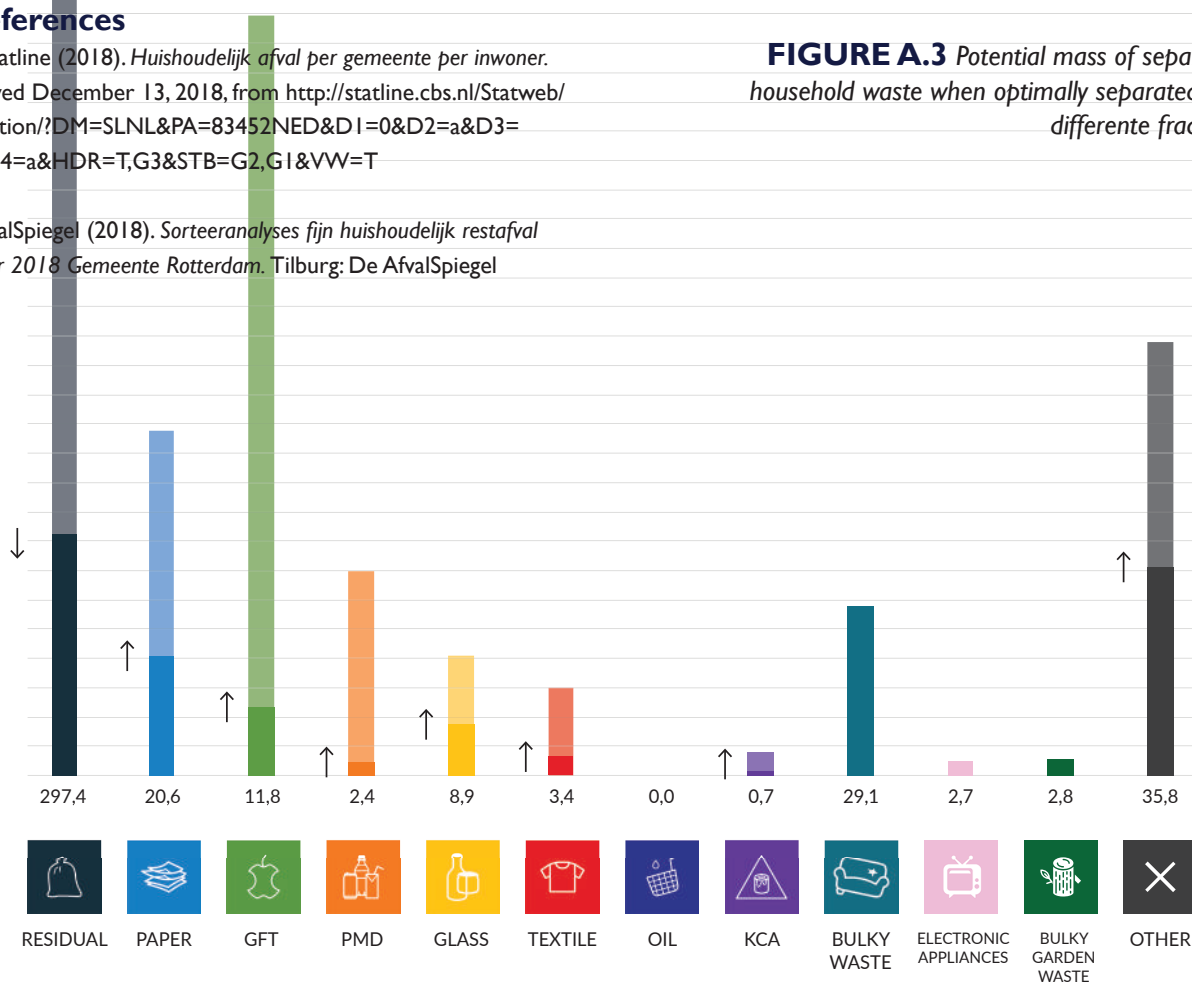

Household waste in Rotterdam in kg/inhabitant in 2017 (CBS Statline, 2017) with (in semi-transparent bars) the potential for separate fractions in kg/inhabitant, based on sorting analysis of spring 2018 (De AfvalSpiegel, 2018)

Currently the City of Rotterdam aims to collect several household waste fractions separately, namely glass, paper and cardboard, PMD, bio-waste, textile, deep-frying fat or oil, small chemical waste, bulky (garden) waste, electronic appliances and reusable goods. PMD stands for *Plastic verpakkingen, Metalen verpakkingen (blik) en Drinkpakken* - translated as plastic packaging, metal packaging (cans) and beverages cartons. All waste that is not collected separately is called residual household waste. Within the City of Rotterdam, the department of Urban Management is responsible for organizing the household waste collection system in the city. Every household in Rotterdam pays waste charges (*afvalstoffenheffing*) to cover for the waste collection and processing costs of the municipality (Rotterdam, n.d.a)

For each different waste fraction, a particular waste disposal channel is in place (see Figure A.4). This waste disposal channel may differ per neighbourhood in Rotterdam. The department of Urban Management distinguishes between three different systems:

1. The use of door-to-door mini containers for residual waste, paper and cardboard, and bio-waste in low-rise neighbourhoods;
2. Indoor waste rooms with common containers for residual waste, and paper and cardboard in high-rise buildings;
3. Underground or above-ground waste containers in public space for high-rise buildings without indoor waste room, for residual waste, paper and cardboard, PMD, glass and textile. These waste containers in public space also facilitate disposal of separated fractions for which users of system (1) and (2) miss separated containers

(D.F.A. van den Elzen, personal communication, November 16, 2018).

Milieuparken (Environmental parks) and *Piekfijn* second-hand shops facilitate separated disposal for waste fractions that lack dedicated (door-to-door, common or public) containers. Citizens can bring their deep-frying fat or oil, small chemical waste, bulky (garden) waste or electronic appliances to the environmental parks. For reusable bulky waste and electronic appliances, residents can contact the collection service of the *Piekfijn* second-hand shops.

Figure A.4 shows what happens to the different waste fractions after collection. The aim is to reuse as many products or parts as possible, to recycle materials that cannot be reused straight away and, finally, to

incinerate waste that cannot be recycled. With waste incineration energy from waste is recovered (electricity, steam, warmth). However, energy recovery is only a last resource. To recycle separated waste materials into new material is preferred.

References

Gemeente Rotterdam (n.d.a). *Ophaaldagen afval*. Retrieved November 7, 2018, from <https://www.rotterdam.nl/wonen-leven/ophaaldagen-afval/>

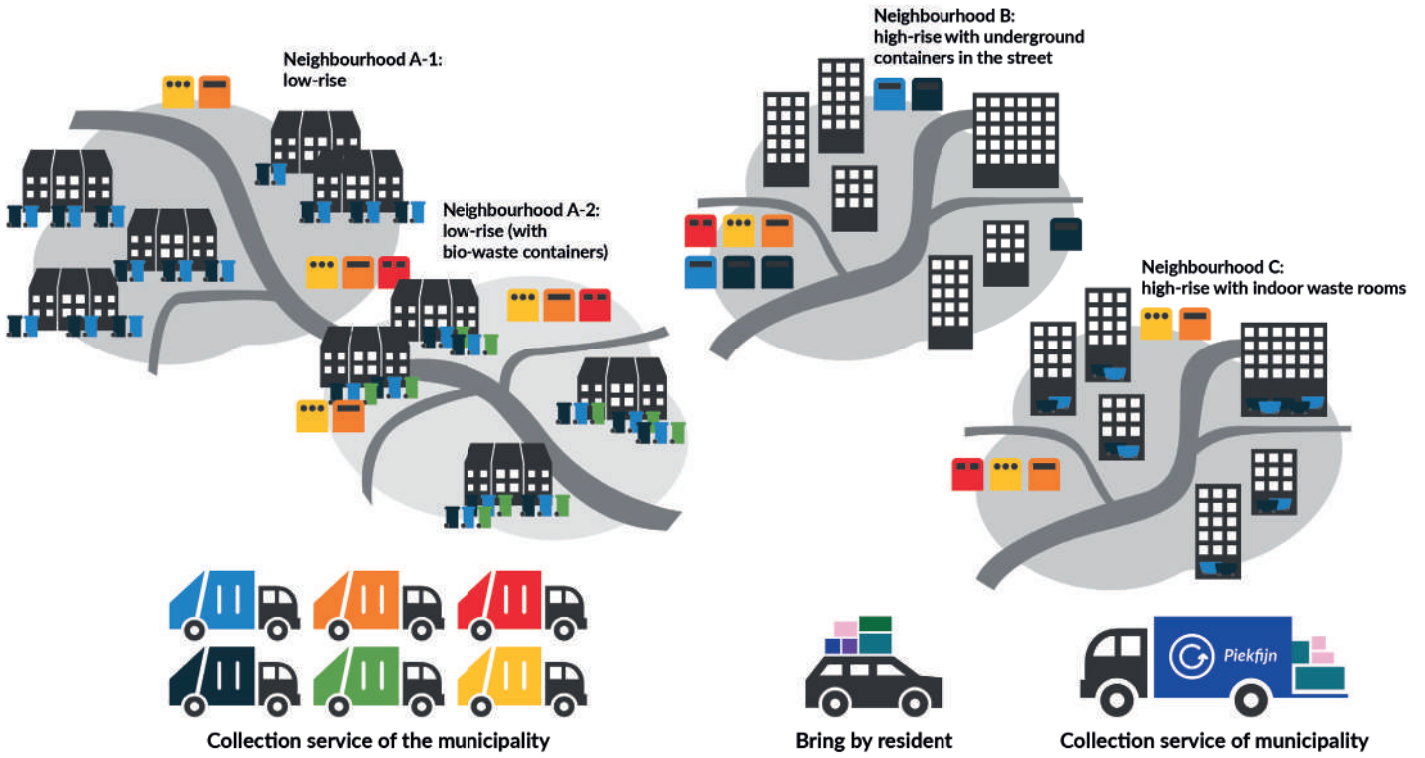

Processing of different waste fractions (Gemeente Rotterdam; AfvalWijzer)

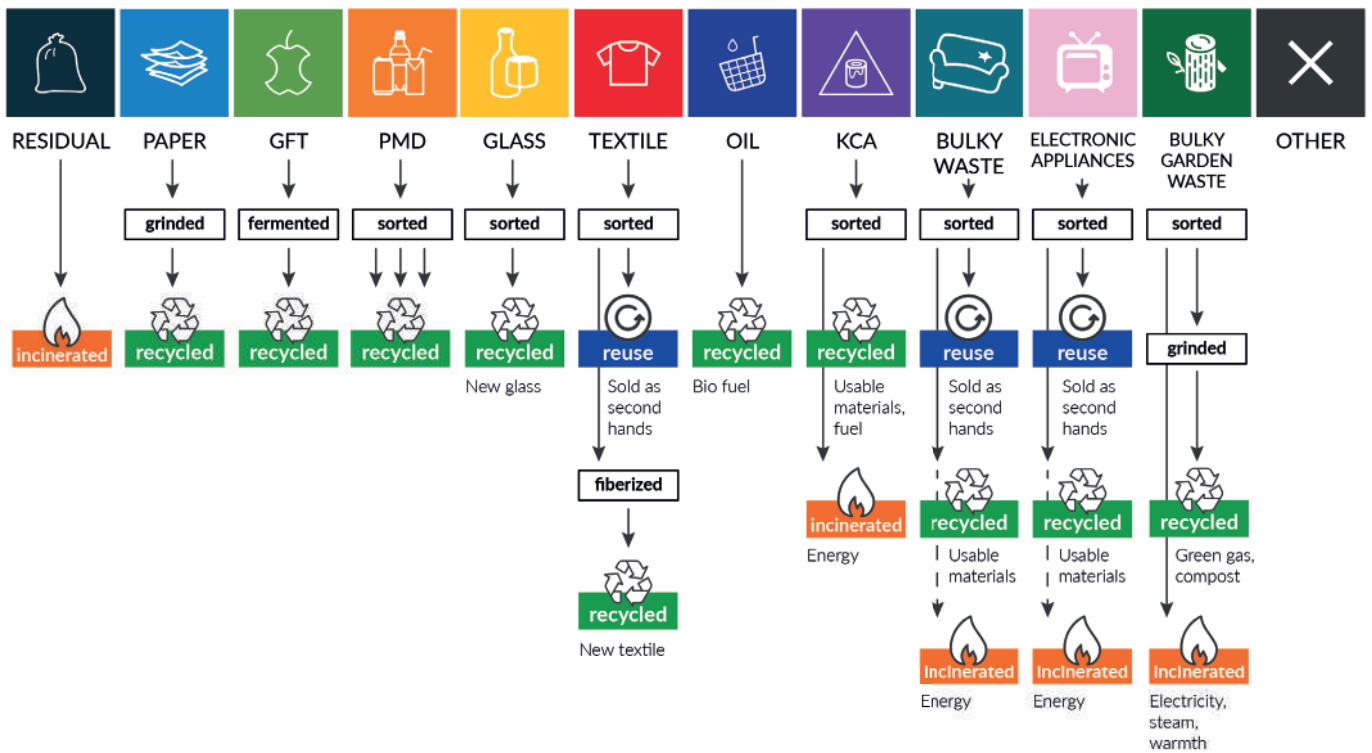

FIGURE A.4 Waste collection and processing for neighbourhoods in Rotterdam

Separate PMD collection ends in Rotterdam in summer 2019

The City of Rotterdam has decided to stop with separated waste collection of PMD, from the summer of 2019 on. The reason being, the current rate of so called separation at the source is too low for PMD, compared to the potential of mechanical post-consumer separation of PMD out of residual waste at waste plants.

Separation at the source means consumers separate their waste into recyclable fractions and residual waste, at home. Currently, only 3% of the households separate PMD. With post-consumer separation, 78% of the plastic can be retrieved from residual waste. Even when the source separation rate of PMD increases in the coming years, it is not to be expected this surpasses the efficiency of post-consumer separation (van den Elzen, personal communication, December 7, 2018).

References

AD (2019). *Plastic mag straks weer gewoon bij het restafval*. Retrieved March 18, 2019 from <https://www.ad.nl/rotterdam/plastic-mag-straks-weer-gewoon-bij-het-restafval~ae4ae118/>

FIGURE A.5 *Plastic waste can be disposed of with residual waste again from the summer of 2019*



▲ Een medewerker van Omrin in Friesland sorteert plastic op een van de lopende banden in het bedrijf. © Persbureau Noordooit, Heerenveen

Plastic mag straks weer gewoon bij het restafval

Steeds meer gemeenten rond Rotterdam stoppen met het apart inzamelen van plastic, metalen verpakkingen en drankkartons (pmd). Na Capelle aan den IJssel en Vlaardingen kunnen ook inwoners van Albrandswaard, Barendrecht en Ridderkerk vanaf volgend jaar het pmd weer [bij het restafval](#) gooien.

Folkert van der Krol 19-01-19, 08:31 Laatste update: 19:15

f 85 | t | e 52

In Rotterdam bouwt AVR aan een tweede installatie die pmd uit het restafval kan halen. Het gaat om een sorteerlijn die vanaf halverwege dit jaar dag en nacht draait en ongeveer 215 miljoen kilo restafval per jaar kan scheiden. Dat is het restafval van ongeveer een miljoen mensen. Het moet een enorme boost geven aan het scheiden van afval van Rotterdamse huishoudens.

Albrandswaard, Ridderkerk en Barendrecht stappen in 2020 over op een systeem van nascheiding, al moeten de gemeenteraden daar nog wel hun fiat aan geven. Niet de inwoners, maar een gespecialiseerd bedrijf haalt het pmd uit het restafval. Barendrecht, Albrandswaard en Ridderkerk, de 'BAR-gemeenten', hebben al een gezamenlijke aanbesteding gedaan. Ook steeds meer andere gemeenten overwegen namelijk nascheiding, terwijl het aantal bedrijven dat dit aanbiedt klein is. „Voor de marktpartijen geldt dat wie het eerst komt, het eerst maalt”, aldus het Ridderkerkse college van burgemeester en wethouders.

Geen speciale zakken

De voordelen van nascheiding, die alleen geldt voor pmd en niet voor oud papier, gft, glas en textiel, zijn Frieslandvolgens de BAR-gemeenten groot. Inwoners hoeven geen speciale zakken of containers meer te vullen, het vergroot het gemak voor de inwoners en machines scheiden het pmd veel beter dan inwoners dat doen en het zou ook voordeliger zijn. In zakken en containers voor pmd komt vaak ook afval terecht dat daarin niet thuishoort, zoals piepschuim en chipszakken.

In Capelle aan den IJssel mag het pmd sinds vorig jaar al bij het restafval. Afvalverwerker Irado weet er wel raad mee, ook al moet al het afval eerst naar de fabriek van Omrin in Friesland worden vervoerd om te worden verwerkt. Zelfs het restafval dat overblijft, krijgt nog een nieuwe bestemming. Het wordt omgezet in biogas. „We hebben al auto's die op dit gas rijden. In de toekomst geldt dit voor al onze wagens. Dan hebben we een volledig gesloten kringloop”, zegt directeur André Hertog van Irado.

Separation of household waste has environmental and economic benefits. Independent research and consultancy company CE Delft made a Social Cost-Benefit Analysis for the separation of household waste (Warringa, De Bruyn & Bijleveld, 2013). The table in Figure A.6 shows a positive balance for waste separation. The environmental benefits together with the decrease of waste processing costs (see Figure A.7) outweigh the increased costs for collection and sorting (see Figure A.8).

In Figure A.7 can be seen that the processing costs of paper and cardboard; and textile are negative. This is a result of their positive economic value: separated paper and cardboard; and textile can be sold to processing companies. Processing of glass, plastic and bio-waste costs money. However, the rate is lower than for the processing of residual waste.

The concept of 'Afval Loont' (translated as "Waste Pays") passes on these economical benefits to citizens who

separate their household waste. Citizens receive 3 Euro cents for a kilo paper, 13 Euro cents for a kilo PMD, 10 Euro cents for a kilo textile, 5 Euro cents for small electric appliances, 10 Euro cents for a kilo (deep-frying) oil and 5 Euro cents for a kilo of metal (Afval Loont, n.d.). Managing director of Afval Loont Jørgen van Rijn explains he receives 40 Euro cents for a kilo plastic and 9 Euro cents for a kilo small electric appliances when he sells it. Next to that, he invoices municipalities for their avoided processing costs (Trouw, 2014).

The economical benefits are mainly visible at large scale. Metal is worth between 12 and 25 Euro cents per kilo. With an average of 15 kilo per household per year, this results in a gain of 2 to 4 Euros per household per year. Paper can be sold for 7 Euro cents per kilo. With an average of 125 kilo of paper per household per year a gain of almost 9 Euros per household can be reached (Appartement & Eigenaar, 2018).

References

- Afval Loont (n.d.). *Hoe werkt het?* Retrieved April 10, 2019 from <https://www.afvalloont.nl/hoe-werkt-het/>
- Appartement & Eigenaar (2018). *Jouw afval is geld waard.* Retrieved April 10, 2019 from <https://www.appartementeneigenaar.nl/beheer-bestuur/collectief/jouw-afval-is-geld-waard>
- Trouw (2014). *Afval inleveren is geld verdienen.* Retrieved April 10, 2019 from <https://www.trouw.nl/home/afval-inleveren-is-geld-verdienen~afb6ade7/>
- Warringa, G.E.A., De Bruyn, S.M. & Bijleveld, M.M. (2013). *Inzetten op meer recycling Een maatschappelijke kosten-batenanalyse.* Delft: CE Delft

MKBA-resultaat (ncw, € mln)

Kosten	
Extra kosten inzameling en sortering	4.828
Extra inkomsten inkoop importafval AVI	47
Inspanning burger	PM-
Beleidskosten	PM-
Totaal	4.875
Baten	
Daling verwerkingskosten	2.795
Werkgelegenheid	54
Milieuwinst	4.118
Hogere winstgevendheid recyclingsector en sorteerbeidrijven	264
Minder grondstofafhankelijkheid	PM+
Innovatie	PM+
Totaal	7.231
Saldo	2.356

Figure A.6 Result of the Social Cost-Benefit Analysis of household waste separation (Source: Warringa, De Bruyn & Bijleveld, 2013)

Kostenverschil verwerken afvalrecycling en -verbranding

	Verwerkingskosten (€/ton)	Meerkosten verwerking (€/ton)	Toename Recycling (kton)	Opbrengsten jaarlijks (€ mln)
Restafval	95			
Oud papier & karton	-73	-169	250	42
Glasverpakkingen	1	-94	46	4
Textiel	-232	-327	42	14
Kunststof	0	-95	314	30
GFT-afval	46	-49	572	28
Drankenkartons	0	-95	20	2
Dakafval	107	12	33	-0,4
Totaal	0		1.277	120

Bron: Noordhoek, 2012; NVRD, 2012; KplusV, 2011; FFact, 2010, enquêtes in het kader van dit onderzoek.

Figure A.7 Saving in processing cost by separation of household waste (Source: Warringa, De Bruyn & Bijleveld, 2013)

Meerkosten inzameling Recycling+ scenario

	Gemiddelde kosten inzameling (€/ton)	Meerkosten inzameling (€/ton)	Toename Recycling + (Kton)	Meerkosten jaarlijks (€ mln)
Restafval bronscheiding	53			
Oud papier & karton bronscheiding	56	3	250	1
Glasverpakkingen bronscheiding	40	-13	46	-1
Textiel bronscheiding	124	71	42	3
Kunststof bronscheiding	632	579	248	144
Kunststof nascheiding	684	631	66	41
GFT-afval bronscheiding	74	21	572	12
Drankenkartons	400	347	20	7
Dakafval		0	33	0
Totaal			1.277	207

Bronnen: NVRD, 2012; FFact, 2010; PWC, 2012; PWC, 2012; KplusV, 2011.

Figure A.8 Additional collection costs for separated household waste (Source: Warringa, De Bruyn & Bijleveld, 2013)

Interview set-up Hoogbouwbewoners Rotterdam (November 2018)

Research questions:

- *What characterises high-rise living (culture)?*
- *What are the main barriers for waste separation at household level, in high-rise buildings?*

START

- Mag ik een geluidsopname maken voor onderzoeksdoeleinden?

INTRO

1. Kan je wat over jezelf vertellen? (*werk, leeftijd*)
2. Kan je iets vertellen over je woonsituatie? (*met wie, hoe lang woon je hier al, met welke reden hierheen verhuist, hoe lang al in Rotterdam, hoe lang al in hoogbouw, hoe hoog*)

HOOGBOUW

3. Wat is de reden dat je voor hoogbouw hebt gekozen?
4. Hoe is het leven in hoogbouw?
 - a. Wat bevalt je aan wonen in hoogbouw?
 - b. Wat bevalt je niet aan wonen in hoogbouw?
 - c. Welke verschillen ervaar je met leven in laagbouw? (*indien eerder in laagbouw gewoond*)
5. Hoe is de sociale interactie in het gebouw?
6. Hoe lang verwacht je hier te blijven wonen?

AFVAL

7. Kan je wat vertellen over hoe je met huishoudelijk afval omgaat? (*wat scheid je, waar en hoe sla je het op, waar breng je het heen, hoe vaak, hoe breng je het er heen, wie is verantwoordelijk, gewoontes*)
8. Wat weet je over afval scheiden? (*welke fracties zijn er, waarom is het belangrijk, doel, hoe faciliteert de gemeente het*)
9. Waarom scheid je afval? (*voor fracties die gescheiden worden*)
 - a. Wat belemmert je bij het scheiden van afval?
10. Waarom scheid je geen afval? (*voor fracties die nog niet gescheiden worden*)
 - a. Wat zouden redenen zijn om dit wel te scheiden?
11. Wat zou afval scheiden voor jou gemakkelijker maken?

EIND

- Zijn er nog dingen die je kwijt wil of aan dit gesprek wil toevoegen?
- Ben je bereidt om later in mijn project nogmaals mee te werken? (*workshop, ideegeneratie, concept evaluatie*)
- Zou ik foto's mogen maken van je huishoudelijk afval in huis?

6

Residual waste,
paper, glass, batteries

2

6

Residual waste,
paper, glass, batteries

2

6

Residual waste,
paper, glass, batteries

2

6

Residual waste,
paper, glass, batteries

2

7

Residual waste,
paper, glass, PMD

7

7

Residual waste,
paper, glass, PMD

7

7

Residual waste,
paper, glass, PMD

7

7

Residual waste,
paper, glass, PMD

7

7

Residual waste,
paper, glass, PMD

7

8

Residual waste,
paper, glass, PD

8

8

Residual waste,
paper, glass, PD

8

8

Residual waste,
paper, glass, PD

8

8

Residual waste,
paper, glass, PD

8

8

Residual waste,
paper, glass, PD

8



14

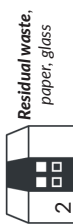

Residual waste,
paper, glass



14



Residual waste,
paper, glass



14



Residual waste,
paper, glass



15



Residual waste,
paper, glass



15



Residual waste,
paper, glass



15



Residual waste,
paper, glass



16



Residual waste,
paper, glass



16

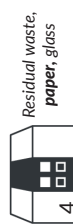

Residual waste,
paper, glass



16



Residual waste,
paper, glass



16



Residual waste,
paper, glass



16



Residual waste,
paper, glass



17



Residual waste,
paper, glass



17



Residual waste,
paper, glass



17



Residual waste,
paper, glass

18 Madrid



Residual waste, glass



18 Madrid



Residual waste, glass



19



Residual waste, paper, glass, plastic bottles



19



Residual waste, paper, glass, plastic bottles



20 Loughborough



Residual waste, glass, mixed recycling, food waste



20 Loughborough



Residual waste, glass, mixed recycling, food waste



20 Loughborough



Residual waste, glass, mixed recycling, food waste



22



Residual waste, paper, glass, GFT



22



Residual waste, paper, glass, GFT



22



Residual waste, paper, glass, GFT



23



Residual waste, paper, glass



23



Residual waste, paper, glass



23



Residual waste, paper, glass



23



Residual waste, paper, glass



23

Residual waste,
paper, glass

5

24

Residual waste,
paper, glass,
GF, plastic

2

24

Residual waste,
paper, glass,
GF, plastic

2

24

Residual waste,
paper, glass,
GF, plastic

2

25

Residual waste,
paper, glass,
PM

5

25

Residual waste,
paper, glass,
PM

5

25

Residual waste,
paper, glass,
PM

5

25

Residual waste,
paper, glass,
PM

5

26 Florence

Residual waste,
paper,
glass/plastic,
bio-waste

3

26 Florence

Residual waste,
paper,
glass/plastic,
bio-waste

3

27

Residual waste,
paper, glass

5

27

Residual waste,
paper, glass

5

27

Residual waste,
paper, glass

5

28

Residual waste,
paper, glass, PMD,
bio-waste

22

28

Residual waste,
paper, glass, PMD,
bio-waste

22

28

Residual waste,
paper, glass, PMD,
bio-waste

22

29

Residual waste,
paper, glass,
plastic,
plastic bottles

4

29

Residual waste,
paper, glass,
plastic,
plastic bottles

4

29

Residual waste,
paper, glass,
plastic,
plastic bottles

4

30

Residual waste,
paper, glass

3

30

Residual waste,
paper, glass

3

30

Residual waste,
paper, glass

3

31

Residual waste,
paper, glass, PMD,
bio-waste+garden

2

31

Residual waste,
paper, glass, PMD,
bio-waste+garden

2

31

Residual waste,
paper, glass, PMD,
bio-waste+garden

2

31

Residual waste,
paper, glass, PMD,
bio-waste+garden

2

32

Residual waste,
paper, plastic, textile,
bio-waste

2

32

Residual waste,
paper, plastic, textile,
bio-waste

2



32



Residual waste,
paper, plastic, textile,
bio-waste



32



Residual waste,
paper, plastic, textile,
bio-waste



32



Residual waste,
paper, plastic, textile,
bio-waste



32



Residual waste,
paper, plastic, textile,
bio-waste



33



Residual waste,
paper, glass, PMD,
bio-waste+garden,
books/textile/etc.



33



Residual waste,
paper, glass, PMD,
bio-waste+garden,
books/textile/etc.



33



Residual waste,
paper, glass, PMD,
bio-waste+garden,
books/textile/etc.



34



Residual waste,
paper, glass, PMD,
bio-waste+garden,
batteries, textile



34



Residual waste,
paper, glass, PMD,
bio-waste+garden,
batteries, textile



34



Residual waste,
paper, glass, PMD,
bio-waste+garden,
batteries, textile



34



Residual waste,
paper, glass, PMD,
bio-waste+garden,
batteries, textile



34



Residual waste,
paper, glass, PMD,
bio-waste+garden,
batteries, textile



34



Residual waste,
paper, glass, PMD,
bio-waste+garden,
batteries, textile



34



Residual waste,
paper, glass, PMD,
bio-waste+garden,
batteries, textile

39 **Gothenburg**



Residual waste,
paper, glass, **PMD**,
bio-waste, plastic
bottles



39 **Gothenburg**



Residual waste,
paper, glass, **PMD**,
waste, plastic bottles



40



Residual waste,
paper, glass, plastic,
bio-waste, **cartridges**,
iron, old appliances,
textile, medicine



40



Residual waste,
paper, glass, plastic,
bio-waste, **cartridges**,
iron, old appliances,
textile, medicine



40



Residual waste,
paper, glass, plastic,
bio-waste, **cartridges**,
iron, old appliances,
textile, medicine



40



Residual waste,
paper, glass, plastic,
bio-waste, **cartridges**,
iron, old appliances,
textile, medicine



40



Residual waste,
paper, glass, plastic,
bio-waste, **cartridges**,
iron, old appliances,
textile, medicine



38



Residual waste,
paper, glass, **PMD**,
bio-waste, plastic
bottles, textile,
batteries



38



Residual waste,
paper, glass, **PMD**,
bio-waste, plastic
bottles, textile,
batteries



38



Residual waste,
paper, **glass**, **PMD**,
bio-waste, plastic
bottles, textile,
batteries



38



Residual waste,
paper, glass, **PMD**,
bio-waste, plastic
bottles, **textile**,
batteries



38



Residual waste,
paper, glass, **PMD**,
bio-waste, plastic
bottles, textile,
batteries



38



Residual waste,
paper, glass, **PMD**,
bio-waste, plastic
bottles, textile,
batteries



39 **Gothenburg**



Residual waste,
paper, glass, **bio**-
waste, plastic bottles



40



Residual waste,
paper, glass, plastic,
bio-waste, cartridges,
iron, old appliances,
textile, medicine

2

40



Residual waste,
paper, glass, plastic,
bio-waste, cartridges,
iron, old appliances,
textile, medicine

2

40



Residual waste,
paper, **glass**, plastic,
bio-waste, cartridges,
iron, old appliances,
textile, medicine

2

40



Residual waste,
paper, glass, plastic,
bio-waste, cartridges,
iron, old appliances,
textile, medicine

2

40



Residual waste,
paper, **glass**, plastic,
bio-waste, cartridges,
iron, old appliances,
textile, medicine

2

40



Residual waste,
paper, glass, plastic,
bio-waste, cartridges,
iron, old appliances,
textile, **medicine**

2

40



Residual waste,
paper, **glass**, plastic,
bio-waste, cartridges,
iron, old appliances,
textile, medicine

2

40



Residual waste,
paper, glass, plastic,
bio-waste, cartridges,
iron, old appliances,
textile, medicine

2

40



Residual waste,
paper, **glass**, plastic,
bio-waste, cartridges,
iron, old appliances,
textile, medicine

2

40



Residual waste,
paper, glass, plastic,
bio-waste, cartridges,
iron, old appliances,
textile, medicine

2

40



Residual waste,
paper, glass, plastic,
bio-waste, cartridges,
iron, old appliances,
textile, medicine

2

40



Residual waste,
paper, **glass**, plastic,
bio-waste, cartridges,
iron, old appliances,
textile, medicine

2

40



Residual waste,
paper, **glass**, plastic,
bio-waste, cartridges,
iron, old appliances,
textile, medicine

2

40



Residual waste,
paper, glass, plastic,
bio-waste, cartridges,
iron, old appliances,
textile, medicine

2



40

Residual waste,
paper, glass, plastic,
bio-waste, cartridges,
iron, old appliances,
textile, medicine



40

Residual waste,
paper, glass, plastic,
bio-waste, cartridges,
iron, old appliances,
textile, medicine

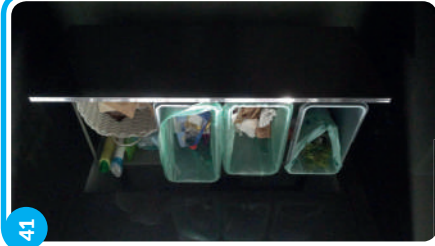

41

Residual waste,
paper, plastic,
GFT



42

Residual waste,
paper, glass, plastic
bottles



42

Residual waste,
paper, glass, plastic
bottles



42

Residual waste,
paper, glass, plastic
bottles



42

Residual waste,
paper, glass, plastic
bottles



43

Residual waste,
paper, glass, PMD,
bio-waste



43

Residual waste,
paper, glass, PMD,
bio-waste



43

Residual waste,
paper, glass, PMD,
bio-waste



43

Residual waste,
paper, glass, PMD,
bio-waste



43

Residual waste,
paper, glass, PMD,
bio-waste



43

Residual waste,
paper, glass, PMD,
bio-waste



44

Residual waste,
paper, glass,
plastic
bottles, bio-waste



44

Residual waste,
paper, glass,
plastic, plastic
bottles, **bio-waste**

44

Residual waste,
paper, glass,
plastic, plastic
bottles, **bio-waste**

44

Residual waste,
paper, glass,
plastic, plastic
bottles, **bio-waste**

45

Residual waste,
paper, glass, PMD,
bio-waste, oil,
corks

45

Residual waste,
paper, glass, PMD,
bio-waste, oil,
corks

45

Residual waste,
paper, glass, PMD,
bio-waste, oil,
corks

45

Residual waste,
paper, glass, PMD,
bio-waste, oil,
corks

45

Residual waste,
paper, glass, PMD,
bio-waste, oil,
corks

45

Residual waste,
paper, glass, **PMD**,
bio-waste, oil,
corks

45

Residual waste,
paper, glass, PMD,
bio-waste, oil,
corks

45

Residual waste,
paper, glass, PMD,
bio-waste, oil,
corks

45

Residual waste,
paper, glass, PMD,
bio-waste, oil,
corks

5

Residual waste,
paper, glass, **PV**,
bio-waste

6

Residual waste,
paper, glass, **PM**,
bio-waste

46

Residual waste,
paper, glass, PM,
bio-waste

46

Residual waste,
paper, glass, PM,
bio-waste

46

Residual waste,
paper, glass, PM,
bio-waste

47 Amman

Residual waste

48

Residual waste,
paper, glass, PMD,
bio-waste

48

Residual waste,
paper, glass, PMD,
bio-waste

48

Residual waste,
paper, glass, PMD,
bio-waste

49

Residual waste,
paper, glass, PMD,
bio-waste

49

Residual waste,
paper, glass, PMD,
bio-waste

49

Residual waste,
paper, glass, PMD,
bio-waste

50

Residual waste,
paper, glass

50

Residual waste,
paper, glass

21

Residual waste,
paper, glass, PM,
bio-waste+garden,
chemical waste,
bulky waste, recycle
shop, textile

21

Residual waste,
paper, glass, PM,
bio-waste+garden,
chemical waste,
bulky waste, textile
recycle shop, textile



21

Residual waste, paper, glass, PM, bio-waste-garden, chemical waste, bulky waste, recycle shop, textile



21

Residual waste, paper, glass, PM, bio-waste-garden, chemical waste, bulky waste, recycle shop, textile



21

Residual waste, paper, glass, PM, bio-waste-garden, chemical waste, bulky waste, recycle shop, textile



51

Residual waste, paper, PM, bio-waste



51

Residual waste, paper, PM, bio-waste



51

Residual waste, paper, PM, bio-waste



52

Residual waste, paper, glass, plastic, bio-waste



52

Residual waste, paper, glass, plastic, bio-waste



52

Residual waste, paper, glass, plastic, bio-waste



52

Residual waste, paper, glass, plastic, bio-waste



52

Residual waste, paper, glass, plastic, bio-waste



52

Residual waste, paper, glass, plastic, bio-waste



52

Residual waste, paper, glass, plastic, bio-waste



52

Residual waste, paper, glass, plastic, bio-waste



Workshop goal

The goal of the workshop is to reveal the unconscious needs and thoughts of high-rise residents in Rotterdam, regarding their household waste management.

Participants

During this workshop, seven high-rise residents of Rotterdam were present.

Preparation to the workshop

In the week previous to the workshop, the high-rise residents were asked to fill in a workbook with five small exercises at home, in order to sensitise their mind regarding the topic of household waste management.

One workbook filled by one of the workshop participants is presented to illustrate the qualitative results gathered from the workbooks (see page 36-38).

Workshop outline

The workshop itself consisted of four parts. In the first part, the participants introduced themselves and explained one of the exercises they filled out. In the second part, the participants were asked to individually map their feelings regarding their current in-home waste practise with PrEmo stickers (Laurans & Desmet, 2017), followed by repeating this exercise for the situation where they would have to separate all their waste. In the third part, the group was asked to jointly sort possible (existing) interventions (see Appendix K, Figures A.9-A.29), according to what would help them the most to separate their household waste. In the last part, the participants were asked to draw their ideal situation for waste separation, while offering them visual triggers in the form of stickers.

For each worksheet one sheet filled by one of the workshop participants is presented to illustrate the workshop outcomes (see page 39-42).



References

Laurans, G. & Desmet, P.M.A. (2017). Developing 14 animated characters for non-verbal self-report of categorical emotions. *Journal of Design Research*, 15(3/4), 214–233.

HALLO!

Leuk dat je mee werkt aan mijn afstudeeronderzoek. In dit boekje vind je vijf opdrachten die je thuis kunt invullen, als voorbereiding voor de workshop. Door deze opdrachten kijk je al eens een keer naar je eigen huishoudelijke afval: wat je ermee doet, hoe je het organiseert, hoe het eruit ziet, hoe het voor jou wordt georganiseerd en hoe je erover denkt.

MaaK vanaf nu elke dag één opdracht uit dit boekje. Dit duurt maximaal 10 minuten. Zo heb je alle opdrachten gedaan vóór de workshop.

De workshop vindt plaats op dinsdag 18 december 2018, van 19.30 tot 21 uur, in het Groothandelsgebouw, Unit A1.196, Rotterdam.

Tot dan!
Iris

vul hier in wie jij bent!

DIT BEN IK

Naam: Paul
Leeftijd: 32

Ik woon op 14 hoog, in een gebouw van 18 verdiepingen in de wijk Centrum in Rotterdam.

Ik woon samen met Stefanie



maak hier een tekening van jezelf!

DIT IS ZOALS IK HET DOE

Datum: 12-12-18

Opdracht 1: Trek lijntjes tussen de verschillende afvalproducten en de prullenbak waarin jij ze nu thuis weggooit.

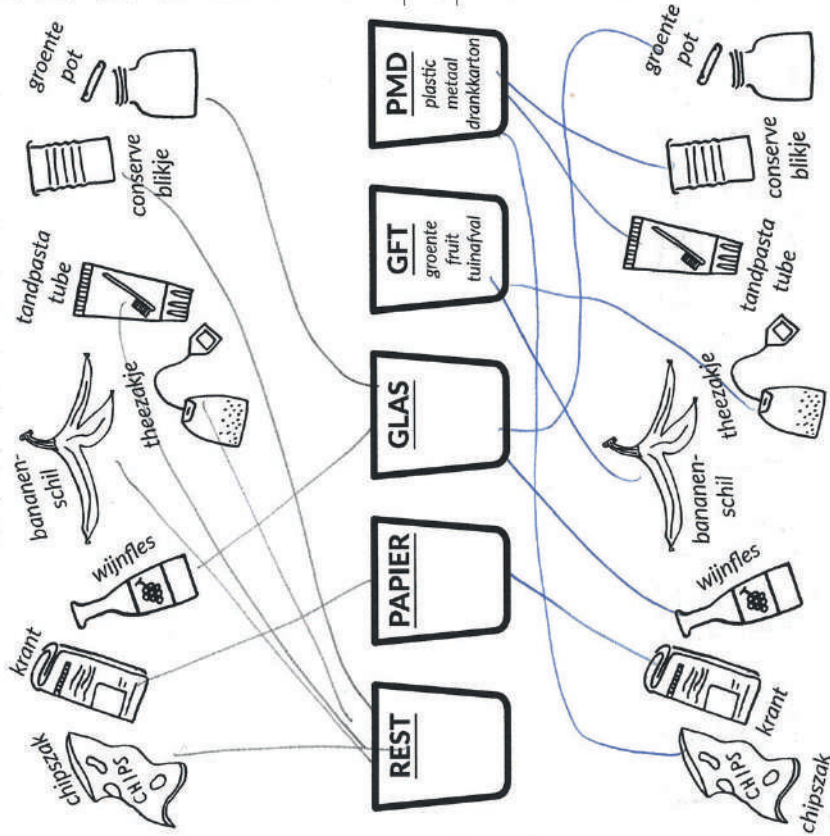

Opdracht 2: Trek nu met een andere kleur lijntjes tussen de verschillende afvalproducten en de prullenbak waarin jij het zou gooien, als je afval helemaal wilt scheiden.

DIT IS ZOALS IK HET ORGANISEER

Datum: 13-12-18

Teken in de ruimte hieronder een plattegrond van je keuken (of een groter gedeelte van je huis). Teken daar met een andere kleur in waar jij welk afval bewaart.

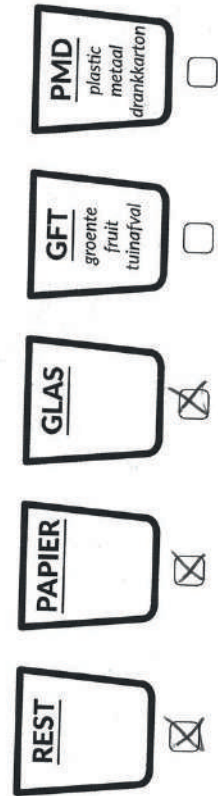
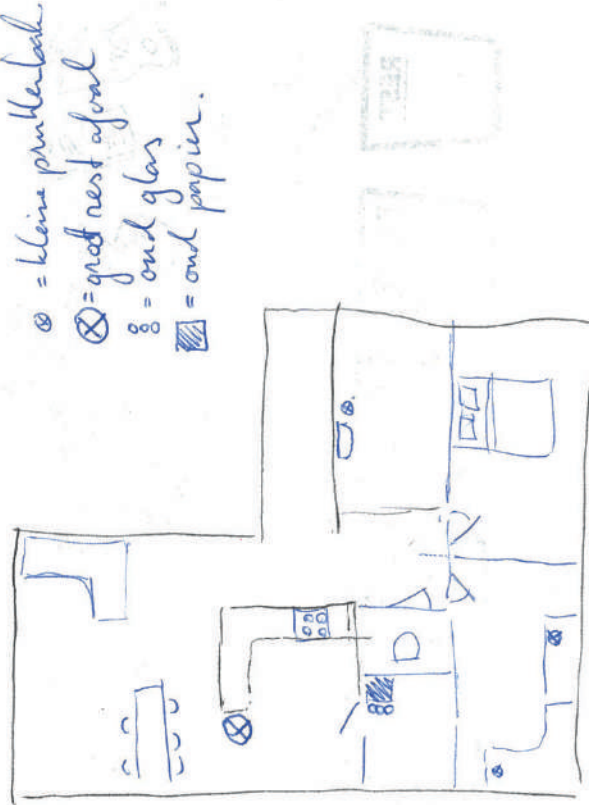

kruis hier aan wat jij thuis apart verzamelt

3

DIT IS ZOALS HET ERUIT ZIET

Datum: 19-12-18

Teken in het vak hoe je restafval prullenbak eruit ziet. Vul naast het vak je antwoorden op de gestelde vragen in.

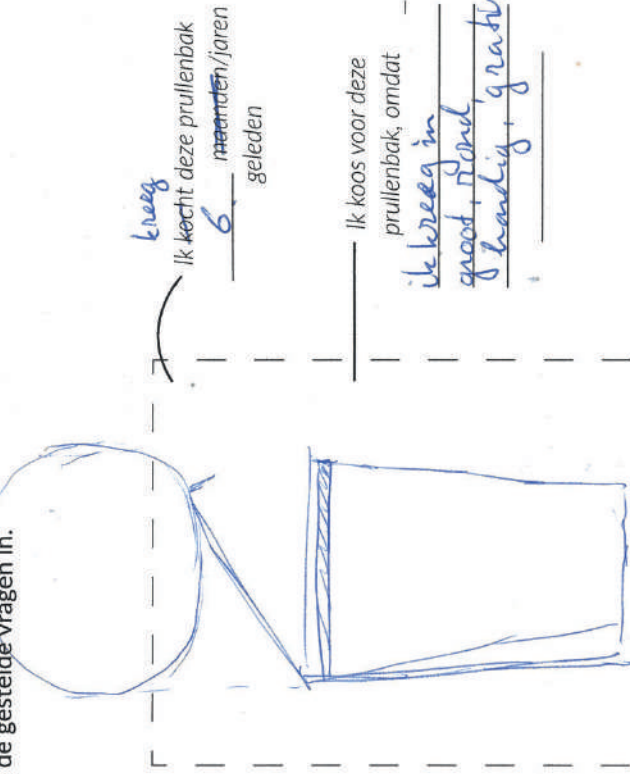

Ik kreeg deze prullenbak _____
 Ik koos voor deze prullenbak, omdat ik kreeg in groot rond handig, gratis!

_____ maanden/jaren geleden

Dit zijn de positieve punten aan mijn prullenbak:

- + groot
- + rond
- + past makkelijk in vuilniszak in De vuilniszak komt goed vol!

Dit zijn de negatieve punten aan mijn prullenbak:

- goedkoop
- plastic
- moet schoon gemaakt worden.

4

DIT IS ZOALS IK HET VOOR MIJ GEORGANISEERD WORDT

lijft ex. huis - huifp

Datum: 17-12-12

Teken in de ruimte hieronder een huis. Teken de plattegrond van je straat of een deel van je wijk. Teken daar met een andere kleur de containers in waar jij je afval weg gooit. Pak een derde kleur om de route te tekenen die jij aflegt van je huis naar de afvalcontainer.

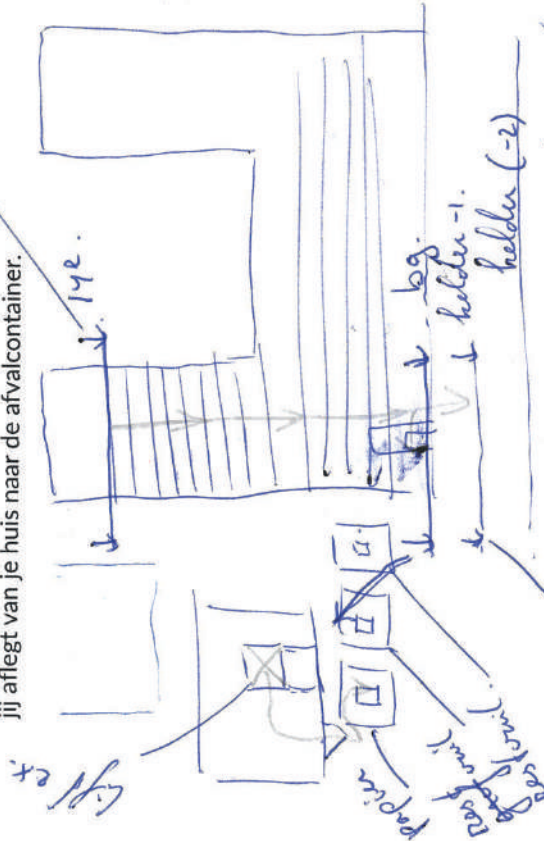

glas containers staan niet op de kaart. looproute per potlood aangegeven.

Kun je per route aangeven hoeveel minuten of meter je ongeveer onderweg bent?

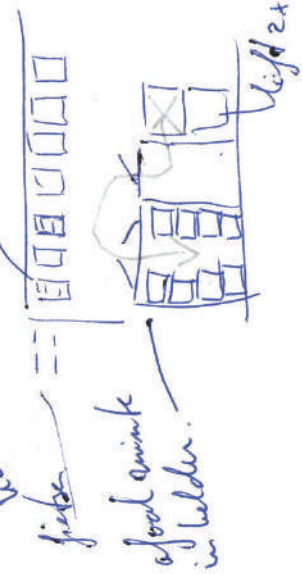

5

DIT IS ZOALS IK EROVER DENK

Datum: 17-12-12

Vul in de gedachtenwerkjes in wat jij denkt over "huishoudelijk afval in jouw flat" en hoe jij denkt over "afval scheiden".

Huishoudelijk afval in mijn flat

Afval scheiden

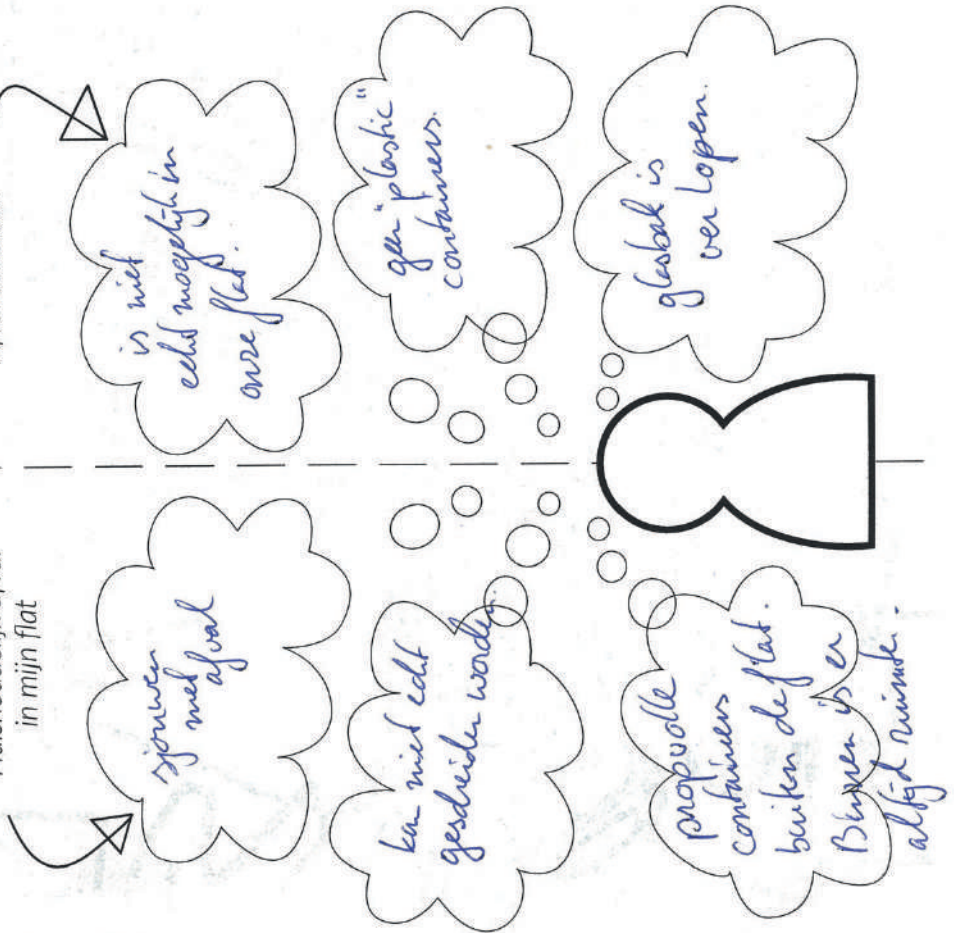

HOE VOEL JIJ JE BIJ JOUW HUIDIGE HUISHOUDELIJK AFVALPROCES?

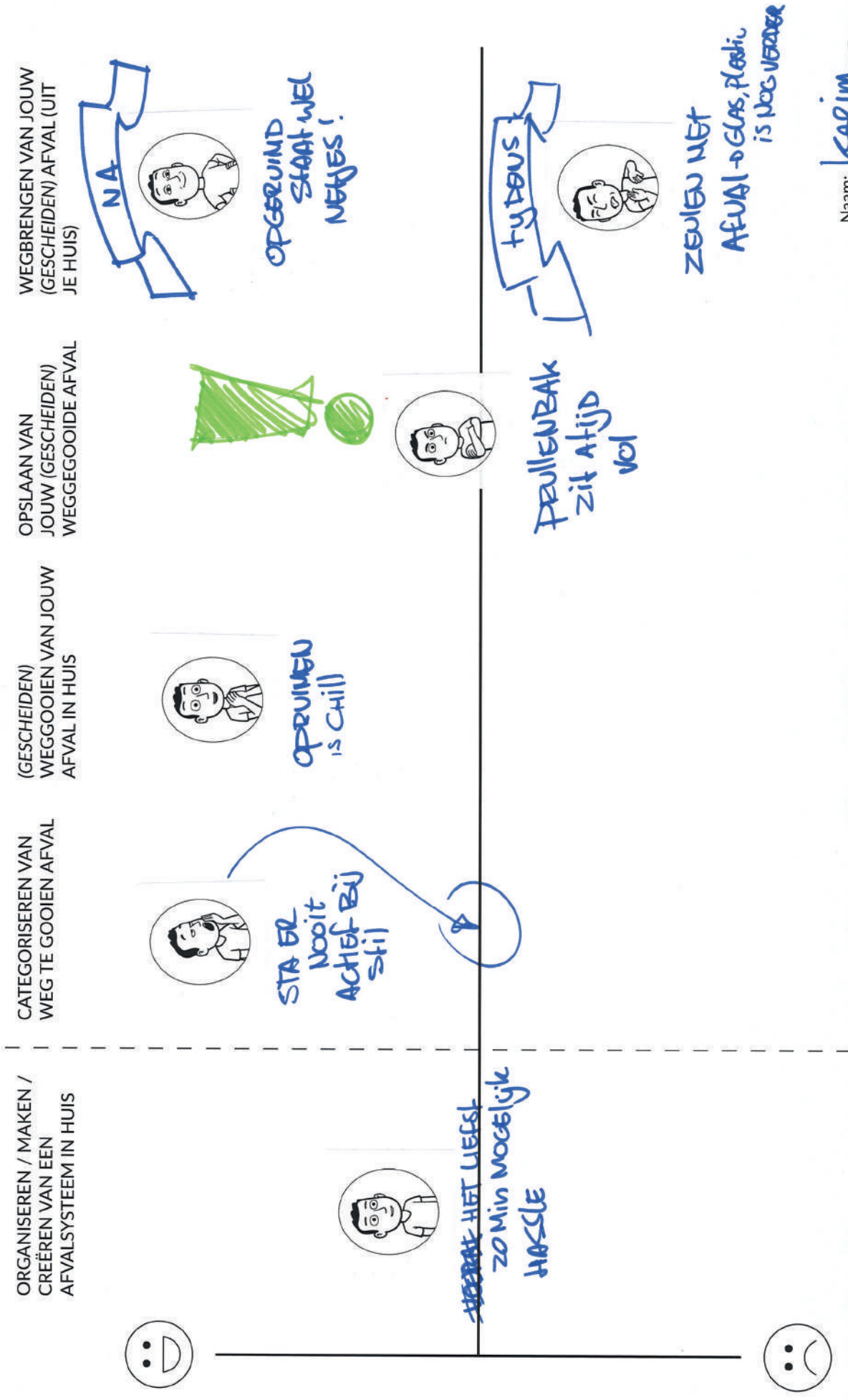

Naam: KARIM

HOE VOEL JIJ JE BIJ HET PROCES VAN HET SCHEIDEN VAN GFT, PLASTIC, PAPIER, GLAS EN RESTAFVAL?

ORGANISEREN / MAKEN / CREËREN VAN EEN AFVALSYSTEEM IN HUIS	CATEGORISEREN VAN WEG TE GOOIEN AFVAL	GESCHEIDEN WEGGOOIEN VAN JOUW AFVAL IN HUIS	OPSLAAN VAN JOUW GESCHEIDEN WEGGEGOOIDE AFVAL	WEGBRENGEN VAN JOUW GESCHEIDEN AFVAL (UIT JE HUIS)
--	---------------------------------------	---	---	--



liever niet.
weinig ruimte
kleine keuker.



liever niet.

(verschillende)
↓
Als alle bakken voor de flat staan zou ik er over na denken.



Als het te veel moeite kost niet.



te veel moeite.
te veel ruimte word ingeromen in huis.

Zoveel rommel in huis...



Naam: Jennifer

Utopia:

Modulaire afvalbak



Duidelijke productie + info

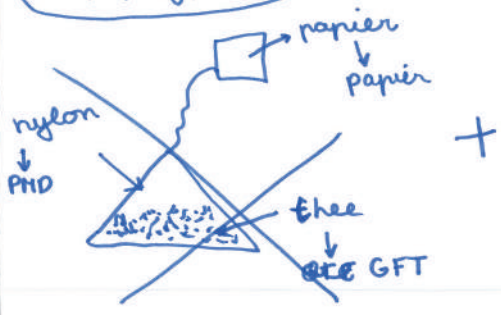

- ↳ te verwarrend & moeite voor consumenten
- ↳ duidelijkheid vanuit producent zoals label waar het moet!!

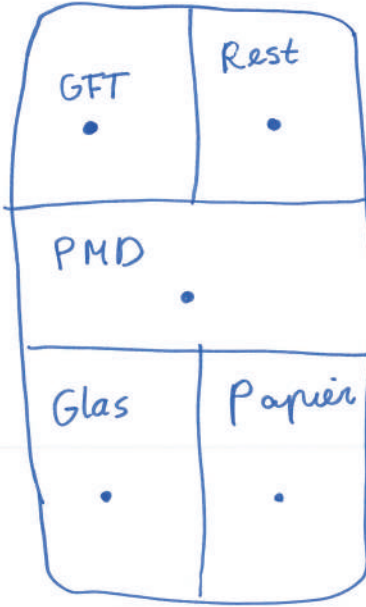

Poster
wat moet waar & wat niet?

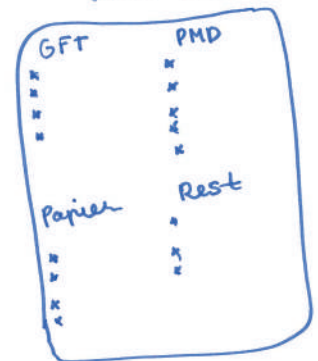

Gescheiden containers bij flat

Naam: Max



Buis wat uitkomt in gesorteerde bakken de kleur zak past bij het gesorteerde product. (buis)



op kleur scheiden.



weinig tijd voor nodig.

Gekleurde afvalzakken



Zelf beneden weggooien.

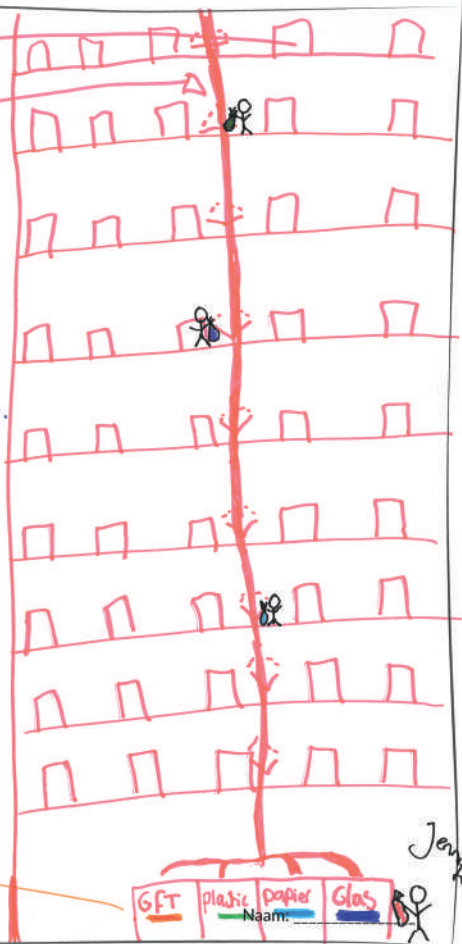

Jens

Easier disposal solutions

Solutions such as the Optibag, waste chutes or in-sink bio grinders (see Figure A.9-A.11) offer easier ways of disposal to high-rise residents. For example, the Optibag (see Figure A.9) let residents dispose of their separated waste in one container, by making use of a coloured bag system. This systems is already in use in Oslo, Norway (Holmerz, 2015).

Main advantage:

- Convenience for the high-rise resident

Main disadvantages:

- Cost investment for the installation of new systems
- Complete transition needed of the current waste management system
- High-maintenance of (complex) systems



A.9

Optibag

Met Optibag scheid je je verschillende soorten afval in verschillende kleuren zakken. Alle zakken mogen in één container. De zakken worden machinaal nagescheiden op kleur



A.10

Voedselvermaler

Met een voedselvermaler kan je GFE (groente-, fruit-, en etensresten) vermalen in je gootsteen en wegspoelen via de waterleiding



A.11

Stortkoker

Met een stortkoker in jouw flat, kun je jouw (gescheiden) afval op jouw verdieping weg gooien. De afval zakken worden dan onder in de flat opgevangen in containers



Gescheiden afval ophangen

A.12

Voor de flat kun je je zakken gescheiden afval één keer per week ophangen. Het wordt dan opgehaald. De rest van de week is de ruimte voor de flat vrij van afval en afvalcontainers

Separation products

Several products are for sale to help citizens with in-home waste separation, such as modulair or combined separation bins, or separation systems for kitchen drawers. For example, the Joseph Joseph bin (see Figure A.13) offers the possibility to dispose all separated waste in one bin.

Main advantage:

- Saving in-home space compared to separated bins

Main disadvantages:

- Not in the power of the City of Rotterdam to ensure people purchase these products
- Too expensive products to provide for free to their citizens for the City of Rotterdam



A.13

Gecombineerde afvalbak

Met een gecombineerde afvalbak kun je in één prullenbak al je verschillende soorten gescheiden afval kwijt



A.16

Afvalstelsel in keukenlade

Met een afvalstelsel in je keukenlade kun je al je afval scheiden in verschillende bakjes. Deze bakjes zitten weggewerkt in je keukenlade



A.14

Modulaire afvalbak

Met modulaire afvalbak kun je verschillende compartimenten combineren naar jouw smaak. Je kunt hierin dan al je verschillende soorten gescheiden afval kwijt

Rewarding waste separation

Several initiatives come up with rewarding systems for citizens who separate their waste. For example, the Wasted app (see Figure A.17) makes it possible for citizens of Amsterdam to collect point per bag of separated waste. With these points, they get discount on products or consumptions in local shops (Wasted, n.d.).

Main advantage:

- Extrinsic motivation for high-rise residents to separate their waste: there is something to gain

Main disadvantages:

- Rewards are not universal: not all high-rise residents will be stimulated by the same reward
- Scalability of the solution, if everyone in the city starts separating their household waste



A.15

Plasticpletter

Met een plasticpletter kun je je apart gescheiden plastic aandrukken, om zo extra ruimte in je prullenbak te creëren. Zo hoef je je plastic afval minder vaak weg te brengen

DEKSEL OPEN,
PLASTIC ERINDEKSEL DICHT,
GEEN GEURTJESHENDEL OMHOOG,
LET'S PLET!PLASTIC GEPLET,
EXTRA RUIMTE

A.17

Wasted app

Met de Wasted app, kun je sparen voor punten. Je krijgt één punt als je een zak gescheiden afval weggooit. Met je gespaarde punten krijg je korting in winkels of gratis koffie bij cafés



A.18

GFT vergister

Met een GFT vergister, kan het GFT-afval van de bewoners in de flat worden omgezet in biogas. Zo kan je met de flat gas produceren, dat gebruikt kan worden voor verwarming van de flat

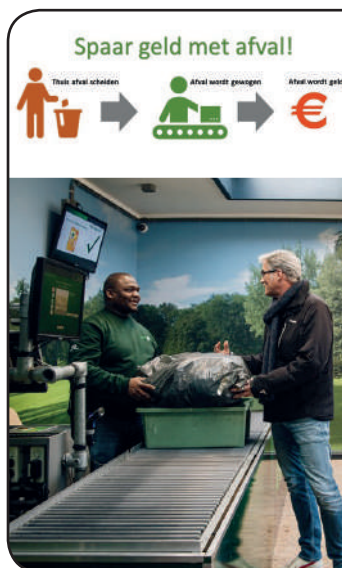

A.19

Afvall loont

Bij 'Afvall loont' kun je je afval gescheiden inleveren, waarbij het gewogen wordt. Per gescheiden kilo word je in geld uitbetaald, want elke soort afval is geld waard

Financial encouragement

Several services are in place in municipalities in the Netherlands to financially encourage citizens to separate their waste, such as Diftar or 'Afvall Loont' (translated as 'Waste Pays') (see Figure A.20-A.19). Diftar is implemented in several municipalities in the Netherlands already. It means that disposing residual waste is charged per bag (when purchasing the bag or with a card system upon disposal), while separated waste can be disposed for free (VANG huishoudelijk afval, n.d.a).

Main advantage:

- It is clear for high-rise residents what the benefit of waste separation is: they will save money in case they separate more

Main disadvantage:

- Susceptible for abuse, with the danger of polluting separated waste fractions. Residents can make use of non-charged bags or containers to dispose their residual waste for free.

Collection systems

Different waste collection systems can be arranged by municipalities in the Netherlands. For example, in Oude Westen in Rotterdam, the municipality is piloting 'de schillenboer' (translated as 'the peel farmer') (see Figure A.21). In this neighbourhood, 'de schillenboer' drives around a cargo bike three times a week, to collect bio waste (Gemeente Rotterdam, n.d.).

Main advantage:

- It is facilitated for high-rise residents to have their separated waste collected, instead of having to bring their waste to a certain point



A.20

Diftar

Voor het weggooien van je restafval moet je betalen met een 'Afvallpas'. Gescheiden afval kan je gratis weggooien in daarvoor bestemde containers



A.21

Schillenboer

Met een schillenboer komt er op een vast tijdstip per week, iemand in jouw wijk langs om jouw GFT afval op te halen. Op die manier kan dit apart ingezameld en verwerkt worden

Main disadvantages:

- For collections systems, high-rise residents (often) have to be at home at the moment of collection. This makes the system less flexible to incorporate in residents' personal agendas

**A.22****Bestel-en-retourneer service**

Bij de bezorging van online bestelde boodschappen is het mogelijk om gescheiden huishoudelijk afval in zakken mee terug te geven

Disposal points

Several waste disposal point initiatives arise in the Netherlands, such as at supermarkets or as stand-alone spots. Retourette (see Figure A.23) is an example of a stand-alone location where citizens can come to, to hand-in their separated waste (Retourette, n.d.). Multiple different separated waste fractions are facilitated, such as batteries, bottles, textile or old appliances.

Main advantage:

- One location to dispose of all separated waste fraction

Main disadvantages:

- The disposal points are present at few locations in a city only. High-rise residents will have to cover a larger distance to make use of the disposal points, than to use the municipal waste containers

Information providence

Several interventions exists to inform citizens about the waste separation system and the offered services. For example, information posters are available, explaining citizens how to separate their waste, or what waste can or cannot go with a certain fraction (Figure see A.25).

**A.23****Retourette**

Bij Retourette kun je in een (winkel-) pand in de buurt, al je afval op één plek gescheiden inleveren. Dit geldt bijvoorbeeld ook voor statiegeldflessen en batterijen

**Inleverpunt bij jouw supermarkt****A.24**

Met een inleverpunt bij jouw supermarkt, kun je bij je supermarkt niet alleen statiegeldflessen, maar ook al je afval gescheiden inleveren

Main advantage:

- It increases the ability of high-rise residents to separate their waste, by providing them with the knowledge they (might) currently lack

Main disadvantages:

- Ensuring that high-rise residents see and take in the information provided
- Making high-rise residents act upon the information provided

Municipal facilities

The facilities a municipality offers to her citizens, can contribute to household waste separation of the citizens. For example, pilots are carried out where residents receive free kitchen counter bio waste bins. In other municipalities, positioning of waste containers is rearranged. An example of such rearrangement is

A.25

Plastic flessen en flacons, Metalen verpakkingen, Drinkkartons

OK!

Fout!

Aluminium schooltjes, Metalen deksen, Blijpspek en verpakkingen

Blijjes, Plastic flessen, Drinkkartons, Plastic flessen, Legge spuitbussen van verstuift en aerosol

Volledig leeg, maximaal volume = 8 liter

Afval sorteren, leuk om leren

Informatieposter

Op een informatieposter voor in je keuken staat per afvalstroom aangegeven welke producten hier WEL en NIET bij horen. Dit helpt je je afval goed te scheiden

A.27

Omgekeerd inzamelen

Bij omgekeerd inzamelen staan de GFT-, papier-, en plastic container het dichtst bij je huis. Voor het wegbrengen van restafval moet je verder lopen

A.26

Huisregels van de flat

Als je in je nieuwe flat komt wonen staat bij de huisregels uitgelegd dat in deze flat afval wordt gescheiden. Iedereen in de flat dient zich aan de huisregels te houden

Gescheiden containers voor de flat **A.28**

Met gescheiden containers, kun je buiten voor jouw flat je afval gescheiden weg gooien. Alle containers staan bij elkaar

‘Omgekeerd inzamelen’ (translated as ‘Reverse collection’) (see Figure A.27). This means separated waste containers are placed close to residencies or these fraction are collected at home, while the distance to residual waste containers is increased (VANG huishoudelijk afval, n.d.b).

Main advantage:

- The effort to dispose separated waste is limited (combined with increased effort to dispose residual waste), which forms a motivation for residents to separate waste

Main disadvantages:

- Susceptible for abuse, with the danger of polluting separated waste fractions. Residents can make use of the closest containers to dispose their residual waste with low effort

A.29

Gratis GFT-aanrechtbakje

Tijdens een actie van de gemeente krijg je als bewoner een gratis GFT-aanrechtbakje uitgedeeld. Hierin kun je je GFT verzamelen, waarna je het buiten in een gezamenlijke container kan weggooien

References Appendix K

Gemeente Rotterdam (n.d.). *Schillenboer*. Retrieved March 5, 2019, from <https://www.rotterdam.nl/wonen-leven/schillenboer/>

Holmerz, S. (2015). *Oslo's Colourful Solution to Waste Management*. Retrieved December 6, 2018 from <https://waste-management-world.com/a/oslos-colourful-solution-to-waste-management>

Retourette (n.d.). *Over Retourette*. Retrieved March 5, 2019 from <http://retourette.nl/over-retourette/>

VANG huishoudelijk afval (n.d.a). *Factsheet 'Diftar in 5 punten'* Retrieved March 5, 2019, from <https://www.vang-hha.nl/nieuws-achtergronden/2015/artikelen/factsheet-'diftar-5/>

VANG huishoudelijk afval (n.d.b). *Factsheet 'Omgekeerd inzamelen in 5 punten'*. Retrieved March 5, from <https://www.vang-hha.nl/nieuws-achtergronden/2015/factsheet-'omgekeerd/>

Wasted (n.d.). *Wasted Turn your waste into discount*. Retrieved December 14, 2018 from <https://wastedlab.nl/en/>

L: Creative session

Session goal

The goal of the creative session is to generate as many ideas as possible, concerning the problem definition and design vision.

Participants

Five fellow design students participated in this creative session

Session outline

The workshop itself consisted of four parts. In the first part, the participants were asked to visualise the worst case scenario: *What if waste processing would no longer exist?* In the second part the participants brainstormed about six How-to statements. In the third part of the session the participants brainstormed about six How-to and What-if statement, related to in-home household waste management. In the final part of the creative session, the participants were asked to visualise their household waste management utopia.

For each part of the creative session one filled sheet is presented to illustrate the workshop outcomes.



2

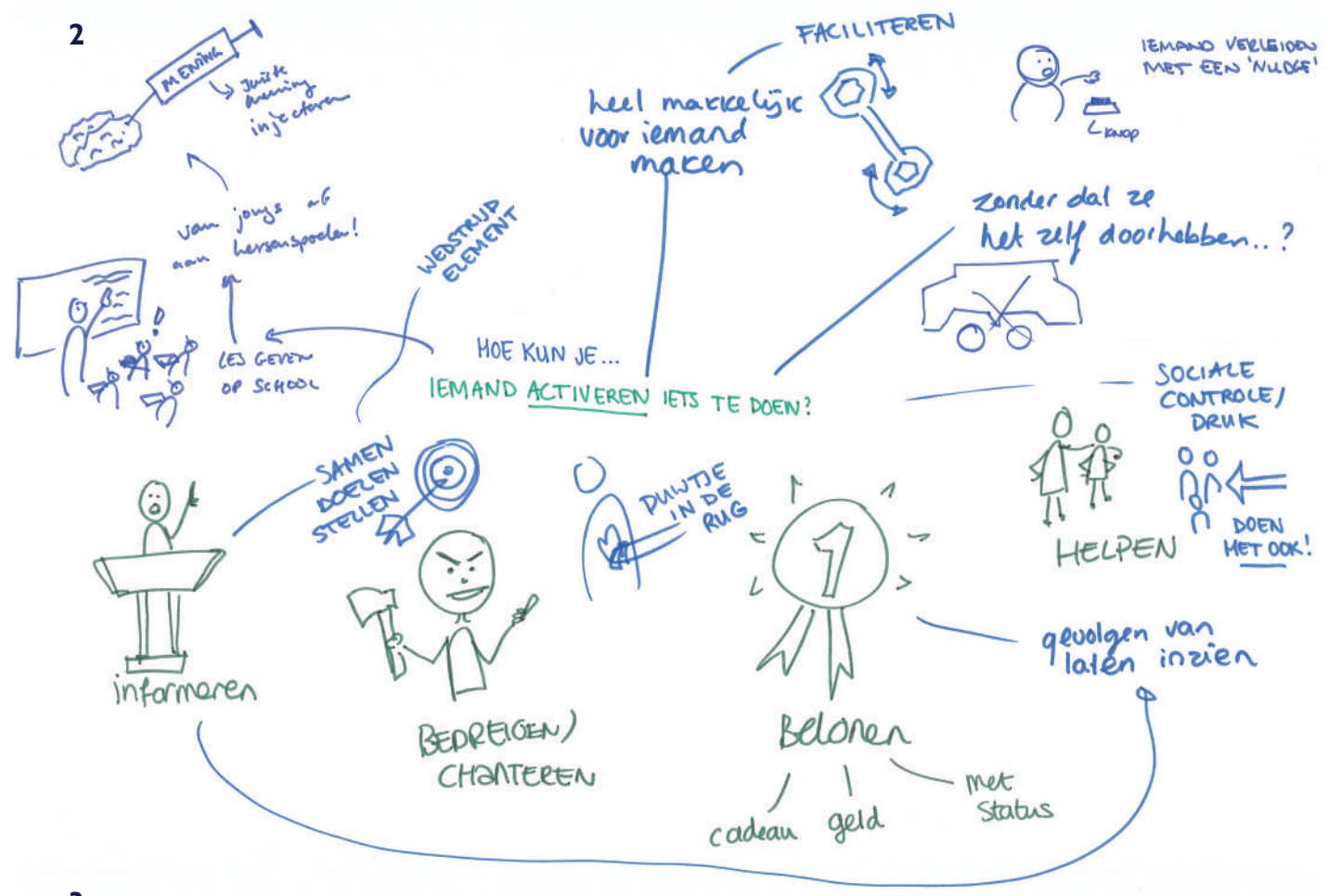

3

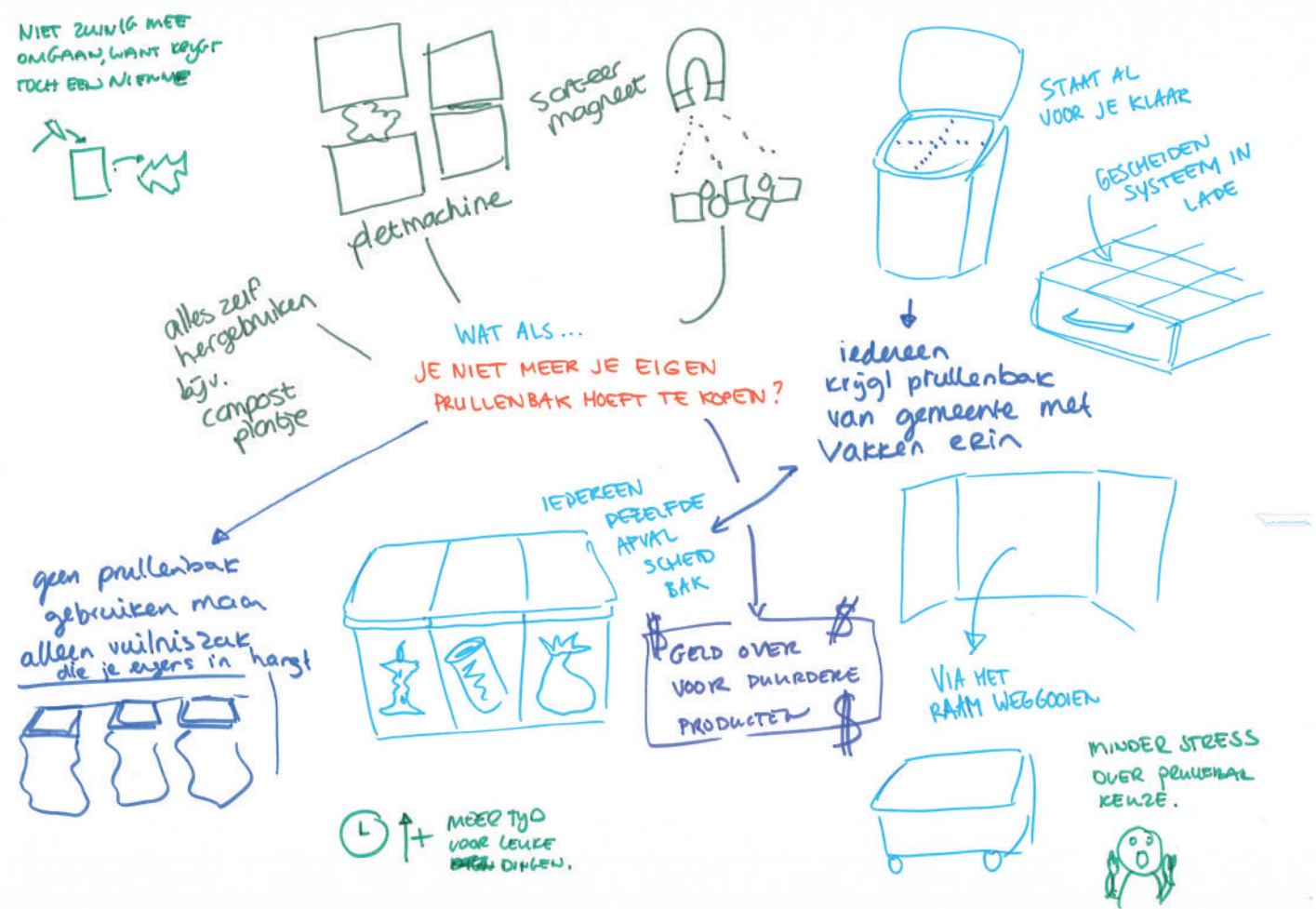

4

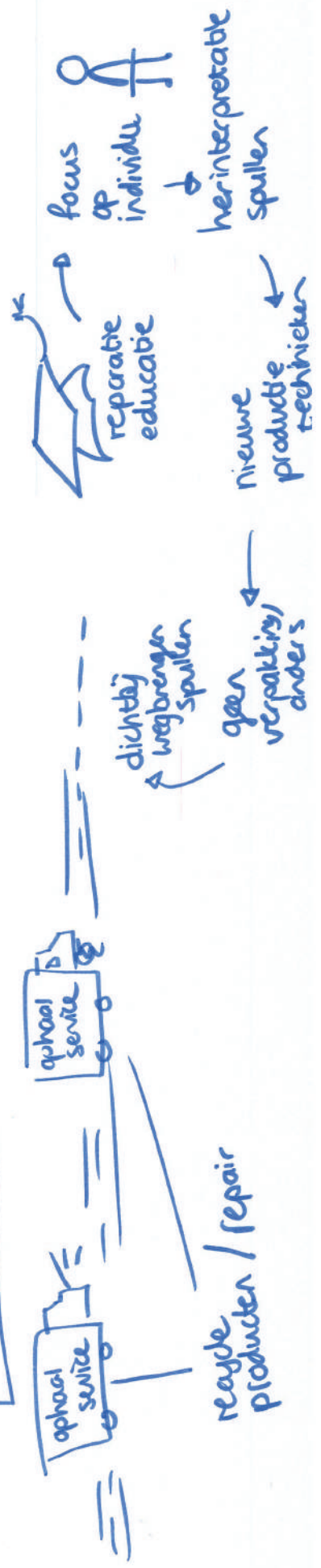
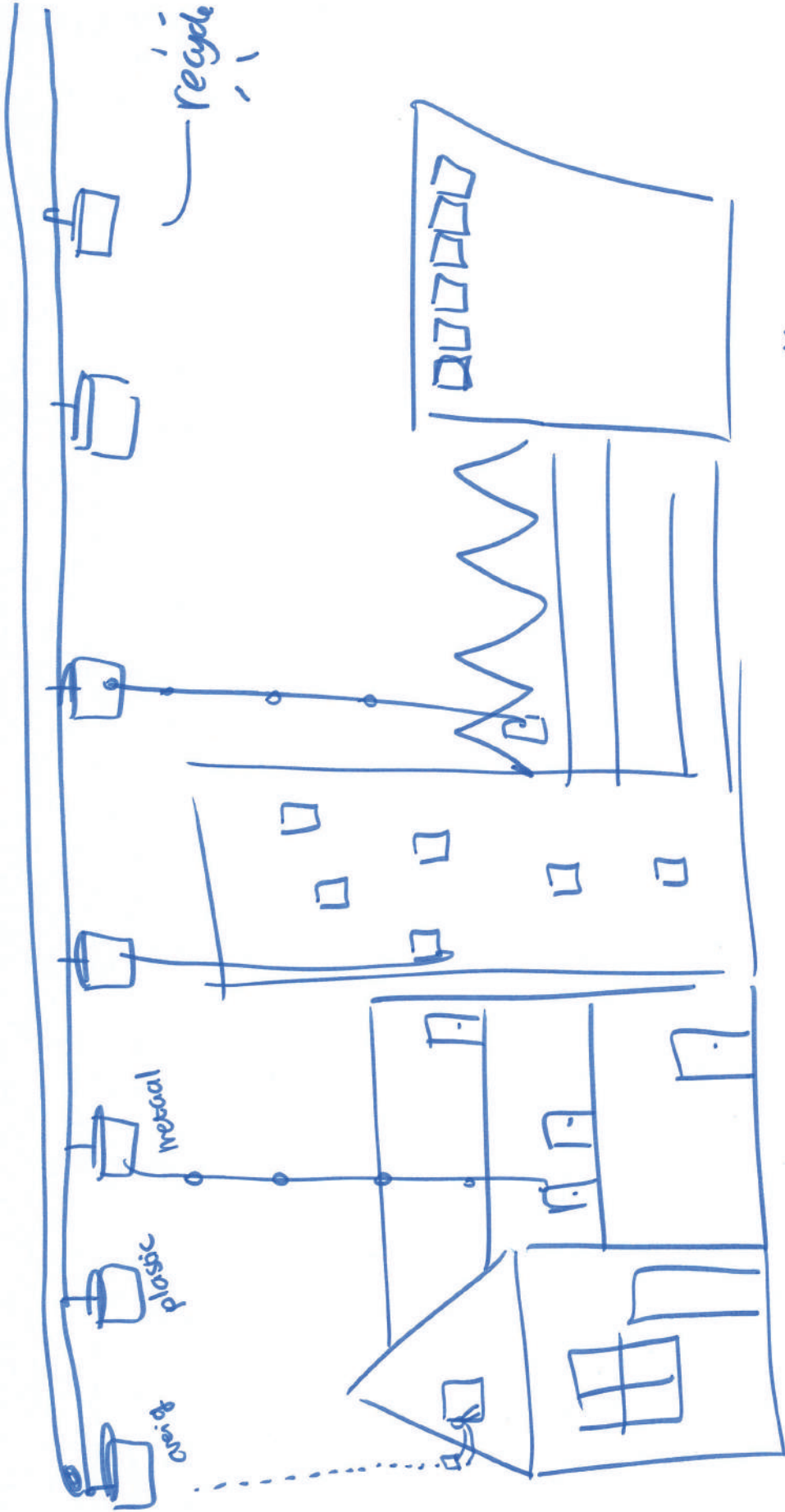

BRAINDUMP (1) 14/1/19

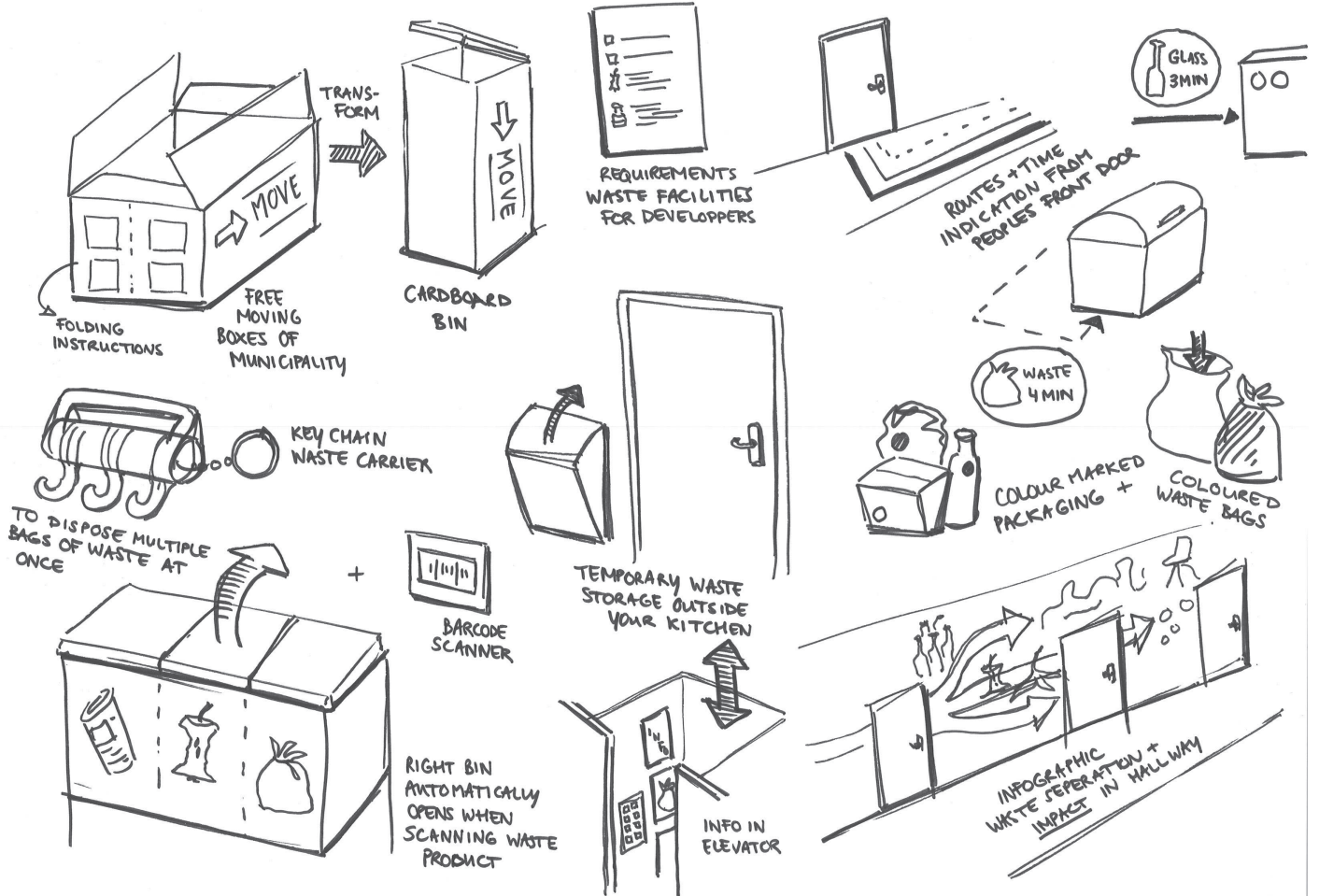

BRAINDUMP (2) 14/1/19

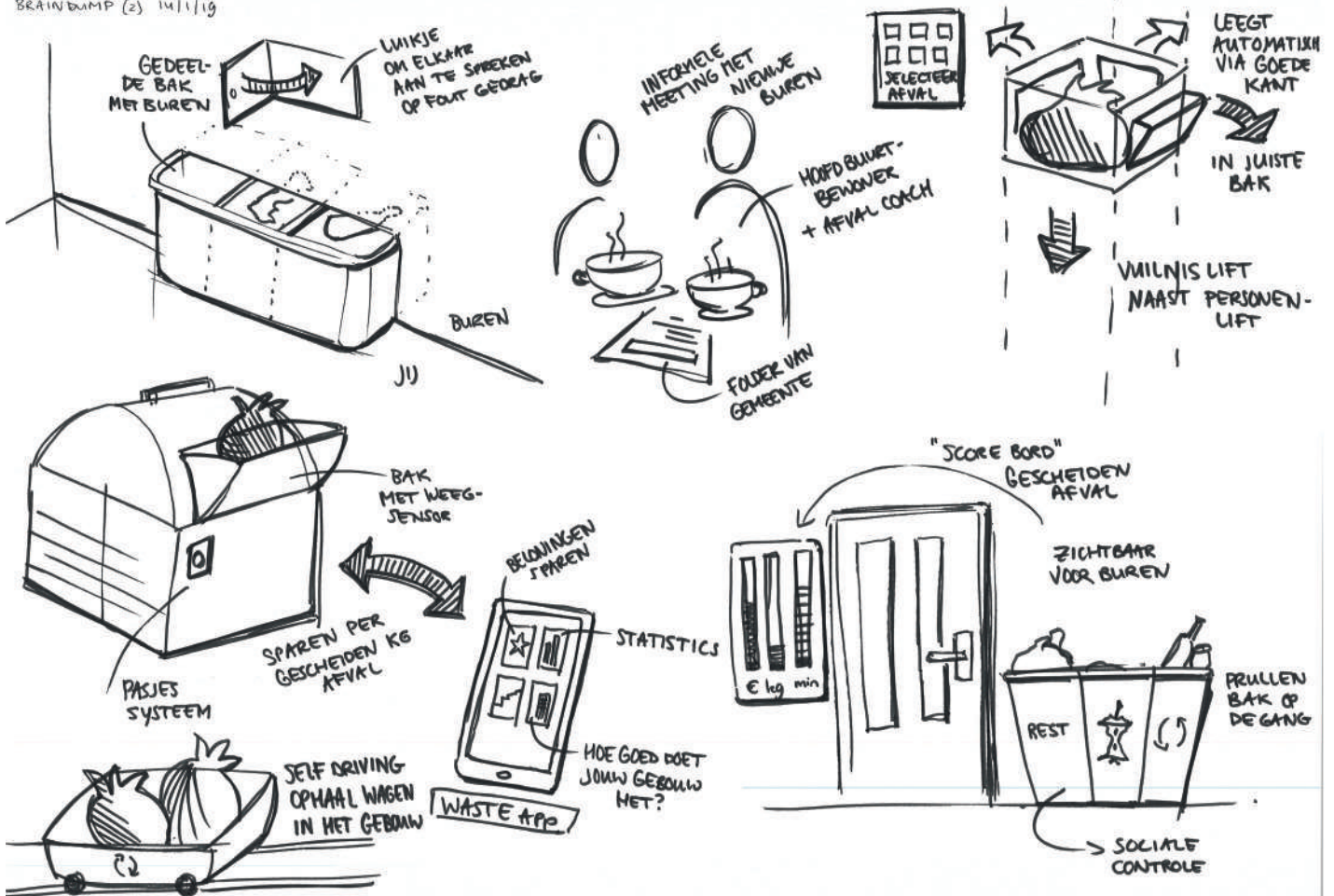

BRAIN DUMP (3) 14/1/19

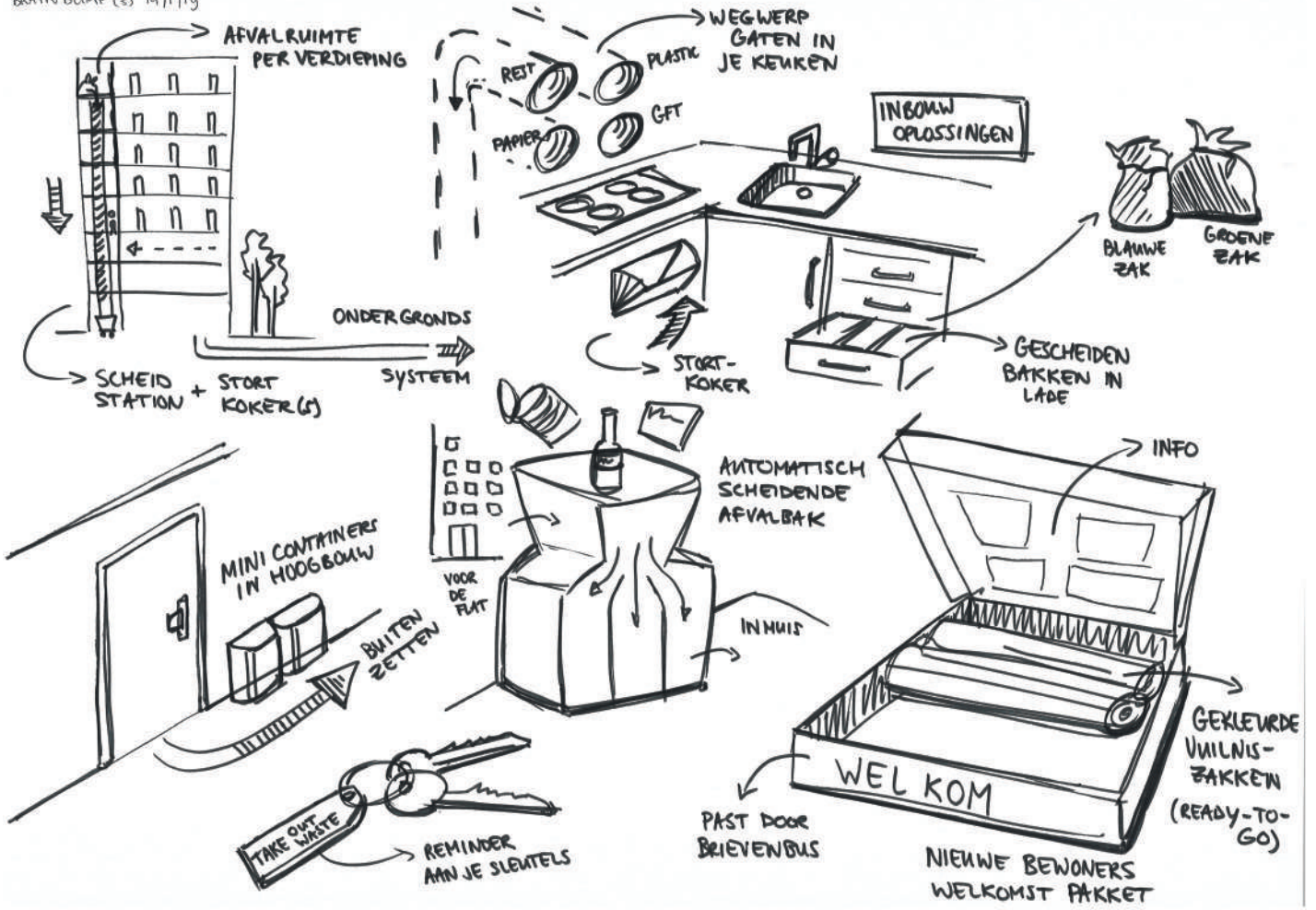

BRAIN DUMP (4) 14/1/19

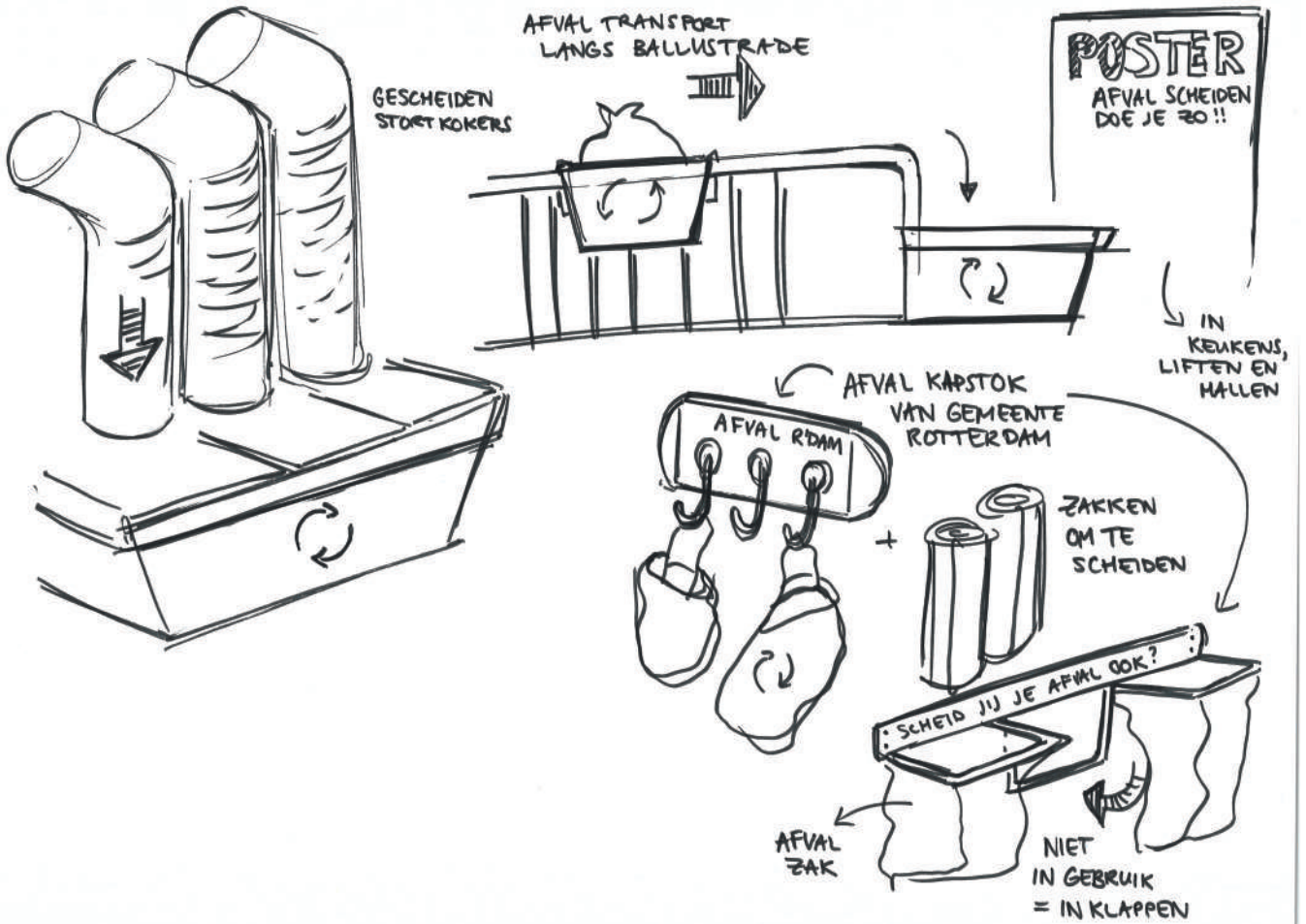

BRAIN STORM (1) 16/1/19

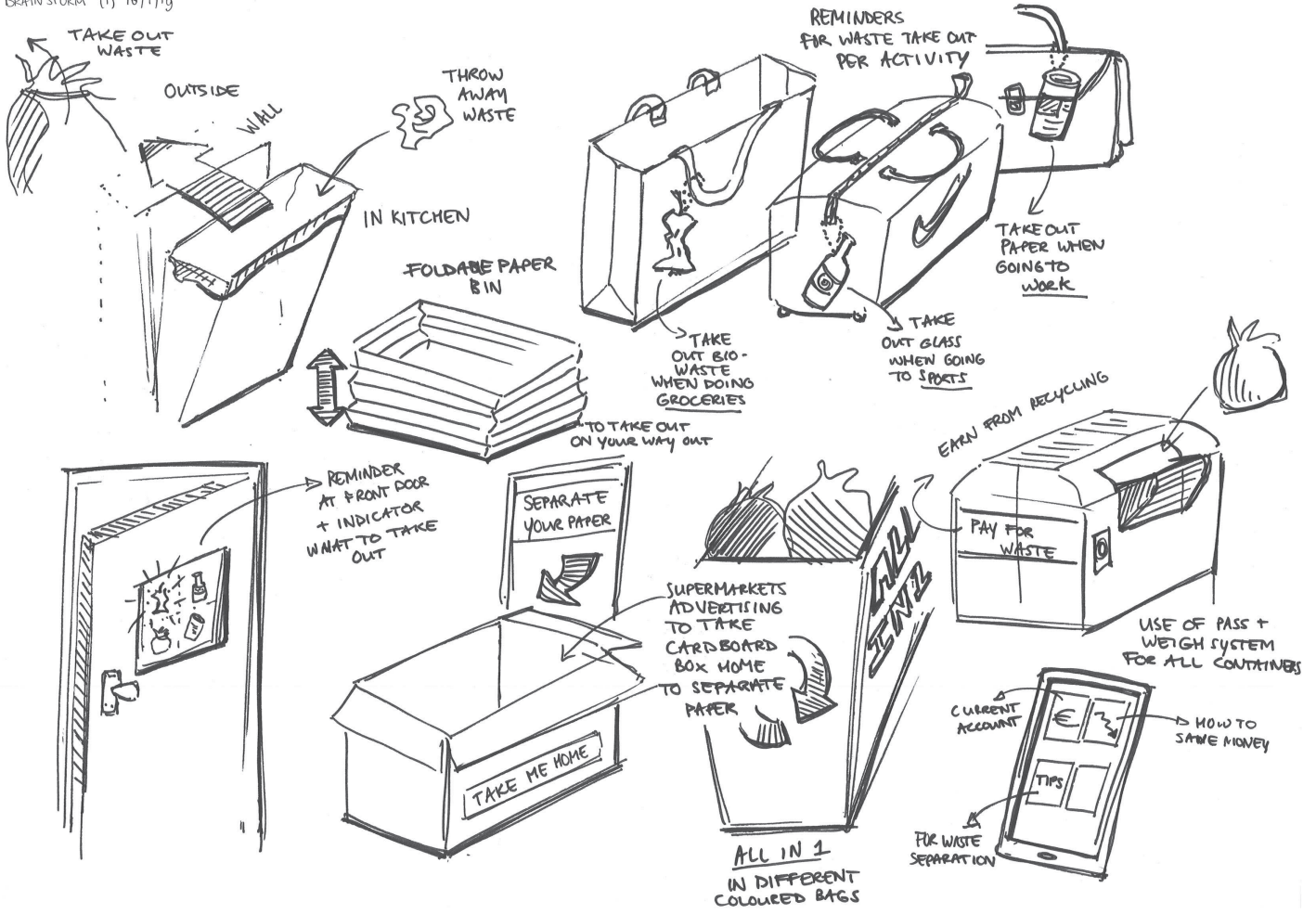

BRAIN STORM (2) 16/1/19

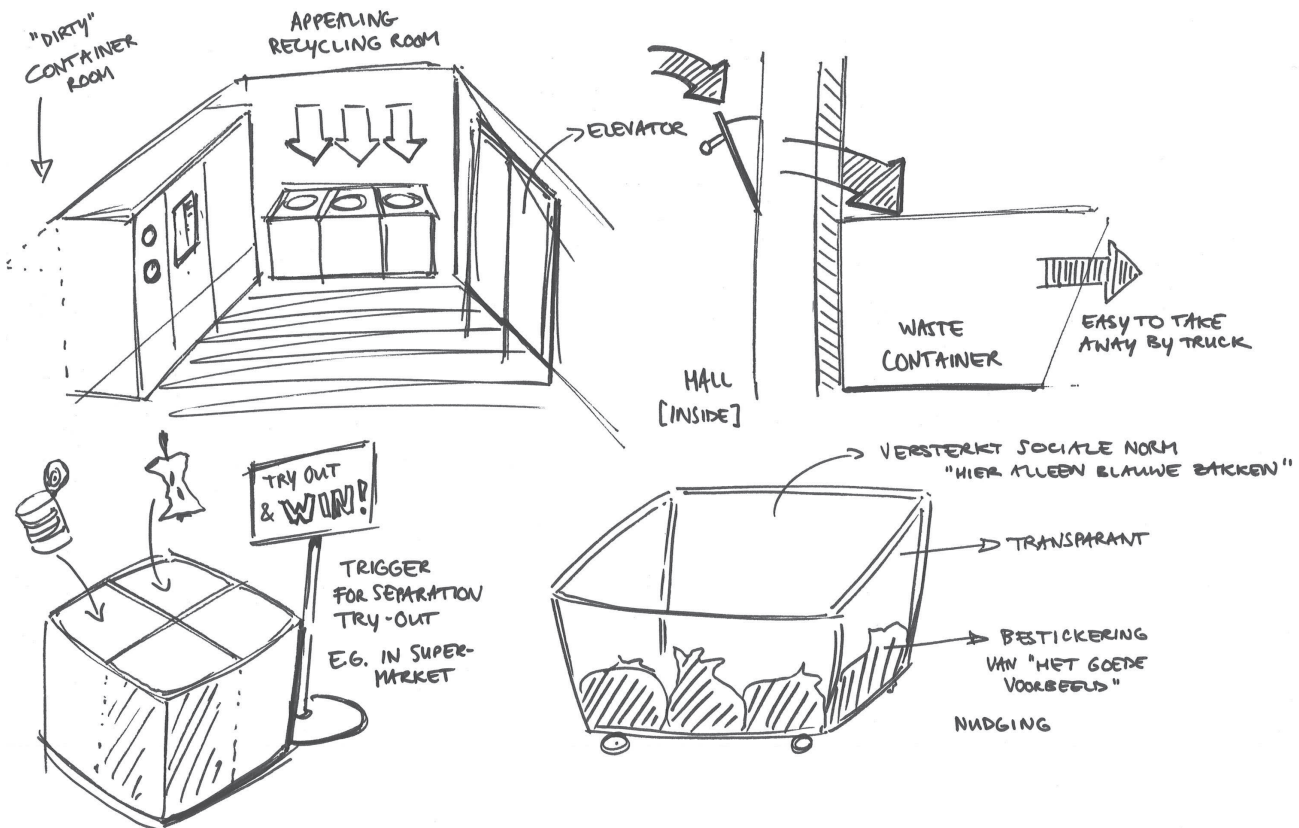

BRAINSTORM (1) 14/11/19

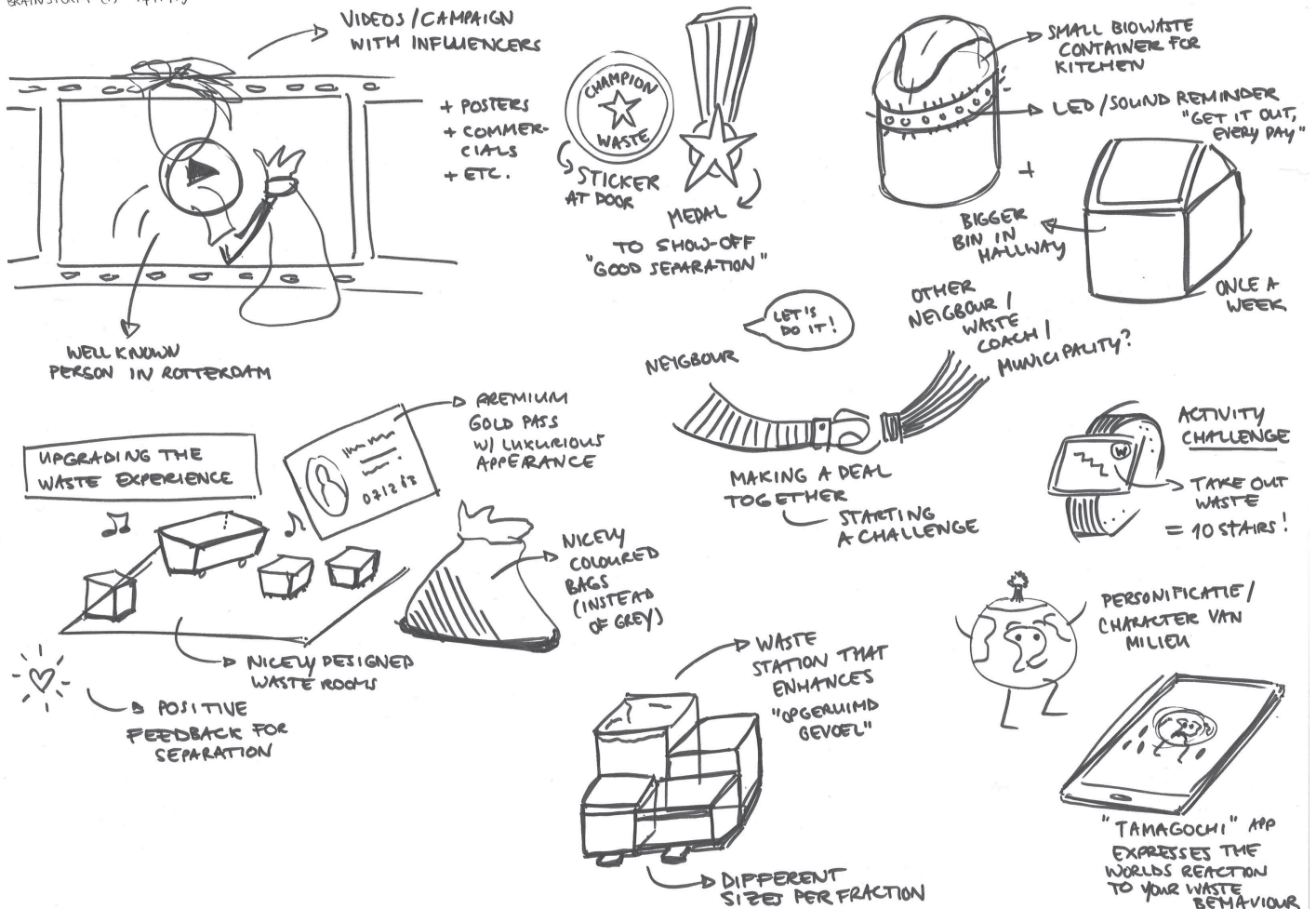

BRAINSTORM (2) 14/11/19

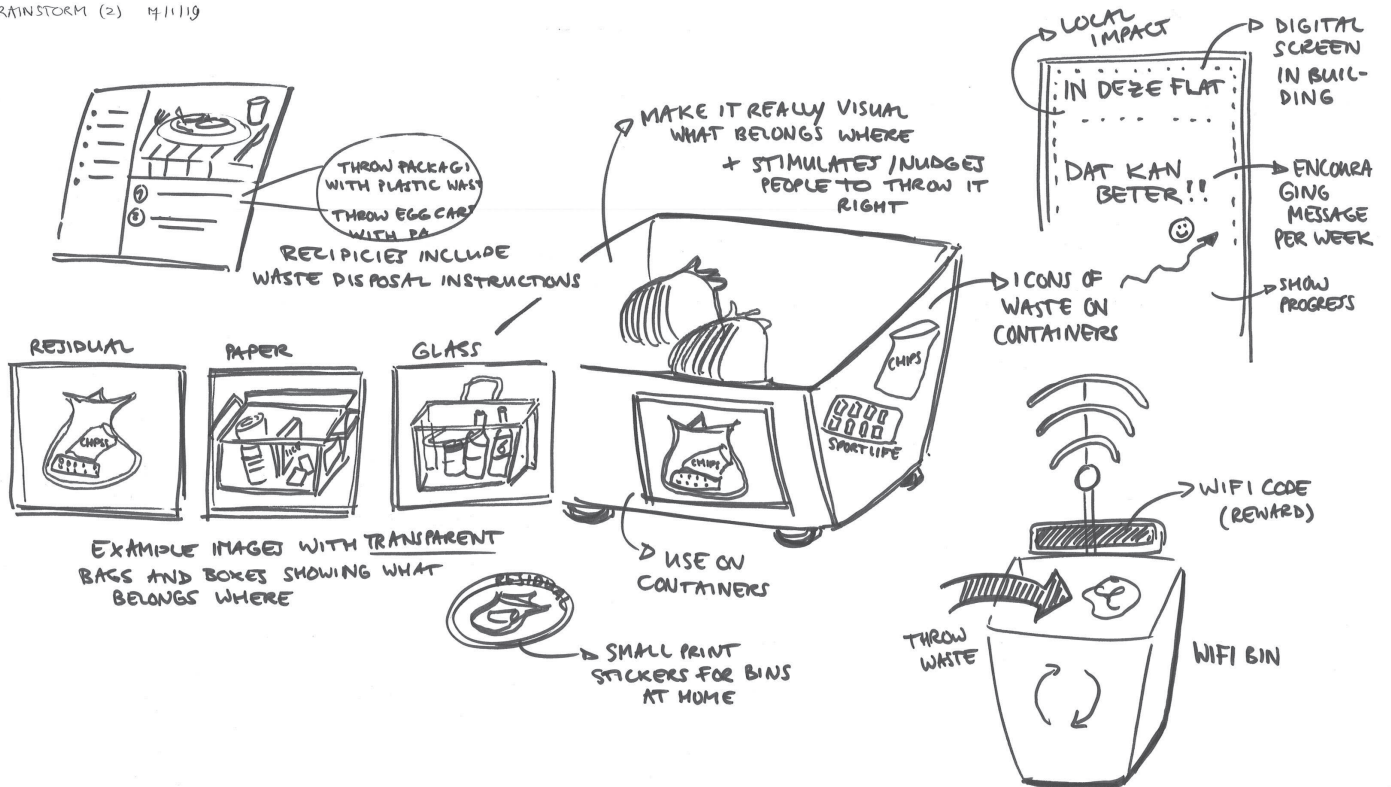

BRAINSTORM 21/1/19
(1)

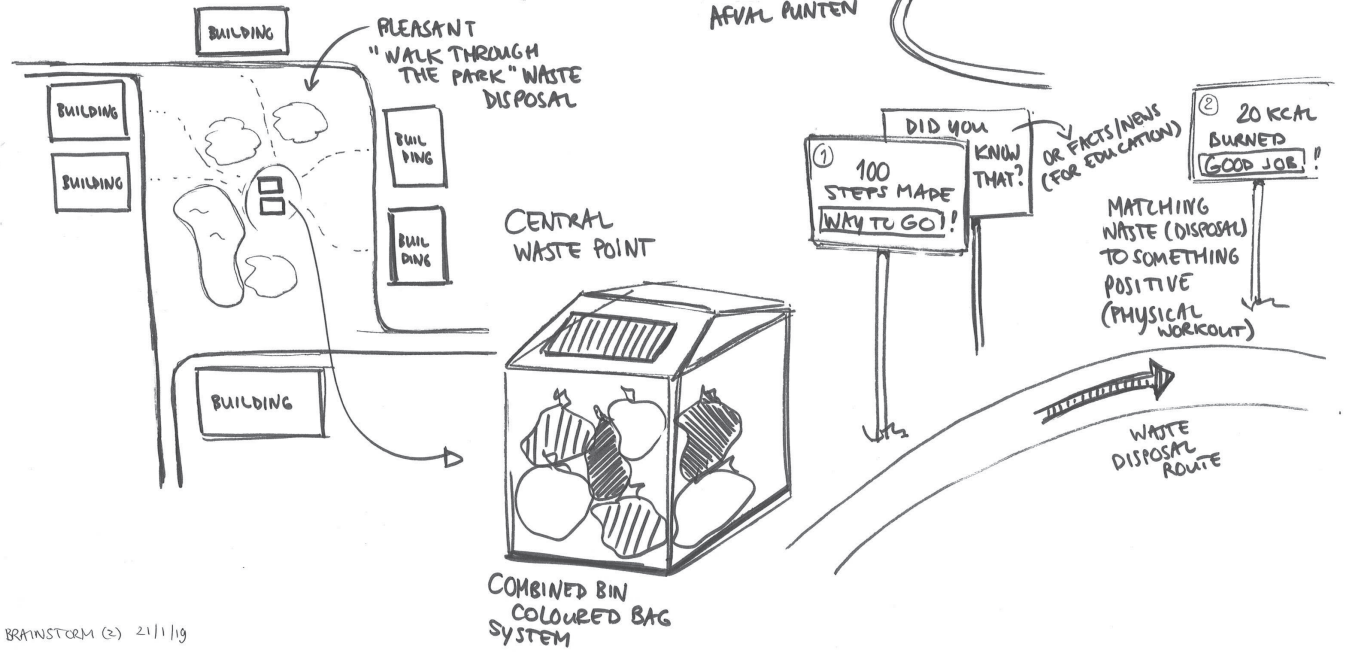
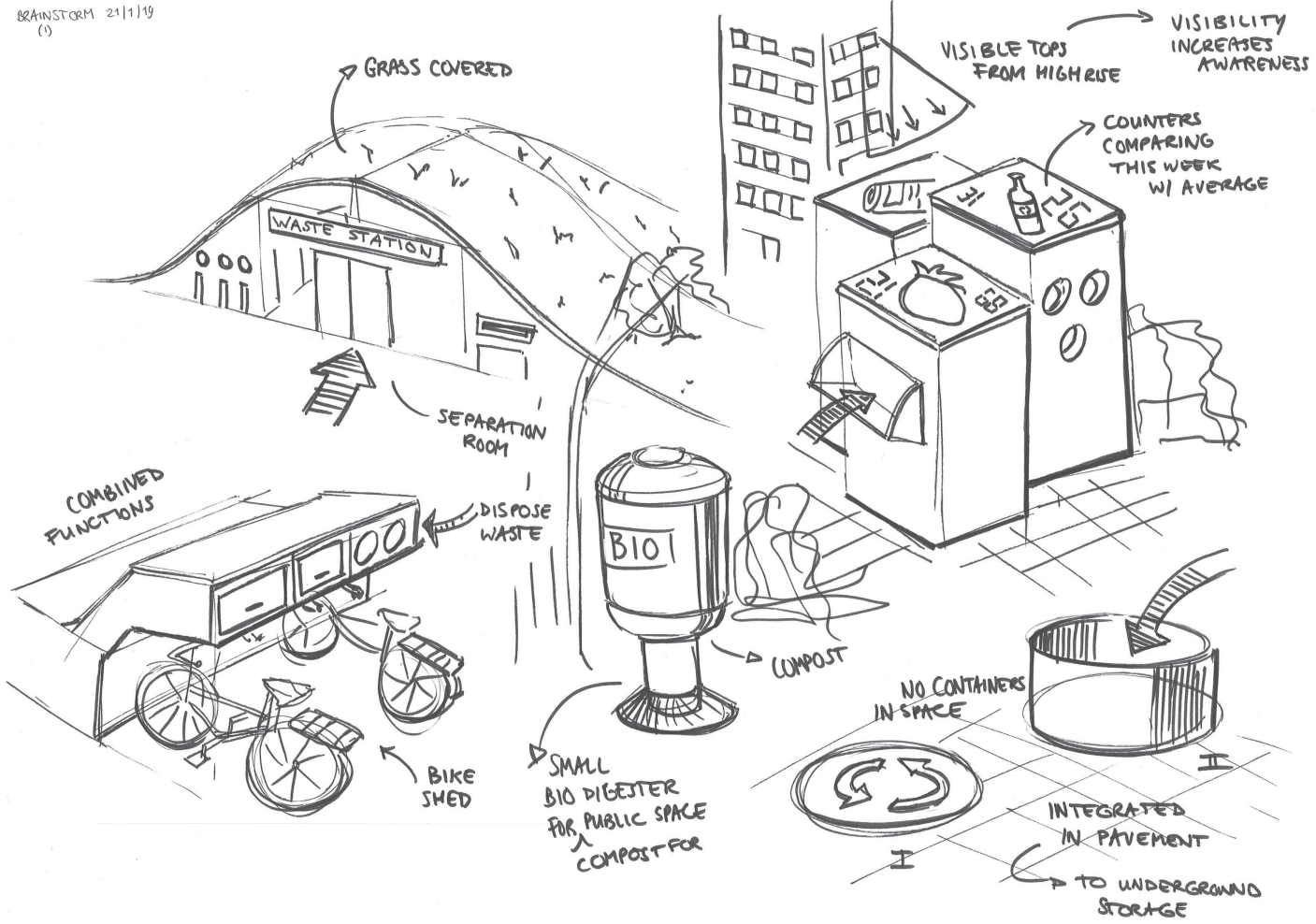

BRAINSTORM (2) 21/1/19

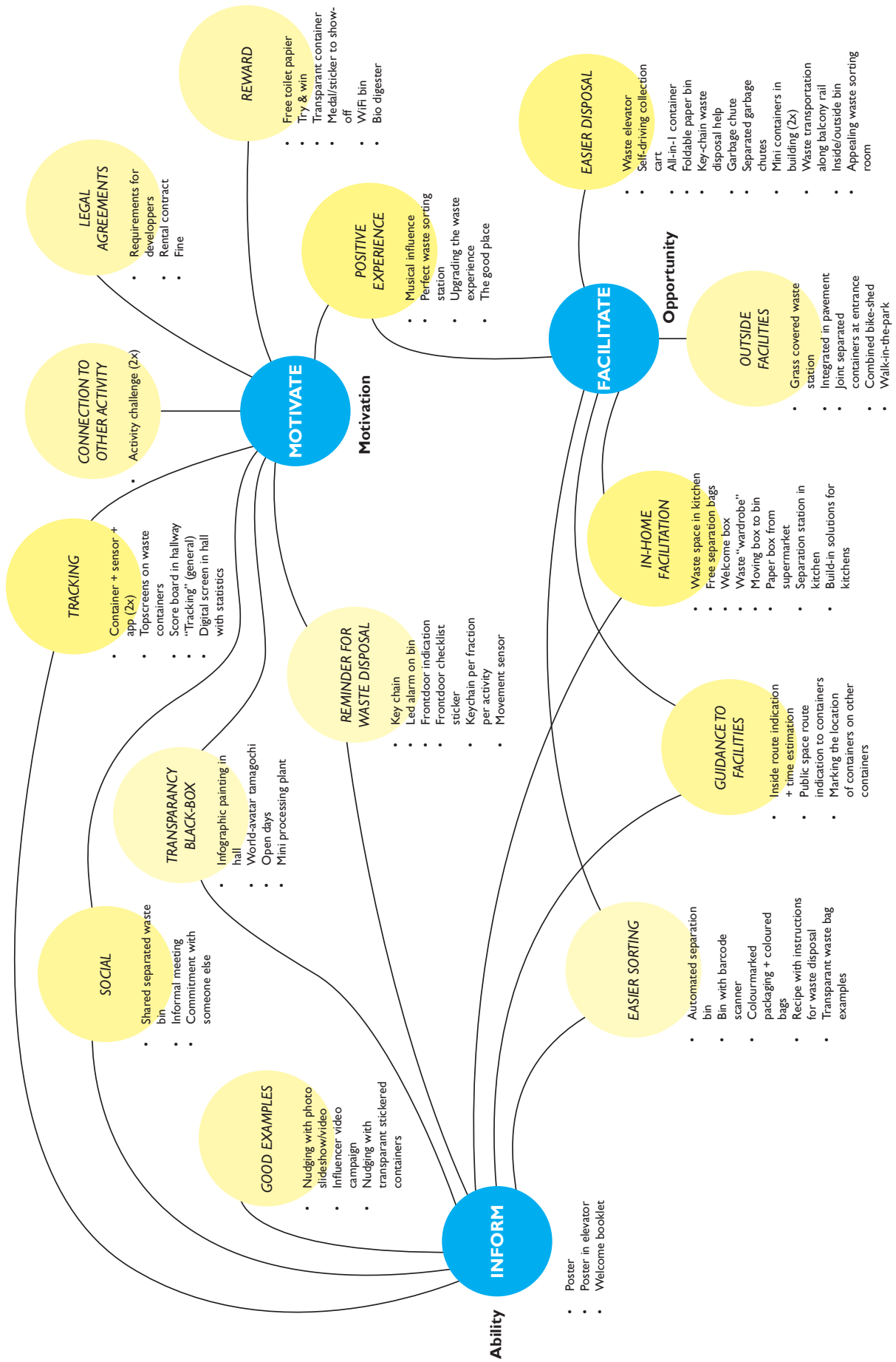

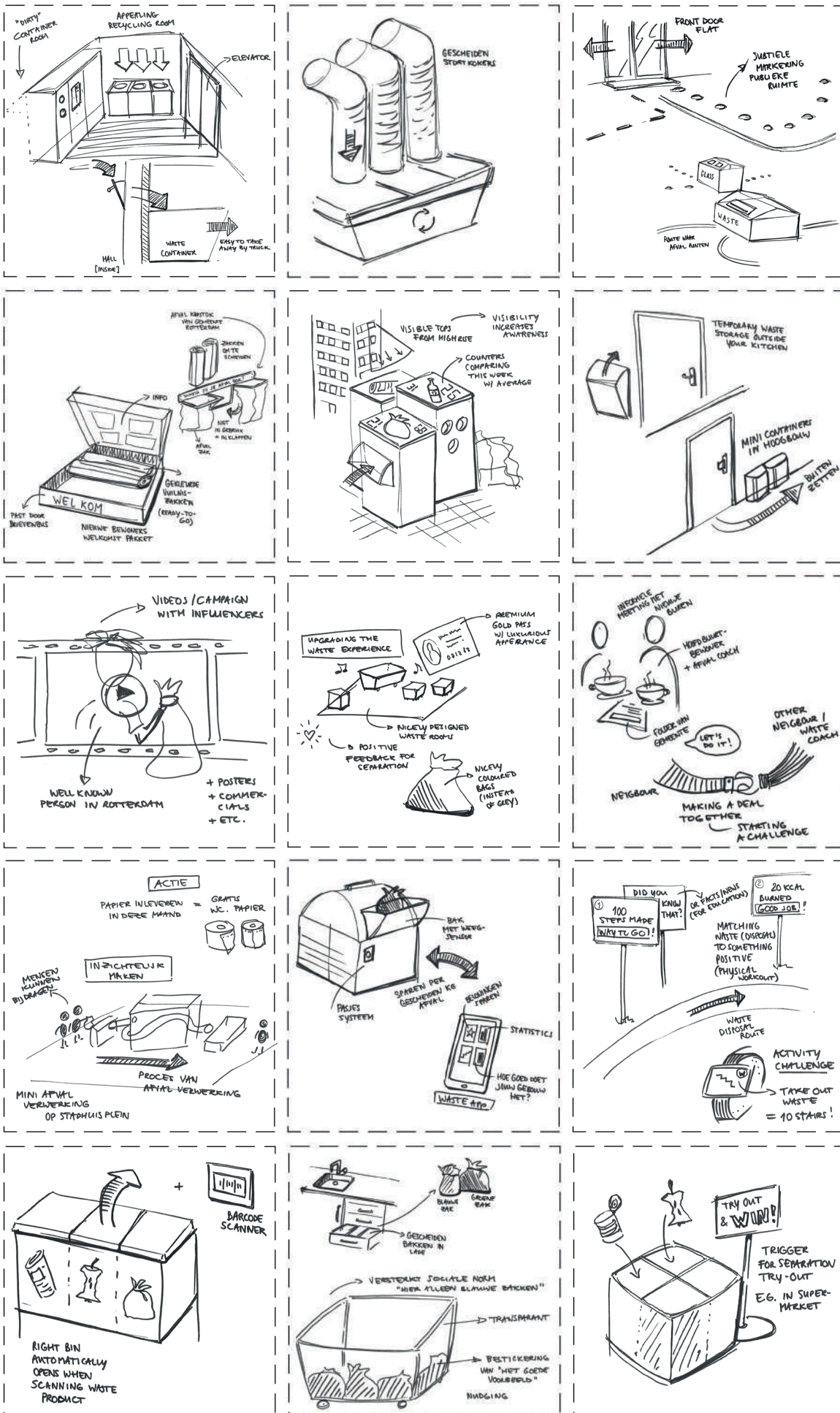

The fifteen ideas presented to the City of Rotterdam. See Figure A.30 for the classification by the Department of Urban Management of the City of Rotterdam

INNOVATIVENESS

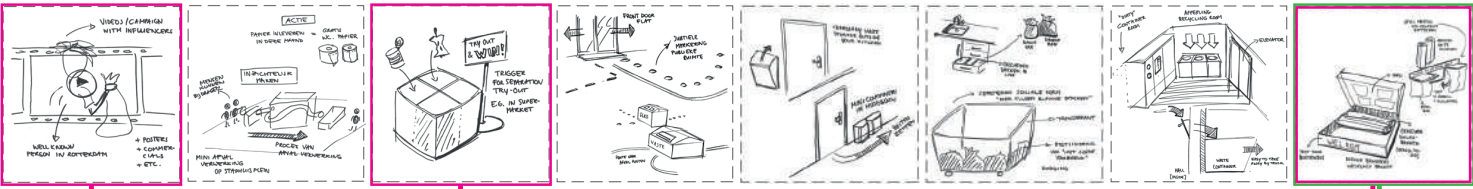

FEASIBILITY

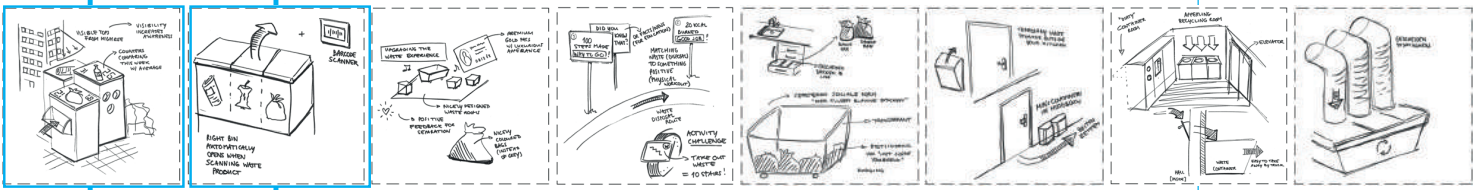

DESIRABILITY

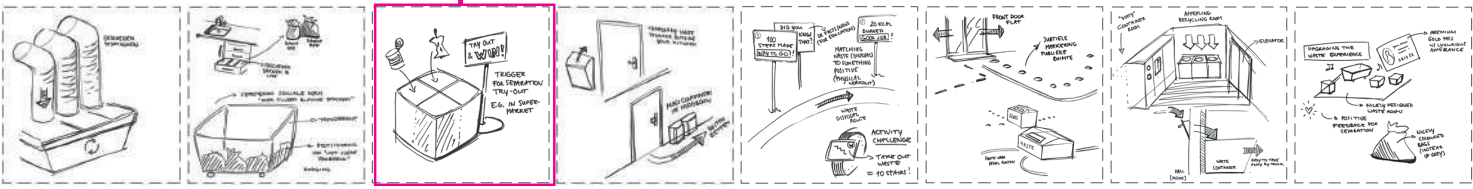

Figure A.30 The mapping of the fifteen presented ideas regarding Innovativeness, Feasibility and Desirability

Social welcoming

With the social welcoming concept, a fellow neighbour brings a recently moved high-rise resident a visit. This neighbour is besides main resident of the building, also a waste coach. He or she explains the new neighbourhood and building to the moved resident, and especially dedicates time to provide instructions regarding the waste management in the building. At the end of the meeting, the waste coach asks for commitment to waste separation from the recently moved neighbour.

Main strategies:

Social influence, social norming, asking commitment

Welcome box

With the welcome box concept, recently moved high-rise residents received a box from the municipality by mail, within the first month after moving. This welcome box contains both information as well as facilities to start waste separation at home right away. For example, information about the waste fractions that need to be separated and the locations of the waste containers; facilities such as coloured garbage bags or a garbage rack to hang loose bags.

Main strategies:

Reciprocity, pro-actively informing, facilitating

FIGURE A.31
Visualisation of the Social welcoming concept idea

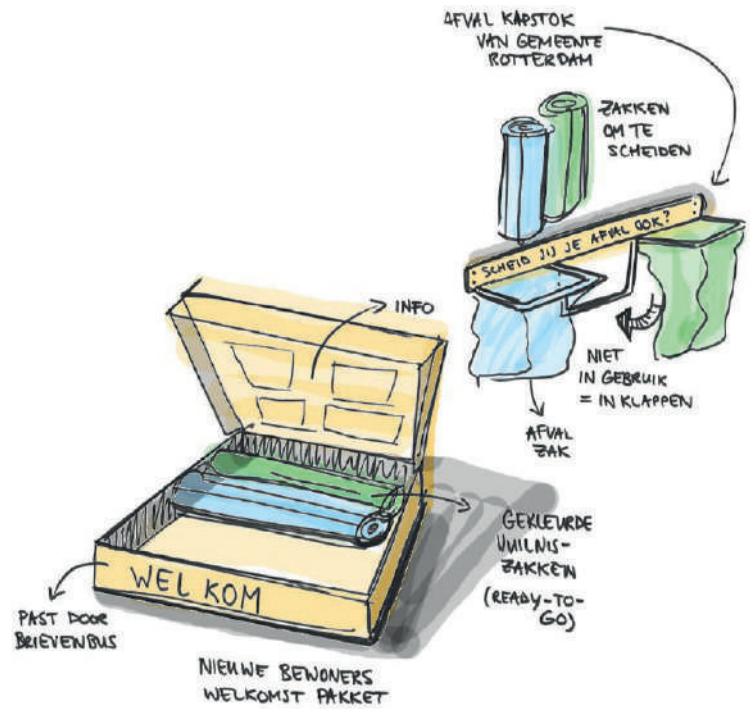
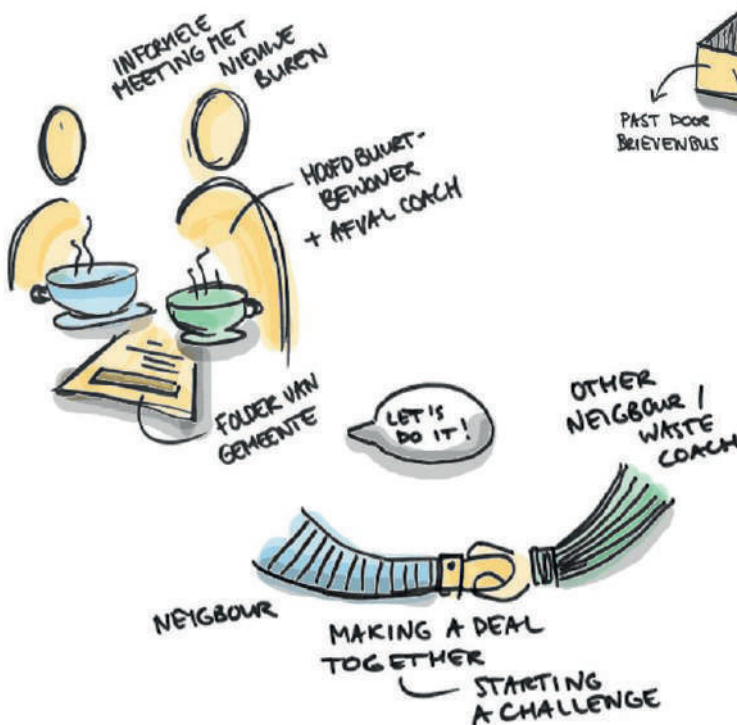

FIGURE A.32
Visualisation of the Welcome box concept idea

Insightful containers

With the insightful container concept, the communal waste containers of high-rise buildings are replaced by containers that have a display indication on top. This indication is visible from inside the high-rise buildings. The top does not only show what kind of waste needs to be disposed of in this container (thereby reminding residents of the different sorts of waste that need to be separated), it also shows a counter. This counter tracks the amount of waste disposed that week, and compares it to past performances. In this way, residents gain insight in the amount of waste they (jointly) generate and separate.

Main strategies:

Visibility, visual reminders, tracking for insight

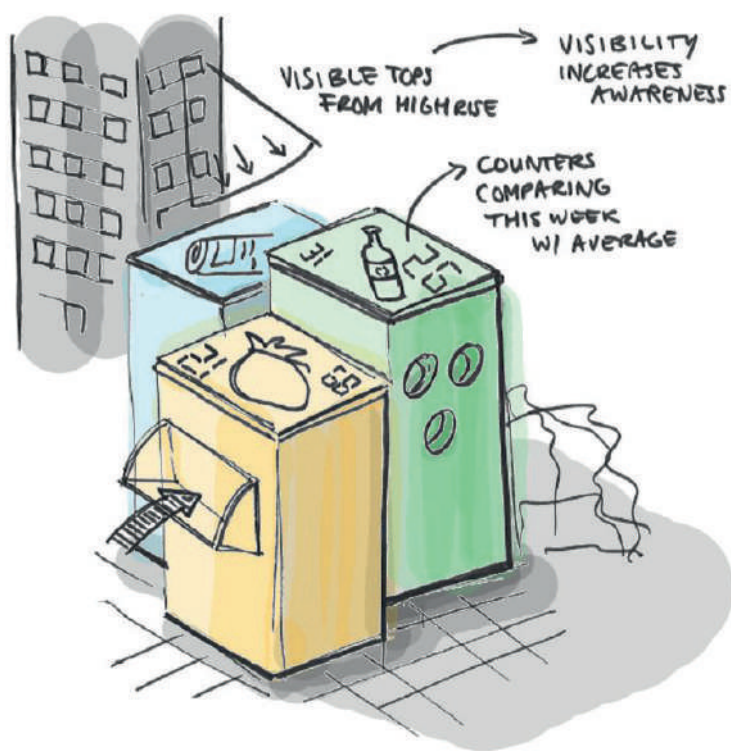

FIGURE A.33

Visualisation of the Insightful containers concept idea

Workshop goal

The goal of the workshop is to evaluate the three different concept ideas (see Appendix P) with high-rise residents, in order to find out for which concept the expected effect is most promising and what concept is most desired by high-rise residents.

Participants

During this workshop, five-rise residents of Rotterdam were present. Two of the participants did also take part in the first workshop (see Appendix J). Two other participating residents do not live in high-rise according to the definition of this project. They live in apartments at the fourth floor (of four-floor building) and the third floor (of four-floor building). However, their municipal waste facilities exist of underground waste containers, which is representative for high-rise residents.

Preparation to the workshop

No preparation for this workshop was needed.

Workshop outline

The workshop itself consisted of five parts. In the first part, the participants introduced themselves to each

other and the outline of the workshop was explained. In the second, third and fourth part followed the same structure. In each of these three parts one of the concept ideas was evaluated according to the IPC method: interesting, plusses, concerns (Tassoul, 2005). Participants used the provided worksheet to individually write down the interesting elements of the concept. Consequently the group jointly discussed these interesting elements. The same approach followed for the positive elements of the concept and the concerns or limitations respectively. In the fifth part, the participants were asked to jointly map the three concepts on a matrix. One axis of the matrix was a scale for how activating the participants evaluated the concept, the other axis represented desirability.

The worksheets used during the workshop are presented at page 63-64. For each worksheet one sheet filled by one of the workshop participants is presented to illustrate the workshop outcomes.

References:

Tassoul, M. (2005). *Creative facilitation: a Delft approach*. VSSD.



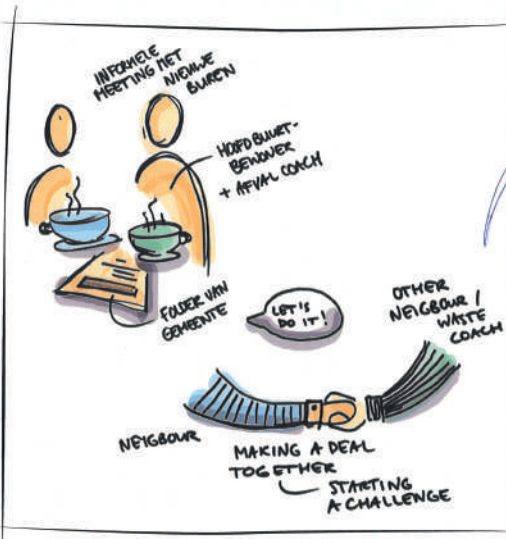

1. WAT VIND JE INTERESSANT AAN DIT IDEE?

- "echte" interactie blijft beter hangen dan een folder. Je kan dan een gezicht achter het doel zien
- stoer achter de deur
- "iemand anders doet het ook"
- iemand om vragen aan te stellen over hoe & wat is ook handig
- challenge creëren geeft ook een doel

4. ZOU DIT IDEE JE HELPEN EEN START TE MAKEN MET JE AFVAL (BETER) TE SCHEIDEN, BIJ EEN VERHUIZING? WAAROM (NIET)?

- Ja
- + je weet hoe je het moet doen
 - + draagt bij aan een groter geheel
 - + misschien is het zelfs een soort eer om in een schone/nette flat te wonen
- Mits
- + in mijn huis ook scheid mogelijkheden zijn
 - + alles makkelijk gemaakt wordt

2. WAT ZIJN DE POSITIEVE KANTEN VAN DIT IDEE?

- + sociaal contact met buren
- + zinvol
- het idee dat anderen het ook doen
- + bagdempelige info
- ff belten als je het niet weet

3. WAT ZIJN DE BEPERKINGEN VAN DIT IDEE?

- gevoel: 'moedergevoel' van een coach
- bemoeienis oid.
- en: misschien hebben mensen geen zin in z'n gesprekje
- "o ja, het "afvalgesprek" moet nog gebeuren"
- cultuur/gewoonte gebrek
- "baan als coach?"

Naam: Maecke

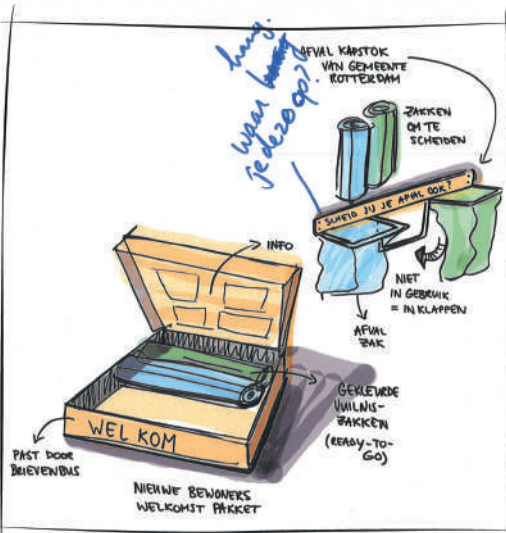

1. WAT VIND JE INTERESSANT AAN DIT IDEE?

- innovatief.
- informatief
- je kan het in je eigen tijd door nemen.
- het wekt de nieuwsgierigheid.
- "Deze doos kan in oud papier", als voorbeeld.

2. WAT ZIJN DE POSITIEVE KANTEN VAN DIT IDEE?

- * Welke interesse.
- * zie 1.
- * zorgt direct voor bewustzijn.
- * je hebt de kans om te "shinen."
- * Gemeente informatie.
- * De producten kunnen heel opvallend zijn en interesse wekken.
- * Prachtige verhuiszaken bezet interesse wekken.

3. WAT ZIJN DE BEPERKINGEN VAN DIT IDEE?

- gekleurde verhuiszaken?
- de afvalseparator zal misschien niet gebruikt worden.
- Ik zie alleen maar kansen, als je de doos maar goed oud wilt hebben!
- Het moet zijn.

Naam: Paul

4. ZOU DIT IDEE JE HELPEN EEN START TE MAKEN MET JE AFVAL (BETER) TE SCHEIDEN, BIJ EEN VERHUIZING? WAAROM (NIET)?

- Zeker.
 - Super mooi pakket.
 - Informatief.
- Waarom niet?:
- geen tijd.
 - aan het slopen/klussen.

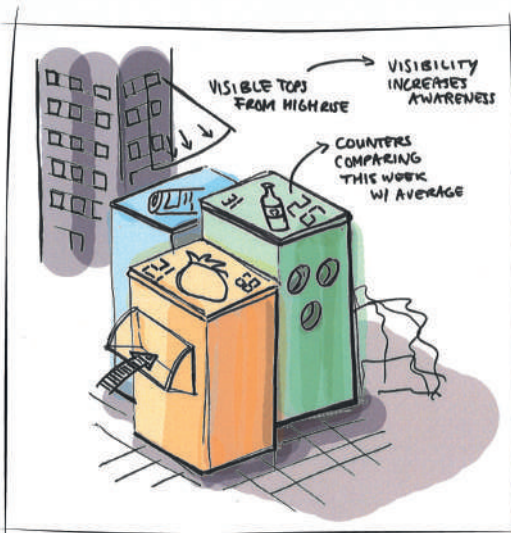

1. WAT VIND JE INTERESSANT AAN DIT IDEE?

- Ven te voren weten dat "de gemeente bak" niet vol zit
- Kleur code?

2. WAT ZIJN DE POSITIEVE KANTEN VAN DIT IDEE?

- gamification
- centrale punten, makkelijk om te began.
- Feedback

3. WAT ZIJN DE BEPERKINGEN VAN DIT IDEE?

- > geen ruimte voor...
- nooit voor iedereen zichtbaar te maken
- niet mooi om op elke straathoek een bak te hebben

4. ZOU DIT IDEE JE HELPEN EEN START TE MAKEN MET JE AFVAL (BETER) TE SCHEIDEN, BIJ EEN VERHUIZING? WAAROM (NIET)?

- niet, huidige system met afval in de flat is aan te trekken
- wel, duidelijk l. alle afval op één plek.

Naam: Thomas

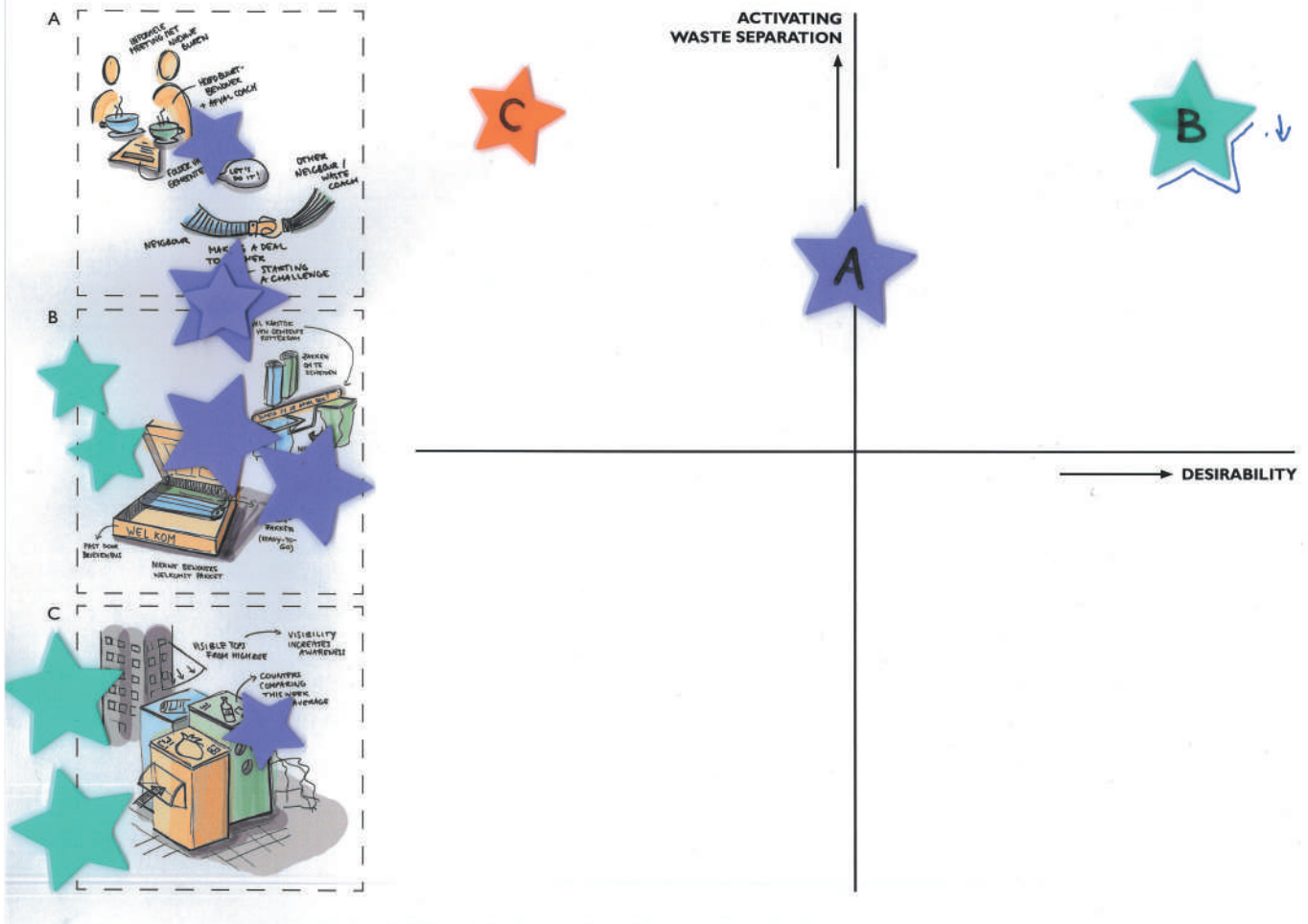

The final solution to the problem definition and the design vision should fit the waste management system in Rotterdam and its stakeholders. The main stakeholders are the City of Rotterdam and the high-rise residents. Therefore the solution should fit the main requirements of those two stakeholders.

Requirements for the City of Rotterdam

For the City of Rotterdam, the main aspects of the solution to take into account are the feasibility and innovativeness. The indicators for these aspects are the following:

Feasibility: the solution is...

- Within the City of Rotterdam's influence
- Economically feasible
- Pilotable
- Scalable
- Using limited (public and underground) space

Innovativeness: the solution is...

- New to the City of Rotterdam
- New to the waste management field in the Netherlands
- Using new technologies
- Adaptive to several stages in the transition towards circular waste management

Requirement for high-rise residents

For the high-rise residents, the main aspects to take into account are how clarifying, activating and supporting the solution is. The clarifying aspect of the solution is important to increase the Ability of residents to separate their household waste. The activating aspect should increase their Opportunity, while the supporting aspect triggers their Motivation. The indicators for these aspects are the following:

Clarifying: the solution is...

- Explaining the expected behaviour (*understandability of the system**)
- Proactively informing (instead of passive information to be found online) (*accessibility of the information**)

Activating: the solution is...

- Facilitating to start household waste separation (*presence of waste facilities**)
- Facilitating source separation in-home (*presence of waste facilities**)
- Lowering the amount of effort needed to start household waste separation (*required effort**)

Supporting: the solution is...

- Facilitating a habit change at the moment of moving (*no priority**)

- Reminding of the desired behaviour (*extra required cognitive effort**)
- Encouraging to try starting in-home waste separation (*negative perceptions**)

*The factors between brackets refer to the influencing factors for waste separation behaviour (see 2.5 Influencing factors for waste separation behaviour).

Individual concept evaluation

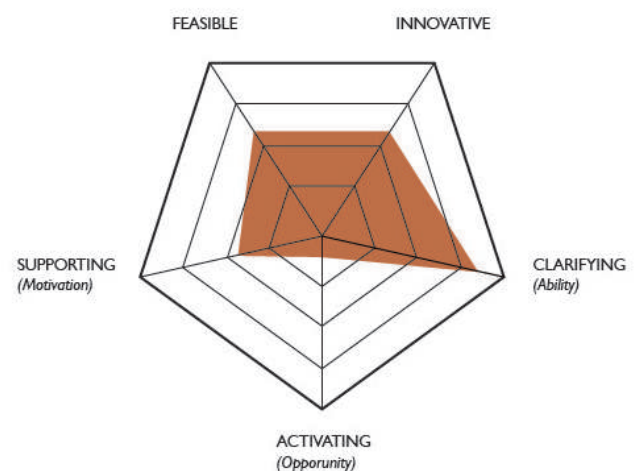

A. Social welcoming

- The concept scores medium on feasibility. It is within the City of Rotterdam's power to take on this concept. Besides, the concept is adaptive to system transitions. However, due to the amount of man hours that needs to be invested, the economic feasibility is medium. Certainly in case of upscaling the concept to city level.
- The concept scores medium on innovativeness. The use of a waste coach is not something new to Rotterdam or the Netherlands and the concept does not make use of innovative technologies. However, the Department of Urban Management evaluates asking for commitment of citizens as new.
- The concept scores high on clarifying. The waste coach informs proactively. Moreover, the personal approach makes it possible to explain in it such way, everyone will understand. It is even possible for citizens to directly ask questions.
- The concept scores low on activating. The waste coach informs, but no facilities to start the desired behaviour are provided. Also, it does not lower the effort to start once the waste coach has left.
- The concept scores medium on supporting. The visit

of the waste coach right after moving supports habit change at the right moment. Asking for commitment creates a certain obligation for citizens to start trying. However, no specific benefits, rewards or reminders for waste separation are present.

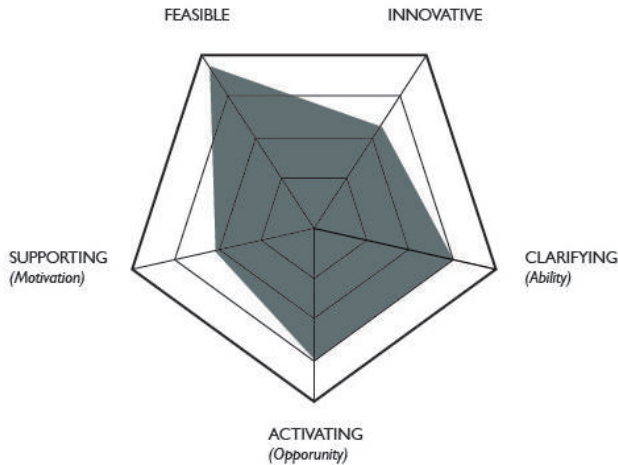

B. Welcome box

- The concept scores high on feasibility. It is within the power of the City of Rotterdam to send packages to their citizens. It is economically feasible, because of the low amount of man hours required and the low investments needed. It is possible to automate sending out the packages. The package is adaptive to system transitions.
- The concept scores medium on innovativeness. The Department of Urban Management does not know any municipalities offering such package to their citizens. However, the level of innovative technologies needed for this concept is low.
- The concept scores medium-high on clarifying. The concept instructs citizens about the systems and actively provides the necessary information.
- The concept scores medium-high on activating. The concept offers facilities to start in-home waste separation right away. Therefore, it lowers the start-up barrier for trying out the waste separation behaviour.
- The concept scores medium on supporting. The concept itself does not provide direct motivation. However, receiving the package shortly after moving, encourages creating a new habit at the right moment. The physical package provides in-home reminders for waste separation.

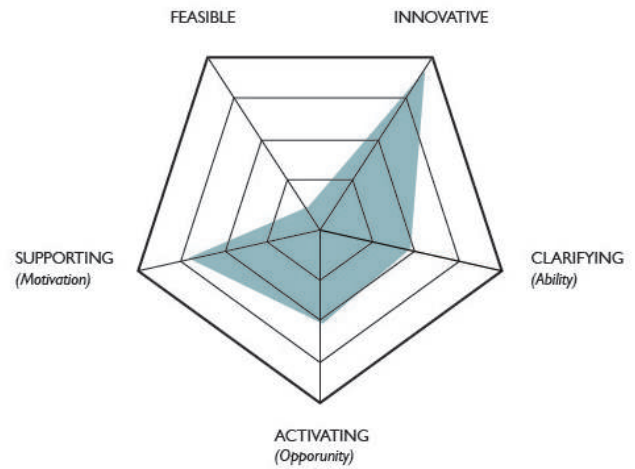

C. Insightful containers

- The concept scores low on feasibility. The concept is in the power of the City of Rotterdam. However, the initial investments for developing this concept are high. In order to upscale this concept, all waste containers in Rotterdam need to be replaced. This is a time consuming and expensive operation. Besides, adapting this concept when system transitions take place will require a lot of resources.
- The concept scores high on innovativeness. The concept makes use of new technologies, such as a sensors to measure the fullness degree of the container. No existing examples of containers displaying past performances are known.
- The concept is medium clarifying. It proactively informs citizens about their performance and the images on top illustrate the fractions that are supposed to be separated. However, all these cues are implicit.
- The concept is medium activating. It facilitates waste separation for high-rise residents. However, the source separation should start in-home. This concept does not support citizens at that moment.
- This concept is medium-high supporting. Providing insight in the amount of waste generated, encourages waste separation. The physical presence, including the indication for different types of waste, remind citizens of their waste separation duty. However, no specific stimulus is given at the moment of moving.

When plotting the spider charts of all three concepts in one figure, the spider chart of Figure A.34 shows. The Insightful containers are highly innovative and supporting, however their feasibility for the City of Rotterdam is low. The social aspect of Social welcoming makes the concept scores the best on clarifying. However, for all other requirements this concept underperforms the Welcome box. The Welcome box scores well over all requirements. The feasibility to develop and implement this concept for the City of Rotterdam, makes the decision.

The high desirability of the Welcome box for both the City of Rotterdam and the high-rise residents, support the plot of this concept in the spider chart.

Figure A.34 The spider charts of the three concepts plotted in one figure

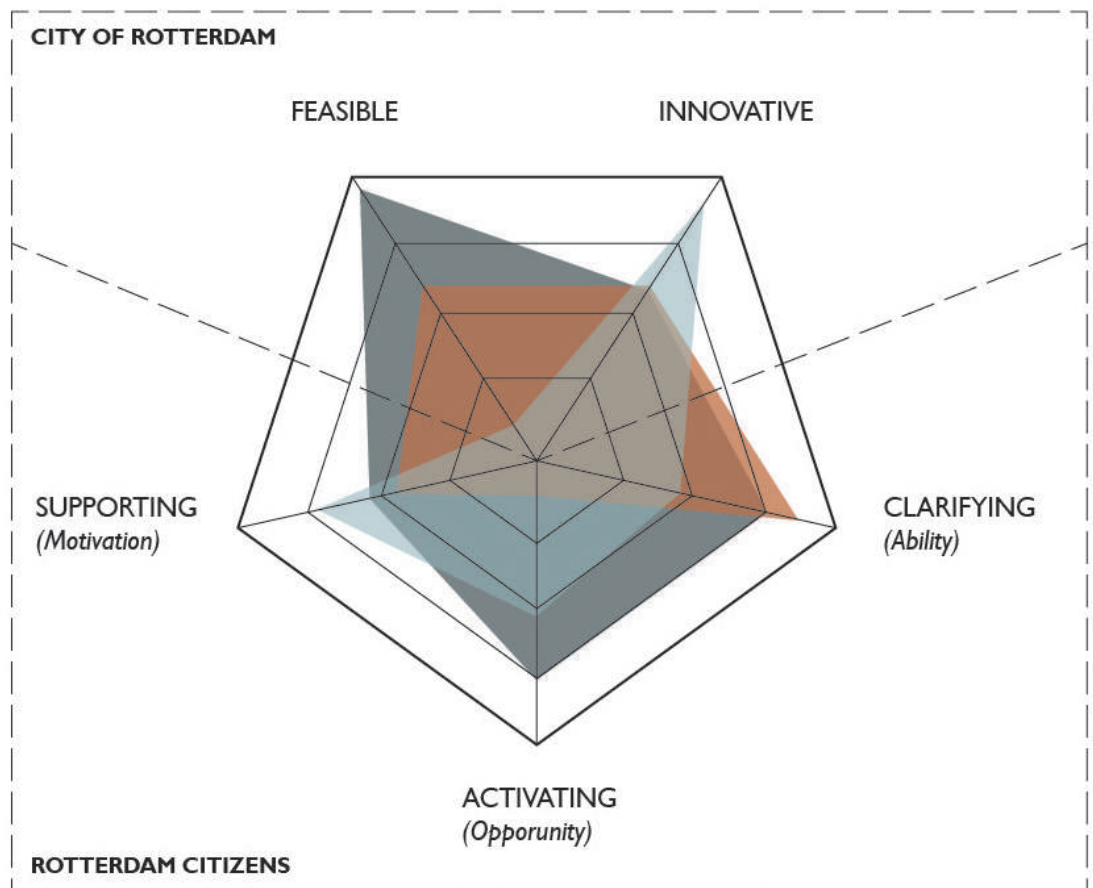

Requirements**Performance**

- The product should inform the user about the household waste collection system in place in the area where the user is living
 - The product should inform the user about the different fractions that need to be separated
 - Daily: glass, paper and cardboard, bio-waste (if applicable), PMD, residual waste
 - Occasionally: textile, KCA, bulky (garden) waste, appliances
 - The product should inform the user about municipal disposal services
 - Locations of containers for collective bring-systems (glass, paper and cardboard, bio-waste, PMD, textile, residual waste)
 - Locations of collection points for personal bring-systems (KCA, bulky (garden) waste, appliances)
 - Service and contact details of municipal collect systems (bulky waste, appliances)
- The information provided by the product is the minimally required information needed to act according to the ambitions of the City of Rotterdam, without having to access other information channels
 - The product should inform the user about existing information channels, for more extensive information
- The product should inform the user about the goal of household waste separation: recycling of valuable materials
- The product should facilitate for the user to start separation of glass, paper and cardboard, bio-waste, textile, KCA, PMD, residual waste for at least a month
- The product should provide personalised information regarding where the closest disposal points are located relative to the address of the receiver

Environment

- The product should prevent from being disposed before being opened

Life in Service

- The product should facilitate the user to separate household waste for at least one month
- It should be possible to preserve the information from the product, for later reference

Maintenance

Not applicable

Target Product Cost

- The production costs per product should not exceed 10 Euros per product
- The production costs for a pilot product should not exceed 25 Euros per product

Transportation

- It should be possible to transport the product per standard post service (e.g., Post NL)
- The product is delivered to the user within one week after the user registered as citizen of Rotterdam via the municipal register

Packaging

- The (packaging of the) product should endure transportation per truck or mini-van

Quantity

- The circulation of the pilot product should be between 100-300 pieces (one time only)
- The circulation of the product should be 20.000-30.000 per year
 - The delivery package should be produced including personalised information per building

Manufacturing facilities

- The production of the product should be outsourced to existing production companies
- The production of the product should make use of existing production methods

Size and weight

- The product should fit through a standard letter box
 - Maximum size of the product is 380x265x32mm
- The product should weigh a maximum of 2 kg

Aesthetic, appearance and finish

- The product should contain the logo of the City of Rotterdam
- The product should contain the logo of Rotterdam Circulair
- The product should communicate consistently (colours, icons, visual language) with other information provided by the City of Rotterdam regarding household waste management

Materials

- The different materials of the product are separable from each other for disposal
 - No glue is used in assembling the product

Standards

Not applicable

Ergonomics

- The product communicates in the Dutch language
- The language use in the product is according to level B1
- The product can be opened without usage of external tools
- The product is initially perceived as a (free) present, not as rules opposed by the City of Rotterdam

Quality and reliability

- It should be possible to update the product when waste management services of the City of Rotterdam change
 - E.g., the amount of fractions that need to be separated at the source by citizens

Testing

- It should be possible to perform a pilot test with the product, over a period of 6 months for a user group size of 100-300 households

Safety

- The product should not contain loose parts that can be swallowed by young children

Product policy

Not applicable

Social and political implications

- The product should make users aware of the circular possibilities of household waste streams

Product liability

Not applicable

Installation, operation

- No specific products or tools are needed for the user to install the product or take the product into operation

Re-use, recycling, disposal

- The product should indicate how the (different parts of) the product should be disposed by the user (for recycling)

Wishes**Materials**

- Materials used for production of the product are recycled material where possible
- The necessary amount of materials for producing the product is limited

**Based on Pugh's checklist*

Material: 1,5 mm corrugated cardboard

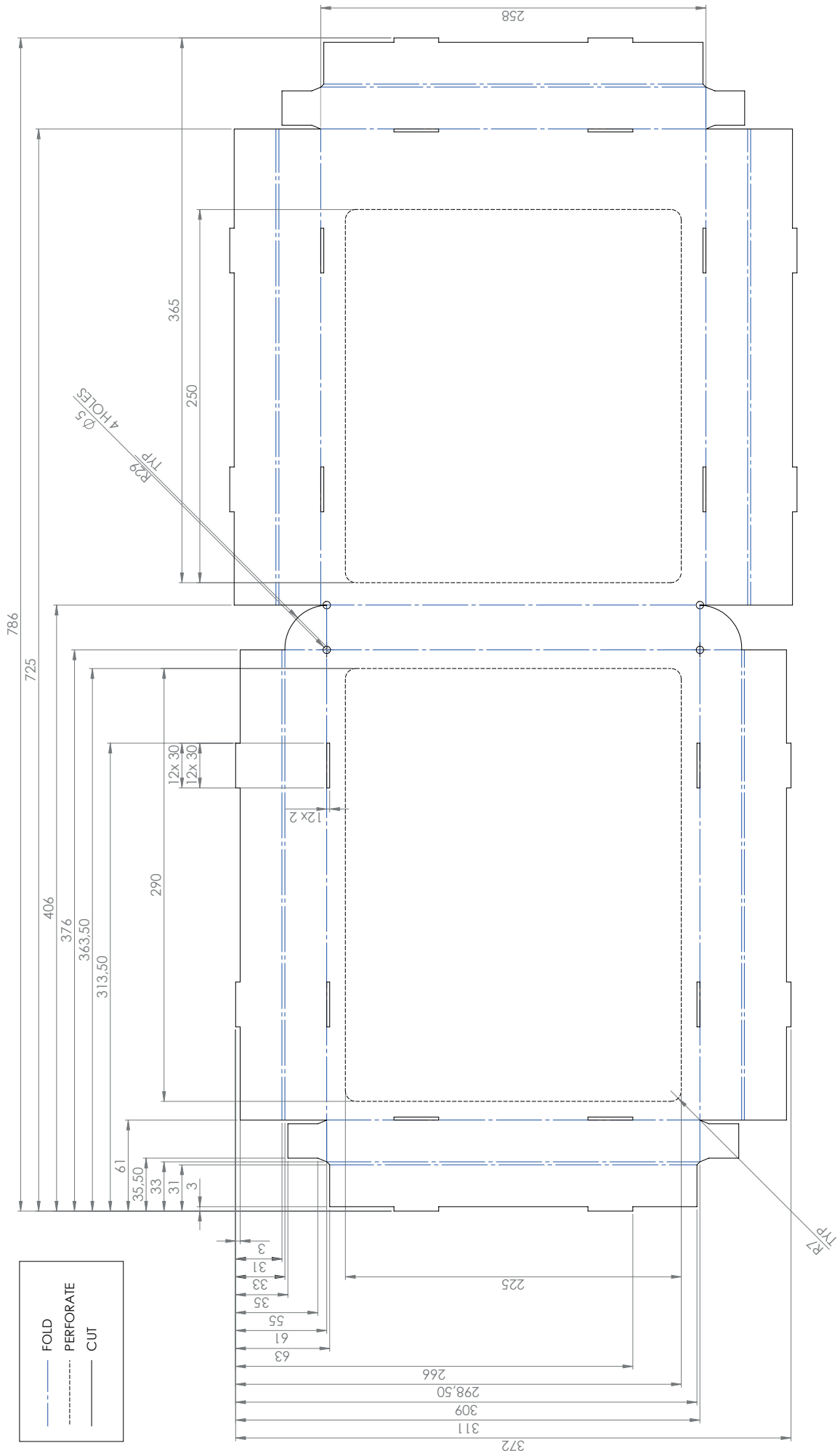

The development of the final product started with an exploration into the possible forms the concept could take. For inspiration, existing products are analysed online and by means of a field trip to IKEA. This results in four product collages and photos of inspiring products.

IKEA

IKEA products are smart designed regarding storage and shipping. Hanging and folding options are explored

Collages See pages 72-75.









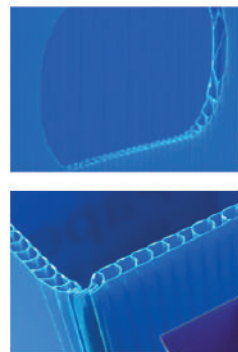

Paper prototyping has been carried out, in order to explore and test different product ideas in 3D. An overview of different (paper) models is presented below.



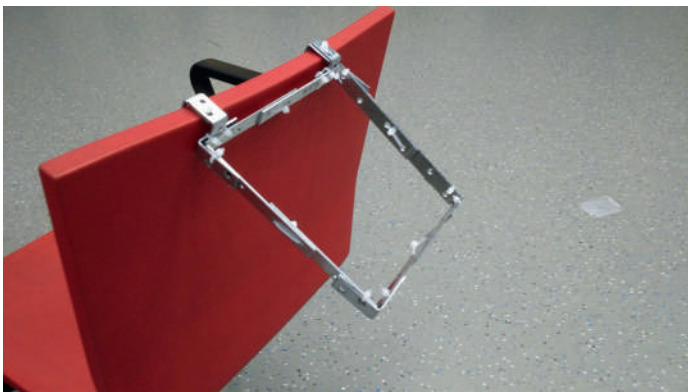
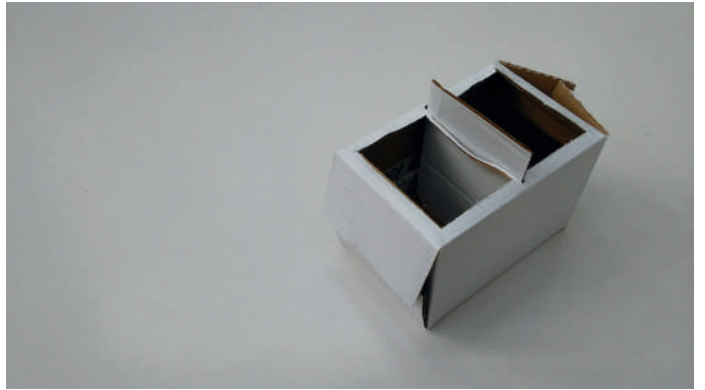
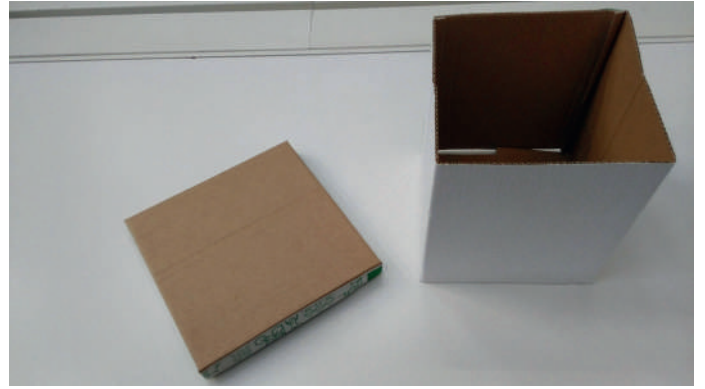

To optimise the content of *Schone start* four concept variations are created. The packages vary with respect to product content. All variations fit in a box of maximum 310x250x28mm (within the maximum dimensions for mailbox delivery).



Different garbage bags

Package consisting of several garbage bags, to be used to separate different waste fractions in home.



Textile bags + labels

Package consisting of three differently sized textile garbagebins. Labels can be used to create a waste separation system



Delivery package (mailbox size)

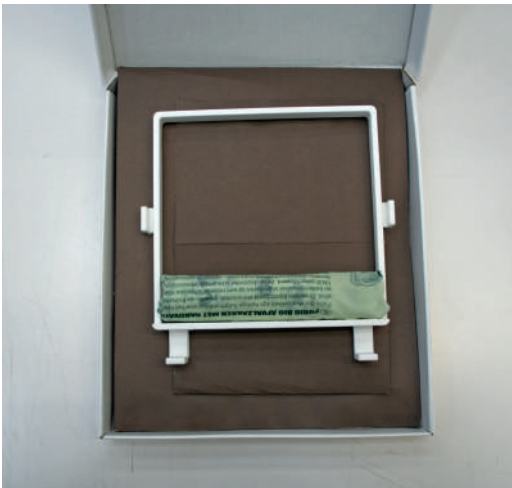

Bag holder + boxes

Package consisting of a bag holder and two foldable boxes. One small sized and one A4 sized box. Including biodegradable bags.



Fraction Stickers

Package consisting of coloured stickers per waste fraction, including information about what waste belongs to what fraction.



I. Different garbage bags

Package consisting of several garbage bags, to be used to separate different waste fractions in home.

Disposable plastic bags are included for residual waste, PMD and GFE (bio-waste bags of biodegradable plastic). Paper bags are included for paper and cardboard, a textile bag for textile collection and a reusable shopper for glass. Additionally, there are small plastic bags for KCA (small chemical waste).



2. Textile bags + labels

Package consisting of three differently sized textile garbagebins. Labels can be used to create a waste separation system.

The bags have loops, and hooks are included, so they can be hung at several different locations.



Intended use



3. Bag holder + boxes

Package consisting of a bag holder and two foldable boxes. One small sized and one A4 sized box. Including biodegradable bags.

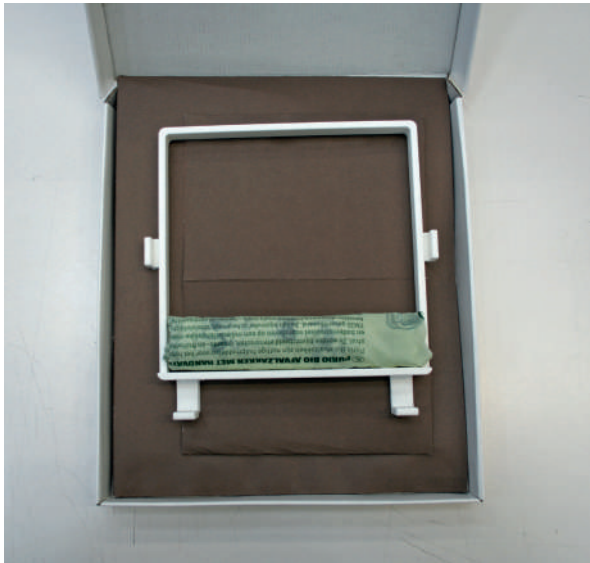

Intended use



4. Fraction stickers

Package consisting of coloured stickers per waste fraction, including information about what waste belongs to what fraction.

Next to the stickers, the package contains a flyer with example pictures on how to use the stickers. For example, on cardboard boxes, grocery bags, kitchen boxes or bins.



Intended use







Leaflet

For the user test, all four concept variation boxes contain this leaflet, stating the different waste streams that are separated by the City of Rotterdam. The text in the bottom states the products that the user receive, to make waste separation easier.

HIER IN ROTTERDAM

SCHEIDEN WIJ:

 GFE	 PMD	 oud PAPIER
 GLAS	 TEXTIEL	 KCA
 REST		

HELP JIJ HIERAAN MEE?

Om het voor jou makkelijker te maken je afval gescheiden weg te gooien, krijg je deze verschillende vuilniszakken.

The four concept variations are evaluated by four Rotterdam residents. They all received one concept variation to try out at home for a week. They live on third and fourth floor (of a four floor building); the fourth floor (of a four floor building); the first floor (of a three floor building); and the third floor (of a four floor building).

The test users evaluated the concept with five Likert point scales. See results presented below. Next to that, a one hour focus group session provided qualitative insights. The focus group consisted of three parts. In the

first parts the users introduced their concept variation to each other and explained how they used it and what they thought about it. In the second part the users discussed what information they would like to see complementary to the products. In the final part, all users explained what their optimal package would look like.

Statements about your evaluation of the product

1. The product was helpful in supporting me with separating my household waste

Totally disagree 1 2 3 4 5 6 7 *Totally agree*

2. The product was encouraging me to separate my household waste

Totally disagree 1 2 3 4 5 6 7 *Totally agree*

3. The product was reminding me to separate my household waste

Totally disagree 1 2 3 4 5 6 7 *Totally agree*

4. The product was facilitating me to separate my household waste

Totally disagree 1 2 3 4 5 6 7 *Totally agree*

5. I separated my household waste better, because of the product

Totally disagree 1 2 3 4 5 6 7 *Totally agree*

— 1. Different garbage bags

— 3. Bag holder + boxes

— 2. Textile bags

— 4. Stickers

Insights

- All users positively evaluated receiving the product, as receiving a present.
- Mainly products complementary to the users' current in-home waste management system are used (e.g., for separation of biowaste or PMD). The standard garbage bags were not used.
- Several of the users remarked they did not (exactly) know how to use the product, as no instructions were provided.
- Several of the users mentioned problems with remembering they had to separate their waste. Only when the alternative to the residual waste bin was highly visible, it served as a reminder. One of the users mentioned 75% of the biowaste still ended up with residual waste. However, another user mentioned how waste separation already became more of a habit at the end of the week.
- One of the users mentioned starting waste separation in this try-out week provided a positive feeling.
- One user mentioned that even with the separation guidelines, for some waste it was still hard to decide in what bin to dispose of it. More information was desired (e.g., about what waste does not belong to a particular fraction).
- Not all users understood the impact of waste separation. More insight in the impact of waste separation was desired by some. One user would like to receive feedback after a while, about what the effect of the product is.
- One of the users was interested to receive a (complete) separation bin for free trial. However, another user would like to use her own bins.
- The delivery package was useless to the users. It was mentioned it was too big to keep. None of the users threw away parts of the product or the box. Assumed is this is due to agreeing to receive this test package for a week and having the intention to give it back after the test.
- One of the users mentioned how the product stimulated her to start waste separation. She mentioned it really worked for her, because she already thought about waste separation before. She doubted whether this would work for everyone.
- The stickers were not only placed at the waste collection product (e.g., box, bin or crate) used, but sometimes at eyeheight for better readability.

Conclusions

- The delivery package fits through the mailbox of the users.
- Only stickers or garbage bags did not facilitate waste separation enough. The users still had to find out how to separate their waste or where to hang the bag. Waste collection product, such as the small bin or bags, are desired. However, the large textile bag was too large.
- Stickers were found useful. Flexible in use and providing the possibility to temporarily remind yourself about the separation guidelines (until you do not need this information anymore).
- The users needed more information on how to use the products. Being told how to do it was not desired, as some adaptability to personal preferences was preferred. Usage suggestions would be appreciated.
- A poster or information sheet with an overview of what to separate would be helpful. References to informative sources can serve highly motivated and interested users.
- Insight in the system, process or impact of waste separation can offer an extra stimulus to start using the product.
- Follow-up regarding the package is desired (e.g., in the form of the possibility to order refills or to order other waste separation products)

Photos

See page 86-87 for photos the users took during their test week.

1. Different garbage bags



2. Textile bags + labels



3. Bag holder + boxes



4. Stickers



Package through mailbox



Small waste bin
Material: 0,8 mm PP foil

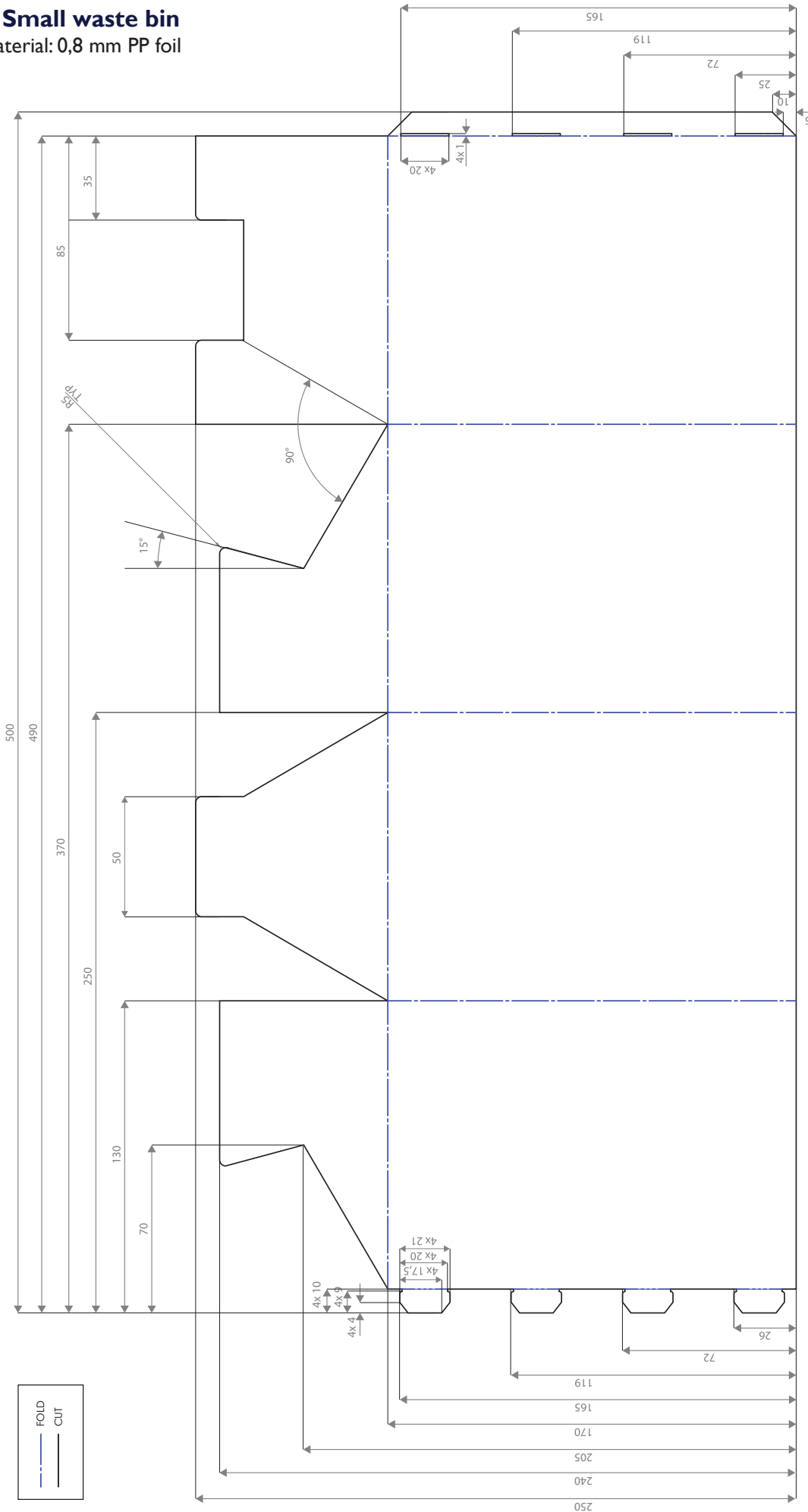

Medium waste bag

Material: 100% cotton

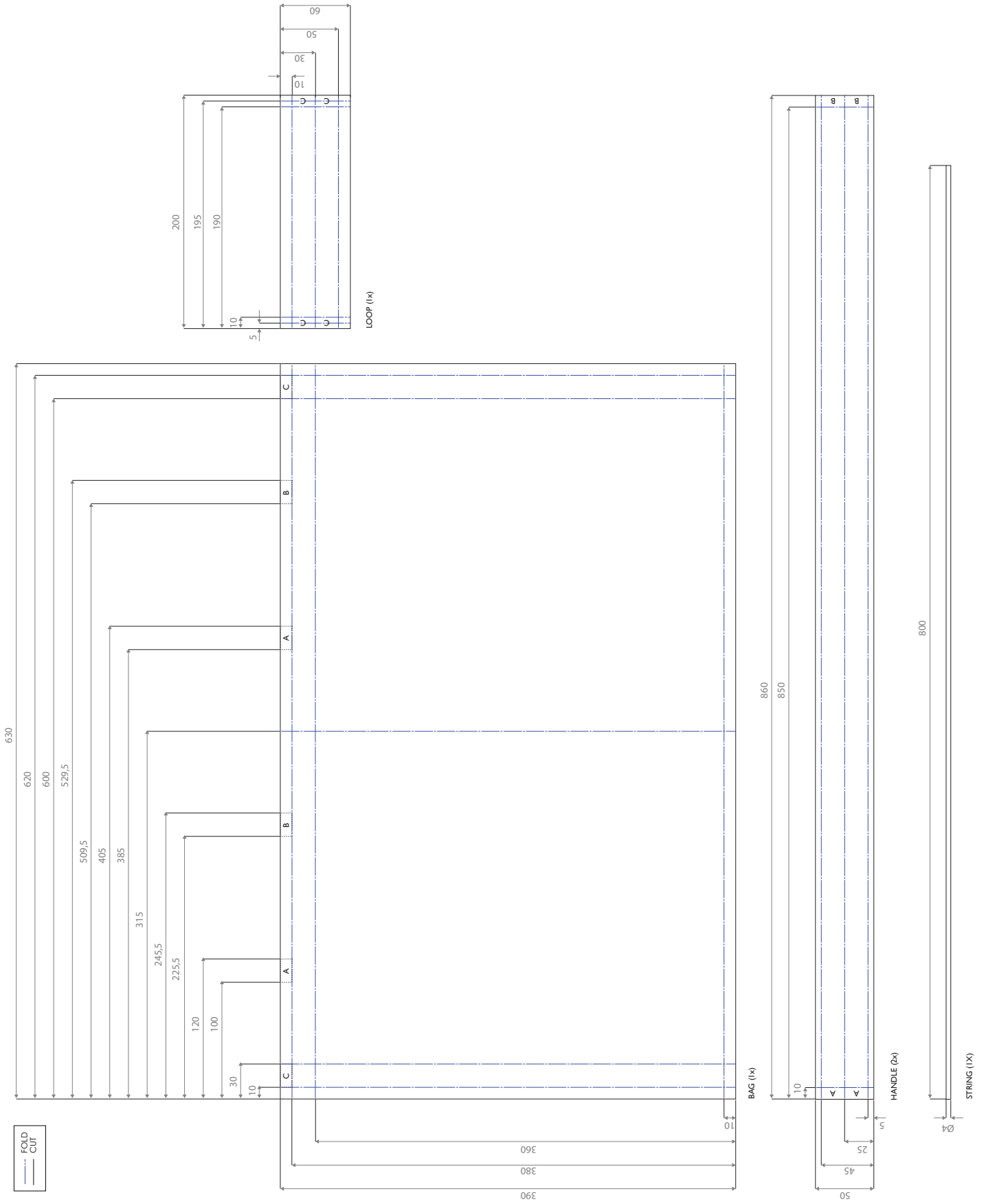

Large waste box

Material: 2,5 mm corrugated cardboard

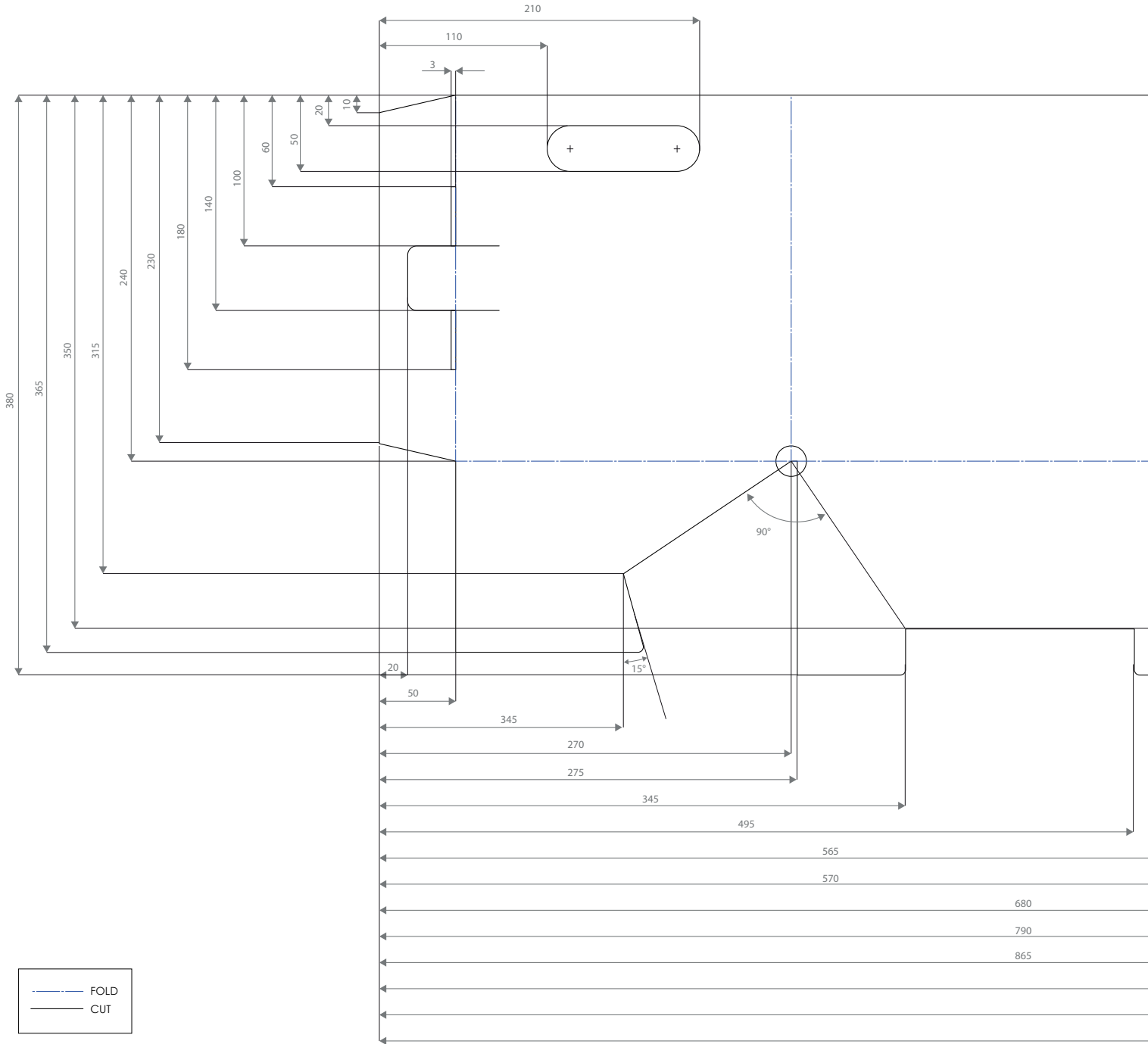

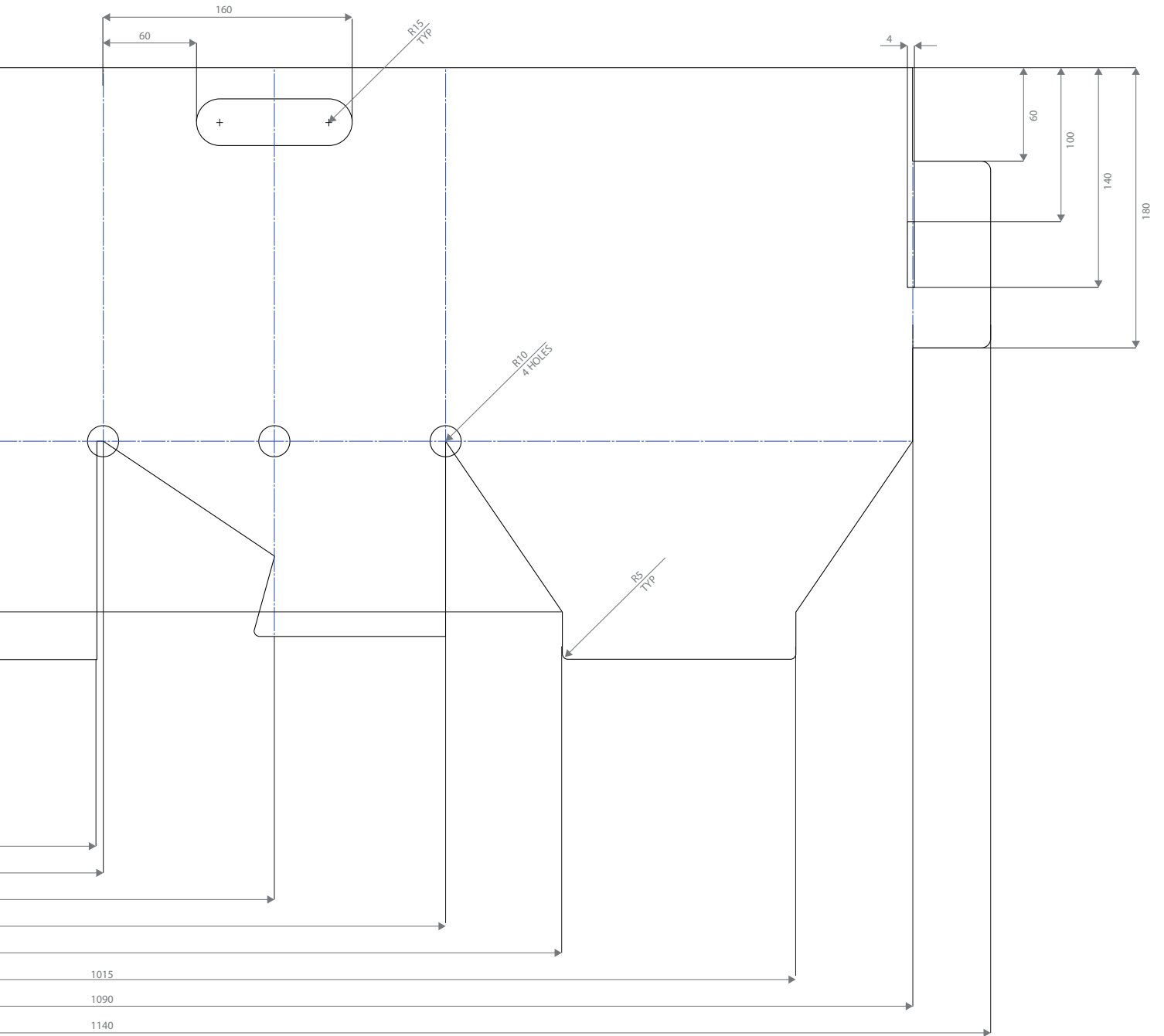

Side closure

The small waste bin is made out of PP foil of 0,8 mm thickness. In order to ensure it can be folded in shape without the use of glue or additional connectors, a form fit of the material itself is designed.

Figure A.35 shows variations in form fitting design. The forms vary based on shape and width of the flaps (by equal with of the slot). Initial test with the form fittings out of Vikureen (PS) failed, due to the material properties of PS. The material is too brittle and breaks when folding. Second tests are performed with 0,8 mm PP foil. The best form fit is achieved when the flap is slightly larger than the slot, which prevents the flap from sliding out after closing (Figure A.35-2). The form fittings are already closed when the user receives the bin. The bottom is not yet folded, so the bin can be folded flat in the delivery package.

Bottom closure

The bottom of the bin closes by means of a snap lock bottom. Design standards for designing this closure can be found in Figure A.36. The bottom should be folded together by the user. Instructions for closing a snap lock bottom are visualised in the instructions that come with the package (Appendix EE).

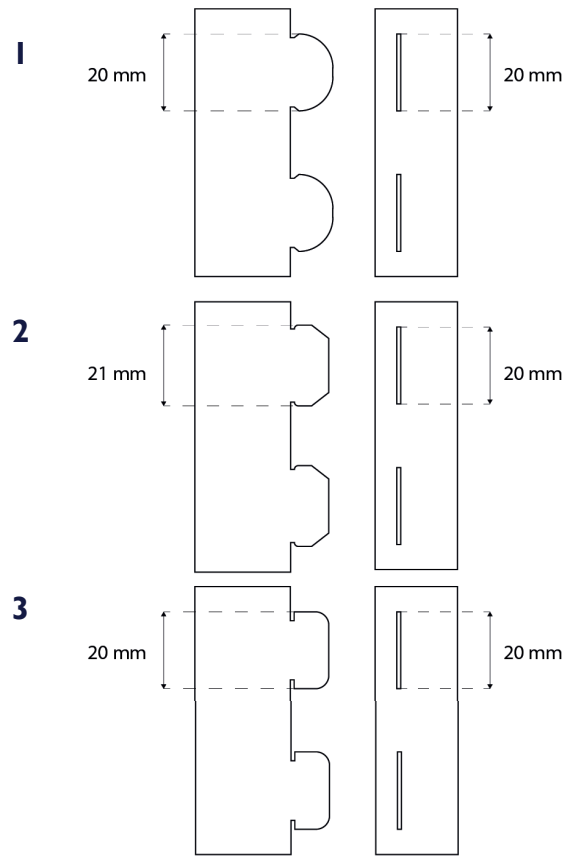

Figure A.35 Form fitting shape variations

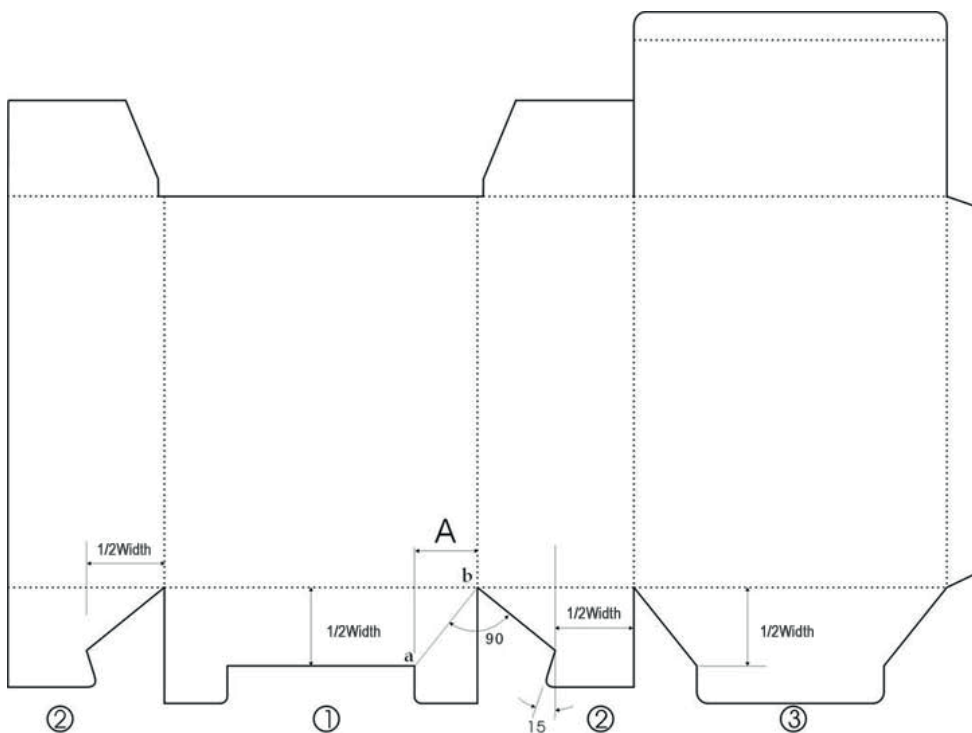

Figure A.36 Design standard for designing a snap lock bottom (Image source: DE printed box)

Side closure

The large waste box is made out of corrugated cardboard with a thickness of 2,5 mm. In order to ensure it can be folded in shape without the use of glue or additional connectors, a form fit of the material itself is designed.

Initially the same type of form fittings as for the small waste bin were used (see Figure A.37). However, cardboard is less dimensionally stable, as the flaps easily crook and bend. Next to that, the form fitting should be closed by the user him/herself to make foldability of the waste box to delivery package size possible. A design with five tiny flaps asks for patience and precision to close. Both reasons ask for a larger form fitting that is easier to operate.

Figure A.39 and A.40 show an existing packaging with a tuck top with reverse tuck flap. With this type of closure, the first tuck flap is hold in place by a second. For the large waste box, only one closure is enough. The large size of the closure helps users to easily close the box themselves. Figure A.38 shows the final closure of the box.

Bottom closure

Like the small waste bin, the large waste box contains a snap lock bottom (Appendix AA).



Figure A.37 First form fit closure, comparable to small waste bin



Figure A.38 Final closure with tuck flaps



Figure A.39 Tuck top with reverse tuck flap in existing packaging (tuck flap pulled back)



Figure A.40 Tuck top with reverse tuck flap in existing packaging (closed)

Number of new high-rise households a year in Rotterdam

Schone start is being sent to recently moved high-rise residents in Rotterdam. Per year around 28.000 households move into high-rise buildings in Rotterdam.

This estimation is made according to the following calculation: In 2017, 47.404 people moved within the city of Rotterdam and 27.116 people moved to Rotterdam (from outside the city) (CBS Statline, 2018a). This forms a total of 74.520 people moving to or in Rotterdam per year. 75% of Rotterdam's citizens live in live in buildings without private front door at street level (Gemeente Rotterdam, 2018). This means 55.890 of the 74.520 moving people move to high-rise buildings. Only one package needs to be send to each household upon moving. The average household size in 2017 in Rotterdam is 2 persons (CBS Statline, 2018b). This results in 27.945 new high-rise households per year or 2.329 new high-rise households per month.

Cost estimation per product

The cost estimation results is a cost of €6,00 per product (see Table A.1). The cost estimation is based on ordering a batch of 2000-2500 products per month. Die cutting is a relatively affordable production technique, as investments for customized die cutting knives are low (especially when divided over a large batch). Cardboard and PP foil are low-costs materials. Many companies exist that combine printing and die cutting (of cardboard and plastics). This makes it possible to produce the product almost entirely at one supplier for tailed price arrangements (expect for the medium sized textile bag). In this way, the customized product can be produced low-cost. For estimation of the product costs, the investments for further design and development of the product are not taken into account.

Cost strategy

In case the City of Rotterdam starts supplying *Schone start* for all recently moved high-rise residents in Rotterdam, this will lead to an investment of €168.000 (= 28.000 * €6,00) per year for production of the product. The step before making this investment would be carrying out a small scale pilot of around 100 households (see 8.2 Product implementation). The production costs for a batch of 100 products will be €16-18,- per product (see Table A.2). To save costs (for customized tools) it can be decided to replace parts of the product with standard purchase parts (such as a type, size or model of box or bag that can be directly ordered).

The production costs for 100 pilot products will be around €15,00-17,00 per piece. This results in a total of €1500-1700 product costs for the pilot product. Together with additional pilot costs (such as man hours and logistics) this will fit well within €10.000, which is a decent amount for a pilot study, according to the City of Rotterdam.

Based on the outcomes of the pilot the City of Rotterdam can decide to make the larger investment for upscaling of the pilot. This investment then can be justified by the effect of the product. More household waste separation leads to an increase of material recycling and a cut in incineration costs. Besides, the public awareness for waste separation can be a valuable effect.

References

Automatic Arts (2019). *Die cutting*. Retrieved April 9, 2019 from <http://www.automatic-arts.com/die-cutting>

CBS Statline (2018a). *Verhuisde personen; binnen gemeenten, tussen gemeenten, regio*. Retrieved February 11, 2019 from <https://statline.cbs.nl/Statweb/publication/?DM=SLNL&PA=60048ned&DI=0-9,12-18,81-87&D2=649&D3=2,7,12,27-29&HDR=G2&STB=G1,T&VW=T>

CBS Statline (2018b). *Huishoudens; samenstelling, grootte, regio, 1 januari*. Retrieved February 11, 2019 from <https://statline.cbs.nl/StatWeb/publication/?VW=T&DM=SLNL&PA=71486NED&DI=0-2,23-26&D2=0&D3=1-670&D4=1&HD=100427-1520&HDR=T,G3&STB=G1,G2>

Gemeente Rotterdam (2018). *Pilot circular wastemanagement high rise building Rotterdam*. Presentation, Rotterdam.

Grafisch Centrum Van der Louw (n.d.). *Doosjes op maat gemaakt, bedrukt of onbedrukt*. Retrieved April 9, 2019 from <https://www.verpakkingenbedrukken.nl/doosjes>

Table A.1: Production cost estimation for a batch of 2000

Product part	Costs	Material and production	Remarks	Reference products
Delivery package (incl. double sided full colour print)	€1,75-2,00	Die cutting out of corrugated cardboard, which is full colour printed on both sides. The price for customized die cutting knives varies from €175-350 (Grafisch Centrum Van der Louw, n.d.) Which is less than €0,18 per box for a batch of 2000.	Full colour customized <i>printing on both sides adds in price compared to the reference products. However, the circulation for the City of Rotterdam will be large enough to make agreements with suppliers to create a fully customized delivery package.</i> <i>Prices are based on a batch of 2000 of the same delivery packages. In case of personalized maps the batch size for the same print may decrease to 10 or less. This will add around €5,00 per product, depending on the exact agreements with the printing company.</i>	<ul style="list-style-type: none"> 1000 post delivery boxes full colour printed on one side for €1,75 p.p. (Leoprinting.nl). Price for larger circulation upon request 2500 delivery boxes full colour printed one side for €1,29 p.p. (Packhelp.com) 2000+ delivery boxes colour printed within limited printing area for €1,04 p.p. (Doosopmaat.nl)
Large waste box	€0,50-1,00	Die cutting out of (brown, unprinted) corrugated cardboard. Customized die cutting knives are available for €175-350 (Grafisch Centrum Van der Louw). Cutting costs around €0,20-0,90 per piece, depending on the material, size and quantity (Automatic Arts, 2019).	<i>Production of the large waste box will have a lower price than the delivery package, as no (two sided full colour) printing is needed.</i> <i>Compared to the (standard) reference products, the extra investment to be made is the customised die cutting knife. This is a low investment of around €0,18 per box.</i>	<ul style="list-style-type: none"> Customized die cutting of 3000 flyers, including production of customized die cutting knife (€375) for €0,18 p.p. (Drukland.nl/drukwerk-stansen) Twentsche Dozencentrale offers standard cardboard boxes in a price range of €0,17-0,68. Batches of >1000 offer economical advantages (Dozencentrale.nl)
Medium waste bag	€0,50-1,50	Sewed bag out of cotton sheets. For customized bags, no investments in products tools need to be made. Based on the design, the pattern of the bag is cut out of cotton sheets and sewed together.	<i>Compared to the reference products, the medium waste bag differs in the cut-out pattern of the textile. This means employees of the production company need more time for the production of the first batch, as they need to get acquainted with the new bag model. This will result in higher costs.</i>	<ul style="list-style-type: none"> 2000 cotton bags with handles and rope closure for €1,64 p.p. (Tassen.nl, Article number 19 2405) 2500 cotton bags with rope closure for €0,52 p.p. (Ecobos.org, Article number 17036 (61-602))
Small waste bin	€0,50-1,00	Die cutting out of Polypropylene (PP) foil. The production of the small waste bin is similar to the production of the large waste box. The difference is the material used. PP is a low cost material. The smaller size of the box compensates for the higher material costs compared to corrugated cardboard.	<i>The production of 2000 pieces adds in costs compared to ordering 10.000 of the reference products.</i>	<ul style="list-style-type: none"> 10.000 PP packaging boxes fabricated in China for €0,12-0,31 (Shenzhen Guoshengyuan Packaging Products Co., Ltd via https://clearbox.manufacturer.globalsources.com/si/6008843239610/pdt/Plastic-favor/1164184100/PP-gift-packaging-box-acetate-box.htm) 10.000 PP packaging boxes fabricated in China for €0,22-0,43 p.p (Weiku.com http://www.weiku.com/products/14059754/Recycled_Foldable_Frosted_PP_Promotional_Packaging_Box.html)
Instruction flyer	€0,05-€0,10	The flyer is full colour printed (on both sides) on sheets of paper and folded in half.	<i>The folded flyer is a standard product. Many printing companies are available offering printing services at low costs.</i>	<ul style="list-style-type: none"> 2500 flyers A5 Vistaprint for €224,79 (Vistaprint.nl) 2500 flyers A5 Drukzo for €89,95 (Drukzo.nl) 2500 flyers A5 Drukwerkdeal for €92,40 (Drukwerkdeal.nl)
Stickers	€0,10-0,50	A sheet of stickers is full colour printed with the waste icons of the City of Rotterdam	<i>Sticker sheets are a standard product. Many printing companies are available offering printing services at low costs.</i>	<ul style="list-style-type: none"> 5000 round stickers (45 mm) for €146,50 (Stickerkoning.nl). €0,23 per 8 stickers. Per sheet of 8 stickers for €0,65 or on a roll of 16.000 stickers for €164,52 (€0,08 per 8 stickers) (Sticker.nl)
Post delivery	€3,90			<ul style="list-style-type: none"> Post NL (https://www.postnl.nl/tarieven)
Total	€3,40-6,10 €7,30-10,00		<i>Excl. delivery</i> <i>Incl. delivery</i>	

Table A.2: Production cost estimation for a pilot batch of 100

Product part	Costs	Reference products
Delivery package (incl. double sided full colour print)	€5,00-7,00	<ul style="list-style-type: none"> 125 post delivery boxes full colour printed on one side for €5,17 p.p. (Leoprinting.nl). 100 delivery boxes full colour printed one side for €5,63 p.p. (Packhelp.com)
Large waste box (brown cardboard)	€2,50-4,50	<ul style="list-style-type: none"> Twentsche Dozencentrale offers standard cardboard boxes in a price range of €0,35-1,00. (Dozencentrale.nl) Additional costs of around €1,75-3,50 per box for a customised die cutting knife needs to be added Alternatively, the boxes can be lasercut out of corrugated cardboard to save investment costs for a customised die cutting knife
Medium waste bag (textile)	€1,00-1,50	<ul style="list-style-type: none"> 100 cotton bags with rope closure for €0,90 p.p. (Ecobos.org, Article number 17035 (61-603))
Small waste bin (PP)	€2,00-2,50	<ul style="list-style-type: none"> The product can be lasercut out of PP foil, in order to save investment costs for a customised die cutting knife PP foil sheets with a surface area large enough to produce four bins are available at Kunststofshop.nl for €6,95 per piece. Asking quotations at several companies for min. 25 sheets offers economical advantages
Instruction flyer	€0,30-0,95	<ul style="list-style-type: none"> 100 flyers A5 Vistaprint for €96,45 (Vistaprint.nl) 100 flyers A5 Drukzo for €37,95 (Drukzo.nl) 100 flyers A5 Drukwerkdeal for €29,40 (Drukwerkdeal.nl)
Stickers	€0,50-1,00	<ul style="list-style-type: none"> Per sheet of 8 stickers for €0,93 (Sticker.nl) Per sheet of 8 stickers for €0,50 (Stickerkoning.nl)
Post delivery	€3,90	<ul style="list-style-type: none"> Post NL (https://www.postnl.nl/tarieven)
Total	€11,30-17,45 €15,20-21,35	<i>Excl. post delivery</i> <i>Incl. post delivery</i>

The City of Rotterdam and other organisations for waste recycling provide digital maps to look up disposal points based on postcode or address. However, citizens need to consult over four different maps in order to find out

where the municipal waste containers, recycle points for KCA (batteries, lamps, small appliances), second-hand shops and environmental parks are located.

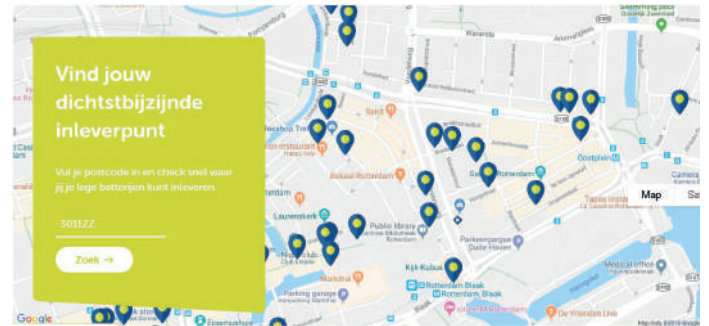
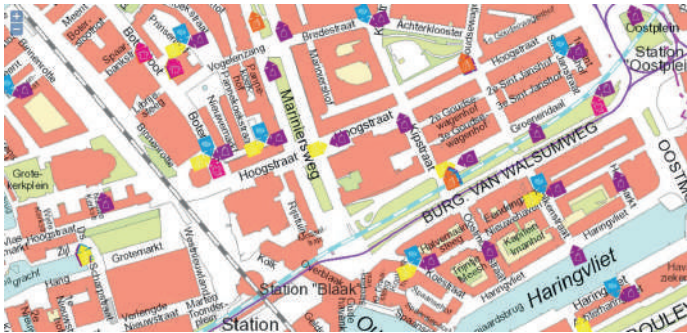

Locations of municipal waste containers via <http://afvalkalender.container-beheer.nl>

Locations for disposal of empty batteries via <https://www.legebatterijen.nl/inleveren/waar-inleveren/>

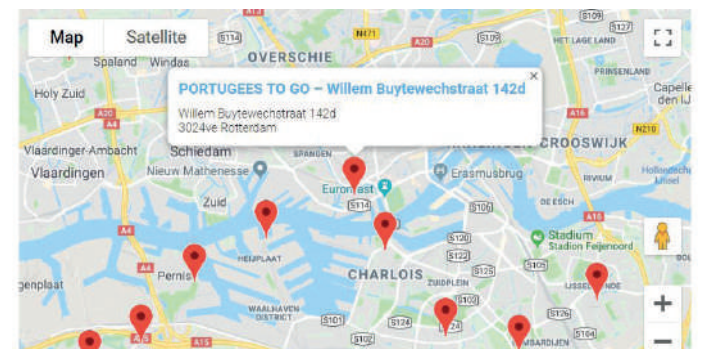
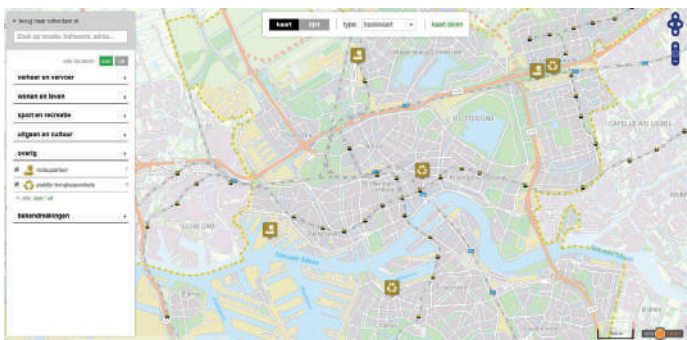

Locations of Piekfijn second-hand shops and Environmental parks via <https://maps.rotterdam.nl/>

Locations for disposal of (frying) oil via <http://www.frituurvetrecyclehet.nl/waar-inleveren/>

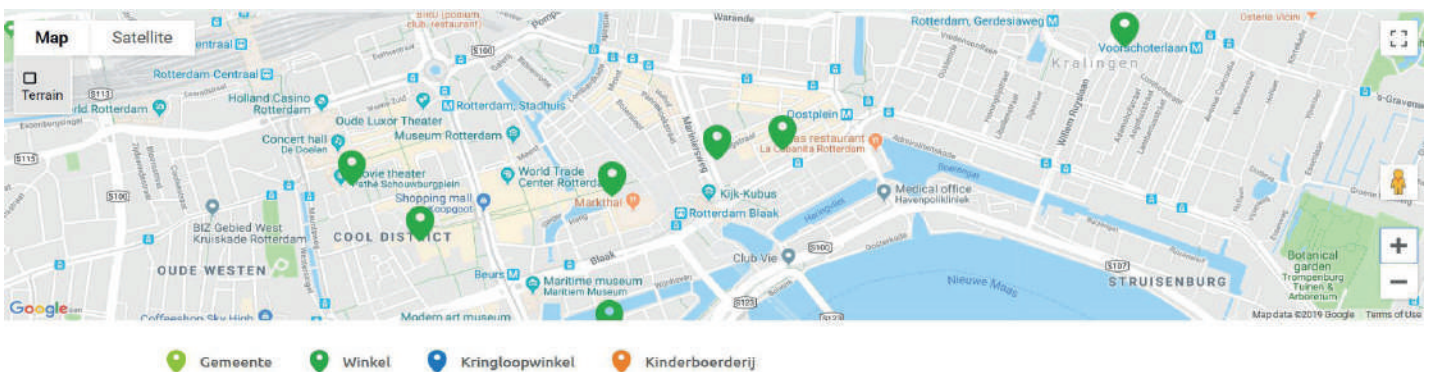

Locations for disposal of KCA (small appliances, empty batteries, lamps) via <https://www.wecycle.nl/inleverpunt-zoeken>

5. Plak het **icoon** van het door jou gekozen afval op de krat, het bakje en de tas. **Stickers met iconen** van het afval, vind je op de Afvalwijzer.



6. Zoek ook een **vaste plek** uit om het bakje, de tas en de krat neer te zetten. Zet het afvalbakje bijvoorbeeld op het aanrecht of in een keukenkastje. Hang de afvaltas aan de kapstok en zet de afvalkrat in de gang of in de berging.



7. **Je bent klaar voor gebruik!** Bedankt voor je bijdrage aan het recyclen van materialen.

Alsjeblieft! Een cadeautje omdat je net verhuisd bent.

Maak jij ook een goede start in je nieuwe huis?

Lees in dit boekje hoe je dit pakket gebruikt

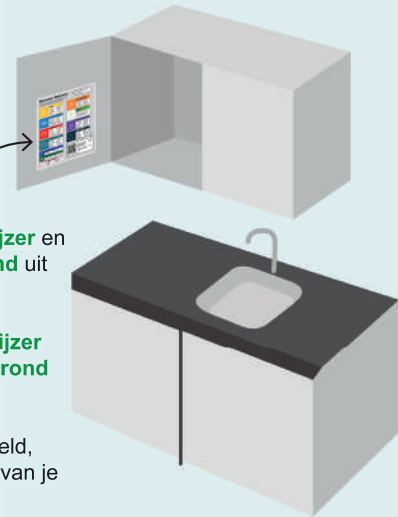

1. Druk de **Afvalwijzer** en de **Afvalplattegrond** uit de doos.

2. Hang de **Afvalwijzer** en de **Afvalplattegrond** op een plek waar jij ze gemakkelijk kan bekijken. Bijvoorbeeld, aan de binnenkant van je keukenkastje.

Backside booklet

3. Vouw de **Afvalkrat**, het **Afvalbakje** en de **Afvaltas** uit. Volg de instructies hieronder voor het dichtvouden van de bodem van de krat en het bakje.

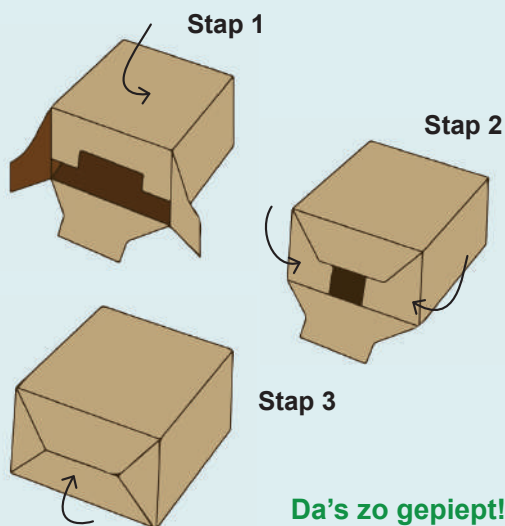

4. Bedenk voor welk afval jij de krat, het bakje en de tas wilt gebruiken. De verschillende afvalsoorten staan genoemd op de Afvalwijzer. **Suggesties** voor gebruik vind je op de volgende twee pagina's.

Frontside booklet

Voor Klein Chemisch Afval (KCA), zoals lampen en batterijen

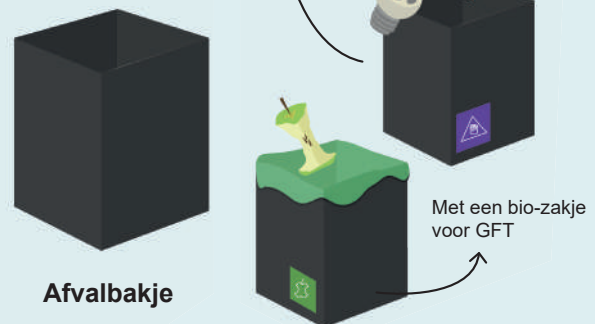

Afvalkrat

Met een bio-zakje voor GFT

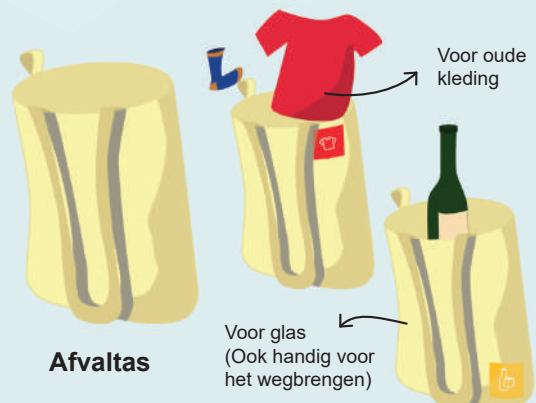

Afvaltas

Voor glas (Ook handig voor het wegbrengen)

Inside booklet

Test set-up

Six prototypes are sent out to six recently moved high-rise residents in Rotterdam. They receive the product via mail, without further instructions. This simulates the intended use case, where *Schone start* is automatically sent by mail after registration of the resident in the municipal personal records database. The prototype contains a personalised Waste map, based on their address. Approximately 1,5-2 weeks after receiving *Schone start*, the product is evaluated with the high-rise resident by means of an interview.

Interview guide

START

- Vind je het goed als ik dit gesprek opneem voor onderzoeksdoeleinden?
- Kan je wat over jezelf vertellen?

VRAGEN

1. Hoe heb je het ontvangen van het pakket ervaren?
2. Wat vond je van het pakket wat je ontvangen hebt?
 - a. De fysieke producten die je hebt gekregen?
 - b. De informatie die het pakket bevat?
3. Hoe heb je het pakket gebruikt?
 - a. Wat heb je wel gebruikt?
 - b. Wat heb je niet gebruikt?
 - c. Wat heb je weggegooid/weg willen gooien?
4. Wat heb je in het pakket gemist?
 - a. Aan informatie?
 - b. Aan fysieke producten?
5. Wat vond je van de timing van het pakket, relatief kort na je verhuizing?
 - a. Wat zou een betere timing zijn?
6. Hoe is je idee over of kennis van afvalscheiding veranderd, sinds je het pakket hebt ontvangen?
7. Wat zou je ervan vinden als Gemeente Rotterdam dit pakket naar alle recent verhuisde hoogbouwbezoekers zou gaan sturen?

EIND

- Zou ik foto's mogen maken van hoe je het product gebruikt? Zou je me foto's kunnen sturen van hoe je het product gebruikt?
- Zou je dit evaluatie formulier voor mij kunnen invullen?

Participants

Six high-rise households participated in the pilot test. During one of the interviews, both residents from one household were present. All other interviews were carried out with only one of the residents. Figure A.41 on page 100 shows details about the participating households.

Test goal

Understand how people use and experience (receiving) *Schone start* and learn how it can be improved.

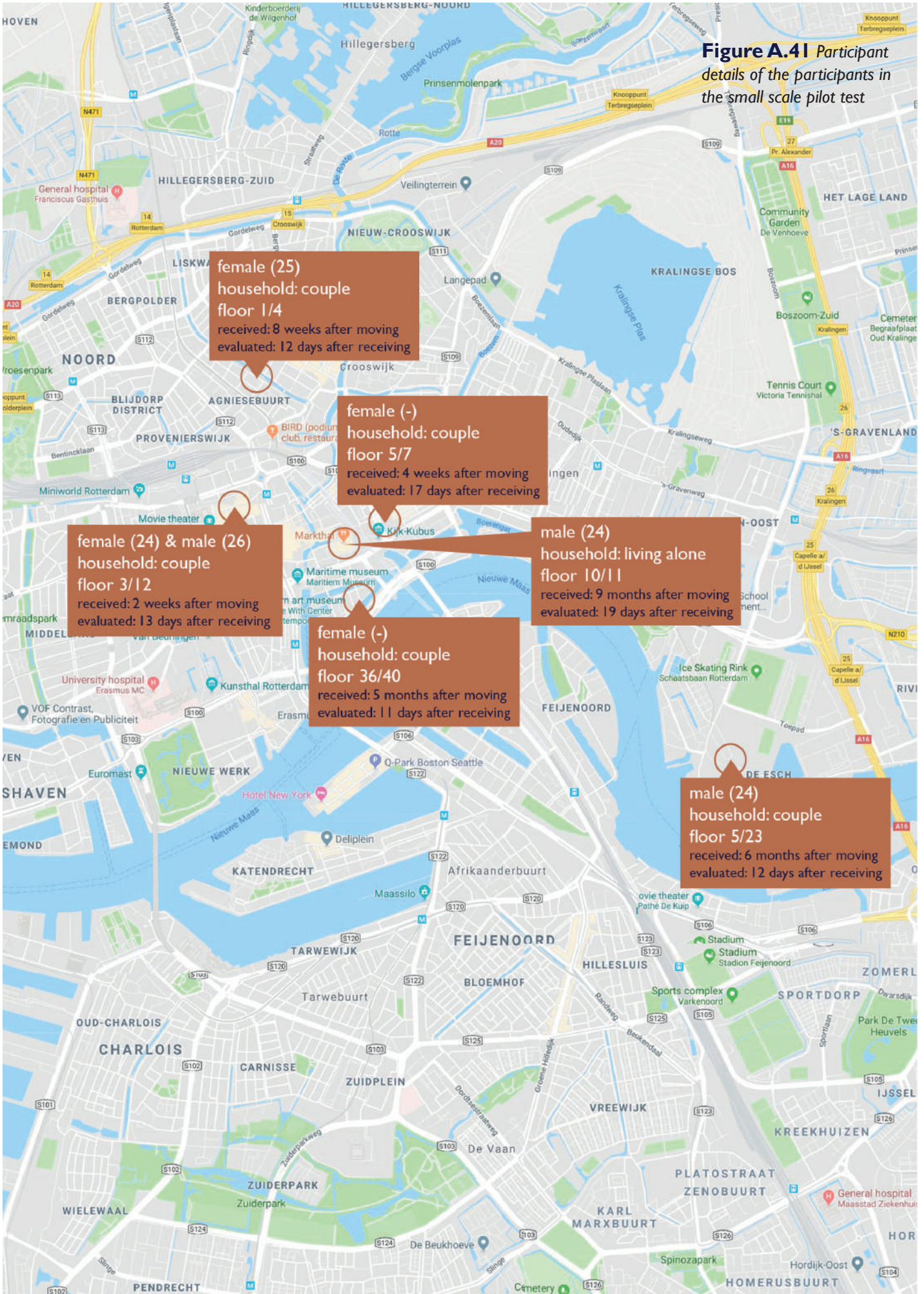

Figure A.41 Participant details of the participants in the small scale pilot test

Achtergrondvragen:

- Ik woon op de _____ (nummer) etage van een gebouw met _____ (aantal) etages
- Ik woon samen met _____ (aantal) mensen (excl. mijzelf)
- Ik ben naar dit adres verhuisd op _____ (datum of maand en jaartal van je verhuizing)

Stellingen over jou en huishoudelijk afvalscheiding

1. Gewoonlijk scheid ik mijn huishoudelijk afval erg goed (zonder gebruik van het pakket)

Volledig oneens | 1 2 3 4 5 6 7 | Volledig eens

2. Ik begrijp het doel van het scheiden van huishoudelijk afval

Volledig oneens | 1 2 3 4 5 6 7 | Volledig eens

3. Ik vind het scheiden van huishoudelijk afval belangrijk

Volledig oneens | 1 2 3 4 5 6 7 | Volledig eens

4. Ik vind dat ik mijn huishoudelijk afval beter zou moeten scheiden

Volledig oneens | 1 2 3 4 5 6 7 | Volledig eens

Stellingen over jouw evaluatie van het pakket

5. Het pakket was nuttig ter ondersteuning van het scheiden van mijn huishoudelijk afval

Volledig oneens | 1 2 3 4 5 6 7 | Volledig eens

6. Het pakket moedigde mij aan om mijn huishoudelijk afval te scheiden

Volledig oneens | 1 2 3 4 5 6 7 | Volledig eens

7. Het pakket hielp mij eraan herinneren om mijn huishoudelijk afval te scheiden

Volledig oneens | 1 2 3 4 5 6 7 | Volledig eens

8. Het pakket faciliteerde het scheiden van mijn huishoudelijk afval voldoende voor mij

Volledig oneens | 1 2 3 4 5 6 7 | Volledig eens

9. Het pakket was voldoende informatief over het scheiden van huishoudelijk afval

Volledig oneens | 1 2 3 4 5 6 7 | Volledig eens

10. Ik heb mijn afval beter gescheiden door het ontvangen van het pakket

Volledig oneens | 1 2 3 4 5 6 7 | Volledig eens

Vragen over het gebruik van het pakket

11. Welke afvalsoorten scheidde je, voordat je het pakket

ontving?

- Glas
- Papier en karton
- GFE / GFT
- PMD:
 - Plastic verpakkingen
 - Metalen verpakkingen
 - Drinkpakken
- Textiel
- KCA (Klein Chemisch Afval):
 - Batterijen
 - Lampen
 - Verf
 - Anders: _____
- Rest afval _____

12. Welke afvalsoorten heb je gescheiden, sinds je het pakket

hebt ontvangen?

- Glas
- Papier en karton
- GFE / GFT
- PMD:
 - Plastic verpakkingen
 - Metalen verpakkingen
 - Drinkpakken
- Textiel
- KCA (Klein Chemisch Afval):
 - Batterijen
 - Lampen
 - Verf
 - Anders: _____
- Rest afval _____

13. Hoe lang heb je het pakket (geprobeerd te) gebruikt (gebruiken)? 1-5 dagen / 6-10 dagen / 11-15 dagen / 16-20 dagen

Stellingen over jou en huishoudelijk afvalscheiding

1. Gewoonlijk scheid ik mijn huishoudelijk afval erg goed (zonder gebruik van het pakket)

Volledig oneens	1	2	3	4	5	6	7	Volledig eens

2. Ik begrijp het doel van het scheiden van huishoudelijk afval

Volledig oneens	1	2	3	4	5	6	7	Volledig eens

3. Ik vind het scheiden van huishoudelijk afval belangrijk

Volledig oneens	1	2	3	4	5	6	7	Volledig eens

4. Ik vind dat ik mijn huishoudelijk afval beter zou moeten scheiden

Volledig oneens	1	2	3	4	5	6	7	Volledig eens

Stellingen over jouw evaluatie van het pakket

5. Het pakket was nuttig ter ondersteuning van het scheiden van mijn huishoudelijk afval

Volledig oneens	1	2	3	4	5	6	7	Volledig eens

6. Het pakket moedigde mij aan om mijn huishoudelijk afval te scheiden

Volledig oneens	1	2	3	4	5	6	7	Volledig eens

7. Het pakket hielp mij eraan herinneren om mijn huishoudelijk afval te scheiden

Volledig oneens	1	2	3	4	5	6	7	Volledig eens

8. Het pakket faciliteerde het scheiden van mijn huishoudelijk afval voldoende voor mij

Volledig oneens	1	2	3	4	5	6	7	Volledig eens

9. Het pakket was voldoende informatief over het scheiden van huishoudelijk afval

Volledig oneens	1	2	3	4	5	6	7	Volledig eens

10. Ik heb mijn afval beter gescheiden door het ontvangen van het pakket

Volledig oneens	1	2	3	4	5	6	7	Volledig eens

Note: the test participant indicated by orange did not open the package between receiving it and the evaluation interview, so no data regarding the product usage evaluation is available.

Participant 1



Participant 2



Participant 3



Participant 4

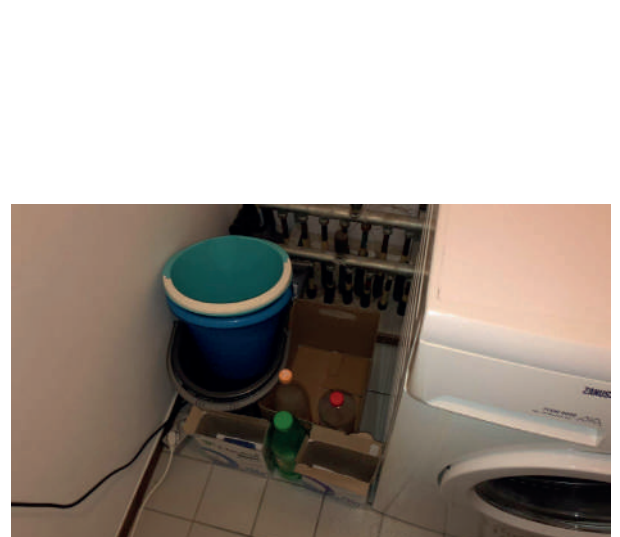

Dimensions

The largest dimensions of the prototype delivery packages are:

320 x 265 x 32 mm

The maximum dimensions of mailbox packages of Post NL are:

380 x 265 x 32 mm

Delivery evaluation

Four out of six prototype packages fit through the mailbox of the participant. One of the mailboxes was an old one, which did not correspond with the standardised modern mailboxes. The other package that did not fit through the mailbox was only 2-3 mm too wide.

Recommendation

The prototype package does fit within the maximum dimensions for mailbox packages of Post NL. However, the four packages that did fit through the mailbox were a tight fit. It is recommended to reduce the width of the package with approximately 5 mm (from 265 to 260 mm). If possible, it is advisable to bring back the height of the package to a maximum of 30 mm too.



