

Basics and first experiments demonstrating isolation improvements in the agile polarimetric FM-CW radar – PARSAX

OLEG A. KRASNOV, GALINA P. BABUR, ZONGBO WANG, LEO P. LIGTHART AND FRED VAN DER ZWAN

The article describes the IRCTR PARSAX radar system, the S-band high-resolution Doppler polarimetric frequency modulated continuous wave (FM-CW) radar with dual-orthogonal sounding signals, which has the possibility to measure all elements of the radar target polarization scattering matrix simultaneously, in one sweep. The performance of such radar depends of the level of sounding signals orthogonality. In the main operational mode, the radar will be used for atmospheric remote sensing and polarimetric studies of ground-based targets. In such mode it will use a pair of synchronous linearly- frequency modulated (LFM) continuous signals with opposite frequency excursions of 50 MHz and duration of 1 ms. Such a combination of sounding signals has limited orthogonality even for huge BT-products, which produce cross-channel interferences. These interferences in case of radar scene with multiple pointed and distributed targets can completely degrade radar operational performance. In this article, we propose simple and effective technique to suppress interferences and to restore radar performance. The technique has been tested using simulation and has been implemented in multi-channel digital receiver of the PARSAX radar. The real radar measurements presented to illustrate effectiveness of cross-channel interferences suppression. The proposed technique can be useful not only for polarimetric radar design, but also in much wide radar applications, which use waveforms with high orthogonality.

Keywords: Polarimetric radar, FM-CW radar, LFM, Orthogonal waveforms

Received 21 December 2009; Revised 28 April 2010; first published online 11 June 2010

I. INTRODUCTION

It is widely known fact that using polarimetric information can seriously improve the radar performances for targets detection, identification, and parameters estimation, for clutter and interferences suppression [1, 2]. Most of modern radar polarimetry algorithms are based on the measurements of the radar target polarization scattering matrix (PSM), which includes four elements with different amplitudes and phases. The necessity to measure all four elements requires a multichannel structure for the radar receiver and transmitter. But even then in most (existing) polarimetric radars the simultaneous measurement of all PSM elements at the same frequency band is not implemented yet.

The vector nature of electromagnetic fields and their scattering mechanisms requires in polarimetric radars the use of sounding signals with dual orthogonality, i.e. the orthogonally polarized components of such signals have waveforms that are orthogonal in terms of their inner product (cross-correlation) [3, 4]. Well-established technical solutions can be used for the transmission and reception of the signals' orthogonally polarized components. The orthogonality of components' waveforms can be established using different approaches. First, time orthogonality in polarimetric radar means the

consequent transmission of sounding signals with orthogonal polarization combined with pulse-to-pulse polarization switching. Second, frequency orthogonality means that the sounding signals occupy non-overlapping frequency bands. However, the polarization of the scattered signals can vary over time and the scattering properties of the same radar object may be different for different sounding frequencies. So both time and frequency orthogonalities can introduce temporal, frequency, and phase ambiguities in the polarimetric results.

There is a known solution (see e.g. [3–5]) of polarimetric radar design that completely removes these ambiguities, that is the use of signals with orthogonally polarized components, which have waveforms that are orthogonal in terms of their inner product (cross-correlation). Such type of sounding signals provides the unique possibility to split all elements of scattering matrix and to measure all of them simultaneously during one pulse or single sweep time. One of the most promising examples of orthogonal waveforms for such signals is a pair of linearly frequency modulated (LFM) signals with opposite frequency excursions, which occupy the same bandwidth and the same time interval.

The structure of the paper is the following. Section 2 gives a brief description of the high-resolution Doppler polarimetric radar PARSAX, which implements the concept of dual-orthogonal signals for simultaneous measurement of all scattering matrix elements and is currently under development in IRCTR, TU Delft. Section 3 describes the problem with channels' isolation in polarimetric FM-CW radar with dual-orthogonal signals. Section 4 presents the novel solution of the described in previous section problem and its validation using computer



Fig. 1. PARSAX radar system.

simulation. Section 5 describes the implementation of the proposed technique in the PARSAX radar digital receiver and show experimental results of measurements with and without use of the interference suppression in comparison with standard one-waveform sounding. Finally, Section 6 includes the conclusions.

II. THE PARSAX RADAR

The PARSAX radar (Fig. 1) currently being developed by IRCTR, TU Delft is a full-polarimetric continuous wave (CW) S-band (3.315 GHz) radar, which uses dual-orthogonal digitally generated sounding signals, high-dynamic range reception of scattered signals and advanced digital processing at the intermediate frequency (IF, 125 MHz) for simultaneous measurements of all elements of the PSM during one sounding sweep. The analog-to-digital conversion provides wider dynamic range, linearity, and freedom to use any pairs of orthogonal waveforms with different duration and bandwidth up to 50 MHz. The IF sampling is done at 400 MHz with 14-bit resolution; the embedded fast FPGA-based digital processing boards with large memory buffer give the possibility to

implement complicated real-time algorithms for signal and data processing, which leads to improved sensitivity and at the same time more stability against the influence of noise, clutter, and external interferences.

In the main operational mode, the radar will be used for atmospheric remote sensing and polarimetric studies of ground-based targets. In such mode it will use a pair of synchronous LFM continuous signals with opposite frequency excursions of 50 MHz and duration (sweep time) of 1 ms. The standard de-ramping processing technique (Fig. 2), which is completely implemented in FPGA, provides range profiles of the PSM complex elements up to 15 km with a resolution around 3 m for further Doppler processing.

The main technical characteristics of the PARSAX radar are presented in Table 1.

III. THE ISOLATION PROBLEM

We analyze synchronous dual-orthogonal LFM signals, which transmitted on orthogonal (horizontal and vertical, subscripts H, V) polarizations:

$$\begin{bmatrix} u_H \\ u_V \end{bmatrix} = \begin{bmatrix} u_1(t) \\ u_2(t) \end{bmatrix} = \begin{bmatrix} \exp[j2\pi(f_0 t + k_0 t^2/2)] \\ \exp[j2\pi(f_0 t - k_0 t^2/2)] \end{bmatrix}, \quad (1)$$

where $u_1(t)$ and $u_2(t)$ are the up-going and down-going LFM signals. The signals are determined for one sweep time interval $t = [0 \dots T]$; have the same frequency band ΔF around carrier frequency f_0 ; $k_0 = \Delta F/T$ is the sweep rate of the sounding signal.

The polarizations of the signals can be changed during the process of sounding. So the signals received on orthogonal polarizations ($x_H(t)$ and $x_V(t)$) contain the sums of the both delayed sounding signals (LFM signals with opposite slopes, $u_1(t)$ and $u_2(t)$) weighted on different complex amplitudes characterizing the corresponding PSM elements.

A simplified scheme of a de-ramping filter for processing of received signals is shown in Fig. 2. In order to obtain the estimations of all scattering matrix elements each polarization component of the received signal in two separated branches

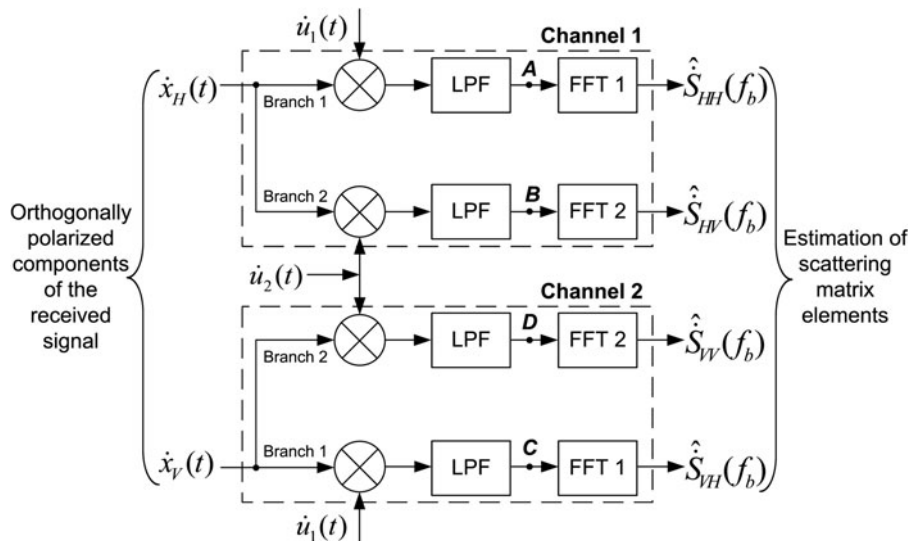

Fig. 2. Block-diagram of the PARSAX radar receiver (with key points A–D).

Table 1. Main characteristics of the PARSAX radar.

S band	Central frequency: 3.315 GHz Modulation bandwidth: up to 50 MHz Resolution: up to 3 m Sweep time: 1 ms, variable
Antennas	Two parabolic reflectors Isolation receiver–transmitter: HH = −100 dB, VV = −85 dB
Receiver	Diameter: 2.12 m. Beam width: 4.6°
Antenna	Gain: 32.75 dB
Transmitter	Diameter: 4.28 m. Beam width: 1.8°
Antenna	Gain: 40.0 dB
Transmitter	Solid state power amplifiers 100 W max per channel −80 dB attenuators (8 bits control bus)
Receiver	Dynamic range: better 70 dB (SFDR) 1 stage down conversion ADC at intermediate frequency (125 MHz, sampling 400 MHz, 14 bits) FPGA-based 4 channels digital processor
Waveforms	Digital vector waveform generator (sampling up to 1.2 GHz, 16 bits) Linear frequency modulation PCM with orthogonal codes

of each receiver channel is mixed with replica of the sounding signal components and, as result, is reduced in slope, i.e. the signals are de-ramped [6]. The signals after demodulation and low-pass filtering (LPF) are called beat signals; they exist at the key-points A, B, C, D of the de-ramped filter (Fig. 2). Further applying a Fourier transform (that is the fast Fourier transform – FFT) onto the beat signals, measured during one sweep period, converts the beat signals into resulting range profiles of all scattering matrix elements. The processing algorithm is summarized by

$$\begin{bmatrix} \hat{S}_{HH}(f_b) & \hat{S}_{HV}(f_b) \\ \hat{S}_{VH}(f_b) & \hat{S}_{VV}(f_b) \end{bmatrix} = \text{FFT} \left[\text{LPF} \begin{bmatrix} \dot{x}_H(t) \cdot \dot{u}_1^*(t) & \dot{x}_H(t) \cdot \dot{u}_2^*(t) \\ \dot{x}_V(t) \cdot \dot{u}_1^*(t) & \dot{x}_V(t) \cdot \dot{u}_2^*(t) \end{bmatrix} \right], \quad (2)$$

for $t \in [\tau_{max} \dots T]$, where T is the LFM sweep time, τ_{max} is maximum time delay of the received vector signal $\dot{\mathbf{x}}(t) = [\dot{x}_1(t) \ \dot{x}_2(t)]$, which corresponds to the maximum range and is defined during the radar design stage, and $\dot{\mathbf{u}}(t) = [\dot{u}_1(t) \ \dot{u}_2(t)]$ is the replica of the transmitted vector signal. Beat frequencies f_b are analyzed in the frequency band $[0 \dots f_{bmax}]$ with a unique relation between the beat frequency value and the range of the observed target [7].

De-ramping processing by definition means the transformation of the sets of delayed LFM-signals into the sine signals (tones). The frequency of each tone corresponds to the definite roundtrip time delay τ , which is determined by the corresponding range R via relation $f_b = k_o \tau = k_o 2R/c$, where c is the light velocity.

There is a problem connected with such polarimetric FM-CW radar architecture: the LFM signals with opposite slopes are not completely orthogonal. They have cross-interference region, where up-going and down-going LFM signals occupy the close-up frequencies at the same time instant. After mixing and LPF in the de-ramping filter, this region results in the interfering signals, which have doubled

sweep rate, $2k_o$, and occupy the whole LPF's frequency band $[0 \dots f_{bmax}]$ [7]. The interfering signals can limit the cross-channel isolation (in terms of signal to interference ratio).

The isolation problem in case of one point target has been originally studied in [5], where the performance analysis of the radar system with dual-orthogonal signals has been done using two parameters – peak sidelobe level (PSL) and isolation (I). They are defined as

$$PSL_i \triangleq \min_{\tau \notin \Omega_i} \left[20 \log_{10} \frac{|R_{ii}(0)|}{|R_{ii}(\tau)|} \right], \quad (3)$$

$$I_i \triangleq \min_{\forall \tau} \left[20 \log_{10} \frac{|R_{ii}(0)|}{|R_{ij}(\tau)|} \right], \quad i, j = 1, 2, \quad (4)$$

where $R_{ii}(\tau)$ and $R_{ij}(\tau)$ are the autocorrelation and cross-correlation functions of the transmitted signals complex envelopes, the index i denotes the waveform that is considered between those simultaneously transmitted, and Ω_i is the interval of τ values corresponding to the mainlobe of $R_{ii}(\tau)$. The PSL is a measure of protection from the maximum residual “co-channel” interference due to interfering target and the isolation I is a measure of protection from the maximum residual “cross-channel” return due to the same target or to an interfering target.

The results of these parameters calculations as functions of the parameter α for the Hamming weighting function

$$w(t) = \alpha + (1 - \alpha) \cos\left(\frac{2\pi t}{T}\right), \quad |t| \leq T/2 \quad (5)$$

are shown in Fig. 3 for the different values of the sounding signals compression ratio, which is defined as a product $B = T \Delta f$ of the signal duration T and the bandwidth Δf .

From this representation it is clear that for the PARSAX FM-CW system with high values of compression ratio (between 2000 and 50 000), the cross-polarization-channels interferences in case of one point target observation become less important in comparison with self-channel interferences due to the sidelobes of compressed signal. A proper selection of the windowing function parameter for every selected value of the compression ratio provides the performances of the polarimetric radar with dual-orthogonal sounding signals at

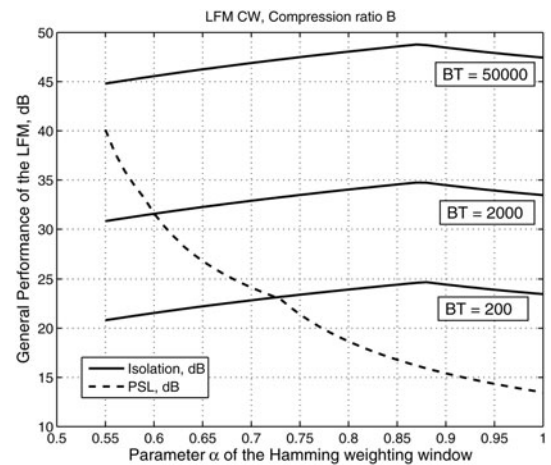
Fig. 3. Performance parameters of the FM-CW polarimetric radar with dual-orthogonal LFM signals.

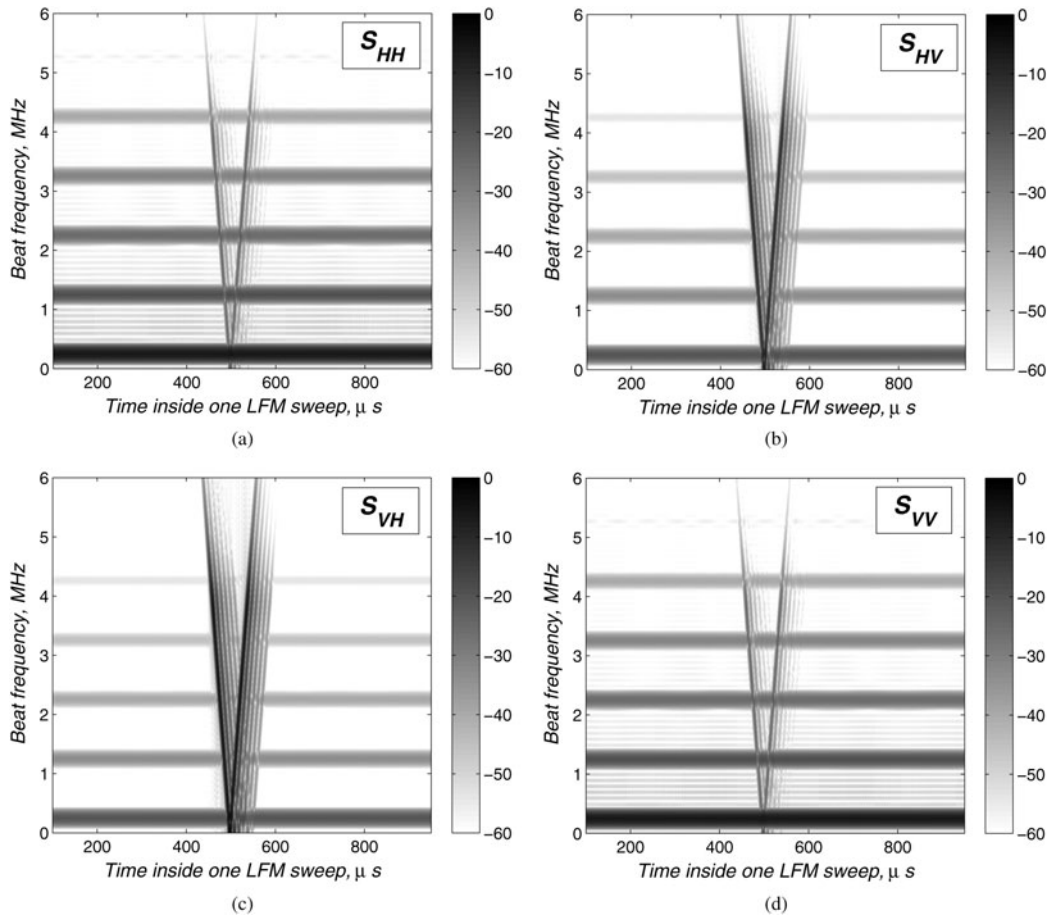

Fig. 4. Time-frequency representation of the de-ramped (beat) signals in four branches of the FM-CW radar receiver.

the level, which is comparable with that for standard one-channel FM-CW radars. At the same time, the suppression of the sidelobes and cross-channels interferences is better than 30 dB level, which is the typical value for the polarization channels isolation in antennas.

The presented analysis is applicable only to the case of one point target. As it was mentioned in [5], when dealing with range extended targets, one cannot base the analysis of the performance of the dual-orthogonal sounding signals on parameters defined over the peak co- and cross-channel interferences, because the minimization of such peaks not necessarily imply a reduction of the interference levels. The analysis and suppression of the cross-channel interferences in such case related to the cumulative effect of backscattering from the single range spread scatterers and, consequently, to the total energy of the interference generated by distributed targets.

As soon as in main operational mode the PARSAX system mostly measures distributed volume and surface targets, the effect of cross-channel interferences can strongly influence the performances of the polarimetric radar, and it is necessary to analyze it in details.

For such study of processes in the polarimetric radar receiver a computer simulation approach has been used. The simulated radar scene included six-point targets with PSM

$$\dot{S} = \begin{bmatrix} 1 & 0.1 \\ 0.1 & 0.5 \end{bmatrix}$$

and positions that cover the full interval of observation ranges. For obtaining a more realistic simulation in the model we included an $1/r^4$ range dependence of the reflected signals.

For analysis, the de-ramped signals at points A–D in the receiver block-diagram (Fig. 2) have been represented on the plane “beat frequency – observation time” using a moving short time Fourier transform (Fig. 4). The horizontal lines represent useful signals – beat tones from every target and the interfering V-shaped frequency-modulated signals around the center of the plane are defined by the interactions of LFM components with opposite slopes. The clear localization in time and the detailed structure of the interfering cross-LFM signals are visible only using the short-time FFT. In case of full-scale FFT, which is used for the standard de-ramping processing, these interfering signals are spread within the full analyzed beat frequency band. This introduces

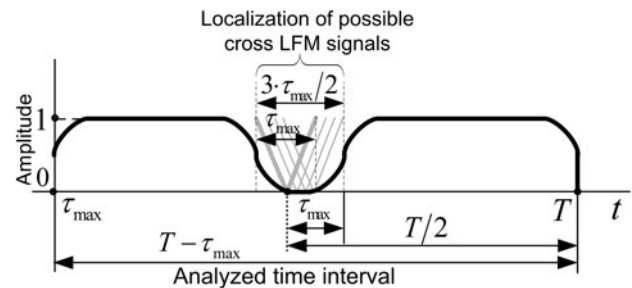

Fig. 5. Smoothed-out window applied to the beat signals.

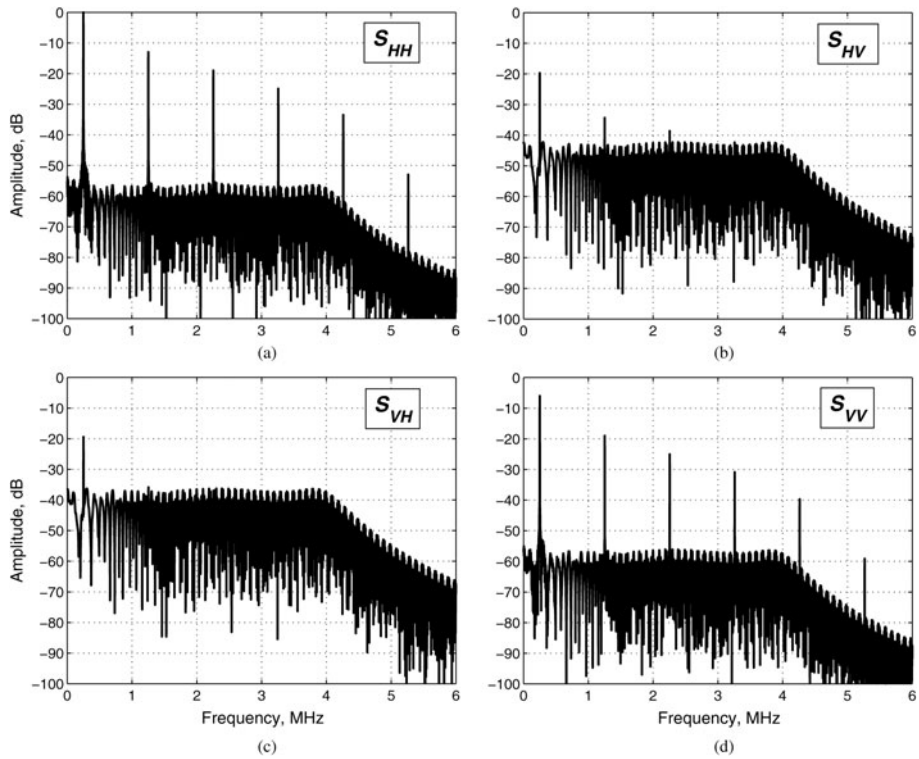

Fig. 6. Simulated de-ramped signals' spectra before filtering.

a flat raised noise-like floor with amplitudes, which are determined by the level of cross-channel isolation (4) and integral received power in complementary channel [7]. This effect, which can be seen in Fig. 6, seriously decreased the operational dynamic range of the radar and detectability of targets. This effect especially important for the cross-polarized channels (HV and VH) of the polarimetric receiver as soon as

for most targets the amplitude of reflected signals with such polarization in average are 10–20 dB less than for co-polarized channels (HH and VV). The provided two-dimensional representation of the signals in the polarimetric receiver channels gives a much more detailed picture of the signals and can be used for further analysis and improvement of the radar performances.

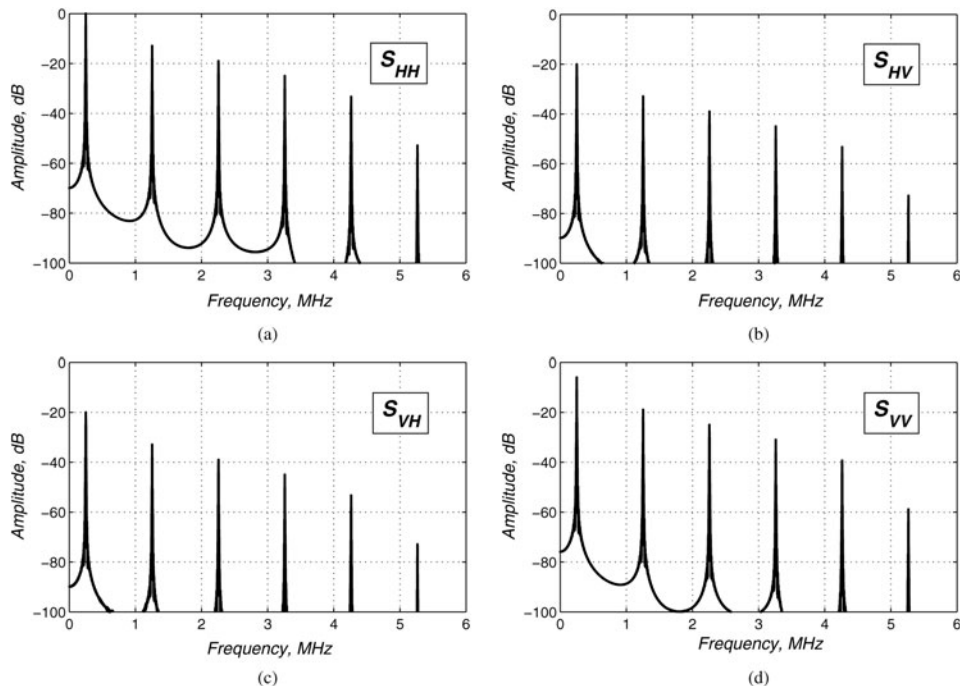

Fig. 7. Simulated de-ramped signals' spectra after filtering.

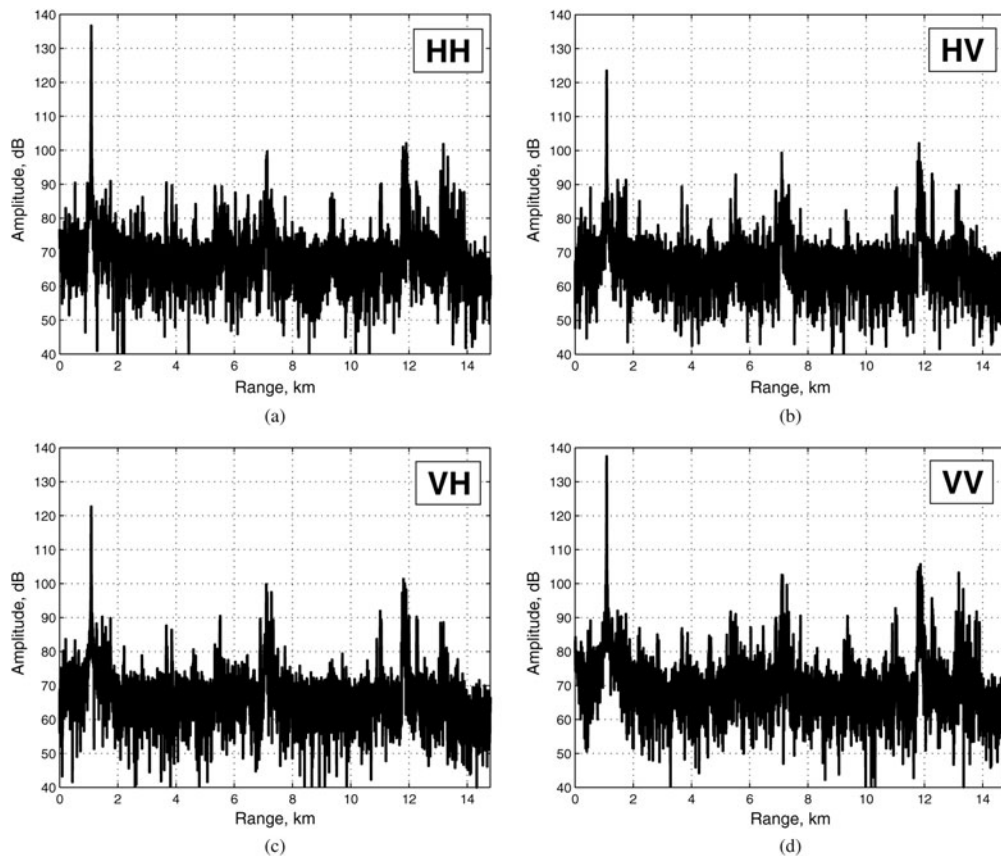

Fig. 8. PARSAX radar range profiles in case of sequential polarimetric sounding with one standard LFM waveform.

IV. THE SOLUTION FOR THE ISOLATION PROBLEM IN PARSAX RADAR

The proposed technique for increasing the isolation between the polarimetric channels of the radar with dual-orthogonal signal is based on the fact that interfering cross LFM signals occupy only a part of the observation time interval (Fig. 4) (detail analysis of the signals and cross-channel interferences can be found in [7]). The V-shaped cross-correlation interfering signals have duration τ_{max} and bandwidth $[0..f_{bmax}]$.

The maximum roundtrip time delay for a cross-correlation component (determined by the objects located in the range interval $[0..R_{max}]$) equals to $\tau_{max}/2$ (not to τ_{max} as for useful (tone) signals). It is defined by the fact that the sweep rate of the cross-signals is increased twice after de-ramping processing. So, the cross-correlation component duration equals to τ_{max} and the maximum roundtrip time delay for cross de-ramped signals is equal to $\tau_{max}/2$. Finally, the time interval in which interfering LFM signals are present in every channel is proportional to the cut-off frequency of the LPF for beat signals and equals to $t_{cut} = 3\tau_{max}/2$.

The proposed technique includes zeroing of the beat signals during the period of presence of the interfering signal. To prevent the rising of spectral sidelobes of useful (tone) beat signals the applied cut-off has to include a window weighting (Fig. 5) [7]. This is quite simple in a technical realization, as soon as time position and duration of the interfering signal are fixed for the given radar design, and it can be implemented in the real-time processing chain.

Figure 6 represents the final range profiles for the simulated radar scene using the standard processing technique. In Fig. 7 the same scene is presented using the proposed technique including suppression of the interfering cross-channel signals. The comparison of these pictures clearly shows that the application of the proposed technique completely removes the presence of interfering signals and produces a full isolation of polarimetric channels. Possible range resolution degradation due to the cut-off filtering should be considered together with the performance degradation because of the window weighting applied in FM-CW radar for sidelobes suppression. As well it is necessary to mention some degrading in energy of useful signals, which can result in SNR losses. For the PARSAX standard waveforms with bandwidth 50 MHz, sweep time 1 ms, and maximum range of interest 15 km, the expected energy loss equals to 1.6 dB. So the advantage of cross-correlation suppression outweighs the disadvantage of energy loss.

V. EXPERIMENTS

Standard de-ramping signal processor with 5 MHz bandwidth low-pass filter and 16k range FFT with Hamming windowing has been implemented as bit-stream image for FPGA-based digital receiver of the PARSAX radar. The output range profiles of 5120 complex signal values together with profile markers for further cross-channel synchronization are accumulated in buffer memory and then are uploaded for further processing, storage, and visualization into the host

computer using fast PCIe bus. With such architecture the radar system is real-time operational. Using high-quality multi-channel digital arbitrary waveform generator it is possible to re-configure the radar to work with different waveforms and compare the performances of different radar architectures, signals, and processing algorithms.

Figure 8 represents typical range profiles of amplitudes of backscattering matrix elements, which were measured using most used currently in radar polarimetry sequential approach: during one sweep only waveform with one polarization state is transmitted (say H), two polarization channels (H and V) of the receiver measure HH and HV elements of PSM simultaneously. During next sweep the polarization of the transmitted waveform is changing to orthogonal (V) and two polarization channels (H and V) of the receiver measure now VH and VV elements. There is time difference between measured columns of PSM, but there is no any cross-channel interference.

The presented in Fig. 8 profiles have about 60 dB dynamic range which defined as a ratio between strongest target and average noise floor of the profile. They have been measured with near horizontally pointed antennas of the PARSAX radar and quite low level of the transmitted continuous power (+10 dBm) that prevents any saturation of the receiver. The strongest target at the range about 1 km is an 80 m chimney and reflections at the range of about 12–14 km correspond to an industrial area in Rotterdam.

Fig. 9 represents the measurements of the same radar scene using simultaneous transmission of two LFM waveforms with opposite slopes in two polarization channels. Four receiver channels implement the standard de-ramping processing, the same as in case of results in Fig. 8. In presented profiles of the amplitudes of PSM elements the influence of cross-channel interferences is very well visible. The noise floor of profiles in case of co-polar elements HH and VV increased by 20 dB and for cross-polar elements – by 30 dB, many targets become hidden in it. The dynamic range of profiles highly degraded, up to unacceptable for radar operation level. These profiles clearly characterize a situation with cross-channel interferences in case of multiple pointed and distributed targets.

Fig. 10 represents again the measurements of the same radar scene using simultaneous transmission of two LFM waveforms with opposite slopes in two polarization channels. But in this case four receiver channels implement the de-ramping processing with cross-channel interference suppression technique, which were proposed in the previous chapter. It has been implemented via zeroing of the predefined area of the Hamming window function in design of bit-stream image for FPGA-based digital receiver of the PARSAX radar. Such implementation does not degrade real-time performances of digital receivers.

Detail comparison of Figs 8 and 10 shows that the application of the cross-channel interference suppression

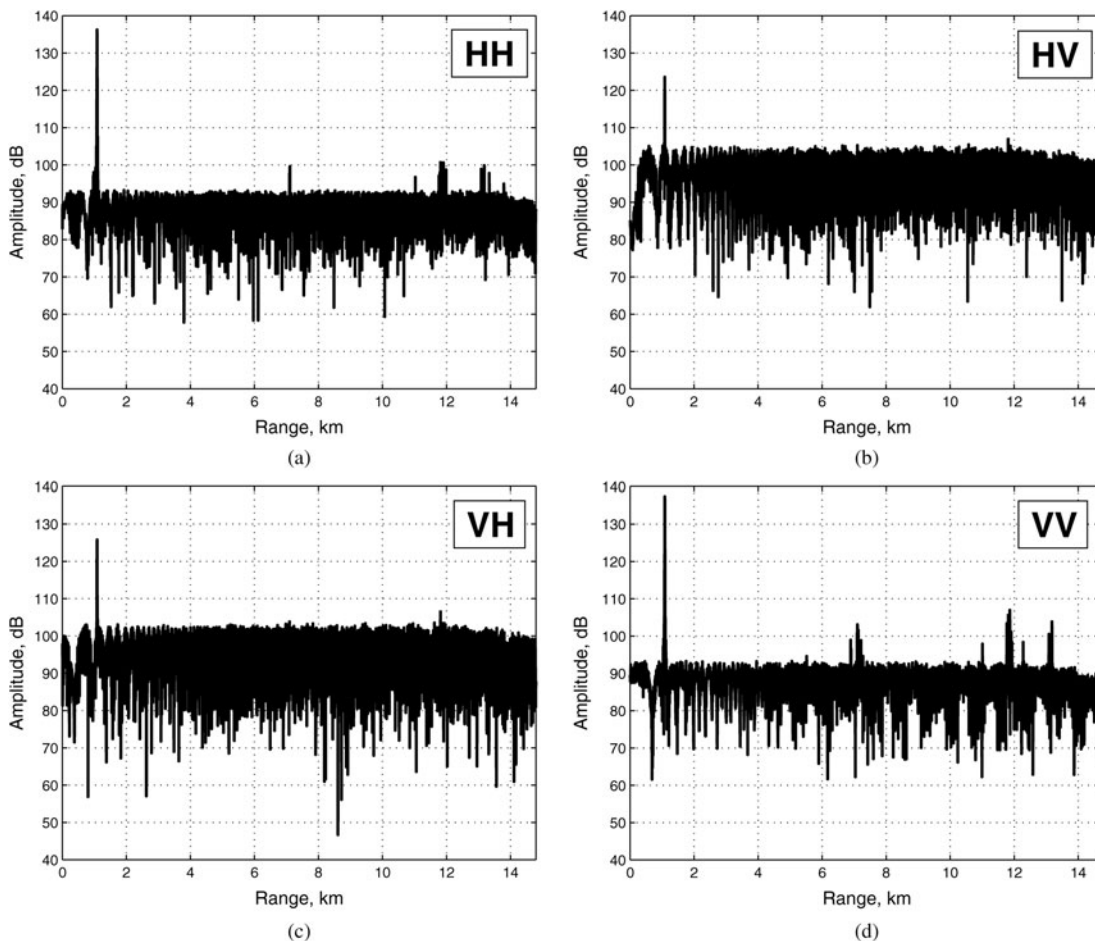

Fig. 9. PARSAX radar range profiles in case of simultaneous polarimetric sounding with two orthogonal LFM waveforms.

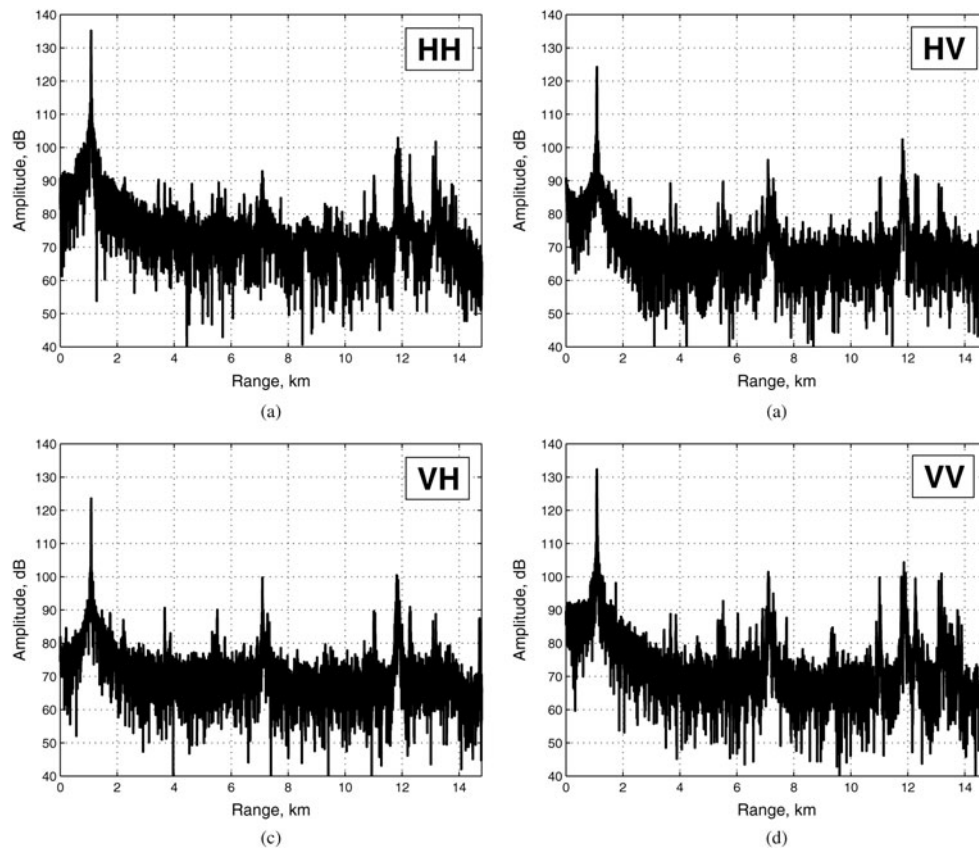

Fig. 10. PARSAX radar range profiles in case of simultaneous sounding with two orthogonal LFM waveforms and cross-channel interferences suppression.

algorithm practically completely restores the average low level of the noise floor and the radar dynamic range. Weak targets become visible and detectable. At the same time such comparison clearly shows the price, which has to be paid. As soon as we exclude from analysis about 15% of the received signal duration, it is possible to see the degradation of the resolution (from 3.3 to 3.96 m) and target amplitude (in this case

~ 0.8 dB). But most important, there is serious rising of sidelobes, which are close to strong targets (Fig. 11). This effect can be connected with quite simple and non-optimal shape of implemented effective windowing function, which has not smoothed level jumps. The optimal choice of such function that minimizes the sidelobe level can be a topic for the future research.

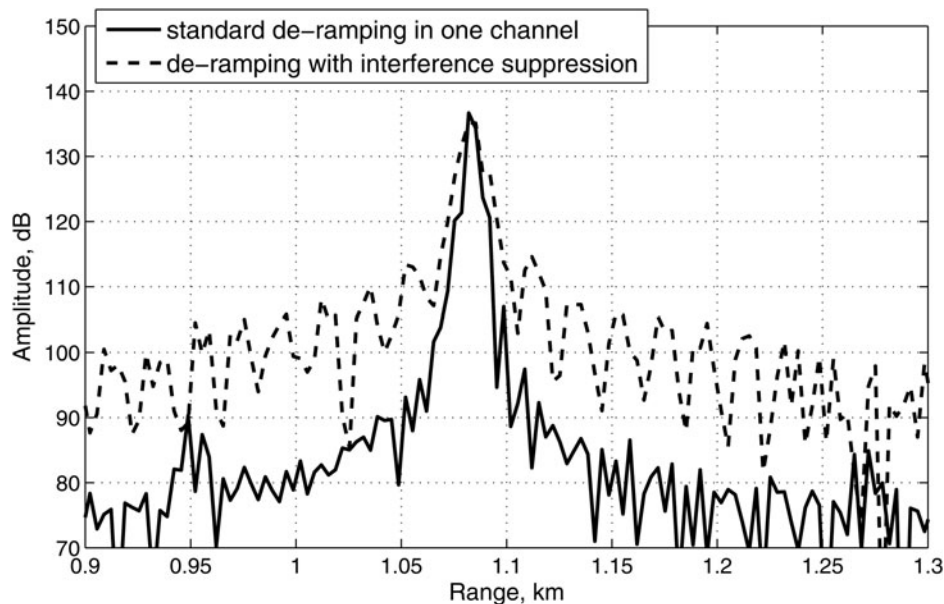

Fig. 11. Zoomed part of the HH amplitude profiles, which were measured by the PARSAX radar in cases of one-waveform sequential polarimetric measurements (solid line) and simultaneous sounding with two orthogonal LFM waveforms and cross-channel interferences suppression (dashed line).

VI. CONCLUSIONS

The article describes the IRCTR PARSAX radar system, the S-band high-resolution Doppler polarimetric FM-CW radar with dual-orthogonal sounding signals, which has the possibility to measure all elements of the radar targets PSM simultaneously, in one sweep.

The performance of such radar depends of the level of sounding signals orthogonality. In the main operational mode, the radar will be used for atmospheric remote sensing and polarimetric studies of ground-based targets. In such mode it will use a pair of synchronous LFM continuous signals with opposite frequency excursions of 50 MHz and duration of 1 ms. Such a combination of sounding signals has limited orthogonality even for huge BT-products, which produce cross-channel interferences. These interferences in case of radar scene with multiple pointed and distributed targets can completely degrade radar operational performance. In this article, we propose simple and effective technique to suppress interferences and to restore radar performance. The technique has been tested using simulation and implemented in multi-channel digital receiver of the PARSAX radar. The real radar measurements presented to illustrate effectiveness of cross-channel interferences suppression. The proposed technique can be useful not only for polarimetric radar design, but in much wider range of radar applications, which use waveforms with high orthogonality.

ACKNOWLEDGEMENTS

At the International Research Centre for Telecommunications and Radar (IRCTR), Delft University of Technology a major research project PARSAX is executed concerning the design and development of full polarimetric FM-CW radar with dual-orthogonal signals for simultaneous measurement of all elements of radar target's polarization scattering matrix. This project is performed under a contract with the Dutch Technology Foundation STW.

REFERENCES

- [1] Boerner, W.M., et al.: *Direct and Inverse Methods in Radar Polarimetry*, Part 1, Kluwer Academic Publishers, Dordrecht, The Netherlands, 1992.
- [2] Lee, J.-S.; Pottier, E.: *Polarimetric Radar Imaging: from Basics to Applications*, CRC Press, Boca Raton, FL, 2009.
- [3] Krasnov, O.A.; Ligthart, L.P.; Li, Z.; Lys, P.; van der Zwan, F.: The PARSAX – full polarimetric FM-CW radar with dual-orthogonal signals, in *European Microwave Week 2008 Conf. Proc.*, EuRAD 2008, 2008, 84–87.
- [4] Titin-Schnaider, C.; Attia, S.: Calibration of the MERIC full-polarimetric radar: theory and implementation. *Aerosp. Sci. Technol.*, 7 (2003), 633–640.
- [5] Giuli, D.; Fossi, M.; Facheris, L.: Radar target scattering matrix measurement through orthogonal signals. *IEE Proc.*, F Radar Signal Process., 140 (1993), 233–242.
- [6] Le Chevalier, F.: *Principles of Radar and Sonar Signals Processing*, Artech House, Inc., Norwood, MA, USA, 2002.
- [7] Babur, G.: *Processing of Dual-orthogonal CW Polarimetric Radar Signals*, PhD thesis, TU Delft, 2009.



Oleg A. Krasnov received the M.S. degree in radio physics from Voronezh State University, Russia, in 1982, and the Ph.D. degree from National Aerospace University “Kharkov Aviation Institute,” Ukraine, in 1994. In 1999 he joined in the International Research Center for Telecommunications and Radar (IRCTR), TU Delft. His interests are in the field

of algorithms development for polarimetric radar signal and data processing, multi-sensor atmospheric remote sensing.



Galina P. Babur received the M.S. degree in radioelectronic systems from Tomsk State University of Control System and Radioelectronics (TUCSR), Russia, in 2003, and the Ph.D. degree from Delft University of Technology (TU Delft), the Netherlands, in 2009. She specializes in the radar signal processing techniques, namely processing

of dual-orthogonal sophisticated radar signals and advanced processing in polarimetric radars with continuous waveforms.



Zongbo Wang was born in Shandong, China, in 1982. He received the B.S. and Ph.D. degrees in electronic engineering from Beijing Institute of Technology, Beijing, China, in 2004 and 2009, respectively. In 2007, he joined Group of Microwave and Radar, Universidad Politécnica de Madrid, Madrid, Spain, where he is engaged in high-resolution

LFM-CW radar image processing. In 2009, he joined the International Research Centre for Telecommunications and Radar, the Delft University of Technology, Delft, Netherlands, for the research of polarimetric remote sensing. His interests are in the field of radar signal processing, real-time digital signal processing, sub-band theory, and filter bank.



Leo P. Ligthart was born in Rotterdam, the Netherlands, on September 15, 1946. He received an Engineer's degree (cum laude) and a Doctor of Technology degree from Delft University of Technology in 1969 and 1985, respectively. He is a Fellow of the IEE and IEEE. He received doctorates (honoris causa) at Moscow State Technical University of Civil Aviation

in 1999 and Tomsk State University of Control Systems and Radioelectronics in 2001. He is an Academician of the Russian Academy of Transport. Since 1992, he has held the Chair of Microwave Transmission, Radar, and Remote Sensing in the Department of Electrical Engineering, Mathematics, and Computer Science, Delft University of Technology. In 1994, he founded the International Research Center for Telecommunications and Radar (IRCTR), and is the Director of IRCTR. Prof. Ligthart's principal areas of specialization include antennas and propagation, radar and remote sensing, but he has also been active in satellite, mobile, and radio communications. He has published over 400 papers and two books.



Fred van der Zwan was born in The Hague, The Netherlands. He received his diploma in 1986 on the Electronic Technical School in The Hague. After working at institutes like Toshiba, TNO and TU-Delft he became in 1992 Electronic Designer in the group of Telecommunications and Tele-observation Technology. He developed and programmed several processing and steering systems

for radar systems. A lot of experiences build up in many years is used to develop new radar system aspects, an upgrade MIMO test beds and an ultra wide band MIMO system is proposed to measure channel characteristics. He initiated and coordinates several new radar projects and campaigns. He has many contacts with all participating partners in several projects. In January 2004 he became co-applicant of the PARSAX project which was granted in December 2005. After that he became technical coordinator of the PARSAX project.