

**Future emerging technologies in the wind power sector  
A European perspective**

Watson, Simon; Moro, Alberto; Reis, Vera; Baniotopoulos, Charalampos; Barth, Stephan; Bartoli, Gianni; Bauer, Florian; Jamieson, Peter; Schmehl, Roland; More Authors

**DOI**

[10.1016/j.rser.2019.109270](https://doi.org/10.1016/j.rser.2019.109270)

**Publication date**

2019

**Document Version**

Final published version

**Published in**

Renewable and Sustainable Energy Reviews

**Citation (APA)**

Watson, S., Moro, A., Reis, V., Baniotopoulos, C., Barth, S., Bartoli, G., Bauer, F., Jamieson, P., Schmehl, R., & More Authors (2019). Future emerging technologies in the wind power sector: A European perspective. *Renewable and Sustainable Energy Reviews*, 113, Article 109270. <https://doi.org/10.1016/j.rser.2019.109270>

**Important note**

To cite this publication, please use the final published version (if applicable).  
Please check the document version above.

**Copyright**

Other than for strictly personal use, it is not permitted to download, forward or distribute the text or part of it, without the consent of the author(s) and/or copyright holder(s), unless the work is under an open content license such as Creative Commons.

**Takedown policy**

Please contact us and provide details if you believe this document breaches copyrights.  
We will remove access to the work immediately and investigate your claim.

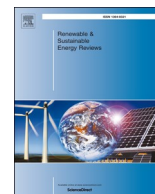

## Future emerging technologies in the wind power sector: A European perspective

Simon Watson<sup>a,\*</sup>, Alberto Moro<sup>b</sup>, Vera Reis<sup>b</sup>, Charalampos Baniotopoulos<sup>c</sup>, Stephan Barth<sup>d</sup>, Gianni Bartoli<sup>e</sup>, Florian Bauer<sup>f</sup>, Elisa Boelman<sup>b</sup>, Dennis Bosse<sup>g</sup>, Antonello Cherubini<sup>h</sup>, Alessandro Croce<sup>i</sup>, Lorenzo Fagiano<sup>i</sup>, Marco Fontana<sup>j</sup>, Adrian Gambier<sup>k</sup>, Konstantinos Gkoumas<sup>b</sup>, Christopher Golightly<sup>l,1</sup>, Mikel Iribas Latour<sup>m</sup>, Peter Jamieson<sup>n</sup>, John Kaldellis<sup>o</sup>, Andrew Macdonald<sup>p</sup>, Jimmy Murphy<sup>q</sup>, Michael Muskulus<sup>r</sup>, Francesco Petrini<sup>s</sup>, Luca Pigolotti<sup>e</sup>, Flemming Rasmussen<sup>t</sup>, Philippe Schild<sup>u</sup>, Roland Schmehl<sup>a</sup>, Nafsika Stavridou<sup>c</sup>, John Tande<sup>v</sup>, Nigel Taylor<sup>b</sup>, Thomas Telsnig<sup>b</sup>, Ryan Wiser<sup>w</sup>

<sup>a</sup> Delft University of Technology, Wind Energy Section, Faculty of Aerospace Engineering, Delft, 2629, HS, the Netherlands

<sup>b</sup> European Commission, Joint Research Centre, Ispra, Italy

<sup>c</sup> University of Birmingham, UK

<sup>d</sup> Centre for Wind Energy Research ForWind, Oldenburg, Germany

<sup>e</sup> University of Florence, Italy

<sup>f</sup> Technical University of Munich, Germany

<sup>g</sup> RWTH – Center for Wind Power Drives, RWTH, Aachen University, Germany

<sup>h</sup> Sant'Anna University of Pisa, Department of Civil and Industrial Engineering, Italy

<sup>i</sup> Politecnico di Milano, Dipartimento di Scienze e Tecnologie Aerospaziali, Italy

<sup>j</sup> Università degli Studi di Trento, Department of Industrial Engineering, Italy

<sup>k</sup> Fraunhofer IWES, Bremerhaven, Germany

<sup>l</sup> Brussels, Belgium

<sup>m</sup> Centro Nacional de Energías Renovables (CENER), Spain

<sup>n</sup> University of Strathclyde, UK

<sup>o</sup> University of West Attica, Greece

<sup>p</sup> Offshore Renewable Energy Catapult, UK

<sup>q</sup> University College Cork, Ireland

<sup>r</sup> Norwegian University of Science and Technology, Norway

<sup>s</sup> Sapienza Università di Roma, Italy

<sup>t</sup> Technical University of Denmark, Denmark

<sup>u</sup> European Commission, DG RTD, Brussels, Belgium

<sup>v</sup> SINTEF Energy Research AS, Norway

<sup>w</sup> Lawrence Berkeley National Laboratory (LBL), USA

### ARTICLE INFO

#### Keywords:

Wind power  
Wind energy  
Emerging technology  
Technology readiness level  
Renewable energy

### ABSTRACT

This paper represents an expert view from Europe of future emerging technologies within the wind energy sector considering their potential, challenges, applications and technology readiness and how they might evolve in the coming years. These technologies were identified as originating primarily from the academic sector, some start-up companies and a few larger industrial entities. The following areas were considered: airborne wind energy, offshore floating concepts, smart rotors, wind-induced energy harvesting devices, blade tip-mounted rotors, unconventional power transmission systems, multi-rotor turbines, alternative support structures, modular high voltage direct current generators, innovative blade manufacturing techniques, diffuser-augmented turbines and small turbine technologies. The future role of advanced multiscale modelling and data availability is also considered. This expert review has highlighted that more research will be required to realise many of these emerging technologies. However, there is a need to identify synergies between fundamental and industrial research by

\* Corresponding author.

E-mail address: [S.J.Watson@tudelft.nl](mailto:S.J.Watson@tudelft.nl) (S. Watson).

<sup>1</sup> Independent Consultant.

correctly targeting public and private funding in these emerging technology areas as industrial development may outpace more fundamental research faster than anticipated.

#### List of abbreviations including units and nomenclature

$a$	axial induction factor	km	kilometre
AWE	Airborne wind energy	kV	kilovolt
BTC	Bend twist coupling	kW	kilowatt
CAPEX	Capital expenditure	m	metre
CAWT	Cross axis wind turbine	MD-AWES	Multiple drone airborne wind energy system
CC	Circulation control	MoDaR	Morphing downwind-aligned rotor
$C_p$	power coefficient	MRS	Multiple-rotor system
$C_t$	thrust coefficient	MW	Megawatt
DAWT	Diffuser augmented wind turbine	OWC	Oscillating water column
FET	Future emerging technology	STC	Spar-torus-combination
HAWT	Horizontal axis wind turbine	SUMR	Segmented ultralight morphing rotor
HVDC	High-voltage direct current	TLP	Tension leg platform
Hz	Hertz	TRL	Technology readiness level
IPC	Individual pitch control	VAWT	Vertical axis wind turbine
		VIV	vortex-induced vibrations
		WEC	Wave energy converter

## 1. Introduction

The future development of wind power presents a significant opportunity in terms of providing low carbon energy. It also presents several challenges. It needs to be cost competitive compared with the use of fossil fuels and other competitor renewable energy sources, most notably solar photovoltaics. The expectation now is that developments should be subsidy-free. The wind turbines of today have seen rapid developments in their underlying technology in order to increase their competitiveness. Nevertheless, we can expect further developments in the next few years and it is instructive to consider potential future directions.

This paper is a review of future emerging technologies (FETs) in the wind power sector based on the opinion of European experts from a range of relevant technology areas. Although the technologies need not be considered exclusive to Europe, the review draws heavily on the European experience, particularly European projects. A large number of the FETs identified originate from academic work within universities and research institutes. Some of the technologies identified are being developed by university spin-outs or start-up companies. A few areas identified are the result of work by larger industrial organisations. What is presented is a summary of information solicited before, during and after a workshop organised by the European Commission. The purpose of this review is to consider different aspects of FETs in wind power such as Technology Readiness Level – TRL (summarised in [Appendix A](#)) and the potential advantages and challenges that may ultimately characterise FET development.

The criteria used to define a relevant FET in this case are:

- Technology related to wind energy supply and conversion;
- A radically new concept, not achievable by incremental research on mainstream technologies;
- Technology at an early stage of development, i.e. TRL should not be greater than 3.

The novelty of some of the technology areas here identified as *emerging* may be debatable as some have already been developed in other sectors or have been demonstrated to a higher technology readiness level (TRL) for smaller-scale devices; however, even if not radically new, application in the wind sector and at a larger scale is still considered to be at a low level of development and shows future promise. Complex applications including several technologies, some of

them having a TRL greater than 3, have been included when the system integration of technologies has not advanced beyond 3. Although it could be argued that there are a number of supporting technologies, e.g. energy storage, innovations in network connections, etc, that are still at a low TRL level and might be included in this review, it was decided to restrict the scope to technologies which are directly relevant to wind power. Including a wide range of supporting technologies would have made this review too broad and indeed topics such as energy storage would warrant a review of their own.

The aim of this paper is to gather, organise and highlight knowledge and information. This is not intended to be a road map for the future of wind power but rather a view of future emerging technologies which are believed to have potential. The review does not pretend to be exhaustive, but it is believed that it does nevertheless represent a wide range of innovations that show promise in the future. For each technology there is a discussion of the main advantages and disadvantages, the state of the art, an assessment of the present TRL and possible development trends which are considered either ‘slow’, ‘average’ or ‘fast’. ‘Average’ is considered where the technology achieves a TRL + 1 within 4–5 years. ‘Slow’ expects a longer timescale and ‘fast’ a shorter one [1]. Values of typical nominal power are also reported, together with an estimate of the potential for scale-up.

The information is presented in sections for each of the identified FETs. Each section gives a brief technical description and the degree of development, challenges and potential including scaling, present TRL level and projected TRL trend. To support the TRL assessment the most recent guidelines were used [2]. The TRL indicator is a relatively new concept in the field of energy technologies so can sometimes not be unequivocally defined, especially for FETs at an early stage of development. When assessing complex systems, the TRL of the least developed components and/or of the integration issues that present new challenges are considered. The assessment of TRL level along with present scale and future projected target power is summarised for all the identified technologies at the end of this paper in [Table 1](#). It should be stressed that as this review concentrates on technologies which are at a low TRL at present, there is no attempt to present a current or future projected levelised cost of energy (LCOE) of any of these technologies. This would be very difficult to do and would be highly speculative at this point in time.

The following sections structure the review into different categories, namely: future wind generation technologies, future technologies which will support these forms of wind power generation and future

knowledge that will be required to fulfil the potential of such power generation. A short conclusion is then provided at the end to summarise the findings and suggest what is required for some of these future technologies to be realised.

## 2. Future wind generation technologies

### 2.1. Airborne wind energy

Airborne wind energy (AWE) is an umbrella name for concepts that convert wind energy into electricity with the common feature of autonomous kites or unmanned aircraft, linked to the ground by one or more tethers [3]. AWE systems offer several potential advantages over conventional wind turbines. They require less material than tower-based turbines, have the potential to be manufactured at lower cost, can be deployed faster and can harness stronger and steadier winds by flying at higher altitudes.

Several different concepts are currently being pursued [4,5] and convergence towards the best architecture has not yet been achieved [6]. A possible classification of AWE systems is shown in Fig. 1, including several specific implementations.

Ground-gen concepts are based on the conversion of mechanical into electrical energy at ground level, while fly-gen concepts are based on the conversion in the air, onboard the airborne unit. Most ground-gen concepts drive a drum-generator module in pumping cycles, alternating between traction and retraction phases to generate electricity. Fly-gen concepts use onboard wind turbines with continuous electrical energy output and a conducting tether to deliver this energy at ground level. Of the fly-gen solutions, crosswind systems can generally produce more power (1-2 orders of magnitude higher) than non-crosswind systems [7].

The main advantages claimed by these concepts are low capital costs, due to the small amount of material used, a relatively simple construction and installation and a higher capacity factor, due to stronger and more consistent high-altitude winds prevalent above 200 m altitude [8–10].

The benefits could increase when deploying AWE systems on floating offshore platforms. Compared to a conventional, tower-based offshore floating wind turbine, a tethered AWE system is subject mainly to tensile rather than bending loads, potentially reducing the cost of large stabilising subsea structures and ballasting [11]. A potential reduction in weight (with possibility of further reduction) could reduce the capital expenditure (CAPEX) of platforms and subsea structures; and the reduced size of the devices allows for rapid installation at a lower cost. Important technical challenges of AWE systems are [6]:

- **High complexity.** The operation of AWE systems crucially depends on a fast-feedback control based on a quite complex set of distributed sensors and actuators that must guarantee fully autonomous flight over long periods of time.
- **Lack of proven reliability and operational hours.** Existing technology demonstrators still rely on supervised operation, especially in the take-off and landing phases, and most of the developed systems are not fully autonomous. Depending on the technologies, currently achieved operating times vary between 2 and 3 h and almost 24 h of autonomy.
- **Limited knowledge.** All the predictions of economic potential and environmental benefits of AWE are based solely on calculations of aerodynamics and mechanics during tethered flight. So far, these calculations have not been fully validated using experimental data. It is not certain that after full development, the technology will yield the promised energy conversion performance. Consequently, the impact and feasibility of scaling up to utility scale generation has not been deeply and rigorously assessed. There is also a need for more research on wind resources/conditions between 100 and 1000 m height, with a better description of the atmosphere in general for sustainable energy systems.

There are still several technical problems to address such as: the durability of flexible materials, greater design convergence, and water erosion testing of materials. Apart from space restrictions (a no-fly zone is necessary given the altitudes in which these devices would operate), regulation, social acceptance, safety and the potential of harm due to lightning strikes and storms are challenges which need to be addressed [12,13]. Space restrictions could cause difficulties to implement wind farms of airborne devices, creating some doubt as to the economic viability of this technology in densely populated areas such as Europe. AWE could be initially exploited for a niche market where the competition of existing mainstream turbines is weaker [14]. For example, AWE could be an interesting solution for small/isolated systems, e.g. kite on truck, to power desalination plants, pumping farm water, military applications, etc.

Recent interesting technology and research trends include: drones and multi-drone concepts, as outlined in Section 2.1.1, advanced aerodynamic modelling, electronics and sensors that allow tethered devices to be controlled autonomously, systems for autonomous take-off and landing, as outlined in Section 2.1.2, and high-lift multi-element aerofoils. The projected power for large scale operation is up to 25 MW/km<sup>2</sup> [15].

The majority of implemented development platforms is in a nominal power range up to 20 kW. A notable outlier and currently the most

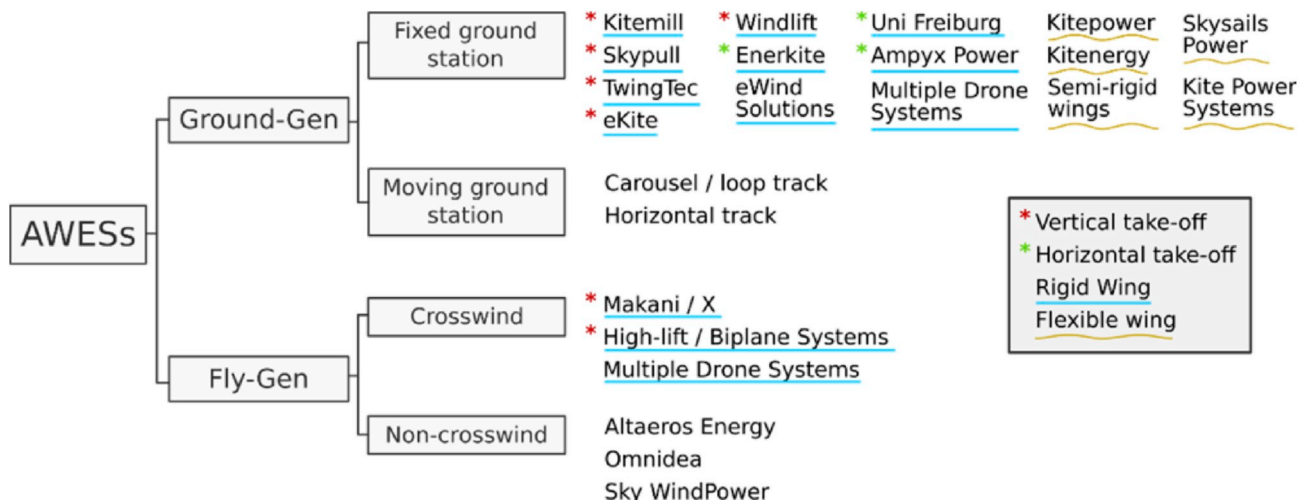

Fig. 1. Classification of AWE systems, adapted from Ref. [7]. N.B. Not included are concepts based on rotary mechanical power transfer to the ground.

prominent project is the M600 which was developed by Makani Power in the USA and which has been tested onshore in California and Hawaii [16,17]. After acquisition by Shell the company announced it would start offshore operation off the coast of Norway [18]. Competitor Ampyx Power based in the Netherlands is on track for flight testing a 250 kW rigid wing system designed for pumping cycle operation on a test site in Ireland, developed by E.ON [19].

A possible scale-up range beyond 1 MW is feasible, but even if this power level is achievable, size could be challenging e.g. due to aeroelasticity problems [17]. When implementing these systems, it would also be important to consider not only the power per square metre wing area but also all the surrounding area, which varies for different technologies. Moreover, the scalability would require longer cables and higher altitudes. At the present time, ground generation technology is not necessarily more advanced than flying generation systems.

The present TRL of AWE is viewed as being between 3 and 5 because of reliability problems of the current prototypes. Present devices have typically only a few hours of autonomous flight. The various AWE technologies, supported by the necessary investments, are envisaged to reach the commercialisation stage in roughly 10 years. The TRL evolution trend is considered 'slow' not only because of challenges yet to be solved, but also because of a general current lack of long-term investment.

At present, AWE requires significant fundamental academic research to get to a required level of maturity, but there is some small-scale commercial investment taking place in the development and testing of devices. Large commercial players are starting to take an interest in the technology and it can be foreseen that this will increase once a level of reliability can be demonstrated.

### 2.1.1. Multiple Drone Airborne Wind Energy Systems

Experimental evidence and physical models show that the performance of flying generators is significantly affected by the aerodynamic dissipation due to drag of the traction cables. Such dissipation sets an upper bound to the effective operating altitude and limits the scalability of the nominal power of the devices.

In this context, Multiple Drone Airborne Wind Energy Systems (MD-AWESs) represent an effective solution that could introduce radically new perspectives in the field of airborne systems [20–22]. An MD-AWES is a crosswind architecture which features multiple drones that are connected to the ground with a single shared cable (see Fig. 2). This aims at significantly reducing the aerodynamic drag of the cables and thus providing a huge potential gain in techno-economic performance.

Preliminary studies of MD-AWES have demonstrated their feasibility. The concept has been investigated by numerical simulation [20–23] and by experimental testing under controlled conditions [23]. More specifically, the multi-drone concept has been proven in models

based on experimental evidence taken on single drone systems, suggesting a TRL of 2–3 for this FET. Their potential upscaling could envisage single units of multi-megawatt class. This could set new perspectives from the point of view of the techno-economic effectiveness of AWE.

The specific challenges of this technology that still need to be investigated are:

- Layout/Architecture choice: the best architecture in terms of number of drones, connections to ground and between drones, type of drones.
- Control: during generation and during the two most critical phases of take-off and landing.
- Design: structural design of drones, flight dynamics, stability, etc.

### 2.1.2. Autonomous take-off and landing systems

Fully autonomous take-off and landing is one of the current technical bottlenecks in the development of AWE technology. Except for vertical take-off and landing systems, this functionality has not been fully demonstrated. Moreover, the possibilities and constraints are very different between soft kites, where a fixed [24] or telescopic mast [25] is usually envisaged to support the wing at take-off, possibly with additional support of a drone [26], and rigid aircraft, where linear or rotational launching concepts have been proposed [27].

In a recent project at ABB Corporate Research (see Fig. 3), a fully autonomous, linear take-off system in compact space for a rigid tethered aircraft has been proved [28]. However, long-term extensive testing in all wind conditions would be required, and the landing phase has not been experimentally investigated yet. For soft kites, automatic launch and landing concepts exist, however their reliability and full-scale applicability have not been fully proven. The main challenge lies in the low speed of the aircraft during take-off and landing, which results in less controllability, coupled with the short tether length and the uncertainty of environmental conditions. The estimated TRL is TRL 2 or 3 depending on whether part of each approach has been experimentally tested or not.

### 2.2. Offshore floating wind concepts

The main innovation of floating wind concepts, compared with mainstream offshore fixed structure mounted turbines, lies with the floating support system. These floating structures have no foundation on the sea-floor, but are instead based on either semi-submersible, tension leg or spar platforms, kept in place by different mooring and anchoring systems [29].

The development of floating wind structures has grown out of existing fixed structure technology (Fig. 4). There is therefore potential

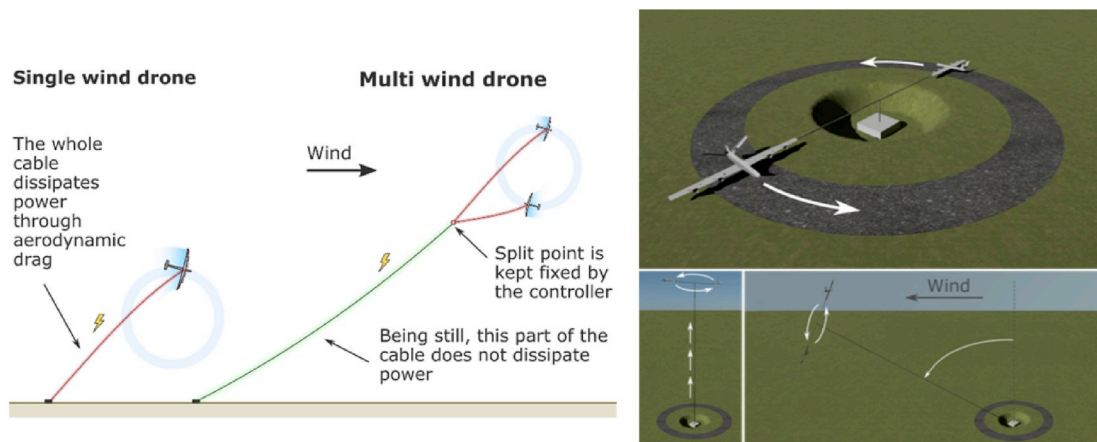

Fig. 2. Left: illustration of the working principle of a multi-drone system. Right: possible strategy for take-off and landing [23].

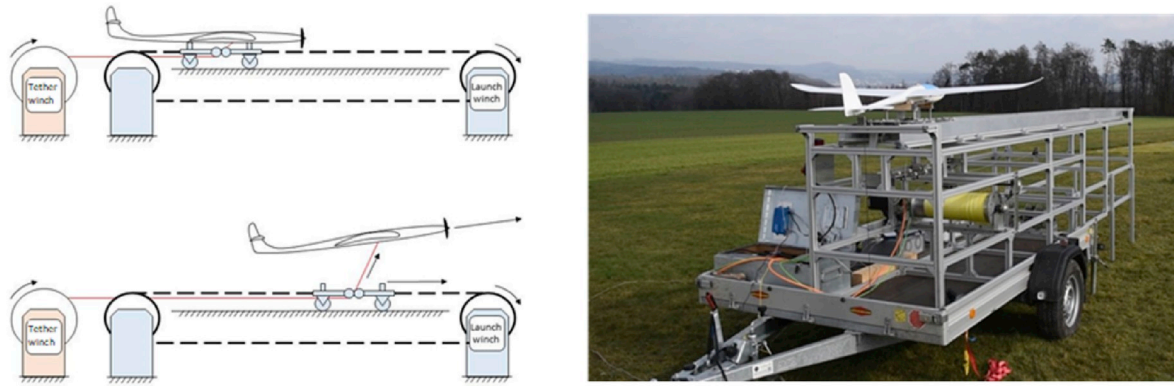

Fig. 3. Left: Sketch of the dynamical model. Right: Picture of the small-scale prototype built at ABB Corporate Research.

for optimisation of floating offshore systems. This optimisation would be possible through the integrated design of the platform and the wind turbine. The more specific, tailored design of wind turbines for offshore floating platforms, including downwind rotors, high tip speed ratio operation and possibly two bladed rotors, could have an impact on the cost of the platform and the whole floating system.

There currently exist a great variety of ideas under development that may ultimately realise lower costs than fixed structure solutions: catenary moored *semi-submersible platforms* [30], the *tension leg platform* (TLP) which has a smaller and lighter structure, but requires a design which increases stress on the tendon and anchor system, (see e.g. Ref. [31] for design considerations); and the *spar-buoy* [32], which is more suited to deeper waters (> ~80 m) [33].

There is a high potential for offshore wind power in deep waters. However, there are difficulties involved in its exploitation. In deep water (60–300 m), there are higher wind speeds, but also higher cabling and mooring costs. Nevertheless, it has been shown that floating designs could achieve lower levelized costs compared with bottom mounted designs due to their lower sensitivity to cost increase with water depth [34]. Floating wind technology is important for countries like the USA (particularly the West coast [35]) and the east coast of Japan [36] which have long coastlines and steeply shelving seabed bathymetries. In these countries, it would be expected that the most relevant technical advances of floating wind technologies will occur.

Floating-turbine design allows for lower transportation and installation costs and lower assembly costs since for some concepts the whole setup (both platform and wind turbine) can be assembled on land and transferred offshore. The difference with existing technology is that at present, assembly is at sea, risking unstable and logistically complex conditions and costly weather downtime. The turbine and foundation for offshore structures comprise approximately 50% of the initial CAPEX cost [37]. The installation and foundation construction of this technology can be dramatically reduced, opening the path for more economic offshore wind energy.

Research and development are necessary in areas related to: additional fatigue loading, possibly reduced by advanced control and innovative design; material and design improvement of mooring and anchoring systems; and platforms (dynamics, size and weight) [38]. In order to reduce weight and costs of semi-submersible structures, which are currently made of steel, there will likely be a need for new materials for floaters. Holistic design of platforms would benefit from further research, such as on high voltage dynamic cables, motion control and active mooring systems. Advanced modelling tools and advanced control systems for pilot installed wind turbines are elements that require further research and development [39,40]. Ecosystem compatibility, symbiosis and societal acceptance are also areas to be studied. The lack of knowledge and practical studies lead to assumptions about floating structure forces and tensions that need to be fully assessed. In general,

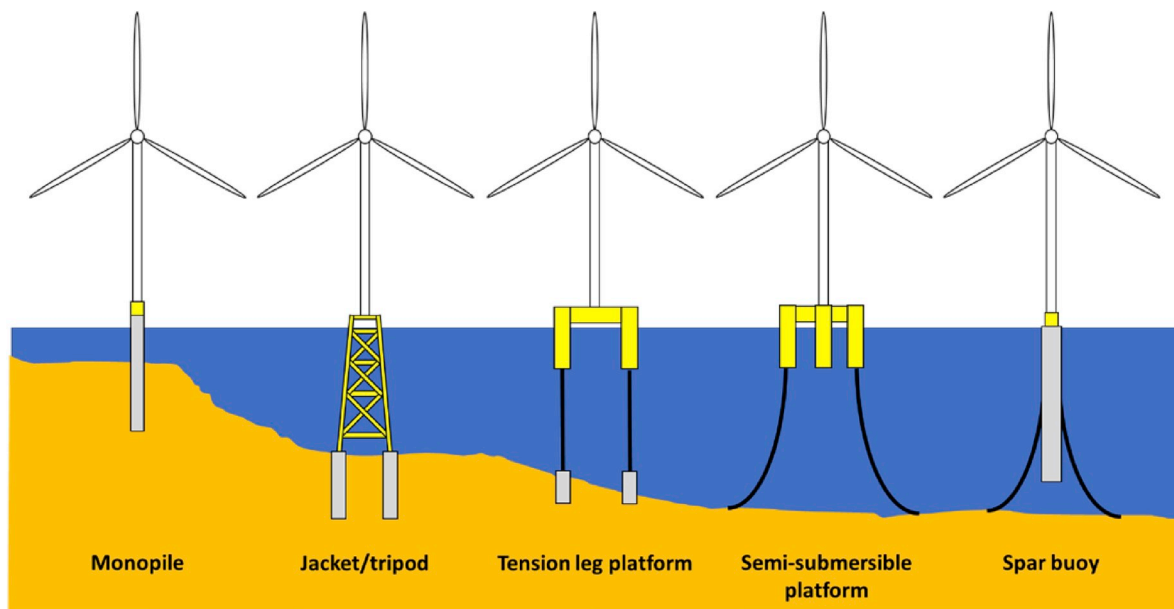

Fig. 4. Offshore platforms.

differences in the environmental impacts are mainly at the installation stage such as the noise from pile hammering. This can be significant for monopiles and jackets, although new approaches could mitigate the impacts such as the use of bubble curtains [41]. The other main challenge is in decommissioning: for fixed-bottom turbines, current practice is to cut the structure just below the ocean floor, i.e. a section of the pile remains in the seabed [42], whereas floating platforms can be towed away, and any drag anchors fully removed.

Floating structures may have to be designed to operate and survive extreme environments, which can significantly impact both capital and operational expenditure. Many of the challenges associated with operating a floating wind farm in deep-water Atlantic conditions have not yet been considered. In general, structural design of floating wind turbine platforms depends on installation location, which needs to be fully analysed and the platform constructed accordingly, restricting industrialised mass production. There is, however, the potential for modular fabrication with assembly in the port which needs to be investigated.

Although currently several offshore floating turbines have been installed in Europe, there are few, if any, wind turbine designs designed specifically for floating concepts. Considering the development trends, Vertical Axis Wind Turbines (VAWTs) could fill a market niche due to their low speed and high torque. If more research is carried out in this field, these turbines could become relevant again. VAWTs are inherently less efficient, but hybridisation with floating devices could be advantageous. A detailed study of the potential aerodynamic and structural integration of VAWTs with floating platforms has been carried out [43–45]. However, from a practical point of view, the integration of a VAWT with a floating platform is considered at a low TRL at present. The TRL of the most advanced floating offshore horizontal axis wind turbines (HAWTs) is between 8 and 9 [46] since spar-buoy and semi-submersible designs are already being built and tested at large scale. However, TLP designs have not yet reached this level of maturity. Most of the implemented technologies have a power of about 6 MW, such as the Siemens turbines used in the Hywind project [47]. The TRL differs if new concepts or components are integrated into the whole system. There are such projects which at present are at a TRL of 4–5 or even lower. For floating platforms designed for very deep waters and hybrid concepts (see Section 2.2.1) the TRL is still at a very low level with only a slow evolution expected.

Fixed offshore wind has shown that larger turbines generally result in lower costs so floating offshore wind would benefit from larger turbines. Theoretically, turbines could be scaled up to at least 20 MW, though future scaling-up difficulties may restrict development to around 10 MW.

Given that a small number of commercially-led demonstrators have now been built, it can be foreseen that larger commercial players will lead the advance of this technology based on the need to develop deeper waters in certain parts of the world. Nonetheless, public research investment will be needed to help support future demonstration projects before a commercially viable concept can be realised.

### 2.2.1. Floating hybrid energy platforms

The maximisation of energy production from offshore sites is critical, both in relation to keeping costs down and minimising environmental impact. This is especially important for the more exposed sites in Atlantic regions, which the wind industry will be moving into in the next decade. Hybrid energy platforms take advantage of synergies and compatible aspects of different energy types or even different technology types within the same industry [48].

An example of combining wind with wave energy is the Blackbird system [49]. This consists of a Storage Base Anchored Uniaxial Hybrid VAWT with a Wave Energy Converter (WEC) supported on a fully submerged Tension Leg Buoy. This hybrid unit consists of a synergy between VAWT, WEC, horizontal sea level generator, submerged WEC system and a single mooring line with integrated cable, moored to the

seafloor via a drilled anchor/suction caisson storage concept.

The European (EU) project MARINA [50] examined more than 100 hybrid concepts, from which three were chosen for more detailed examination. These three concepts were the Spar-Torus-Combination (STC), the Semi-submersible Flap Combination (SFC), and a large Oscillating Water Column (OWC)-array floater. The STC and the SFC concepts add wave energy converters to an existing floating wind turbine, while the OWC array concept is an integration of a wind turbine with a very large V-shaped floating platform [51].

Another type of hybrid is the *wind-wind system*. The development of multi-converter platforms exploits conventional and airborne wind energy converters on the same platform. Multi-turbine floating platforms are already being developed, e.g. SCDnezy [52], presenting a clearer path forward, whereas various types of airborne wind technologies are still in an early stage of development. Airborne wind is itself facing several challenges as mentioned earlier. Assessment of whether tethered airborne systems will work on floating platforms is needed. The design of a stable floating platform allowing efficient operation is critical. In some cases, the platform needs to be very large and, given the lower power generation of kites (at present 100 kW though this could be scaled), it impacts significantly on the cost of energy. Combining AWE with a platform for a conventional wind turbine, if technically feasible, could have beneficial impacts such as better exploitation of the wind resource.

The benefits of hybrid platforms lie in the synergies between the different forms of energy production. The combination of elementary technologies on a single platform may have the potential for higher overall production levels and to share infrastructure, e.g. platforms, cables, substations, etc. In addition, resource analyses for wave energy sites have generally shown that viable sites also have a high wind energy resource. Wave energy tends to be more predictable and less variable than wind energy with the peaks in wave energy production trailing the peaks in wind energy production. This will have the advantage of smoothing combined wind/wave production overall thus increasing energy market value [53]. Hybrid platforms could operate efficiently at most wave energy sites, but floating platforms incorporating only a wind generator can be unstable. The use of the STC helps to stabilise the system, which constitutes a major advantage. Several projects, some of them being in pre-commercial stages, are in place and still have a higher levelised cost of energy than conventional fixed offshore wind, since for the latter the learning curve is based on more years of experience.

These hybrid devices present, compared to the single floating devices, an additional set of challenges and development needs due to greater complexity and reliability problems. The MARINA project has highlighted the challenges associated with the hybrid wind-wave platform design, by presenting a comparative numerical and experimental study for the STC and SFC concepts. It was found that for these concepts, wave energy technology contributed less than 10% of the total energy production of the hybrid platform. In addition, for some combinations, the inclusion of a wave energy converter tended to destabilise the platform, going against the fundamental principles of the platform. For instance, the spar is designed to be hydrodynamically transparent but this is no longer the case when a point absorber is added. The large OWC array had good energy balance but the large pitch motion of the floating platform gave rise to operational and survival problems.

The most developed technology at present would seem to be the hybrid platform with floating wind and wave energy [54], such as the P80, developed in the framework of the Poseidon project (Fig. 5). The P80 project (from the company 'Floating Power Plant') is the upgraded version of the P37 device. P37 is a hybrid wind-wave floating scaled device that has been tested in North Sea conditions having 33 kW of installed wind power and 50 kW of installed wave power. The wave energy converters are heaving/pitching flaps that must always be aligned towards the incident waves in order to maximise production.



Fig. 5. The hybrid wind-wave platform project P80. Courtesy of Floating Power Plant.

The P80 was tested [55] at 1/50 scale (TRL of 4, possibly 5). It aims at a single wind turbine of between 5 and 8 MW and a 2–3.6 MW wave energy converter. The actual power values are low, e.g. the floating power plant P37 has a nominal power lower than 100 kW.

Floating hybrid wind turbines face similar challenges as single turbine floaters, with the additional challenges associated with a more complex system. One of the challenges is the lack of knowledge regarding hybrid dynamics and interaction with the floater. For these devices to work there has to be a clear synergy between technologies.

Wave energy conversion devices are generally at a lower TRL in comparison with single wind devices, lowering the global TRL of hybrid systems. As mentioned previously, the TRL of floating wind turbines is between 8 and 9, while the TRL assessment of several hybrid projects is between 1 and 5. An example of low TRL technology is the Blackbird, a concept system with a TRL of 1–2. The STC technology is estimated to have TRL of 2–3, while systems like the P37 mentioned above, using the SFC technology, could have a higher TRL, i.e. 4–5.

In terms of scaling-up potential for hybrid devices, it can be expected that values should be similar to the those of single technology floating devices, i.e. of the order of 10 MW.

There is a question regarding the synergy of the technologies, i.e. is it preferable or desirable to combine devices rather than have them operating separately? The main value of these combinations may not only be additional power generation but the fact that, for example, wave energy converters can work as dampers by reducing platform motion and loads if the system is optimally designed. This has the potential for reducing capital and possibly operations and maintenance costs which in turn could reduce LCOE. Overall, the development of these technologies is associated with high values of investment which represents a challenge.

### 2.3. Smart rotors

Larger rotor blades make it necessary to consider blade/rotor concepts that can adjust themselves to non-homogeneous wind flow like gusts, turbulence spots, shear, etc. For very long blades, i.e. greater than 70 m, it is very hard to define the optimal operational point, since the

inflow situations may vary quite a lot along the blade. Therefore, a local optimal blade setting, i.e. adjusted to the flow on a scale of metres or tens of metres, makes sense. This could reduce loads, increase or smooth out power output or help in wind turbine or wind farm control. Devices which integrate this type of concept fall into the category of smart rotor technology [56]. This concept could incorporate both active and/or passive load alleviation systems. These are described in the following section.

#### 2.3.1. Passive and active control systems

Passive load alleviation systems are not controlled by operators or automatic systems. They can be distributed along the blade span, e.g. *Bend Twist Coupling* (BTC), or placed in specific regions of the blade [57]. These technologies can use anisotropic (in the case of BTC), elastomeric (coating) and multi-stable materials [58]. Given their characteristics, carbon fibre composites and 3-D printing are essential for the future development of these technologies.

BTC allows a twist of the blade caused by a primary bending deformation [59]. Modular and articulated rotor blades have also been the subject of study, such as the *Segmented Ultralight Morphing Rotor* (SUMR) which employs a *Morphing Downwind-Aligned Rotor* (MoDaR) technology. During extreme weather conditions, these blades can fold together reducing the risk of damage. This concept is intended to be implemented in blades of over 200 m in length for 50 MW wind turbines located in areas with harsh climate conditions. In the USA, a 13.2 MW concept with a TRL = 4 has been developed [60].

The low drag *vortex generator* is another type of passive system. This technology consists of a small vane typically attached to the suction side of wings or blades, where it causes local mixing in the boundary layer and thereby can delay or prevent flow separation [61]. It can be used in to reduce or mitigate separation in the root region and to prevent erosion of turbine blades. Turbine blades with a low drag penalty can be designed with add-ons installed in the outer blade sections, in order to reduce the effect of erosion or roughness changes on the blades. This is the subject of research as part of the European Demo-Wind initiative through the *Offshore Demonstration Blade* project [62].

These passive devices can be included in the design process from the beginning, thanks to modern multi-disciplinary analysis and optimisation approaches or can be implemented in existing blades. They may also be integrated with different types of active control systems.

Blades with movable parts can be considered both passive and active systems. In the passive case, the slats and/or flaps are coupled using only springs without the use of actuators or control systems. *Trailing-Edge Flap Control*, which is currently being demonstrated at MW scale, *Leading Edge Slats* [63] and *Moving Tips* are examples of active control systems [64].

A specific type of active control system is *circulation control* (CC) on wind turbine aerofoils. This delivers compressed air from special slots located on the blade surface. Compressed air dynamically adjusts the aerodynamic performance of the blades, and can essentially be used to control lift, drag, and ultimately power. This system has been shown to exhibit high levels of control in combination with an exceptionally fast response rate [65]. One example is the technology developed by Kohana (see Fig. 6), where a 100 kW prototype was tested.

This rotor ejects air from the suction side surface towards the leading edge to cause separation. This is used as a high bandwidth, fast response control system reducing both extreme and fatigue turbine loads. Another application is to use the ejected air directed towards the trailing edge allowing the generation of enhanced lift. In this case, the rotor blades have, especially on the outboard rotor, elliptical aerofoil sections of very low solidity which are structurally efficient and lightweight. Because of this, they exhibit reduced lift and drag loading when idling in extreme winds. The rotor can be ~30% larger in diameter within the same load envelope of a standard design [66].

*Individual Pitch Control* (IPC) is a multivariable control which uses feedback and feedforward based on estimated wind speed which can



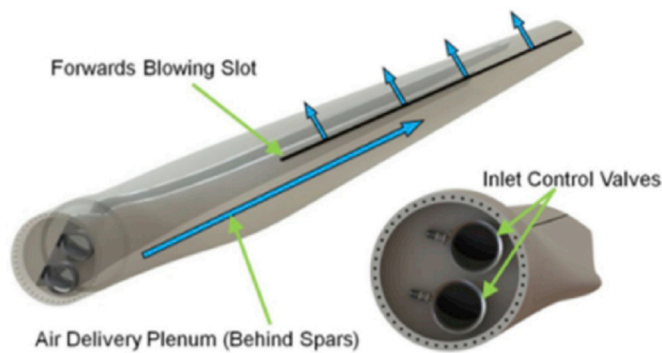

Fig. 6. Circulation control system. Courtesy of Kohana Technologies Inc.

control power production and alleviate loads experienced by wind turbines through pitching the blades individually [67].

Another important feature related to active control systems is the use of the rotor as a wind sensor, which can allow drive and control systems to use the data they themselves provide, e.g. Refs. [68,69].

### 2.3.2. Degree of development, challenges and potential of smart rotors

The main potential of smart rotor technology would be in enabling and scaling up to larger wind turbines (> 20 MW). Scaling up turbine size is seen as a viable option to reduce LCOE as the balance of plant required represents a smaller fraction of the overall capital cost per unit of installed capacity. The synergy between passive load alleviation, active control and the rotor-as-a-sensor technology will enable reductions in weight and fatigue loads. It may also contribute to reducing the cost of energy, extending the length of the blades, increasing the swept area and improving capacity factors. These technologies can be used to re-blade existing operating wind turbines and provide better management of the load during peak usage. Another potential advantage is in improving annual energy production in the latter years of their life without affecting the loads on other sub-components, such as nacelle and tower. Furthermore, the design life of turbine blades can be significantly enhanced by modifying their shape. Potential relevance is for wind turbines in general, especially large turbines, both land-based and offshore.

*Vortex generators* have been used on blades since the 1980s. They can slightly increase the power output. The concept and its benefits, well known in aeronautics and road transport, are still being studied for wind power applications [70,71]. The main benefits lie in mitigation of blade wear and erosion prevention. The erosion control aspect is a new insight arising from this technology. The fact that this can probably be implemented in existing blades is considered a big advantage.

Combining passive and active control is possible, as well as applying these technologies for both VAWTs and HAWTs [72]. The challenges are to fully understand the interaction of these technologies with turbulence, control and turbine dynamics. These are all non-linear problems with a high degree of complexity. Lifetime and cost of movable components and actuators may also present some challenges. It may be challenging to find or develop techniques which can stand the required millions of load cycles with minimal maintenance. The development of equipment and materials to build such blades, and at the same time endure fatigue loading, is another important challenge.

There is a need to improve the measurement of the dynamic wind inflow to drive the active control systems and allow the effective use of smart rotor technology [73]. This can be through better processing of conventional wind speed measurements from such as nacelle-mounted cup anemometers and wind vanes or through the use of remote sensing data from lidars or spinner-mounted sonic anemometers [74]. The use of high-fidelity computational fluid dynamics (CFD) codes could be significant in defining the 3D wind field approaching the rotor. The measurement and processing of strain on the blades also has an

important role to play as input to smart rotor solutions [75].

Developing efficient pumping systems and high efficiency variable speed fans, is one of the challenges for CC systems. Fan technology is extremely well developed but predominantly for operation at relatively constant loads. The development of economic designs of very low solidity elliptical aerofoils, with accurate manufacture of the slots for air delivery, is a particular challenge. The use of carbon in the elliptical blade sections may prevent undue flexibility that could result from the sections being optimally of very low solidity. Effective aeroelastic modelling of the circulation-controlled rotor and integration of a reasonably controllable pressurised pumping system also need R&D resources, although no fundamental problems are anticipated. Optimisation of control will obviously be of major importance and will involve new challenges around pumping power costs, load regulation and energy capture. The added cost to rotor systems of CC is not yet known but an outline cost of energy calculation indicates that there can be net benefit even if rotor costs are escalated by a factor as great as 4. Outline calculations suggest that pumping power demand is typically lower than 10% of the overall energy generated. By expanding the rotor size without increase in loading it is possible to obtain more annual energy output than a standard rotor. Technology is established but substantial further work on integrated design and structural blade aspects is required. CC system technology is heavily patented, even if many patents are generic. Since research in this field is mainly performed by the industry it is difficult to correctly estimate its TRL (2–3 in the public domain, maybe higher).

The IPC and BTC, individually and together, have been wind tunnel tested, which would imply a TRL of at least 4. Depending on how the blade is designed, the TRL of BTC may vary. In the more mature cases, the TRL of BTC is 5–7, since some specific technology has been tested at large scale, but it has not reached the market yet. Some manufacturing techniques are not viable at the moment; several components have to be hand-made since there is not an industrial manufacturing process.

If a solution for the challenges is found, the TRL evolution can follow an average to possibly fast track if there is disclosure of some of the confidential information required. For most of these technologies, the expected time-scale for scaling up applications is of the order of a decade. The BTC technology should reach the market in 5 years. Most advanced turbines being developed now have a nominal power of 12 MW and the scalability can go to 10–50 MW. Some of these technologies have to compete with each other for funding and this could influence the pace of the TRL change.

Although industry is leading the development of some of the smart rotor technologies and patents have been filed, several innovations are still very much at the fundamental research stage. At this point, it is difficult to say which technologies are likely to succeed in the longer term and significant public research money will still be required to assess some of the more speculative innovations.

### 2.4. Wind turbine with tip-rotors

This conceptual technology consists of wind turbines where the traditional torque transmission by gearbox and generator is substituted by a fast-rotating rotor/generator mounted on the tip region of each blade (see Fig. 7). While conventional turbines extract power at a free wind speed of around 10 m/s by conversion of torque, the tip-rotor converts power at around 70 m/s. The concept can be designed for both two- or three-bladed turbines [76].

The efficiency of the tip rotors to convert power could be close to 100% at low tip speed ratios, as the usual Betz limitation of 59% does not apply for the moving tip rotor [77]. This is because it is the *thrust* of the tip rotors which is providing the reaction torque to the primary rotor causing them to extract power as they move. It can therefore be shown that in the idealised Betz model case [77], the ratio of the power extracted by a tip rotor to that extracted by the primary rotor is  $C_p/C_t = (1 - a)$ , where  $C_p$  is the power coefficient of the tip rotor,  $C_t$  is



Fig. 7. Schematic of a possible demonstration scale 11 kW turbine with tip-rotors.

its thrust coefficient and  $a$  is the axial induction factor from idealised actuator disc theory. If the tip rotor were itself optimised, then  $a = 1/3$ . This would imply the overall efficiency of the tip rotor to be the optimal efficiency of the primary rotor multiplied by  $(1 - 1/3)$ , i.e.  $(16/27) \times (1 - 1/3) = 0.395$ . If the overall efficiency were determined by each rotor operating at the Betz limit, i.e.  $(16/27) \times (16/27) = 0.351$ , it can be seen that this configuration has the potential to slightly exceed this value. However, this would necessitate relatively slow-moving and large tip rotors which would defeat the object of the design so in practice any design would sacrifice efficiency somewhat to have relatively low weight, high speed tip rotors [77]. It has been demonstrated by Siemens that direct drive generators for e-propellers for aircraft can reach a performance of 5 kW/kg [78]. This suggests a two-bladed 10 MW turbine could have two generators in the tip-region with a weight of 1000 kg each. This value is considered relatively low in comparison to the blade weight. The drive train for a typical 10 MW turbine will have a weight of the order of several hundred tonnes. This significant mass reduction has the potential to reduce capital costs.

Since wind turbines with tip-rotors do not require a main shaft or gearbox, this technology aims at cost and weight reduction, being particularly beneficial, for example, for floating offshore concepts. It may be possible to make the main rotor with a fixed pitch, downwind, free yawing, teetering rotor and possibly with extended pitchable blade tips.

Noise and erosion of the tip-rotors are the two main challenges associated with the anticipated high speed of the rotor, together with centrifugal forces on the tip rotors. The aerodynamics and aeroelastics of this concept are more complex than for conventional turbines, whereby specific rotor blade shapes and materials need to be developed and investigated.

The concept is more suitable for very large wind turbines, since larger turbines have fewer challenges related to the centrifugal forces on the rotors. This technology may be more appropriate for the offshore environment, given the additional noise and visual impact compared with conventional single rotor turbines.

Concerning the degree of development of this technology, no prototype has yet been constructed or tested. The TRL of such a concept is thus 1–2 with a possible scalability of the same order of magnitude as for a conventional 10 MW offshore turbine. A slow TRL trend is



Fig. 8. Vestas multi-rotor wind turbine. Photograph courtesy of ZX Lidars.

anticipated since investors are reluctant to fund the technology due to its radical and high-risk nature.

This form of technology is clearly at a very fundamental level of development with only very basic paper concepts produced. There is the need for detailed concept studies to be publicly funded in order to assess the challenges and potential for this form of wind power generation device before any industrially-led developments can be expected.

## 2.5. Multi-rotor wind turbines

To improve efficiency and reduce overall loads on a wind turbine it is possible to replace a large single rotor with a multiple-rotor system (MRS), as shown in Fig. 8. This innovative solution could allow a large power system (20 MW or more) to be installed at a single site by means of a high number of standardised rotors. As mentioned above, scaling up is seen as a key factor in overall cost reduction.

With individual control of rotors, it is possible to respond to a turbulent wind field across the device, allowing for more efficient generation and with the potential to alleviate loads. Possible advantages of the MRS can be to mitigate structural and material problems associated with the scaling up to a large device. There is also the possibility of yawing without the requirement for a separate mechanism.

Optimum rotor size is likely to be determined by operations and maintenance logistics rather than aerodynamics. Overall design optimisation is interactive with aerodynamic, electrical, loading considerations and other factors. Turbines can be clustered to reduce some electrical costs, but the independent operation of each turbine maximises overall load reduction [79,80].

A major advantage of this technology is in the standardisation [80]. The production process of smaller rotors could be industrialised and could have lower costs while present production methods of large turbines require customisation. Moreover, in the case of malfunctioning of one rotor this does not imply any interruption of energy production from the working rotors of the array. For the same total swept area as an equivalent single rotor, power efficiency can increase.

Within the framework of the EU INNWIND project, a 20 MW multi-rotor concept was modelled (TRL = 2). This MRS design (45 rotors with 440 kW power each) was compared to a reference single 20 MW turbine [79,80]. The MRS power production was estimated to be 8% higher than a single rotor system of the same overall swept area [80].

Detailed designs for maintenance are needed to optimise logistics and evaluate operations and maintenance costs more reliably. Reliability studies have shown that, while there can be a large maintenance advantage in having much smaller components [81,82], avoidance of the use of jack-up vessels is critical to have effective design to avoid minor failures. The outline concept within the INNWIND project was to have a built-in top-level travelling crane that could handle each rotor nacelle system automatically and lower to base level.

The modelling of an MRS is challenging and needs more development. Aerodynamics are an important area which need further research [83]. The design tools for turbulent wind loading and aeroelastic behaviour of a multi-rotor system are at a very preliminary stage. Active control and structural vibration alleviation present particular challenges. There is a need to improve design, modelling and reliability due to the increased number of components.

In terms of scaling up the size of a wind turbine and reducing costs, this machine offers higher power extraction efficiency on average, potential fatigue life extension and reduction in material scaling problems [84]. There has been work, e.g. Ref. [85] to develop three and seven rotor concept systems for small scale applications. The most advanced European project exploiting this technology is a 900 kW four rotor-turbine developed by Vestas. This project appears to have a TRL of 5–6. The TRL of most multi-rotor turbines is between 2 and 4. Scalability should be of the order of 20 MW but it could reach higher levels. Further work on modelling and complete system design is needed, after which the technology could evolve at a fast pace.

As there has been a commercial demonstrator of this technology as mentioned above, there is clearly potential for industrial funding of research to bring this technology to maturity, supported by public funding to tackle some of the more fundamental challenges associated with aeroelastic design and control.

## 2.6. Diffuser augmented wind turbines

Diffuser Augmented Wind Turbines (DAWTs), also known as wind lens or shrouded wind turbines, are HAWTs which possess a diffuser-type structure resembling a funnel, able to collect and concentrate the approaching wind. The diffuser can be modified by adding a broad ring or brim around the exit point and an inlet shroud at the entrance, thus creating a 'lens effect'. This design increases diffuser performance and it has been demonstrated as producing increased power compared to conventional turbines, for a given turbine diameter and wind speed [86]. There could therefore be a potential for LCOE reduction compared with an un-shrouded machine, but only if the cost of the diffuser is less than the cost of making the rotor larger in order to provide the equivalent power output. This remains a significant challenge. Other more tangible potential benefits are a possible reduction in airborne tip noise or the opportunity to make the machine less visible by embedding it within a building structure, though structure-borne noise remains a challenge.

DAWT devices are at a semi-commercial level of development in Japan, with power ratings of the order of tens of kW. The most advanced projects have been developed by Kyushu University, who have studied several configurations, from single DAWTs to multi rotor systems (see Fig. 9), with a maximum tested power of 100 kW [87]. In addition, tests on floating platforms were performed in Hakata bay.

Multi-rotor DAWTs appear to display convincing performance with the typical challenges of MRS, enhanced by complex interactions with the diffusers [87]. These interactions with optimal spacing can be very beneficial but perhaps due to unsteady effects, the geometrical symmetries do not always correspond to flow field and rotor performance similarity. Structural loading is a challenge for cost effectiveness of all diffuser augmented systems, single-rotor or multi-rotor. Whether there is the potential to have larger compensating energy gains and lighter total rotor and nacelle systems with multiple rotors still remains a topic of research.

Although this technology is not likely to be significantly cheaper than the non-ducted technology, it could be suitable for a niche-market.

The TRL is around 5–6, with a scaling up target of 1 MW. The TRL evolution is expected to be 'average'.

This type of technology will be more suitable for smaller scale applications and it is not expected that there will be major industrial investment in associated research in the near future. Public funding for this technology needs to target niche applications such as the urban environment.

## 2.7. Other small wind turbine technologies

The following non-mainstream concepts are briefly reviewed, namely, wind turbines based on *magnetic levitation*, *innovative vertical axis* and a *cross axis design*:

- Magnetic levitation (also MagLev) wind turbines use full-permanent magnets to attempt to eliminate friction through levitation of the blades [88] (see Fig. 10(a)). This technology is quite advanced (TRL = 8) for small power applications (~kW). One of the major challenges of this technology is the low techno-economic efficiency and the limited suitability for scaling up [88].
- Vertical axis wind turbines (VAWTs), as the name suggests, have a vertical shaft around which the rotor turns. In most recent applications, these have been developed for offshore applications [89] as shown in Fig. 10(b). VAWTs, with intrinsically lower optimum rotational speeds, are penalised by producing relatively high torques with cost and mass implications for the drive train. An interesting idea to avoid this problem is using secondary rotors which can exploit the tip speed of the VAWT rather than dealing with very low shaft speeds and very high torque.
- The Cross Axis Wind Turbine (CAWT) extracts wind energy from airflows coming from the horizontal and vertical directions [90] (see Fig. 10(c)). The CAWT is not necessarily a novel concept but innovative designs are emerging, perhaps interesting for niche applications, particularly important in the context of urban use of wind energy.

Most of these technologies are for low power applications ('small wind'), being suitable for urban environments, perhaps embedded in buildings. It is envisaged that there could be applications for niche markets. Cost reductions here could result from more efficient designs, cheaper manufacturing and materials, cheaper installations and



Fig. 9. 10 kW multi-rotor DAWT system installed in Japan. Courtesy of Kyushu University and Riamwind Corporation.

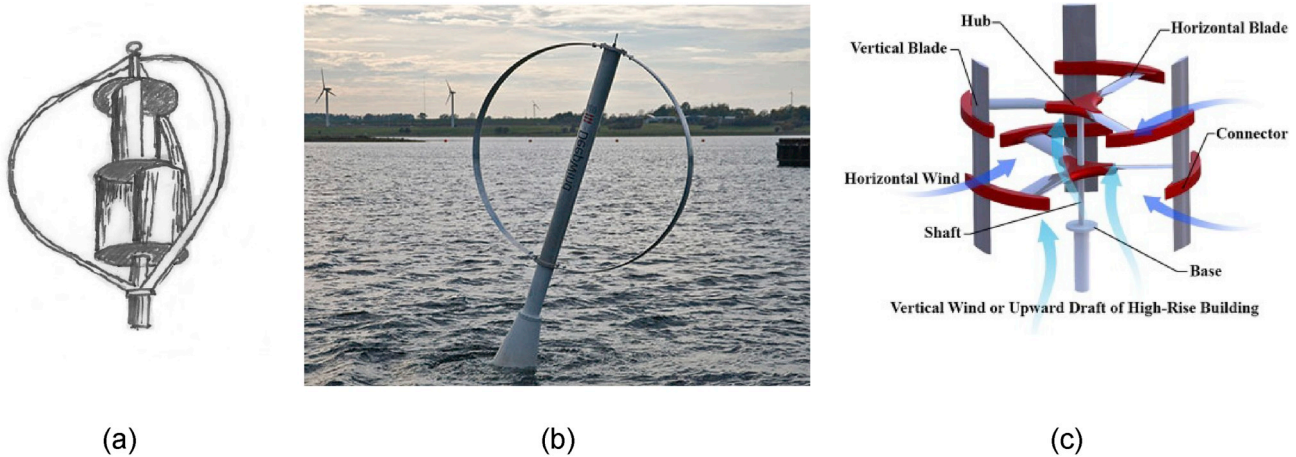

Fig. 10. Examples of: (a) magnetic levitation; (b) innovative vertical axis (Courtesy of DTU wind energy) and (c) cross-axis wind turbine [91].

economies of scale.

The main challenges of these technologies are not only technical, but also the noise, aesthetics and societal acceptance need to be addressed. Moreover, in some cases there are apparent legislative challenges [92,93].

At the present time, it is difficult to assess these technologies in terms of TRL or power generation scale. In terms of future research investment, similar comments can be made as for the ducted technology, although some of the concepts described above are at an even earlier stage of development and will need public funding to assess their full potential.

## 2.8. Wind induced energy harvesting from aeroelastic phenomena

Air flow-induced vibrations of mechanical systems can be exploited to extract energy, when specifically designed to experience large-amplitude oscillations. The mechanical system has to be combined to work with suitable energy-conversion apparatus, such as electromagnetic or piezoelectric transducers. This type of technology will not be used for large-scale generation, but for applications where a small amount of autonomous power is required, e.g. wireless sensors or structural health monitoring. These energy harvesting devices have possible applications in urban settings and for energy harvesting at small and micro-scales. The LCOE for such devices will remain high compared with the much larger scale wind power generators, but for very small scale applications, may be cost effective.

Among fluid-structure-interaction phenomena [94], those considered suitable for energy harvesting applications include: (i) dynamic instability of classical flutter [95], (ii) interference between vortex-induced vibrations (VIV) [96,97], and, (iii) dynamic instability or galloping [98–100].

Flutter-based devices involve a rigid, streamlined model (a simple flat plate or aerofoil) of finite length, which is elastically suspended to oscillate along two degrees of freedom: heaving (cross-flow translation) and pitching (rotation). The energy extraction is activated in the heaving motion component, being less sensitive to a damping increment. Linear generators, typically solenoids, are used (see Fig. 11). Depending on the application, different governing parameters can be selected. The design configuration can be adapted to specific operating ranges of flow speed.

VIV and galloping-based devices involve a rigid, finite-length model with a bluff cross section for the generation of vortices. The model is schematically shown in Fig. 12 for the case of ocean current-induced vibrations showing that a bluff body can be elastically suspended to oscillate in the cross-flow direction only. This principle, with appropriate tuning of the system, could equally be used to harvest energy from the wind.

For these technologies, the energy harvesting performance mainly

depends on:

- the flow speed at which the device starts to operate (cut-in velocity), which should be as low as possible;
- the motion amplitude, which should be as high as possible;
- the damping level, which dictates the proportion of energy flowing on to the next conversion device.

The last point is critical, since the added damping due to energy harvesting can attenuate the flow-induced vibrations, i.e. the Scruton Number may increase, leading to the vanishing of vortex shedding [101]. Electromagnetic transducers have a better performance when working with large-amplitude motions at low frequencies, while piezoelectric transducers perform better at higher frequencies.

Research has mainly focussed on flapping foils, with either semi-active control or fully-passive motion; in the latter case, classical-flutter-based devices [102]. The efficiency predicted through theoretical analyses or computational simulations is high (up to 30–35%) and may be competitive with other technologies. However, the efficiency is currently lower than 5%, with a low TRL and a power per unit length of 2 W/m, obtained with a 10-cm wide plate oscillating at about 2 Hz in a uniform flow at 10 m/s [97].

The technology based on flutter can be considered as a fully-passive version of the more studied flapping-foil technology not requiring an

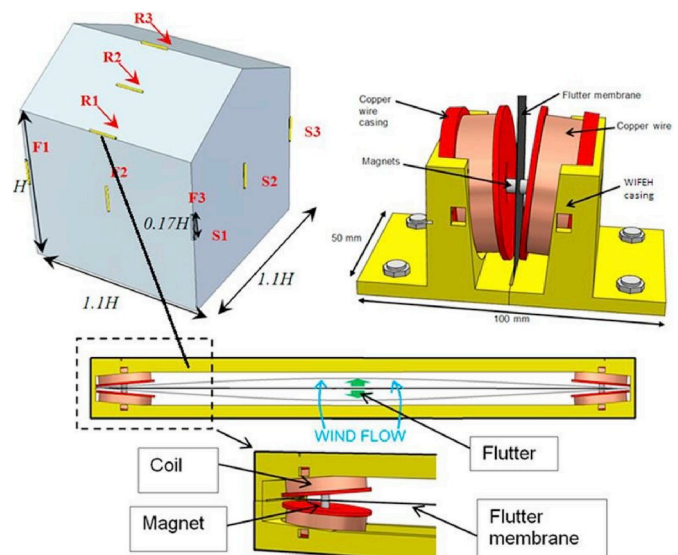

Fig. 11. Flutter vibration energy harvester [95].

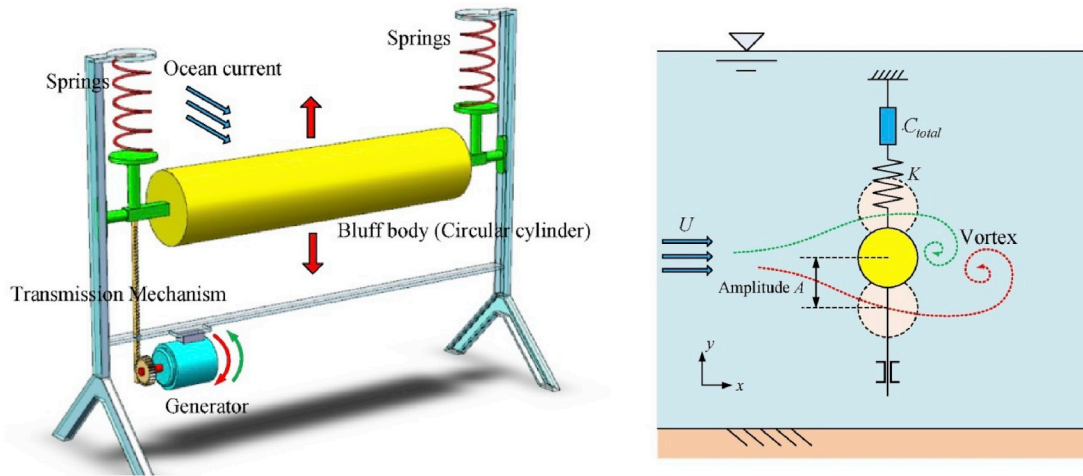

Fig. 12. Device exploiting the vortex induced vibration principle from an ocean current [96].

active control mechanism to operate. Scientific research on the post-critical regime of flutter still needs development. The TRL for flutter-based devices is 2–3. These devices are still at laboratory scale, where the conversion apparatus is often simulated through dampers. Effective prototypes that can also generate energy are still to be developed. This technology has potential applications in urban environments (see Fig. 11) and turbulent situations, since preliminary tests have shown that high levels of turbulence intensity and large turbulence scales have little influence on the system response [102]. There have been some conceptual projects. An example is the piezo-tree, a tree-shaped device with piezoelectric leaves based on fluttering technology. The concept presented several challenges such as very low power output and problems of electrical integration. Future research should focus on the aerodynamic properties of the cross section and on optimisations such as the reduction of mass ratio, to further enhance the amplitude of the motion and to widen the operative range. From the perspective of real applications, devices that contain a single oscillating system or an array of them can both be conceived. However, installations of multiple systems still require investigation of possible interference effects.

VIV excitation only devices have typically a narrow operational range, are generally unsuited to variable flows, and are very sensitive to design [94,96]. Based on this concept, the company Vortex Bladeless is developing and testing demonstrators including a 100 W nominal power device, the Vortex Tacoma [103]. Devices based on the interference between VIV and galloping present a larger operational range. Recent studies have explored the interference of vortex-induced vibration and galloping, with results that can be positively exploited for low-power energy harvesting systems [104]. An example project (on the upper scale of TRL) is the European Space Agency funded project “piezoTsensor” [105].

The TRL of VIV-galloping devices is estimated to be 2–3, and for VIV 3–4 with a slow trend for development. Some devices have a nominal power of 2 W/m, with others of the order of 0.1 W/m, therefore power upscaling is likely to be low.

Because of the niche nature of these technologies, much of the research is still at the academic level. There is little commercial development at present. The challenge will be to channel public research funding into those niche applications which show the highest level of promise.

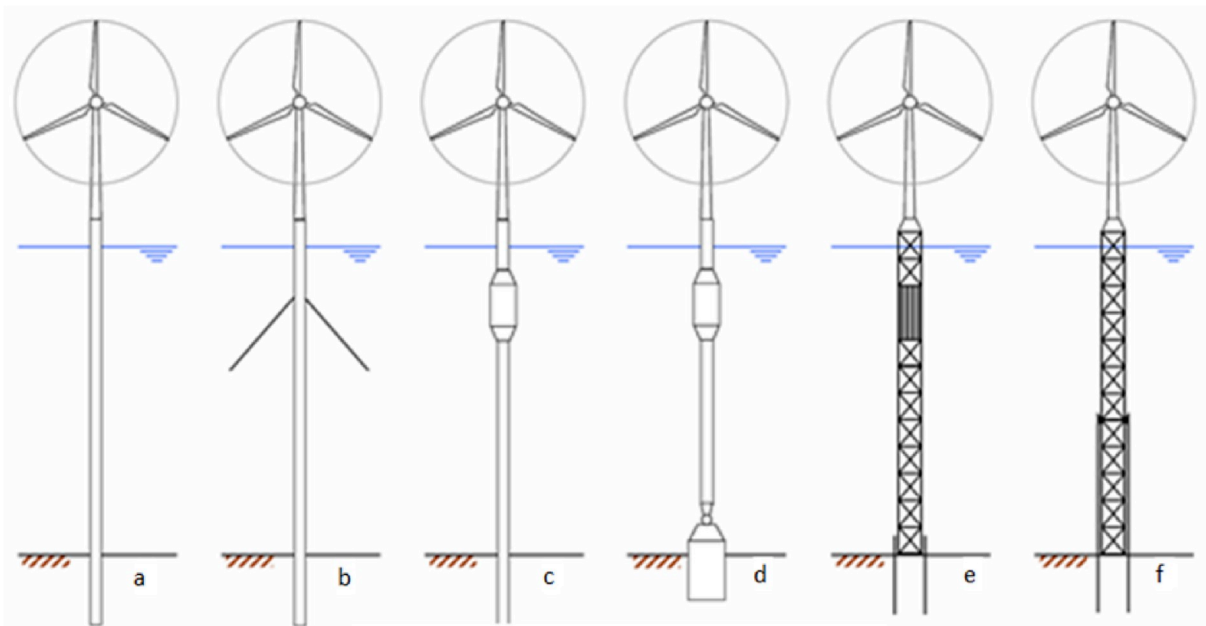

Fig. 13. Compliant tower concepts for the offshore wind industry: (a) Slender monopile (‘dumb tower’), (b) Guyed tower, (c) Buoyant tower, (d) Articulated buoyant tower, (e) Tower with mass trap, (f) Compliant piled tower. Courtesy of W. de Vries [109].

### 3. Future supporting technologies

#### 3.1. Alternative support structures for wind turbines

Current support structures for fixed bottom-mounted offshore wind turbines to date consist mainly of monopiles, although a number of gravity base solutions and jackets have been employed, as well as other concepts (see Fig. 13). A number of unconventional designs have been suggested as alternatives in the literature such as suction bucket jackets and suction caissons [106], but others have not been studied well enough to date. Alternative fixed bottom support structures, self-rising lattice towers and new materials for towers and support structures are discussed in this section. These have the potential to reduce LCOE by reducing the volume and/or the mass of the material required and by making installation simpler and cheaper.

With the rapid acceleration of offshore wind energy, it can be expected that research in this area will be industrially led, supported by public sector funding where appropriate.

##### 3.1.1. Alternative fixed bottom support structures for offshore wind

A number of alternative fixed bottom-mounted support structure concepts exists. Here we focus on two of the most promising alternative support solutions. A first option is the use of a compliant structure (see Fig. 13) that has its first eigenfrequency below the main wave frequencies, in contrast to the usual design where it is higher. Such a wind turbine is a compromise between a fixed and floating structure, a concept also referred to as a semi-floater. The structure attracts relatively low hydrodynamic loads and is therefore attractive, but due to its complexity, it has not been a popular choice so far [107]. The connection to the foundation needs special attention and might need to rely on novel solutions such as an articulated joint [108].

Another example is the use of a full lattice tower, replacing the usual wind turbine tower with a multi-member braced structure. This is also used for jackets or as part of certain semi-floater designs as shown in Fig. 13 e-f. Bolted lattice towers were the preferred solution for small, onshore turbines, before the circular tower began to dominate [110]. Part of the reason for this was the high stiffness (reducing vibrations) and the ease of assembly using bolted connections, whereas drawbacks are the many connections, the difficulty of safe access to the turbine and aesthetics, the latter being less of a concern offshore. Although welded cylindrical towers have solved most of these problems since the 1980s, lattice structures could be more suitable in building taller wind turbine towers, since they benefit from being robust enough with much less material used, while giving the flexibility in transportation of the cross-sections on site and their ease of mounting.

The innovation of these concepts would be in their use offshore. In this case, a number of challenges will need to be met, including: mitigating the risk of corrosion, using different profiles and connection methods than onshore and the development for use with much larger turbines than the technology has been used for before [111].

This concept is attractive to address structural frequency response problems that can be seen with circular towers for very large wind turbines which become 'too soft' [112], but also in terms of reducing the weight of the wind turbine system or providing a more efficient connection to the foundation, i.e. removing the need for a dedicated transition piece.

##### 3.1.2. Self-rising towers

The production of wind energy could increase with larger wind turbines on higher towers. Lattice structures could be more suitable for building taller wind turbine towers, even if there is a lack of very high cranes for erection. Self-rising lattice towers are suitable for horizontal axis wind turbines both in onshore and offshore applications, constructed by raising each tower subsection from the prior lower tower section. Their advantage is that there are no large cranes necessary for the installation of the tower. Tower subsections can be mounted and

lifted to their final position with the aid of frames and the use of small size cranes and/or cables [113].

The two main EU projects on this self-rising concept are HyperTower [113–116] and SHOWTIME [117,118]. The HyperTower project aims to optimise the design of self-rising lattice towers that are ideal for onshore wind farms while the SHOWTIME project focuses on the design of hybrid towers. These hybrid towers are suitable for offshore locations where the bottom lattice part is connected to the tubular shell upper part by means of a transition piece that is carefully designed to sustain both wind and wave loads.

##### 3.1.3. New materials for towers and support structures

Current wind turbine towers and support structures are constructed from steel and/or concrete. The steel is typically the same grade as used in the construction industry. Higher grades of steel can offer better structural performance (strength, buckling resistance) and lead to lighter structures. Hybrid solutions [119] using both steel and concrete and the use of alternative materials such as wood, aluminium [120] or especially composites, e.g. reinforced materials, or sandwich structures [121], can offer similar advantages in performance.

##### 3.1.4. Degree of development, challenges and potential of alternative support structures

The advantage of alternative fixed bottom-mounted support structures is based on more efficient connections between tower and foundation. A full lattice structure is quite strong even for high towers while monopiles become too soft when taller, with 20 MW turbines or larger anticipated in the future. This technology offers a more integrated design and flexibility. Similarly, the compliant support structures follow a different strategy to reduce wave loading and resonance problems, thereby leading to a lighter structure. Lattice structures are lighter than tubular versions and provide opportunities to transport tower parts to site more easily for assembly and installation.

This technology poses severe challenges, as the system behaviour is of critical importance for a wind turbine. The main challenges related to these concepts are understanding the complex dynamics, especially in the interaction with the rotor, challenges related to manufacturing, e.g. reducing welding costs, safe access to the turbine and installation techniques, particularly offshore.

The TRL of these alternative fixed bottom-mounted support structures is estimated to be TRL 1–3, since most of the research has been limited to concept studies and structural analysis based on numerical simulations, e.g. Refs. [108,122]. An exception is the 2B6 downwind 6 MW wind turbine that has been tested since 2015 in an onshore demonstrator project. This particular concept is therefore at TRL 7–8. Lattice towers have been employed commercially at TRL 9 for onshore turbines up to 2.5–2.75 MW (with the Fuhrländer FL2500 and the GE 2.75–120 turbines). However, there is a non-trivial challenge to adapt these designs for offshore applications and new turbines that are much larger, potentially scaling up to at least 30 MW, and which will behave much more dynamically. This requires new, innovative solutions for the structural design, the control, and the installation.

The use of micro-cranes for self-rising wind turbine towers could allow assembling such lattice towers on-site with lower installation costs. Since the small sections can be transported with conventional vehicles, in contrast to those required for long tubular tower sections, the transportation costs are also reduced. This technology is still at conceptual and testing stage, with no commercial structure designs released in Europe, though a hybrid monopile-lattice self-erecting tower is under development by Nabrawind of Brazil. For these reasons the present TRL of this technology is 2–5, though there is an ongoing project to build a demonstration telescopic tower as part of the EU Elican project which would be at a higher TRL. The idea of using a telescopic tower to simplify the installation of an offshore monopile wind turbine has been studied, though a number of assumptions were made that would need to be addressed for a viable solution to be

developed [123].

To allow the development of this technology, more research would be required on materials and suitable beam sections. There are plans to carry out laboratory tests on cross sections, using performance data to build tower numerical models. Considering the current rotor technology and the design of this kind of support structure to date, a limit of the order of 30 MW is estimated.

Hybrid composite solutions for towers and support structures offer a lighter and stronger structure, especially important for onshore wind energy. Additional advantages include shorter assembly times and easier transport. This can influence turbine design positively, leading to assembly cost reductions, even if offset by currently higher material costs. Some drawbacks that need to be considered are related to manufacturing, since more complex processes, welding and surface treatments would be required to produce such composite materials. Because such materials are not widely in use, there are more uncertainties regarding structural safety, e.g. fatigue behaviour, compared to standard designs. Consequently, there is a conservative view regarding the current design standards. The use of novel materials may require modification of these standards and guidelines. There are insufficient incentives to study the strength and behavioural limits of these materials.

Some concepts are at a preliminary stage of study (TRL = 2), or at an intermediate level, e.g. the Hexcrete concrete tower concept [124] which has been validated in the laboratory (TRL = 4). Other concepts are almost commercial, e.g. the Elisa self-installing tower developed during the Elican project [125] was recently installed at the PLOCAN test site with a 5 MW wind turbine (TRL = 6–7). For the latter, the aim is to reduce costs to make them economically viable. These concepts, with weight reduction, could find a potential use for offshore and floating applications.

The fact that TRL level is judged to be low in some cases is because the implementation and adaptation of these support structure technologies on wind turbines is new. Small changes in one component can have significant impact on the overall wind turbine design that need to

be fully understood before higher TRLs can be achieved. For all the technologies, the development rate would be considered as ‘average’.

### 3.2. Unconventional power transmission for wind turbine rotors

Current wind turbines generate mechanical power from aerodynamic forces on the rotor, which turn a shaft that drives an electro-mechanical generator. Although the efficiency of the electro-mechanical conversion is high, the variable rotational speed requires a frequency converter to connect each turbine to the power grid. Other challenges include reliability problems with mechanical gearboxes or, in the case of gearless turbines, the weight of the directly driven generator as turbines become increasingly large.

It is possible to replace the mechanical gearbox using a *hydrostatic transmission system* [126,127]. Such a system also has the possibility to provide continuous speed, torque and power control, removing the need for a converter. Alternatives to conventional electro-mechanical generators are *hydraulic transmission systems* (see Fig. 14) or *compressed-air technology* [128,129].

The main advantages of these technologies are lighter nacelles and the possibility to include energy storage options in the case of hydraulic and compressed air systems. Lighter nacelles reduce the amount of material required for the support structure thus reducing capital cost. Integrated storage options increase the value of the energy converted. Both of these factors have the potential to reduce LCOE. The main challenge is the reduced efficiency of hydraulic or compressed-air systems compared to electrical conversion, which could be addressed by a central conversion plant collecting power from several turbines. However, the reliability of such a complex system is still a challenge. Material and design challenges also need to be addressed.

The most advanced project was a Scottish-based turbine with 7 MW of nominal power [131]. This seems to have a well-established TRL (4–7), having already been tested using a scaled prototype in an operational environment. The development ceased soon after Mitsubishi Heavy Industries formed a joint venture with Vestas to focus on the improvement of the more conventional Vestas 8 MW turbine, latterly scaled up to 9.5 MW. The risks and uncertainties connected with the new technology might have outweighed the benefits. However, it is likely that the technology might be offered as an option for the new turbine at a later stage. There are other projects exploiting this technology; some of them never went beyond the concept stage (TRL 1–2), others were tested at laboratory scale, with some simulations for full size wind farms (TRL = 3–4), with power not exceeding 1 MW. An

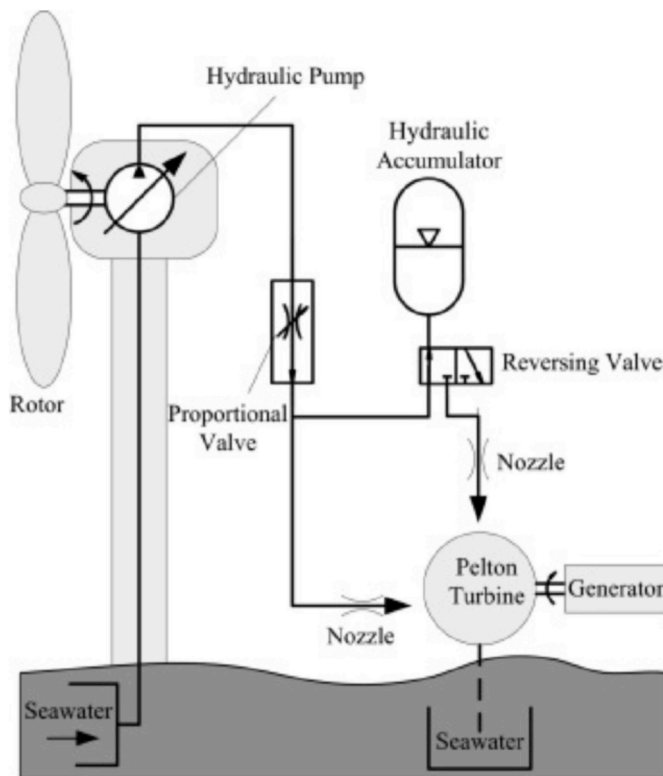

Fig. 14. Schematic of a hydraulic transmission system for wind turbine with energy storage [130].

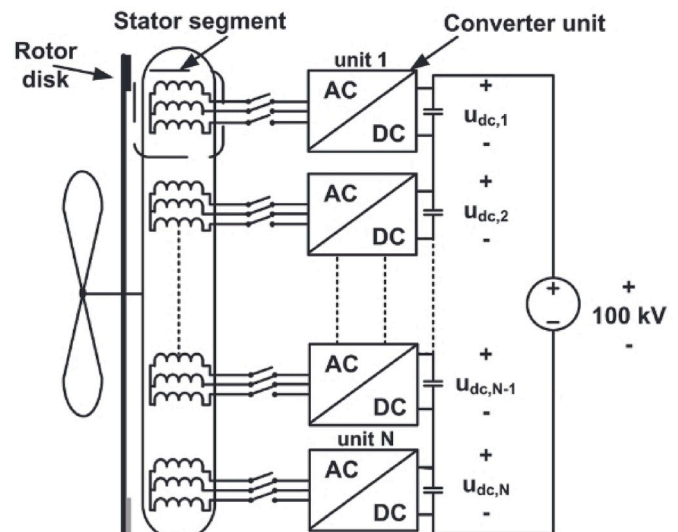

Fig. 15. Overview of a modular series connected converter [133].

example of a prototype which is currently being developed is the 500 kW machine developed in Delft, i.e. the Delft Offshore Turbine [132].

This technology only makes sense when deployed at large scale. The potential for scaling up is around 100 MW but the TRL trend is slow.

### 3.3. Modular HVDC generators

High-Voltage Direct Current (HVDC) systems can bring advantages to offshore wind energy transmission by eliminating capacitive losses in the underwater power cables. The modular high voltage generator concept could produce HVDC electricity by connecting in series, rectifying and increasing the tension of different sections of the electric wiring of the wind generator's stator (see Fig. 15).

A voltage output of 100 kV and higher is possible with this type of configuration [133,134]. This concept has been verified experimentally using a 45 kW prototype with three generator segments and three converter units in series [133].

The modular HVDC generator concept has the potential to reduce the size and weight of the electrical machines used to generate energy, to increase the voltage and to rectify the power produced by offshore wind. This system could provide direct HVDC production, instead of relying on more complex systems needing AC generators, AC/AC transformers and AC/DC converters. When DC transmission systems are required, fewer conversion steps could result in lower losses, lower investment cost and higher system reliability. All of these factors could contribute to a reduction in LCOE. This system might increase the energy yield from a wind farm by 3%–7%. With higher 'up-time' of the turbines, it could be possible to keep producing electricity even when sub-modules fail.

The main challenges consist of: improving power/weight and power/volume ratios; achieving full hardware and software protection and reach efficiencies higher than 95; % and managing the voltage control of DC modules. Installation can be challenging, as can: unwanted magnetic coupling of the stator coils due to modularisation; the need to explore new stator designs to achieve proper electric field control and avoid induced capacitive currents and; thermal cooling. The mechanical robustness of the stator may be compromised when it is divided into modules due to the sub-harmonic fields in the machine.

Due to the low power output of existing prototypes and their limitations, the present TRL of this technology is 3 and it is difficult to assess TRL trend and scaling potential at this stage of development.

The limited work in this area thus far suggests that public sector research will be initially required to drive the development of this technology.

### 3.4. Innovative blade manufacturing techniques and materials

Blade manufacturing techniques may be relevant to the future performance of wind turbines and in terms of improving component lifetime. New solutions such as *automated manufacturing*, either involving *fibre composite laminate laying* [135] or *additive 3D printing processes for both moulds and blades* [136] would allow technology-driven cost reduction in blade manufacturing, while reducing the uncertainty, i.e. manufacturing tolerance, in the process. Further and quicker adaptation to specific customer needs under the so-called 'Industry 4.0' paradigm would also become possible, as well as fast testing of new aerodynamic shapes. Sensors and actuators are expected to play a major role in future wind turbine blade manufacturing for enhanced monitoring and smart rotor designs, e.g. BTC.

An alternative material to fibre-glass wind turbine blades is *fabric-based materials*. They could significantly reduce production costs and weight of the blades. This technology uses tensioned fabric wrapped around a spaceframe blade structure, that is, a truss-like, lightweight rigid structure, replacing the current clam shell wind turbine blade design [137]. The blade structure would be completely modified, allowing for easy access and repair to the fabric to maintain standard wind turbine performance (see Fig. 16).

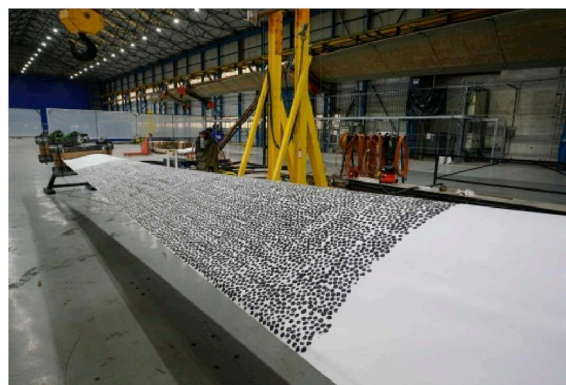

Fig. 16. Illustration of a fabric blade prototype tested in the Offshore Renewable Energy Catapult laboratories. Courtesy of ACT Blade Ltd.

New polyurethane based materials such polyurethane prepreg sheets and fibreglass/polyurethane foam preforms [138] can be used to produce lighter, stronger and longer blades, compared to the current commercial epoxy-based versions. A key property of wind turbine blades is the inter-laminar fracture toughness. The incorporation of multi-walled carbon nanotubes into polyurethane composites can double the fracture toughness of epoxy blades [139].

The production of wind turbine blades is still quite a manual and involved process [140]. Automation has the potential to simplify production and cut costs. Producing blades with 3D printing processes could be highly beneficial in this regard. Since these alternative manufacturing techniques are applications of existing technologies this should not be considered a radically new technology. This would also lead to incremental cost reduction. However, it can be observed that these manufacturing techniques are used for small scale structures while application in the wind power sector would normally require much larger scales so at present TRL is still around 1–3 with an average evolution.

New materials for blades have a lot of potential, particularly at larger scale. Appropriately designed new materials could contribute to weight reduction and increased stiffness for a typical 70 m blade. A wider spectrum of materials is needed. A new fibre which could be better adapted to wind turbine blades than existing carbon fibres would be extremely valuable for the wind power sector.

The US ARPA-E program funded a project on fabric-based blade material and the challenges of this technology were subsequently reported [137]. There are still several challenges to be addressed with regard to suitable new textiles, such as how the material behaves, particularly its fatigue properties and performance and thus the TRL of this technology is 2–3 with a slow TRL evolution. The most advanced ongoing project in Europe is the textile-based ACT Blade tested in the Offshore Renewable Energy Catapult laboratories [141].

Significant basic research will be required in order to accelerate developments in this area, though with blades a relatively high cost item and future challenges in scaling, this should be seen as a priority area.

## 4. Future knowledge requirements

### 4.1. High-fidelity multi-scale integrated models for complex wind inflow

Within the wind power sector, there is still the need for accurate and appropriate models for better understanding of wind inflow fundamental physics. Wind energy systems operate in highly unpredictable turbulent conditions. This can lead to unsuitable adaptations of wind power plants, turbine design and operation related to wind resource variability. Accurate turbine and layout design as well as turbine control strategies require high-fidelity models of scales varying from ~1 mm to > 1000 km. To provide confidence in model accuracy, validation against observations will be important through benchmarking



studies and the use of remote sensing data, e.g. Refs. [142,143].

High-fidelity models should be improved for a number of reasons, e.g. they should be capable of providing better estimates of the wind energy potential of large wind farms than at present; they should be able to better predict the forces experienced by turbines in operation to ensure that future larger machines are properly designed; they should be able to better forecast the wind on multiple timescales to allow smart control of wind farms to manage output and loads and to facilitate the integration of wind energy into networks.

High-fidelity multi-scale integrated models for complex wind inflow should be able to accurately predict the behaviour of a wind energy system and estimate its lifetime. They should be suitable to optimise design and management of wind power plants by fully capturing the interaction with and between turbines through their wakes in areas of varying terrain complexity. Ultimately, this would help to significantly reduce the cost of energy [144,145] and would require application of supercomputing capacities, as well as extensive verification and validation through high-resolution measurement campaigns.

Simple computational models are commonly used for representing different temporal and spatial scales, ranging from kilometres for weather phenomena to millimetres for the boundary layer of the blades [147], as depicted in Fig. 17. High-fidelity multi-scale integrated models present several challenges related to the high complexity of the interactions. There is still a significant lack of knowledge, so research is needed on models coupling the different scales [148]. There is work in this area, e.g. the U.S. Department of Energy is developing a multi-year research initiative, Atmosphere to Electrons [149], which targets a better understanding of the complex physics governing electricity generation by wind plants.

An integrated multi-scale interdisciplinary approach is new but important if we are truly to understand the interaction of wind generation technology with the environment and advance its design accordingly. Modelling efforts at different scales for wind inflow have been performed but only in separate specialised research communities and thus the level of development of truly integrated multi-scale models is still at a TRL of 3 and the TRL development trend is still slow.

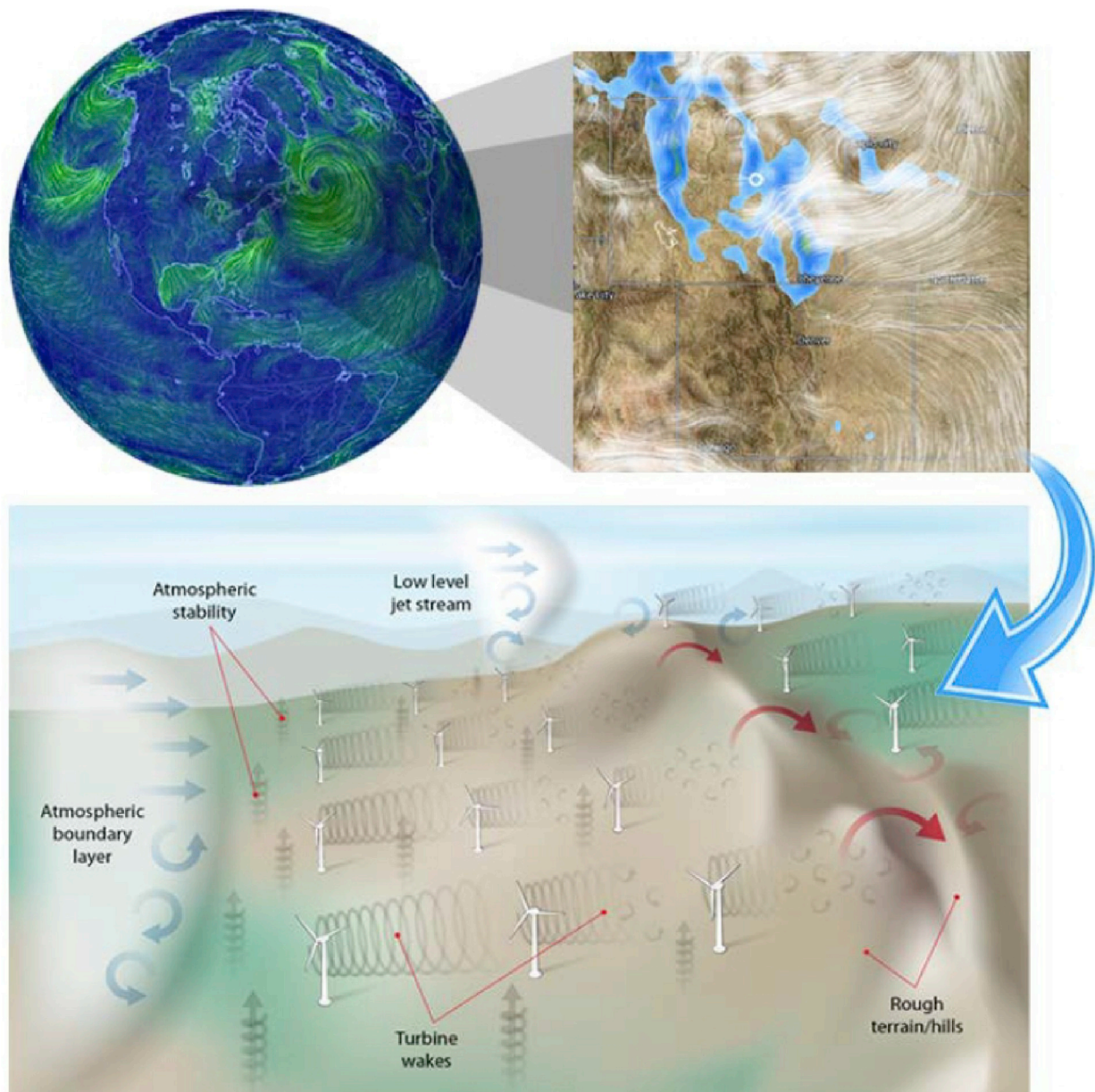

Fig. 17. The complexity of the wind flow from large regional scales to small scales. With permission of the National Renewable Energy Laboratory [146].

#### 4.2. Wind energy databases and big data analysis

A large quantity of wind energy data has been generated in recent years, with a wide variety of variables routinely collected from hundreds of sensors on experimental and turbine installed devices. Long term wind simulations made with numerical weather prediction models, computational fluid dynamics model simulations and measurement campaigns are further sources.

Data-sharing from renewable energy industry sectors, e.g. turbine manufacturers, operators and utility companies, data merging and data mining need to improve for both wind farm operational efficiency and assessment methodologies [150]. However, typically there is a gap in the information flow between the wind resource assessment community and operational producers and operators or utility companies.

Factors, such as real wake effects, anomalous component behaviour and misalignment could be identified, checked and corrected if the vast resources of data were suitably exploited [151]. In addition, under/over estimation of energy yield during wind farm design project prospecting and during design phase could be quantified.

Through the gathering of data, it could be possible to bring down turbine operation and maintenance costs and at the same time prevent knowledge loss, i.e. empirical knowledge of operators is lost when they retire. Tools to achieve this may be available but they are not optimised to solve such problems. Wind energy data analysis requires wind resource assessment experts, wind farm operation experts, mathematicians, statisticians, physicists, engineers, meteorologists, IT specialists, etc., to work together.

Distilling the complex data stream into real knowledge poses technological and scientific challenges. Not only data are needed but also appreciation of the kind of data required, how to analyse them and an understanding of the right questions to ask.

**Table 1**

Technology readiness level and power scale assessments for the different FETs identified.

Technology	TRL (2017) and TRL trend	Power (2017)	Scaling up target
Airborne wind energy	TRL = 3-5 Trend: Slow	100 kW nominal power	~ MW
Multiple drone systems (MD AWES)	TRL = 2-3 Trend: Slow	N. a.	Up to ~10 MW
Autonomous take-off and landing systems	TRL = 2-3 Trend: Slow	N. a.	N. a.
Offshore Floating wind concepts	TRL = 4-9 Trend: Slow	6 MW	10 MW
Floating hybrid energy platforms: a) wind-wave and b) wind-wind systems	TRL = 1-5 a); 1-5; b); 3-4 Trend: Slow	100 kW	10 MW
Smart rotors: a) Bend Twist Coupling; b) Segmented Ultra Morphing Rotor; c) Vortex generator; d) Blades with movable parts; e) Circulation control systems; f) Active control systems	TRL = 2-7 a); 5-7; b); 4; c); 5-6; d); 2-4; e); 2-4; f); 2-3 Trend: Average/Fast	100 kW + 12 MW	~10-50 MW
Wind induced energy harvesting from aeroelastic phenomena: a) flutter and galloping-based devices; b) vortex induced vibrations-based devices	TRL = 2-4 a); 2-3; b); 3-4 Trend: Slow	~ W (2W/m)	~ kW
Wind turbine with tip-rotors	TRL = 1-2 Trend: Slow	N.a.	N.a.
Unconventional power transmission for wind turbine rotors	TRL = 1-7 Trend: Slow	7 MW	~100 MW
Multi-rotor system (MRS) wind turbines	TRL = 2-6 Trend: Fast	900 kW	≥20 MW
Diffuser augmented wind turbine	TRL = 5-6 Trend: Fast	10-100 kW	≤1 MW
Future supporting technologies: a) Alternative fixed bottom support structures; b) Self-rising towers; c) New materials for towers and support structures	TRL = 2-8 a) 2-8 b) 2-5 c) 2-8 Trend: Average	N.a.	a) 30 MW b) 30 MW c) N.a.
Modular HVDC generator	TRL = 3 Trend: N.a.	45 kW	N.a.
High-fidelity multi-scale integrated models for complex wind flow	TRL = 3 Trend: Slow	N.a.	N.a.
Knowledge from wind energy databases	TRL = 3 Trend: Average	N.a.	N.a.
Innovative blade manufacturing techniques and materials	TRL ≤3 Trend: Slow/Average	N.a.	N.a.

Note: N.a.: Not applicable or Not available.

Although, 'big data analytics' has been driven heavily by industry who are starting to make available commercial offerings in this sector, the TRL of big data analytics still has a wide range from 3 upwards. The lower end of the TRL range in this case is not associated with technical challenges but with policies towards data sharing and mining. In order to push big data analytics to full maturity, the industry has to unlock and allow disclosure of their data. What we have seen so far, is still a level of industrial development which is in its infancy. The potential for the application of big data analytics in areas such as resource, turbine design, operations and maintenance and forecasting could be so much greater than at present particularly if attitudes to open data access can change. The pace of TRL development of this area could be considered to be average, but it will become important in the coming years. The technology to process data already exists and it is an integration of developed technologies that is required. However, the wind power industry is not yet mature enough to properly proceed with the development of this area, since commercial competition discourages data sharing. There are at least two EU projects related to data sharing, namely: the New European Wind Atlas project that is being developed [145], and the MARINET network aimed at accelerating the development of marine renewable energy [152]. These are just examples of publicly-funded initiatives where data sharing could be beneficial to the development of big data analytics.

#### 5. Conclusions

In this paper, future emerging technologies in wind energy have been identified by a number of European experts. The range of technologies identified come primarily from academic research, with many concepts being the subject of early stage development by university spin-out and start-up companies. A few technologies have been actively

investigated by larger industrial organisations. New generation concepts have been reviewed, the challenges assessed and their future potential highlighted. Both large-scale and small-scale generation technology have been considered. A number of underpinning technologies has been assessed such as the support structures and new ways to manufacture blades to enable future cost-effective scaling up of wind turbines. The role and current status of knowledge enhancement has also been highlighted, in particular, the requirement for integrated multi-scale models which are able to capture the full range of interactions between the environment and the turbine as well as the need to find ways to process, understand and extract useful knowledge from the very large volumes of data produced by the current and future wind energy industry.

From this review it is clear that there are a number of cross-cutting challenges that can be identified. In some cases, there is the need to develop materials which are cheap to manufacture, durable and lightweight. This is a particular challenge for the soft-wing airborne wind energy devices, fabric blades and small-scale energy harvesting devices. The development of advanced control strategies is a significant challenge in several cases including the floating devices, airborne wind energy generators, multi-rotor devices and smart rotors. Advanced control is likely to be a key enabler to scaling of the size of several of the devices reviewed. This needs to be complemented by a better understanding of the unsteady aerodynamics which results from the complex interaction between the turbulent inflow and the wind power generator. An improved understanding of the aeroelastic and fluid-structure interaction behaviour will be needed to realise the development of the floating and alternative support structures. Some of the technologies will need more fundamental proof of concept studies and scale model experiments before development can proceed, e.g. tip-rotor devices.

A comprehensive assessment of the technology readiness level of these technologies and their development trend has been performed, together with their typical power and scaling up potential. These quantitative assessments are summarised in Table 1.

It should be noted that this review reflects the state of knowledge at the present time, based largely on a set of more relevant technologies some of which have undergone testing and some of which are still very much at the concept stage. There may be other as yet unknown or undeveloped concepts which could radically change the economics of wind energy.

The authors of this review highlighted that emerging wind power technologies need more fundamental research to overcome still limited knowledge in several research areas such as airborne wind energy, offshore floating wind, multi-rotor systems, new support structures and high-fidelity modelling of complex wind inflows.

The wind energy industry has faced the challenge of how to scale up generation technology in order to reduce costs. It is foreseen that scaling up will continue to be a challenge but that there are a number of innovative technologies which could make this possible. However, there must be a combined push using both public and private funding to make this happen. In order to do so, fundamental research (funded mainly with public contribution) on emerging technologies needs to be correctly targeted and should not overlap with areas of interest of advanced industrial research, as industrial development may outpace fundamental research faster than anticipated.

## Appendix A. Technology Readiness Levels (TRLs)

- TRL #1: Basic principles observed.
- TRL #2: Technology concept formulated.
- TRL #3: Experimental proof of concept.
- TRL #4: Technology validated in lab.
- TRL #5: Technology validated in relevant environment.
- TRL #6: Technology demonstrated in relevant environment.
- TRL #7: System prototype demonstration in operational

environment.

TRL #8: System complete and qualified.

TRL #9: Actual system proven in operational environment.

More detailed guidance on how the TRL scale could be applied in the wind power sector can be found at: <https://publications.europa.eu/en/publication-detail/-/publication/1da3324e-e6d0-11e7-9749-01aa75ed71a1/language-en/format-PDF/source-61073523>.

## References

- [1] Moro A, Aycart J, Bardizza G, Bielewsky M, Lopez-Garcia J, Taylor N, et al. First workshop on identification of future emerging technologies for low carbon energy supply. 2017. <https://doi.org/10.2760/849373>.
- [2] De Rose A, Buna M, Strazza C, Olivieri N, Stevens T, Leen P, et al. Technology readiness Level : guidance principles for renewable energy technologies. Annexes. Luxembourg; 2017. <https://doi.org/10.2777/863818>.
- [3] Ahrens U, Diehl M, Schmehl R, editors. Airborne wind energy Berlin, Heidelberg: Springer Berlin Heidelberg; 2013. <https://doi.org/10.1007/978-3-642-39965-7>.
- [4] Schmehl R, editor. Airborne wind energy - advances in technology development and research Singapore: Springer; 2018. <https://doi.org/10.1007/978-981-10-1947-0>.
- [5] Diehl M, Leuthold R, Schmehl R, editors. The international airborne wind energy conference 2017: book of abstracts Freiburg: University of Freiburg and Delft University of Technology; 2017. <https://doi.org/10.6094/UNIFR/12994>.
- [6] Hussen K van, Dietrich E, Smeltink J, Berentsen K, Sleen M van der, Haffner R, et al. Study on Challenges in the commercialisation of airborne wind energy systems Draft Final Report. Brussels: European Commission; 2018. <https://doi.org/10.2777/87591>.
- [7] Cherubini A, Papini A, Vertechy R, Fontana M. Airborne wind energy systems: a review of the technologies. *Renew Sustain Energy Rev* 2015;51:1461–76. <https://doi.org/10.1016/j.rser.2015.07.053>.
- [8] Zillmann U, Bechtle P. Emergence and economic dimension of airborne wind energy. In: Schmehl R, editor. Airborne wind energy - adv. Technol. Dev. Res. Springer Nature Singapore; 2018. p. 1–25. [https://doi.org/10.1007/978-981-10-1947-0\\_1](https://doi.org/10.1007/978-981-10-1947-0_1).
- [9] Bechtle P, Schelbergen M, Schmehl R, Zillmann U, Watson S. Airborne wind energy resource analysis. *Renew Energy* 2019. <https://doi.org/10.1016/j.renene.2019.03.118>.
- [10] Sommerfeld M, Crawford C, Steinfeld G, Dörenkämper M. Improving mid-altitude mesoscale wind speed forecasts using LiDAR-based observation nudging for Airborne Wind Energy Systems. *Wind Energy Sci Discuss* 2019;1–30. <https://doi.org/10.5194/wes-2019-7>.
- [11] Cherubini A, Moretti G, Fontana M. Dynamic modeling of floating offshore airborne wind energy converters. In: Schmehl R, editor. Airborne wind energy - adv. Technol. Dev. Res. Springer Nature Singapore; 2018. p. 137–63. [https://doi.org/10.1007/978-981-10-1947-0\\_7](https://doi.org/10.1007/978-981-10-1947-0_7).
- [12] Salma V, Ruiterkamp R, Kruijff M, van Paassen MMR, Schmehl R. Current and expected airspace regulations for airborne wind energy systems. In: Schmehl R, editor. Airborne wind energy - adv. Technol. Dev. Res. Springer Nature Singapore; 2018. p. 703–25. [https://doi.org/10.1007/978-981-10-1947-0\\_29](https://doi.org/10.1007/978-981-10-1947-0_29).
- [13] Bruinzeel L, Klop E, Brenninkmeijer A, Bosch J. Ecological impacts of PowerPlane technology: current state of knowledge and future research agenda. In: Schmehl R, editor. Airborne wind energy - adv. Technol. Dev. Res. Springer Nature Singapore; 2018. p. 679–701. [https://doi.org/10.1007/978-981-10-1947-0\\_28](https://doi.org/10.1007/978-981-10-1947-0_28).
- [14] Kamp LM, Ortt JR, Doe MFA. Niche strategies to introduce kite-based airborne wind energy. In: Schmehl R, editor. Airborne wind energy - adv. Technol. Dev. Res. Springer Nature Singapore; 2018. p. 665–78. [https://doi.org/10.1007/978-981-10-1947-0\\_27](https://doi.org/10.1007/978-981-10-1947-0_27).
- [15] Kruijff M, Ruiterkamp R. A roadmap towards airborne wind energy in the utility sector. Schmehl R, editor. Airborne wind energy - adv. Technol. Dev. Res. vol. 1. Singapore: Springer; 2018. p. 643–62. [https://doi.org/10.1007/978-981-10-1947-0\\_26](https://doi.org/10.1007/978-981-10-1947-0_26).
- [16] Vander Lind D, Ahrens U, Diehl M, Schmehl R, editors. Analysis and flight test validation of high performance airborne wind turbines Airborne Wind Energy; 2013. p. 473–90. [https://doi.org/10.1007/978-3-642-39965-7\\_28](https://doi.org/10.1007/978-3-642-39965-7_28).
- [17] Wijnja J, Schmehl R, De Breuker R, Jensen K, Vander Lind D. Aeroelastic analysis of a large airborne wind turbine. *J Guid Control Dyn* 2018;41. <https://doi.org/10.2514/1.G001663>.
- [18] Gallucci M. Alphabet's wind energy kites to fly offshore. *IEEE Spectr* 2019 (accessed March 2, 2019). <https://spectrum.ieee.org/energywise/energy/renewables/alphabets-moonshot-wind-kites-to-fly-offshore>.
- [19] Lankhorst S. Ampyx Power – harvesting untapped winds at high altitudes. *Wind Energy Mag* 2018 No. 4, accessed <https://www.windenergie-magazine.nl/ampyx-power-harvesting-untapped-winds-at-high-altitudes/>, Accessed date: 11 April 2019.
- [20] Zanon M, Gros S, Andersson J, Diehl M. Airborne wind energy based on dual airfoils. *IEEE Trans Control Syst Technol* 2013;21:1215–22. <https://doi.org/10.1109/TCST.2013.2257781>.
- [21] Leuthold R, De Schutter J, Malz EC, Licitra G, Gros S, Diehl M. Operational regions of a multi-kite AWE system. *Eur. Control conf. ECC* 2018, Limassol, Cyprus: IEEE; 2018. p. 52–7. <https://doi.org/10.23919/ECC.2018.8550199>.
- [22] Leuthold R, Gros S, Diehl M. Induction in optimal control of multiple-kite airborne wind energy systems. *IFAC-PapersOnLine* 2017;50:153–8. <https://doi.org/10.1016/j.ifacol.2017.08.031>.

- 1016/j.ifacol.2017.08.026.
- [23] Cherubini A. *Advances in airborne wind energy and wind drones*, PhD thesis. Scuola Superiore Sant' Anna 2017. Italy.
- [24] van der Vlugt R, Bley A, Noom M, Schmehl R. Quasi-steady model of a pumping kite power system. *Renew Energy* 2019;131:83–99. <https://doi.org/10.1016/j.renene.2018.07.023>.
- [25] Fritz F. Airborne wind energy. In: Ahrens U, Diehl M, Schmehl R, editors. *Appl. An autom. Kite syst. Sh. Propuls. Power gener.* Springer Berlin Heidelberg; 2013. p. 359–72. <https://doi.org/10.1007/978-3-642-39965-7>.
- [26] Rapp S, Schmehl R. Vertical takeoff and landing of flexible wing kite power systems. *J Guid Control Dyn* 2018;41:2386–400. <https://doi.org/10.2514/1.6003535>.
- [27] Fagiolo N, Nguyen-Van E, Rager F, Schnez S, Ohler C. Autonomous takeoff and flight of a tethered aircraft for airborne wind energy. *IEEE Trans Control Syst Technol* 2018. <https://doi.org/10.1109/TCST.2017.2661825>.
- [28] Nguyen Van E, Fagiolo N, Schnez S. On the autonomous take-off and landing of tethered wings for airborne wind energy. *Proc Am control conf* 2016. <https://doi.org/10.1109/ACC.2016.7525562>. 2016-July:4077–82.
- [29] Jonkman JM, Matha D. Dynamics of offshore floating wind turbines-analysis of three concepts. *Wind Energy* 2011;14:557–69. <https://doi.org/10.1002/we.442>.
- [30] Liu Y, Li S, Yi Q, Chen D. Developments in semi-submersible floating foundations supporting wind turbines: a comprehensive review. *Renew Sustain Energy Rev* 2016;60:433–49. <https://doi.org/10.1016/j.rser.2016.01.109>.
- [31] Bachynski EE, Moan T. Design considerations for tension leg platform wind turbines. *Mar Struct* 2012;29:89–114. <https://doi.org/10.1016/j.marstruc.2012.09.001>.
- [32] Cheng Z, Wang K, Gao Z, Moan T, Cheng CZ. A comparative study on dynamic responses of spar-type floating horizontal and vertical axis wind turbines 2017;20:305–23. <https://doi.org/10.1002/we.2007>.
- [33] Azcona J, Palacio D, Munduate X, González L, Nygaard TA. Impact of mooring lines dynamics on the fatigue and ultimate loads of three offshore floating wind turbines computed with IEC 61400-3 guideline. *Wind Energy* 2017;20:797–813. <https://doi.org/10.1002/we.2064>.
- [34] Myhr A, Bjerkeseter C, Ågotnes A, Nygaard TA. Levelised cost of energy for offshore floating wind turbines in a life cycle perspective. *Renew Energy* 2014;66:714–28. <https://doi.org/10.1016/J.RENENE.2014.01.017>.
- [35] Dvorak MJ, Archer CL, Jacobson MZ. California offshore wind energy potential. *Renew Energy* 2010;35:1244–54. <https://doi.org/10.1016/j.renene.2009.11.022>.
- [36] Patel S. Japan prepares to float offshore wind industry. *Power* 2013;157: 10–10.
- [37] Gonzalez-Rodriguez AG. Review of offshore wind farm cost components. *Energy Sustain Dev* 2017;37:10–9. <https://doi.org/10.1016/j.esd.2016.12.001>.
- [38] Henderson AR, Witcher D. Floating offshore wind energy — a review of the current status and an assessment of the prospects. *Wind Eng* 2010;34:1–16. <https://doi.org/10.1260/0309-524X.34.1.1>.
- [39] Namik H, Stol K. Individual blade pitch control of floating offshore wind turbines. *Wind Energy* 2010;13:74–85. <https://doi.org/10.1002/we.332>.
- [40] Lackner MA. Controlling platform motions and reducing blade loads for floating wind turbines. *Wind Eng* 2009;33:541–53. <https://doi.org/10.1260/0309-524X.33.6.541>.
- [41] Dähne M, Tougaard J, Carstensen J, Rose A, Nabe-Nielsen J. Bubble curtains attenuate noise from offshore wind farm construction and reduce temporary habitat loss for harbour porpoises. *Mar Ecol Prog Ser* 2017;580:221–37. <https://doi.org/10.3354/meps12257>.
- [42] Topham E, McMillan D. Sustainable decommissioning of an offshore wind farm. *Renew Energy* 2017;102:470–80. <https://doi.org/10.1016/J.RENENE.2016.10.066>.
- [43] Borg M, Shires A, Collu M. Offshore floating vertical axis wind turbines, dynamics modelling state of the art. part I: Aerodynamics. *Renew Sustain Energy Rev* 2014;39:1214–25. <https://doi.org/10.1016/j.rser.2014.07.096>.
- [44] Borg M, Collu M, Kolios A. Offshore floating vertical axis wind turbines, dynamics modelling state of the art. Part II: mooring line and structural dynamics. *Renew Sustain Energy Rev* 2014;39:1226–34. <https://doi.org/10.1016/j.rser.2014.07.122>.
- [45] Borg M, Collu M. Offshore floating vertical axis wind turbines, dynamics modelling state of the art. Part III: hydrodynamics and coupled modelling approaches. *Renew Sustain Energy Rev* 2015;46:296–310. <https://doi.org/10.1016/j.rser.2014.10.100>.
- [46] Wind Europe. *Floating Offshore Wind Vision Statement* 2017;16. <https://doi.org/10.1007/978-3-319-27972-5>.
- [47] Castro-Santos L, Filgueira-Vizoso A, Carral-Couce L, Formoso JÁF. Economic feasibility of floating offshore wind farms. *Energy* 2016. <https://doi.org/10.1016/j.energy.2016.06.135>.
- [48] O'Sullivan KP. *Feasibility of combined wind-wave energy platforms* PhD thesis National University of Ireland – Cork (NUIC); 2014.
- [49] Golightly CR. *Blackbird: a hybrid CAES storage anchored mono-TLP VAWT-WEC*. Wind eur. Conf. 2017. 28-30 November, Amsterdam.
- [50] Manzanar R, Hanssen JE, Torgeir M, Ingram D. MARINA Platform project: first steps towards deep offshore wind/ocean energy conversion. Third int. Conf. Ocean energy, 6th-8th oct. 2010. Bilbao.
- [51] Gao Z, Moan T, Wan L, Michailides C. Comparative numerical and experimental study of two combined wind and wave energy concepts. *J Ocean Eng Sci* 2016;1:36–51. <https://doi.org/10.1016/J.JOES.2015.12.006>.
- [52] de Vries E. Aerodyn prepares SCDnezzy for Japan tests. *Wind Power Mon* 2018;34:32–4.
- [53] Pérez-Collazo C, Greaves D, Iglesias G. A review of combined wave and offshore wind energy. *Renew Sustain Energy Rev* 2015;42:141–53. <https://doi.org/10.1016/j.rser.2014.09.032>.
- [54] Tomey-Bozo N, Murphy J, Lewis T, Thomas G. A review and comparison of offshore floating concepts with combined wind-wave energy. *Proc 11th Eur Wave Tidal Energy Conf* 2015;1–8.
- [55] MARINET FP7. *MARINET - marine renewables infrastructure network for emerging energy technologies*. <http://www.fp7-marinet.eu/>; 2018, Accessed date: 23 March 2018.
- [56] Barlas TK, van Kuik GAM. Review of state of the art in smart rotor control research for wind turbines. *Prog Aerosp Sci* 2010;46:1–27. <https://doi.org/10.1016/j.paerosci.2009.08.002>.
- [57] Bottasso CL, Campagnolo F, Croce A, Tibaldi C. Optimization-based study of bend-twist coupled rotor blades for passive and integrated passive/active load alleviation. *Wind Energy* 2012;16:149–1166. <https://doi.org/10.1002/we.1543>.
- [58] Lachenal X, Daynes S, Weaver PM. Review of morphing concepts and materials for wind turbine blade applications. *Wind Energy* 2013;16:283–307. <https://doi.org/10.1002/we.531>.
- [59] Hayat K, de Lecea AGM, Moriones CD, Ha SK. Flutter performance of bend-twist coupled large-scale wind turbine blades. *J Sound Vib* 2016;370:149–62. <https://doi.org/10.1016/J.JSV.2016.01.032>.
- [60] Ichter B, Steele A, Loth E, Moriarty P, Selig M. A morphing downwind-aligned rotor concept based on a 13-MW wind turbine. *Wind Energy* 2016;19:625–37. <https://doi.org/10.1002/we.1855>.
- [61] Troldborg N, Zahle F, Sørensen NN. Simulations of wind turbine rotor with vortex generators. *J Phys Conf Ser* 2016;753:022057. <https://doi.org/10.1088/1742-6596/753/2/022057>.
- [62] ODB-project – the offshore demonstration blade project n.d. [http://odb-project.com/\(accessed July 19, 2018\)](http://odb-project.com/(accessed July 19, 2018)).
- [63] Bottasso CL, Croce A, Gualdoni F, Montinari P. Load mitigation for wind turbines by a passive aeroelastic device. *J Wind Eng Ind Aerodyn* 2016;148:57–69. <https://doi.org/10.1016/J.JWEIA.2015.11.001>.
- [64] Bottasso CL, Croce A, Gualdoni F, Montinari P, Riboldi CED. Articulated blade tip devices for load alleviation on wind turbines. *Wind Energy Sci* 2016;1:297–310. <https://doi.org/10.5194/wes-1-297-2016>.
- [65] Wetzel DA, Griffin J, Cattafesta LN. Experiments on an elliptic circulation control aerofoil. *J Fluid Mech* 2013;730:99–144. <https://doi.org/10.1017/jfm.2013.293>.
- [66] Jamieson P. *Circulation control for the rotors of large horizontal Axis wind turbines*. Proc. Gd. Renew. Energy conf. 2018. Yokohama.
- [67] Lackner MA, Van Kuik G. A comparison of smart rotor control approaches using trailing edge flaps and individual pitch control. *Wind Energy* 2010;13:117–34. <https://doi.org/10.1002/we.353>.
- [68] Zhang S, Franek O, Eggers PCF, Byskov C, Pedersen GF. Multipath suppression with an absorber for UWB wind turbine blade deflection sensing systems. *IEEE Trans Microw Theory Tech* 2017;65:2583–95. <https://doi.org/10.1109/TMTT.2017.2649499>.
- [69] Bertelè M, Bottasso CL, Cacciola S. Automatic detection and correction of pitch misalignment in wind turbine rotors. *Wind Energy Sci* 2018;3:791–803. <https://doi.org/10.5194/wes-3-791-2018>.
- [70] Griffin DA. *Investigation of vortex generators for augmentation of wind turbine power performance* NREL Technical Report: NREL/SR-440-21399 1996
- [71] Gao L, Zhang H, Liu Y, Han S. Effects of vortex generators on a blunt trailing-edge airfoil for wind turbines. *Renew Energy* 2015;76:303–11. <https://doi.org/10.1016/j.renene.2014.11.043>.
- [72] Shires A, Kourkoulis V. Application of circulation controlled blades for vertical axis wind turbines. *Energies* 2013;6:3744–63. <https://doi.org/10.3390/en6083744>.
- [73] Barlas TK, van der Veen GJ, van Kuik GAM. Model predictive control for wind turbines with distributed active flaps: incorporating inflow signals and actuator constraints. *Wind Energy* 2012;15:757–71. <https://doi.org/10.1002/we.503>.
- [74] Cooperman A, Martinez M. Load monitoring for active control of wind turbines. *Renew Sustain Energy Rev* 2015;41:189–201. <https://doi.org/10.1016/j.rser.2014.08.029>.
- [75] Zhang M, Tan B, Xu J. Smart fatigue load control on the large-scale wind turbine blades using different sensing signals. *Renew Energy* 2016;87:111–9. <https://doi.org/10.1016/J.RENENE.2015.10.011>.
- [76] de Vries O. *Fluid dynamic aspects of wind energy conversion*. Natl aerosp lab rep AGARD-AG-243, publ by NATO. 1979. p. 156.
- [77] Jamieson P. *Innovation in wind turbine design*. second ed. Wiley; 2018. <https://doi.org/10.1002/9781119975441>.
- [78] Siemens AG. Press Release: Siemens develops world-record electric motor for aircraft 2015:3 accessed <https://www.siemens.com/press/en/pressrelease/?press=/en/pressrelease/2015/corporate/pr2015030156coen.htm>, Accessed date: 14 November 2018.
- [79] Jamieson P, Branney M, Chaviaropoulos P, Sieros G, Voutsinas S, Chasapogiannis P. The structural design and preliminary aerodynamic evaluation of a multi-rotor system as a solution for offshore systems of 20 MW or more unit capacity. *J Phys Conf Ser* 2014;5241:012084.
- [80] Jamieson P, Branney M, Hart K, Chaviaropoulos PK, Sieros G, Voutsinas S, et al. Innovative turbine concepts - deliverable 1.33 of the EU INNWIND project. 2015.
- [81] Tavner PJ, Xiang J, Spinato F. Reliability analysis for wind turbines. *Wind Energy* 2007;10:1–18. <https://doi.org/10.1002/we.204> ER.
- [82] Tavner PJ, Spinato F, van Bussel G, Koutoulakos E. The reliability of different wind turbine concepts, with relevance to offshore applications. *Proc eur wind energy conf brussels, 31st march - 3rd april 2008*. 2008.
- [83] Chasapogiannis P, Prospathopoulos JM, Voutsinas SG, Chaviaropoulos TK. Analysis of the aerodynamic performance of the multi-rotor concept. *J Phys Conf Ser* 2014;524:012084. <https://doi.org/10.1088/1742-6596/524/1/012084>.
- [84] Jamieson P, Branney M. Multi-rotors; a solution to 20 MW and beyond? *Energy*

- Procedia 2012;24:52–9. <https://doi.org/10.1016/J.EGYPRO.2012.06.086>.
- [85] Göltenbott U. Aerodynamics of multi-rotor wind turbine systems using diffuser-augmentation PhD Thesis Kyushu University; 2017. <https://doi.org/10.15017/1807035>.
- [86] Ohya Y, Miyazaki J, Göltenbott U, Watanabe K. Power augmentation of shrouded wind turbines in a multirotor system. *J Energy Resour Technol* 2017;139:051202. <https://doi.org/10.1115/1.4035754>.
- [87] Göltenbott U, Ohya Y, Yoshida S, Jamieson P. Aerodynamic interaction of diffuser augmented wind turbines in multi-rotor systems. *Renew Energy* 2017;112:25–34. <https://doi.org/10.1016/j.renene.2017.05.014>.
- [88] Kozlov SV, Sirotkin EA, Solomin BV. Wind turbine rotor magnetic levitation. 2016 2nd Int Conf Ind Eng Appl Manuf ICIEAM 2016 - Proc 2016:5–8. <https://doi.org/10.1109/ICIEAM.2016.7911477>.
- [89] Paulsen US. Deliverable D5.1 - sizing of a Spar-type floating support structure. 2013.
- [90] Chong WT, Muzammil WK, Wong KH, Wang CT, Gwani M, Chu YJ, et al. Cross axis wind turbine: pushing the limit of wind turbine technology with complementary design. *Appl Energy* 2017;207:78–95. <https://doi.org/10.1016/j.apenergy.2017.06.099>.
- [91] Chong WT, Muzammil WK, Wong KH, Wang CT, Gwani M, Chu YJ, et al. Cross axis wind turbine: pushing the limit of wind turbine technology with complementary design. *Appl Energy* 2017;207:78–95. <https://doi.org/10.1016/j.apenergy.2017.06.099>.
- [92] Efstathiades CO. Trends and challenges for wind energy harvesting: SMART cities - the role OF local authorities IN the engagement OF small wind turbines IN urban areas. Winer work 'trends challenges wind energy harvest march 30-31, 2015. 2015. p. 227–37. Coimbra, Port.
- [93] Hamza N. Trends and challenges for wind energy harvesting: urban wind energy: exposing sustainability symbolism or a hidden existence. Winer work 'trends challenges wind energy harvest march 30-31, 2015. 2015. p. 239–48. Coimbra, Port.
- [94] Elahi H, Eugeni M, Gaudenzi P, Elahi H, Eugeni M, Gaudenzi P. A review on mechanisms for piezoelectric-based energy harvesters. *Energies* 2018;11:1850. <https://doi.org/10.3390/en11071850>.
- [95] Aquino AI, Calauti JK, Hughes BR. Evaluation of the integration of the wind-induced flutter energy harvester (WIFEH) into the built environment: experimental and numerical analysis. *Appl Energy* 2017;207:61–77. <https://doi.org/10.1016/j.apenergy.2017.06.041>.
- [96] Zhang B, Song B, Mao Z, Tian W, Li B. Numerical investigation on VIV energy harvesting of bluff bodies with different cross sections in tandem arrangement. *Energy* 2017;133:723–36. <https://doi.org/10.1016/j.energy.2017.05.051>.
- [97] Pigolotti L, Mannini C, Bartoli G. Experimental study on the flutter-induced motion of two-degree-of-freedom plates. *J Fluids Struct* 2017;75:77–98. <https://doi.org/10.1016/j.jfluidstructs.2017.07.014>.
- [98] Abdelkefi A, Hajj MR, Nayfeh AH. Piezoelectric energy harvesting from transverse galloping of bluff bodies. *Smart Mater Struct* 2013;22:015014. <https://doi.org/10.1088/0964-1726/22/1/015014>.
- [99] Ewere F, Wang G, Cain B. Experimental investigation of galloping piezoelectric energy harvesters with square bluff bodies. *Smart Mater Struct* 2014;23:104012. <https://doi.org/10.1088/0964-1726/23/10/104012>.
- [100] Zhao L, Yang Y. Analytical solutions for galloping-based piezoelectric energy harvesters with various interfacing circuits. *Smart Mater Struct* 2015;24:075023. <https://doi.org/10.1088/0964-1726/24/7/075023>.
- [101] Simiu E, Scanlan RH. *Wind effects on Structures : fundamentals and applications to design*. third ed. New York: John Wiley & Sons, Inc.; 1996.
- [102] Caracoglia L. Modeling the coupled electro-mechanical response of a torsional-flutter-based wind harvester with a focus on energy efficiency examination. *J Wind Eng Ind Aerodyn* 2018;174:437–50. <https://doi.org/10.1016/j.jweia.2017.10.017>.
- [103] Bladeless Vortex. 14 may story of a tech startup – vortex bladeless aerogenerator accessed <https://vortexbladeless.com/story-vortex-bladeless-tech-startup/>; 2018, Accessed date: 29 October 2018.
- [104] Petrini F, Gkoumas K. Piezoelectric energy harvesting from vortex shedding and galloping induced vibrations inside HVAC ducts. *Energy Build* 2018;158:371–83. <https://doi.org/10.1016/j.enbuild.2017.09.099>.
- [105] piezoTsensor 2016 accessed <http://www.piezosensor.eu/>, Accessed date: 29 October 2018.
- [106] Wang X, Zeng X, Li J, Yang X, Wang H. A review on recent advancements of substructures for offshore wind turbines. *Energy Convers Manag* 2018;158:103–19. <https://doi.org/10.1016/j.enconman.2017.12.061>.
- [107] DeVries W, van der Tempel J, Carstens H, Argyriadis K, Passon P, Camp T, et al. Assessment of bottom-mounted support structure types with conventional design stiffness and installation techniques for typical deep-water sites. 2007.
- [108] Njomo Wandji W, Natarajan A, Dimitrov N. Development and design of a semi-floater substructure for multi-megawatt wind turbines at 50+ m water depths. *Ocean Eng* 2016;125:226–37. <https://doi.org/10.1016/J.OCEANENG.2016.07.021>.
- [109] De Vries W, van der Tempel J, Carstens H, Argyriadis K, Passon P, Camp T, et al. Assessment of bottom-mounted support structure types with conventional design stiffness and installation techniques for typical deep-water sites - EU UpWind Project Research Report for Deliverable 4.2 vol. 1. 2007.
- [110] Hau E. *Wind turbines*. Berlin, Heidelberg: Springer Berlin Heidelberg; 2013. <https://doi.org/10.1007/978-3-642-27151-9>.
- [111] Zwick D, Muskulus M, Moe G. Iterative optimization approach for the design of full-height lattice towers for offshore wind turbines. *Energy Procedia* 2012;24:297–304. <https://doi.org/10.1016/J.EGYPRO.2012.06.112>.
- [112] Natarajan A, Stolpe M, Njomo Wandji W. Structural optimization based design of jacket type sub-structures for 10 MW offshore wind turbines. *Ocean Eng* 2019;172:629–40. <https://doi.org/10.1016/J.OCEANENG.2018.12.023>.
- [113] Stavridou N, Koltsakis E, Baniotopoulos C. Structural analysis and optimal design of steel lattice wind turbine towers. *Proc Inst Civ Eng - Struct Build* 2019;1–43. <https://doi.org/10.1680/jstbu.18.00074>.
- [114] Stavridou N, Koltsakis E, Baniotopoulos CC. Tubular, lattice and hybrid steel turbine towers for offshore wind energy: a numerical investigation. In: Randolph NF, Doan DH, Tang M, Bui M, Dinh VN, editors. *Proc. 1st vietnam symp. Adv. Offshore eng. 1st-3rd novemb*. Hanoi: Springer; 2019. p. 524–9. [https://doi.org/10.1007/978-981-13-2306-5\\_74](https://doi.org/10.1007/978-981-13-2306-5_74).
- [115] Stavridou N, Koltsakis E, Baniotopoulos C. Material optimisation use in steel lattice wind turbine towers. In: Papadrakakis M, Stavroulakis G, editors. *9th GRACM int. Congr. Comput. Mech. 4th-6th June*. 2018. p. 173–80. Chania.
- [116] Stavridou N, Koltsakis E, Baniotopoulos C. Structural investigation of lattice and tubular steel wind turbine towers. A comparative study. In: Baniotopoulos C, Borri C, Morino E, Blocken B, Hemida H, Veljkovic M, editors. *Winer. '18 final conf. Catanzaro: . 21st-23rd March*; 2018. p. 291–8.
- [117] Richter C, Rebelo C, Shah Mohammadi MR, Feldmann M, Pak D. SHOWTIME: steel hybrid onshore wind towers installed with minimal Effort : development of lifting process. *Int. Conf. Wind energy harvest. 20th-21st april*. 2017. Coimbra, Portugal.
- [118] Jupp S. Aluminium as a viable solution for offshore wind turbines. Deep sea offshore wind R&D semin. 20th - 21st january. 2011. Trondheim, Norway.
- [119] Richter C, Rebelo C, Shah Mohammadi MR, Feldmann M, Pak D. SHOWTIME: steel hybrid onshore wind towers installed with minimal Effort : development of lifting process. *Int. Conf. Wind energy harvest*. 2017.
- [120] Jupp S. Aluminium as a viable solution for offshore wind turbines *Climate strategy intro* 2011. p. 1–29. 2011.
- [121] Young AC, Goupee AJ, Dagher HJ, Viselli AM. Methodology for optimizing composite towers for use on floating wind turbines. *J Renew Sustain Energy* 2017;9:033305. <https://doi.org/10.1063/1.4984259>.
- [122] Long H, Moe G. Preliminary design of bottom-fixed lattice offshore wind turbine towers in the fatigue limit state by the frequency domain method. *J Offshore Mech Arct Eng* 2012;134:031902. <https://doi.org/10.1115/1.4005200>.
- [123] Sarkar A, Gudmestad OT. Study on a new method for installing a monopile and a fully integrated offshore wind turbine structure. *Mar Struct* 2013;33:160–87. <https://doi.org/10.1016/j.marstruc.2013.06.001>.
- [124] Sriharan S. Wind turbine towers: precast concrete Hexcrete may help increase renewable energy capacity with taller hub heights. *PCI J* 2015;60:33–8.
- [125] Serina MJ, Nieto J. World's first craneless bottom-fixed offshore turbine, 5 MW "ELISA" prototype. *Proc. Offshore Wind 2017. 6th-8th June, London*. 2017.
- [126] Silva P, Giuffrida A, Fergnani N, Macchi E, Cantù M, Suffredini R, et al. Performance prediction of a multi-MW wind turbine adopting an advanced hydrostatic transmission. *Energy* 2014;64:450–61. <https://doi.org/10.1016/j.energy.2013.11.034>.
- [127] Polinder H, Ferreira JA, Jensen BB, Abrahamsen AB, Atallah K, McMahon RA. Trends in wind turbine generator systems. *IEEE J Emerg Sel Top Power Electron* 2013;1:174–85. <https://doi.org/10.1109/JESTPE.2013.2280428>.
- [128] Sant T, Buhagiar D, Farrugia RN. Modelling the dynamic response and loads of floating offshore wind turbine structures with integrated compressed air energy storage. *ASME 2017 36th int conf ocean offshore arct eng 2017*. <https://doi.org/10.1115/OMAE2017-61587>. 10: Ocean:V010T09A049.
- [129] Garvey SD. Structural capacity and the 20 MW wind turbine. *Proc Inst Mech Eng Part A J Power Energy* 2010;224:1083–115. <https://doi.org/10.1243/09576509JPE973>.
- [130] Fan Y, Mu A, Ma T. Study on the application of energy storage system in offshore wind turbine with hydraulic transmission. *Energy Convers Manag* 2016;110:338–46. <https://doi.org/10.1016/J.ENCONMAN.2015.12.033>.
- [131] Ross K. Mitsubishi claims world first with hydraulic wind turbine breakthrough - power Engineering International. *Power Engineering Int* 2013 accessed <https://www.powerengineeringint.com/articles/2013/01/mitsubishi-claims-world-first-with-hydraulic-wind-turbine-break.html>, Accessed date: 12 April 2019.
- [132] Kempenaar AS, Diepeveen NFB, Jarquin Laguna A. MicroDOT: design of a 10W prototype of the Delft offshore turbine. *EWEA 2011 offshore*. 2011. 29th November - 1st December, Amsterdam.
- [133] Gjerde S, Ljøekelsøy K, Nilsen R, Undeland T. A modular series connected converter structure suitable for a high-voltage direct current transformerless offshore wind turbine. *Wind Energy* 2014;17:1855–74. <https://doi.org/10.1002/we.1670>.
- [134] Olsen PK, Gjerde S, Nilssen RM, Hoelto J, Hvidsten S. A Transformerless generator-converter concept making feasible a 100 kV light weight offshore wind turbine: Part i - the generator. *IEEE Energy Convers. Congr. Expo. ECCE 2012* 2012;247–52. <https://doi.org/10.1109/ECCE.2012.6342816>. 2012.
- [135] US Department of Energy. Fiber reinforced polymer composite manufacturing workshop: summary report 2014. DOE/EE-1041.
- [136] US Department of Energy. Transforming wind turbine blade mold manufacturing with 3D printing. 2017. DOE/GO-102016-4870.
- [137] Bullis K. GE hopes to make its cloth wind turbine idea fly. *MIT Technol Rev*; 2012 accessed <https://www.technologyreview.com/s/508301/ge-hopes-to-make-its-cloth-wind-turbine-idea-fly/>, Accessed date: 14 November 2018.
- [138] Hupka F, Schornstein M, Nefzger H. Polyurethane prepreg and composite fiber element produced therefrom. 2016. EP2986659A1.
- [139] Williamson K. Bayer develops polyurethane composite for wind turbine blades. *Renew Energy Focus* 2011. <http://www.renewableenergyfocus.com/view/22781/bayer-develops-polyurethane-composite-for-wind-turbine-blades/>.
- [140] Mishnaevsky L, Branner K, Petersen H, Beauson J, McGugan M, Sørensen B. Materials for wind turbine blades: an overview. *Materials* 2017;10:1285. <https://doi.org/10.3390/ma10101285>.

- [doi.org/10.3390/ma10111285](https://doi.org/10.3390/ma10111285).
- [141] ACT Blade. ACT blade: the next generation. 2018 n.d <http://actblade.com/>, Accessed date: 14 November 2018.
- [142] Bechmann A, Sørensen NN, Berg J, Mann J, Réthoré P-E. The bolund experiment, Part II: blind comparison of microscale flow models. *Boundary-Layer Meteorol* 2011;141:245–71. <https://doi.org/10.1007/s10546-011-9637-x>.
- [143] Vasiljević NLM, Palma JM, Angelou N, Carlos Matos J, Menke R, Lea G, et al. Perdigo 2015: methodology for atmospheric multi-Doppler lidar experiments. *Atmos Meas Tech* 2017;10:3463–83. <https://doi.org/10.5194/amt-10-3463-2017>.
- [144] Dykes K, Hand M, Stehly T, Veers P, Robinson M, Lantz E, et al. Enabling the SMART wind power plant of the future through science-based innovation. *Denver West Parkway Golden*; 2017.
- [145] Mann J, Angelou N, Arnqvist J, Callies D, Cantero E, Arroyo RC, et al. Complex terrain experiments in the new european wind Atlas. *Philos Trans R Soc A Math Phys Eng Sci* 2017;375:20160101. <https://doi.org/10.1098/rsta.2016.0101>.
- [146] Dykes K, Hand M, Stehly T, Veers P, Robinson M, Lantz E, et al. Enabling the SMART wind power plant of the future through science-based innovation *Technical Report NREL/TP-5000-68123* 2017
- [147] Sanz Rodrigo J, Churchfield M, Kosovic B. A methodology for the design and testing of atmospheric boundary layer models for wind energy applications. *Wind Energy Sci* 2017;2:35–54. <https://doi.org/10.5194/wes-2-35-2017>.
- [148] Shaw WJ, Lundquist JK, Schreck SJ. Research needs for wind resource characterization. *Bull Am Meteorol Soc* 2009;90:535–8. <https://doi.org/10.1175/2008BAMS2729.1>.
- [149] A2e - Office of Energy Efficiency & Renewable Energy. Atmosphere to Electrons - wind energy technologies office. 2018 accessed <https://www.energy.gov/eere/wind/atmosphere-electrons>, Accessed date: 22 March 2018.
- [150] Ekonomou L, Lazarou S, Chatzarakis GE, Vita V. Estimation of wind turbines optimal number and produced power in a wind farm using an artificial neural network model. *Simul Model Pract Theory* 2012;21:21–5. <https://doi.org/10.1016/j.simpat.2011.09.009>.
- [151] Al-Shammari ET, Shamshirband S, Petković D, Zalnezhad E, Yee PL, Taher RS, et al. Comparative study of clustering methods for wake effect analysis in wind farm. *Energy* 2016;95:573–9. <https://doi.org/10.1016/j.energy.2015.11.064>.
- [152] Maisondieu C, Healy M. The impact of the MARINET initiative on the development of Marine Renewable Energy. *Int J Mar Energy* 2015;12:77–86. <https://doi.org/10.1016/j.ijome.2015.06.002>.