

4

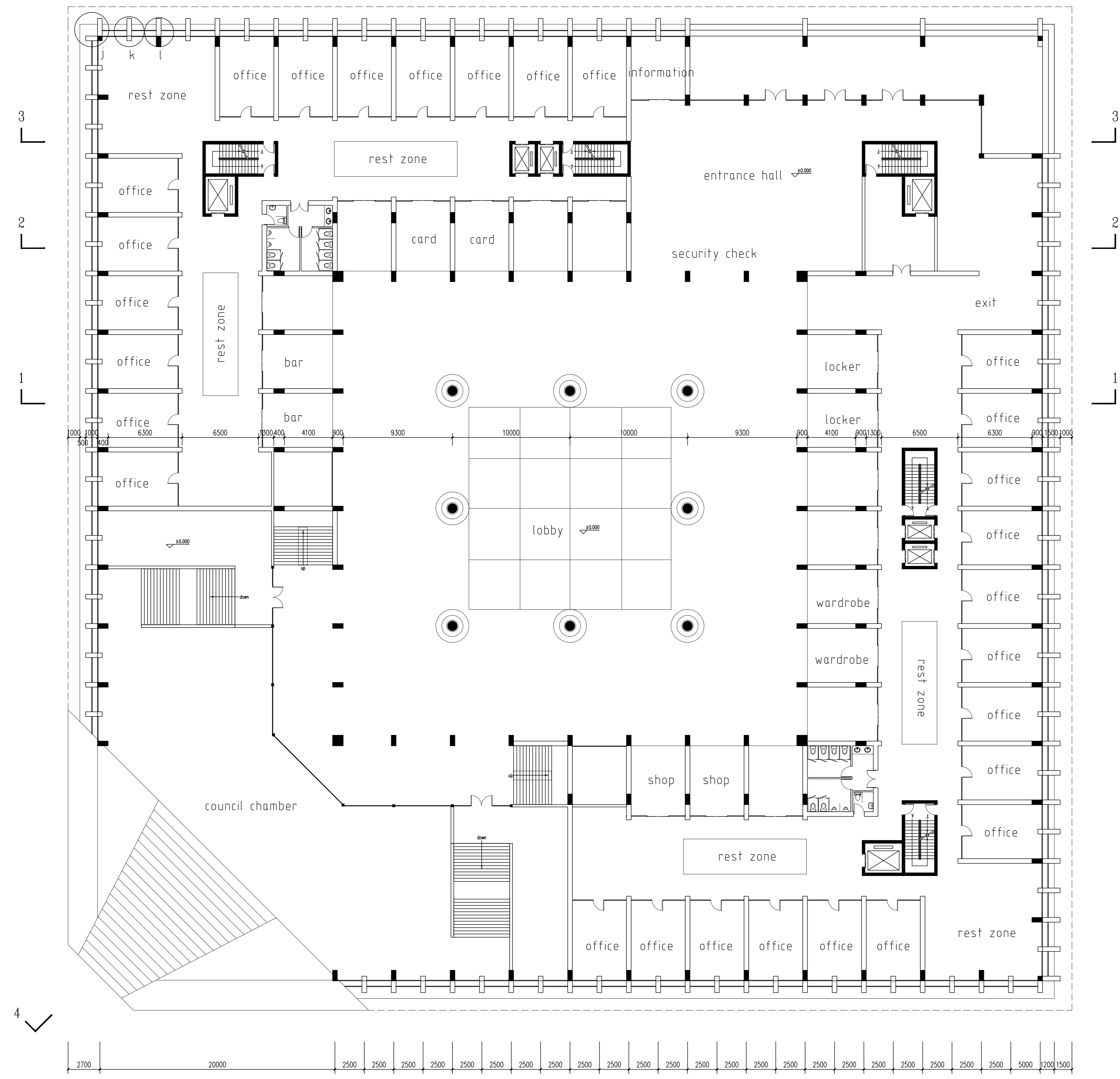

ground plan 1:200

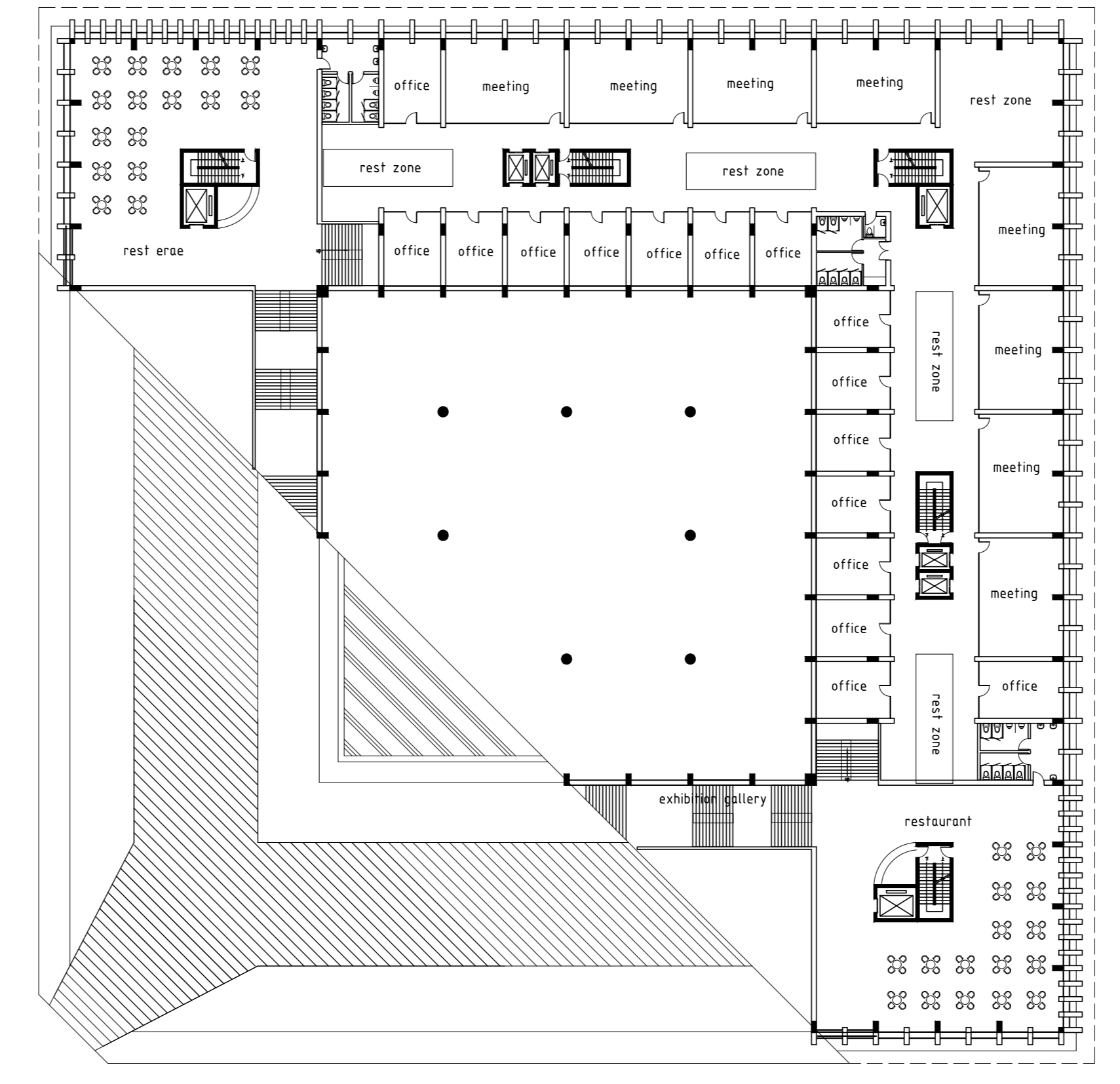

2 plan 1:200

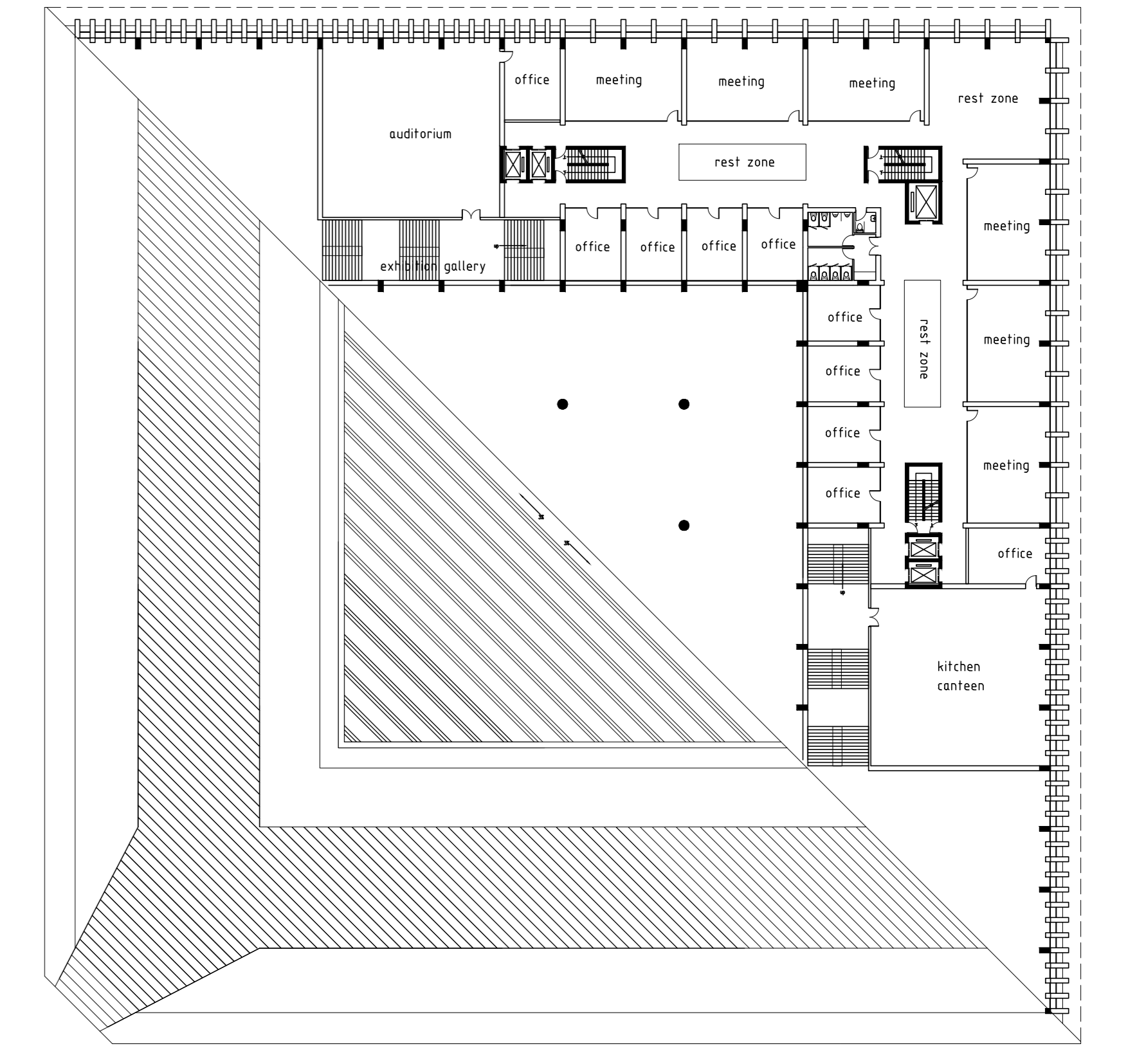

3 plan 1:200

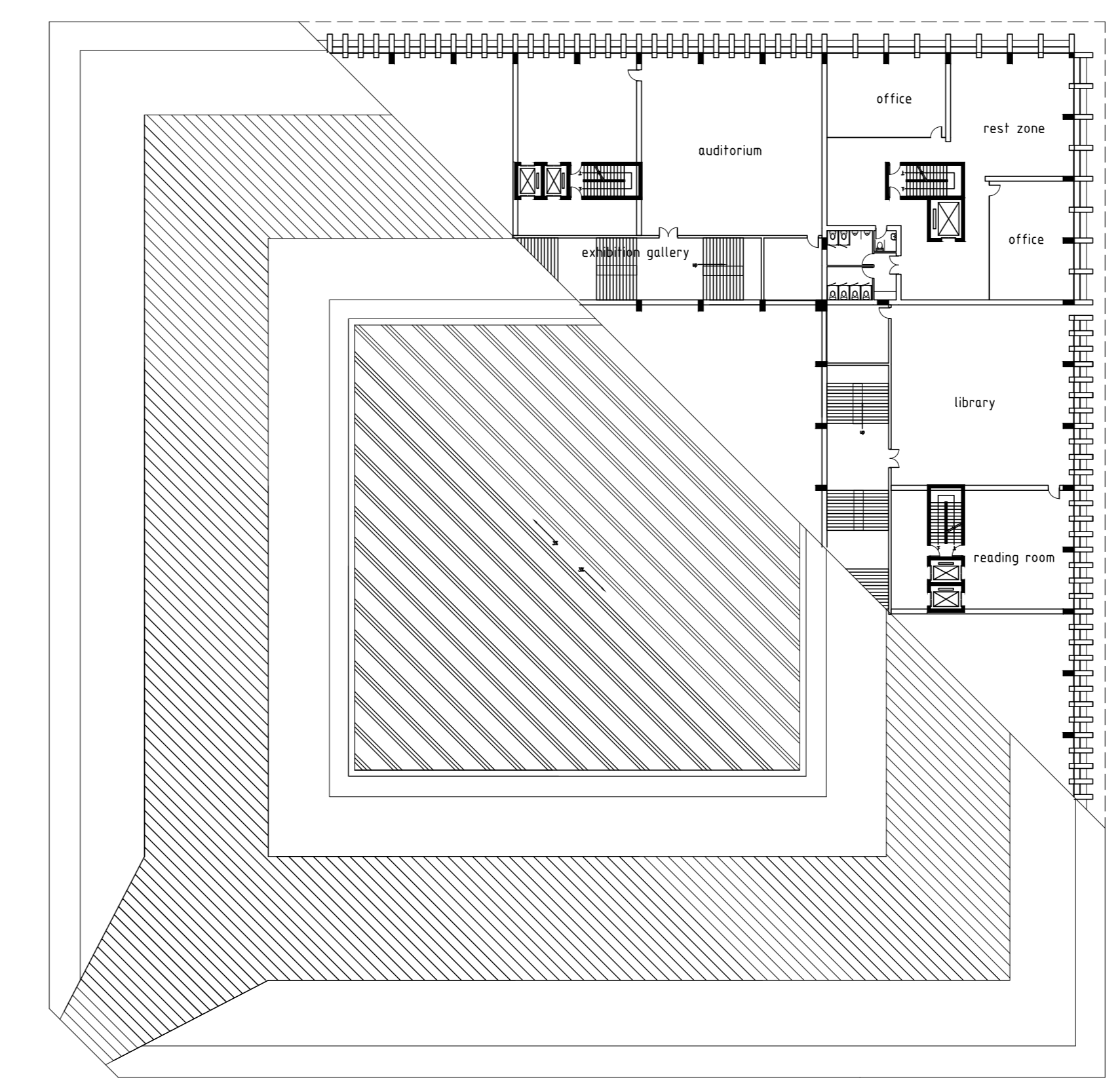

4 plan 1:200

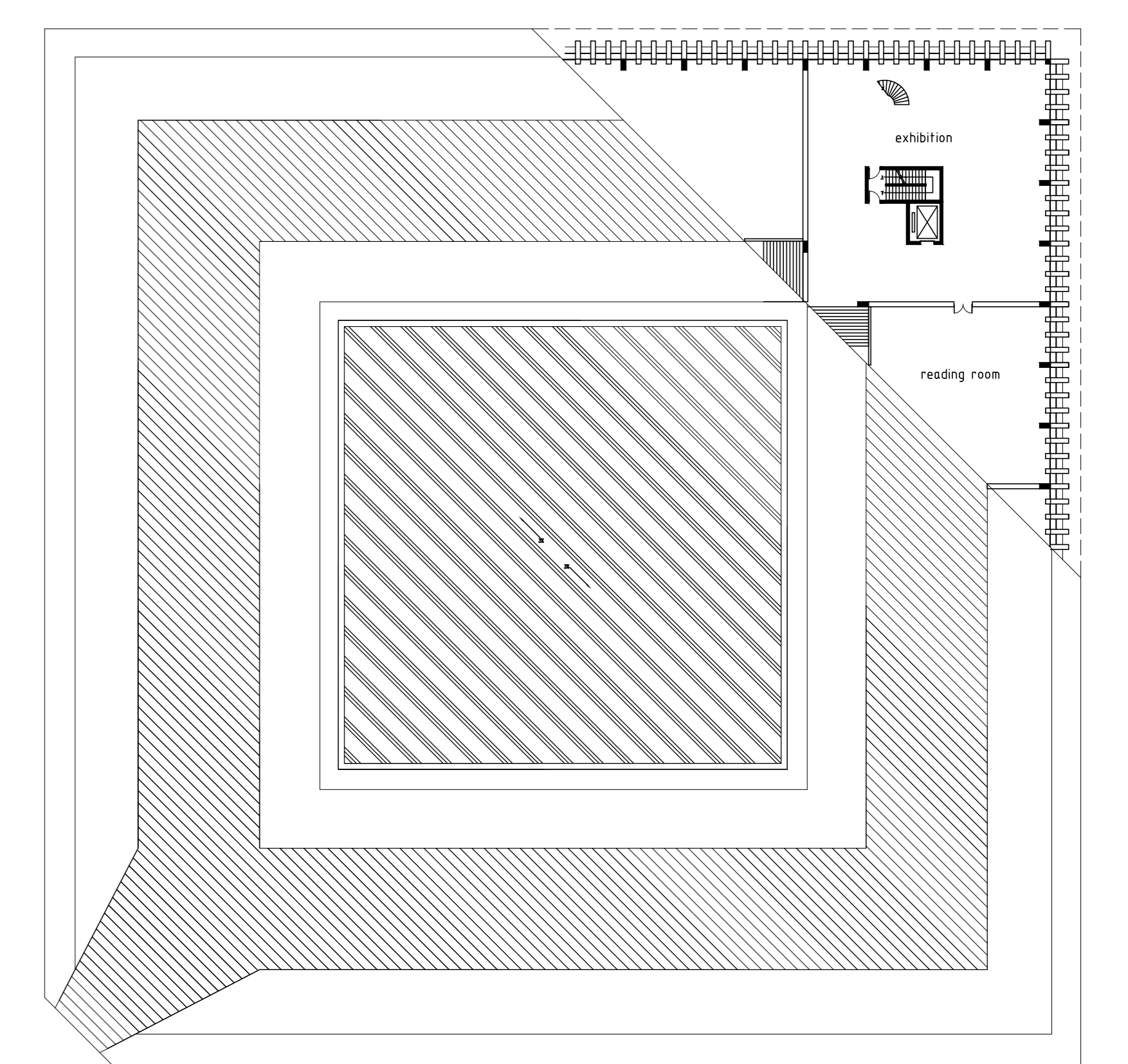

5 plan 1:200

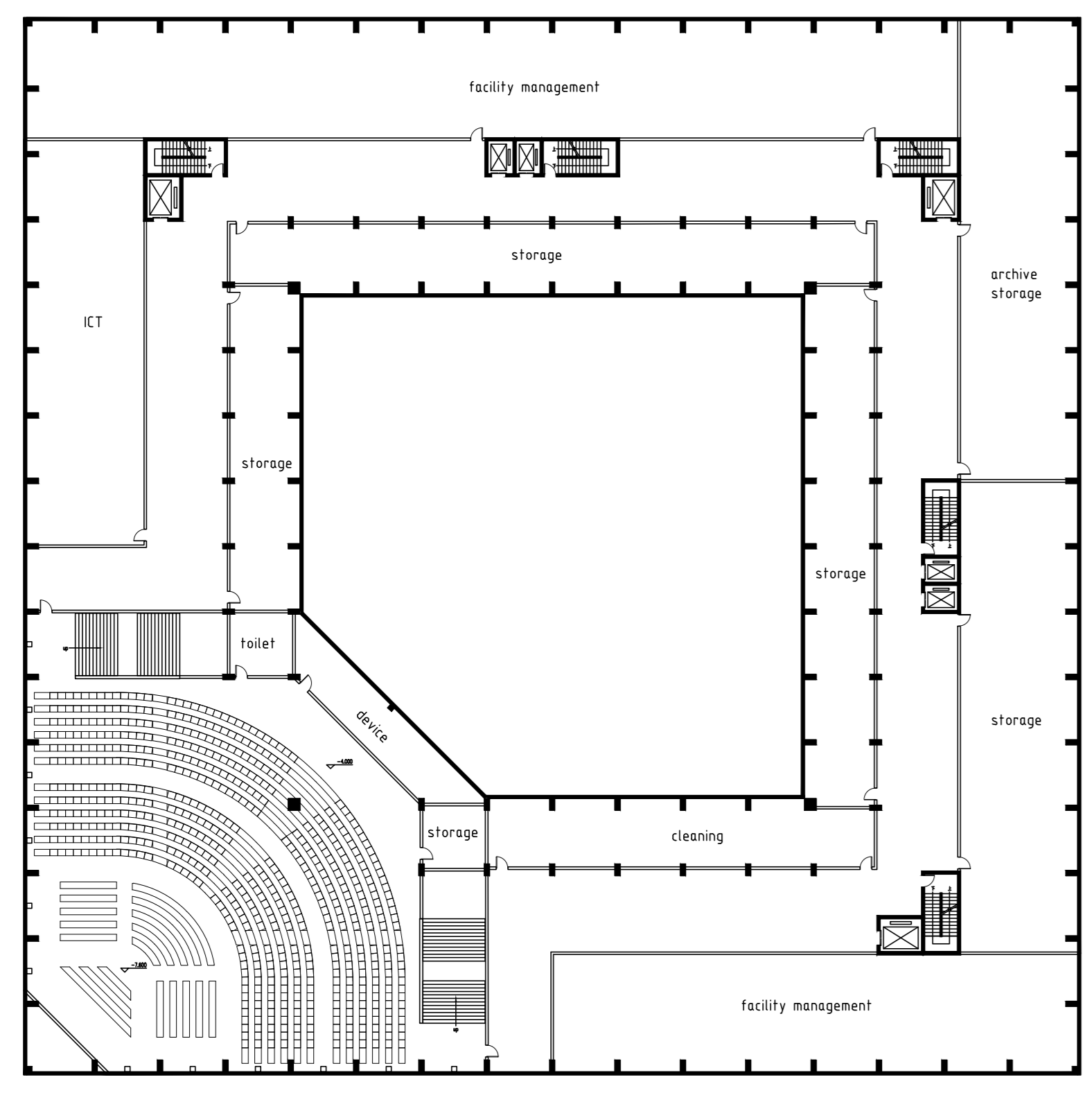

-1 plan 1:200

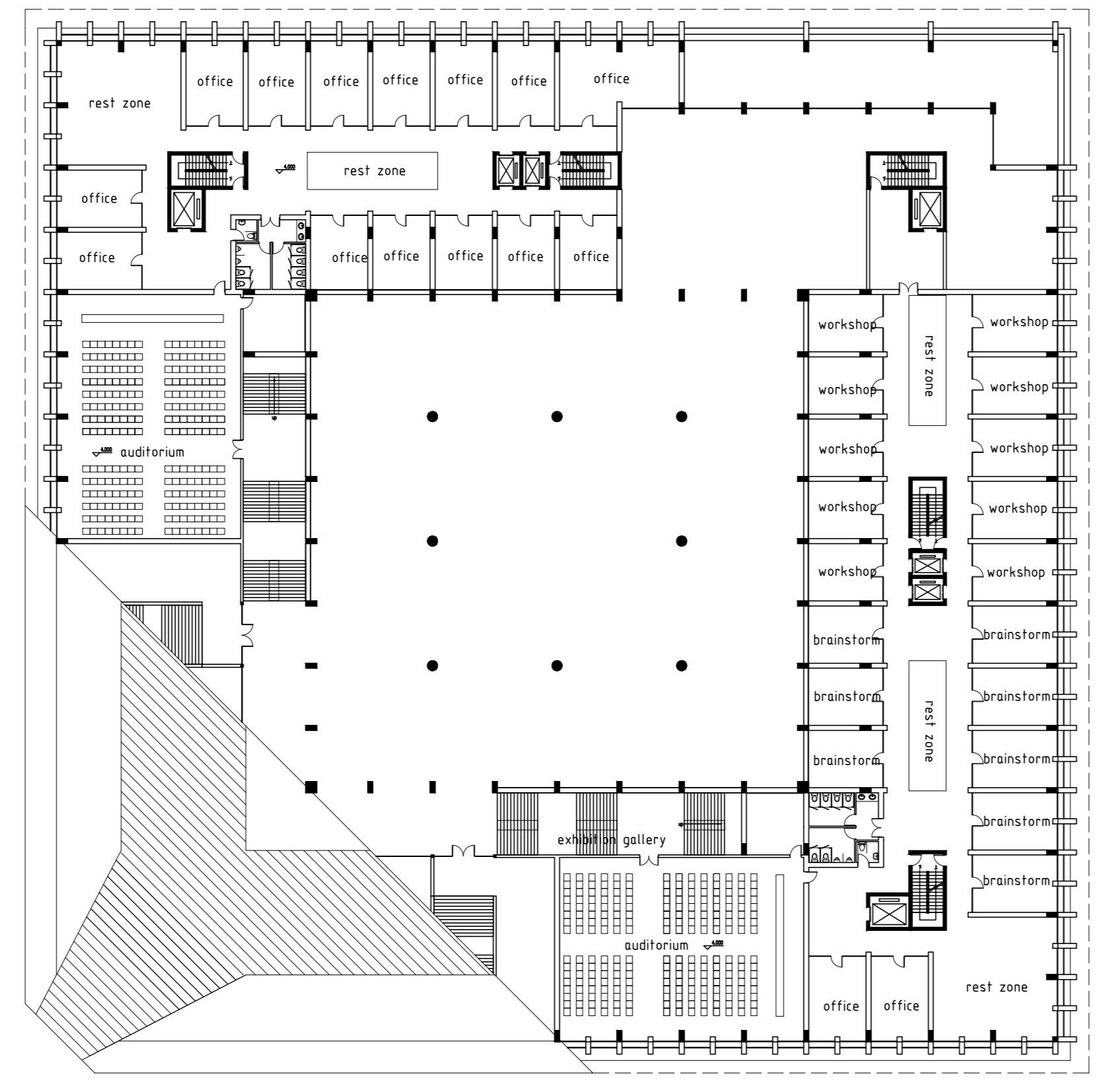

1 plan 1:200

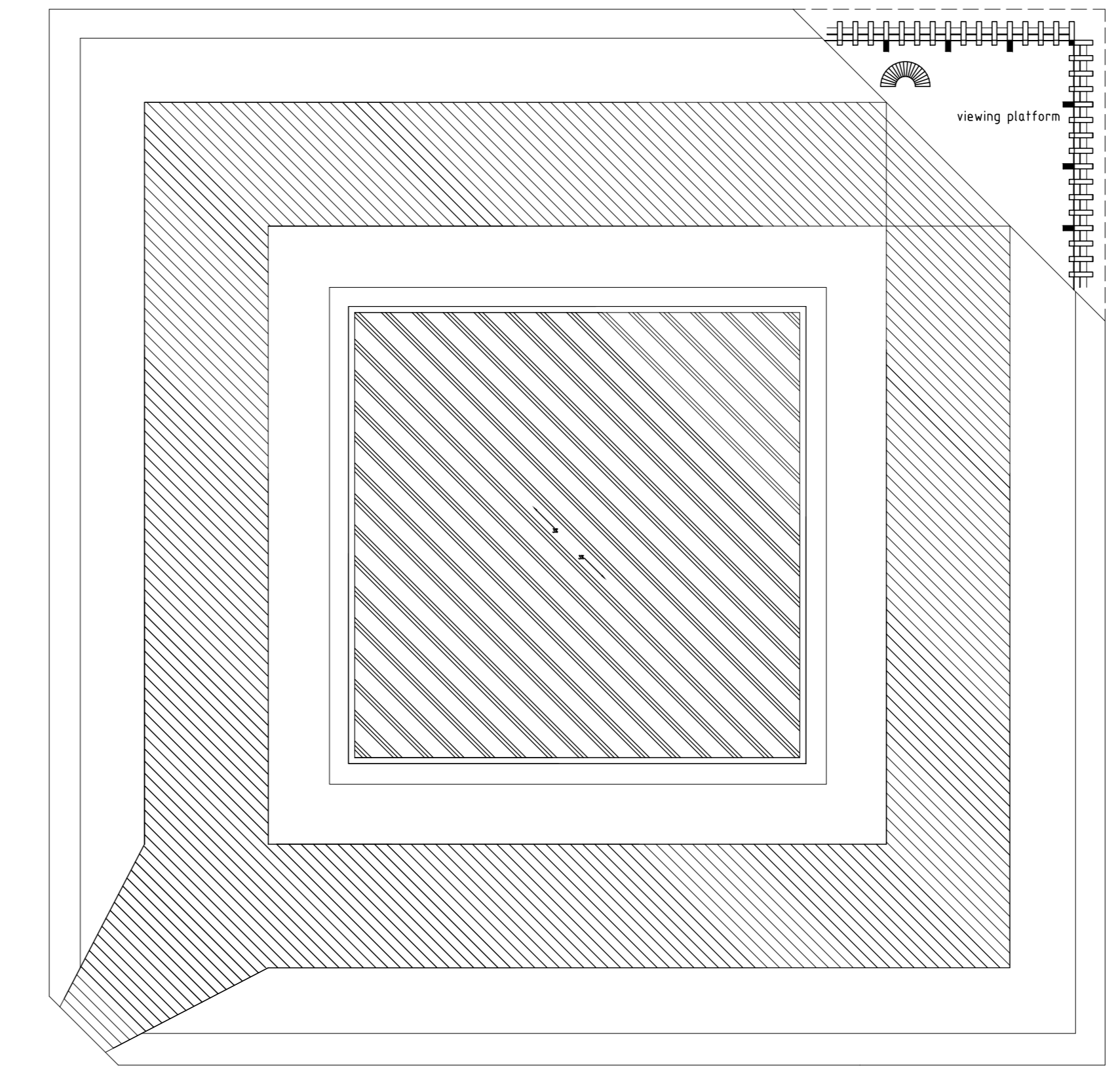

6 plan 1:200

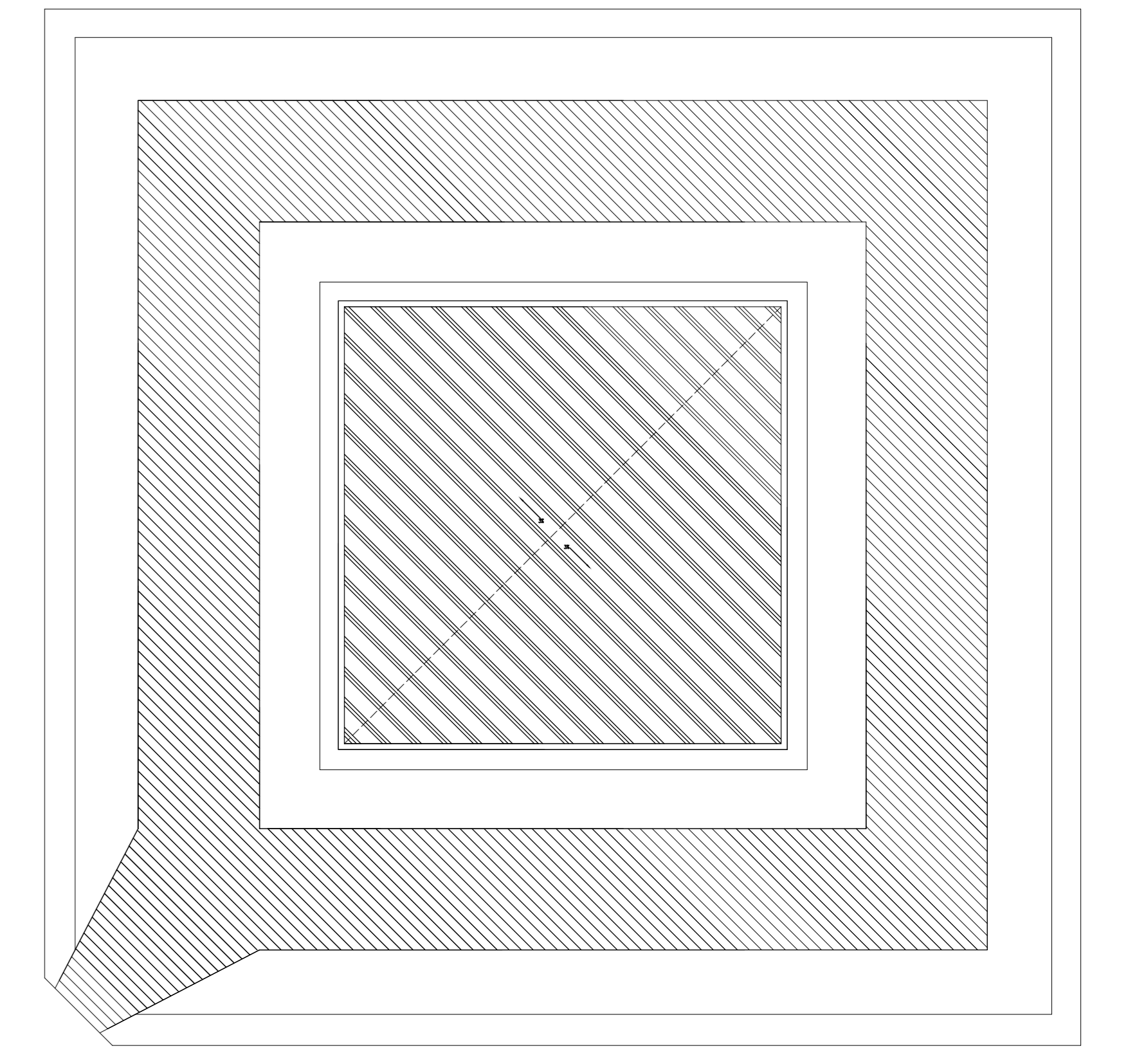

7 plan 1:200

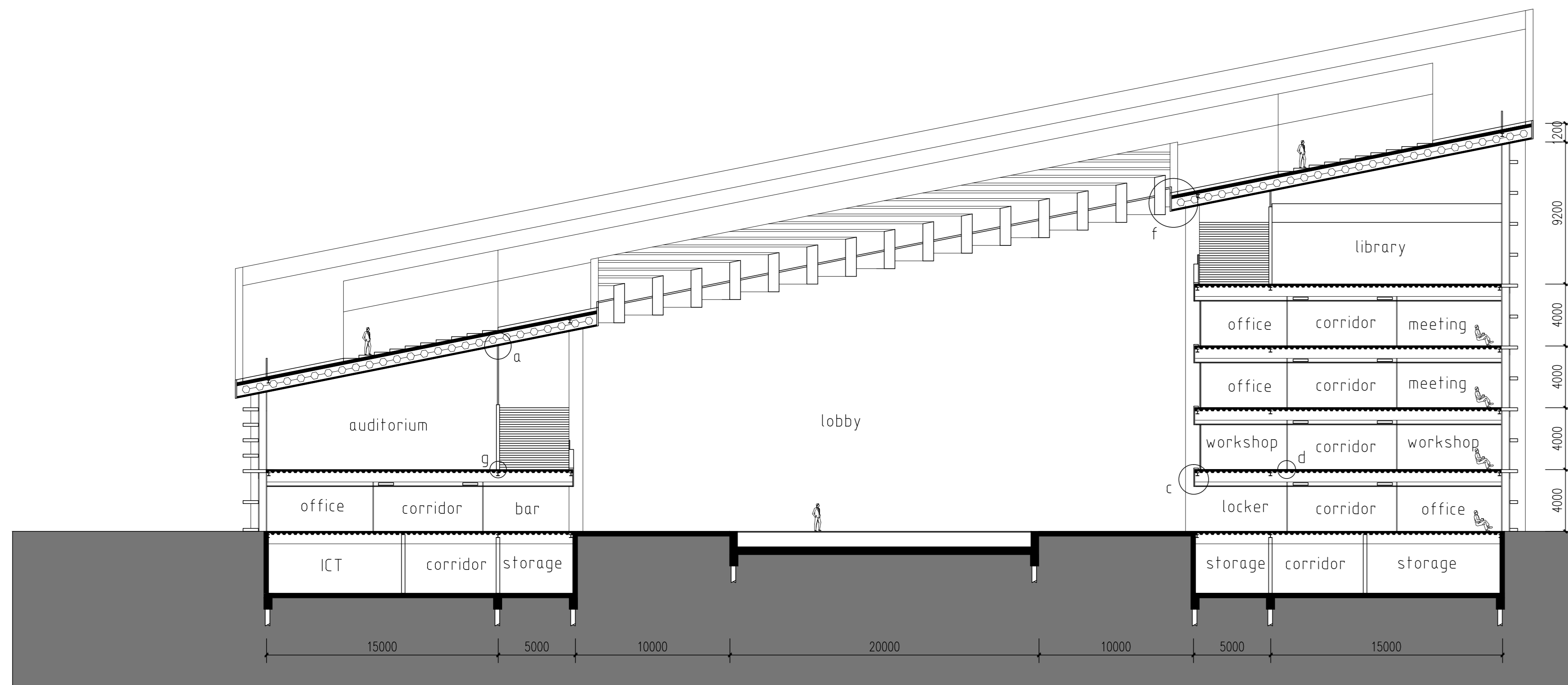

section 1-1 1:200

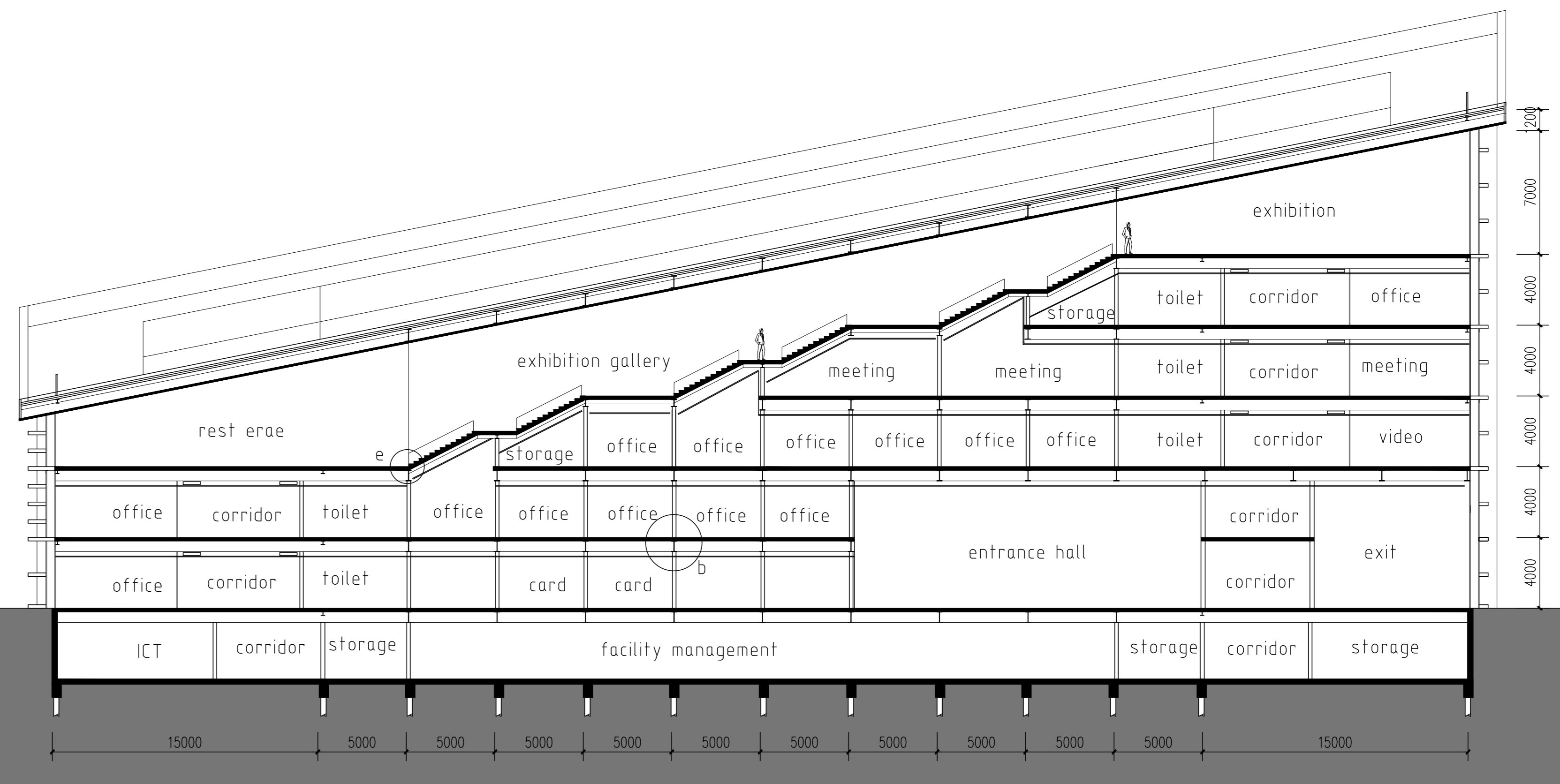

section 2-2 1:200

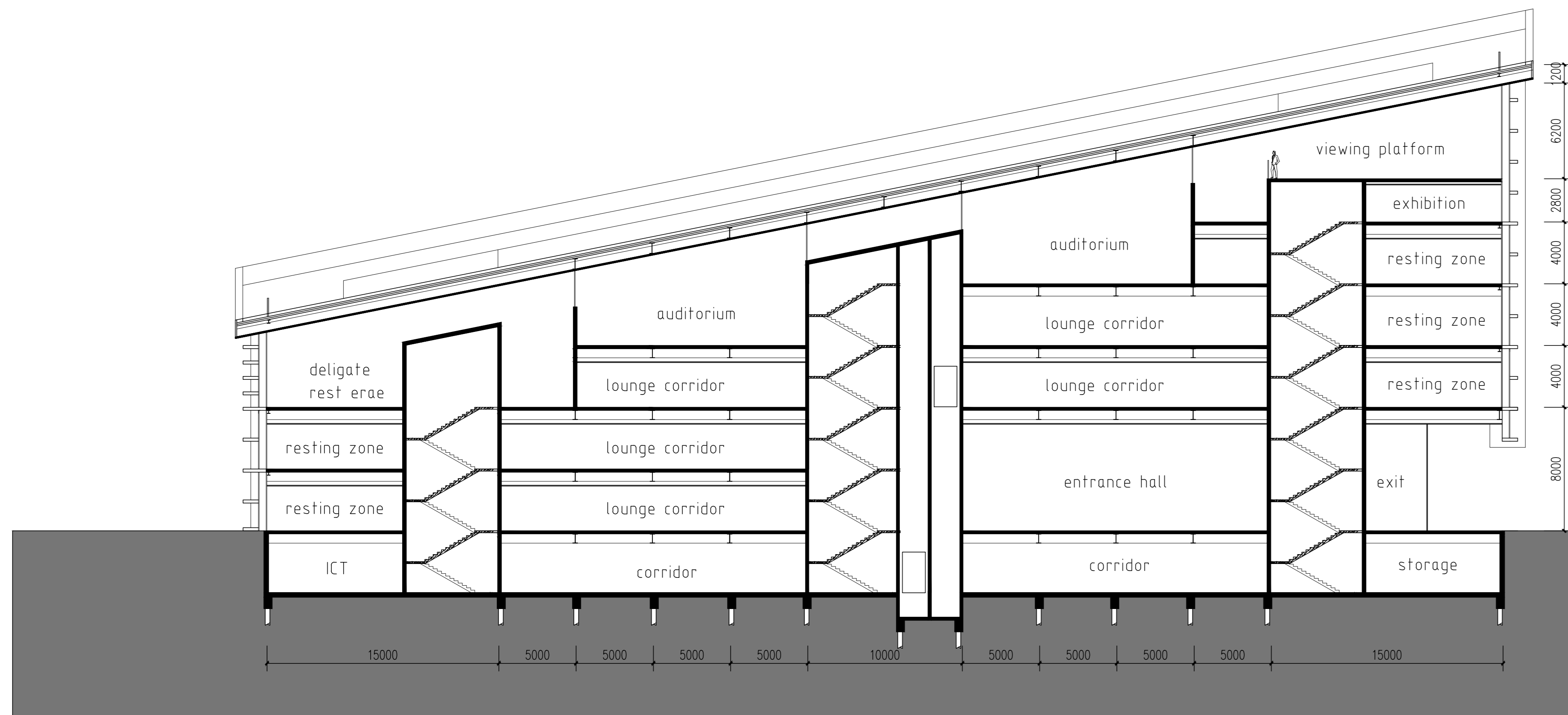

section 3-3 1:200

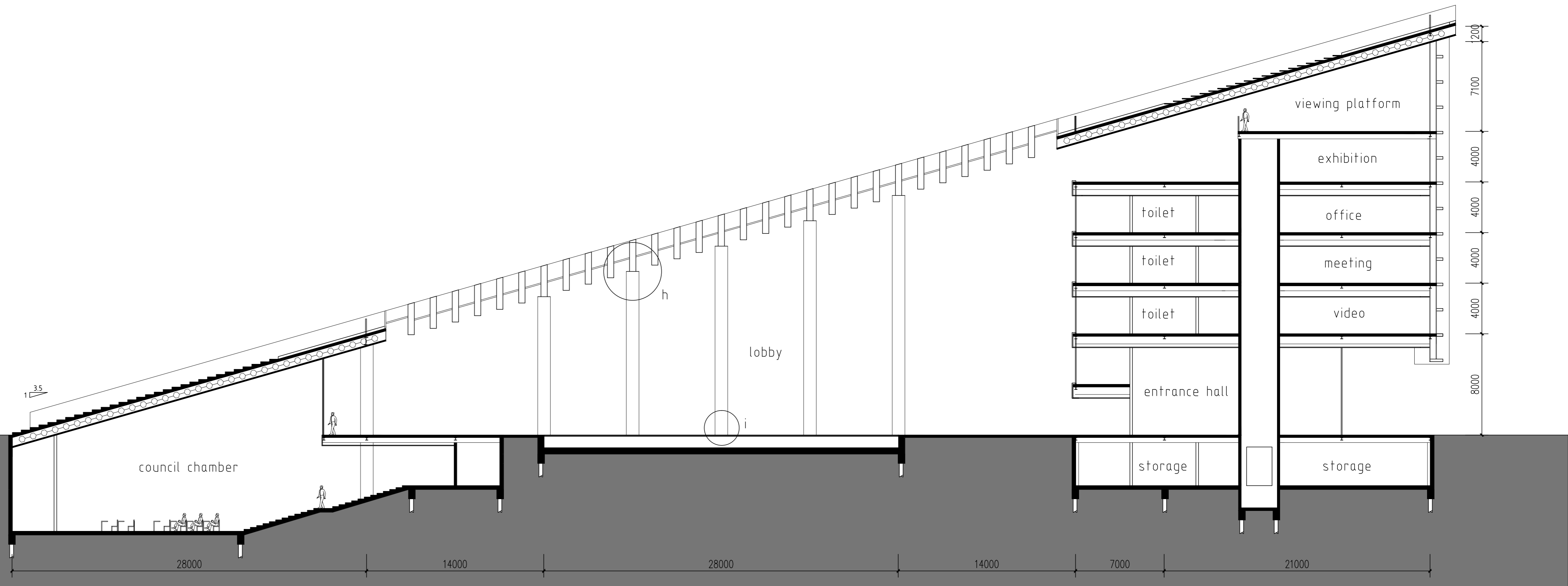

section 4-4 1:200

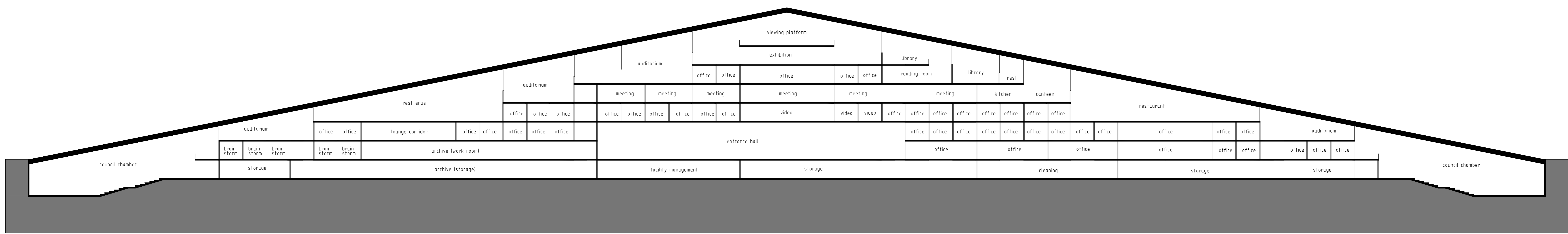

long section diagram

facade elevation 1:20

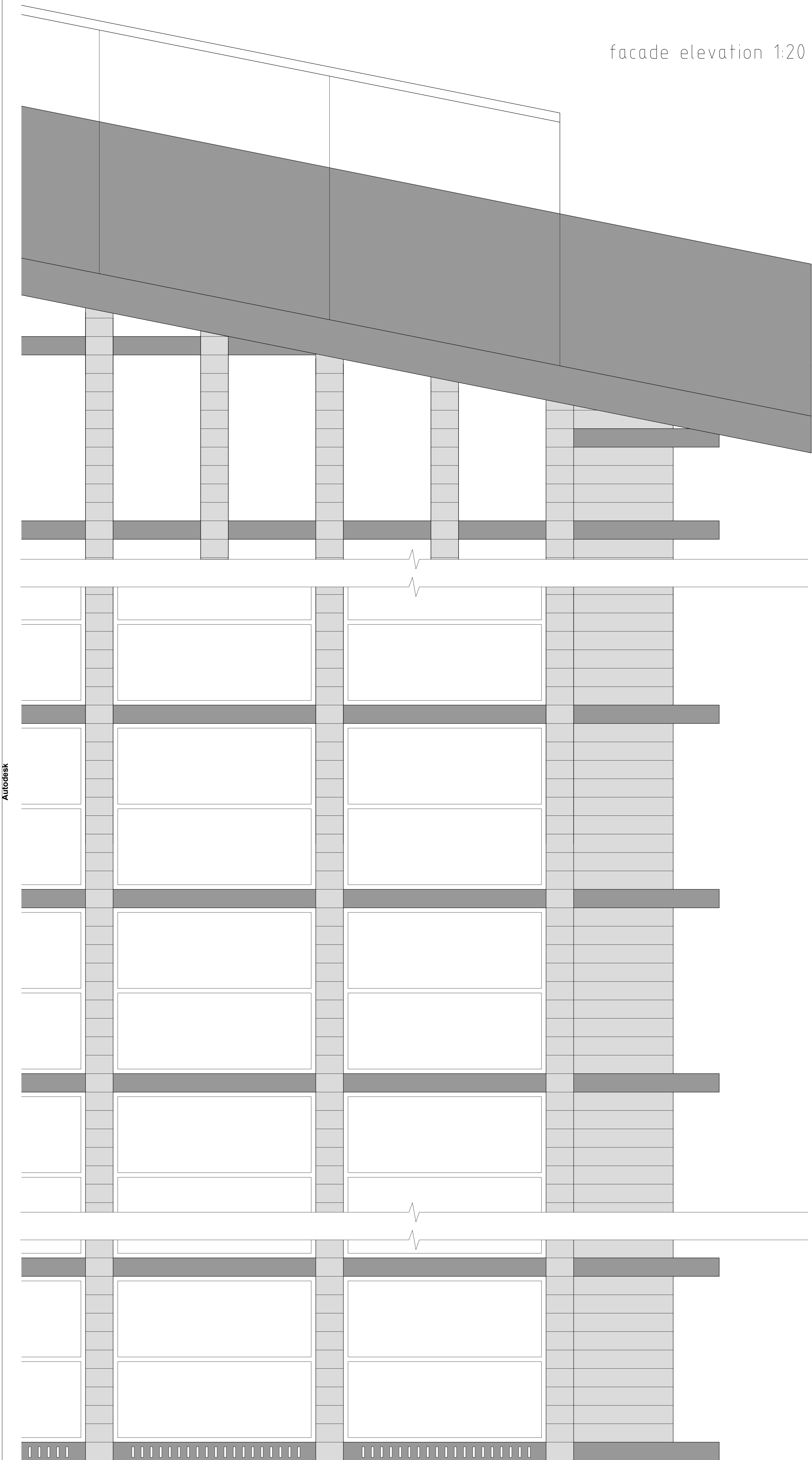

facade section 1:20

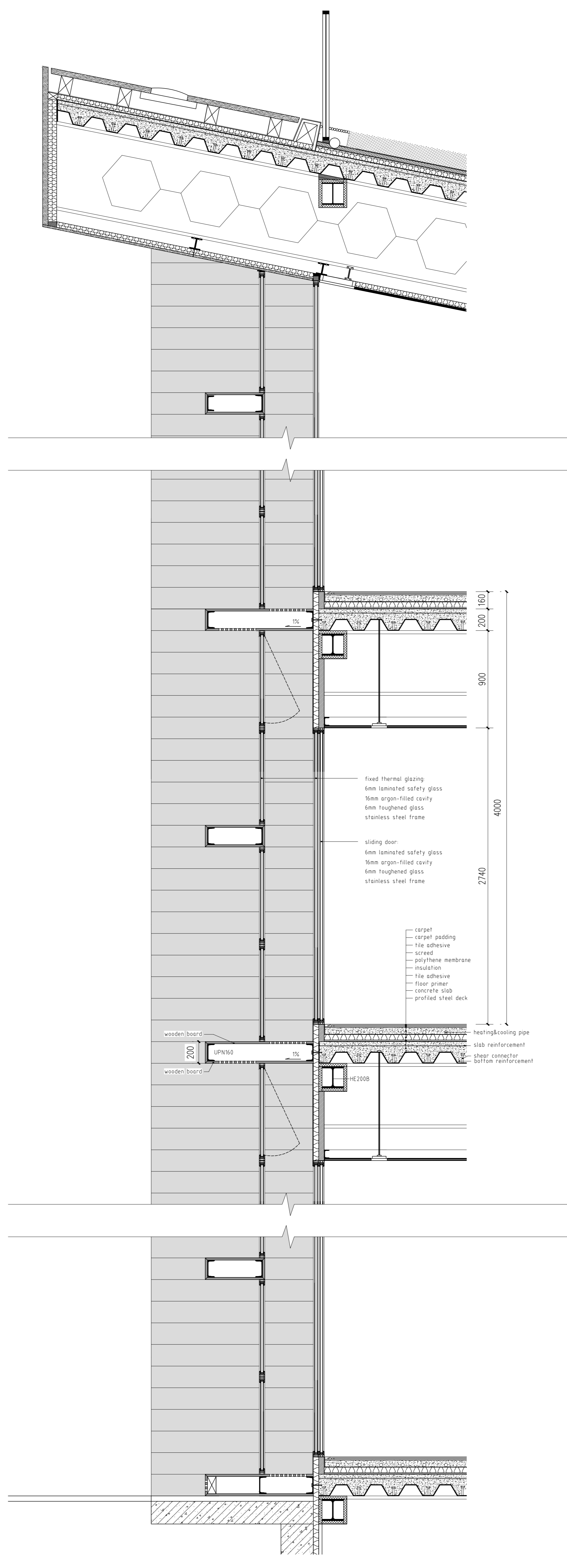

facade interior elevation 1:20

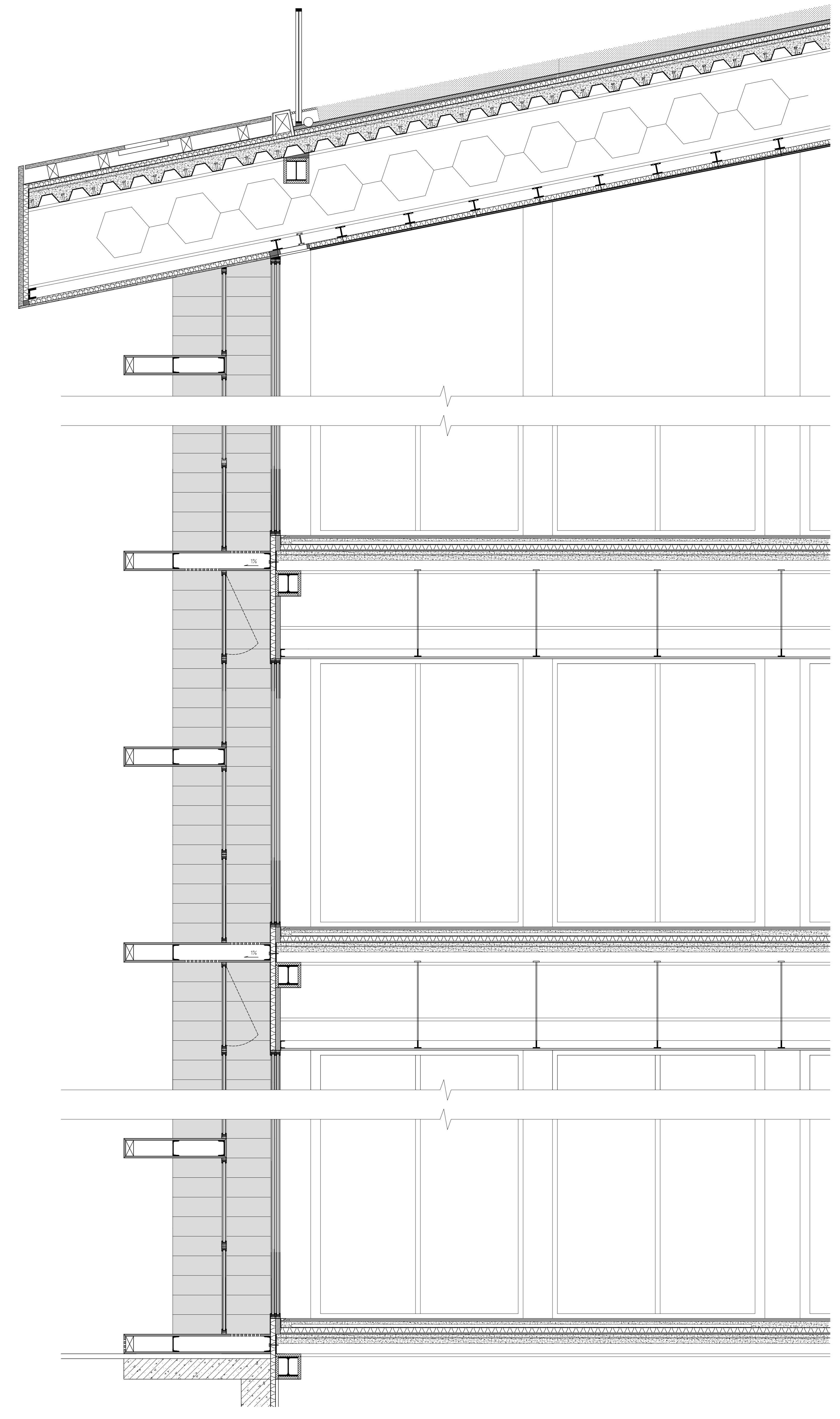



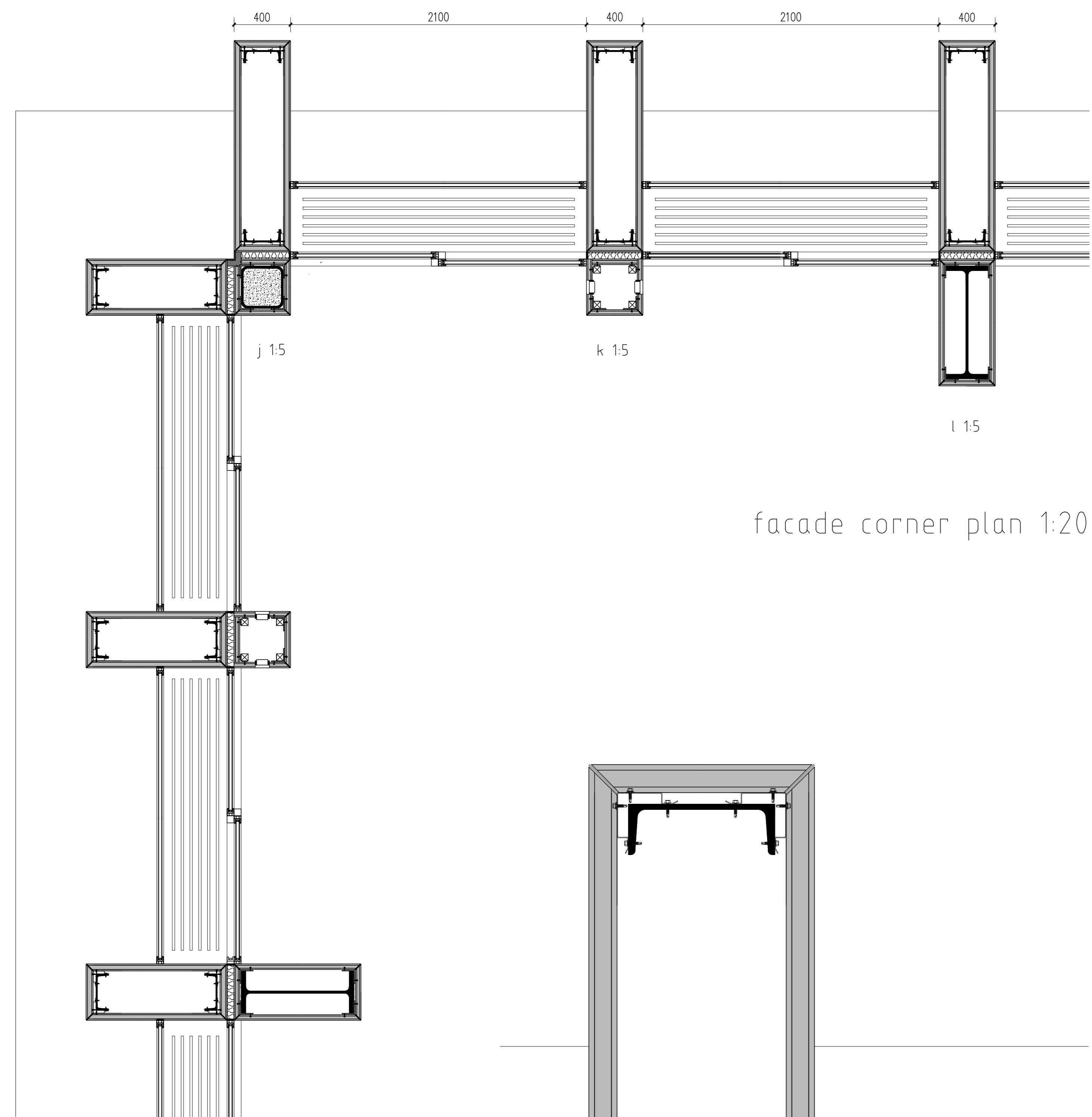

facade corner plan 1:20

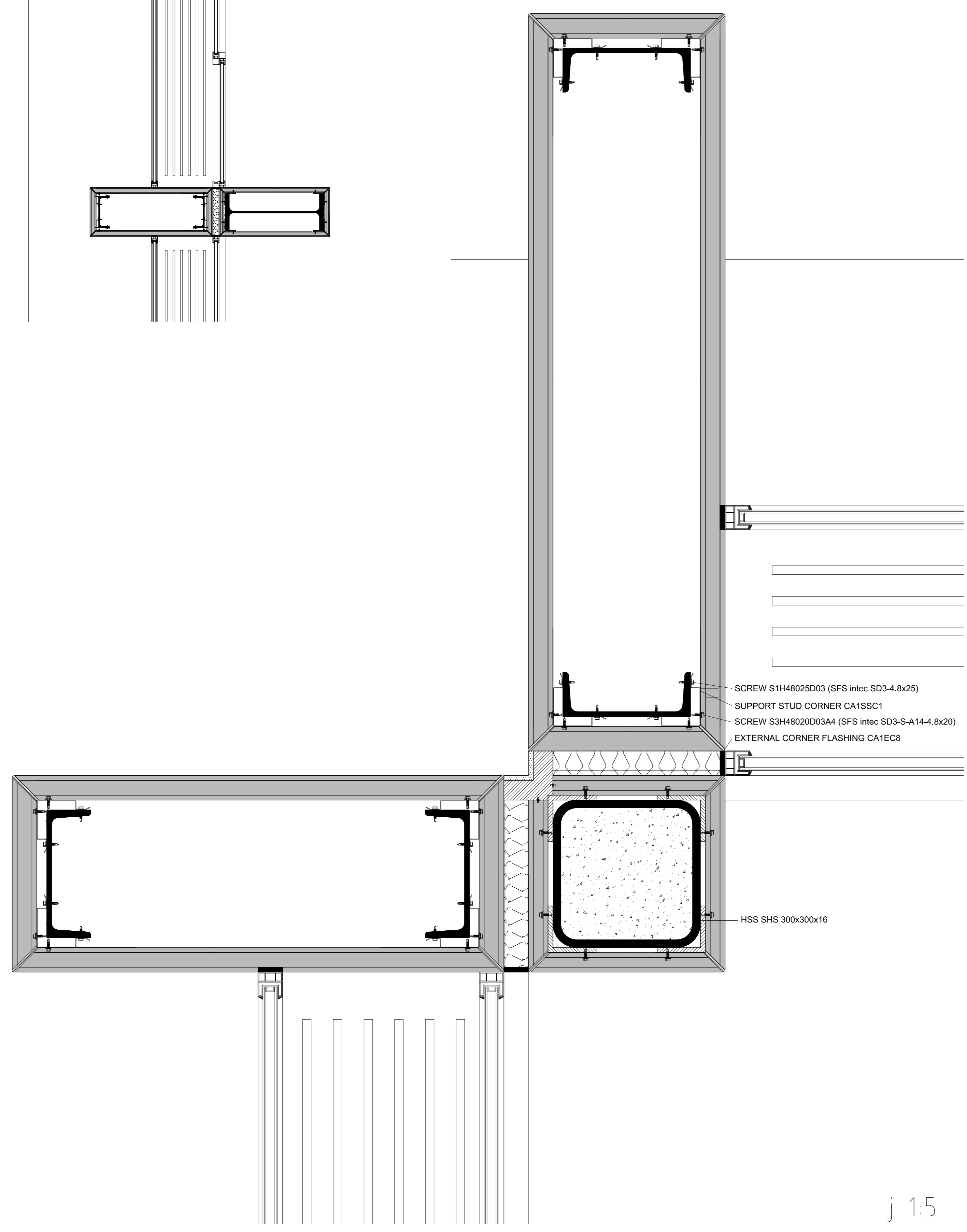
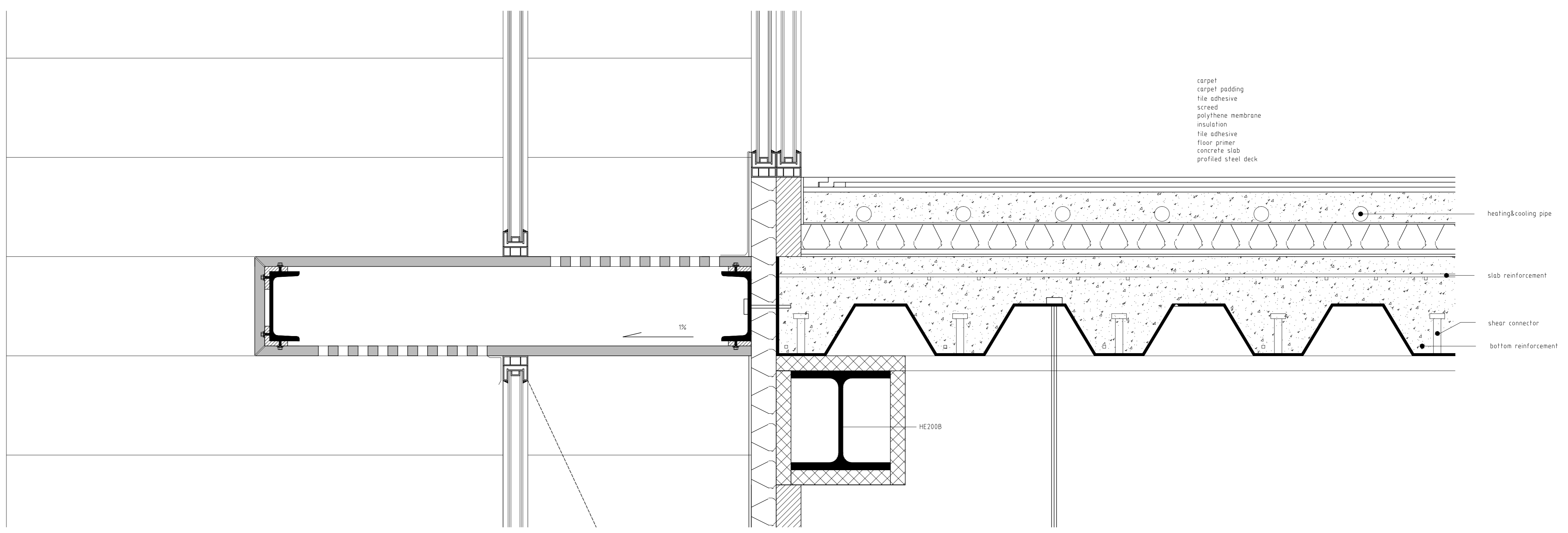

j 1:5

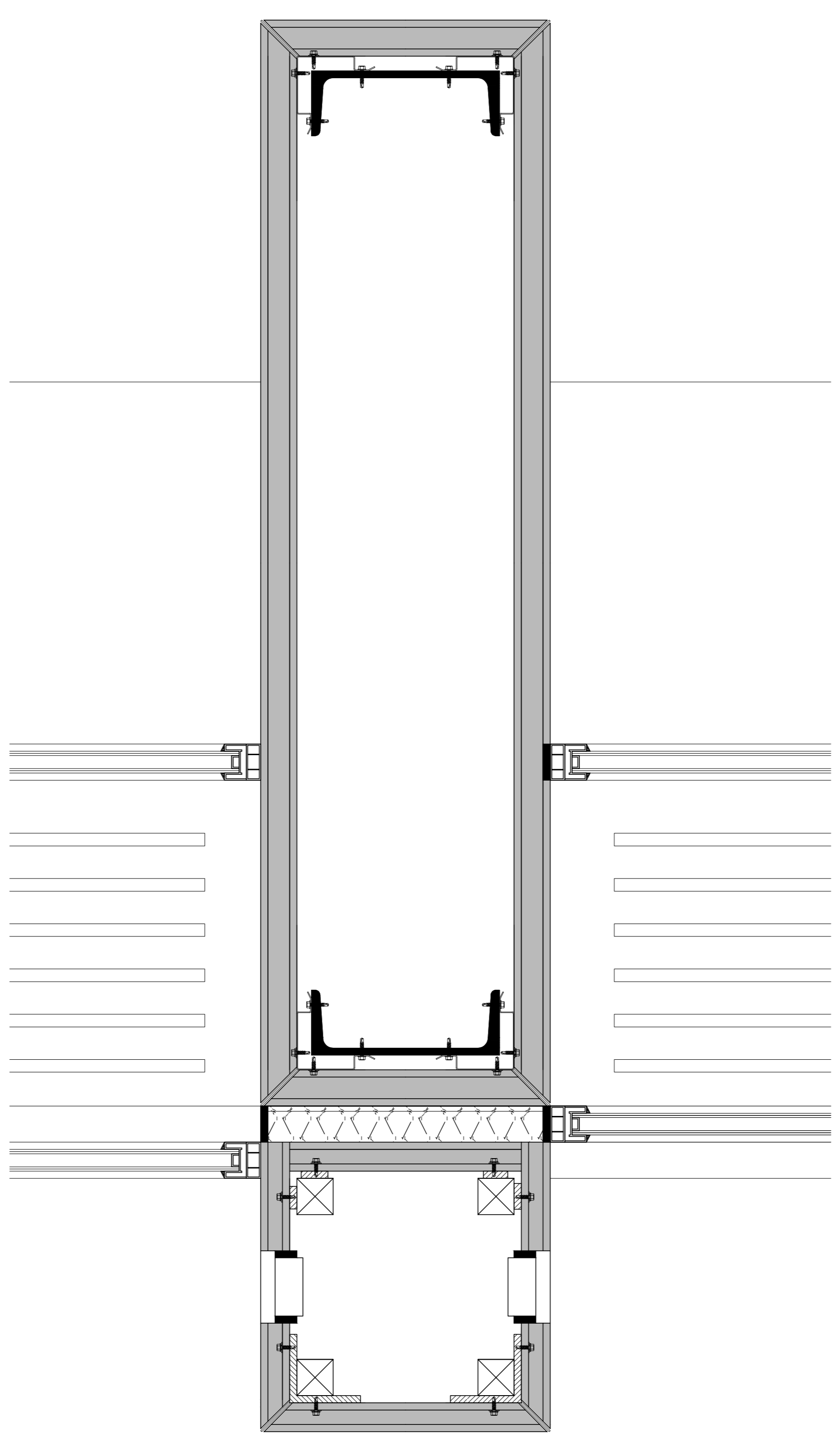

k 1:5

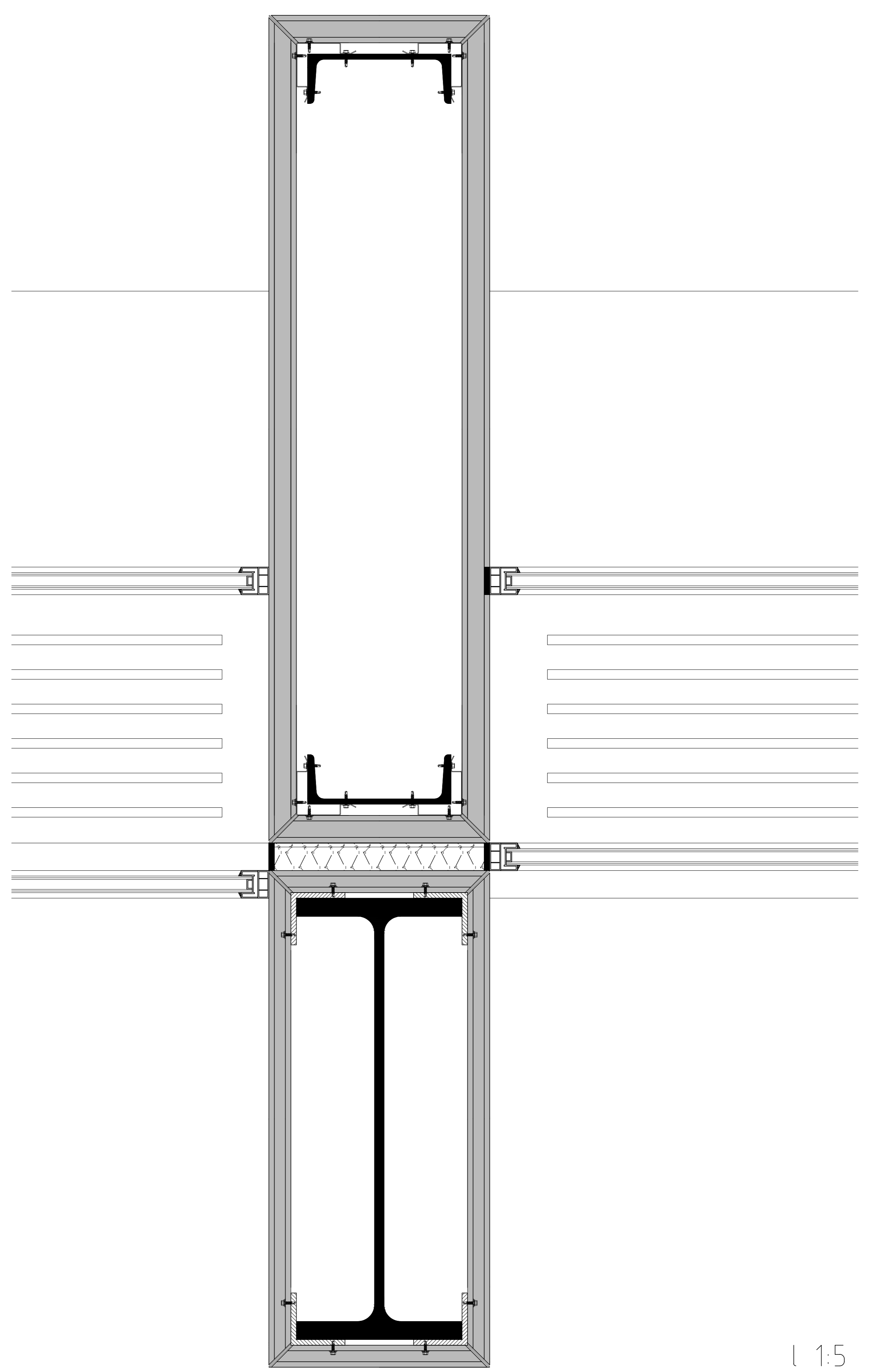

l 1:5

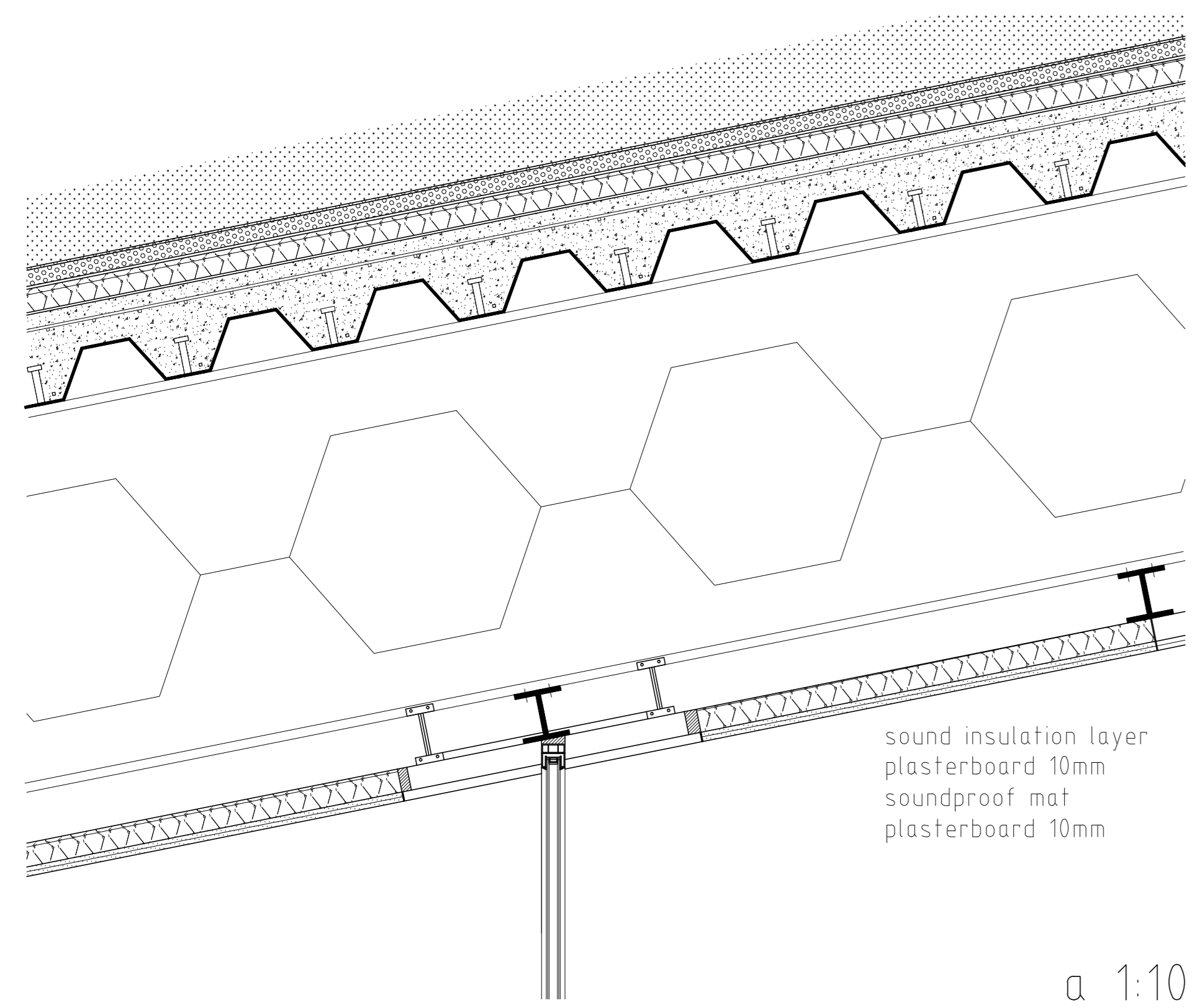

a 1:10

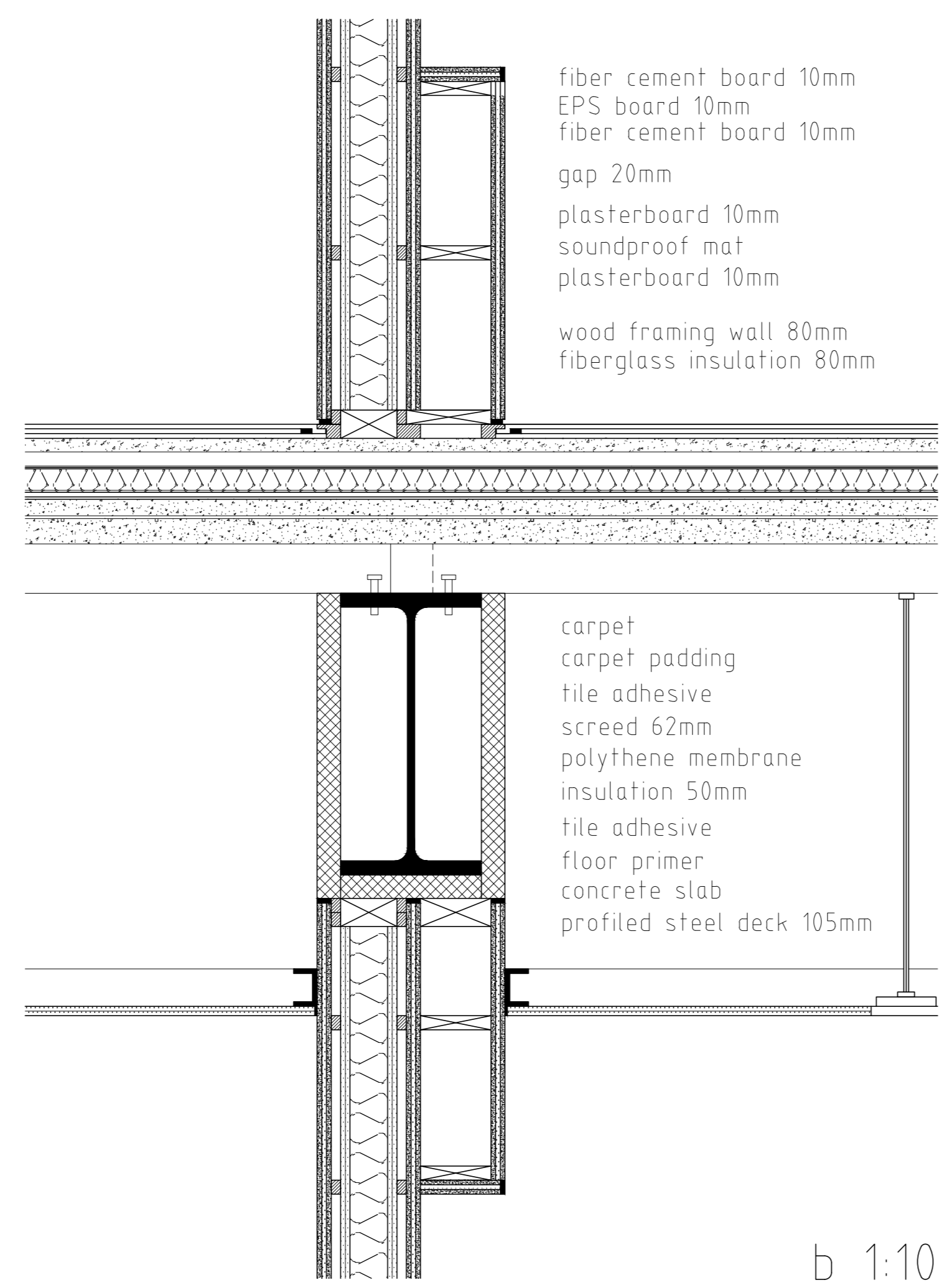

b 1:10

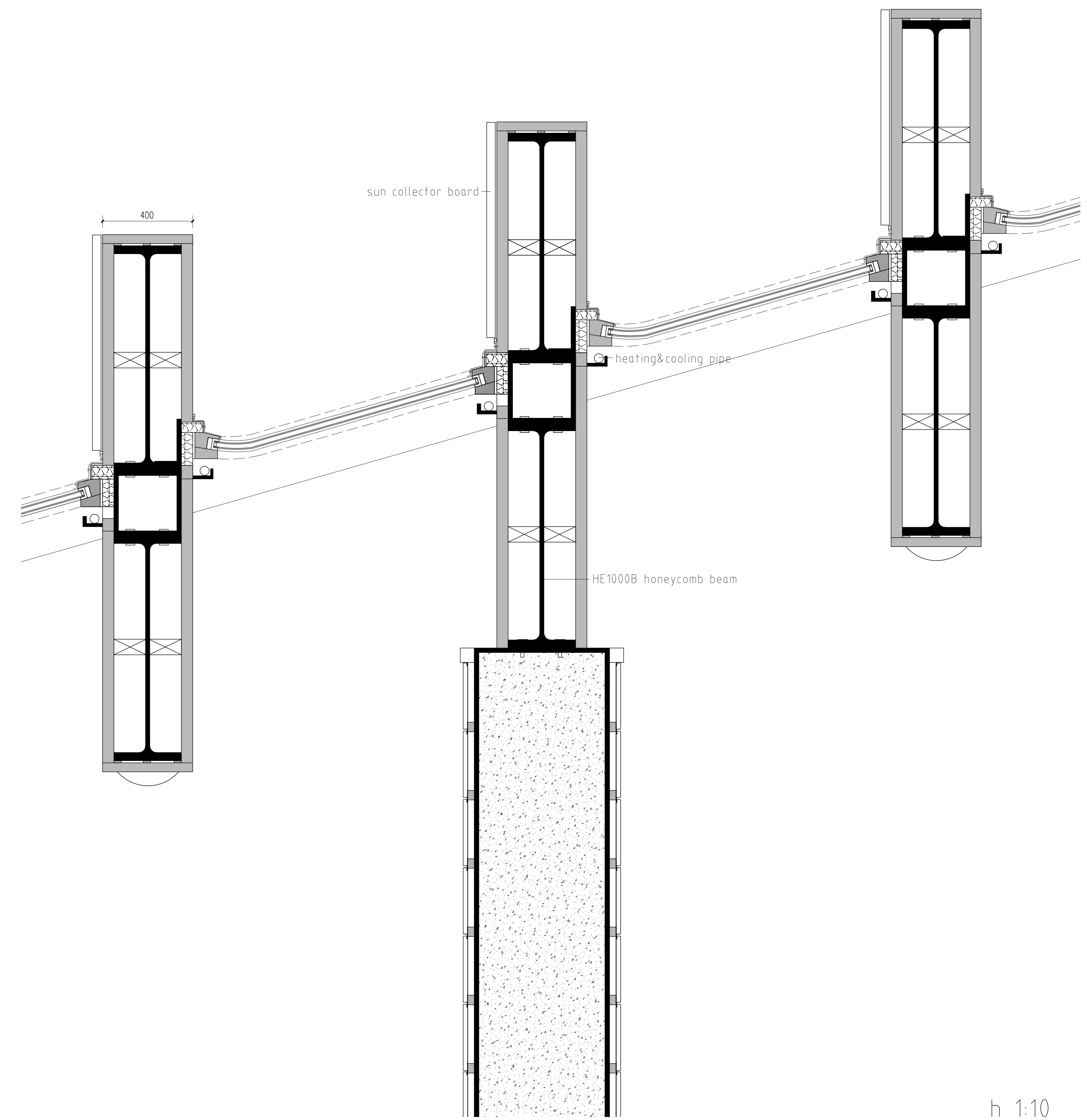

c 1:10

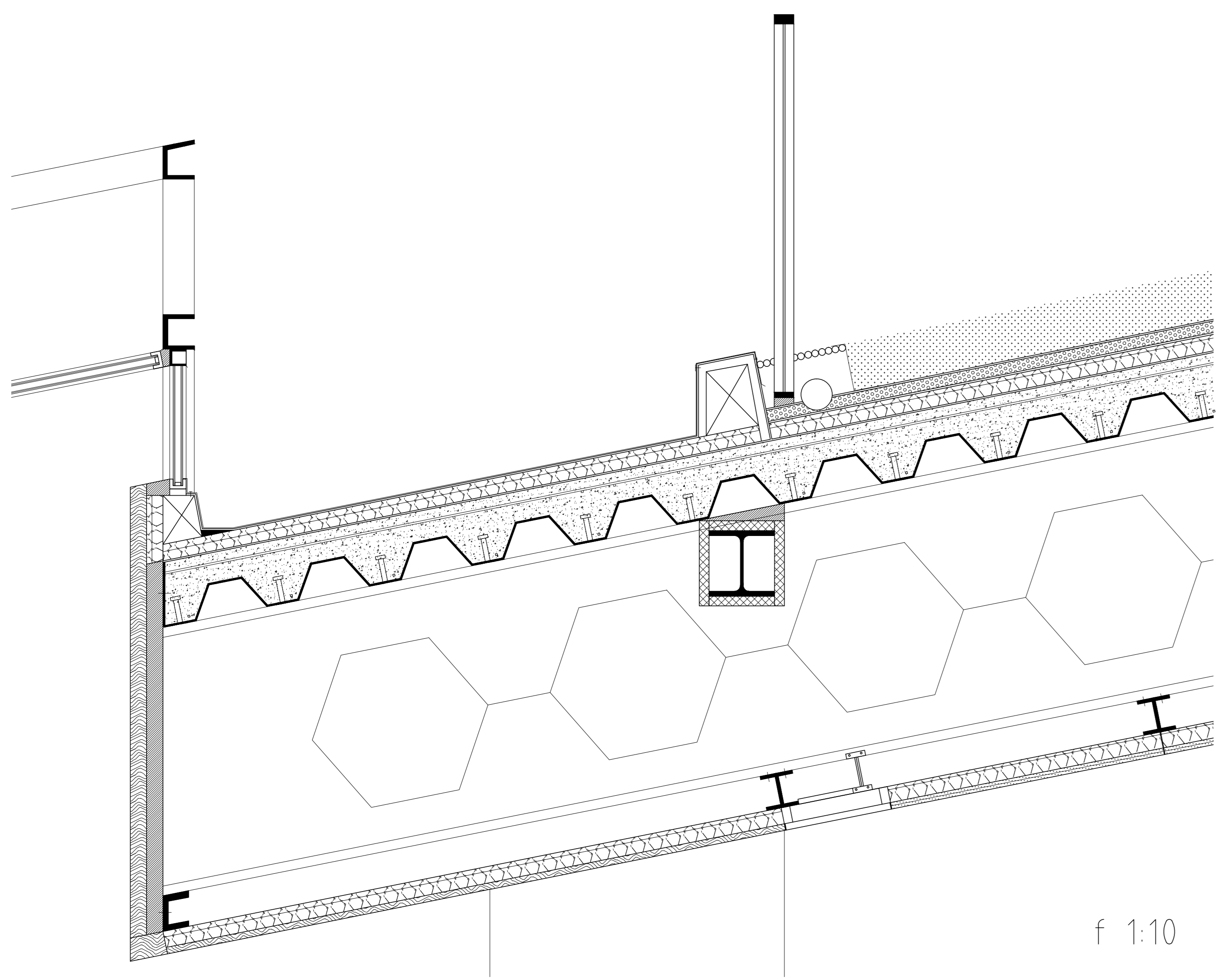

f 1:10

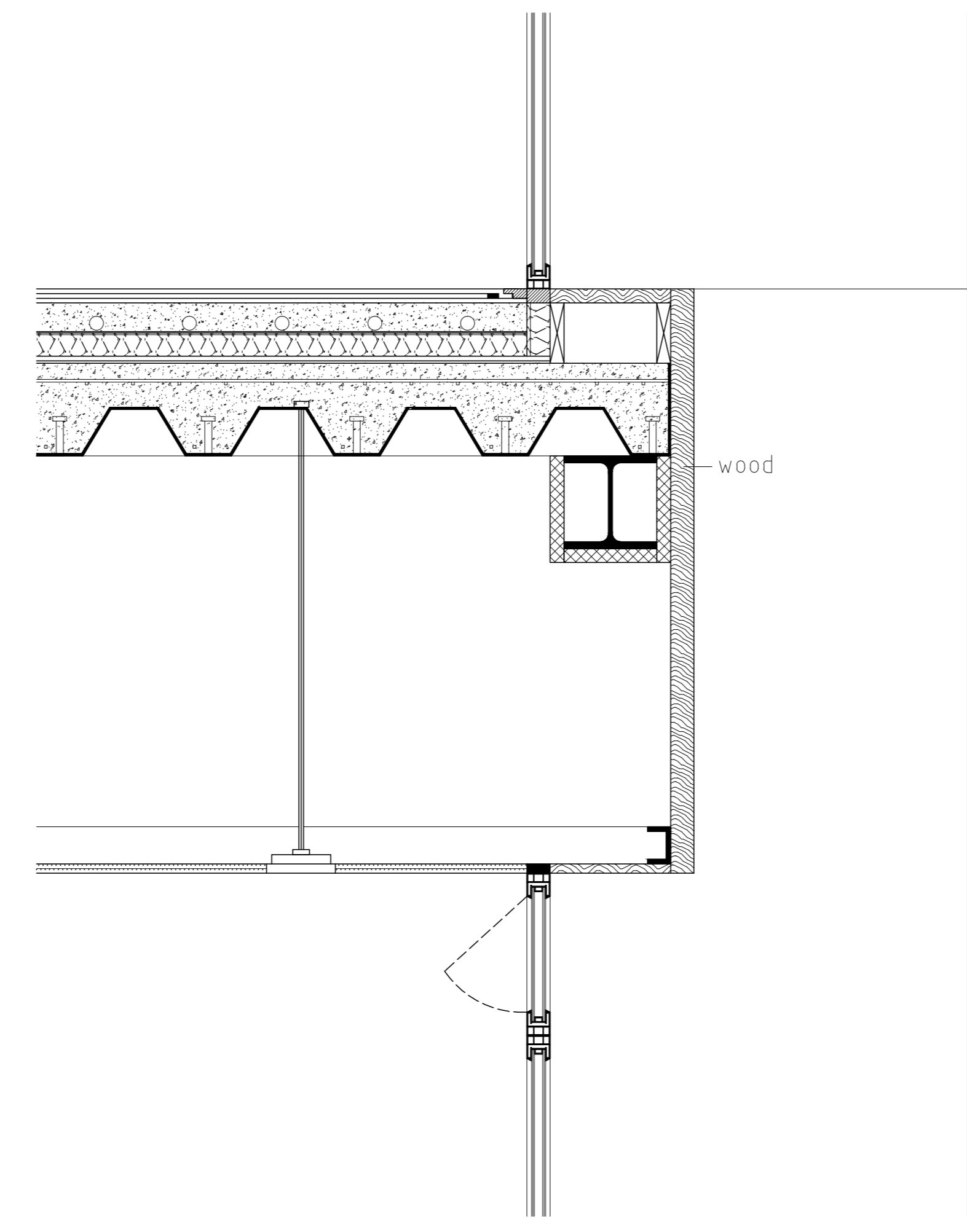

g 1:10

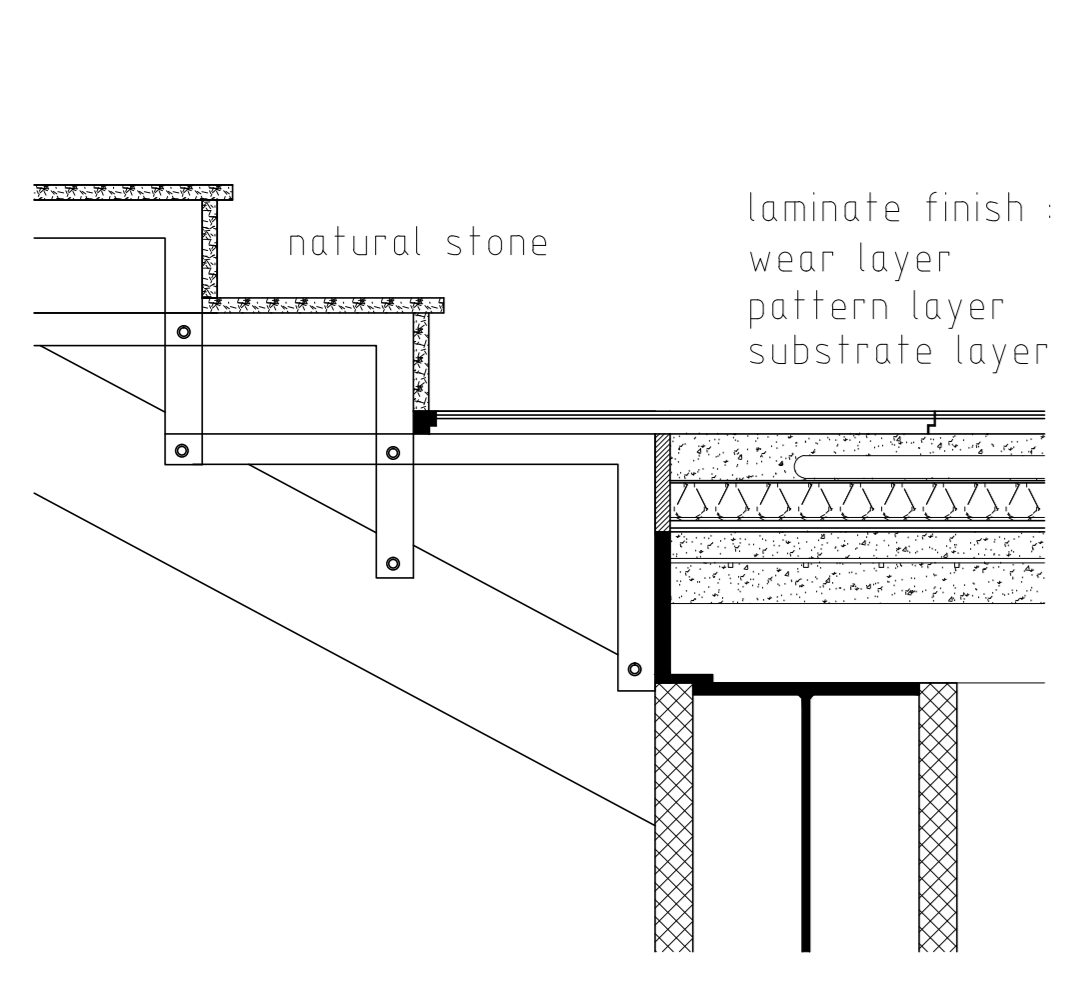

e 1:10

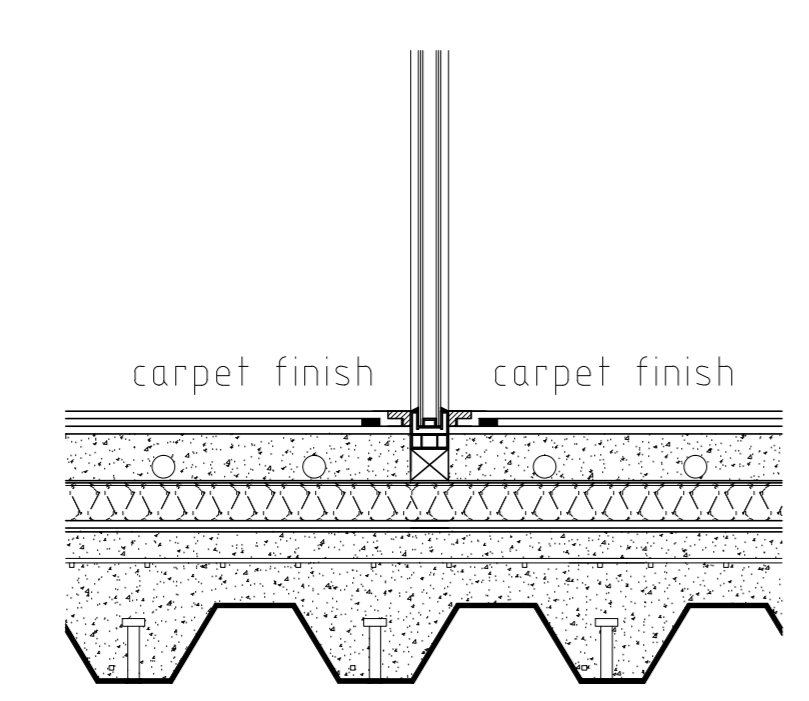

d 1:10

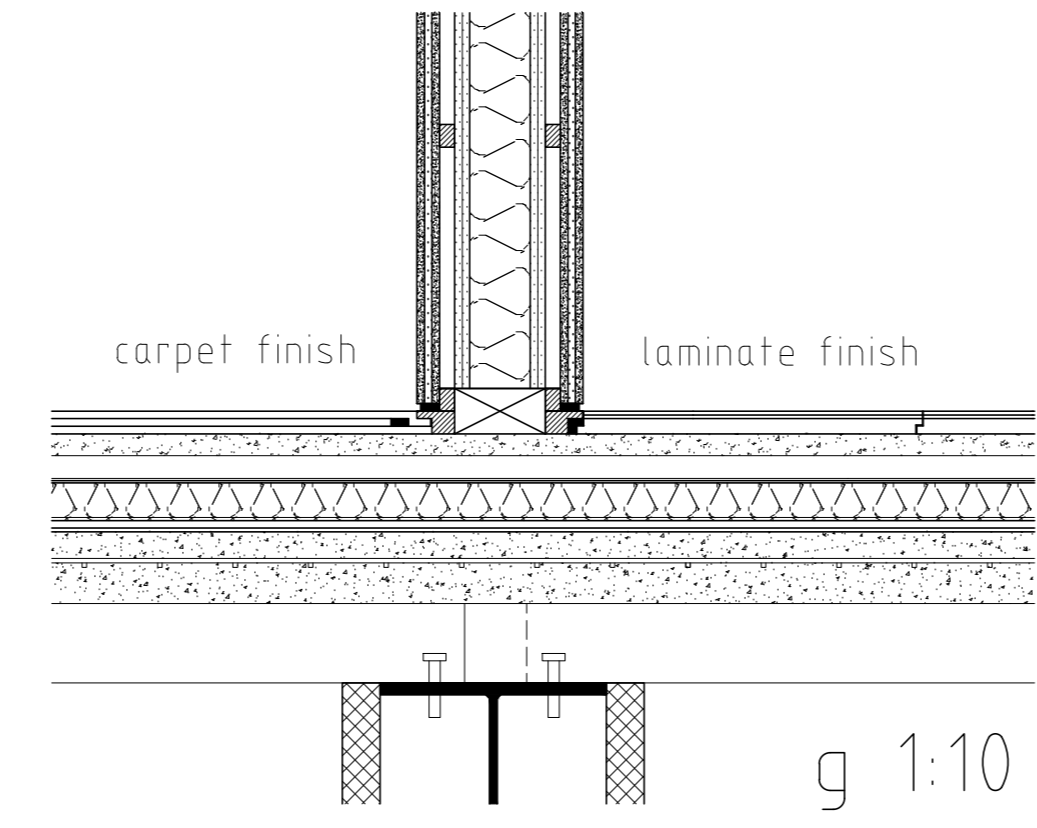
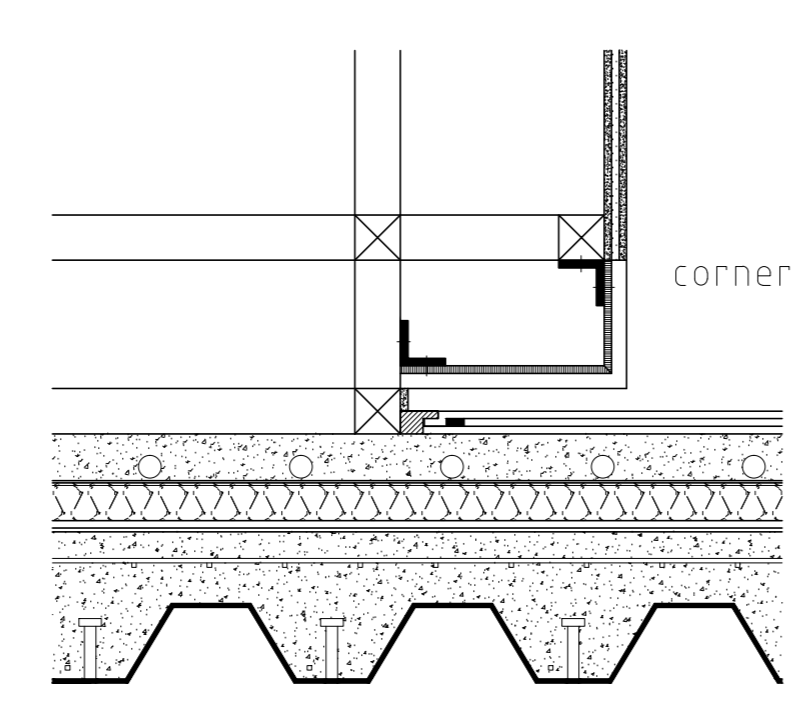

g 1:10

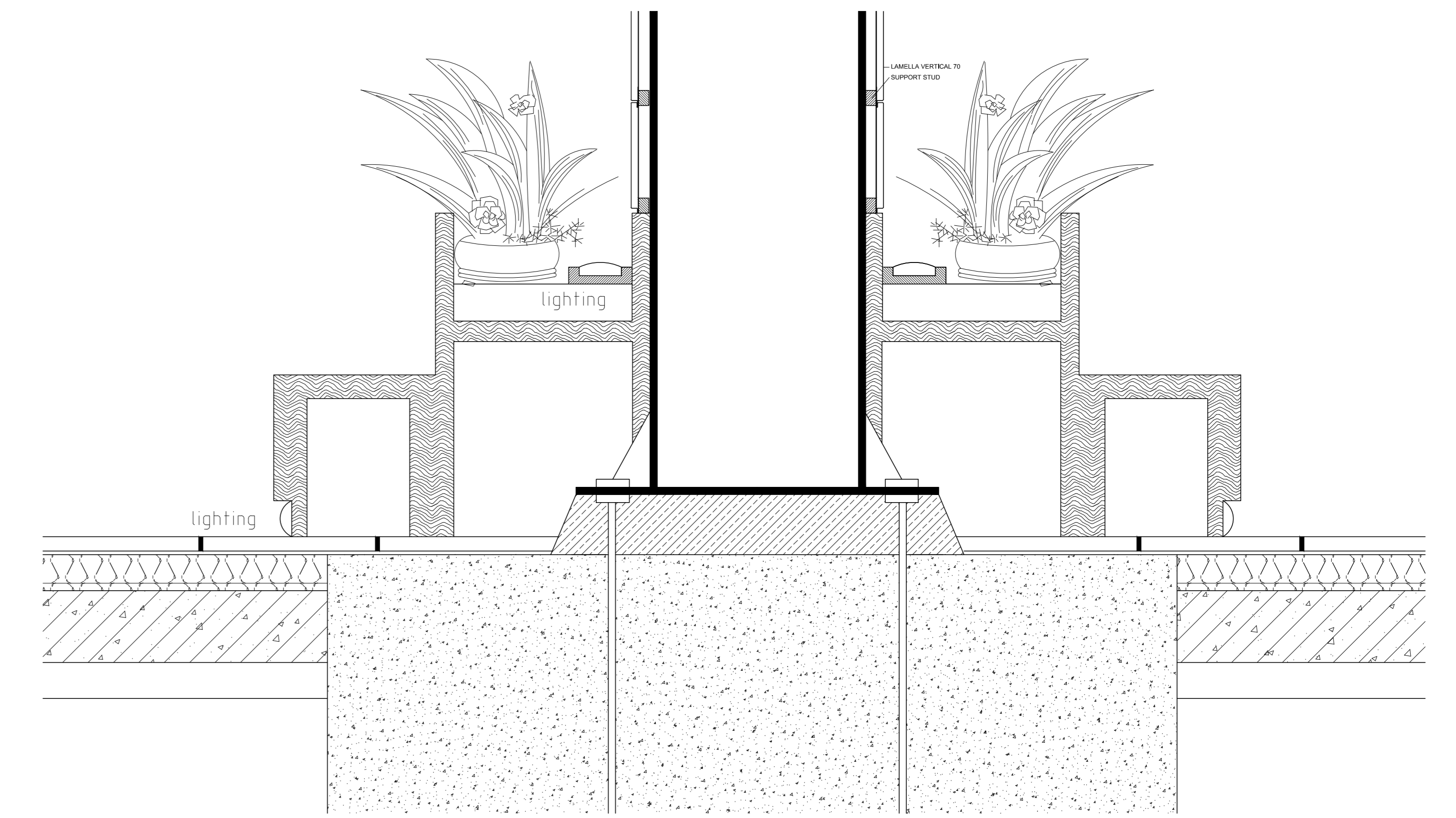

i 1:10

h 1:10