

Towards the understanding of vertical-axis wind turbines in double-rotor configuration

De Tavernier, D.; Ferreira, C.; Li, A.; Paulsen, U. S.; Madsen, H. A.

DOI

[10.1088/1742-6596/1037/2/022015](https://doi.org/10.1088/1742-6596/1037/2/022015)

Publication date

2018

Document Version

Final published version

Published in

Journal of Physics: Conference Series

Citation (APA)

De Tavernier, D., Ferreira, C., Li, A., Paulsen, U. S., & Madsen, H. A. (2018). Towards the understanding of vertical-axis wind turbines in double-rotor configuration. *Journal of Physics: Conference Series*, 1037(2), Article 022015. <https://doi.org/10.1088/1742-6596/1037/2/022015>

Important note

To cite this publication, please use the final published version (if applicable). Please check the document version above.

Copyright

Other than for strictly personal use, it is not permitted to download, forward or distribute the text or part of it, without the consent of the author(s) and/or copyright holder(s), unless the work is under an open content license such as Creative Commons.

Takedown policy

Please contact us and provide details if you believe this document breaches copyrights. We will remove access to the work immediately and investigate your claim.

PAPER • OPEN ACCESS

Towards the understanding of vertical-axis wind turbines in double-rotor configuration.

To cite this article: D. De Tavernier *et al* 2018 *J. Phys.: Conf. Ser.* **1037** 022015

View the [article online](#) for updates and enhancements.

Related content

- [Rotor solidity effects on the performance of vertical-axis wind turbines at high Reynolds numbers](#)
M.A. Miller, S. Duvvuri, W.D. Kelly et al.
- [Aeroelastic Stability Investigations for Large-scale Vertical Axis Wind Turbines](#)
B C Owens and D T Griffith
- [Wind tunnel experiments of a pair of interacting vertical-axis wind turbines](#)
A Vergaerde, T De Troyer, J Kluczewska-Bordier et al.



IOP | ebooks™

Bringing you innovative digital publishing with leading voices to create your essential collection of books in STEM research.

Start exploring the collection - download the first chapter of every title for free.

Towards the understanding of vertical-axis wind turbines in double-rotor configuration.

D. De Tavernier^{*}, C. Ferreira^{*}, A. Li[◇], U.S. Paulsen[◇] and H.A. Madsen[◇]

^{*} Delft University of Technology, Wind Energy, Kluyverweg 1, Delft, The Netherlands,

[◇] Technical University of Denmark, Wind Energy, Frederiksborgvej 399, Roskilde, Denmark.

E-mail: D.A.M.DeTavernier@tudelft.nl

Abstract. Vertical-axis wind turbines (VAWTs) in double-rotor configuration, meaning two rotors in close proximity, have the ability to enhance the power performance. In this study, we work towards the understanding of vertical-axis wind turbines in double-rotor configuration. Numerical simulations are performed to gain insight in the physics behind the double-rotor concept. Furthermore, a parametric study is performed to explore the effect of the double-rotor lay-out, rotor loading, rotor spacing and wind direction on the flow characteristics and the power generation.

Nomenclature

c = Chord length [m]	R = Rotor radius [m]	α = Angle of attack [deg]
C_P = Power coefficient [-]	V_{rel} = Relative velocity [m/s]	θ = Azimuthal angle [deg]
C_T = Thrust coefficient [-]	V_∞ = Incoming velocity [m/s]	σ = Rotor solidity, $Nc/2R$ [-]
d_{int} = Rotor spacing, D_{int}/D [-]	x = X-coordinate, X/D [-]	λ = Tip speed ratio, ω^R/V_{inf} [-]
D = Rotor diameter, $2R$ [m]	y = Y-coordinate, Y/D [-]	ω = Rotational speed [rad/s]

1. Introduction

During the last decade, there is an increased interest in vertical-axis wind turbines (VAWTs) and how to improve their efficiency. This trend is driven by the floating offshore wind farm application and the need to decrease the cost of energy. Great advances are already made in the rotor aerodynamics of VAWTs; however, most of the research focusses on single turbines.

1.1. Background

Some studies have been conducted to understand the effect of VAWTs in double-rotor configuration, meaning two rotors in close proximity as visually presented in Figure 1. Dabiri [1] performed field tests on various configurations of counter-rotating VAWTs and has shown the potential to enhance the power performance using closely spaced VAWTs. These findings are confirmed by numerical studies performed by Ning [2], Araya et al. [3], Feng et al. [4] and Zanforlin et al. [5]. Ning modified the actuator cylinder theory such that it can simulate the aerodynamic loading of multiple turbines. Araya et al. developed a low-order model using Rankine bodies and Feng et al. used a free vortex model

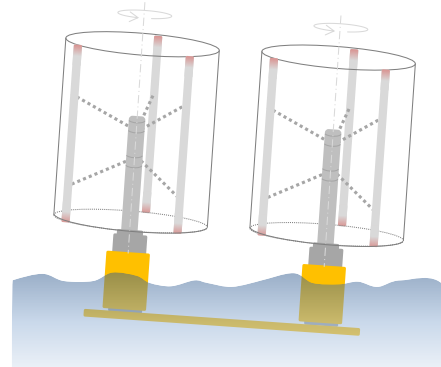

Figure 1: Double-rotor VAWT.

with empirical wake models. Zanforlin et al. presented a two-dimensional URANS simulation of the flow around a pair of counter-rotating VAWTs, with various spacings, tip speed ratios and wind directions. These studies also pointed out the sensitivity to wind direction that could cause the performance of the individual turbines to degrade compared to an isolated rotor. Recently, academia and industry are collaborating to experimentally validate the numerical predictions of torque and power for double-rotor VAWTs with various rotor spacings [6]. Besides the power increment, other advantages of the double-rotor configuration have been recognised such as fast wake recovery and lower costs with respect to offshore floaters and O&M; to state some of the advantages mentioned in [1, 7].

1.2. Research objective

The research goals of this work are: (i) Gaining a physical understanding of a double-rotor configuration and identifying the differences with respect to the single-rotor. (ii) Thoroughly investigating the effect of various aspects such as tip speed ratio, solidity, rotational direction, rotor spacing, wind direction, etc. on the flow characteristics of the rotors and the power generation.

2. Methodology

2.1. Numerical code

The simulations of this parametric study are performed using U2DiVA. U2DiVA is a two-dimensional panel/vortex model, developed by Ferreira [8]. It follows the Prandtl's lifting line theory and represents airfoils by a distribution of sources and doublets on the airfoil surface. The vortex is consequently shed into the wake with a velocity being a combination of the incoming wind speed and the induced velocity. This free-wake vortex model is used to model different configurations. The wake of both a single- and double-rotor configurations can be calculated and as an example Figure 2 is presented.

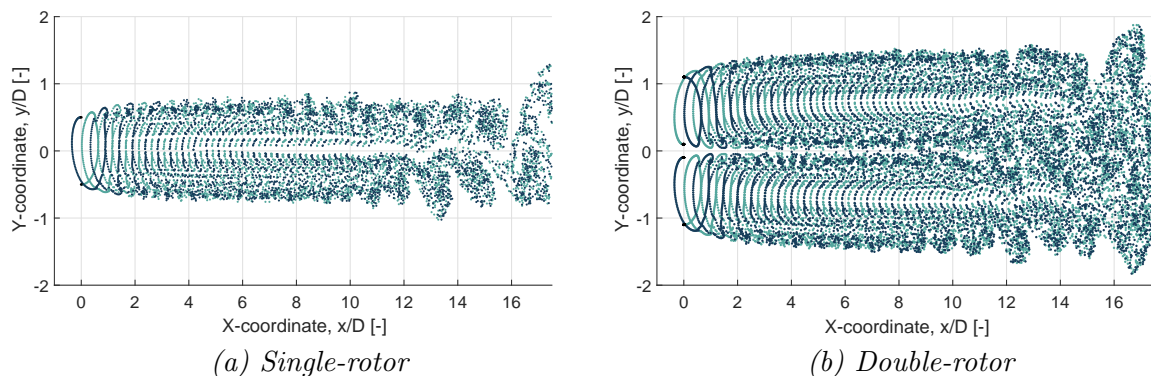

Figure 2: Top-view of wake calculated using U2DiVA for a two-bladed VAWT with NACA0015 airfoils with tip speed ratio 2.5 and solidity 0.1 ($V_\infty = 1\text{m/s}$, $c = 1\text{m}$, $R = 10\text{m}$, $d_{int} = 0.2$)

From a convergence study of the power coefficient with the number of revolutions, it is concluded that 50 revolutions should suffice for medium loaded cases (i.e. $C_T < 0.9$). In this case, the simulations have achieved the steady state within 0.5% in case of the single-rotor and below 1% for the double-rotor configuration. For heavily loaded cases, U2DiVA converges slowly or might even encounter convergence issues. This causes that the results for $C_T > 0.9$ are less reliable and need to be interpreted with care. Though, balancing the simulation time and the accuracy, 50 revolutions should be enough for the purpose of this paper. An extensive validation and comparison of this model with other aerodynamic models is provided in [9].

2.2. Double-rotor layout

For the double-rotor VAWT three different layouts can be set up: (i) co-rotating, (ii) counter-up and (iii) counter-down. The term *counter-* and *co-rotating* refer to the rotational direction of both rotors with respect to each other. The terms *up* and *down* refer to the positive direction of the rotational velocity of the rotors with respect to the incoming wind velocity. A schematic representation of the three layouts is provided in Figure 3. In this paper a distinction will be made between four parts of a rotor in double-rotor configuration: inner-upwind, outer-upwind, inner-downwind and outer-downwind. For the counter-rotating turbine, the azimuthal angle is defined starting at the beginning of the upwind part. Except stated differently, the results will always correspond to the counter-clockwise rotating turbine; i.e. top turbine in the counter-down and co-rotating configuration and the bottom turbine in the counter-up configuration. All length dimensions are normalised with the rotor diameter.

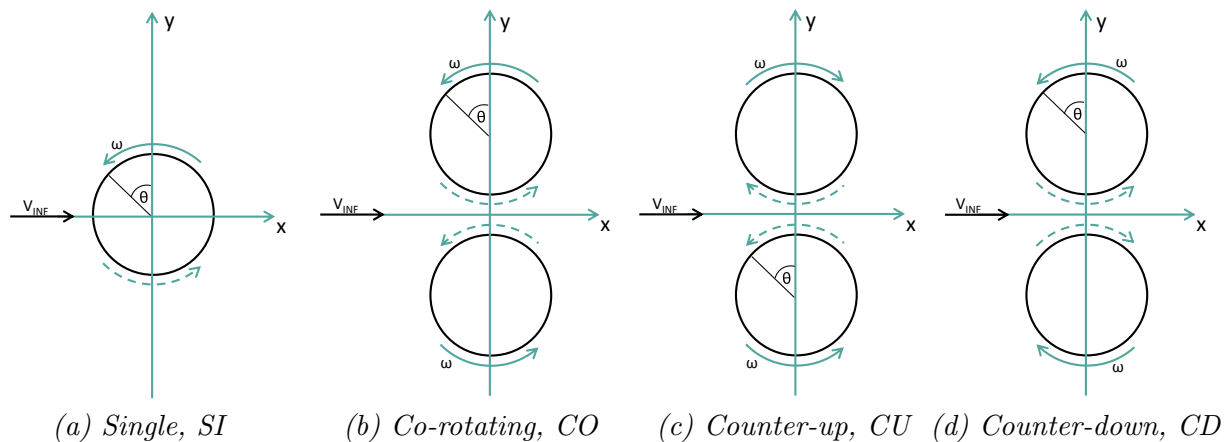

Figure 3: Schematic representation of the single- and double-rotor VAWT layouts.

3. Physical interpretation of double-rotor concept

To understand and reveal the physical mechanism behind the double-rotor VAWT, one representative example will be discussed in detail. This case consists of a 2-bladed rotor with a solidity of 0.1 and tip speed ratio of 2.5. The incoming velocity is set to 1m/s. The blades have a NACA0015 profile and a chord length of 1m. This particular rotor will be studied in the various double-rotor lay-outs with a fixed rotor spacing of 0.2 and compared to the isolated single-rotor. All results presented in this section are calculated using the 2D U2DiVA code.

In Figure 4a-h, the velocity field and streamlines around the rotor(s) are visualised. The velocities are normalised with the free stream wind speed V_∞ . The flow field reveals that because of the presence of the neighbouring turbine, the wake expansion is restricted. The inner flow is narrowed while the outer part of the flow develops normally compared to the single-rotor. The wake development of all double-rotor configurations are rather similar. Compared to the single-rotor configuration, the flow in between the two rotors in double-rotor configuration is accelerated. In the counter-down layout, the flow acceleration is more explicit than in the counter-up and co-rotating layout. In Figure 5a-d, the x- and y-component of the perceived velocity, angle of attack and local power coefficient at different azimuthal positions are presented. The results are presented for the counter-up (CU), counter-down (CD) and single-rotor (SI) configuration. The results for the co-rotating case are intentionally left out since they comply well with the observations done for the counter-up and counter-down configuration. This will be discussed in order to understand the flow phenomena behind the double-rotor concept.

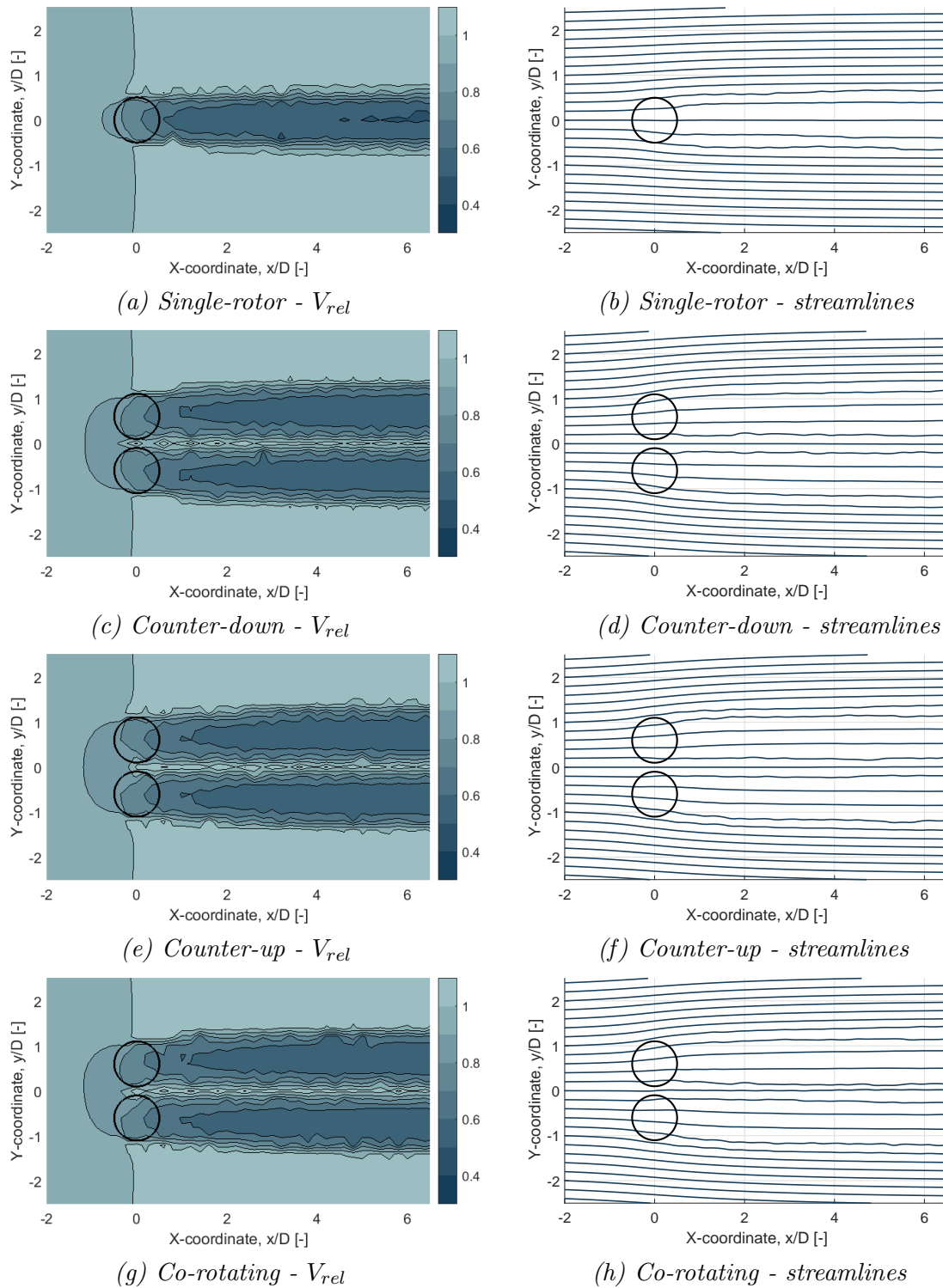

Figure 4: Velocity field around a two-bladed single-rotor (SI), counter-down (CD), counter-up (CU) and co-rotating (CO) configuration. Relative velocity is normalised with the incoming velocity V_∞ . ($d_{int} = 0.2$, $\lambda = 2.5$, $\sigma = 0.1$)

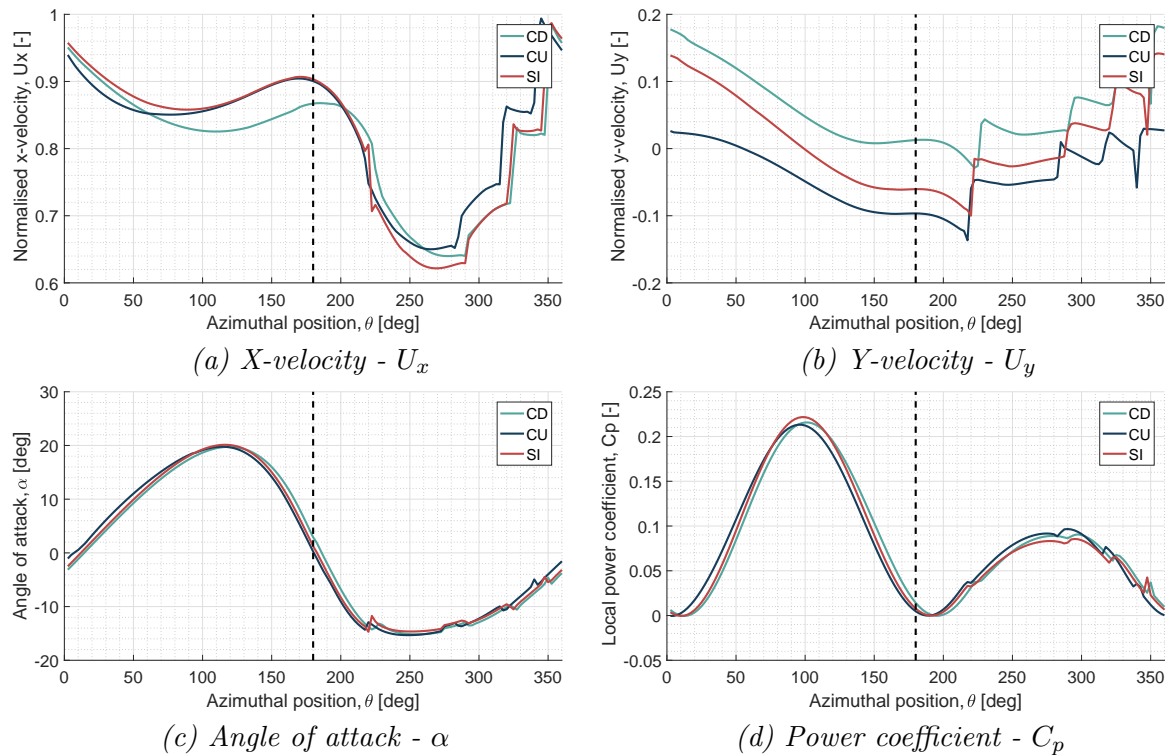

Figure 5: Local velocity, angle of attack and power coefficient at two-bladed rotor for single-rotor (SI), counter-up (CU) and counter-down (CD) configuration. Velocities are normalised with the incoming velocity V_∞ . ($d_{int} = 0.2$, $\lambda = 2.5$, $\sigma = 0.1$)

Upwind part

It can be understood that the induced velocity field created by the first rotor's is added to the induced velocity of the second rotor. For the inner-upwind part of the rotor, the presence of the neighbouring rotor causes the y-velocity to reduce significantly as well as the x-velocity but to a lower extent. This change in the velocity field affects the inflow conditions (i.e. angle of attack) favourably. It will cause the loading on the inner-upwind part of the rotor to raise and the mass flow to decrease. At the outer-upwind part, the effect of the second rotor is less pronounced due to the longer distance to that rotor and thus the weaker induction. The induced velocity of the second rotor will cause the y-component of the velocity to increase slightly but will hardly effect the x-component. This will result in a less favourable angle of attack in the outer-upwind part. Considering the complete upwind part one might recognise that the angle of attack range is rather similar for the double-rotor as for the single-rotor, however, it seems to be shifted in the azimuthal position. The positive influence of inner-upwind and negative effect of the outer-upwind part are mostly cancelling out resulting in a fairly constant total power generated by the upwind part.

Downwind part

In the inner-downwind part, the y-component of induced velocity is almost completely reduced to zero. For the outer-downwind part, the y-component increases for similar reasons as explained earlier. The biggest difference on the downwind part between the double-rotor and single-rotor can be recognised in the x-velocity. The induced velocity created by the second rotor on the downwind part of the first rotor is in the positive x-direction and will partially cancel out the induced velocity in negative x-direction created by the first rotor. This increases the mass flow through the downwind part of the rotor and from the streamlines it can be revealed that this

causes the wake to contract compared to the single-rotor configuration. The new velocity field causes the angle of attack to increase slightly. In the outer-downwind part, this effect is less pronounced due to the larger distance between the two rotors and thus the second rotor affect the first one minor. The inner-downwind part is generating significantly more power compared to the same part of a single-rotor and is as such also revealed as the most contributing part to the success of the double-rotor concept.

4. Parametric study

4.1. Effect of tip speed ratio and solidity

Not only the performance of VAWTs is depending on the tip speed ratio and solidity, but also the effectiveness of the double-rotor concept is influenced by it. From Figure 7a-h, where the power and thrust coefficient are presented for the single and double-rotor configurations, it can be understood that the double-rotor configurations show enhanced performance compared to the isolated turbine. This is true for all combinations of tip speed ratio and solidity. In terms of power, the counter-up configuration is in general the most effective, followed by the co-rotating and counter-down configuration.

Additionally, the effectiveness of the double-rotor concept is more significant for heavily loaded rotors, corresponding to larger tip speed ratios and solidities. To substantiate this, Figure 6a is provided in which the power coefficient of the double-rotor normalised with the single-rotor (similar tip speed ratio and solidity) is plotted versus the thrust coefficient of the single-rotor VAWT. This plot reveals that the power can be enhanced up to 10% relative to the single-rotor. Furthermore, note from Figure 6b that for a specific increase in power, the thrust is increased with a smaller extend.

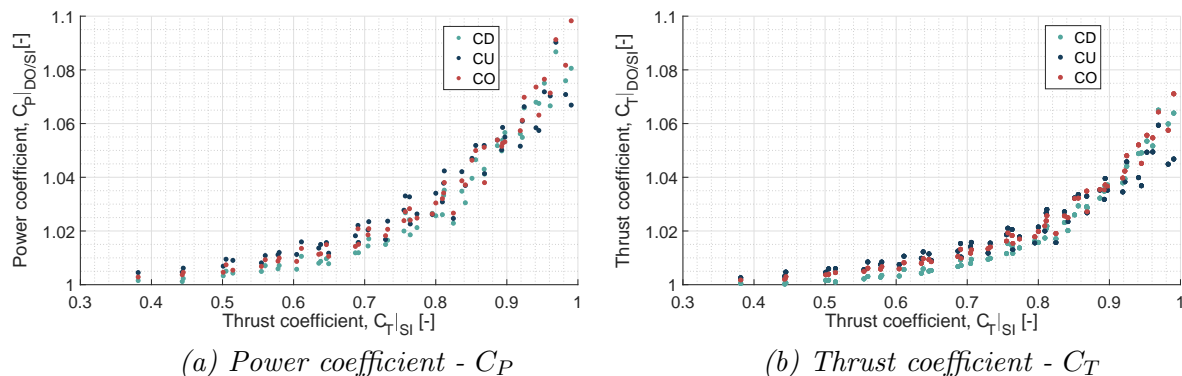

Figure 6: Power and thrust coefficient for counter-up, counter-down and co-rotating configuration ($d_{int} = 0.2$) normalised with single-rotor versus the rotor thrust of a single-rotor.

As noticed, heavily loaded rotors are experiencing more power gain in double-rotor configurations. For these load cases the induced velocity field is much stronger, leading to more pronounced mutually induced velocities between the rotors. Practically, one could say that having a second rotor in close proximity will cause the wake expansion to be restricted much more pronounced for heavily loaded rotors. The streamlines will be more deflected inwards and as a result a larger mass flow will go through the downstream part of the heavily loaded rotor. As such, heavily loaded cases are experiencing the double-rotor effect more extreme and the gain in power that can be reached for the double-rotor with respect to the single-rotor configuration will be larger.

4.2. Effect of rotor spacing

The double-rotor configuration is significantly depending on the rotor spacing in between the two rotors. It is expected that when moving the turbines away from each other, the performance

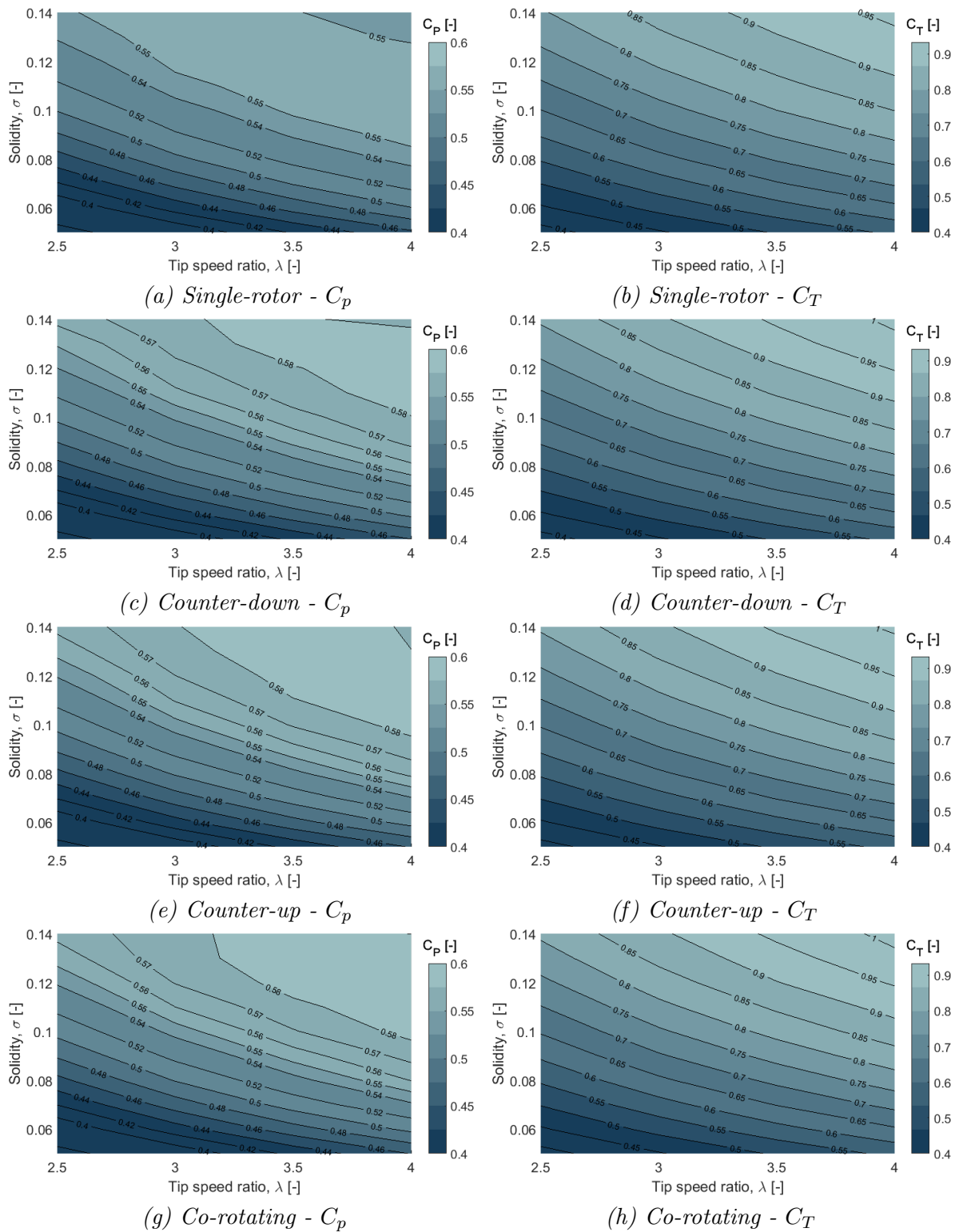

Figure 7: Power and thrust coefficient for various tip speed ratios and solidities of a two-bladed single-rotor (SI), counter-down (CD), counter-up (CU) and co-rotating (CO) configuration ($d_{int} = 0.2$).

should gradually converge to the performance of the isolated single-rotor. This is proven by Figure 8, in which the power coefficient of the double-rotor configurations normalised with the single-rotor is presented as a function of the rotor spacing. Two different rotor loadings are presented, one corresponding to a tip speed ratio of 2.5 and solidity of 0.1 and another one with tip speed ratio of 3.5 and the same solidity.

Several remarks can be made from these figures. First of all notice that for both counter-rotating configurations (counter-up and counter-down), the highest coefficients of power have been obtained in case the two rotors are in the closest arrangement. For the co-rotating configuration, this is not true. The optimal rotor spacing lies around 0.04 and 0.1. Also, one can observe that for large rotor spacings above 1 diameter, there is almost no difference between the various double-rotor configurations. Only when the rotors move closer together, the difference becomes significant and the counter-up configuration out-performance the others. Finally, the non-smoothness of the curves should be interpreted carefully since the accuracy of the numerical simulations is limited.

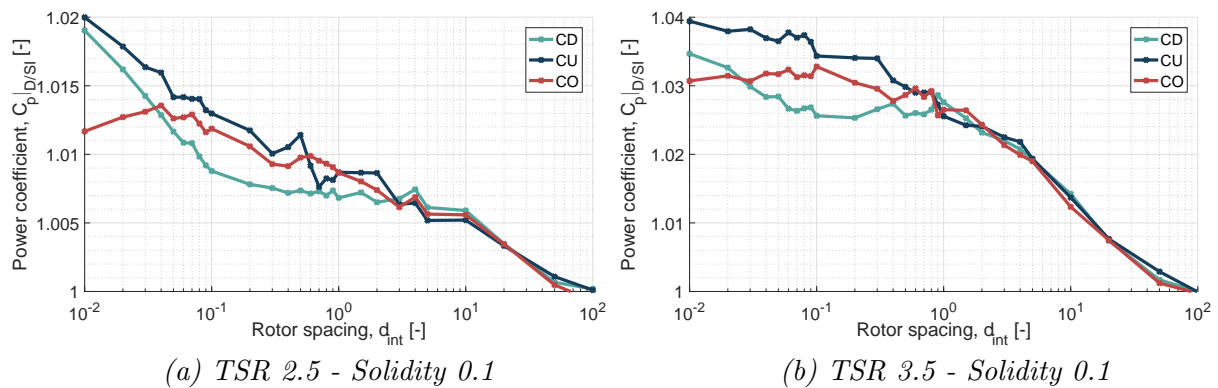

Figure 8: Power coefficient with respect to rotor spacing for counter-up, counter-down and co-rotating configuration. Power normalised with single-rotor. ($\lambda = 2.5$ or 3.5 , $\sigma = 0.1$)

Explaining why smaller rotor spacings are in general beneficial in terms of power production can be explained easily by considering the induced velocity of the neighbouring turbine. The closer the second turbine is to the first one, the stronger the induced velocity field of rotor one on rotor two will be. Moving the rotors closer to each other causes the y-velocity in between the rotors to vanish even further. The streamlines are deflected more inwards and consequently the mass flow through the downwind side of the rotor will increase more.

4.3. Effect of wind direction

It has already been stated by e.g. Dabiri [1] and Zanforlin [5] that vertical-axis wind turbines in double-rotor configuration are very sensitive to the wind direction. In this parametric study, a similar observation is done. Consider Figure 9. In this figure, the power coefficient of the north rotor, south rotor and the average of both rotors (normalised with the power coefficient of the single isolated rotor) is plotted with respect to the wind direction in a polar plot. The results are presented for the counter-rotating configuration (note that it represents both counter-up and counter-down due to symmetry) with a solidity of 0.1, tip speed ratio of 2.5 and rotor spacing of 0.2. The results of the co-rotating case are intentionally left out since very similar trends can be observed. A yaw angle of 0° corresponds to the case where the incoming velocity is perpendicular to the double-rotor configuration. From Figure 9 it can be concluded that for 0° yaw angle, both rotors are performing equally and better than the isolated single-rotor. If the wind direction changes, the performance of both rotors falls out of balance and one will perform better than the other. Up till a certain deflection angle, the back-rotor performs better than the

rotor in front. Beyond this yaw angle the trend becomes opposite. If the wind is aligned with the rotors, one rotor is completely in the wake of the other and a significant portion of power is lost compared to the single-rotor case.

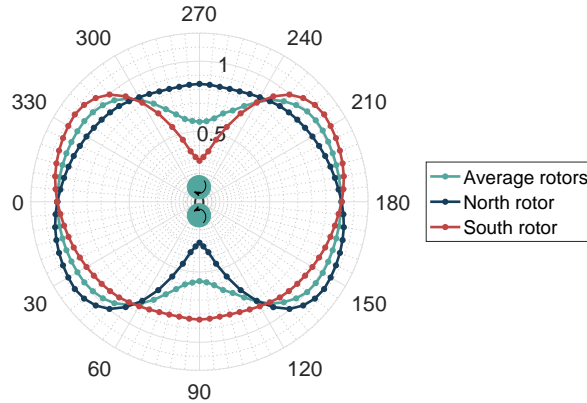

Figure 9: Effect of wind direction on power coefficient for counter-rotating configuration. Power coefficients are normalised with single-rotor. ($d_{int} = 0.2$, $\lambda = 2.5$, $\sigma = 0.1$)

To better understand the physics behind the double-rotor configuration in yaw, the velocity field corresponding to two yaw angles is presented in Figure 10. In case of 30° yaw, the back-rotor is generating more power than the front-rotor. This is because the induced velocity generated by the front-rotor on the back-rotor will be in the positive x-direction and thus increase the mass flow through the rotor. For the 60° yaw case, the back-rotor enters the wake of the front-rotor. The velocity in this region is significantly decreased making the turbine to under-perform. The front-rotor will encounter an additional induced velocity in the negative x-direction reducing its mass flow and its performance. The back-rotor loses more than 60% of its performance and the front-rotor about 15%.

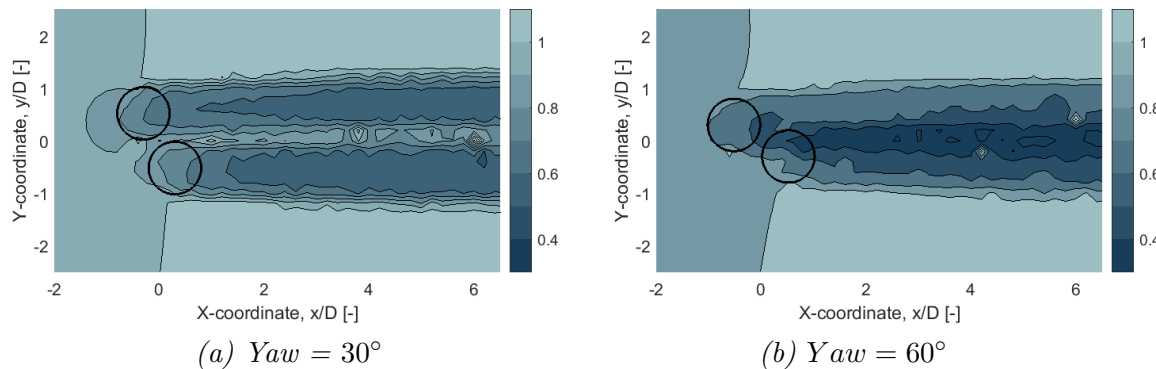

Figure 10: Velocity field around a two-bladed counter-down configuration with various yaw angles. Velocity normalised with the incoming velocity V_∞ . ($d_{int} = 0.2$, $\lambda = 2.5$, $\sigma = 0.1$)

From Figure 11a, it can be derived that for heavily loaded cases, the sensitivity to wind direction is larger. For the cases with small yaw angles, the achievable gain using the double-rotor concept increases with rotor loading. However, the heavily loaded case also suffers more in 90° yaw since the wake is much stronger. As an indication: for the rotor with solidity of 0.14, up to 50% of the average power can get lost. For the lower solidity cases, this is only 30%. The range of yaw angles for which the double-rotor concept remains profitable depends significantly on the rotor spacing. This is presented in Figure 11b. The wind window for which the back-rotor remains out of the wake of the front-rotor is proportional to the rotor spacing. However, the power gain at zero yaw is inversely proportional to the rotor spacing.

5. Conclusion

In this work, we have worked towards the understanding of vertical-axis wind turbines in double-rotor configurations. We have created insight in the physics behind the double-rotor

configuration and performed a parametric study to identify the effect of the rotor loading, rotor spacing and wind direction on the flow field and performance. The simulations are performed using a two-dimensional panel/vortex model and deal with three double-rotor layouts: (i) counter-up, (ii) counter-down and (iii) co-rotating.

The velocity field around the double-rotor reveals that due to the presence of the neighbouring turbine, the flow in between the rotors is accelerated and the wake is restricted to expand. The deflection of the streamlines mainly affects the mass flow through the inner-downwind part of the rotor and it is identified that this part is the most contributing to the success of the double-rotor concept. This phenomena has been clarified using the induced velocity fields of a single- and double-rotor. From the parametric study it is concluded that heavily loaded rotors are experiencing more power gain from the double-rotor configuration. The counter-up configuration seems to be the best performing configuration. The highest power performance can, in general, be obtained in case the two rotors are in the closest arrangement. Finally the wind direction sensitivity of the double-rotor configuration is proven.

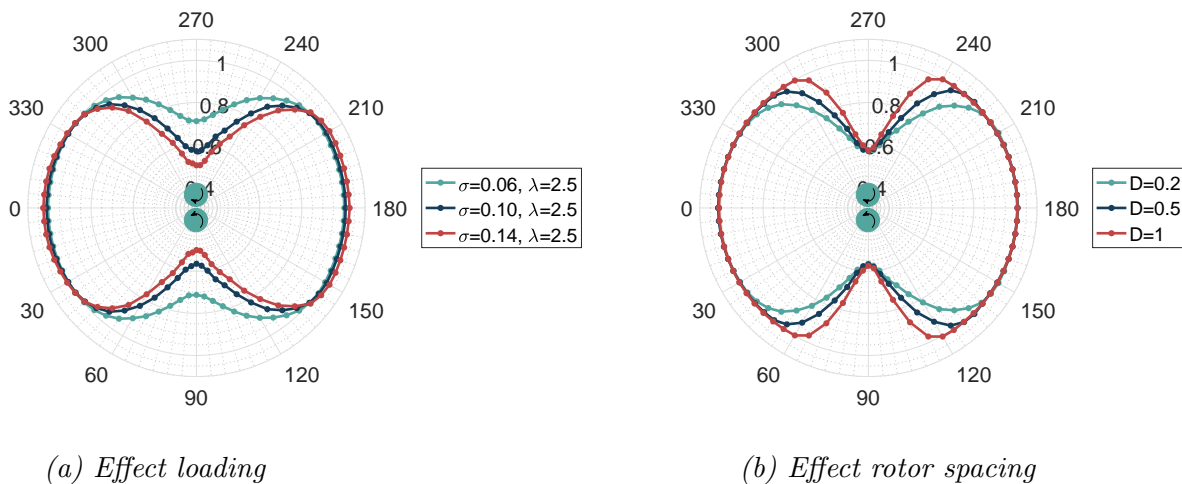

Figure 11: Effect of wind direction on average power coefficient for counter-rotating configuration. Power normalised with single-rotor. (Baseline: $d_{int} = 0.2$, $\lambda = 2.5$, $\sigma = 0.1$)

Acknowledgements

This research has been sponsored by the company Nenuphar Wind - Offshore wind turbines.

References

- [1] Dabiri J.O. Potential order-of-magnitude enhancement of wind farm power density via counter-rotating vertical-axis wind turbine arrays. July 2011. *Journal of Renewable and Sustainable Energy* **3** 043104
- [2] Ning A. Actuator cylinder theory for multiple vertical axis wind turbines. December 2016. *Wind Energy Science* **1** 327-340
- [3] Araya D.B., Craig A.E., Kinzel M. and Dabiri J.O. Low-order modeling of wind farm aerodynamics using leaky Rankine bodies. December 2014. *Journal of Renewable and Sustainable Energy* **6** 063118
- [4] Feng G. Optimizing the land use for wind Farms using vertical axis wind turbines. 2014. *Europe's first wind energy conference and exhibition, European Wind Energy Association (EWEA)*
- [5] Zanforlin S. and Nishino T. Fluid dynamic mechanisms of enhanced power generation by closely spaced vertical axis wind turbines. August 2016. *Renewable Energy* **99** 1213-1226
- [6] Van Kemenande G., De Troyer T., Immas A., Kluczevska-Bordier J., Deglaire P. and Runacres M. Wind tunnel testing of a pair of VAWTs for offshore applications. September 2016 *Euromech Colloquium 583*
- [7] Parneix N., Fuchs R., Immas A. and Silvert F. Efficiency improvement of vertical-axis wind turbines with counter-rotating lay-out. 2016. *Report Nenuphar*
- [8] Ferreira C.S. The near wake of the VAWT. October 2009. The near wake of the VAWT. *Phd thesis Delft University of Technology*
- [9] Ferreira C.S., Madsen H.A., Barone M., Roscher B., Deglaire P. and Arduin I. Comparison of aerodynamic models for Vertical Axis Wind Turbines. 2014. *Journal of Physics: Conference Series* **524** 012125