

Integration of hydraulic wind turbines for seawater reverse osmosis desalination

Jarquín-Laguna, Antonio; Greco, Francesca

DOI

[10.1109/OSES.2019.8867343](https://doi.org/10.1109/OSES.2019.8867343)

Publication date

2019

Document Version

Accepted author manuscript

Published in

Proceedings Offshore Energy and Storage Summit (OSES 2019)

Citation (APA)

Jarquín-Laguna, A., & Greco, F. (2019). Integration of hydraulic wind turbines for seawater reverse osmosis desalination. In *Proceedings Offshore Energy and Storage Summit (OSES 2019)* IEEE.
<https://doi.org/10.1109/OSES.2019.8867343>

Important note

To cite this publication, please use the final published version (if applicable).
Please check the document version above.

Copyright

Other than for strictly personal use, it is not permitted to download, forward or distribute the text or part of it, without the consent of the author(s) and/or copyright holder(s), unless the work is under an open content license such as Creative Commons.

Takedown policy

Please contact us and provide details if you believe this document breaches copyrights.
We will remove access to the work immediately and investigate your claim.

Integration of Hydraulic Wind Turbines for Seawater Reverse Osmosis Desalination

Antonio Jarquin-Laguna

*dept. Maritime and Transport Technology
sect. Offshore and Dredging Engineering
Delft University of Technology
Delft, the Netherlands
A.JarquinLaguna@tudelft.nl*

Francesca Greco

*dept. Hydraulic Engineering
sect. Offshore Engineering
Delft University of Technology
Delft, The Netherlands
F.Greco@tudelft.nl*

Abstract—The integration of renewable energy sources to power seawater desalination is crucial to mitigate CO₂ emissions and to face the increasing challenges that are stressing fresh water resources depletion. In particular wind energy is one of the most cost-effective forms of renewable energy with a high potential to reduce the seawater desalination's environmental impact. While most applications are aimed at using conventional wind technologies to produce the electricity required by the desalination processes, wind turbines with hydraulic transmission can bring new opportunities to avoid the multiple energy conversion steps and make fresh water production from wind energy more simple and cost-effective. This paper elaborates on two potential configurations, numerical modelling and possible control strategies which are able to directly combine a horizontal axis wind turbine rotor, a hydraulic transmission and a seawater reverse osmosis (SWRO) desalination unit. The integration of an ideal pressure exchanger as energy recovery devices (ERD) to increase the operating efficiency of the SWRO unit is analysed. Results are shown for the most relevant operating conditions of the integrated system in terms of wind speeds, pressures, brine salinity and fresh water productions. Intermediate results are also shown for the dynamic analysis and simulation of the wind powered direct-driven SWRO system subject to turbulent wind speed conditions.

Index Terms—Wind energy, seawater desalination, reverse osmosis, hydraulic drives.

I. INTRODUCTION

A. The water problem

Water scarcity is already a global issue affecting at least one fifth of the world's population [1]. The depletion and contamination of fresh water sources, touching different sectors like agriculture, tourism and industry, threatens not only the economic development and people's health, but also contributes to other problems like political instability, conflicts and migrations [2]. Remote locations and small islands are particularly affected by water resources issues. With half of the world's population living within 100 km from an ocean and considering that 97% of the water is saline, seawater desalination promotes itself as an alternative and interesting source for fresh water production. Conventionally, remote places and island communities use fossil fuels to provide the energy required to operate the different desalination technologies, however these fuels are vulnerable to volatile global market prices and to logistical supply problems, in addition to the

high associated expenses to the environmental impact and CO₂ emissions. Every day, 90 billion liters of water are desalinated all over the world contributing with 76 million of tonnes of CO₂ released per year. The required high energy consumption from conventional technologies is a critical factor that affects the economics of seawater desalination [3].

B. Wind driven desalination

Wind energy is one of the most cost-effective forms of renewable energy with a high potential to reduce the seawater desalination's environmental impact by 75% [4]. In addition, wind energy uses virtually no water to operate during its life cycle. Most applications of wind energy in combination with seawater reverse osmosis desalination (SWRO) are aimed at using conventional wind technologies to produce the electricity required by seawater desalination processes [5]. First, wind turbines convert the kinetic energy from the wind flow into mechanical and then electrical energy. Only then, the electricity taken from the grid is converted back to mechanical energy required by the pumps to power the SWRO process using between 4 and 6 kWh per cubic meter of fresh water produced. It is clearly seen that the current solution involves multiple energy conversion steps using the grid as an energy buffer to account for the wind power fluctuations. In this paper, a new approach is presented where hydraulic wind turbines are dedicated to produce fresh water in a more direct manner without any electrical intermediate conversion and potentially avoiding the need of the electrical grid as shown in the schematic of Fig. 1. By avoiding the intermediate electrical conversion steps, it is expected that the hydraulic wind turbine will produce fresh water from wind energy between 10 and 20% more efficient when compared to a conventional wind turbine used for grid connected seawater desalination.

C. Opportunities and challenges

The development of integrated wind turbines with SWRO technology offers the following opportunities to make fresh water production from wind energy more cost effective:

- Improved efficiency: avoiding multiple energy conversion steps will allow to the proposed technology to reduce the energy required to produce a cubic meter of fresh water.

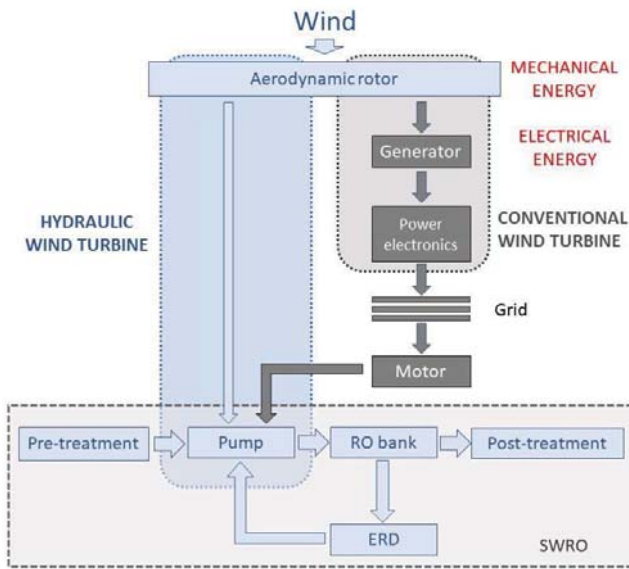
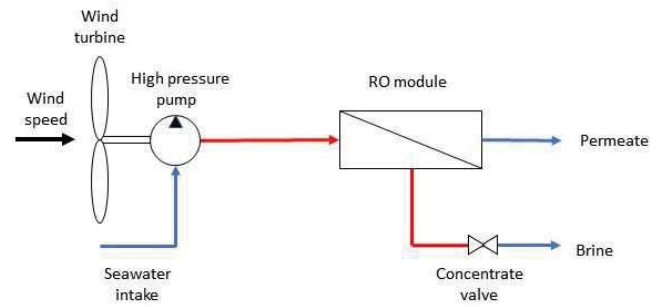

Fig. 1. Comparison between conventional and proposed wind powered SWRO system.

- Cost reduction on operation and maintenance: eliminating the electrical components simplifies the maintenance and repair work by having less components. In addition, simplifying the energy conversion at the nacelle will allow to reduce the top mass weight.
- Elimination of CO₂ emissions: seawater desalination from wind energy will contribute to the energy transition by saving between 1.4 and 1.8 kg of CO₂ for every cubic meter of fresh water produced [6].
- Increased accessibility of SWRO to remote locations: coastal or offshore locations will be able to use their wind resource to produce fresh water regardless of their access to the electrical grid.
- Water storage: the desalinated water can be stored cost effectively compared to storage of electrical energy produced from the wind turbines.

From a system point of view, integrating effectively wind turbine and SWRO technologies requires fundamental understanding of the underlying interaction mechanisms between the components involved in the chain of conversion processes. It is clear that the feedback effects between the wind turbine rotor, the control system and desalination processes need to be considered for a proper evaluation and optimisation. Wind turbines are highly dynamic systems which are subject to the stochastic nature of wind. In contrast, SWRO technologies are units which are typically operated under relatively constant and stationary conditions. The application of wind powered SWRO desalination follows previous work where the integration of wind turbine technology in combination with hydraulic systems for power conversion has been studied for hydraulic offshore wind turbines [7]–[9].

This paper elaborates on the modelling, simulation and comparison of two potential configurations of SWRO with



(a) Wind driven SWRO with variable valve.

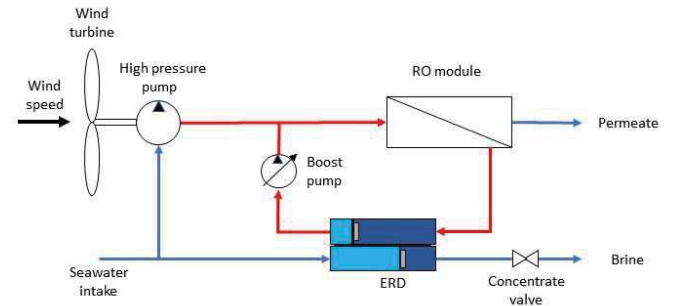

(b) Wind driven SWRO with pressure exchanger ERD.

Fig. 2. Schematic of two potential configurations for wind powered direct driven-driven SWRO system.

direct wind energy conversion as shown in Fig. 2. In order to keep the wind speed rotor within its optimal operating region, two control strategies are proposed to enable a variable speed operation using the hydraulic components for below rated wind speed conditions using the system pressure. The results are shown for a theoretical 500 kW turbine using an isobaric energy recovery device (ERD) to increase the operating efficiency of the SWRO unit.

II. PROPOSED DIRECT-DRIVEN WIND TURBINE SWRO DESALINATION SYSTEM

A. Wind driven SWRO with variable valve

The simplest configuration consists of a wind turbine rotor coupled to a positive displacement water pump and SWRO desalination module as shown in Fig. 2a. According to the wind speed and rotational speed of the rotor, the seawater flow is pumped into the reverse osmosis desalination module, where a membrane separates fresh water from salts and ions. Once the osmotic pressure is reached, the fresh water is permeated across the membrane and collected at atmospheric pressure. The salts and ions retained by the membrane are disposed into a high concentration stream which flows along the module, i.e. brine. A concentrate valve located in the concentrate stream allows to regulate the back pressure of the system. This ability to manipulate the pressure in the water pump discharge will directly influence the pump torque which in turn, may be used for closed loop control of the rotor speed in below rated operating conditions. This configuration has been proposed

for tidal energy desalination in [10], and the control strategy has been analysed and implemented in wind turbines that incorporate a hydraulic-drive train and Pelton turbine [9].

B. Wind driven SWRO with isobaric energy recovery device

The integration of a pressure exchanger ERD is proposed in this configuration as shown in Fig. 2b. Part of the feed seawater is sent at atmospheric pressure to the hydraulic wind turbine while the rest is sent to the pressure exchanger ERD. The purpose of this device is to extract the remaining pressure content of the discharged brine and transfer it to the feed flow to improve the SWRO operating efficiency [11], [12]. An auxiliary boost pump is used to regulate the concentrate flow and to compensate for any pressure losses in the ERD. The main feature of this concept, is that all the feed flow from the rotor-pump is converted into permeate while the boost pump is used to regulate the concentrate stream and ERD flow rates. In a similar manner as the previous concept, the boost pump of the ERD can be employed to modify the system pressure, thus it can be used to control the pump torque and consequently the rotor speed.

The pressure exchanger ERD is made of a high-pressure housing containing a ceramic rotor perforated by many ducts. Surrounding the rotor there are a sleeve and two end covers. During its operation, as shown in Fig. 3 the rotor is first filled by the low pressure seawater (a). While rotating, the rotor exposes briefly the low pressure seawater flow to the high pressure concentrate (b), allowing the transfer of energy from the latter via direct contact. The pressurized seawater is then pushed out of the pressure exchanger (c) joining the stream of the high pressure pump. The concentrate is pushed out at a lower pressure by the feed seawater (d). The rotor ducts function as a cartridge charging and discharging as the pressure transfer process repeats itself. In this way, energy is captured that would be otherwise wasted, reducing the system power consumption per produced volume of permeate up to 60% compared with a system without ERD [13].

III. SIMPLIFIED MATHEMATICAL MODELS

A. Wind turbine rotor

The simplified aerodynamic characteristics of a horizontal axis wind turbine rotor can be described as a function of its geometrical characteristics and through its non-dimensional steady-state performance coefficients. The aerodynamic torque and power can be expressed with the following equations as a function of the upstream wind speed U_w , the air density ρ_{air} and the rotor radius R .

$$\tau_{aero} = C_\tau(\lambda, \beta) \frac{1}{2} \rho_{air} \pi R^3 U_w^2 \quad (1)$$

$$P_{aero} = C_P(\lambda, \beta) \frac{1}{2} \rho_{air} \pi R^2 U_w^3 \quad (2)$$

The torque and power coefficients, C_τ and C_P , are defined as function of the collective pitch angle of the blades β and the tip speed ratio λ which is the ratio of the rotor tip tangential

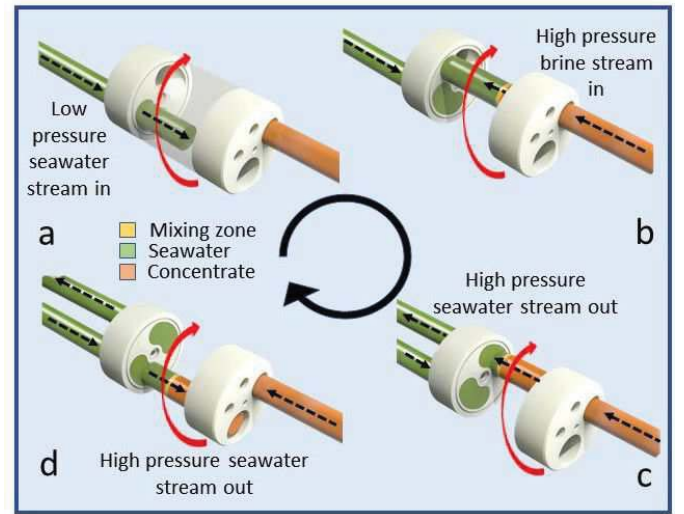

Fig. 3. Principle of operation of the pressure exchanger as energy recovery device.

speed to the upstream wind speed, with the rotational speed of the rotor ω_r ,

$$\lambda = \frac{\omega_r R}{U_w} \quad (3)$$

Although this model do not consider any aero-elastic or unsteady aerodynamic effects, the aerodynamic loading is assumed to give sufficient detail on the the wind turbine rotor behaviour for the purposes of this work.

B. Hydraulic drive train

The wind turbine rotor is directly connected to a large positive displacement water pump through the low-speed rotor shaft. Assuming a stiff connection, the angular acceleration of the rotor-pump assembly can be described through the imbalance of the aerodynamic torque and the opposing torque from the water pump. The mass moments of inertia of the rotor and water pump are given by J_r and J_p respectively

$$(J_r + J_p) \dot{\omega}_r - \tau_{aero}(U, \beta, \omega_r) + \tau_p(\omega_r, \Delta p_p) = 0 \quad (4)$$

The water pump has a constant volumetric displacement V_p which determines the volume of fluid that is obtained for each rotor revolution based on the positive displacement principle. The volumetric flow rate of the pump Q_p , and the transmitted torque τ_p are based on quasi-steady relations as a function of the pressure difference across the pump Δp and of the rotational speed of the rotor-pump assembly. The internal leakage losses are described with the laminar leakage coefficient C_s and included as a linear function of the pressure across the pump. Similarly, the pump torque includes a viscous friction component with the damping coefficient B_p and a dry component described with the coefficient C_{fp} [14].

$$Q_p = V_p \omega_r - C_s \Delta p \quad (5)$$

$$\tau_p = V_p \Delta p + B_p \omega_r + C_{fp} V_p \Delta p \quad (6)$$

C. RO membranes

The transport mechanism of the reverse osmosis desalination process is based the solution-diffusion model to represent the transport of water across the dense RO membrane and the retention of salts and ions [15]. According to this model, the permeants are absorbed by the membrane surface, then diffused across its thickness and lastly they are released at the other side of the membrane. The flow rate of each component per unit area that passes across the membrane is given by the water flux according to the following equation:

$$J_w = K_w(\Delta p - \Delta\pi) \quad (7)$$

where K_w represents the water permeability constant, Δp_{RO} is the difference in pressure between the two sides of the membrane and $\Delta\pi$ is the osmotic pressure difference. The osmotic pressure difference depends on the effective concentration of total dissolved solids C_{eff} , considered at the feed side of the membrane surface [16]:

$$\Delta\pi = \delta C_{eff} T \quad (8)$$

$$\frac{C_{eff}}{C_f} = a + (1-a) \left[(1-R_m) + R_m \left(\frac{U_f}{U_c} \right) \right] \quad (9)$$

where the salt rejection R_m represents the ability of the membrane to retain the salts, T denotes the seawater temperature in K, a is the weighting coefficient, C_f represents the feed concentration at the RO membranes and U is the water velocity. The subscripts f, c and p stand for the feed, concentrate and permeate respectively. Considering the mass balance over the RO membrane, the following relation between flow rates is obtained:

$$U_f A_f - U_c A_c - U_p A_p = 0 \quad (10)$$

Another important parameter that characterizes the RO membranes is the recovery rate RR , which represents the ratio of membrane permeate or product water to the system feed water.

$$RR = \frac{Q_p}{Q_f} = \frac{U_p A_p}{U_f A_f} \quad (11)$$

D. Concentrate valve

The following non-linear model is used to describe the valve using the energy and mass balances as proposed by [16], where the friction losses factor e_v depends on the valve geometrical characteristics and is used to represent the valve resistance to the flow.

$$\rho V \frac{d}{dt} U_c = \Delta p A_c - \frac{1}{2} \rho_w e_v A_c U_c^2 \quad (12)$$

The valve settings can be manipulated through an actuator like a spear valve which is able to modify the friction losses factor e_v . The dynamics of such an actuator are approximated by a first order differential equation:

$$T_v \frac{d}{dt} e_v = e_{v,ref} - e_v \quad (13)$$

where the valve constant T_v , denotes the characteristic time of the valve to reach the reference value $e_{v,ref}$.

E. Isobaric ERD unit

The simplified model of the pressure exchanger is derived as well from the mass balance principle [17]. The overall mass flow rates of water and solute is expressed from the following ordinary differential equation:

$$\frac{dm_{b,out}}{dt} = F_{f,in} C_{f,in} + F_{b,in} C_{b,in} - F_{f,out} C_{f,out} \quad (14)$$

$$\text{with } F_{b,out} = F_{b,in} + OV \cdot F_{f,in} \quad (15)$$

where $m_{f,out}$ refers to the overall mass of the pressurized feed water at the outlet of the ERD. The overall mass flow rates of the influents for the feed and brine are described by $F_{f,in}$ and $F_{b,in}$ respectively, whereas $F_{b,out}$ represents that of the effluent for the brine. The overflush ratio OV denotes the water that must be bypassed or dumped during each cycle to maintain coordination between all the chambers in the pressure exchanger [13]. The overflush is determined by the difference between $F_{f,in}$ and $F_{f,out}$.

Similarly, the differential equation for the mass balance of the solute is expressed as:

$$\frac{dm_{b,out}}{dt} = F_{f,in} C_{f,in} + F_{b,in} C_{b,in} - F_{f,out} C_{f,out} \quad (16)$$

$$\text{with } C_{f,out} = M(C_{b,in} - C_{f,in}) + C_{f,in} \quad (17)$$

where $m_{b,out}$ is the solute mass of the depressurized brine, $C_{b,in}$ and $C_{f,in}$ indicate the concentrations of the influents for the high pressure brine and low pressure feed, respectively and $C_{f,out}$ represents the concentration of the effluent for the pressurized feed. The volumetric mixing ratio between the feed and brine streams caused by the hydraulic energy transfer in the ERD unit is given by M . Using this ratio, it is possible to estimate the increased salinity of the feed stream at the outlet of the ERD and at the entrance of the RO membranes for different recovery rates as shown in Fig. 4.

A auxiliary boost pump is integrated together with the ERD device to compensate any pressure losses and to regulate the recovery rate of the SWRO. It will be assumed that an ideal boost pump, either with variable speed or variable displacement, will be able to adjust the recovery rate according to a reference value RR_{ref} and a characteristic time constant T_{ERD} as described by the following first order differential equation:

$$T_{ERD} \frac{d}{dt} RR = RR_{ref} - RR \quad (18)$$

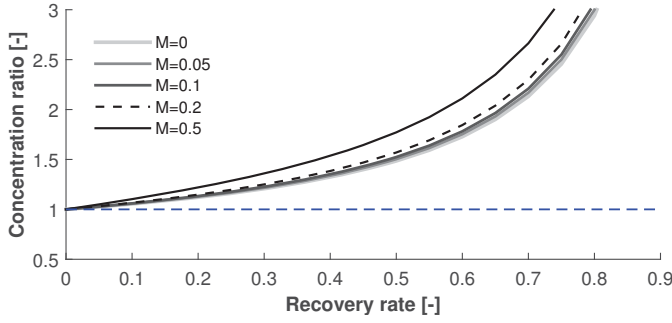

Fig. 4. Increased salinity at the RO membranes as a function of the recovery rate for different mixing ratios of the ERD.

IV. VARIABLE SPEED STRATEGY

For below rated wind speeds, the power capture of the wind turbine rotor is maximised by adjusting its rotational speed to match the optimal aerodynamic performance while keeping a fixed pitch angle. These conditions occur at a constant tip speed ratio where $C_{P,max}$ is achieved. A quadratic relation for the optimal aerodynamic torque as a function of the rotor speed is obtained by substituting (2) and (3) into (1) [18].

$$\tau_{aero} = \frac{1}{2} \frac{C_{P,max}}{(\lambda C_{P,max})^3} \rho \pi R^5 \omega_r^2 \quad (19)$$

For a constant displacement pump, the relation between the pump torque and the rotational speed depends directly on the pressure across the pump as presented in (6). The system pressure is given by both the osmotic pressure and the membrane characteristics as a function of the volumetric flow rates according to (7), (8), (9), and (11) resulting in the following relation:

$$\Delta p = \frac{\rho Q_p}{A_m N_m K_w} + \delta T C_{eff}(Q_p, Q_f) \quad (20)$$

For the configuration with a variable valve, the back pressure of the system is manipulated through the valve settings according to (12) and (13) with dependent permeate and brine flow rates. On the other hand, for the pressure exchanger ERD, the boost pump can be used to adjust the output flow of the ERD with (18) and influence the osmotic pressure which is the second term on the right hand side of (20). With the ERD unit, the permeate flow rate is given by the water pump flow rate as linear function of the rotational speed of the rotor-pump assembly. Both strategies are shown in the torque-speed graph of Fig. 5, where it is shown that for low rotor-speeds a minimum torque is required to overcome the osmotic pressures and only after 6.5 or 7.0m/s the rotor is able to operate with the desired variable speed relation for optimal aerodynamic efficiency. Other control strategies to manipulate the system pressure in hydraulic wind turbines have been presented in [9], [19].

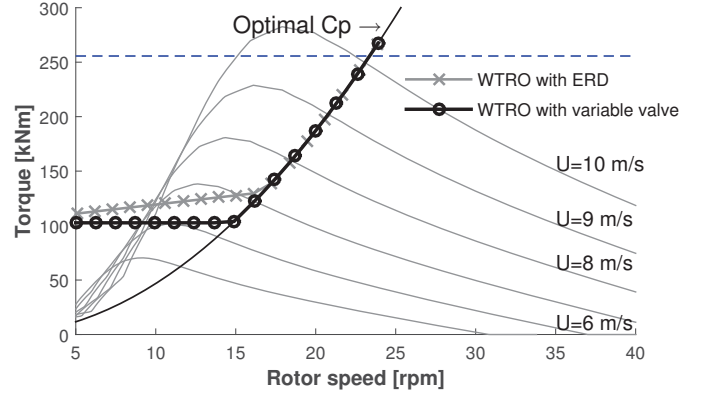

Fig. 5. Aerodynamic torque for different wind speeds and transmitted torque of the SWRO systems with and without ERD.

V. NUMERICAL RESULTS

A. Steady state-results

The operational conditions of the SWRO system with and without ERD pressure exchanger are obtained for different operating wind speeds, using as a reference a 500kW wind turbine rotor with a rotor radius of 30m. The pump sizing was done according to the operational limits of both the rotor and the SWRO module. The maximum rotational speed of the rotor is limited by the rotor tip velocity of 80m/s while a maximum operating pressure of 75 bars is imposed by the mechanical-resistance of the SWRO membranes. For the configuration with pressure exchanger ERD, it is assumed that the pressure transfer occurs ideally without any pressure loss and that the auxiliary boost pump is able to adapt to the required recovery rate. The rest of the selected design values are summarized in Table I. The cut-in wind speed is achieved when the rotor-pump assembly is able to achieve the minimum osmotic pressure between 6 and 6.5m/s, see Fig. 6, while a maximum system pressure of 72.5 bars is achieved for steady-state conditions at a resulting rated wind speed of 10.3m/s.

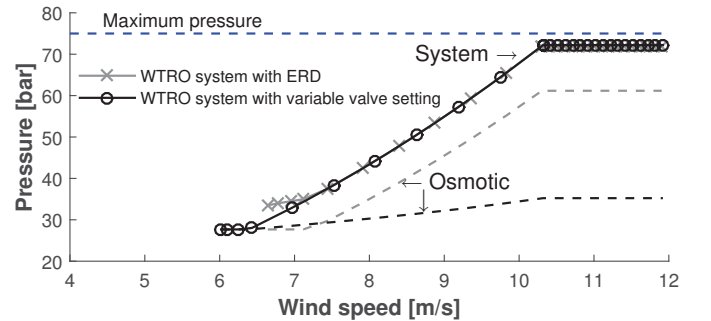

Fig. 6. Steady-state pressures.

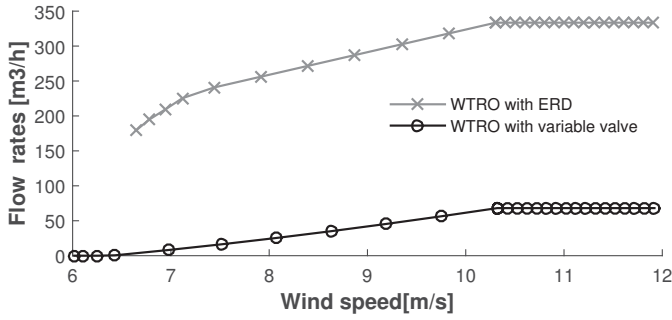

Fig. 7. Steady-state permeate flow rates.

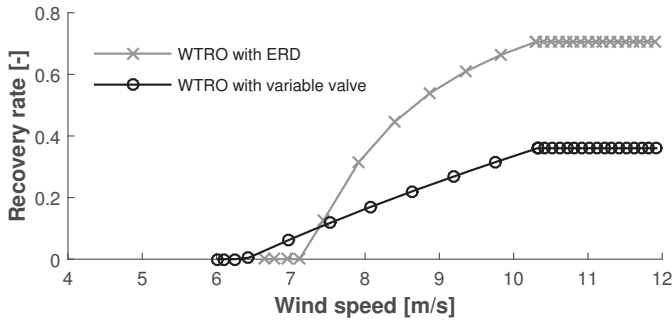

Fig. 8. Steady-state recovery rates of the SWRO system.

It is clearly seen in Figs. 7 and 8 that the configuration with the ideal pressure exchanger ERD allows for at least five times higher production of fresh water with respect to the variable valve configuration. However, the higher recovery rates required with the ERD system between 50-75% might be difficult to achieve in practice. These values are only possible with a very large auxiliary boost pump which might seem unfeasible. The recovery rates for the variable valve are below 40%, which are within the conventional operational envelope of existing SWRO systems.

B. Time-domain simulations

The system of coupled algebraic and differential equations presented in section III was used to develop the time-domain numerical model of the two configurations from Fig. 2 in the commercial software MATLAB/Simulink. The numerical

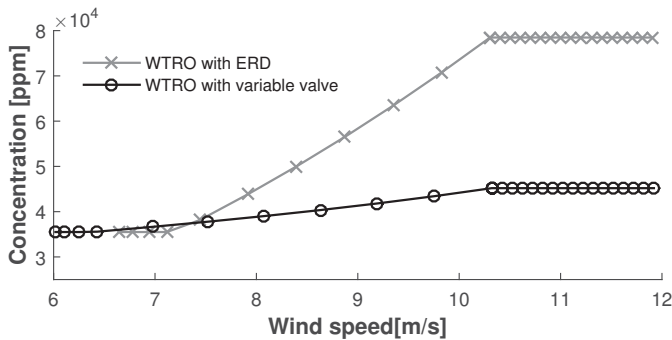

Fig. 9. Steady-state effective concentration of the SWRO system.

results were obtained using a variable time-step integration with 4th order Runge-Kutta scheme. The simulation results are shown as a preliminary case study to verify the dynamic response of the proposed configurations for a generated mean wind speed of 8.0m/s as shown in Fig 10. A value of 12% turbulence intensity was created with a Kaimal spectrum according to the IEC 61400-3. The rest of the simulation parameters are presented in Table I.

TABLE I
DESIGN AND SIMULATION PARAMETERS

Description	Symbol	Value	unit
Air density	ρ_{air}	1.225	kg/m ³
Seawater density	ρ_w	1025	kg/m ³
Seawater temperature	T	22	degC
Intake feed concentration	C_{fin}	35500	ppm
Rotor radius	R	30	m
Rotor mass moment of inertia	J_r	6.5e5	kg m ²
Pump mass moment of inertia	J_p	1.5e4	kg m ²
Pump volumetric displacement	V_p	233	L/rev
Pump's laminar leakage coefficient	C_s	6.6e-10	m ³ /(sPa)
Pump's viscous friction coefficient	B_p	0.0	Nm s
Pump's dry friction coefficient	C_{fp}	0.02	-
Mass transfer coefficient	K_w	6.4e-9	s/m
Number of membranes	N_m	88	-
Area per membrane	A_m	15.6	m ²
Feed flow pipe area	A_f	9.1e-3	m ²
Concentrate pipe area	A_c	9.1e-3	m ²
Permeate pipe area	A_p	5.5e-3	m ²
Osmotic pressure coefficient	δ	0.2641	Pa/(ppm K)
Fractional salt rejection	R_m	0.97	-
Concentration weighting coefficient	a	0.5	-
Overflush ratio of ERD	OV	0.05	-
Volumetric mixing of ERD	M	0.06	-
System volume	V	8.0	m ³
Valve time constant	T_v	4.0	s
ERD time constant	T_{ERD}	4.0	s

The variable rotor speed response is shown in Fig 11. Despite the turbulent wind conditions, the tip speed ratio is kept within the desired value in both configurations which ensures that optimal aerodynamic performance is achieved according to the proposed variable speed strategies. The dynamic response of the SWRO system is shown in Fig. 12. In accordance to the steady-state results, the system with pressure exchanger ERD is able to produce a higher flow rate of permeate and depicts similar variations around the mean value with respect to the variable valve case. On the other hand, a higher effective concentration in the ERD configuration is obtained as a result of the brine recirculation and mixing with the feed seawater. Thus, higher osmotic pressure fluctuations are obtained which could have an important impact on the fatigue and degradation of the SWRO membranes.

The specific energy consumption (SEC) is a conventional performance parameter used in SWRO desalination, which is defined as the electrical energy needed to produce a cubic meter of permeate [20]. In the simulations the captured wind energy is used instead of the electrical energy to obtain a SEC between 6.5-12 and 1-2 kWh per cubic meter of fresh water for the variable valve and the ERD configurations respectively as shown in the last graph of Fig. 12.

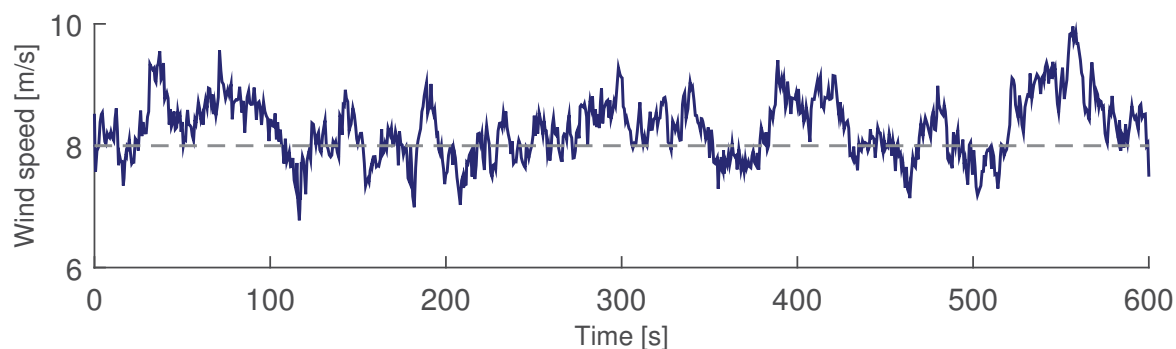

Fig. 10. Wind speed time series with 8.0 m/s mean value and 12% turbulence intensity used for the time-domain simulations.

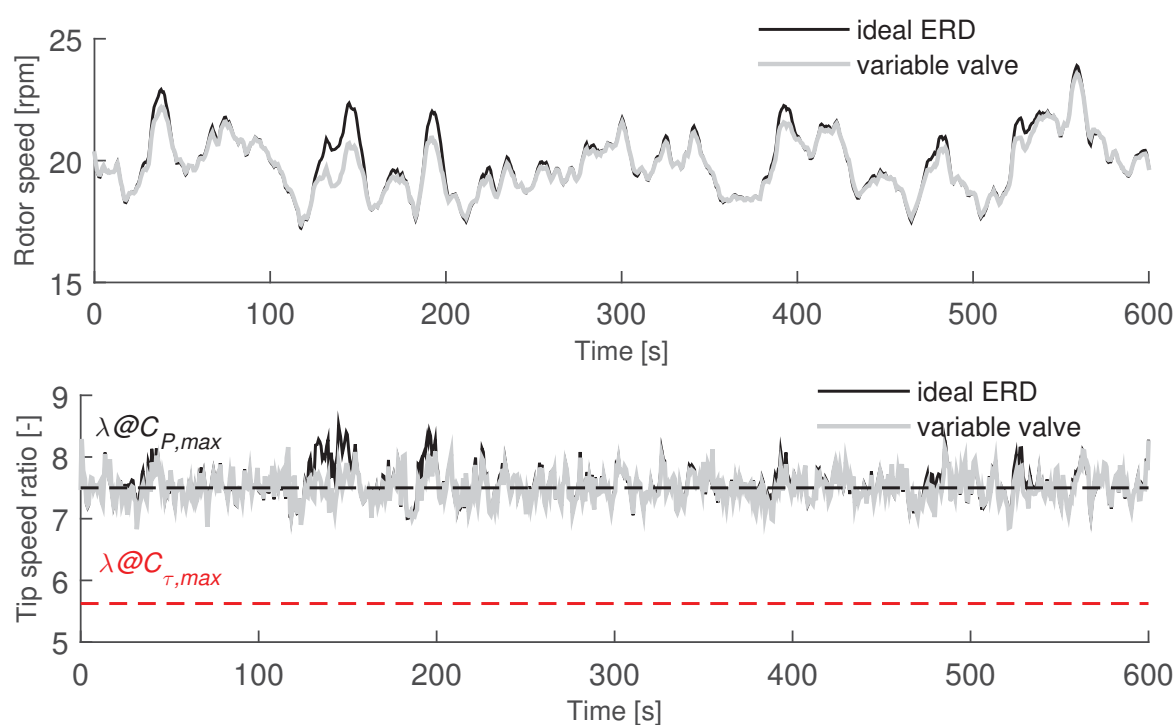

Fig. 11. Time-domain results for the rotor speed response subject to turbulent wind speed conditions.

VI. CONCLUSIONS AND FUTURE WORK

This paper elaborates on the idea to combine wind power and seawater reverse osmosis desalination using hydraulic technology and eliminating the intermediate electrical conversion steps. Two configurations were proposed in which the interaction mechanisms between the wind turbine rotor, the control system, the water pump and the SWRO have an important influence on the production of fresh water for below rated wind speed conditions. A control strategy to modify the rotor speed based on the system pressure was presented with the aim to keep optimal aerodynamic performance as in conventional wind turbines. The integration of a pressure exchanger energy recovery device showed the potential to significantly increase the fresh water production provided that the boost pump is able to operate in a broad range of recovery

rates. A time-domain numerical model was derived from first principles, with the purpose of simulating the response of the two configurations under turbulent wind speed conditions. The intermediate results of this work showed that using a pressure exchanger introduces higher concentrations and pressure fluctuations when compared to a configuration with an adjustable valve. From the dynamic response it was shown that for the selected control strategy there is a compromise between the higher amount of permeate and the higher pressure fluctuations required by the ERD system.

Future work will explore other configurations and control strategies in which a sacrifice of the rotor's aerodynamic performance could result in better operating conditions regarding pressures and recovery rates. In addition a more accurate model of the ERD and experimental work will follow to validate the results of the numerical models presented.

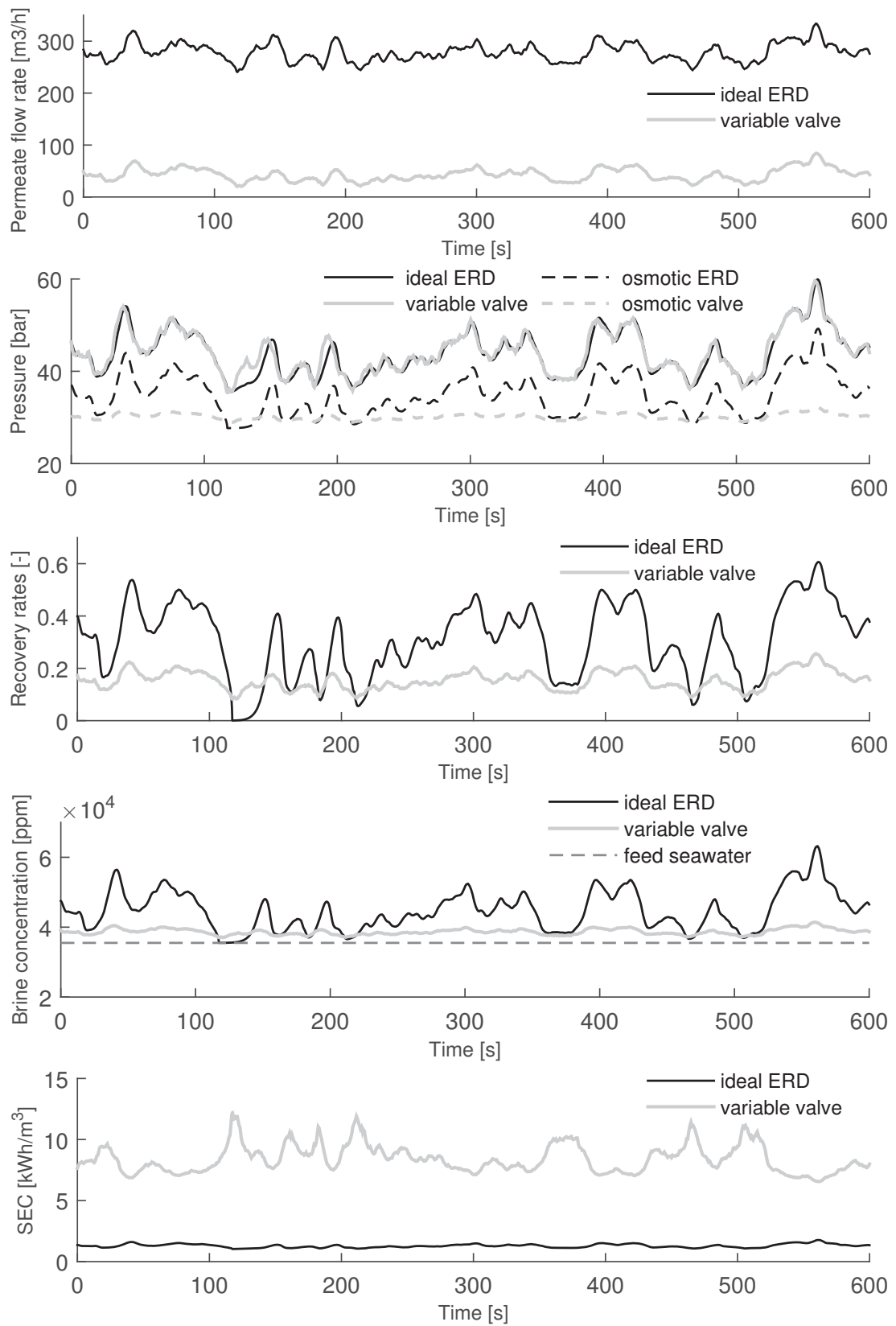

Fig. 12. Dynamic response of the SWRO system for below rated wind speed conditions

REFERENCES

- [1] M. M. Mekonnen, and A. Y. Hoekstra, "Four billion people facing severe water scarcity," *Sci. Adv.* 2(2), pp.1–6, 2016.
- [2] P. Gleick and C. Iceland, "Water, Security, and Conflict," report from World Resources Institute, 2018.
- [3] International Water Summit, "Energy Efficient Desalination," January 2018, p. 15. Available at: www.internationalwatersummit.com.
- [4] R. G. Raluy, L. Serra and J. Uche, "Life cycle assessment of desalination technologies integrated with renewable energies," *Desalination*, vol 183, pp. 81–93, 2005.
- [5] M. A. Abdelkareem, M. El Hay Assad, E. T. Sayed. and B. Soudan, "Recent progress in the use of renewable energy sources to power water desalination plants," *Desalination*, vol. 435, pp. 97–113, 2017.
- [6] M. Elimelech and W. A. Phillip, "The Future of Seawater and the Environment: Energy, Technology, and the Environment," *Science*, vol. 333, pp. 712–718, August, 2011.
- [7] N. F. B. Diepeveen, "On the Application of Fluid Power Transmission in Offshore Wind Turbines," Delft University of Technology, PhD dissertation, August 2013.
- [8] A. Jarquin Laguna, "Centralised electricity generation in offshore wind farms using hydraulic networks," Delft University of Technology, PhD dissertation, April 2017.
- [9] S. P. Mulders, N. F. B. Diepeveen and J. W. van Wingerden, "Control design, implementation and evaluation for an in-field 500 kW wind turbine with a fixed-displacement hydraulic drivetrain," *Wind Energy Science*, pp. 1–37, May, 2018.
- [10] F. Greco and A. Jarquin-Laguna, "Simulation of a horizontal axis tidal turbine for direct driven reverse- osmosis desalination," *Advances in Renewable Energies Offshore*, Taylor & Francis Group, London, pp. 181-188, October 2018.
- [11] R. L. Stover, "Development of a fourth generation energy recovery device. A 'CTO's Notebook'," *Desalination*, vol 165(SUPPL.), pp. 313–321, 2004.
- [12] S. Mambretti, E. Orsi, S. Gagliardi and R. Stover, "Behaviour of energy recovery devices in unsteady flow conditions and application in the modelling of the Hamma desalination plant," *Desalination*, vol. 238, pp. 233–245, 2009.
- [13] R. L. Stover, "Seawater reverse osmosis with isobaric energy recovery devices," *Desalination*, vol. 203, pp. 168–175, 2007.
- [14] H. E. Merritt, "Hydraulic Control Systems," John Wiley & sons, 1967.
- [15] J. G. Wijman and R. W. Baker, "The Solution Diffusion Model : A Review," *Journal of Membrane Science*, 1995.
- [16] A. R. Bartman, P. D. Christofides and Y. Cohen, "Nonlinear Model-Based Control of an Experimental Reverse Osmosis Water Desalination System," *IFAC Proceedings Volumes*, vol. 42(11), pp. 892–897, 2009.
- [17] K. Jeong, Y. G. Lee, S. J. Ki and J. H. Kim, "Modeling seawater reverse osmosis system under degradation conditions of membrane performance: assessment of isobaric energy recovery devices and feed pressure control benefits," *Desalination and Water Treatment*, vol. 57:43, pp.20210–20218, 2016.
- [18] F. D. Bianchi, H. De Battista, and R. J. Mantz, "Wind Turbine Control Systems: Principles, Modelling and Gain Scheduling Design," *Cleveland Clinic quarterly*, vol. 26, Springer, 2007.
- [19] D. Buhagiar, T. Sant and M. Bugeja, "A Comparison of Two Pressure Control Concepts for Hydraulic Offshore Wind Turbines," *ASME. J. Dyn. Sys., Meas., Control*, vol. 138(8), pp. 081007-1–081007-11, 2016.
- [20] A. Zhu, P. D. Christofides and Y. Cohen, "Effect of Thermodynamic Restriction on Energy Cost Optimization of RO Membrane Water Desalination," *Ind. Eng. Chem. Res.*, vol. 48, pp.6010–6021, 2009.